



# FCC RADIO TEST REPORT

**FCC ID** : PY7-72473U  
**Equipment** : GSM/WCDMA/LTE Phone with BT, DTS/UNII  
a/b/g/n/ac, GPS and NFC  
**Brand Name** : Sony  
**Applicant** : Sony Mobile Communications Inc.  
4-12-3 Higashi-Shinagawa, Shinagawa-ku,  
Tokyo, 140-0002, Japan  
**Manufacturer** : Sony Mobile Communications Inc.  
4-12-3 Higashi-Shinagawa, Shinagawa-ku,  
Tokyo, 140-0002, Japan  
**Standard** : FCC Part 15 Subpart E §15.407

The product was received on Jun. 05, 2019 and testing was started from Jun. 18, 2019 and completed on Jul. 08, 2019. We, SPORTON INTERNATIONAL INC. EMC & Wireless Communications Laboratory, would like to declare that the tested sample has been evaluated in accordance with the test procedures and has been in compliance with the applicable technical standards.

The report must not be used by the client to claim product certification, approval, or endorsement by TAF or any agency of government.

The test results in this report apply exclusively to the tested model / sample. Without written approval of SPORTON INTERNATIONAL INC. EMC & Wireless Communications Laboratory, the test report shall not be reproduced except in full.

Approved by: Jones Tsai

**SPORTON INTERNATIONAL INC. EMC & Wireless Communications Laboratory**

No. 52, Huaya 1st Rd., Guishan Dist., Taoyuan City, Taiwan (R.O.C.)



## Table of Contents

History of this test report.....	3
Summary of Test Result .....	4
<b>1 General Description .....</b>	<b>5</b>
1.1 Product Feature of Equipment Under Test .....	5
1.2 Modification of EUT .....	6
1.3 Testing Location .....	6
1.4 Applicable Standards.....	6
<b>2 Test Configuration of Equipment Under Test.....</b>	<b>7</b>
2.1 Carrier Frequency and Channel .....	7
2.2 Test Mode.....	8
2.3 Connection Diagram of Test System .....	10
2.4 Support Unit used in test configuration and system.....	11
2.5 EUT Operation Test Setup .....	11
2.6 Measurement Results Explanation Example .....	11
<b>3 Test Result.....</b>	<b>12</b>
3.1 6dB & 26dB & 99% Occupied Bandwidth Measurement .....	12
3.2 Maximum Conducted Output Power Measurement .....	16
3.3 Power Spectral Density Measurement.....	18
3.4 Unwanted Emissions Measurement .....	20
3.5 AC Conducted Emission Measurement.....	25
3.6 Automatically Discontinue Transmission .....	27
3.7 Antenna Requirements .....	29
<b>4 List of Measuring Equipment.....</b>	<b>30</b>
<b>5 Uncertainty of Evaluation.....</b>	<b>32</b>
<b>Appendix A. Conducted Test Results</b>	
<b>Appendix B. AC Conducted Emission Test Result</b>	
<b>Appendix C. Radiated Spurious Emission</b>	
<b>Appendix D. Radiated Spurious Emission Plots</b>	
<b>Appendix E. Duty Cycle Plots</b>	



### History of this test report

Report No.	Version	Description	Issued Date
FR940905-02E	01	Initial issue of report	Jul. 18, 2019



## Summary of Test Result

Report Clause	Ref Std. Clause	Test Items	Result (PASS/FAIL)	Remark
3.1	15.403(i)	6dB & 26dB Bandwidth	Pass	-
3.1	2.1049	99% Occupied Bandwidth	Reporting only	-
3.2	15.407(a)	Maximum Conducted Output Power	Pass	-
3.3	15.407(a)	Power Spectral Density	Pass	-
3.4	15.407(b)	Unwanted Emissions	Pass	Under limit 3.92 dB at 5729.480 MHz
3.5	15.207	AC Conducted Emission	Pass	Under limit 18.64 dB at 0.596 MHz
3.6	15.407(c)	Automatically Discontinue Transmission	Pass	-
3.7	15.203 15.407(a)	Antenna Requirement	Pass	-

**Declaration of Conformity:**

The test results with all measurement uncertainty excluded are presented in accordance with the regulation limits or requirements declared by manufacturers.

**Comments and Explanations:**

The declared of product specification for EUT presented in the report are provided by the manufacturer, and the manufacturer takes all the responsibilities for the accuracy of product specification.

**Reviewed by: Wii Chang**

**Report Producer: Yimin Ho**



# 1 General Description

## 1.1 Product Feature of Equipment Under Test

GSM/WCDMA/LTE, Bluetooth, DTS/UNII a/b/g/n/ac, NFC, and GNSS.

Standards-related Product Specification	
Antenna Type	<Ant. 1>: Loop Antenna <Ant. 2>: Loop Antenna
Antenna Gain	<5150 MHz ~ 5250 MHz> <Ant. 1>: -2.3 dBi <Ant. 2>: -3.7 dBi <5250 MHz ~ 5350 MHz> <Ant. 1>: -1.5 dBi <Ant. 2>: -3.6 dBi <5470 MHz ~ 5725 MHz> <Ant. 1>: -2.9 dBi <Ant. 2>: -1.5 dBi

EUT Information List			
HW Version	SW Version	S/N	Performed Test Item
A	0_77003_A_28_2	BH93001CH2	RF conducted measurement
	7.19	BH93009KH1	Radiated Spurious Emission
		BH93008LH1	AC Conducted Emission

Accessory List	
AC Adapter	Model Name : UCH32
	S/N: 6218W30200106 (for radiation emission) 6218W30200197 (for conducted emission)
Earphone	Model Name.: MH750
	S/N : N/A
USB Cable	Model Name.: UCB24
	S/N : N/A
2 in 1 USB Audio Cable	Model Name.: EC270
	S/N : N/A

**Note:**

1. Above EUT list used are electrically identical per declared by manufacturer.
2. Above the accessories list are used to exercise the EUT during test, and the serial number of each type of accessories is listed in each section of this report.
3. For other wireless features of this EUT, test report will be issued separately.
4. The antenna 1 and antenna 2 in this test report are equivalent to WLAN chain 0 and chain 1 in Antenna Specification by manufacturer.
5. The firmware installed in the EUT during testing was 0\_77003\_A\_28\_2.



### 1.2 Modification of EUT

No modifications are made to the EUT during all test items.

### 1.3 Testing Location

<b>Test Site</b>	SPORTON INTERNATIONAL INC. EMC & Wireless Communications Laboratory	
<b>Test Site Location</b>	No.52, Huaya 1st Rd., Guishan Dist., Taoyuan City, Taiwan (R.O.C.) TEL: +886-3-327-3456 FAX: +886-3-328-4978	
<b>Test Site No.</b>	<b>Sporton Site No.</b>	
	TH05-HY	CO05-HY

**Note:** The test site complies with ANSI C63.4 2014 requirement.

<b>Test Site</b>	SPORTON INTERNATIONAL INC. EMC & Wireless Communications Laboratory	
<b>Test Site Location</b>	No.58, Aly. 75, Ln. 564, Wenhua 3rd, Rd., Guishan Dist., Taoyuan City, Taiwan (R.O.C.) TEL: +886-3-327-0868 FAX: +886-3-327-0855	
<b>Test Site No.</b>	<b>Sporton Site No.</b>	
	03CH16-HY	

**Note:** The test site complies with ANSI C63.4 2014 requirement.

FCC Designation No.: TW1190 and TW0007

### 1.4 Applicable Standards

According to the specifications of the manufacturer, the EUT must comply with the requirements of the following standards:

- ♦ FCC Part 15 Subpart E
- ♦ FCC KDB 789033 D02 General UNII Test Procedures New Rules v02r01.
- ♦ FCC KDB 414788 D01 Radiated Test Site v01r01.
- ♦ FCC KDB 662911 D01 Multiple Transmitter Output v02r01.
- ♦ ANSI C63.10-2013

**Remark:**

1. All test items were verified and recorded according to the standards and without any deviation during the test.
2. This EUT has also been tested and complied with the requirements of FCC Part 15, Subpart B, recorded in a separate test report.



## 2 Test Configuration of Equipment Under Test

- a. The EUT has been associated with peripherals and configuration operated in a manner tended to maximize its emission characteristics in a typical application. Frequency range investigated: conduction emission (150 kHz to 30 MHz), radiation emission (9 kHz to the 10th harmonic of the highest fundamental frequency or to 40 GHz, whichever is lower). For radiated measurement, pre-scanned in three orthogonal panels, X, Y, Z and Accessory. The worst cases (Y plane with Adapter) were recorded in this report.
- b. AC power line Conducted Emission was tested under maximum output power.

### 2.1 Carrier Frequency and Channel

Frequency Band	Channel	Freq. (MHz)	Channel	Freq. (MHz)
5150-5250 MHz Band 1 (U-NII-1)	36	5180	44	5220
	38*	5190	46*	5230
	40	5200	48	5240
	42 <sup>#</sup>	5210		

Frequency Band	Channel	Freq. (MHz)	Channel	Freq. (MHz)
5250-5350 MHz Band 2 (U-NII-2A)	52	5260	60	5300
	54*	5270	62*	5310
	56	5280	64	5320
	58 <sup>#</sup>	5290		

Frequency Band	Channel	Freq. (MHz)	Channel	Freq. (MHz)
5470-5725 MHz Band 3 (U-NII-2C)	100	5500	112	5560
	102*	5510	116	5580
	104	5520	132	5660
	106 <sup>#</sup>	5530	134*	5670
	108	5540	136	5680
	110*	5550	140	5700



Frequency Band	Channel	Freq. (MHz)	Channel	Freq. (MHz)
TDWR Channel	118*	5590	124	5620
	120	5600	126*	5630
	122 <sup>#</sup>	5610	128	5640

Frequency Band	Channel	Freq. (MHz)	Channel	Freq. (MHz)
Straddle Channel	138 <sup>#</sup>	5690	144	5720
	142*	5710		

**Note:**

1. The above Frequency and Channel in "\*" were 802.11n HT40 and 802.11ac VHT40.
2. The above Frequency and Channel in "<sup>#</sup>" were 802.11ac VHT80.

## 2.2 Test Mode

Final test modes are considering the modulation and worse data rates as below table.

Modulation	Data Rate
802.11a	6 Mbps
802.11n HT20	MCS0
802.11n HT40	MCS0
802.11ac VHT20 (Covered by HT20)	MCS0
802.11ac VHT40 (Covered by HT40)	MCS0
802.11ac VHT80	MCS0

Test Cases	
<b>AC Conducted Emission</b>	Mode 1 : GSM850 Idle + Bluetooth Link + WLAN (5GHz) Link + MPEG4 + USB Audio Cable + USB Cable (Charging from Adapter) + Battery + Earphone
<b>Remark:</b> The single mode covered by MIMO mode base on the MIMO mode power higher than the single mode.	





Ch. #		Band I : 5150-5250 MHz	Band II : 5250-5350 MHz	Band III : 5470-5725MHz
		802.11a	802.11a	802.11a
L	Low	36	52	100
M	Middle	44	60	116
H	High	48	64	140
Straddle		-	-	144

Ch. #		Band I : 5150-5250 MHz	Band II : 5250-5350 MHz	Band III : 5470-5725MHz
		802.11n HT20	802.11n HT20	802.11n HT20
L	Low	36	52	100
M	Middle	44	60	116
H	High	48	64	140
Straddle		-	-	144

Ch. #		Band I : 5150-5250 MHz	Band II : 5250-5350 MHz	Band III : 5470-5725MHz
		802.11n HT40	802.11n HT40	802.11n HT40
L	Low	38	54	102
M	Middle	-	-	110
H	High	46	62	134
Straddle		-	-	142

Ch. #		Band I : 5150-5250 MHz	Band II : 5250-5350 MHz	Band III : 5470-5725MHz
		802.11ac VHT80	802.11ac VHT80	802.11ac VHT80
L	Low	-	-	106
M	Middle	42	58	122
H	High	-	-	-
Straddle		-	-	138

## 2.3 Connection Diagram of Test System

<WLAN Tx Mode>

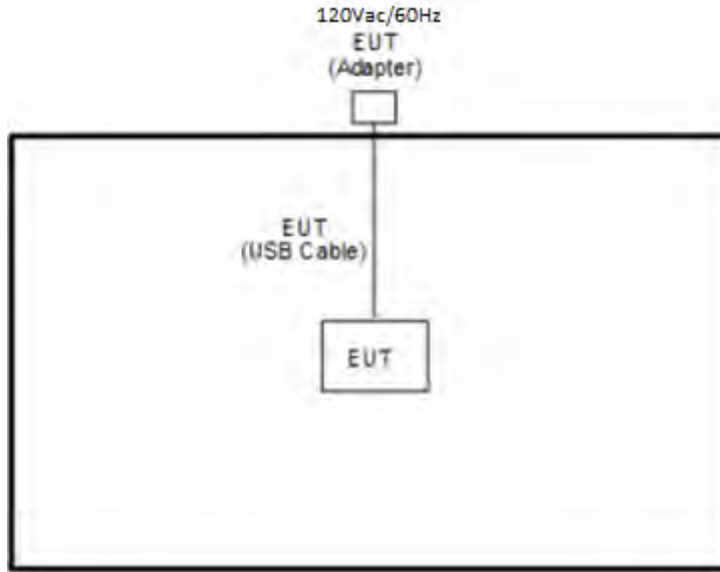

<AC Conducted Emission Mode>

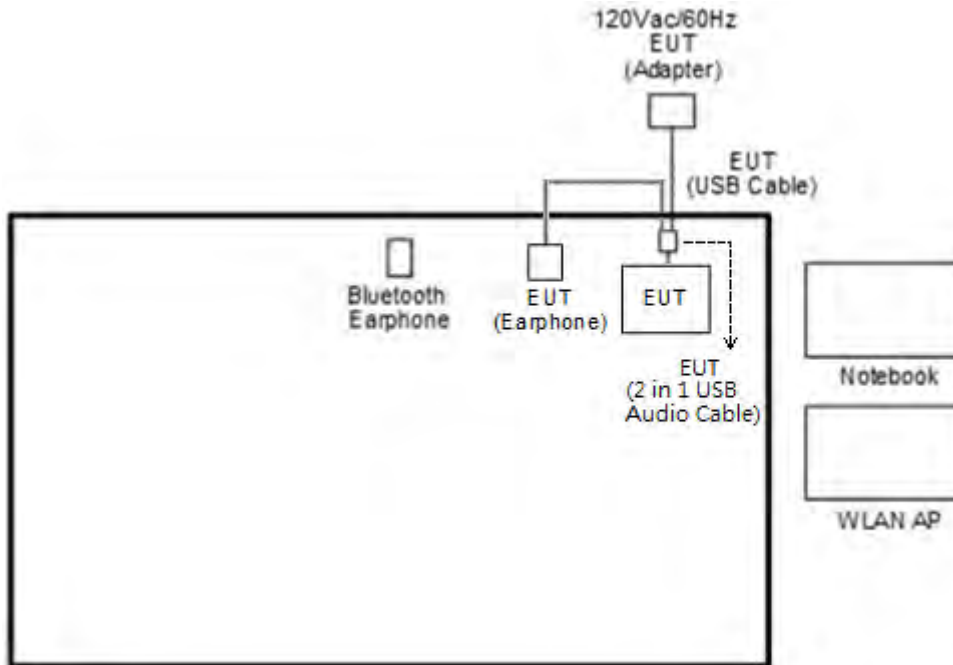

## 2.4 Support Unit used in test configuration and system

Item	Equipment	Trade Name	Model Name	FCC ID	Data Cable	Power Cord
1.	System Simulator	Anritsu	MT8820C	N/A	N/A	Unshielded, 1.8 m
2.	Bluetooth Earphone	Sony	SBH82D	PY7-RD0010	N/A	N/A
3.	WLAN AP	ASUS	RT-AC1750	MSQ-RTAC66U	N/A	Unshielded, 1.8 m
4.	Notebook	DELL	Latitude E3340	FCC DoC	N/A	AC I/P: Unshielded, 1.2 m DC O/P: Shielded, 1.8 m
5.	SD Card	SanDisk	MicroSD HC	FCC DoC	N/A	N/A

## 2.5 EUT Operation Test Setup

The RF test items, utility “Tera Term” was installed in Notebook which was programmed in order to make the EUT get into the engineering modes to provide channel selection, power level, data rate and the application type and for continuous transmitting signals.

## 2.6 Measurement Results Explanation Example

**For all conducted test items:**

The offset level is set in the spectrum analyzer to compensate the RF cable loss and attenuator factor between EUT conducted output port and spectrum analyzer. With the offset compensation, the spectrum analyzer reading level is exactly the EUT RF output level.

Example :

The spectrum analyzer offset is derived from RF cable loss and attenuator factor.

*Offset = RF cable loss + attenuator factor.*

Following shows an offset computation example with cable loss 4.2 dB and 10dB attenuator.

$$\begin{aligned}
 \text{Offset(dB)} &= \text{RF cable loss(dB)} + \text{attenuator factor(dB)}. \\
 &= 4.2 + 10 = 14.2 \text{ (dB)}
 \end{aligned}$$



### 3 Test Result

#### 3.1 6dB & 26dB & 99% Occupied Bandwidth Measurement

##### 3.1.1 Description of 6dB & 26dB & 99% Occupied Bandwidth

This section is for reporting purpose only.

There is no restriction limits for bandwidth.

For Straddle Channel, according to KDB 789033 D02 General UNII Test Procedures New Rules v02r01, if the power and PSD of the devices are uniform and comply with the lower limits specified for the U-NII-2 bands, a single measurement over the entire emission bandwidth can be performed to show compliance.

##### 3.1.2 Measuring Instruments

See list of measuring equipment of this test report.

##### 3.1.3 Test Procedures

The testing follows FCC KDB 789033 D02 General UNII Test Procedures New Rules v02r01.

For 26dB & 99OB

Section C) Emission bandwidth

1. Set RBW = approximately 1% of the emission bandwidth.
2. Set the VBW > RBW.
3. Detector = Peak.
4. Trace mode = max hold
5. Measure the maximum width of the emission that is 26 dB down from the peak of the emission. Compare this with the RBW setting of the analyzer. Readjust RBW and repeat measurement as needed until the RBW/EBW ratio is approximately 1%.
6. For 99% Bandwidth Measurement, the spectrum analyzer's resolution bandwidth (RBW) is set 1-5% of the emission bandwidth and set the Video bandwidth (VBW)  $\geq 3 * RBW$ .
7. Measure and record the results in the test report.

For 6dB

Section C) Emission bandwidth

1. Set RBW = 100kHz.
2. Set the VBW  $\geq 3 * RBW$ .
3. Detector = Peak.
4. Trace mode = max hold
5. Measure the maximum width of the emission that is 6 dB down from the peak of the emission.
6. Measure and record the results in the test report.

### 3.1.4 Test Setup

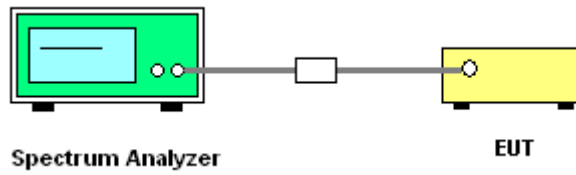

### 3.1.5 Test Result of 6dB & 26dB & 99% Occupied Bandwidth

Please refer to Appendix A.

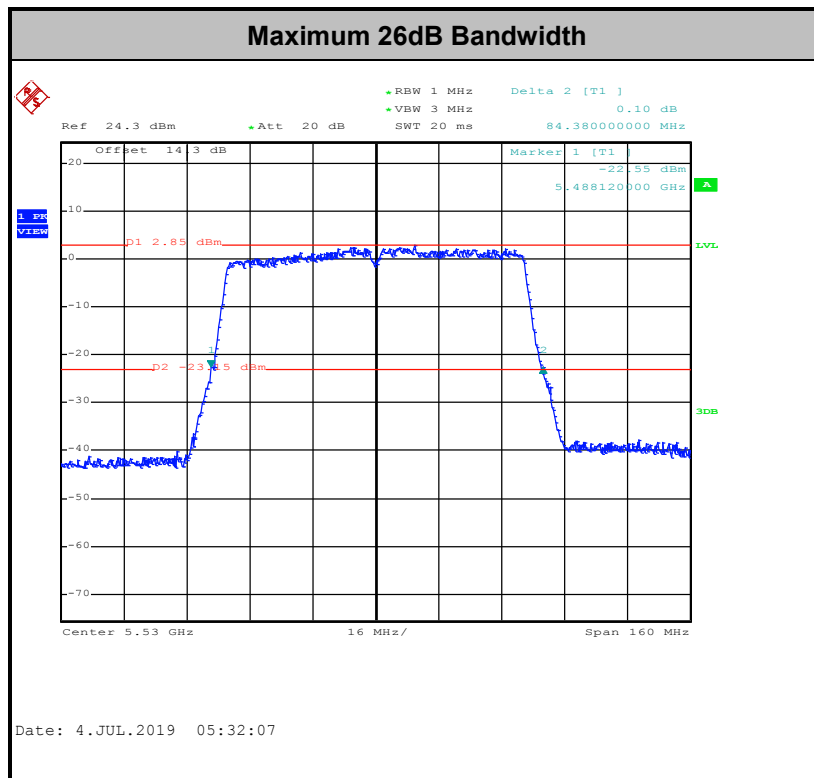

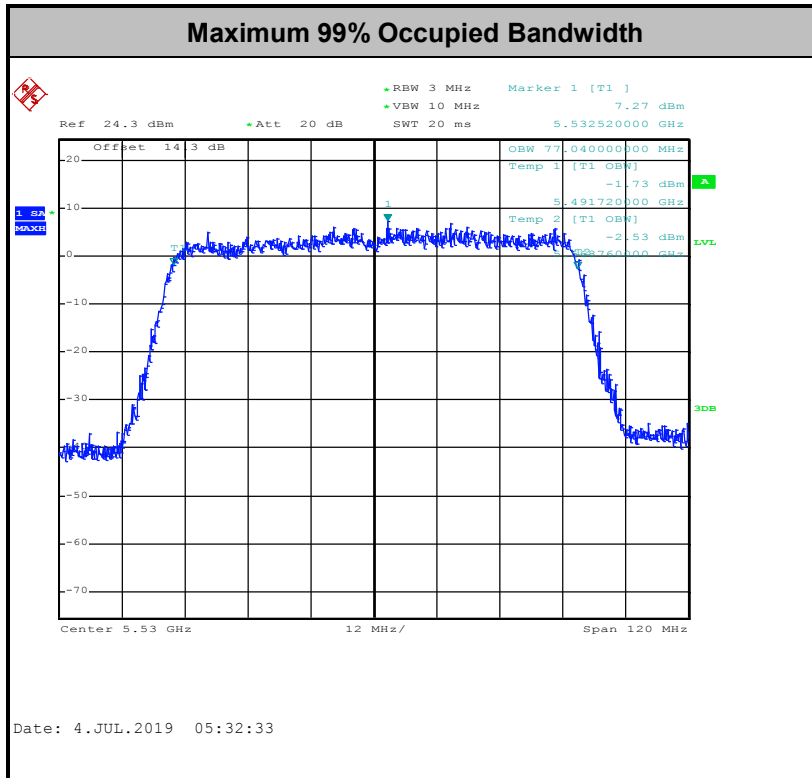

**Note:** The occupied channel bandwidth is maintained within the band of operation for all of the modulations.

<Straddle Channel>

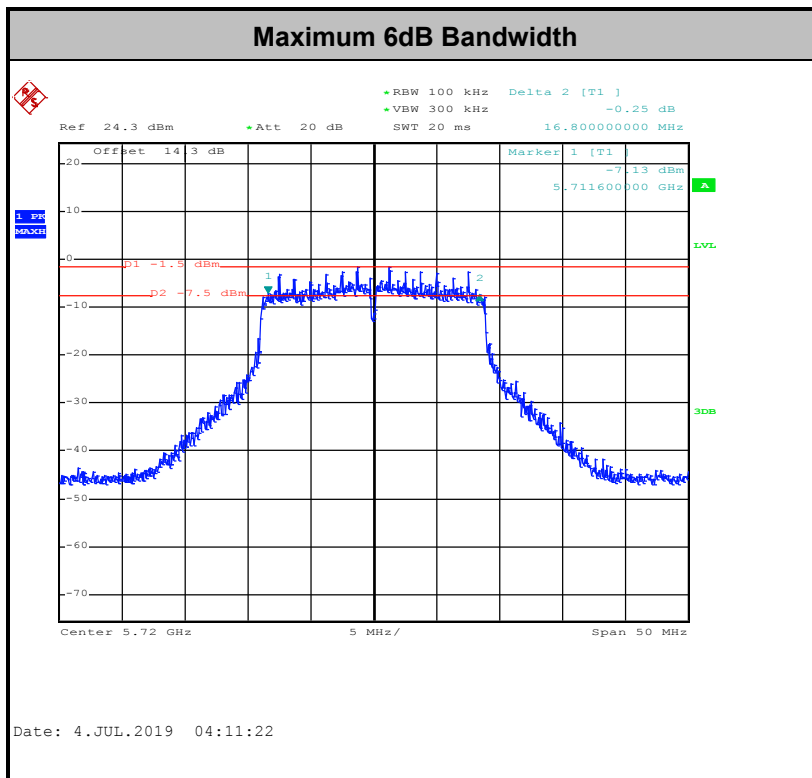

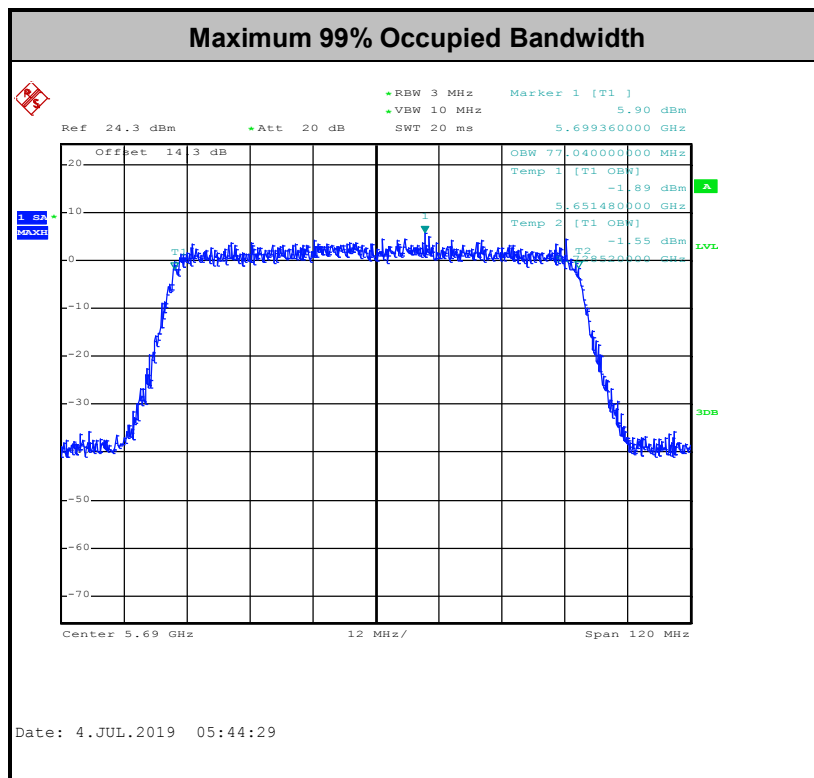
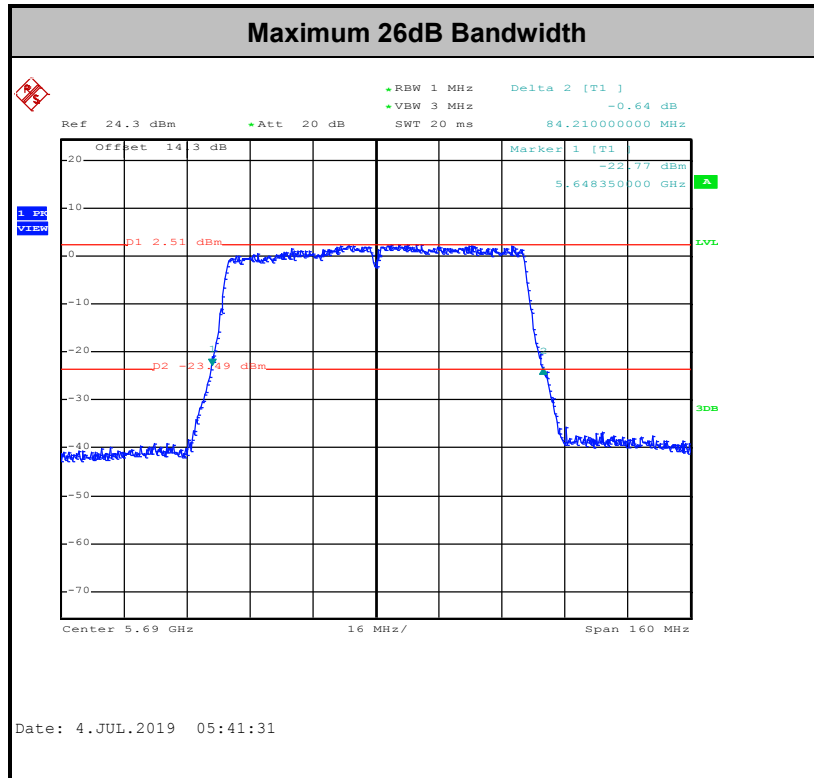

**Note:** The occupied channel bandwidth is maintained within the band of operation for all of the modulations.



## 3.2 Maximum Conducted Output Power Measurement

### 3.2.1 Limit of Maximum Conducted Output Power

<FCC 14-30 CFR 15.407>

**For the 5.15–5.25 GHz bands:**

- For mobile and portable client devices in the 5.15–5.25 GHz band, the maximum conducted output power over the frequency band of operation shall not exceed 250 mW. For an indoor access point operating in the band 5.15-5.25 GHz, the maximum conducted output power over the frequency band of operation shall not exceed 1 W.

**For the 5.25–5.725 GHz bands:**

- The maximum conducted output power over the frequency bands of operation shall not exceed the lesser of 250 mW or  $11 \text{ dBm} + 10 \log B$ , where B is the 26 dB emission bandwidth in megahertz.

For Straddle Channel, according to KDB 789033 D02 General UNII Test Procedures New Rules v02r01, if the power and PSD of the devices are uniform and comply with the lower limits specified for the U-NII-2 bands, a single measurement over the entire emission bandwidth can be performed to show compliance.

If transmitting antennas of directional gain greater than 6 dBi are used, the peak output power shall be reduced by the amount in dB that the directional gain of the antenna exceeds 6 dBi.

Note that U-NII-2 band, devices with a maximum e.i.r.p. greater than 500 mW shall implement TPC in order to have the capability to operate at least 6 dB below the maximum permitted e.i.r.p. of 1 W.

### 3.2.2 Measuring Instruments

See list of measuring equipment of this test report.



### 3.2.3 Test Procedures

The testing follows Method PM-G of FCC KDB 789033 D02 General UNII Test Procedures New Rules v02r01.

Method PM-G (Measurement using a gated RF average power meter):

1. Measurement is performed using a wideband RF power meter.
2. The EUT is configured to transmit at its maximum power control level.
3. Measure the average power of the transmitter
4. Since the measurement is made only during the ON time of the transmitter, no duty cycle correction factor is required.

For Straddle Channel, according to KDB 789033 D02 General UNII Test Procedures New Rules v02r01, if the power and PSD of the devices are uniform and comply with the lower limits specified for the U-NII-2 bands, a single measurement over the entire emission bandwidth can be performed to show compliance.

### 3.2.4 Test Setup

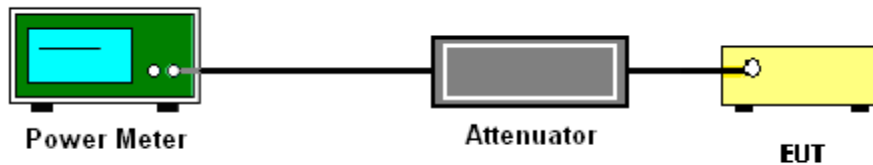

### 3.2.5 Test Result of Maximum Conducted Output Power

Please refer to Appendix A.



### 3.3 Power Spectral Density Measurement

#### 3.3.1 Limit of Power Spectral Density

<FCC 14-30 CFR 15.407>

**For the 5.15–5.25 GHz bands:**

For mobile and portable client devices in the 5.15–5.25 GHz band, the maximum power spectral density shall not exceed 11 dBm in any 1.0 MHz band. For an indoor access point operating in the band 5.15-5.25 GHz, the maximum power spectral density shall not exceed 17 dBm in any 1.0 MHz band.

**For the 5.25–5.725 GHz bands:**

The maximum power spectral density shall not exceed 11 dBm in any 1.0 MHz band.

For Straddle Channel, according to KDB 789033 D02 General UNII Test Procedures New Rules v02r01, if the power and PSD of the devices are uniform and comply with the lower limits specified for the U-NII-2 bands, a single measurement over the entire emission bandwidth can be performed to show compliance.

If transmitting antennas of directional gain greater than 6 dBi are used, the peak output power shall be reduced by the amount in dB that the directional gain of the antenna exceeds 6 dBi.

#### 3.3.2 Measuring Instruments

See list of measuring equipment of this test report.

#### 3.3.3 Test Procedures

The testing follows FCC KDB 789033 D02 General UNII Test Procedures New Rules v02r01. Section F) Maximum power spectral density.

**# Method SA-3 #**

(power averaging (rms) detection with max hold):

- Set span to encompass the entire emission bandwidth (EBW) of the signal.
- Set RBW = 1 MHz.
- Set VBW  $\geq$  3 MHz
- Number of points in sweep  $\geq$  2 Span / RBW.
- Sweep time  $\leq$  (number of points in sweep)  $\times$  T, when duty cycle is less than 98 percent where T is the minimum transmission duration over which the transmitter is on and is transmitting at its maximum power control level for the tested mode of operation.
- Detector = power averaging (rms).
- Trace mode = max hold.
- Allow max hold to run for at least 60 seconds, or longer as needed to allow the trace to stabilize.

1. The RF output of EUT was connected to the spectrum analyzer by a low loss cable.
2. Each plot has already offset with cable loss, and attenuator loss. Measure the PPSD and record it.
3. For MIMO mode, calculation method follows FCC KDB 662911 D01 Multiple Transmitter Output v02r01.

Method (a): Measure and sum the spectra across the outputs.

The total final Power Spectral Density is from a device with 2 transmitter outputs. The spectrum measurements of the individual outputs are all performed with the same span and number of points; the spectrum value in the first spectral bin of output 1 is summed with that in the first spectral bin of output 2 to obtain the value for the first frequency bin of the summed spectrum.

### 3.3.4 Test Setup

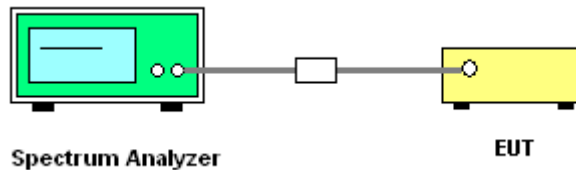

### 3.3.5 Test Result of Power Spectral Density

Please refer to Appendix A.

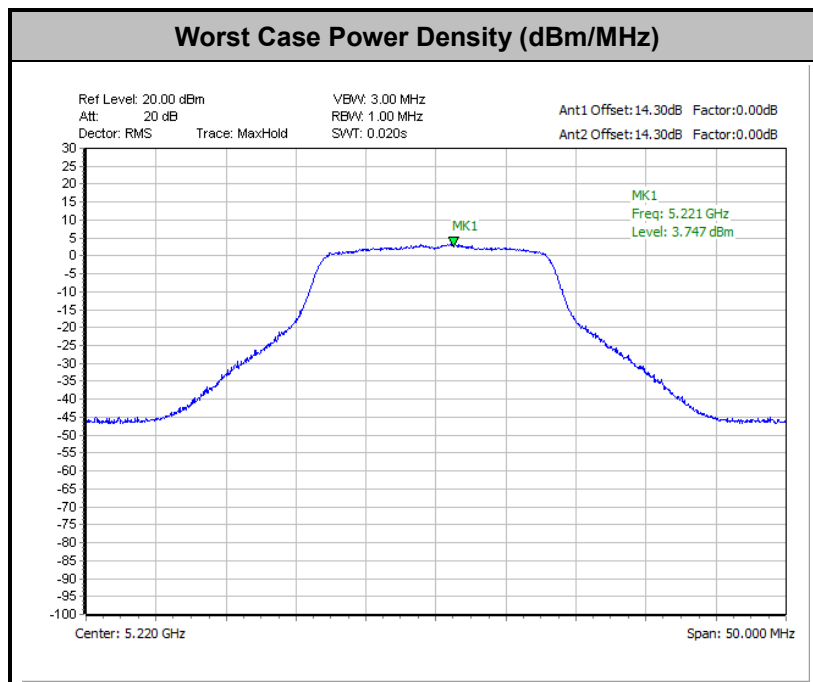



### 3.4 Unwanted Emissions Measurement

This section is to measure unwanted emissions through radiated measurement for band edge spurious emissions and out of band emissions measurement.

#### 3.4.1 Limit of Unwanted Emissions

- (1) For transmitters operating in the 5150-5250 MHz band: all emissions outside of the 5150-5350 MHz band shall not exceed an EIRP of -27dBm/MHz.

For transmitters operating in the 5250-5350 MHz band: all emissions outside of the 5150-5350 MHz band shall not exceed an EIRP of -27 dBm/MHz. Devices operating in the 5250-5350 MHz band that generate emissions in the 5150-5250 MHz band must meet all applicable technical requirements for operation in the 5150-5250 MHz band (including indoor use) or alternatively meet an out-of-band emission EIRP limit of -27 dBm/MHz in the 5150-5250 MHz band.

For transmitters operating in the 5470-5600 MHz and 5650-5725MHz band: all emissions outside of the 5470-5600 MHz and 5650-5725MHz band shall not exceed an EIRP of -27 dBm/MHz.

- (2) Unwanted spurious emissions fallen in restricted bands shall comply with the general field strength limits as below table,

Frequency (MHz)	Field Strength (microvolts/meter)	Measurement Distance (meters)
0.009 – 0.490	2400/F(kHz)	300
0.490 – 1.705	24000/F(kHz)	30
1.705 – 30.0	30	30
30 – 88	100	3
88 – 216	150	3
216 - 960	200	3
Above 960	500	3

**Note:** The following formula is used to convert the EIRP to field strength.

$$E = \frac{1000000\sqrt{30P}}{3} \text{ } \mu\text{V/m, where P is the eirp (Watts)}$$



EIRP (dBm)	Field Strength at 3m (dBμV/m)
- 27	68.3

(3) KDB789033 D02 v02r01 G)2)c)

- (i) Section 15.407(b)(1) to (b)(3) specify the unwanted emission limits for the U-NII-1 and U-NII-2 bands. As specified, emissions above 1000 MHz that are outside of the restricted bands are subject to a peak emission limit of -27 dBm/MHz.<sup>3</sup>
- (ii) Section 15.407(b)(4) specifies the unwanted emission limit for the U-NII-3 band. A band emissions mask is specified in Section 15.407(b)(4)(i). The emission limits are in terms of a Peak detector. An alternative to the band emissions mask is specified in Section 15.407(b)(4)(ii). The alternative limits are based on the highest antenna gain specified in the filing. There are also marketing and importation restrictions for the devices using the alternative limit.<sup>4</sup>

**Note 3:** An out-of-band emission that complies with both the average and peak limits of Section 15.209 is not required to satisfy the -27 dBm/MHz peak emission limit.

**Note 4:** Only devices with antenna gains of 10 dBi or less may be approved using the emission limits specified in Section 15.247(d) till March 2, 2018; all other devices operating in this band must use the mask specified in Section 15.407(b)(4)(i).

### 3.4.2 Measuring Instruments

See list of measuring equipment of this test report.

### 3.4.3 Test Procedures

1. The testing follows FCC KDB 789033 D02 General UNII Test Procedures New Rules v02r01. Section G) Unwanted emissions measurement.
  - (1) Procedure for Unwanted Emissions Measurements Below 1000MHz
    - RBW = 120 kHz
    - VBW = 300 kHz
    - Detector = Peak
    - Trace mode = max hold
  - (2) Procedure for Peak Unwanted Emissions Measurements Above 1000 MHz
    - RBW = 1 MHz
    - VBW ≥ 3 MHz
    - Detector = Peak
    - Sweep time = auto
    - Trace mode = max hold



(3) Procedures for Average Unwanted Emissions Measurements Above 1000MHz

- RBW = 1 MHz
  - VBW = 10 Hz, when duty cycle is no less than 98 percent.
  - $VBW \geq 1/T$ , when duty cycle is less than 98 percent where T is the minimum transmission duration over which the transmitter is on and is transmitting at its maximum power control level for the tested mode of operation.
2. The EUT was placed on a turntable with 0.8 meter for frequency below 1GHz and 1.5 meter for frequency above 1GHz respectively above ground.
  3. The EUT was set 3 meters from the interference receiving antenna which was mounted on the top of a variable height antenna tower.
  4. The antenna is a broadband antenna and its height is adjusted between one meter and four meters above ground to find the maximum value of the field strength for both horizontal polarization and vertical polarization of the antenna.
  5. For each suspected emission, the EUT was arranged to its worst case and then adjust the antenna tower (from 1 m to 4 m) and turntable (from 0 degree to 360 degrees) to find the maximum reading.
  6. For testing below 1GHz, if the emission level of the EUT in peak mode was 3 dB lower than the limit specified, then peak values of EUT will be reported, otherwise, the emissions will be repeated one by one using the CISPR quasi-peak method and reported.
  7. For testing above 1GHz, the emission level of the EUT in peak mode was 20dB lower than average limit (that means the emission level in average mode also complies with the limit in average mode), then peak values of EUT will be reported, otherwise, the emissions will be measured in average mode again and reported.

### 3.4.4 Test Setup

For radiated emissions below 30MHz

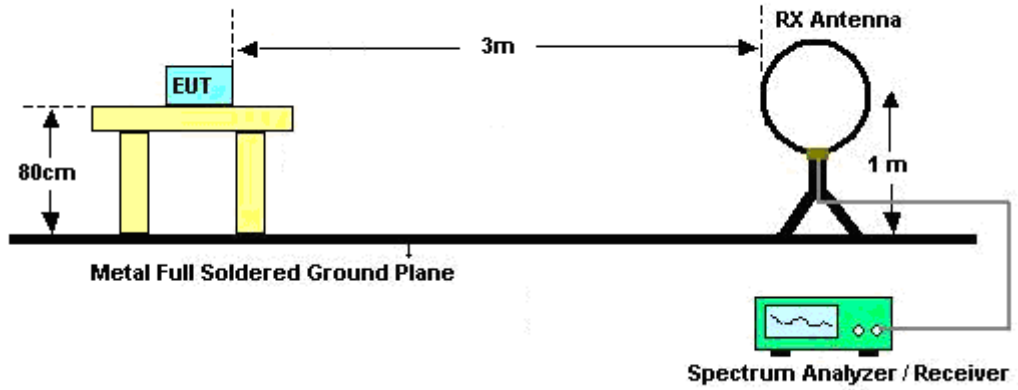

For radiated emissions from 30MHz to 1GHz

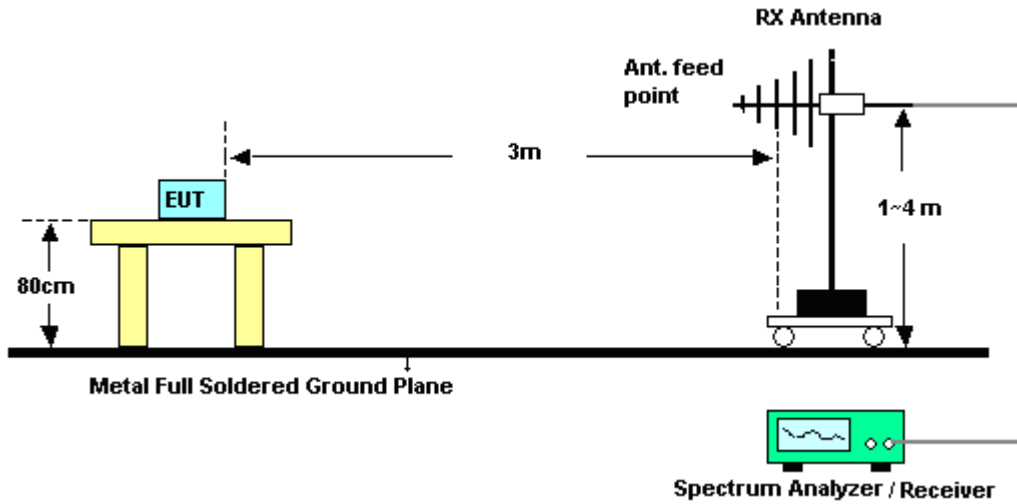

For radiated emissions above 1GHz

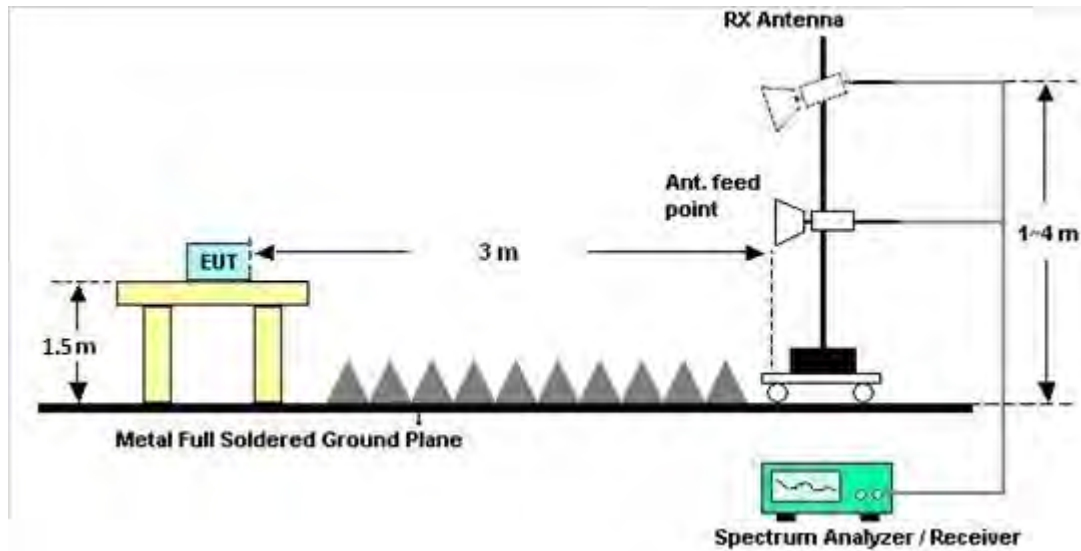

### 3.4.5 Test Results of Radiated Spurious Emissions (9 kHz ~ 30 MHz)

The low frequency, which started from 9 kHz to 30MHz, was pre-scanned and the result which was 20dB lower than the limit line was not reported.

There is a comparison data of both open-field test site and alternative test site - semi-Anechoic chamber according to 414788 D01 Radiated Test Site v01r01, and the result came out very similar.

### 3.4.6 Test Result of Radiated Spurious at Band Edges

Please refer to Appendix C and D.

### 3.4.7 Duty Cycle

Please refer to Appendix E.

### 3.4.8 Test Result of Radiated Spurious Emissions (30MHz ~ 10th Harmonic)

Please refer to Appendix C and D.





### 3.5 AC Conducted Emission Measurement

#### 3.5.1 Limit of AC Conducted Emission

For equipment that is designed to be connected to the public utility (AC) power line, the radio frequency voltage that is conducted back onto the AC power line on any frequency or frequencies within the band 150 kHz to 30 MHz shall not exceed the limits in the following table.

Frequency of emission (MHz)	Conducted limit (dB $\mu$ V)	
	Quasi-peak	Average
0.15-0.5	66 to 56*	56 to 46*
0.5-5	56	46
5-30	60	50

\*Decreases with the logarithm of the frequency.

#### 3.5.2 Measuring Instruments

See list of measuring equipment of this test report.

#### 3.5.3 Test Procedures

1. The EUT was placed 0.4 meter from the conducting wall of the shielding room was kept at least 80 centimeters from any other grounded conducting surface.
2. Connect EUT to the power mains through a line impedance stabilization network (LISN).
3. All the support units are connecting to the other LISN.
4. The LISN provides 50 ohm coupling impedance for the measuring instrument.
5. The FCC states that a 50 ohm, 50 microhenry LISN should be used.
6. Both sides of AC line were checked for maximum conducted interference.
7. The frequency range from 150 kHz to 30 MHz was searched.
8. Set the test-receiver system to Peak Detect Function and specified bandwidth with Maximum Hold Mode.

### 3.5.4 Test Setup

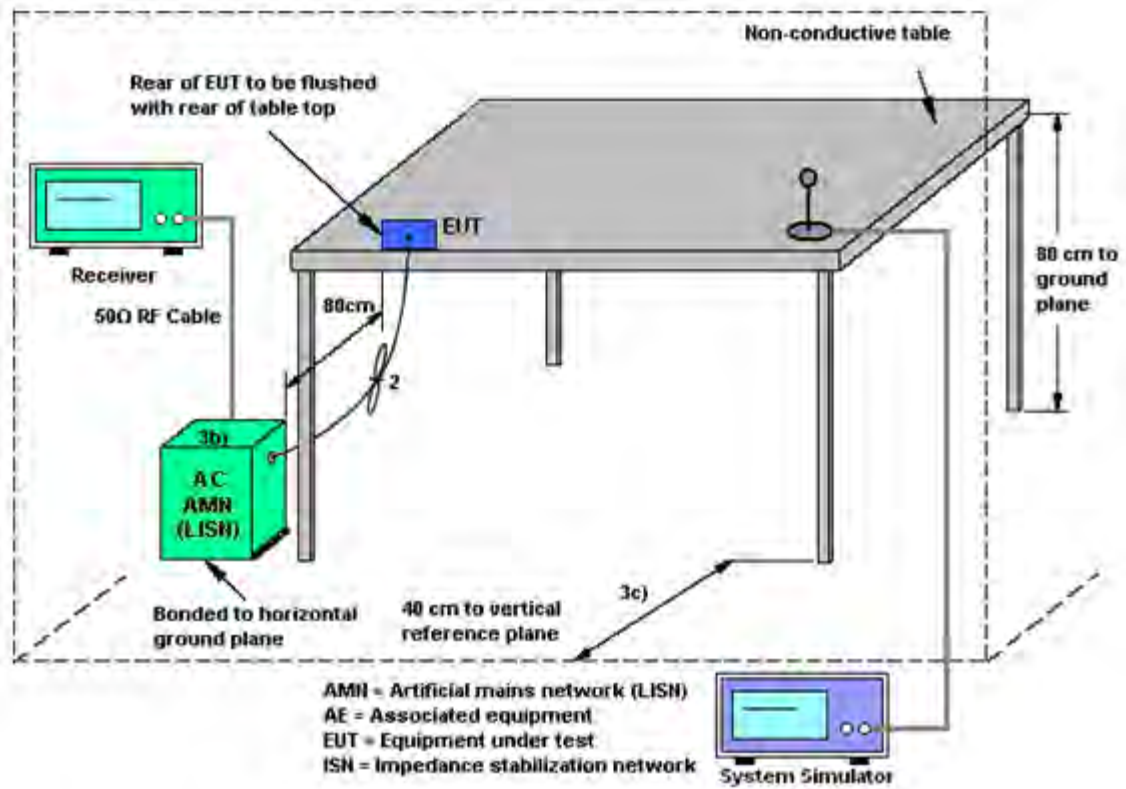

### 3.5.5 Test Result of AC Conducted Emission

Please refer to Appendix B.



## **3.6 Automatically Discontinue Transmission**

### **3.6.1 Limit of Automatically Discontinue Transmission**

The device shall automatically discontinue transmission in case of either absence of information to transmit or operational failure. These provisions are not intended to preclude the transmission of control or signaling information or the use of repetitive codes used by certain digital technologies to complete frame or burst intervals. Applicants shall include in their application for equipment authorization to describe how this requirement is met.

### **3.6.2 Measuring Instruments**

See list of measuring equipment of this test report.

### **3.6.3 Test Result of Automatically Discontinue Transmission**

EUT is verified this characteristic during the function check of normal sample associated with an access point:

- A. Information start: make EUT supply information to the access point.
- B. Information stop: stop supplying information to the access point.

While the EUT is not transmitting any information, the EUT can automatically discontinue transmission and become standby mode for power saving.

- C. Information start: make EUT supply information to the access point again.

The EUT can detect the controlling signal of ACK message transmitting from remote device and verify whether it shall resend or discontinue transmission.

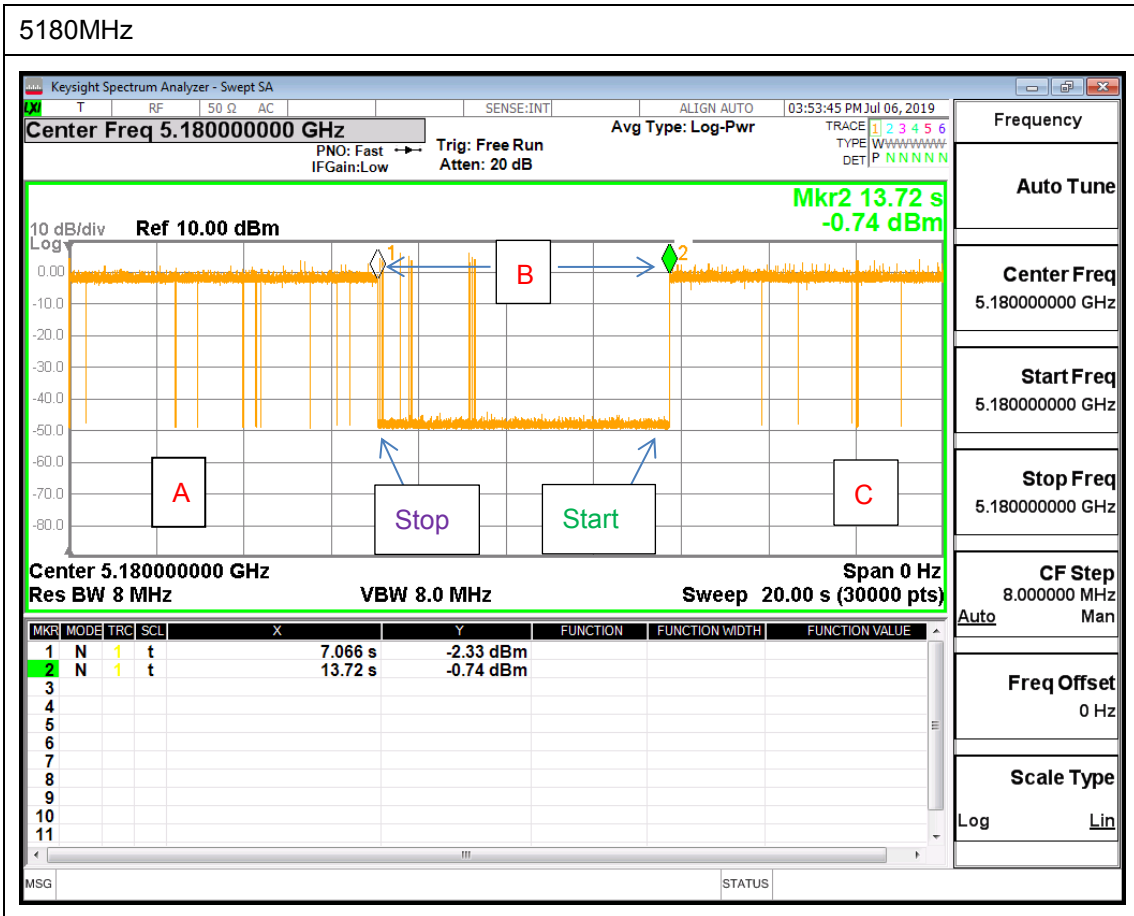

**Note:** The control / signalling information during the period B is precluded.



### 3.7 Antenna Requirements

#### 3.7.1 Standard Applicable

If transmitting antenna directional gain is greater than 6 dBi, both the peak transmit power and the peak power spectral density shall be reduced by the amount in dB that the directional gain of the antenna exceeds 6 dBi.

#### 3.7.2 Antenna Anti-Replacement Construction

An embedded-in antenna design is used.

#### 3.7.3 Antenna Gain

<CDD Modes >

FCC KDB 662911 D01 Multiple Transmitter Output v02r01

For CDD transmissions, directional gain is calculated as

Directional gain = GANT + Array Gain, where Array Gain is as follows.

For power spectral density (PSD) measurements on all devices,

Array Gain = 10 log(NANT/NSS=1) dB.

For power measurements on IEEE 802.11 devices,

Array Gain = 0 dB (i.e., no array gain) for NANT ≤ 4.

Directional gain may be calculated by using the formulas applicable to equal gain antennas with GANT set equal to the gain of the antenna having the highest gain;

The EUT supports CDD mode.

For power, the directional gain GANT is set equal to the antenna having the highest gain, i.e., F)2)f)i).

For PSD, the directional gain calculation is following F)2)f)ii) of KDB 662911 D01 v02r01.

The power and PSD limit should be modified if the directional gain of EUT is over 6 dBi,

The directional gain “DG” is calculated as following table.

<CDD Modes>						
	Ant. 1	Ant. 2	DG for Power	DG for PSD	Power Limit Reduction	PSD Limit Reduction
	(dBi)	(dBi)	(dBi)	(dBi)	(dB)	(dB)
Band I	-2.30	-3.70	-2.30	0.04	0.00	0.00
Band II	-1.50	-3.60	-1.50	0.52	0.00	0.00
Band III	-2.90	-1.50	-1.50	0.84	0.00	0.00

Power limit reduction = Composite gain – 6dBi, ( min = 0 )

PSD limit reduction = Composite gain + PSD Array gain – 6dBi, ( min = 0 )



## 4 List of Measuring Equipment

Instrument	Manufacturer	Model No.	Serial No.	Characteristics	Calibration Date	Test Date	Due Date	Remark
Hygrometer	Testo	DTM-303A	TP157075	N/A	Nov. 05, 2018	Jun. 18, 2019~ Jul. 04, 2019	Nov. 04, 2019	Conducted (TH05-HY)
Power Sensor	DARE	RPR3006W	16I00054SN O10	10MHz~6GHz	Dec. 19, 2018	Jun. 18, 2019~ Jul. 04, 2019	Dec. 18 2019	Conducted (TH05-HY)
Spectrum Analyzer	Rohde & Schwarz	FSP40	100057	9kHz-40GHz	Nov. 21, 2018	Jun. 18, 2019~ Jul. 04, 2019	Nov. 20, 2019	Conducted (TH05-HY)
Signal Analyzer	Rohde & Schwarz	FSV40	101397	10Hz~40GHz	Nov. 13, 2018	Jun. 18, 2019~ Jul. 04, 2019	Nov. 12, 2019	Conducted (TH05-HY)
Switch Box & RF Cable	Burgeon	ETF-058	EC1208382	N/A	Mar. 27, 2019	Jun. 18, 2019~ Jul. 04, 2019	Mar. 26, 2020	Conducted (TH05-HY)
AC Power Source	ChainTek	APC-1000W	N/A	N/A	N/A	Jun. 30, 2019	N/A	Conduction (CO05-HY)
EMI Test Receiver	Rohde & Schwarz	ESR3	102388	9kHz~3.6GHz	Nov. 12, 2018	Jun. 30, 2019	Nov. 11, 2019	Conduction (CO05-HY)
Hygrometer	Testo	608-H1	34913912	N/A	Mar. 19, 2019	Jun. 30, 2019	Mar. 18, 2020	Conduction (CO05-HY)
LISN	Rohde & Schwarz	ENV216	100080	9kHz~30MHz	Nov. 14, 2018	Jun. 30, 2019	Nov. 13, 2019	Conduction (CO05-HY)
LISN	Rohde & Schwarz	ENV216	100081	9kHz~30MHz	Nov. 09, 2018	Jun. 30, 2019	Nov. 08, 2019	Conduction (CO05-HY)
Software	Rohde & Schwarz	EMC32 V10.30	N/A	N/A	N/A	Jun. 30, 2019	N/A	Conduction (CO05-HY)
LF Cable	HUBER + SUHNER	RG-214/U	LF01	N/A	Dec. 31, 2018	Jun. 30, 2019	Dec. 30, 2019	Conduction (CO05-HY)
Pulse Limiter	Rohde & Schwarz	ESH3-Z2	100851	N/A	Dec. 31, 2018	Jun. 30, 2019	Dec. 30, 2019	Conduction (CO05-HY)
Loop Antenna	Rohde & Schwarz	HFH2-Z2	100315	9 kHz~30 MHz	Jan. 11, 2019	Jul. 03, 2019~ Jul. 08, 2019	Jan. 10, 2020	Radiation (03CH16-HY)
Bilog Antenna	TESEQ	CBL6111D& 00802N1D0 1N-06	47020&06	30MHz to 1GHz	Oct. 13, 2018	Jul. 03, 2019~ Jul. 08, 2019	Oct. 12, 2019	Radiation (03CH16-HY)
Horn Antenna	SCHWARZBE CK	BBHA 9120 D	9120D-1522	1G~18GHz	Sep. 07, 2018	Jul. 03, 2019~ Jul. 08, 2019	Sep. 06, 2019	Radiation (03CH16-HY)
SHF-EHF Horn Antenna	SCHWARZBE CK	BBHA 9170	BBHA91702 51	18GHz ~ 40GHz	Nov. 20, 2018	Jul. 03, 2019~ Jul. 08, 2019	Nov. 19, 2019	Radiation (03CH16-HY)
Amplifier	SONOMA	310N	371607	9kHz~1000MHz	Oct. 02. 2018	Jul. 03, 2019~ Jul. 08, 2019	Oct. 01. 2019	Radiation (03CH16-HY)
Preamplifier	Jet-Power	JPA0118-55- 303	1710001800 055007	1GHz~18GHz	Apr. 01, 2019	Jul. 03, 2019~ Jul. 08, 2019	Mar. 31, 2020	Radiation (03CH16-HY)
Preamplifier	Keysight	83017A	MY5327026 4	1GHz~26.5GHz	Dec. 12, 2018	Jul. 03, 2019~ Jul. 08, 2019	Dec. 11, 2019	Radiation (03CH16-HY)
Amplifier	MITEQ	TTA1840-35- HG	1871923	18GHz~40GHz, VSWR : 2.5:1 max	Jul. 16, 2018	Jul. 03, 2019~ Jul. 08, 2019	Jul. 15, 2019	Radiation (03CH16-HY)
EMI Test Receiver	Keysight	N9038A (MXE)	MY57290111	3Hz~26.5GHz	Nov. 29, 2018	Jul. 03, 2019~ Jul. 08, 2019	Nov. 28, 2019	Radiation (03CH16-HY)
Spectrum Analyzer	Agilent	N9010A	MY5420048 6	10Hz~44GHz	Oct. 19, 2018	Jul. 03, 2019~ Jul. 08, 2019	Oct. 18, 2019	Radiation (03CH16-HY)



Instrument	Manufacturer	Model No.	Serial No.	Characteristics	Calibration Date	Test Date	Due Date	Remark
Hygrometer	TECEPEL	DTM-303B	TP162965	N/A	Oct. 22, 2018	Jul. 03, 2019~ Jul. 08, 2019	Oct. 21, 2019	Radiation (03CH16-HY)
Filter	Wainwright	WLK4-1000- 1530-8000-4 0SS	SN11	1G Low Pass	Sep. 16, 2018	Jul. 03, 2019~ Jul. 08, 2019	Sep. 15, 2019	Radiation (03CH16-HY)
Filter	Wainwright	WHKX8-587 2.5-6750-18 000-40ST	SN3	6.75 GHz Highpass	Sep. 16, 2018	Jul. 03, 2019~ Jul. 08, 2019	Sep. 15, 2019	Radiation (03CH16-HY)
RF Cable	HUBER + SUHNER	SUCOFLEX 126E	MY1082/26 EA	30M-18G	Oct. 15, 2018	Jul. 03, 2019~ Jul. 08, 2019	Oct. 14, 2019	Radiation (03CH16-HY)
RF Cable	HUBER + SUHNER	SUCOFLEX 104	MY15539/4	30M-18G	Feb. 26, 2019	Jul. 03, 2019~ Jul. 08, 2019	Feb. 25, 2020	Radiation (03CH16-HY)
RF Cable	HUBER + SUHNER	SUCOFLEX 104	MY36980/4	30M~18GHz	Apr. 15, 2019	Jul. 03, 2019~ Jul. 08, 2019	Apr. 14, 2020	Radiation (03CH16-HY)
Controller	ChainTek	3000-1	N/A	Control Turn table & Ant Mast	N/A	Jul. 03, 2019~ Jul. 08, 2019	N/A	Radiation (03CH16-HY)
Antenna Mast	ChainTek	MBS-520-1	N/A	1m~4m	N/A	Jul. 03, 2019~ Jul. 08, 2019	N/A	Radiation (03CH16-HY)
Turn Table	ChainTek	T-200-S-1	N/A	0~360 Degree	N/A	Jul. 03, 2019~ Jul. 08, 2019	N/A	Radiation (03CH16-HY)
Software	Audix	E3 6.2009-8-24	RK-001136	N/A	N/A	Jul. 03, 2019~ Jul. 08, 2019	N/A	Radiation (03CH16-HY)



## 5 Uncertainty of Evaluation

### Uncertainty of Conducted Emission Measurement (150kHz ~ 30MHz)

Measuring Uncertainty for a Level of Confidence of 95% ( $U = 2Uc(y)$ )	2.20
---	------

### Uncertainty of Radiated Emission Measurement (30 MHz ~ 1000 MHz)

Measuring Uncertainty for a Level of Confidence of 95% ( $U = 2Uc(y)$ )	4.90
---	------

### Uncertainty of Radiated Emission Measurement (1000 MHz ~ 18000 MHz)

Measuring Uncertainty for a Level of Confidence of 95% ( $U = 2Uc(y)$ )	5.80
---	------

### Uncertainty of Radiated Emission Measurement (18000 MHz ~ 40000 MHz)

Measuring Uncertainty for a Level of Confidence of 95% ( $U = 2Uc(y)$ )	3.90
---	------



**Appendix A. Test Result of Conducted Test Items**

Test Engineer:	Rebecca Li / Howard lin / AnAn Wu	Temperature:	21~25	°C
Test Date:	2019/6/18~2019/7/4	Relative Humidity:	51~54	%

**TEST RESULTS DATA**  
**26dB and 99% OBW**

Band I													
Mod.	Data Rate	NTX	CH.	Freq. (MHz)	99% Bandwidth (MHz)		26 dB Bandwidth (MHz)		IC 99% Bandwidth Power Limit (dBm)		IC 99% Bandwidth EIRP Limit (dBm)		Note
					Ant 1	Ant 2	Ant 1	Ant 2	Ant 1	Ant 2	Ant 1	Ant 2	
11a	6Mbps	2	36	5180	16.75	16.70	24.60	24.75	-	-	22.23	22.23	
11a	6Mbps	2	44	5220	16.70	16.80	24.60	23.90	-	-	22.23	22.23	
11a	6Mbps	2	48	5240	16.85	16.80	24.30	24.70	-	-	22.25	22.25	
HT20	MCS0	2	36	5180	17.90	17.90	25.25	24.95	-	-	22.53	22.53	
HT20	MCS0	2	44	5220	17.95	17.85	25.20	25.45	-	-	22.52	22.52	
HT20	MCS0	2	48	5240	18.00	17.90	26.00	24.90	-	-	22.53	22.53	
HT40	MCS0	2	38	5190	36.60	36.50	42.23	41.76	-	-	23.01	23.01	
HT40	MCS0	2	46	5230	36.50	36.60	42.35	42.02	-	-	23.01	23.01	
VHT80	MCS0	2	42	5210	76.80	76.80	83.58	83.20	-	-	23.01	23.01	

**TEST RESULTS DATA**  
**Average Power Table**

FCC Band I												
Mod.	Data Rate	NTX	CH.	Freq. (MHz)	Average Conducted Power (dBm)			FCC Conducted Power Limit (dBm)		DG (dBi)		Pass/Fail
					Ant 1	Ant 2	SUM	Ant 1	Ant 2	Ant 1	Ant 2	
11a	6Mbps	1	36	5180	10.00	9.00		24.00	24.00	-2.30	-3.70	Pass
11a	6Mbps	1	44	5220	10.20	8.80		24.00	24.00	-2.30	-3.70	Pass
11a	6Mbps	1	48	5240	10.00	8.80		24.00	24.00	-2.30	-3.70	Pass
HT20	MCS0	1	36	5180	10.20	8.80		24.00	24.00	-2.30	-3.70	Pass
HT20	MCS0	1	44	5220	10.10	8.80		24.00	24.00	-2.30	-3.70	Pass
HT20	MCS0	1	48	5240	10.10	8.80		24.00	24.00	-2.30	-3.70	Pass
HT40	MCS0	1	38	5190	10.10	9.00		24.00	24.00	-2.30	-3.70	Pass
HT40	MCS0	1	46	5230	10.20	8.80		24.00	24.00	-2.30	-3.70	Pass
VHT20	MCS0	1	36	5180	10.10	8.70		24.00	24.00	-2.30	-3.70	Pass
VHT20	MCS0	1	44	5220	10.00	8.70		24.00	24.00	-2.30	-3.70	Pass
VHT20	MCS0	1	48	5240	10.00	8.70		24.00	24.00	-2.30	-3.70	Pass
VHT40	MCS0	1	38	5190	10.00	8.80		24.00	24.00	-2.30	-3.70	Pass
VHT40	MCS0	1	46	5230	10.00	8.70		24.00	24.00	-2.30	-3.70	Pass
VHT80	MCS0	1	42	5210	10.00	8.70		24.00	24.00	-2.30	-3.70	Pass
11a	6Mbps	2	36	5180	10.40	9.10	12.81	24.00		-2.30		Pass
11a	6Mbps	2	44	5220	10.40	9.00	12.77	24.00		-2.30		Pass
11a	6Mbps	2	48	5240	10.20	9.00	12.65	24.00		-2.30		Pass
HT20	MCS0	2	36	5180	10.40	9.10	12.81	24.00		-2.30		Pass
HT20	MCS0	2	44	5220	10.30	8.90	12.67	24.00		-2.30		Pass
HT20	MCS0	2	48	5240	10.30	9.00	12.71	24.00		-2.30		Pass
HT40	MCS0	2	38	5190	10.20	9.10	12.70	24.00		-2.30		Pass
HT40	MCS0	2	46	5230	10.40	9.00	12.77	24.00		-2.30		Pass
VHT20	MCS0	2	36	5180	10.20	9.00	12.65	24.00		-2.30		Pass
VHT20	MCS0	2	44	5220	10.20	8.90	12.61	24.00		-2.30		Pass
VHT20	MCS0	2	48	5240	10.30	8.90	12.67	24.00		-2.30		Pass
VHT40	MCS0	2	38	5190	10.20	9.00	12.65	24.00		-2.30		Pass
VHT40	MCS0	2	46	5230	10.20	9.00	12.65	24.00		-2.30		Pass
VHT80	MCS0	2	42	5210	10.30	9.10	12.75	24.00		-2.30		Pass

**TEST RESULTS DATA**  
**Power Spectral Density**

FCC Band I												
Mod.	Data Rate	NTX	CH.	Freq. (MHz)	Average Power Density (dBm/MHz)			Average PSD Limit (dBm/MHz)		DG (dBi)		Pass /Fail
					Ant 1	Ant 2	SUM	Ant 1	Ant 2	Ant 1	Ant 2	
11a	6Mbps	2	36	5180			2.83	11.00	0.04		Pass	
11a	6Mbps	2	44	5220			3.75	11.00	0.04		Pass	
11a	6Mbps	2	48	5240			3.01	11.00	0.04		Pass	
HT20	MCS0	2	36	5180			2.90	11.00	0.04		Pass	
HT20	MCS0	2	44	5220			3.23	11.00	0.04		Pass	
HT20	MCS0	2	48	5240			3.42	11.00	0.04		Pass	
HT40	MCS0	2	38	5190			-0.04	11.00	0.04		Pass	
HT40	MCS0	2	46	5230			0.02	11.00	0.04		Pass	
VHT80	MCS0	2	42	5210			-2.11	11.00	0.04		Pass	

**TEST RESULTS DATA**  
**26dB and 99% OBW**

Band II															
Mod.	Data Rate	NTX	CH.	Freq. (MHz)	99% Bandwidth (MHz)		26 dB Bandwidth (MHz)		IC 99% Bandwidth Power Limit (dBm)		IC 99% Bandwidth EIRP Limit (dBm)		FCC 26dB Bandwidth Power Limit (dBm)		Note
					Ant 1	Ant 2	Ant 1	Ant 2	Ant 1	Ant 2	Ant 1	Ant 2	Ant 1	Ant 2	
11a	6Mbps	2	52	5260	16.80	16.75	24.60	25.20	23.24		29.24		23.98		
11a	6Mbps	2	60	5300	16.75	16.75	24.70	25.35	23.24		29.24		23.98		
11a	6Mbps	2	64	5320	16.80	16.75	24.55	23.85	23.24		29.24		23.98		
HT20	MCS0	2	52	5260	17.90	17.95	25.40	25.05	23.53		29.53		23.98		
HT20	MCS0	2	60	5300	17.90	17.90	25.15	25.25	23.53		29.53		23.98		
HT20	MCS0	2	64	5320	17.95	17.90	25.60	25.50	23.53		29.53		23.98		
HT40	MCS0	2	54	5270	36.50	36.60	41.99	41.94	23.98		30.00		23.98		
HT40	MCS0	2	62	5310	36.60	36.50	42.30	42.30	23.98		30.00		23.98		
VHT80	MCS0	2	58	5290	76.92	76.80	83.57	83.20	23.98		30.00		23.98		

**TEST RESULTS DATA**  
**Average Power Table**

FCC Band II													
Mod.	Data Rate	NTX	CH.	Freq. (MHz)	Average Conducted Power (dBm)			FCC Conducted Power Limit (dBm)		DG (dBi)		EIRP Power Limit (dBm)	Pass/Fail
					Ant 1	Ant 2	SUM	Ant 1	Ant 2	Ant 1	Ant 2		
11a	6Mbps	1	52	5260	10.00	8.90		23.98	23.98	-1.50	-3.60	26.99	Pass
11a	6Mbps	1	60	5300	10.10	8.80		23.98	23.98	-1.50	-3.60	26.99	Pass
11a	6Mbps	1	64	5320	10.20	8.90		23.98	23.98	-1.50	-3.60	26.99	Pass
HT20	MCS0	1	52	5260	10.30	8.80		23.98	23.98	-1.50	-3.60	26.99	Pass
HT20	MCS0	1	60	5300	10.30	9.00		23.98	23.98	-1.50	-3.60	26.99	Pass
HT20	MCS0	1	64	5320	10.10	8.80		23.98	23.98	-1.50	-3.60	26.99	Pass
HT40	MCS0	1	54	5270	10.10	8.80		23.98	23.98	-1.50	-3.60	26.99	Pass
HT40	MCS0	1	62	5310	10.20	8.80		23.98	23.98	-1.50	-3.60	26.99	Pass
VHT20	MCS0	1	52	5260	10.10	8.70		23.98	23.98	-1.50	-3.60	26.99	Pass
VHT20	MCS0	1	60	5300	10.10	8.90		23.98	23.98	-1.50	-3.60	26.99	Pass
VHT20	MCS0	1	64	5320	10.00	8.70		23.98	23.98	-1.50	-3.60	26.99	Pass
VHT40	MCS0	1	54	5270	10.00	8.70		23.98	23.98	-1.50	-3.60	26.99	Pass
VHT40	MCS0	1	62	5310	10.00	8.70		23.98	23.98	-1.50	-3.60	26.99	Pass
VHT80	MCS0	1	58	5290	10.30	8.70		23.98	23.98	-1.50	-3.60	26.99	Pass
11a	6Mbps	2	52	5260	10.20	9.10	12.70	23.98		-1.50		26.99	Pass
11a	6Mbps	2	60	5300	10.40	9.00	12.77	23.98		-1.50		26.99	Pass
11a	6Mbps	2	64	5320	10.40	9.10	12.81	23.98		-1.50		26.99	Pass
HT20	MCS0	2	52	5260	10.40	9.00	12.77	23.98		-1.50		26.99	Pass
HT20	MCS0	2	60	5300	10.40	9.10	12.81	23.98		-1.50		26.99	Pass
HT20	MCS0	2	64	5320	10.20	9.10	12.70	23.98		-1.50		26.99	Pass
HT40	MCS0	2	54	5270	10.30	9.10	12.75	23.98		-1.50		26.99	Pass
HT40	MCS0	2	62	5310	10.40	9.10	12.81	23.98		-1.50		26.99	Pass
VHT20	MCS0	2	52	5260	10.30	9.00	12.71	23.98		-1.50		26.99	Pass
VHT20	MCS0	2	60	5300	10.20	9.10	12.70	23.98		-1.50		26.99	Pass
VHT20	MCS0	2	64	5320	10.10	8.90	12.55	23.98		-1.50		26.99	Pass
VHT40	MCS0	2	54	5270	10.20	9.00	12.65	23.98		-1.50		26.99	Pass
VHT40	MCS0	2	62	5310	10.20	9.00	12.65	23.98		-1.50		26.99	Pass
VHT80	MCS0	2	58	5290	10.40	8.90	12.72	23.98		-1.50		26.99	Pass

**TEST RESULTS DATA**  
**Power Spectral Density**

Band II												
Mod.	Data Rate	NTX	CH.	Freq. (MHz)	Average Power Density (dBm/MHz)			Average PSD Limit (dBm/MHz)		DG (dBi)		Pass /Fail
					Ant 1	Ant 2	SUM	Ant 1	Ant 2	Ant 1	Ant 2	
11a	6Mbps	2	52	5260			2.62	11.00	0.52		Pass	
11a	6Mbps	2	60	5300			3.15	11.00	0.52		Pass	
11a	6Mbps	2	64	5320			3.25	11.00	0.52		Pass	
HT20	MCS0	2	52	5260			2.92	11.00	0.52		Pass	
HT20	MCS0	2	60	5300			3.03	11.00	0.52		Pass	
HT20	MCS0	2	64	5320			3.09	11.00	0.52		Pass	
HT40	MCS0	2	54	5270			-1.01	11.00	0.52		Pass	
HT40	MCS0	2	62	5310			-0.20	11.00	0.52		Pass	
VHT80	MCS0	2	58	5290			-2.60	11.00	0.52		Pass	

**TEST RESULTS DATA**  
**26dB and 99% OBW**

Band III																
Mod.	Data Rate	NTX	CH.	Freq. (MHz)	99% Bandwidth In U-NII 2C (MHz)		26 dB Bandwidth In U-NII 2C (MHz)		IC 99% Bandwidth Power Limit (dBm)		IC 99% Bandwidth EIRP Limit (dBm)		FCC 26dB Bandwidth Power Limit (dBm)		6 dB Bandwidth for Straddle Channel (MHz)	
					Ant 1	Ant 2	Ant 1	Ant 2	Ant 1	Ant 2	Ant 1	Ant 2	Ant 1	Ant 2	Ant 1	Ant 2
11a	6Mbps	2	100	5500	16.80	16.75	24.90	24.95	23.24	23.24	29.24	29.24	23.98	----	----	
11a	6Mbps	2	116	5580	16.80	16.70	24.60	25.20	23.23	23.23	29.23	29.23	23.98	----	----	
11a	6Mbps	2	140	5700	16.75	16.75	24.50	25.30	23.24	23.24	29.24	29.24	23.98	----	----	
11a	6Mbps	2	144	5720	13.40	13.40	16.80	17.10	22.27	22.27	28.27	28.27	23.25	2.55	3.1	
HT20	MCS0	2	100	5500	17.95	17.90	25.55	25.10	23.53	23.53	29.53	29.53	23.98	----	----	
HT20	MCS0	2	116	5580	17.90	17.90	25.65	24.80	23.53	23.53	29.53	29.53	23.98	----	----	
HT20	MCS0	2	140	5700	17.95	17.90	26.30	25.35	23.53	23.53	29.53	29.53	23.98	----	----	
HT20	MCS0	2	144	5720	14.00	14.00	18.05	17.55	22.46	22.46	28.46	28.46	23.44	3.35	3.4	
HT40	MCS0	2	102	5510	36.50	36.60	42.12	41.83	23.98	23.98	30.00	30.00	23.98	----	----	
HT40	MCS0	2	110	5550	36.60	36.60	46.31	41.82	23.98	23.98	30.00	30.00	23.98	----	----	
HT40	MCS0	2	134	5670	36.50	36.50	42.30	41.76	23.98	23.98	30.00	30.00	23.98	----	----	
HT40	MCS0	2	142	5710	33.30	33.30	35.84	35.96	23.98	23.98	30.00	30.00	23.98	2.92	3.18	
VHT80	MCS0	2	106	5530	77.04	77.04	84.38	83.93	23.98	23.98	30.00	30.00	23.98	----	----	
VHT80	MCS0	2	122	5610	77.04	76.92	83.84	83.26	23.98	23.98	30.00	30.00	23.98	----	----	
VHT80	MCS0	2	138	5690	73.28	73.52	76.65	76.44	23.98	23.98	30.00	30.00	23.98	2.64	2.6	



**TEST RESULTS DATA**  
**Average Power Table**

FCC Band III													
Mod.	Data Rate	NTX	CH.	Freq. (MHz)	Average Conducted Power (dBm)			FCC Conducted Power Limit (dBm)		DG (dBi)		EIRP Power Limit (dBm)	Pass/Fail
					Ant 1	Ant 2	SUM	Ant 1	Ant 2	Ant 1	Ant 2		
11a	6Mbps	1	100	5500	10.10	8.90		23.98	23.98	-2.90	-1.50	26.99	Pass
11a	6Mbps	1	116	5580	10.10	8.90		23.98	23.98	-2.90	-1.50	26.99	Pass
11a	6Mbps	1	140	5700	10.20	8.80		23.98	23.98	-2.90	-1.50	26.99	Pass
11a	6Mbps	1	144	5720	10.10	8.70		23.98	23.98	-2.90	-1.50	26.99	Pass
HT20	MCS0	1	100	5500	10.10	8.80		23.98	23.98	-2.90	-1.50	26.99	Pass
HT20	MCS0	1	116	5580	10.20	9.00		23.98	23.98	-2.90	-1.50	26.99	Pass
HT20	MCS0	1	140	5700	10.10	8.80		23.98	23.98	-2.90	-1.50	26.99	Pass
HT20	MCS0	1	144	5720	10.10	9.00		23.98	23.98	-2.90	-1.50	26.99	Pass
HT40	MCS0	1	102	5510	10.10	8.80		23.98	23.98	-2.90	-1.50	26.99	Pass
HT40	MCS0	1	110	5550	10.10	9.00		23.98	23.98	-2.90	-1.50	26.99	Pass
HT40	MCS0	1	134	5670	10.10	8.90		23.98	23.98	-2.90	-1.50	26.99	Pass
HT40	MCS0	1	142	5710	10.10	9.00		23.98	23.98	-2.90	-1.50	26.99	Pass
VHT20	MCS0	1	100	5500	10.00	8.70		23.98	23.98	-2.90	-1.50	26.99	Pass
VHT20	MCS0	1	116	5580	10.10	8.80		23.98	23.98	-2.90	-1.50	26.99	Pass
VHT20	MCS0	1	140	5700	10.00	8.70		23.98	23.98	-2.90	-1.50	26.99	Pass
VHT20	MCS0	1	144	5720	10.00	8.70		23.98	23.98	-2.90	-1.50	26.99	Pass
VHT40	MCS0	1	102	5510	10.00	8.70		23.98	23.98	-2.90	-1.50	26.99	Pass
VHT40	MCS0	1	110	5550	10.00	8.90		23.98	23.98	-2.90	-1.50	26.99	Pass
VHT40	MCS0	1	134	5670	10.00	8.70		23.98	23.98	-2.90	-1.50	26.99	Pass
VHT40	MCS0	1	142	5710	10.00	8.80		23.98	23.98	-2.90	-1.50	26.99	Pass
VHT80	MCS0	1	106	5530	10.10	8.80		23.98	23.98	-2.90	-1.50	26.99	Pass
VHT80	MCS0	1	122	5610	10.20	9.00		23.98	23.98	-2.90	-1.50	26.99	Pass
VHT80	MCS0	1	138	5690	10.00	8.70		23.98	23.98	-2.90	-1.50	26.99	Pass

FCC Band III													
Mod.	Data Rate	NTX	CH.	Freq. (MHz)	Average Conducted Power (dBm)			FCC Conducted Power Limit (dBm)		DG (dBi)		EIRP Power Limit (dBm)	Pass/Fail
					Ant 1	Ant 2	SUM	Ant 1	Ant 2	Ant 1	Ant 2		
11a	6Mbps	2	100	5500	10.40	9.10	12.81	23.98		-1.50	26.99	Pass	
11a	6Mbps	2	116	5580	10.20	9.10	12.70	23.98		-1.50	26.99	Pass	
11a	6Mbps	2	140	5700	10.40	8.90	12.72	23.98		-1.50	26.99	Pass	
11a	6Mbps	2	144	5720	10.40	9.10	12.81	23.25		-1.50	26.99	Pass	
HT20	MCS0	2	100	5500	10.20	9.00	12.65	23.98		-1.50	26.99	Pass	
HT20	MCS0	2	116	5580	10.40	9.10	12.81	23.98		-1.50	26.99	Pass	
HT20	MCS0	2	140	5700	10.30	9.00	12.71	23.98		-1.50	26.99	Pass	
HT20	MCS0	2	144	5720	10.20	9.20	12.74	23.44		-1.50	26.99	Pass	
HT40	MCS0	2	102	5510	10.40	9.10	12.81	23.98		-1.50	26.99	Pass	
HT40	MCS0	2	110	5550	10.30	9.10	12.75	23.98		-1.50	26.99	Pass	
HT40	MCS0	2	134	5670	10.30	9.00	12.71	23.98		-1.50	26.99	Pass	
HT40	MCS0	2	142	5710	10.40	9.10	12.81	23.98		-1.50	26.99	Pass	
VHT20	MCS0	2	100	5500	10.20	8.90	12.61	23.98		-1.50	26.99	Pass	
VHT20	MCS0	2	116	5580	10.40	9.00	12.77	23.98		-1.50	26.99	Pass	
VHT20	MCS0	2	140	5700	10.30	8.90	12.67	23.98		-1.50	26.99	Pass	
VHT20	MCS0	2	144	5720	10.10	9.00	12.60	23.44		-1.50	26.99	Pass	
VHT40	MCS0	2	102	5510	10.30	9.10	12.75	23.98		-1.50	26.99	Pass	
VHT40	MCS0	2	110	5550	10.20	9.10	12.70	23.98		-1.50	26.99	Pass	
VHT40	MCS0	2	134	5670	10.30	8.90	12.67	23.98		-1.50	26.99	Pass	
VHT40	MCS0	2	142	5710	10.40	9.00	12.77	23.98		-1.50	26.99	Pass	
VHT80	MCS0	2	106	5530	10.40	8.90	12.72	23.98		-1.50	26.99	Pass	
VHT80	MCS0	2	122	5610	10.40	9.10	12.81	23.98		-1.50	26.99	Pass	
VHT80	MCS0	2	138	5690	10.10	8.80	12.51	23.98		-1.50	26.99	Pass	

**TEST RESULTS DATA**  
**Power Spectral Density**

Band III												
Mod.	Data Rate	NTX	CH.	Freq. (MHz)	Average Power Density (dBm/MHz)			Average PSD Limit (dBm/MHz)		DG (dBi)		Pass /Fail
					Ant 1	Ant 2	SUM	Ant 1	Ant 2	Ant 1	Ant 2	
11a	6Mbps	2	100	5500			2.91	11.00	0.84		Pass	
11a	6Mbps	2	116	5580			3.66	11.00	0.84		Pass	
11a	6Mbps	2	140	5700			3.38	11.00	0.84		Pass	
11a	6Mbps	2	144	5720			3.20	11.00	0.84		Pass	
HT20	MCS0	2	100	5500			2.82	11.00	0.84		Pass	
HT20	MCS0	2	116	5580			3.68	11.00	0.84		Pass	
HT20	MCS0	2	140	5700			3.25	11.00	0.84		Pass	
HT20	MCS0	2	144	5720			3.18	11.00	0.84		Pass	
HT40	MCS0	2	102	5510			-0.07	11.00	0.84		Pass	
HT40	MCS0	2	110	5550			0.52	11.00	0.84		Pass	
HT40	MCS0	2	134	5670			0.53	11.00	0.84		Pass	
HT40	MCS0	2	142	5710			-0.08	11.00	0.84		Pass	
VHT80	MCS0	2	106	5530			-2.64	11.00	0.84		Pass	
VHT80	MCS0	2	122	5610			-2.39	11.00	0.84		Pass	
VHT80	MCS0	2	138	5690			-2.13	11.00	0.84		Pass	



## Appendix B. AC Conducted Emission Test Results

Test Engineer :	Jimmy Chang	Temperature :	24~26°C
		Relative Humidity :	52~54%

# EUT Information

Report NO : 940905-02  
 Test Mode : Mode 1  
 Test Voltage : 120Vac/60Hz  
 Phase : Line

Full Spectrum

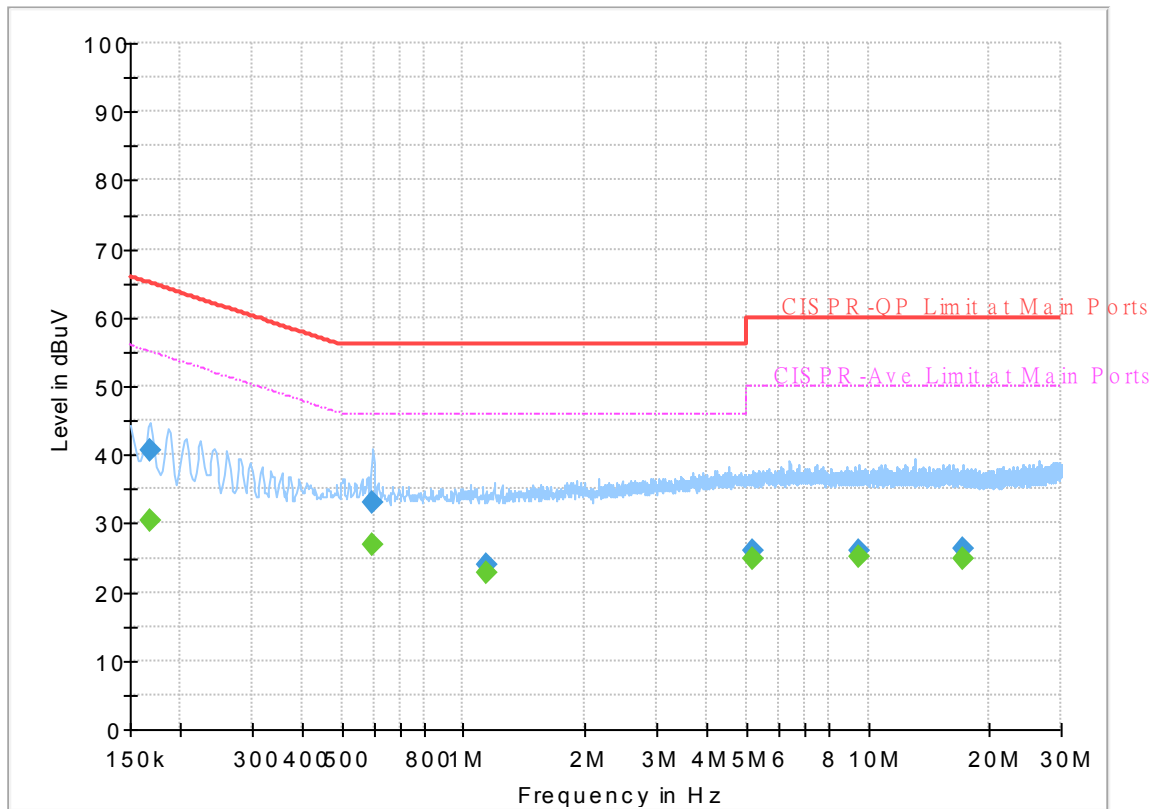

## Final\_Result

Frequency (MHz)	QuasiPeak (dBuV)	CAverage (dBuV)	Limit (dBuV)	Margin (dB)	Line	Filter	Corr. (dB)
0.168000	---	30.43	55.06	24.63	L1	OFF	19.5
0.168000	40.55	---	65.06	24.51	L1	OFF	19.5
0.597750	---	27.01	46.00	18.99	L1	OFF	19.5
0.597750	33.15	---	56.00	22.85	L1	OFF	19.5
1.135500	---	22.75	46.00	23.25	L1	OFF	19.6
1.135500	23.98	---	56.00	32.02	L1	OFF	19.6
5.210250	---	24.87	50.00	25.13	L1	OFF	19.7
5.210250	26.02	---	60.00	33.98	L1	OFF	19.7
9.440250	---	25.08	50.00	24.92	L1	OFF	19.9
9.440250	26.09	---	60.00	33.91	L1	OFF	19.9
17.182500	---	24.90	50.00	25.10	L1	OFF	20.2
17.182500	26.35	---	60.00	33.65	L1	OFF	20.2

## EUT Information

Report NO : 940905-02  
 Test Mode : Mode 1  
 Test Voltage : 120Vac/60Hz  
 Phase : Neutral

Full Spectrum

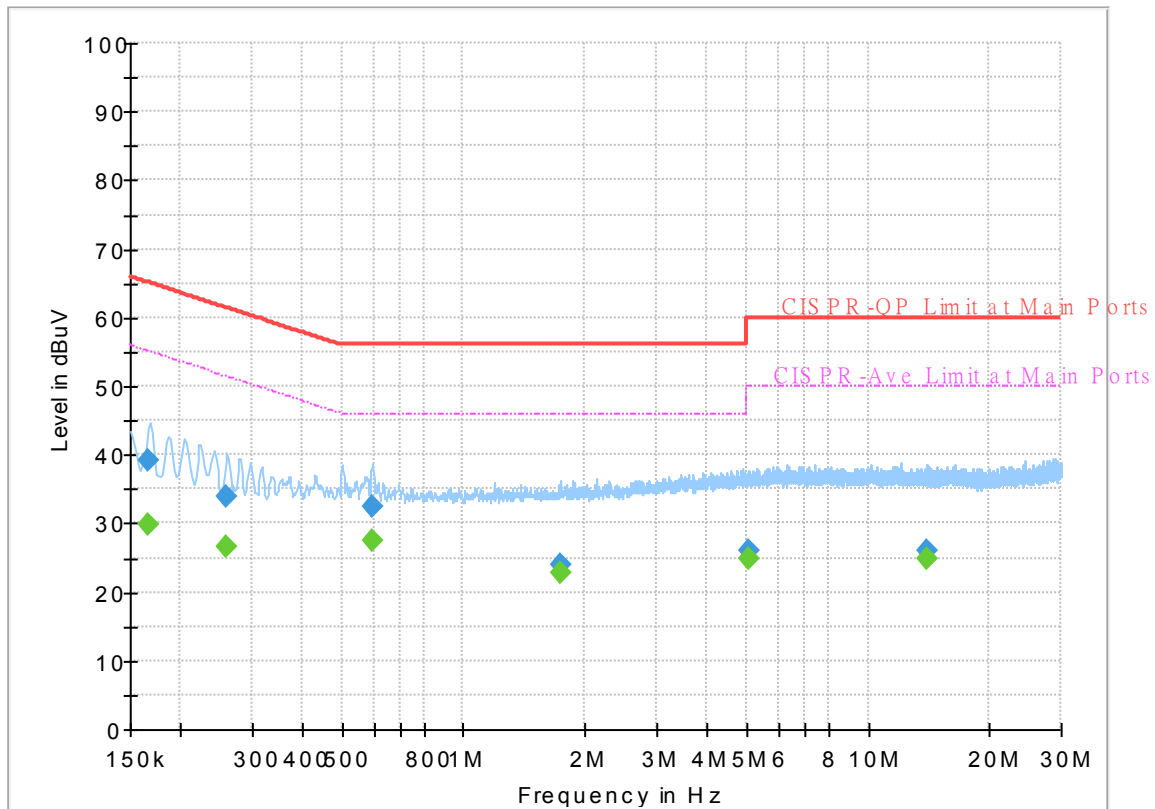

## Final Result

Frequency (MHz)	QuasiPeak (dBuV)	CAverage (dBuV)	Limit (dBuV)	Margin (dB)	Line	Filter	Corr. (dB)
0.165750	---	29.73	55.17	25.44	N	OFF	19.5
0.165750	39.06	---	65.17	26.11	N	OFF	19.5
0.260250	---	26.54	51.42	24.88	N	OFF	19.5
0.260250	33.80	---	61.42	27.62	N	OFF	19.5
0.595500	---	27.36	46.00	18.64	N	OFF	19.5
0.595500	32.39	---	56.00	23.61	N	OFF	19.5
1.734000	---	22.86	46.00	23.14	N	OFF	19.6
1.734000	23.91	---	56.00	32.09	N	OFF	19.6
5.084250	---	24.89	50.00	25.11	N	OFF	19.7
5.084250	26.06	---	60.00	33.94	N	OFF	19.7
13.917750	---	24.84	50.00	25.16	N	OFF	20.1
13.917750	26.09	---	60.00	33.91	N	OFF	20.1



### Appendix C. Radiated Spurious Emission

Test Engineer :	Jacky Hung, Austin LI, CR Liro, and Peter Liao	Temperature :	20~25°C
		Relative Humidity :	50~60%

**Band 1 - 5150~5250MHz**  
**WIFI 802.11a (Band Edge @ 3m)**

WIFI	Note	Frequency	Level	Over	Limit	Read	Antenna	Path	Preamp	Ant	Table	Peak	Pol.	
Ant.				Limit	Line	Level	Factor	Loss	Factor	Pos	Pos	Avg.		
1		( MHz )	( dBµV/m )	( dB )	( dBµV/m )	( dBµV )	( dB/m )	( dB )	( dB )	( cm )	( deg )	( P/A )	( H/V )	
802.11a CH 36 5180MHz		5117.26	56.27	-17.73	74	40.05	32.66	13.28	29.72	198	315	P	H	
		5145.6	44.81	-9.19	54	28.69	32.63	13.21	29.72	198	315	A	H	
	*	5180	107.59	-	-	91.6	32.58	13.13	29.72	198	315	P	H	
	*	5180	99.52	-	-	83.53	32.58	13.13	29.72	198	315	A	H	
													H	
			5068.12	56.21	-17.79	74	39.8	32.72	13.4	29.71	116	196	P	V
			5067.6	43.6	-10.4	54	27.19	32.72	13.4	29.71	116	196	A	V
	*		5180	100.69	-	-	84.7	32.58	13.13	29.72	116	196	P	V
	*		5180	93.05	-	-	77.06	32.58	13.13	29.72	116	196	A	V
														V
802.11a CH 44 5220MHz		5031.72	55.69	-18.31	74	39.16	32.76	13.48	29.71	148	323	P	H	
		5145.6	43.25	-10.75	54	27.13	32.63	13.21	29.72	148	323	A	H	
	*	5220	107.9	-	-	92.01	32.54	13.07	29.72	148	323	P	H	
	*	5220	99.45	-	-	83.56	32.54	13.07	29.72	148	323	A	H	
			5411.84	54.07	-19.93	74	38.5	32.31	12.99	29.73	148	323	P	H
			5452.72	43.31	-10.69	54	27.65	32.26	13.14	29.74	148	323	A	H
			5000.52	55.44	-18.56	74	38.79	32.8	13.56	29.71	166	205	P	V
			5080.6	42.91	-11.09	54	26.55	32.7	13.37	29.71	166	205	A	V
	*		5220	100.7	-	-	84.81	32.54	13.07	29.72	166	205	P	V
	*		5220	92.58	-	-	76.69	32.54	13.07	29.72	166	205	A	V
			5407.64	54.98	-19.02	74	39.42	32.31	12.98	29.73	166	205	P	V
			5452.44	41.86	-12.14	54	26.2	32.26	13.14	29.74	166	205	A	V



<b>802.11a</b> <b>CH 48</b> <b>5240MHz</b>		5015.08	55.45	-18.55	74	38.86	32.78	13.52	29.71	164	318	P	H
		5145.6	42.98	-11.02	54	26.86	32.63	13.21	29.72	164	318	A	H
	*	5240	107.38	-	-	91.54	32.51	13.05	29.72	164	318	P	H
	*	5240	98.95	-	-	83.11	32.51	13.05	29.72	164	318	A	H
		5453.28	54.31	-19.69	74	38.65	32.26	13.14	29.74	164	318	P	H
		5452.72	43.06	-10.94	54	27.4	32.26	13.14	29.74	164	318	A	H
		5112.58	55.25	-18.75	74	39.02	32.66	13.29	29.72	150	198	P	V
		5073.06	42.86	-11.14	54	26.48	32.71	13.38	29.71	150	198	A	V
	*	5240	100.24	-	-	84.4	32.51	13.05	29.72	150	198	P	V
	*	5240	92.29	-	-	76.45	32.51	13.05	29.72	150	198	A	V
		5353.88	54.4	-19.6	74	38.77	32.38	12.98	29.73	150	198	P	V
		5450.48	41.87	-12.13	54	26.22	32.26	13.13	29.74	150	198	A	V
Remark	1. No other spurious found. 2. All results are PASS against Peak and Average limit line.												





Band 1 5150~5250MHz

WIFI 802.11a (Harmonic @ 3m)

WIFI Ant. 1	Note	Frequency ( MHz )	Level ( dBμV/m )	Over Limit ( dB )	Limit Line ( dBμV/m )	Read Level ( dBμV )	Antenna Factor ( dB/m )	Path Loss ( dB )	Preamp Factor ( dB )	Ant Pos ( cm )	Table Pos ( deg )	Peak Avg. ( P/A )	Pol. ( H/V )
802.11a CH 36 5180MHz		10360	45.53	-22.67	68.2	47.44	39.9	17.48	59.29	100	0	P	H
		15540	43.37	-30.63	74	43.91	37.9	21.51	59.95	100	0	P	H
													H
													H
		10360	45.25	-22.95	68.2	47.16	39.9	17.48	59.29	100	0	P	V
		15540	43.11	-30.89	74	43.65	37.9	21.51	59.95	100	0	P	V
													V
													V
802.11a CH 44 5220MHz		10440	45.31	-22.89	68.2	47.07	40.02	17.55	59.33	100	0	P	H
		15660	42.68	-31.32	74	43.13	37.9	21.53	59.88	100	0	P	H
													H
													H
		10440	45.15	-23.05	68.2	46.91	40.02	17.55	59.33	100	0	P	V
		15660	42.94	-31.06	74	43.39	37.9	21.53	59.88	100	0	P	V
													V
													V
802.11a CH 48 5240MHz		10480	45.56	-22.64	68.2	47.26	40.07	17.58	59.35	100	0	P	H
		15720	42.97	-31.03	74	43.37	37.9	21.54	59.84	100	0	P	H
													H
													H
		10480	46.63	-21.57	68.2	48.33	40.07	17.58	59.35	100	0	P	V
		15720	42.87	-31.13	74	43.27	37.9	21.54	59.84	100	0	P	V
													V
													V
Remark	1. No other spurious found. 2. All results are PASS against Peak and Average limit line.												



Band 1 5150~5250MHz

WIFI 802.11n HT20 (Band Edge @ 3m)

WIFI Ant.	Note	Frequency	Level	Over Limit	Limit Line	Read Level	Antenna Factor	Path Loss	Preamp Factor	Ant Pos	Table Pos	Peak Avg.	Pol.	
1		( MHz )	( dBμV/m )	( dB )	( dBμV/m )	( dBμV )	( dB/m )	( dB )	( dB )	( cm )	( deg )	( P/A )	( H/V )	
802.11n HT20 CH 36 5180MHz		5142.74	58.81	-15.19	74	42.68	32.63	13.22	29.72	166	312	P	H	
		5145.6	44.22	-9.78	54	28.1	32.63	13.21	29.72	166	312	A	H	
	*	5180	106.83	-	-	90.84	32.58	13.13	29.72	166	312	P	H	
	*	5180	98.56	-	-	82.57	32.58	13.13	29.72	166	312	A	H	
													H	
														H
			5074.88	56.4	-17.6	74	40.02	32.71	13.38	29.71	300	360	P	V
			5067.86	43.69	-10.31	54	27.28	32.72	13.4	29.71	300	360	A	V
		*	5180	100.45	-	-	84.46	32.58	13.13	29.72	300	360	P	V
		*	5180	92.42	-	-	76.43	32.58	13.13	29.72	300	360	A	V
													V	
													V	
802.11n HT20 CH 44 5220MHz		5117	55.16	-18.84	74	38.94	32.66	13.28	29.72	165	319	P	H	
		5145.6	43.95	-10.05	54	27.83	32.63	13.21	29.72	165	319	A	H	
		* 5220	106.89	-	-	91	32.54	13.07	29.72	165	319	P	H	
		* 5220	98.54	-	-	82.65	32.54	13.07	29.72	165	319	A	H	
			5363.4	53.61	-20.39	74	38.01	32.36	12.97	29.73	165	319	P	H
			5452.72	43.68	-10.32	54	28.02	32.26	13.14	29.74	165	319	A	H
			5081.9	55.18	-18.82	74	38.83	32.7	13.36	29.71	332	345	P	V
			5068.12	43.76	-10.24	54	27.35	32.72	13.4	29.71	332	345	A	V
		*	5220	100.73	-	-	84.84	32.54	13.07	29.72	332	345	P	V
		*	5220	94.38	-	-	78.49	32.54	13.07	29.72	332	345	A	V
		5441.52	54.08	-19.92	74	38.45	32.27	13.1	29.74	332	345	P	V	
		5442.92	42.43	-11.57	54	26.8	32.27	13.1	29.74	332	345	A	V	



<b>802.11n</b>  <b>HT20</b>  <b>CH 48</b>  <b>5240MHz</b>		5071.5	55.86	-18.14	74	39.47	32.71	13.39	29.71	162	309	P	H
		5145.6	43.91	-10.09	54	27.79	32.63	13.21	29.72	162	309	A	H
	*	5240	107.75	-	-	91.91	32.51	13.05	29.72	162	309	P	H
	*	5240	99.57	-	-	83.73	32.51	13.05	29.72	162	309	A	H
		5426.4	54.33	-19.67	74	38.74	32.29	13.04	29.74	162	309	P	H
		5452.72	44.39	-9.61	54	28.73	32.26	13.14	29.74	162	309	A	H
		5082.42	56.35	-17.65	74	40	32.7	13.36	29.71	328	340	P	V
		5078.26	43.72	-10.28	54	27.35	32.71	13.37	29.71	328	340	A	V
	*	5240	100.04	-	-	84.2	32.51	13.05	29.72	328	340	P	V
	*	5240	91.47	-	-	75.63	32.51	13.05	29.72	328	340	A	V
		5391.4	53.91	-20.09	74	38.35	32.33	12.96	29.73	328	340	P	V
		5444.04	42.43	-11.57	54	26.79	32.27	13.11	29.74	328	340	A	V
<b>Remark</b>	1. No other spurious found. 2. All results are PASS against Peak and Average limit line.												



Band 1 5150~5250MHz

WIFI 802.11n HT20 (Harmonic @ 3m)

WIFI Ant. 1	Note	Frequency ( MHz )	Level ( dBμV/m )	Over Limit ( dB )	Limit Line ( dBμV/m )	Read Level ( dBμV )	Antenna Factor ( dB/m )	Path Loss ( dB )	Preamp Factor ( dB )	Ant Pos ( cm )	Table Pos ( deg )	Peak Avg. ( P/A )	Pol. ( H/V )	
802.11n HT20 CH 36 5180MHz		10360	45.61	-22.59	68.2	47.52	39.9	17.48	59.29	100	0	P	H	
		15540	42.71	-31.29	74	43.25	37.9	21.51	59.95	100	0	P	H	
													H	
													H	
			10360	45.69	-22.51	68.2	47.6	39.9	17.48	59.29	100	0	P	V
			15540	43.21	-30.79	74	43.75	37.9	21.51	59.95	100	0	P	V
														V
802.11n HT20 CH 44 5220MHz		10440	45.34	-22.86	68.2	47.1	40.02	17.55	59.33	100	0	P	H	
		15660	43.17	-30.83	74	43.62	37.9	21.53	59.88	100	0	P	H	
													H	
													H	
			10440	45.88	-22.32	68.2	47.64	40.02	17.55	59.33	100	0	P	V
			15660	42.49	-31.51	74	42.94	37.9	21.53	59.88	100	0	P	V
														V
802.11n HT20 CH 48 5240MHz		10480	45.59	-22.61	68.2	47.29	40.07	17.58	59.35	100	0	P	H	
		15720	42.56	-31.44	74	42.96	37.9	21.54	59.84	100	0	P	H	
													H	
													H	
			10480	45.43	-22.77	68.2	47.13	40.07	17.58	59.35	100	0	P	V
			15720	42.46	-31.54	74	42.86	37.9	21.54	59.84	100	0	P	V
														V
Remark	1. No other spurious found.													
	2. All results are PASS against Peak and Average limit line.													



Band 1 5150~5250MHz

WIFI 802.11n HT40 (Band Edge @ 3m)

WIFI Ant.	Note	Frequency	Level	Over Limit	Limit Line	Read Level	Antenna Factor	Path Loss	Preamp Factor	Ant Pos	Table Pos	Peak Avg.	Pol.
1		( MHz )	( dBμV/m )	( dB )	( dBμV/m )	( dBμV )	( dB/m )	( dB )	( dB )	( cm )	( deg )	( P/A )	( H/V )
802.11n HT40 CH 38 5190MHz		5010.14	56.88	-17.12	74	40.26	32.79	13.54	29.71	156	318	P	H
		5149.76	47.73	-6.27	54	31.63	32.62	13.2	29.72	156	318	A	H
	*	5190	104.54	-	-	88.59	32.57	13.1	29.72	156	318	P	H
	*	5190	96.46	-	-	80.51	32.57	13.1	29.72	156	318	A	H
		5443.76	53.95	-20.05	74	38.31	32.27	13.11	29.74	156	318	P	H
		5453	44.02	-9.98	54	28.36	32.26	13.14	29.74	156	318	A	H
		5053.56	55.47	-18.53	74	39.01	32.74	13.43	29.71	316	351	P	V
		5149.76	45.05	-8.95	54	28.95	32.62	13.2	29.72	316	351	A	V
	*	5190	98.31	-	-	82.36	32.57	13.1	29.72	316	351	P	V
	*	5190	89.85	-	-	73.9	32.57	13.1	29.72	316	351	A	V
		5445.44	53.84	-20.16	74	38.2	32.27	13.11	29.74	316	351	P	V
		5430.32	43.78	-10.22	54	28.18	32.28	13.06	29.74	316	351	A	V
802.11n HT40 CH 46 5230MHz		5010.92	55.05	-18.95	74	38.44	32.79	13.53	29.71	162	310	P	H
		5081.9	44.81	-9.19	54	28.46	32.7	13.36	29.71	162	310	A	H
	*	5230	104.69	-	-	88.83	32.52	13.06	29.72	162	310	P	H
	*	5230	96.39	-	-	80.53	32.52	13.06	29.72	162	310	A	H
		5393.92	54.73	-19.27	74	39.18	32.33	12.95	29.73	162	310	P	H
		5452.72	45.11	-8.89	54	29.45	32.26	13.14	29.74	162	310	A	H
		5046.02	55.01	-18.99	74	38.53	32.74	13.45	29.71	295	358	P	V
		5079.3	44.68	-9.32	54	28.32	32.7	13.37	29.71	295	358	A	V
	*	5230	97.7	-	-	81.84	32.52	13.06	29.72	295	358	P	V
	*	5230	89.44	-	-	73.58	32.52	13.06	29.72	295	358	A	V
		5438.16	54.34	-19.66	74	38.72	32.27	13.09	29.74	295	358	P	V
		5451.88	43.4	-10.6	54	27.75	32.26	13.13	29.74	295	358	A	V
Remark	1. No other spurious found. 2. All results are PASS against Peak and Average limit line.												



Band 1 5150~5250MHz

WIFI 802.11n HT40 (Harmonic @ 3m)

WIFI Ant. 1	Note	Frequency ( MHz )	Level ( dBμV/m )	Over Limit ( dB )	Limit Line ( dBμV/m )	Read Level ( dBμV )	Antenna Factor ( dB/m )	Path Loss ( dB )	Preamp Factor ( dB )	Ant Pos ( cm )	Table Pos ( deg )	Peak Avg. ( P/A )	Pol. ( H/V )	
802.11n HT40 CH 38 5190MHz		10380	45.93	-22.27	68.2	47.8	39.93	17.5	59.3	100	0	P	H	
		15570	42.66	-31.34	74	43.18	37.9	21.52	59.94	100	0	P	H	
													H	
													H	
			10380	45.32	-22.88	68.2	47.19	39.93	17.5	59.3	100	0	P	V
			15570	42.95	-31.05	74	43.47	37.9	21.52	59.94	100	0	P	V
														V
802.11n HT40 CH 46 5230MHz		10460	45.74	-22.46	68.2	47.48	40.04	17.56	59.34	100	0	P	H	
		15690	43.16	-30.84	74	43.58	37.9	21.54	59.86	100	0	P	H	
													H	
													H	
			10460	45.9	-22.3	68.2	47.64	40.04	17.56	59.34	100	0	P	V
			15690	42.74	-31.26	74	43.16	37.9	21.54	59.86	100	0	P	V
														V
Remark	1. No other spurious found.													
	2. All results are PASS against Peak and Average limit line.													



Band 1 5150~5250MHz

WIFI 802.11ac VHT80 (Band Edge @ 3m)

WIFI Ant.	Note	Frequency	Level	Over Limit	Limit Line	Read Level	Antenna Factor	Path Loss	Preamp Factor	Ant Pos	Table Pos	Peak Avg.	Pol.
1		( MHz )	( dBμV/m )	( dB )	( dBμV/m )	( dBμV )	( dB/m )	( dB )	( dB )	( cm )	( deg )	( P/A )	( H/V )
802.11ac VHT80 CH 42 5210MHz		5147.16	56.96	-17.04	74	40.85	32.62	13.21	29.72	156	322	P	H
		5148.46	49.18	-4.82	54	33.08	32.62	13.2	29.72	156	322	A	H
	*	5210	101.6	-	-	85.7	32.55	13.07	29.72	156	322	P	H
	*	5210	93.57	-	-	77.67	32.55	13.07	29.72	156	322	A	H
		5386.36	54.11	-19.89	74	38.54	32.34	12.96	29.73	156	322	P	H
		5452.44	44.72	-9.28	54	29.06	32.26	13.14	29.74	156	322	A	H
		5146.38	55.35	-18.65	74	39.24	32.62	13.21	29.72	350	353	P	V
		5132.6	46.05	-7.95	54	29.89	32.64	13.24	29.72	350	353	A	V
	*	5210	94.35	-	-	78.45	32.55	13.07	29.72	350	353	P	V
	*	5210	86.71	-	-	70.81	32.55	13.07	29.72	350	353	A	V
		5423.6	54.26	-19.74	74	38.68	32.29	13.03	29.74	350	353	P	V
	5353.32	44.26	-9.74	54	28.63	32.38	12.98	29.73	350	353	A	V	
Remark	1. No other spurious found. 2. All results are PASS against Peak and Average limit line.												



**Band 1 5150~5250MHz**

**WIFI 802.11ac VHT80 (Harmonic @ 3m)**

WIFI Ant. 1	Note	Frequency ( MHz )	Level ( dBμV/m )	Over Limit ( dB )	Limit Line ( dBμV/m )	Read Level (dBμV)	Antenna Factor ( dB/m )	Path Loss ( dB )	Preamp Factor ( dB )	Ant Pos ( cm )	Table Pos ( deg )	Peak Avg. (P/A)	Pol. (H/V)	
802.11ac VHT80 CH 42 5210MHz		10420	45.59	-22.61	68.2	47.39	39.99	17.53	59.32	100	0	P	H	
		15630	43.17	-30.83	74	43.64	37.9	21.53	59.9	100	0	P	H	
													H	
													H	
			10420	44.69	-23.51	68.2	46.49	39.99	17.53	59.32	100	0	P	V
			15630	42.87	-31.13	74	43.34	37.9	21.53	59.9	100	0	P	V
													V	
													V	

**Remark**  
 1. No other spurious found.  
 2. All results are PASS against Peak and Average limit line.





**Band 2 - 5250~5350MHz**  
**WIFI 802.11a (Band Edge @ 3m)**

WIFI Ant.	Note	Frequency	Level	Over Limit	Limit Line	Read Level	Antenna Factor	Path Loss	Preamp Factor	Ant Pos	Table Pos	Peak Avg.	Pol.
1		( MHz )	( dBμV/m )	( dB )	( dBμV/m )	( dBμV )	( dB/m )	( dB )	( dB )	( cm )	( deg )	( P/A )	( H/V )
802.11a CH 52 5260MHz		5121.72	55.45	-18.55	74	39.25	32.65	13.27	29.72	164	312	P	H
		5145.52	43.06	-10.94	54	26.94	32.63	13.21	29.72	164	312	A	H
	*	5260	108.71	-	-	92.91	32.49	13.04	29.73	164	312	P	H
	*	5260	100.13	-	-	84.33	32.49	13.04	29.73	164	312	A	H
		5407.2	54.78	-19.22	74	39.22	32.31	12.98	29.73	164	312	P	H
		5452.8	43.28	-10.72	54	27.62	32.26	13.14	29.74	164	312	A	H
		5095.88	55.27	-18.73	74	38.98	32.68	13.33	29.72	127	196	P	V
		5073.78	42.9	-11.1	54	26.52	32.71	13.38	29.71	127	196	A	V
	*	5260	101.34	-	-	85.54	32.49	13.04	29.73	127	196	P	V
	*	5260	93.37	-	-	77.57	32.49	13.04	29.73	127	196	A	V
		5446.32	53.87	-20.13	74	38.24	32.26	13.11	29.74	127	196	P	V
		5350.56	41.92	-12.08	54	26.29	32.38	12.98	29.73	127	196	A	V
802.11a CH 60 5300MHz		5128.52	55.22	-18.78	74	39.04	32.65	13.25	29.72	162	313	P	H
		5069.02	42.91	-11.09	54	26.51	32.72	13.39	29.71	162	313	A	H
	*	5300	108.35	-	-	92.63	32.44	13.01	29.73	162	313	P	H
	*	5300	100.09	-	-	84.37	32.44	13.01	29.73	162	313	A	H
		5361.84	55.47	-18.53	74	39.86	32.37	12.97	29.73	162	313	P	H
		5350.08	43.42	-10.58	54	27.79	32.38	12.98	29.73	162	313	A	H
		5089.08	55.44	-18.56	74	39.12	32.69	13.35	29.72	131	194	P	V
		5089.42	42.89	-11.11	54	26.57	32.69	13.35	29.72	131	194	A	V
	*	5300	102.93	-	-	87.21	32.44	13.01	29.73	131	194	P	V
	*	5300	94.18	-	-	78.46	32.44	13.01	29.73	131	194	A	V
		5410.56	53.85	-20.15	74	38.28	32.31	12.99	29.73	131	194	P	V
		5350.32	42.14	-11.86	54	26.51	32.38	12.98	29.73	131	194	A	V



<b>802.11a CH 64 5320MHz</b>	*	5320	109.05	-	-	93.36	32.42	13	29.73	165	307	P	H
	*	5320	100.75	-	-	85.06	32.42	13	29.73	165	307	A	H
		5359.2	54.94	-19.06	74	39.32	32.37	12.98	29.73	165	307	P	H
		5352.64	43.9	-10.1	54	28.27	32.38	12.98	29.73	165	307	A	H
													H
													H
	*	5320	101.72	-	-	86.03	32.42	13	29.73	136	194	P	V
	*	5320	94.08	-	-	78.39	32.42	13	29.73	136	194	A	V
		5351.36	54.75	-19.25	74	39.12	32.38	12.98	29.73	136	194	P	V
		5352.8	42.27	-11.73	54	26.64	32.38	12.98	29.73	136	194	A	V
													V
													V
<b>Remark</b>	<ol style="list-style-type: none"> <li>1. No other spurious found.</li> <li>2. All results are PASS against Peak and Average limit line.</li> </ol>												



Band 2 5250~5350MHz

WIFI 802.11a (Harmonic @ 3m)

WIFI Ant. 1	Note	Frequency ( MHz )	Level ( dBμV/m )	Over Limit ( dB )	Limit Line ( dBμV/m )	Read Level ( dBμV )	Antenna Factor ( dB/m )	Path Loss ( dB )	Preamp Factor ( dB )	Ant Pos ( cm )	Table Pos ( deg )	Peak Avg. ( P/A )	Pol. ( H/V )	
802.11a CH 52 5260MHz		10520	44.95	-23.25	68.2	46.64	40.1	17.61	59.4	100	0	P	H	
		15780	42.9	-31.1	74	43.24	37.9	21.56	59.8	100	0	P	H	
													H	
													H	
			10520	45.07	-23.13	68.2	46.76	40.1	17.61	59.4	100	0	P	V
			15780	44.15	-29.85	74	44.49	37.9	21.56	59.8	100	0	P	V
														V
														V
802.11a CH 60 5300MHz		10600	46.8	-27.2	74	48.6	40.1	17.68	59.58	100	0	P	H	
		15900	43.5	-30.5	74	43.74	37.9	21.58	59.72	100	0	P	H	
													H	
													H	
			10600	46.47	-27.53	74	48.27	40.1	17.68	59.58	100	0	P	V
			15900	43.19	-30.81	74	43.43	37.9	21.58	59.72	100	0	P	V
														V
														V
802.11a CH 64 5320MHz		10640	45.64	-28.36	74	47.51	40.1	17.7	59.67	100	0	P	H	
		15960	44.28	-29.72	74	44.48	37.9	21.59	59.69	100	0	P	H	
													H	
													H	
			10640	46.03	-27.97	74	47.9	40.1	17.7	59.67	100	0	P	V
			15960	43.51	-30.49	74	43.71	37.9	21.59	59.69	100	0	P	V
														V
														V
Remark	1. No other spurious found.													
	2. All results are PASS against Peak and Average limit line.													



Band 2 5250~5350MHz

WIFI 802.11n HT20 (Band Edge @ 3m)

WIFI Ant.	Note	Frequency	Level	Over Limit	Limit Line	Read Level	Antenna Factor	Path Loss	Preamp Factor	Ant Pos	Table Pos	Peak Avg.	Pol.
1		( MHz )	( dBμV/m )	( dB )	( dBμV/m )	( dBμV )	( dB/m )	( dB )	( dB )	( cm )	( deg )	( P/A )	( H/V )
802.11n HT20 CH 52 5260MHz		5104.04	54.23	-19.77	74	37.96	32.68	13.31	29.72	165	316	P	H
		5069.02	43.41	-10.59	54	27.01	32.72	13.39	29.71	165	316	A	H
	*	5260	107.69	-	-	91.89	32.49	13.04	29.73	165	316	P	H
	*	5260	98.37	-	-	82.57	32.49	13.04	29.73	165	316	A	H
		5403.12	54.07	-19.93	74	38.52	32.32	12.96	29.73	165	316	P	H
		5452.8	43.49	-10.51	54	27.83	32.26	13.14	29.74	165	316	A	H
		5086.36	55.09	-18.91	74	38.76	32.7	13.35	29.72	125	329	P	V
		5066.98	43.21	-10.79	54	26.8	32.72	13.4	29.71	125	329	A	V
	*	5260	99.57	-	-	83.77	32.49	13.04	29.73	125	329	P	V
	*	5260	90.58	-	-	74.78	32.49	13.04	29.73	125	329	A	V
		5370	53.68	-20.32	74	38.08	32.36	12.97	29.73	125	329	P	V
		5453.04	42	-12	54	26.34	32.26	13.14	29.74	125	329	A	V
802.11n HT20 CH 60 5300MHz		5017.34	55.38	-18.62	74	38.79	32.78	13.52	29.71	172	307	P	H
		5069.02	43.2	-10.8	54	26.8	32.72	13.39	29.71	172	307	A	H
	*	5300	108.04	-	-	92.32	32.44	13.01	29.73	172	307	P	H
	*	5300	98.78	-	-	83.06	32.44	13.01	29.73	172	307	A	H
		5352.96	54.46	-19.54	74	38.83	32.38	12.98	29.73	172	307	P	H
		5452.8	43.79	-10.21	54	28.13	32.26	13.14	29.74	172	307	A	H
		5020.74	54.66	-19.34	74	38.08	32.78	13.51	29.71	124	328	P	V
		5071.4	43.17	-10.83	54	26.78	32.71	13.39	29.71	124	328	A	V
	*	5300	99.51	-	-	83.79	32.44	13.01	29.73	124	328	P	V
	*	5300	90.06	-	-	74.34	32.44	13.01	29.73	124	328	A	V
		5429.52	54.49	-19.51	74	38.9	32.28	13.05	29.74	124	328	P	V
		5351.52	42.07	-11.93	54	26.44	32.38	12.98	29.73	124	328	A	V



<b>802.11n</b> <b>HT20</b> <b>CH 64</b> <b>5320MHz</b>	*	5320	108.01	-	-	92.32	32.42	13	29.73	156	312	P	H
	*	5320	98.94	-	-	83.25	32.42	13	29.73	156	312	A	H
		5362.08	61.39	-12.61	74	45.78	32.37	12.97	29.73	156	312	P	H
		5352.16	43.82	-10.18	54	28.19	32.38	12.98	29.73	156	312	A	H
													H
													H
	*	5320	98.61	-	-	82.92	32.42	13	29.73	137	318	P	V
	*	5320	89.18	-	-	73.49	32.42	13	29.73	137	318	A	V
		5453.76	55.23	-18.77	74	39.57	32.26	13.14	29.74	137	318	P	V
		5352.96	42.04	-11.96	54	26.41	32.38	12.98	29.73	137	318	A	V
													V
													V
<b>Remark</b>	1. No other spurious found. 2. All results are PASS against Peak and Average limit line.												



Band 2 5250~5350MHz

WIFI 802.11n HT20 (Harmonic @ 3m)

WIFI Ant. 1	Note	Frequency ( MHz )	Level ( dBμV/m )	Over Limit ( dB )	Limit Line ( dBμV/m )	Read Level ( dBμV )	Antenna Factor ( dB/m )	Path Loss ( dB )	Preamp Factor ( dB )	Ant Pos ( cm )	Table Pos ( deg )	Peak Avg. ( P/A )	Pol. ( H/V )	
802.11n HT20 CH 52 5260MHz		10520	45.87	-22.33	68.2	47.56	40.1	17.61	59.4	100	0	P	H	
		15780	43.55	-30.45	74	43.89	37.9	21.56	59.8	100	0	P	H	
													H	
													H	
			10520	45.69	-22.51	68.2	47.38	40.1	17.61	59.4	100	0	P	V
			15780	42.76	-31.24	74	43.1	37.9	21.56	59.8	100	0	P	V
														V
														V
802.11n HT20 CH 60 5300MHz		10600	45.69	-28.31	74	47.49	40.1	17.68	59.58	100	0	P	H	
		15900	42.64	-31.36	74	42.88	37.9	21.58	59.72	100	0	P	H	
													H	
													H	
			10600	45.42	-28.58	74	47.22	40.1	17.68	59.58	100	0	P	V
			15900	42.57	-31.43	74	42.81	37.9	21.58	59.72	100	0	P	V
														V
														V
802.11n HT20 CH 64 5320MHz		10640	45.16	-28.84	74	47.03	40.1	17.7	59.67	100	0	P	H	
		15960	43.78	-30.22	74	43.98	37.9	21.59	59.69	100	0	P	H	
													H	
													H	
			10640	45.92	-28.08	74	47.79	40.1	17.7	59.67	100	0	P	V
			15960	43.2	-30.8	74	43.4	37.9	21.59	59.69	100	0	P	V
														V
														V
Remark	1. No other spurious found. 2. All results are PASS against Peak and Average limit line.													



Band 2 5250~5350MHz

WIFI 802.11n HT40 (Band Edge @ 3m)

WIFI Ant.	Note	Frequency	Level	Over Limit	Limit Line	Read Level	Antenna Factor	Path Loss	Preamp Factor	Ant Pos	Table Pos	Peak Avg.	Pol.
1		( MHz )	( dBμV/m )	( dB )	( dBμV/m )	( dBμV )	( dB/m )	( dB )	( dB )	( cm )	( deg )	( P/A )	( H/V )
802.11n HT40 CH 54 5270MHz		5053.72	55.09	-18.91	74	38.63	32.74	13.43	29.71	156	311	P	H
		5086.02	44.4	-9.6	54	28.07	32.7	13.35	29.72	156	311	A	H
	*	5270	105.69	-	-	89.91	32.48	13.03	29.73	156	311	P	H
	*	5270	96.64	-	-	80.86	32.48	13.03	29.73	156	311	A	H
		5371.68	55.63	-18.37	74	40.04	32.35	12.97	29.73	156	311	P	H
		5452.56	44.94	-9.06	54	29.28	32.26	13.14	29.74	156	311	A	H
		5080.58	54.26	-19.74	74	37.9	32.7	13.37	29.71	102	183	P	V
		5072.76	44.16	-9.84	54	27.77	32.71	13.39	29.71	102	183	A	V
	*	5270	97.45	-	-	81.67	32.48	13.03	29.73	102	183	P	V
	*	5270	88.86	-	-	73.08	32.48	13.03	29.73	102	183	A	V
		5417.76	54.2	-19.8	74	38.63	32.3	13.01	29.74	102	183	P	V
		5421.6	43.37	-10.63	54	27.79	32.29	13.03	29.74	102	183	A	V
802.11n HT40 CH 62 5310MHz		5085.34	54.45	-19.55	74	38.11	32.7	13.36	29.72	159	311	P	H
		5072.76	44.18	-9.82	54	27.79	32.71	13.39	29.71	159	311	A	H
	*	5310	105.07	-	-	89.36	32.43	13.01	29.73	159	311	P	H
	*	5310	96.46	-	-	80.75	32.43	13.01	29.73	159	311	A	H
		5368.32	56.56	-17.44	74	40.96	32.36	12.97	29.73	159	311	P	H
		5350.08	46.59	-7.41	54	30.96	32.38	12.98	29.73	159	311	A	H
		5042.16	54.18	-19.82	74	37.68	32.75	13.46	29.71	107	198	P	V
		5015.98	44.18	-9.82	54	27.59	32.78	13.52	29.71	107	198	A	V
	*	5310	98.3	-	-	82.59	32.43	13.01	29.73	107	198	P	V
	*	5310	89.24	-	-	73.53	32.43	13.01	29.73	107	198	A	V
		5374.32	53.77	-20.23	74	38.18	32.35	12.97	29.73	107	198	P	V
		5350.08	43.77	-10.23	54	28.14	32.38	12.98	29.73	107	198	A	V
Remark	1. No other spurious found. 2. All results are PASS against Peak and Average limit line.												



Band 2 5250~5350MHz

WIFI 802.11n HT40 (Harmonic @ 3m)

WIFI Ant. 1	Note	Frequency ( MHz )	Level ( dBμV/m )	Over Limit ( dB )	Limit Line ( dBμV/m )	Read Level ( dBμV )	Antenna Factor ( dB/m )	Path Loss ( dB )	Preamp Factor ( dB )	Ant Pos ( cm )	Table Pos ( deg )	Peak Avg. ( P/A )	Pol. ( H/V )	
802.11n HT40 CH 54 5270MHz		10540	45.46	-22.74	68.2	47.18	40.1	17.63	59.45	100	0	P	H	
		15810	42.94	-31.06	74	43.25	37.9	21.57	59.78	100	0	P	H	
													H	
													H	
			10540	44.75	-23.45	68.2	46.47	40.1	17.63	59.45	100	0	P	V
			15810	42.53	-31.47	74	42.84	37.9	21.57	59.78	100	0	P	V
														V
														V
802.11n HT40 CH 62 5310MHz		10620	45.93	-28.07	74	47.77	40.1	17.69	59.63	100	0	P	H	
		15930	43.61	-30.39	74	43.82	37.9	21.59	59.7	100	0	P	H	
													H	
													H	
			10620	45.59	-28.41	74	47.43	40.1	17.69	59.63	100	0	P	V
			15930	43.72	-30.28	74	43.93	37.9	21.59	59.7	100	0	P	V
														V
														V
Remark	1. No other spurious found. 2. All results are PASS against Peak and Average limit line.													





Band 2 5250~5350MHz

WIFI 802.11ac VHT80 (Band Edge @ 3m)

WIFI Ant.	Note	Frequency	Level	Over Limit	Limit Line	Read Level	Antenna Factor	Path Loss	Preamp Factor	Ant Pos	Table Pos	Peak Avg.	Pol.
1		( MHz )	( dBμV/m )	( dB )	( dBμV/m )	( dBμV )	( dB/m )	( dB )	( dB )	( cm )	( deg )	( P/A )	( H/V )
802.11ac VHT80 CH 58 5290MHz		5130.9	54.29	-19.71	74	38.12	32.64	13.25	29.72	150	317	P	H
		5070.38	44.03	-9.97	54	27.63	32.72	13.39	29.71	150	317	A	H
	*	5290	102.38	-	-	86.64	32.45	13.02	29.73	150	317	P	H
	*	5290	93.74	-	-	78	32.45	13.02	29.73	150	317	A	H
		5354.16	59.2	-14.8	74	43.57	32.38	12.98	29.73	150	317	P	H
		5350.08	49.97	-4.03	54	34.34	32.38	12.98	29.73	150	317	A	H
		5136.34	54.06	-19.94	74	37.91	32.64	13.23	29.72	105	195	P	V
		5033.66	45.28	-8.72	54	28.75	32.76	13.48	29.71	105	195	A	V
	*	5290	95.32	-	-	79.58	32.45	13.02	29.73	105	195	P	V
	*	5290	86.59	-	-	70.85	32.45	13.02	29.73	105	195	A	V
		5383.92	55.07	-18.93	74	39.5	32.34	12.96	29.73	105	195	P	V
	5353.44	46.39	-7.61	54	30.76	32.38	12.98	29.73	105	195	A	V	
Remark	1. No other spurious found. 2. All results are PASS against Peak and Average limit line.												



Band 2 5250~5350MHz

WIFI 802.11ac VHT80 (Harmonic @ 3m)

WIFI Ant. 1	Note	Frequency ( MHz )	Level ( dBμV/m )	Over Limit ( dB )	Limit Line ( dBμV/m )	Read Level (dBμV)	Antenna Factor ( dB/m )	Path Loss ( dB )	Preamp Factor ( dB )	Ant Pos ( cm )	Table Pos ( deg )	Peak Avg. (P/A)	Pol. (H/V)	
802.11ac VHT80 CH 58 5290MHz		10580	46.02	-22.18	68.2	47.8	40.1	17.66	59.54	100	0	P	H	
		15870	43.2	-30.8	74	43.46	37.9	21.58	59.74	100	0	P	H	
													H	
													H	
			10580	45.19	-23.01	68.2	46.97	40.1	17.66	59.54	100	0	P	V
			15870	43.28	-30.72	74	43.54	37.9	21.58	59.74	100	0	P	V
														V

**Remark**

- No other spurious found.
- All results are PASS against Peak and Average limit line.



**Band 3 - 5470~5725MHz**  
**WIFI 802.11a (Band Edge @ 3m)**

WIFI Ant.	Note	Frequency	Level	Over Limit	Limit Line	Read Level	Antenna Factor	Path Loss	Preamp Factor	Ant Pos	Table Pos	Peak Avg.	Pol.	
1		( MHz )	( dBμV/m )	( dB )	( dBμV/m )	( dBμV )	( dB/m )	( dB )	( dB )	( cm )	( deg )	( P/A )	( H/V )	
802.11a CH 100 5500MHz		5459.12	58.32	-15.68	74	42.65	32.25	13.16	29.74	196	309	P	H	
		5469.84	58.8	-9.4	68.2	43.1	32.24	13.2	29.74	196	309	P	H	
		5452.88	43.39	-10.61	54	27.73	32.26	13.14	29.74	196	309	A	H	
	*	5500	107.31	-	-	91.54	32.2	13.31	29.74	196	309	P	H	
	*	5500	98.98	-	-	83.21	32.2	13.31	29.74	196	309	A	H	
														H
			5420.24	54.3	-19.7	74	38.72	32.3	13.02	29.74	103	197	P	V
			5461.84	53.02	-15.18	68.2	37.34	32.25	13.17	29.74	103	197	P	V
			5458.8	41.85	-12.15	54	26.18	32.25	13.16	29.74	103	197	A	V
	*		5500	102.4	-	-	86.63	32.2	13.31	29.74	103	197	P	V
	*		5500	93.67	-	-	77.9	32.2	13.31	29.74	103	197	A	V
														V
802.11a CH 116 5580MHz		5386.48	54.64	-19.36	74	39.07	32.34	12.96	29.73	190	311	P	H	
		5464.48	53.49	-14.71	68.2	37.81	32.24	13.18	29.74	190	311	P	H	
		5452.72	43.48	-10.52	54	27.82	32.26	13.14	29.74	190	311	A	H	
	*	5580	108.57	-	-	92.38	32.38	13.59	29.78	190	311	P	H	
	*	5580	101.14	-	-	84.95	32.38	13.59	29.78	190	311	A	H	
			5752.715	55.09	-13.11	68.2	38.12	32.76	14.07	29.86	190	311	P	H
			5445.04	54.58	-19.42	74	38.94	32.27	13.11	29.74	206	175	P	V
			5462.56	53.66	-14.54	68.2	37.99	32.24	13.17	29.74	206	175	P	V
			5444.32	42.03	-11.97	54	26.39	32.27	13.11	29.74	206	175	A	V
	*		5580	102.11	-	-	85.92	32.38	13.59	29.78	206	175	P	V
	*		5580	93.13	-	-	76.94	32.38	13.59	29.78	206	175	A	V
			5735.075	55.38	-12.82	68.2	38.49	32.72	14.02	29.85	206	175	P	V



<b>802.11a</b> <b>CH 140</b> <b>5700MHz</b>	*	5700	107.68	-	-	90.95	32.64	13.93	29.84	146	316	P	H
	*	5700	99.72	-	-	82.99	32.64	13.93	29.84	146	316	A	H
		5728.68	63.87	-4.33	68.2	47.01	32.7	14.01	29.85	146	316	P	H
													H
													H
													H
	*	5700	100.09	-	-	83.36	32.64	13.93	29.84	101	168	P	V
	*	5700	91.86	-	-	75.13	32.64	13.93	29.84	101	168	A	V
		5753	55.53	-12.67	68.2	38.56	32.76	14.07	29.86	101	168	P	V
													V
													V
													V
<b>Remark</b>	1. No other spurious found. 2. All results are PASS against Peak and Average limit line.												



Band 3 - 5470~5725MHz

WIFI 802.11a (Harmonic @ 3m)

WIFI Ant. 1	Note	Frequency ( MHz )	Level ( dBμV/m )	Over Limit ( dB )	Limit Line ( dBμV/m )	Read Level ( dBμV )	Antenna Factor ( dB/m )	Path Loss ( dB )	Preamp Factor ( dB )	Ant Pos ( cm )	Table Pos ( deg )	Peak Avg. ( P/A )	Pol. ( H/V )
802.11a CH 100 5500MHz		11000	46.16	-27.84	74	48.55	40.1	17.99	60.48	100	0	P	H
		16500	46.67	-21.53	68.2	43.23	40.1	22.28	58.94	100	0	P	H
													H
													H
		11000	45.02	-28.98	74	47.41	40.1	17.99	60.48	100	0	P	V
		16500	46.3	-21.9	68.2	42.86	40.1	22.28	58.94	100	0	P	V
													V
													V
802.11a CH 116 5580MHz		11160	45.33	-28.67	74	47.81	39.97	18.12	60.57	100	0	P	H
		16740	47.16	-21.04	68.2	41.98	40.96	22.6	58.38	100	0	P	H
													H
													H
		11160	44.91	-29.09	74	47.39	39.97	18.12	60.57	100	0	P	V
		16740	47.39	-20.81	68.2	42.21	40.96	22.6	58.38	100	0	P	V
													V
													V
802.11a CH 140 5700MHz		11400	44.33	-29.67	74	46.95	39.78	18.3	60.7	100	0	P	H
		17100	48.62	-19.58	68.2	40.52	42.42	23.09	57.41	100	0	P	H
													H
													H
		11400	44.75	-29.25	74	47.37	39.78	18.3	60.7	100	0	P	V
		17100	48.81	-19.39	68.2	40.71	42.42	23.09	57.41	100	0	P	V
													V
													V
Remark	<ol style="list-style-type: none"> <li>No other spurious found.</li> <li>All results are PASS against Peak and Average limit line.</li> </ol>												



**Band 3 - 5470~5725MHz**  
**WIFI 802.11n HT20 (Band Edge @ 3m)**

WIFI Ant.	Note	Frequency	Level	Over Limit	Limit Line	Read Level	Antenna Factor	Path Loss	Preamp Factor	Ant Pos	Table Pos	Peak Avg.	Pol.	
1		( MHz )	( dBμV/m )	( dB )	( dBμV/m )	( dBμV )	( dB/m )	( dB )	( dB )	( cm )	( deg )	( P/A )	( H/V )	
802.11n HT20 CH 100 5500MHz		5453.52	57.47	-16.53	74	41.81	32.26	13.14	29.74	150	316	P	H	
		5465.04	58.36	-9.84	68.2	42.68	32.24	13.18	29.74	150	316	P	H	
		5452.72	43.7	-10.3	54	28.04	32.26	13.14	29.74	150	316	A	H	
	*	5500	106.5	-	-	90.73	32.2	13.31	29.74	150	316	P	H	
	*	5500	97.15	-	-	81.38	32.2	13.31	29.74	150	316	A	H	
														H
			5435.76	54.53	-19.47	74	38.91	32.28	13.08	29.74	116	201	P	V
			5463.6	53.1	-15.1	68.2	37.42	32.24	13.18	29.74	116	201	P	V
			5452.56	42.04	-11.96	54	26.38	32.26	13.14	29.74	116	201	A	V
	*		5500	101.79	-	-	86.02	32.2	13.31	29.74	116	201	P	V
	*		5500	92.54	-	-	76.77	32.2	13.31	29.74	116	201	A	V
														V
802.11n HT20 CH 116 5580MHz		5406.64	55.27	-18.73	74	39.72	32.31	12.97	29.73	149	313	P	H	
		5469.28	54.06	-14.14	68.2	38.36	32.24	13.2	29.74	149	313	P	H	
		5452.72	43.12	-10.88	54	27.46	32.26	13.14	29.74	149	313	A	H	
	*	5580	107.18	-	-	90.99	32.38	13.59	29.78	149	313	P	H	
	*	5580	98.44	-	-	82.25	32.38	13.59	29.78	149	313	A	H	
			5747.675	54.88	-13.32	68.2	37.94	32.74	14.06	29.86	149	313	P	H
			5412.16	53.15	-20.85	74	37.58	32.31	12.99	29.73	123	213	P	V
			5465.44	53.23	-14.97	68.2	37.55	32.24	13.18	29.74	123	213	P	V
			5452.24	41.82	-12.18	54	26.16	32.26	13.14	29.74	123	213	A	V
	*		5580	101.52	-	-	85.33	32.38	13.59	29.78	123	213	P	V
	*		5580	92.31	-	-	76.12	32.38	13.59	29.78	123	213	A	V
			5741.06	54.32	-13.88	68.2	37.41	32.73	14.04	29.86	123	213	P	V



<b>802.11n</b> <b>HT20</b> <b>CH 140</b> <b>5700MHz</b>	*	5700	106.58	-	-	89.85	32.64	13.93	29.84	163	301	P	H
	*	5700	97.77	-	-	81.04	32.64	13.93	29.84	163	301	A	H
		5729.48	64.28	-3.92	68.2	47.42	32.7	14.01	29.85	163	301	P	H
													H
													H
													H
	*	5700	98.74	-	-	82.01	32.64	13.93	29.84	105	175	P	V
	*	5700	89.38	-	-	72.65	32.64	13.93	29.84	105	175	A	V
		5733.08	55.09	-13.11	68.2	38.21	32.71	14.02	29.85	105	175	P	V
													V
													V
													V
<b>Remark</b>	1. No other spurious found. 2. All results are PASS against Peak and Average limit line.												



Band 3 - 5470~5725MHz

WIFI 802.11n HT20 (Harmonic @ 3m)

WIFI Ant. 1	Note	Frequency ( MHz )	Level ( dBμV/m )	Over Limit ( dB )	Limit Line ( dBμV/m )	Read Level ( dBμV )	Antenna Factor ( dB/m )	Path Loss ( dB )	Preamp Factor ( dB )	Ant Pos ( cm )	Table Pos ( deg )	Peak Avg. ( P/A )	Pol. ( H/V )	
802.11n HT20 CH 100 5500MHz		11000	46.23	-27.77	74	48.62	40.1	17.99	60.48	100	0	P	H	
		16500	45.94	-22.26	68.2	42.5	40.1	22.28	58.94	100	0	P	H	
													H	
													H	
			11000	46.57	-27.43	74	48.96	40.1	17.99	60.48	100	0	P	V
			16500	47.43	-20.77	68.2	43.99	40.1	22.28	58.94	100	0	P	V
														V
														V
802.11n HT20 CH 116 5580MHz		11160	45.33	-28.67	74	47.81	39.97	18.12	60.57	100	0	P	H	
		16740	47.16	-21.04	68.2	41.98	40.96	22.6	58.38	100	0	P	H	
													H	
													H	
			11160	44.91	-29.09	74	47.39	39.97	18.12	60.57	100	0	P	V
			16740	47.39	-20.81	68.2	42.21	40.96	22.6	58.38	100	0	P	V
														V
														V
802.11n HT20 CH 140 5700MHz		11400	44.82	-29.18	74	47.44	39.78	18.3	60.7	100	0	P	H	
		17100	47.95	-20.25	68.2	39.85	42.42	23.09	57.41	100	0	P	H	
													H	
													H	
			11400	44.28	-29.72	74	46.9	39.78	18.3	60.7	100	0	P	V
			17100	48.76	-19.44	68.2	40.66	42.42	23.09	57.41	100	0	P	V
														V
														V
Remark	<ol style="list-style-type: none"> <li>No other spurious found.</li> <li>All results are PASS against Peak and Average limit line.</li> </ol>													





**Band 3 - 5470~5725MHz**  
**WIFI 802.11n HT40 (Band Edge @ 3m)**

WIFI Ant.	Note	Frequency	Level	Over Limit	Limit Line	Read Level	Antenna Factor	Path Loss	Preamp Factor	Ant Pos	Table Pos	Peak Avg.	Pol.
1		( MHz )	( dBμV/m )	( dB )	( dBμV/m )	( dBμV )	( dB/m )	( dB )	( dB )	( cm )	( deg )	( P/A )	( H/V )
802.11n HT40 CH 102 5510MHz		5434	54.98	-19.02	74	39.37	32.28	13.07	29.74	152	315	P	H
		5464	54.1	-14.1	68.2	38.42	32.24	13.18	29.74	152	315	P	H
		5452.72	44.72	-9.28	54	29.06	32.26	13.14	29.74	152	315	A	H
	*	5510	103.82	-	-	88	32.22	13.34	29.74	152	315	P	H
	*	5510	95.37	-	-	79.55	32.22	13.34	29.74	152	315	A	H
		5738.54	54.95	-13.25	68.2	38.05	32.72	14.03	29.85	152	315	P	H
		5390.32	53.43	-20.57	74	37.87	32.33	12.96	29.73	102	203	P	V
		5468.32	54.12	-14.08	68.2	38.43	32.24	13.19	29.74	102	203	P	V
		5447.68	43.22	-10.78	54	27.58	32.26	13.12	29.74	102	203	A	V
	*	5510	98.99	-	-	83.17	32.22	13.34	29.74	102	203	P	V
	*	5510	90.21	-	-	74.39	32.22	13.34	29.74	102	203	A	V
		5732.555	55.16	-13.04	68.2	38.28	32.71	14.02	29.85	102	203	P	V
802.11n HT40 CH 110 5550MHz		5458.96	53.52	-20.48	74	37.85	32.25	13.16	29.74	156	311	P	H
		5463.04	53.14	-15.06	68.2	37.47	32.24	13.17	29.74	156	311	P	H
		5452.96	44.49	-9.51	54	28.83	32.26	13.14	29.74	156	311	A	H
	*	5550	103.58	-	-	87.55	32.31	13.48	29.76	156	311	P	H
	*	5550	95.67	-	-	79.64	32.31	13.48	29.76	156	311	A	H
		5741.375	54.57	-13.63	68.2	37.66	32.73	14.04	29.86	156	311	P	H
		5415.76	53.54	-20.46	74	37.96	32.3	13.01	29.73	112	201	P	V
		5468.08	52.49	-15.71	68.2	36.8	32.24	13.19	29.74	112	201	P	V
		5444.32	43.56	-10.44	54	27.92	32.27	13.11	29.74	112	201	A	V
	*	5550	98.98	-	-	82.95	32.31	13.48	29.76	112	201	P	V
	*	5550	90.51	-	-	74.48	32.31	13.48	29.76	112	201	A	V
		5746.415	55.57	-12.63	68.2	38.63	32.74	14.06	29.86	112	201	P	V



<b>802.11n</b>  <b>HT40</b>  <b>CH 134</b>  <b>5670MHz</b>		5423.85	54.55	-19.45	74	38.97	32.29	13.03	29.74	157	300	P	H
		5466.55	53.76	-14.44	68.2	38.07	32.24	13.19	29.74	157	300	P	H
		5452.55	44.05	-9.95	54	28.39	32.26	13.14	29.74	157	300	A	H
	*	5670	103.78	-	-	87.18	32.57	13.85	29.82	157	300	P	H
	*	5670	95.81	-	-	79.21	32.57	13.85	29.82	157	300	A	H
		5726.15	62.29	-5.91	68.2	45.44	32.7	14	29.85	157	300	P	H
		5422.45	54.41	-19.59	74	38.83	32.29	13.03	29.74	103	213	P	V
		5466.55	53.6	-14.6	68.2	37.91	32.24	13.19	29.74	103	213	P	V
		5451.15	43.49	-10.51	54	27.84	32.26	13.13	29.74	103	213	A	V
	*	5670	97.08	-	-	80.48	32.57	13.85	29.82	103	213	P	V
	*	5670	88.73	-	-	72.13	32.57	13.85	29.82	103	213	A	V
		5742.775	55.09	-13.11	68.2	38.17	32.73	14.05	29.86	103	213	P	V
<b>Remark</b>	1. No other spurious found. 2. All results are PASS against Peak and Average limit line.												



Band 3 - 5470~5725MHz

WIFI 802.11n HT40 (Harmonic @ 3m)

WIFI Ant. 1	Note	Frequency ( MHz )	Level ( dBμV/m )	Over Limit ( dB )	Limit Line ( dBμV/m )	Read Level ( dBμV )	Antenna Factor ( dB/m )	Path Loss ( dB )	Preamp Factor ( dB )	Ant Pos ( cm )	Table Pos ( deg )	Peak Avg. ( P/A )	Pol. ( H/V )	
802.11n HT40 CH 102 5510MHz		11020	45.61	-28.39	74	48.02	40.08	18	60.49	100	0	P	H	
		16530	47.02	-21.18	68.2	43.36	40.21	22.32	58.87	100	0	P	H	
													H	
													H	
			11020	45.28	-28.72	74	47.69	40.08	18	60.49	100	0	P	V
			16530	46.13	-22.07	68.2	42.47	40.21	22.32	58.87	100	0	P	V
														V
														V
802.11n HT40 CH 110 5550MHz		11100	45.98	-28.02	74	48.43	40.02	18.07	60.54	100	0	P	H	
		16650	46.14	-22.06	68.2	41.61	40.64	22.48	58.59	100	0	P	H	
													H	
													H	
			11100	46.35	-27.65	74	48.8	40.02	18.07	60.54	100	0	P	V
			16650	46.16	-22.04	68.2	41.63	40.64	22.48	58.59	100	0	P	V
														V
														V
802.11n HT40 CH 134 5670MHz		11340	44.81	-29.19	74	47.39	39.83	18.26	60.67	100	0	P	H	
		17010	48.14	-20.06	68.2	40.96	41.95	22.96	57.73	100	0	P	H	
													H	
													H	
			11340	45.95	-28.05	74	48.53	39.83	18.26	60.67	100	0	P	V
			17010	47.79	-20.41	68.2	40.61	41.95	22.96	57.73	100	0	P	V
														V
														V
Remark	1. No other spurious found. 2. All results are PASS against Peak and Average limit line.													



**Band 3 - 5470~5725MHz**

**WIFI 802.11ac VHT80 (Band Edge @ 3m)**

WIFI Ant.	Note	Frequency	Level	Over Limit	Limit Line	Read Level	Antenna Factor	Path Loss	Preamp Factor	Ant Pos	Table Pos	Peak Avg.	Pol.
1		( MHz )	( dBμV/m )	( dB )	( dBμV/m )	( dBμV )	( dB/m )	( dB )	( dB )	( cm )	( deg )	( P/A )	( H/V )
802.11ac VHT80 CH 106 5530MHz		5435.68	56.52	-17.48	74	40.9	32.28	13.08	29.74	153	314	P	H
		5464.48	56.11	-12.09	68.2	40.43	32.24	13.18	29.74	153	314	P	H
		5452.96	46.72	-7.28	54	31.06	32.26	13.14	29.74	153	314	A	H
	*	5530	100.53	-	-	84.6	32.27	13.41	29.75	153	314	P	H
	*	5530	91.93	-	-	76	32.27	13.41	29.75	153	314	A	H
		5737.91	55.76	-12.44	68.2	38.86	32.72	14.03	29.85	153	314	P	H
		5454.64	55.38	-18.62	74	39.73	32.25	13.14	29.74	105	201	P	V
		5466.64	55.51	-12.69	68.2	39.82	32.24	13.19	29.74	105	201	P	V
		5458.72	45.79	-8.21	54	30.12	32.25	13.16	29.74	105	201	A	V
	*	5530	95.93	-	-	80	32.27	13.41	29.75	105	201	P	V
	*	5530	88.03	-	-	72.1	32.27	13.41	29.75	105	201	A	V
	5741.375	56.01	-12.19	68.2	39.1	32.73	14.04	29.86	105	201	P	V	
802.11ac VHT80 CH 122 5610MHz		5452.24	54.45	-19.55	74	38.79	32.26	13.14	29.74	160	298	P	H
		5464.96	54.24	-13.96	68.2	38.56	32.24	13.18	29.74	160	298	P	H
		5452.72	45.75	-8.25	54	30.09	32.26	13.14	29.74	160	298	A	H
	*	5610	101.74	-	-	85.4	32.44	13.69	29.79	160	298	P	H
	*	5610	93.93	-	-	77.59	32.44	13.69	29.79	160	298	A	H
		5739.485	55.35	-12.85	68.2	38.43	32.73	14.04	29.85	160	298	P	H
		5436.16	53.96	-20.04	74	38.34	32.28	13.08	29.74	117	204	P	V
		5469.28	52.73	-15.47	68.2	37.03	32.24	13.2	29.74	117	204	P	V
		5410.72	44.85	-9.15	54	29.28	32.31	12.99	29.73	117	204	A	V
	*	5610	96.09	-	-	79.75	32.44	13.69	29.79	117	204	P	V
	*	5610	88	-	-	71.66	32.44	13.69	29.79	117	204	A	V
	5748.62	55.15	-13.05	68.2	38.2	32.75	14.06	29.86	117	204	P	V	
<b>Remark</b>	1. No other spurious found. 2. All results are PASS against Peak and Average limit line.												



Band 3 5470~5725MHz

WIFI 802.11ac VHT80 (Harmonic @ 3m)

WIFI Ant. 1	Note	Frequency ( MHz )	Level ( dBμV/m )	Over Limit ( dB )	Limit Line ( dBμV/m )	Read Level ( dBμV )	Antenna Factor ( dB/m )	Path Loss ( dB )	Preamp Factor ( dB )	Ant Pos ( cm )	Table Pos ( deg )	Peak Avg. ( P/A )	Pol. ( H/V )	
802.11ac VHT80 CH 106 5530MHz		11060	45.44	-28.56	74	47.87	40.05	18.03	60.51	100	0	P	H	
		16590	46.81	-21.39	68.2	42.73	40.42	22.39	58.73	100	0	P	H	
													H	
													H	
			11060	46.01	-27.99	74	48.44	40.05	18.03	60.51	100	0	P	V
			16590	46.36	-21.84	68.2	42.28	40.42	22.39	58.73	100	0	P	V
														V
802.11ac VHT80 CH 122 5610MHz		11220	45.58	-28.42	74	48.1	39.92	18.16	60.6	100	0	P	H	
		16830	47.17	-21.03	68.2	41.33	41.29	22.72	58.17	100	0	P	H	
													H	
													H	
			11220	45.55	-28.45	74	48.07	39.92	18.16	60.6	100	0	P	V
			16830	48.32	-19.88	68.2	42.48	41.29	22.72	58.17	100	0	P	V
														V
Remark	1. No other spurious found.													
	2. All results are PASS against Peak and Average limit line.													



**Band 3 - Straddle Channel**  
**WIFI 802.11a (Band Edge @ 3m)**

WIFI Ant.	Note	Frequency	Level	Over Limit	Limit Line	Read Level	Antenna Factor	Path Loss	Preamp Factor	Ant Pos	Table Pos	Peak Avg.	Pol.
1		( MHz )	( dBμV/m )	( dB )	( dBμV/m )	( dBμV )	( dB/m )	( dB )	( dB )	( cm )	( deg )	( P/A )	( H/V )
802.11a CH 144 5720MHz		5403.82	54.67	-19.33	74	39.12	32.32	12.96	29.73	161	301	P	H
		5460.76	53.84	-14.36	68.2	38.16	32.25	13.17	29.74	161	301	P	H
		5452.96	43.24	-10.76	54	27.58	32.26	13.14	29.74	161	301	A	H
	*	5720	108.78	-	-	91.97	32.68	13.98	29.85	161	301	P	H
	*	5720	100.84	-	-	84.03	32.68	13.98	29.85	161	301	A	H
		5943.5	56.08	-12.12	68.2	39.13	33.18	13.72	29.95	161	301	P	H
		5448.28	53.55	-20.45	74	37.91	32.26	13.12	29.74	156	209	P	V
		5467.78	52.25	-15.95	68.2	36.56	32.24	13.19	29.74	156	209	P	V
		5445.16	42.24	-11.76	54	26.6	32.27	13.11	29.74	156	209	A	V
	*	5720	101.09	-	-	84.28	32.68	13.98	29.85	156	209	P	V
	*	5720	92.84	-	-	76.03	32.68	13.98	29.85	156	209	A	V
		5926	56.11	-12.09	68.2	39.13	33.14	13.78	29.94	156	209	P	V
<b>Remark</b>	1. No other spurious found. 2. All results are PASS against Peak and Average limit line.												



**Band 3 - Straddle Channel**

**WIFI 802.11a (Harmonic @ 3m)**

WIFI Ant. 1	Note	Frequency ( MHz )	Level ( dBµV/m )	Over Limit ( dB )	Limit Line ( dBµV/m )	Read Level ( dBµV )	Antenna Factor ( dB/m )	Path Loss ( dB )	Preamp Factor ( dB )	Ant Pos ( cm )	Table Pos ( deg )	Peak Avg. ( P/A )	Pol. ( H/V )	
802.11a CH 144 5720MHz		11440	45.34	-28.66	74	47.99	39.75	18.33	60.73	100	0	P	H	
		17160	48.6	-19.6	68.2	39.9	42.73	23.16	57.19	100	0	P	H	
													H	
													H	
			11440	44.82	-29.18	74	47.47	39.75	18.33	60.73	100	0	P	V
			17160	48.98	-19.22	68.2	40.28	42.73	23.16	57.19	100	0	P	V
														V
														V

**Remark**

- No other spurious found.
- All results are PASS against Peak and Average limit line.



**Band 3 - Straddle Channel**  
**WIFI 802.11n HT20 (Band Edge @ 3m)**

WIFI Ant.	Note	Frequency	Level	Over Limit	Limit Line	Read Level	Antenna Factor	Path Loss	Preamp Factor	Ant Pos	Table Pos	Peak Avg.	Pol.
1		( MHz )	( dBμV/m )	( dB )	( dBμV/m )	( dBμV )	( dB/m )	( dB )	( dB )	( cm )	( deg )	( P/A )	( H/V )
802.11n HT20 CH 144 5720MHz		5438.92	53.69	-20.31	74	38.07	32.27	13.09	29.74	158	299	P	H
		5461.15	52.91	-15.29	68.2	37.23	32.25	13.17	29.74	158	299	P	H
		5452.96	43.47	-10.53	54	27.81	32.26	13.14	29.74	158	299	A	H
	*	5720	106.91	-	-	90.1	32.68	13.98	29.85	158	299	P	H
	*	5720	98.43	-	-	81.62	32.68	13.98	29.85	158	299	A	H
		5856	56	-12.2	68.2	38.92	32.98	14.01	29.91	158	299	P	H
		5376.13	53.39	-20.61	74	37.8	32.35	12.97	29.73	168	206	P	V
		5460.76	53.62	-14.58	68.2	37.94	32.25	13.17	29.74	168	206	P	V
		5452.96	42.48	-11.52	54	26.82	32.26	13.14	29.74	168	206	A	V
	*	5720	99.64	-	-	82.83	32.68	13.98	29.85	168	206	P	V
	*	5720	90.52	-	-	73.71	32.68	13.98	29.85	168	206	A	V
		5859.75	56.22	-11.98	68.2	39.14	32.99	14	29.91	168	206	P	V
<b>Remark</b>	1. No other spurious found. 2. All results are PASS against Peak and Average limit line.												





Band 3 - Straddle Channel

WIFI 802.11n HT20 (Harmonic @ 3m)

WIFI Ant. 1	Note	Frequency ( MHz )	Level ( dBμV/m )	Over Limit ( dB )	Limit Line ( dBμV/m )	Read Level (dBμV)	Antenna Factor ( dB/m )	Path Loss ( dB )	Preamp Factor ( dB )	Ant Pos ( cm )	Table Pos ( deg )	Peak Avg. (P/A)	Pol. (H/V)	
802.11n HT20 CH 144 5720MHz		11440	45.06	-28.94	74	47.71	39.75	18.33	60.73	100	0	P	H	
		17160	48.79	-19.41	68.2	40.09	42.73	23.16	57.19	100	0	P	H	
													H	
													H	
			11440	45.49	-28.51	74	48.14	39.75	18.33	60.73	100	0	P	V
			17160	48.79	-19.41	68.2	40.09	42.73	23.16	57.19	100	0	P	V
														V

**Remark**

- No other spurious found.
- All results are PASS against Peak and Average limit line.



**Band 3 - Straddle Channel**  
**WIFI 802.11n HT40 (Band Edge @ 3m)**

WIFI Ant.	Note	Frequency	Level	Over Limit	Limit Line	Read Level	Antenna Factor	Path Loss	Preamp Factor	Ant Pos	Table Pos	Peak Avg.	Pol.
1		( MHz )	( dBμV/m )	( dB )	( dBμV/m )	( dBμV )	( dB/m )	( dB )	( dB )	( cm )	( deg )	( P/A )	( H/V )
802.11n HT40 CH 142 5710MHz		5419.81	54.84	-19.16	74	39.26	32.3	13.02	29.74	158	299	P	H
		5461.93	53.77	-14.43	68.2	38.09	32.25	13.17	29.74	158	299	P	H
		5452.57	44.1	-9.9	54	28.44	32.26	13.14	29.74	158	299	A	H
	*	5710	104.33	-	-	87.55	32.66	13.96	29.84	158	299	P	H
	*	5710	96.31	-	-	79.53	32.66	13.96	29.84	158	299	A	H
		5910.75	56.7	-11.5	68.2	39.71	33.1	13.83	29.94	158	299	P	H
		5357.02	54.22	-19.78	74	38.6	32.37	12.98	29.73	115	211	P	V
		5465.05	53.52	-14.68	68.2	37.84	32.24	13.18	29.74	115	211	P	V
		5442.43	43.58	-10.42	54	27.95	32.27	13.1	29.74	115	211	A	V
	*	5710	96.23	-	-	79.45	32.66	13.96	29.84	115	211	P	V
	*	5710	88.13	-	-	71.35	32.66	13.96	29.84	115	211	A	V
		5861.5	56.98	-11.22	68.2	39.9	33	13.99	29.91	115	211	P	V
<b>Remark</b>	1. No other spurious found. 2. All results are PASS against Peak and Average limit line.												



**Band 3 - Straddle Channel**

**WIFI 802.11n HT40 (Harmonic @ 3m)**

WIFI Ant. 1	Note	Frequency ( MHz )	Level ( dBμV/m )	Over Limit ( dB )	Limit Line ( dBμV/m )	Read Level ( dBμV )	Antenna Factor ( dB/m )	Path Loss ( dB )	Preamp Factor ( dB )	Ant Pos ( cm )	Table Pos ( deg )	Peak Avg. ( P/A )	Pol. ( H/V )	
802.11n HT40 CH 142 5710MHz		11420	45.9	-28.1	74	48.54	39.76	18.32	60.72	100	0	P	H	
		17130	49.13	-19.07	68.2	40.73	42.58	23.12	57.3	100	0	P	H	
													H	
													H	
			11420	44.82	-29.18	74	47.46	39.76	18.32	60.72	100	0	P	V
			17130	48.66	-19.54	68.2	40.26	42.58	23.12	57.3	100	0	P	V
														V

**Remark**

- No other spurious found.
- All results are PASS against Peak and Average limit line.



**Band 3 - Straddle Channel**  
**WIFI 802.11ac VHT80 (Band Edge @ 3m)**

WIFI Ant.	Note	Frequency	Level	Over Limit	Limit Line	Read Level	Antenna Factor	Path Loss	Preamp Factor	Ant Pos	Table Pos	Peak Avg.	Pol.
1		( MHz )	( dBμV/m )	( dB )	( dBμV/m )	( dBμV )	( dB/m )	( dB )	( dB )	( cm )	( deg )	( P/A )	( H/V )
802.11ac VHT80 CH 138 5690MHz		5434.63	54.91	-19.09	74	39.3	32.28	13.07	29.74	157	301	P	H
		5462.71	53.57	-14.63	68.2	37.9	32.24	13.17	29.74	157	301	P	H
		5415.13	44.73	-9.27	54	29.16	32.3	13	29.73	157	301	A	H
	*	5690	100.33	-	-	83.64	32.62	13.9	29.83	157	301	P	H
	*	5690	92.37	-	-	75.68	32.62	13.9	29.83	157	301	A	H
		5868	56.54	-11.66	68.2	39.48	33.01	13.97	29.92	157	301	P	H
		5355.07	54.46	-19.54	74	38.84	32.37	12.98	29.73	155	178	P	V
		5460.37	53.24	-14.96	68.2	37.57	32.25	13.16	29.74	155	178	P	V
		5424.1	44.47	-9.53	54	28.88	32.29	13.04	29.74	155	178	A	V
	*	5690	94.1	-	-	77.41	32.62	13.9	29.83	155	178	P	V
	*	5690	85.82	-	-	69.13	32.62	13.9	29.83	155	178	A	V
		5943.25	56.4	-11.8	68.2	39.45	33.18	13.72	29.95	155	178	P	V
<b>Remark</b>	1. No other spurious found. 2. All results are PASS against Peak and Average limit line.												



**Band 3 - Straddle Channel**

**WIFI 802.11ac VHT80 (Harmonic @ 3m)**

WIFI Ant. 1	Note	Frequency ( MHz )	Level ( dBμV/m )	Over Limit ( dB )	Limit Line ( dBμV/m )	Read Level (dBμV)	Antenna Factor ( dB/m )	Path Loss ( dB )	Preamp Factor ( dB )	Ant Pos ( cm )	Table Pos ( deg )	Peak Avg. (P/A)	Pol. (H/V)	
802.11ac VHT80 CH 138 5690MHz		11380	45.99	-28.01	74	48.59	39.8	18.29	60.69	100	0	P	H	
		17070	47.65	-20.55	68.2	39.86	42.26	23.05	57.52	100	0	P	H	
													H	
													H	
			11380	44.53	-29.47	74	47.13	39.8	18.29	60.69	100	0	P	V
			17070	46.68	-21.52	68.2	38.89	42.26	23.05	57.52	100	0	P	V
														V

**Remark**  
 1. No other spurious found.  
 2. All results are PASS against Peak and Average limit line.



Emission below 1GHz  
WIFI 802.11n HT20 (LF @ 3m)

WIFI Ant.	Note	Frequency	Level	Over Limit	Limit Line	Read Level	Antenna Factor	Path Loss	Preamp Factor	Ant Pos	Table Pos	Peak Avg.	Pol.	
1		( MHz )	( dBμV/m )	( dB )	( dBμV/m )	( dBμV )	( dB/m )	( dB )	( dB )	( cm )	( deg )	( P/A )	( H/V )	
802.11n HT20 LF		155.13	27.4	-16.1	43.5	41.55	16.69	1.52	32.36	-	-	P	H	
		215.27	26.53	-16.97	43.5	41.78	15.19	1.92	32.36	-	-	P	H	
		559.62	26.96	-19.04	46	29.69	26.27	3.64	32.64	-	-	P	H	
		770.11	30.94	-15.06	46	30.69	28.21	4.45	32.41	-	-	P	H	
		870.99	32.36	-13.64	46	30.64	29.03	4.65	31.96	100	0	P	H	
		979.63	34.49	-19.51	54	29.53	30.85	5.2	31.09	-	-	P	H	
														H
														H
														H
														H
														H
														H
			43.58	30.97	-9.03	40	45.44	17.35	0.62	32.44	100	0	P	V
			179.38	27.58	-15.92	43.5	43.24	15.06	1.63	32.35	-	-	P	V
			446.13	23.48	-22.52	46	29.78	23.07	3.17	32.54	-	-	P	V
			559.62	27.35	-18.65	46	30.08	26.27	3.64	32.64	-	-	P	V
			757.5	30.86	-15.14	46	30.58	28.21	4.5	32.43	-	-	P	V
			922.4	32.7	-13.3	46	29.96	29.7	4.63	31.59	-	-	P	V
														V
														V
													V	
													V	
													V	
													V	
													V	
Remark	1. No other spurious found. 2. All results are PASS against limit line.													



**Note symbol**

*	<b>Fundamental Frequency</b> which can be ignored. However, the level of any unwanted emissions shall not exceed the level of the fundamental frequency.
!	Test result is <b>over limit</b> line.
P/A	<b>Peak</b> or <b>Average</b>
H/V	<b>Horizontal</b> or <b>Vertical</b>



A calculation example for radiated spurious emission is shown as below:

WIFI Ant. 1	Note	Frequency ( MHz )	Level ( dBμV/m )	Over Limit ( dB )	Limit Line ( dBμV/m )	Read Level ( dBμV )	Antenna Factor ( dB/m )	Path Loss ( dB )	Preamp Factor ( dB )	Ant Pos ( cm )	Table Pos ( deg )	Peak Avg. ( P/A )	Pol. ( H/V )
802.11b CH 01 2412MHz		2390	55.45	-18.55	74	54.51	32.22	4.58	35.86	103	308	P	H
		2390	43.54	-10.46	54	42.6	32.22	4.58	35.86	103	308	A	H

1. Path Loss(dB) = Cable loss(dB) + Filter loss(dB) + Attenuator loss(dB)
2. Level(dBμV/m) = Antenna Factor(dB/m) + Path Loss(dB) + Read Level(dBμV) - Preamp Factor(dB)
3. Over Limit(dB) = Level(dBμV/m) – Limit Line(dBμV/m)

**For Peak Limit @ 2390MHz:**

1. Level(dBμV/m)  
= Antenna Factor(dB/m) + Path Loss(dB) + Read Level(dBμV) - Preamp Factor(dB)  
= 32.22(dB/m) + 4.58(dB) + 54.51(dBμV) – 35.86 (dB)  
= 55.45 (dBμV/m)
2. Over Limit(dB)  
= Level(dBμV/m) – Limit Line(dBμV/m)  
= 55.45(dBμV/m) – 74(dBμV/m)  
= -18.55(dB)

**For Average Limit @ 2390MHz:**

1. Level(dBμV/m)  
= Antenna Factor(dB/m) + Path Loss(dB) + Read Level(dBμV) - Preamp Factor(dB)  
= 32.22(dB/m) + 4.58(dB) + 42.6(dBμV) – 35.86 (dB)  
= 43.54 (dBμV/m)
2. Over Limit(dB) = Level(dBμV/m) – Limit Line(dBμV/m)  
= 43.54(dBμV/m) – 54(dBμV/m)  
= -10.46(dB)

**Both peak and average measured complies with the limit line, so test result is “PASS”.**





### Appendix D. Radiated Spurious Emission

Test Engineer :	Jacky Hung, Austin LI, CR Liro, and Peter	Temperature :	20~25°C
	Liao	Relative Humidity :	50~60%

#### Note symbol

-L	Low channel location
-R	High channel location



**Band 1 - 5150~5250MHz**  
**WIFI 802.11a (Band Edge @ 3m)**

WIFI	Band 1 5150~5250MHz Band Edge @ 3m	
ANT	802.11a CH36 5180MHz	
2	Horizontal	Fundamental
<b>Peak</b>	<p>Site : 03CH6-HY            Condition : PEAK_BE_74 3m 91200_1522 HORIZONTAL            RBW:1000.0000 Hz VSW:3000.0000 Hz SWT:Auto            Detector : Peak            Project : 940905-02</p>	<p>Site : 03CH6-HY            Condition : PEAK(FUN) 3m 91200_1522 HORIZONTAL            RBW:1000.0000 Hz VSW:3000.0000 Hz SWT:Auto            Detector : Peak            Project : 940905-02</p>
<b>Avg.</b>	<p>Site : 03CH6-HY            Condition : AVG_BE_54 3m 91200_1522 HORIZONTAL            RBW:1000.0000 Hz VSW:0.0000 Hz SWT:Auto            Detector : Peak            Project : 940905-02</p>	<p>Left blank</p>



WIFI	Band 1 5150~5250MHz Band Edge @ 3m	
ANT	802.11a CH36 5180MHz	
2	Vertical	Fundamental
Peak	<p>Site : 03CH16-HY            Condition : PEAK_BE_74 3m 91200_1522 VERTICAL            RBW:1000.0000 Hz VSW:3000.0000 Hz SWT:Auto            Detector : Peak            Project : 940905-02</p>	<p>Site : 03CH16-HY            Condition : PEAK(LINE) 3m 91200_1522 VERTICAL            RBW:1000.0000 Hz VSW:3000.0000 Hz SWT:Auto            Detector : Peak            Project : 940905-02</p>
Avg.	<p>Site : 03CH16-HY            Condition : AVG_BE_54 3m 91200_1522 VERTICAL            RBW:1000.0000 Hz VSW:3000.0000 Hz SWT:Auto            Detector : Peak            Project : 940905-02</p>	Left blank

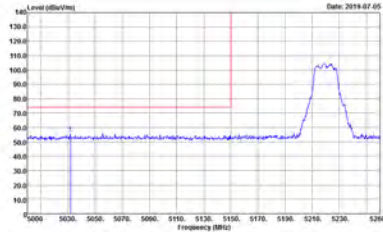
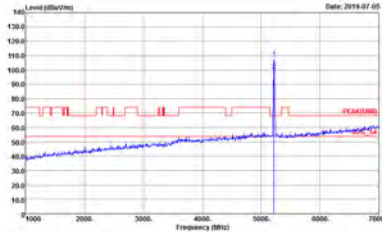
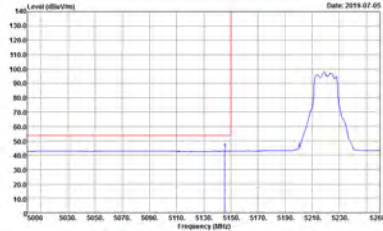

WIFI	Band 1 5150~5250MHz Band Edge @ 3m	
ANT	802.11a CH44 5220MHz - L	
2	Horizontal	Fundamental
Peak	 <p>Site : 03CH16-HY            Condition : PEAK_BE_74 3m 91200_1522 HORIZONTAL            RBW:1000.0000 Hz VSW:3000.0000 Hz SWT:Auto            Detector : Peak            Project : 940905-02</p>	 <p>Site : 03CH16-HY            Condition : PEAK(LINE) 3m 91200_1522 HORIZONTAL            RBW:1000.0000 Hz VSW:3000.0000 Hz SWT:Auto            Detector : Peak            Project : 940905-02</p>
Avg.	 <p>Site : 03CH16-HY            Condition : AVG_BE_54 3m 91200_1522 HORIZONTAL            RBW:1000.0000 Hz VSW:3000.0000 Hz SWT:Auto            Detector : Peak            Project : 940905-02</p>	Left blank

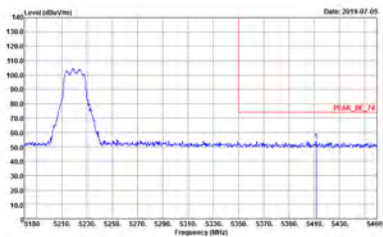
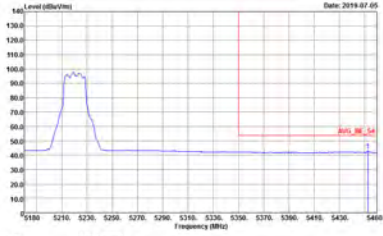

WIFI	Band 1 5150~5250MHz Band Edge @ 3m	
ANT	802.11a CH44 5220MHz - R	
2	Horizontal	Fundamental
<p><b>Peak</b></p>	 <p>Site : 03CH16-HY            Condition : PEAK_BE_74 3m 91200_152Z HORIZONTAL            RBW:3000.0000 Hz VBW:3000.0000 Hz SWT:Auto            Detector : Peak            Project : 940905-02</p>	<p>Left blank</p>
<p><b>Avg.</b></p>	 <p>Site : 03CH16-HY            Condition : AVG_BE_54 3m 91200_152Z HORIZONTAL            RBW:3000.0000 Hz VBW:3000.0000 Hz SWT:Auto            Detector : Peak            Project : 940905-02</p>	<p>Left blank</p>

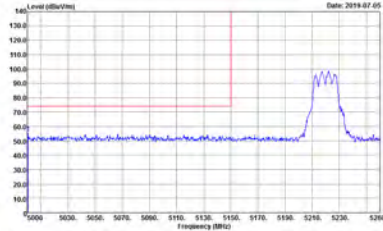
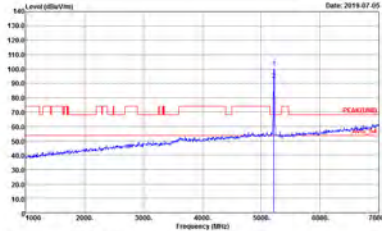
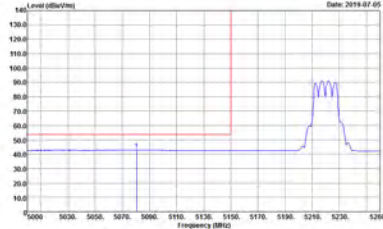

WIFI	Band 1 5150~5250MHz Band Edge @ 3m	
ANT	802.11a CH44 5220MHz - L	
2	Vertical	Fundamental
Peak	 <p>Site : 03CH16-HY            Condition : PEAK_BE_74 3m 91200_1522 VERTICAL            RBW:1000.0000 Hz VSW:3000.0000 Hz SWT:Auto            Detector : Peak            Project : 940905-02</p>	 <p>Site : 03CH16-HY            Condition : PEAK(LINE) 3m 91200_1522 VERTICAL            RBW:1000.0000 Hz VSW:3000.0000 Hz SWT:Auto            Detector : Peak            Project : 940905-02</p>
Avg.	 <p>Site : 03CH16-HY            Condition : AVIS_BE_54 3m 91200_1522 VERTICAL            RBW:1000.0000 Hz VSW:3.0000 Hz SWT:Auto            Detector : Peak            Project : 940905-02</p>	Left blank



WIFI	Band 1 5150~5250MHz Band Edge @ 3m	
ANT	802.11a CH44 5220MHz - R	
2	Vertical	Fundamental
<p><b>Peak</b></p>	<p>Site : 03CH16-HY            Condition : PEAK_BE_74 3m 91200_152Z VERTICAL            RBW:1000.0000 Hz VSW:3000.0000 Hz SWT:Auto            Detector : Peak            Project : 940905-02</p>	<p>Left blank</p>
<p><b>Avg.</b></p>	<p>Site : 03CH16-HY            Condition : AVG_BE_54 3m 91200_152Z VERTICAL            RBW:1000.0000 Hz VSW:3000.0000 Hz SWT:Auto            Detector : Peak            Project : 940905-02</p>	<p>Left blank</p>

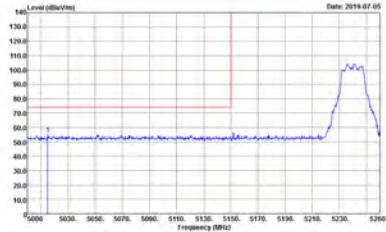
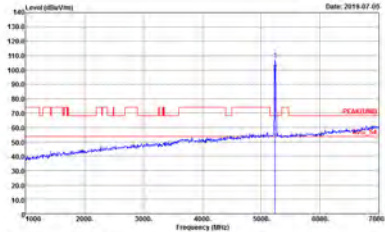
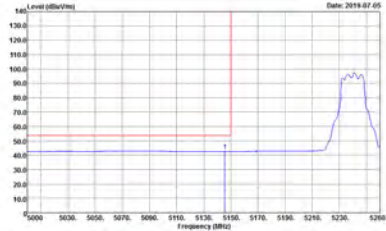

WIFI	Band 1 5150~5250MHz Band Edge @ 3m	
ANT	802.11a CH48 5240MHz - L	
2	Horizontal	Fundamental
Peak	 <p>Site : 03CH16-HY            Condition : PEAK_BE_74 3m 91200_1522 HORIZONTAL            RBW:1000.0000 Hz VSW:3000.0000 Hz SWT:Auto            Detector : Peak            Project : 940905-02</p>	 <p>Site : 03CH16-HY            Condition : PEAK(LINE) 3m 91200_1522 HORIZONTAL            RBW:1000.0000 Hz VSW:3000.0000 Hz SWT:Auto            Detector : Peak            Project : 940905-02</p>
Avg.	 <p>Site : 03CH16-HY            Condition : AVG_BE_54 3m 91200_1522 HORIZONTAL            RBW:1000.0000 Hz VSW:3000.0000 Hz SWT:Auto            Detector : Peak            Project : 940905-02</p>	Left blank



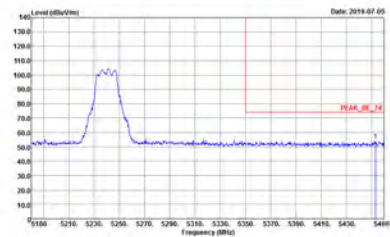
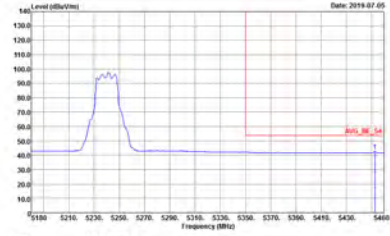

WIFI	Band 1 5150~5250MHz Band Edge @ 3m	
ANT	802.11a CH48 5240MHz - R	
2	Horizontal	Fundamental
<p><b>Peak</b></p>	 <p>Site : 03CH16-HY            Condition : PEAK_BE_74 3m 91200_152Z HORIZONTAL            RBW:3000.0000 Hz VBW:3000.0000 Hz SWT:Auto            Detector : Peak            Project : 940905-02</p>	<p>Left blank</p>
<p><b>Avg.</b></p>	 <p>Site : 03CH16-HY            Condition : AVG_BE_54 3m 91200_152Z HORIZONTAL            RBW:3000.0000 Hz VBW:3000.0000 Hz SWT:Auto            Detector : Peak            Project : 940905-02</p>	<p>Left blank</p>

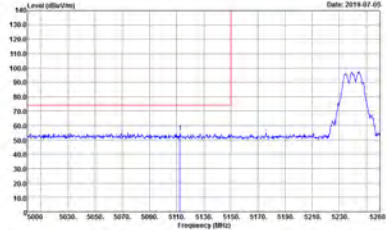
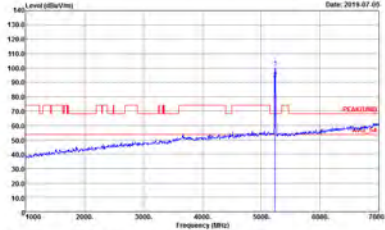
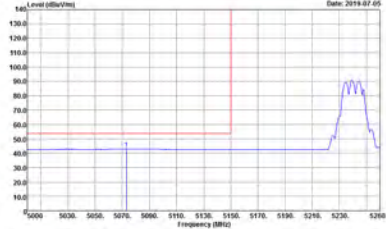

WIFI	Band 1 5150~5250MHz Band Edge @ 3m	
ANT	802.11a CH48 5240MHz - L	
2	Vertical	Fundamental
Peak	 <p>Site : 03CH16-HY            Condition : PEAK_BE_74 3m 91200_1522 VERTICAL            RBW:1000.0000 Hz VSW:3000.0000 Hz SWT:Auto            Detector : Peak            Project : 940905-02</p>	 <p>Site : 03CH16-HY            Condition : PEAK(LINE) 3m 91200_1522 VERTICAL            RBW:1000.0000 Hz VSW:3000.0000 Hz SWT:Auto            Detector : Peak            Project : 940905-02</p>
Avg.	 <p>Site : 03CH16-HY            Condition : AVG_BE_54 3m 91200_1522 VERTICAL            RBW:1000.0000 Hz VSW:3000.0000 Hz SWT:Auto            Detector : Peak            Project : 940905-02</p>	Left blank



WIFI	Band 1 5150~5250MHz Band Edge @ 3m	
ANT	802.11a CH48 5240MHz - R	
2	Vertical	Fundamental
Peak	<p>Site : 03CH16-HY Condition : PEAK_BE_74 3m 91200_152Z VERTICAL RBW:1000.0000 Hz VSW:3000.0000 Hz SWT:Auto Detector : Peak Project : 940905-02</p>	Left blank
Avg.	<p>Site : 03CH16-HY Condition : AVG_BE_54 3m 91200_152Z VERTICAL RBW:1000.0000 Hz VSW:3000.0000 Hz SWT:Auto Detector : Peak Project : 940905-02</p>	Left blank

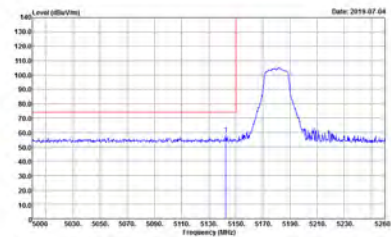
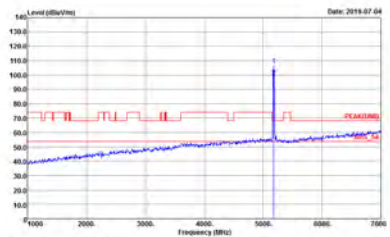
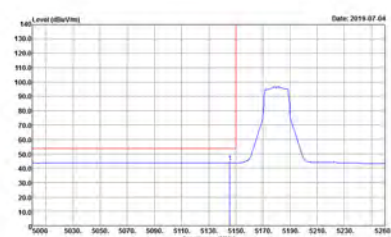

**Band 1 5150~5250MHz**  
**WIFI 802.11n HT20 (Band Edge @ 3m)**

WIFI	Band 1 5150~5250MHz Band Edge @ 3m	
ANT	802.11n HT20 CH36 5180MHz	
2	Horizontal	Fundamental
<b>Peak</b>	 <p>Site : 03CH6-HY            Condition : PEAK_BE_74 3m 91200_1522 HORIZONTAL            RBW:1000.0000 Hz VSW:3000.0000 Hz SWT:Auto            Detector : Peak            Project : 940905-02</p>	 <p>Site : 03CH6-HY            Condition : PEAK(FUN) 3m 91200_1522 HORIZONTAL            RBW:1000.0000 Hz VSW:3000.0000 Hz SWT:Auto            Detector : Peak            Project : 940905-02</p>
<b>Avg.</b>	 <p>Site : 03CH6-HY            Condition : AVG_BE_54 3m 91200_1522 HORIZONTAL            RBW:1000.0000 Hz VSW:3000.0000 Hz SWT:Auto            Detector : Peak            Project : 940905-02</p>	Left blank

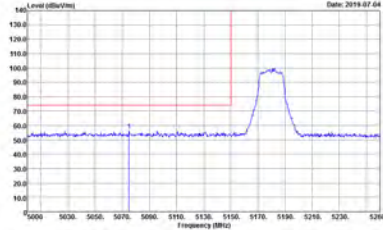
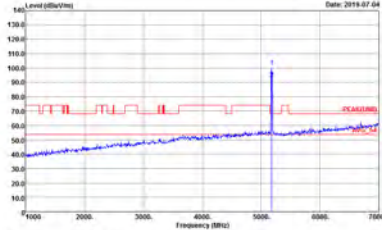
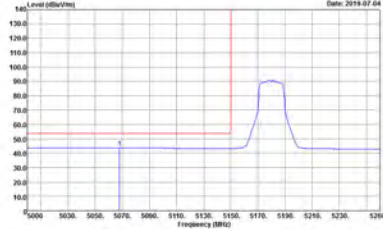

WIFI	Band 1 5150~5250MHz Band Edge @ 3m	
ANT	802.11n HT20 CH36 5180MHz	
2	Vertical	Fundamental
Peak	 <p>Site : 03CH16-HY            Condition : PEAK_BE_74 3m 91200_1522 VERTICAL            RBW:1000.0000 Hz VSW:3000.0000 Hz SWT:Auto            Detector : Peak            Project : 940905-02</p>	 <p>Site : 03CH16-HY            Condition : PEAK(LINE) 3m 91200_1522 VERTICAL            RBW:1000.0000 Hz VSW:3000.0000 Hz SWT:Auto            Detector : Peak            Project : 940905-02</p>
Avg.	 <p>Site : 03CH16-HY            Condition : AVG_BE_54 3m 91200_1522 VERTICAL            RBW:1000.0000 Hz VSW:3000.0000 Hz SWT:Auto            Detector : Peak            Project : 940905-02</p>	Left blank

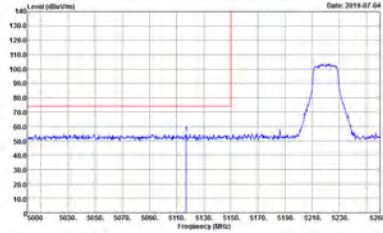
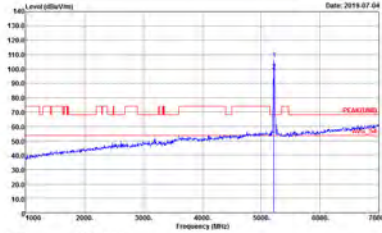
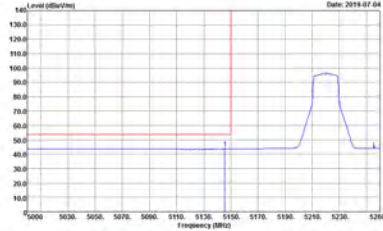

WIFI	Band 1 5150~5250MHz Band Edge @ 3m	
ANT	802.11n HT20 CH44 5220MHz - L	
2	Horizontal	Fundamental
Peak	 <p>Site : 03CH16-HY            Condition : PEAK_BE_74 3m 91200_1522 HORIZONTAL            RBW:1000.0000 Hz VSW:3000.0000 Hz SWT:Auto            Detector : Peak            Project : 940905-02</p>	 <p>Site : 03CH16-HY            Condition : PEAK(LINE) 3m 91200_1522 HORIZONTAL            RBW:1000.0000 Hz VSW:3000.0000 Hz SWT:Auto            Detector : Peak            Project : 940905-02</p>
Avg.	 <p>Site : 03CH16-HY            Condition : AVG_BE_54 3m 91200_1522 HORIZONTAL            RBW:1000.0000 Hz VSW:3000.0000 Hz SWT:Auto            Detector : Peak            Project : 940905-02</p>	Left blank



WIFI	Band 1 5150~5250MHz Band Edge @ 3m	
ANT	802.11n HT20 CH44 5220MHz - R	
2	Horizontal	Fundamental
Peak	<p>Site : 03CH16-HY Condition : PEAK_BE_74 3m 91200_152Z HORIZONTAL RBW:3000.0000 Hz VSW:3000.0000 Hz SWT:Auto Detector : Peak Project : 940905-02</p>	Left blank
Avg.	<p>Site : 03CH16-HY Condition : AVG_BE_54 3m 91200_152Z HORIZONTAL RBW:3000.0000 Hz VSW:3000.0000 Hz SWT:Auto Detector : Peak Project : 940905-02</p>	Left blank



WIFI	Band 1 5150~5250MHz Band Edge @ 3m	
ANT	802.11n HT20 CH44 5220MHz - L	
2	Vertical	Fundamental
Peak	<p>Site : 03CH16-HY            Condition : PEAK_BE_74 3m 91200_1522 VERTICAL            RBW:1000.0000 Hz VSW:3000.0000 Hz SWT:Auto            Detector : Peak            Project : 940905-02</p>	<p>Site : 03CH16-HY            Condition : PEAK(LINE) 3m 91200_1522 VERTICAL            RBW:1000.0000 Hz VSW:3000.0000 Hz SWT:Auto            Detector : Peak            Project : 940905-02</p>
Avg.	<p>Site : 03CH16-HY            Condition : AVG_BE_54 3m 91200_1522 VERTICAL            RBW:1000.0000 Hz VSW:3000.0000 Hz SWT:Auto            Detector : Peak            Project : 940905-02</p>	Left blank





WIFI	Band 1 5150~5250MHz Band Edge @ 3m	
ANT	802.11n HT20 CH44 5220MHz - R	
2	Vertical	Fundamental
Peak	<p>Site : 03CH16-HY Condition : PEAK_BE_74 3m 91200_152Z VERTICAL RBW:3000.0000 Hz VSW:3000.0000 Hz SWT:Auto Detector : Peak Project : 940905-02</p>	Left blank
Avg.	<p>Site : 03CH16-HY Condition : AVG_BE_54 3m 91200_152Z VERTICAL RBW:3000.0000 Hz VSW:3000.0000 Hz SWT:Auto Detector : Peak Project : 940905-02</p>	Left blank

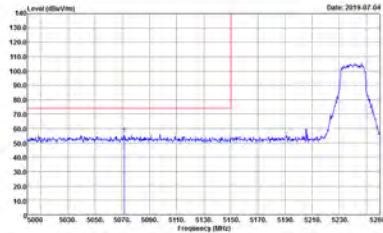
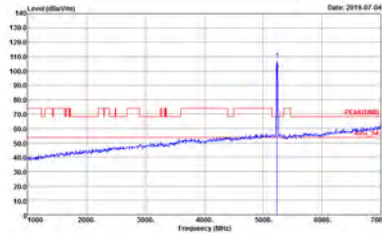
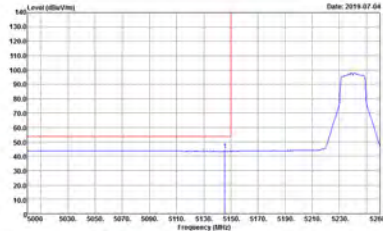

WIFI	Band 1 5150~5250MHz Band Edge @ 3m	
ANT	802.11n HT20 CH48 5240MHz - L	
2	Horizontal	Fundamental
Peak	 <p>Site : 03CH16-HY            Condition : PEAK_BE_74 3m 91200_1522 HORIZONTAL            RBW:1000.0000 Hz VSW:3000.0000 Hz SWT:Auto            Detector : Peak            Project : 940905-02</p>	 <p>Site : 03CH16-HY            Condition : PEAK(LINE) 3m 91200_1522 HORIZONTAL            RBW:1000.0000 Hz VSW:3000.0000 Hz SWT:Auto            Detector : Peak            Project : 940905-02</p>
Avg.	 <p>Site : 03CH16-HY            Condition : AVG_BE_54 3m 91200_1522 HORIZONTAL            RBW:1000.0000 Hz VSW:3000.0000 Hz SWT:Auto            Detector : Peak            Project : 940905-02</p>	Left blank



WIFI	Band 1 5150~5250MHz Band Edge @ 3m	
ANT	802.11n HT20 CH48 5240MHz - R	
2	Horizontal	Fundamental
Peak	<p>Site : 03CH16-HY Condition : PEAK_BE_74 3m 912GB_152Z HORIZONTAL RBW:3000.0000 Hz VSW:3000.0000 Hz SWT:Auto Detector : Peak Project : 940905-02</p>	Left blank
Avg.	<p>Site : 03CH16-HY Condition : AVIS_BE_54 3m 912GB_152Z HORIZONTAL RBW:3000.0000 Hz VSW:3000.0000 Hz SWT:Auto Detector : Peak Project : 940905-02</p>	Left blank



WIFI	Band 1 5150~5250MHz Band Edge @ 3m	
ANT	802.11n HT20 CH48 5240MHz - L	
2	Vertical	Fundamental
Peak	<p>Site : 03CH16-HY            Condition : PEAK_BE_74 3m 91200_1522 VERTICAL            RBW:1000.0000 Hz VSW:3000.0000 Hz SWT:Auto            Detector : Peak            Project : 940905-02</p>	<p>Site : 03CH16-HY            Condition : PEAK(LINE) 3m 91200_1522 VERTICAL            RBW:1000.0000 Hz VSW:3000.0000 Hz SWT:Auto            Detector : Peak            Project : 940905-02</p>
Avg.	<p>Site : 03CH16-HY            Condition : AVIS_BE_54 3m 91200_1522 VERTICAL            RBW:1000.0000 Hz VSW:3.0000 Hz SWT:Auto            Detector : Peak            Project : 940905-02</p>	Left blank



WIFI	Band 1 5150~5250MHz Band Edge @ 3m	
ANT	802.11n HT20 CH48 5240MHz - R	
2	Vertical	Fundamental
<p><b>Peak</b></p>	<p>Site : 03CH16-HY            Condition : PEAK_BE_74 3m 91200_152Z VERTICAL            RBW:3000.0000 Hz VBW:3000.0000 Hz SWT:Auto            Detector : Peak            Project : 940905-02</p>	<p>Left blank</p>
<p><b>Avg.</b></p>	<p>Site : 03CH16-HY            Condition : AVG_BE_54 3m 91200_152Z VERTICAL            RBW:3000.0000 Hz VBW:3000.0000 Hz SWT:Auto            Detector : Peak            Project : 940905-02</p>	<p>Left blank</p>

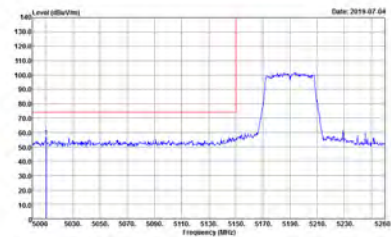
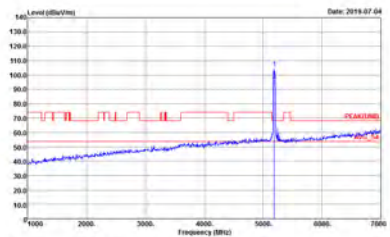
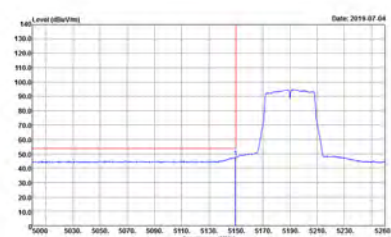

**Band 1 5150~5250MHz**  
**WIFI 802.11n HT40 (Band Edge @ 3m)**

WIFI	Band 1 5150~5250MHz Band Edge @ 3m	
ANT	802.11n HT40 CH38 5190MHz - L	
2	Horizontal	Fundamental
<b>Peak</b>	 <p>Site : 03CH16-HY            Condition : PEAK_BE_74 3m 91200_1522 HORIZONTAL            RBW:1000.0000 Hz VSW:3000.0000 Hz SWT:Auto            Detector : Peak            Project : 940905-02</p>	 <p>Site : 03CH16-HY            Condition : PEAK(FUND) 3m 91200_1522 HORIZONTAL            RBW:1000.0000 Hz VSW:3000.0000 Hz SWT:Auto            Detector : Peak            Project : 940905-02</p>
<b>Avg.</b>	 <p>Site : 03CH16-HY            Condition : AVG_BE_54 3m 91200_1522 HORIZONTAL            RBW:1000.0000 Hz VSW:10000 Hz SWT:Auto            Detector : Peak            Project : 940905-02</p>	Left blank



WIFI	Band 1 5150~5250MHz Band Edge @ 3m	
ANT	802.11n HT40 CH38 5190MHz - R	
2	Horizontal	Fundamental
Peak	<p>Site : 03CH16-HY Condition : PEAK_BE_74 3m 91200_1522 HORIZONTAL RBW:3000.0000 Hz VSW:3000.0000 Hz SWT:Auto Detector : Peak Project : 940905-02</p>	Left blank
Avg.	<p>Site : 03CH16-HY Condition : AVG_BE_54 3m 91200_1522 HORIZONTAL RBW:3000.0000 Hz VSW:3000.0000 Hz SWT:Auto Detector : Peak Project : 940905-02</p>	Left blank

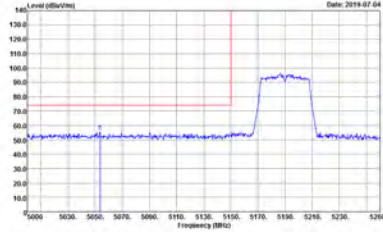
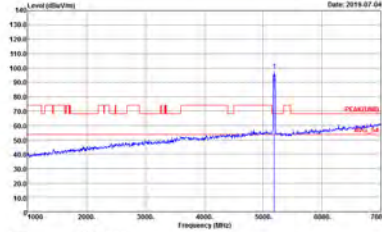
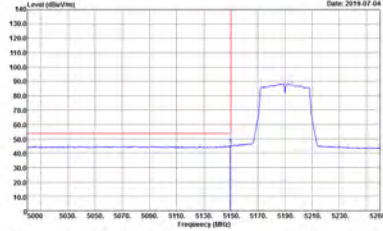

WIFI	Band 1 5150~5250MHz Band Edge @ 3m	
ANT	802.11n HT40 CH38 5190MHz - L	
2	Vertical	Fundamental
Peak	 <p>Site : 03CH16-HY            Condition : PEAK_BE_74 3m 91200_1522 VERTICAL            RBW:1000.0000 Hz VSW:3000.0000 Hz SWT:Auto            Detector : Peak            Project : 940905-02</p>	 <p>Site : 03CH16-HY            Condition : PEAK(LINE) 3m 91200_1522 VERTICAL            RBW:1000.0000 Hz VSW:3000.0000 Hz SWT:Auto            Detector : Peak            Project : 940905-02</p>
Avg.	 <p>Site : 03CH16-HY            Condition : AVG_BE_54 3m 91200_1522 VERTICAL            RBW:1000.0000 Hz VSW:10000Hz SWT:Auto            Detector : Peak            Project : 940905-02</p>	Left blank



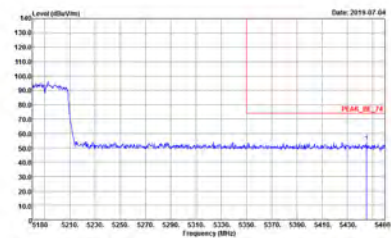
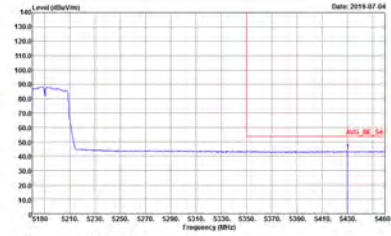

WIFI	Band 1 5150~5250MHz Band Edge @ 3m	
ANT	802.11n HT40 CH38 5190MHz - R	
2	Vertical	Fundamental
<p><b>Peak</b></p>	 <p>Site : 03CH16-HY            Condition : PEAK_BE_74 3m 91200_1522 VERTICAL            RBW:1000.0000Hz VSW:3000.0000Hz SWT:Auto            Detector : Peak            Project : 940905-02</p>	<p>Left blank</p>
<p><b>Avg.</b></p>	 <p>Site : 03CH16-HY            Condition : AVG_BE_54 3m 91200_1522 VERTICAL            RBW:1000.0000Hz VSW:10000Hz SWT:Auto            Detector : Peak            Project : 940905-02</p>	<p>Left blank</p>

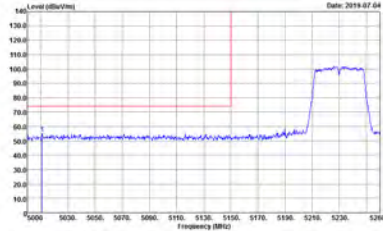
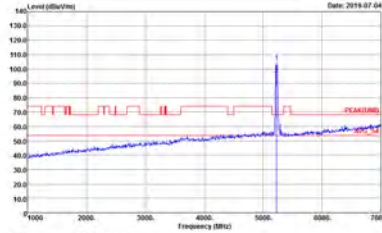
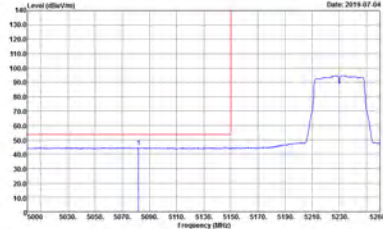

WIFI	Band 1 5150~5250MHz Band Edge @ 3m	
ANT	802.11n HT40 CH46 5230MHz - L	
2	Horizontal	Fundamental
Peak	 <p>Site : 03CH16-HY            Condition : PEAK_BE_74 3m 91200_1522 HORIZONTAL            RBW:1000.0000 Hz VSW:3000.0000 Hz SWT:Auto            Detector : Peak            Project : 940905-02</p>	 <p>Site : 03CH16-HY            Condition : PEAK(LINE) 3m 91200_1522 HORIZONTAL            RBW:1000.0000 Hz VSW:3000.0000 Hz SWT:Auto            Detector : Peak            Project : 940905-02</p>
Avg.	 <p>Site : 03CH16-HY            Condition : AVG_BE_54 3m 91200_1522 HORIZONTAL            RBW:1000.0000 Hz VSW:10000 Hz SWT:Auto            Detector : Peak            Project : 940905-02</p>	Left blank



WIFI	Band 1 5150~5250MHz Band Edge @ 3m	
ANT	802.11n HT40 CH46 5230MHz - R	
2	Horizontal	Fundamental
Peak	<p>Site : 03CH16-HY Condition : PEAK_BE_74 3m 91200_1522 HORIZONTAL RBW:3000.0000 Hz VSW:3000.0000 Hz SWT:Auto Detector : Peak Project : 940905-02</p>	Left blank
Avg.	<p>Site : 03CH16-HY Condition : AVG_BE_54 3m 91200_1522 HORIZONTAL RBW:3000.0000 Hz VSW:3000.0000 Hz SWT:Auto Detector : Peak Project : 940905-02</p>	Left blank

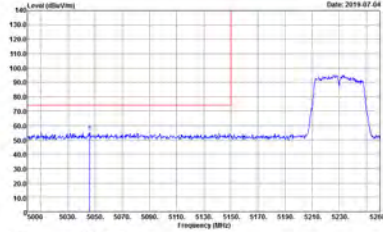
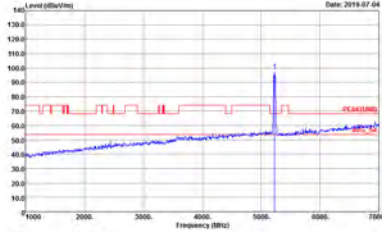
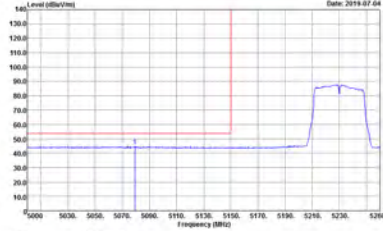

WIFI	Band 1 5150~5250MHz Band Edge @ 3m	
ANT	802.11n HT40 CH46 5230MHz - L	
2	Vertical	Fundamental
Peak	 <p>Site : 03CH16-HY            Condition : PEAK_BE_74 3m 91200_1522 VERTICAL            RBW:1000.0000Hz VSW:3000.0000Hz SWT:Auto            Detector : Peak            Project : 940905-02</p>	 <p>Site : 03CH16-HY            Condition : PEAK(LINE) 3m 91200_1522 VERTICAL            RBW:1000.0000Hz VSW:3000.0000Hz SWT:Auto            Detector : Peak            Project : 940905-02</p>
Avg.	 <p>Site : 03CH16-HY            Condition : AVIS_BE_54 3m 91200_1522 VERTICAL            RBW:1000.0000Hz VSW:10000Hz SWT:Auto            Detector : Peak            Project : 940905-02</p>	Left blank

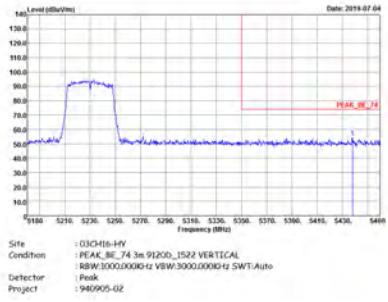
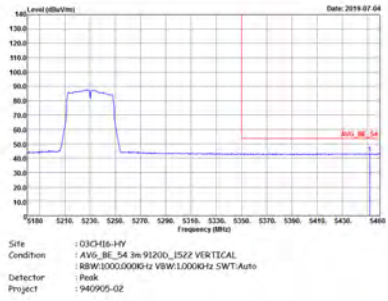

WIFI	Band 1 5150~5250MHz Band Edge @ 3m	
ANT	802.11n HT40 CH46 5230MHz - R	
2	Vertical	Fundamental
Peak		Left blank
Avg.		Left blank

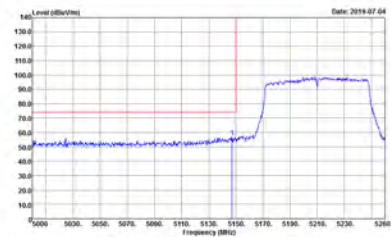
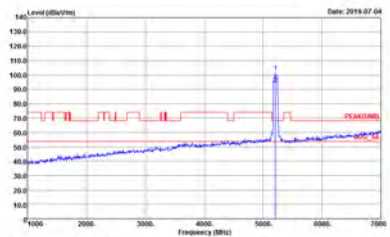
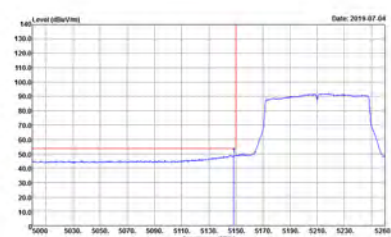

**Band 1 5150~5250MHz**  
**WIFI 802.11ac VHT80 (Band Edge @ 3m)**

WIFI	Band 1 5150~5250MHz Band Edge @ 3m	
ANT	802.11ac VHT80 CH42 5210MHz - L	
2	Horizontal	Fundamental
<b>Peak</b>	 <p>Site : 03CH6-HY            Condition : PFA4_86_74 3m 91200_1522 HORIZONTAL            RBW:1000.0000Hz VSW:3000.0000Hz SWT:Auto            Detector : Peak            Project : 940905-02</p>	 <p>Site : 03CH6-HY            Condition : PFA4(EN1) 3m 91200_1522 HORIZONTAL            RBW:1000.0000Hz VSW:3000.0000Hz SWT:Auto            Detector : Peak            Project : 940905-02</p>
<b>Avg.</b>	 <p>Site : 03CH6-HY            Condition : AVIS_BE_54 3m 91200_1522 HORIZONTAL            RBW:1000.0000Hz VSW:3.0000Hz SWT:Auto            Detector : Peak            Project : 940905-02</p>	Left blank



WIFI	Band 1 5150~5250MHz Band Edge @ 3m	
ANT	802.11ac VHT80 CH42 5210MHz - R	
2	Horizontal	Fundamental
Peak	<p>Site : 03CH16-HY Condition : PEAK_BE_74 3m 91200_1522 HORIZONTAL RBW:3000.000KHz VSW:3000.000Hz SWT:Auto Detector : Peak Project : 940905-02</p>	Left blank
Avg.	<p>Site : 03CH16-HY Condition : AVG_BE_54 3m 91200_1522 HORIZONTAL RBW:3000.000KHz VSW:3000.000Hz SWT:Auto Detector : Peak Project : 940905-02</p>	Left blank

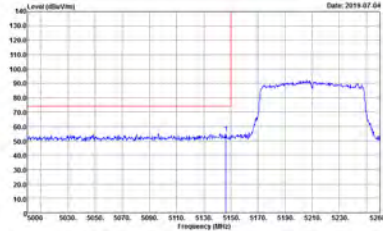
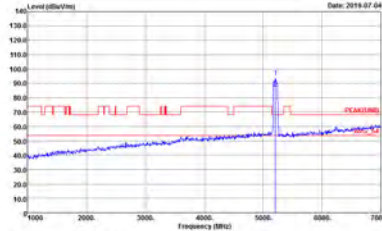
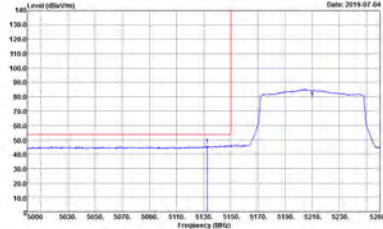

WIFI	Band 1 5150~5250MHz Band Edge @ 3m	
ANT	802.11ac VHT80 CH42 5210MHz - L	
2	Vertical	Fundamental
Peak	 <p>Site : 03CH16-HY            Condition : PEAK_BE_74 3m 91200_1522 VERTICAL            RBW:1000.0000 Hz VSW:3000.0000 Hz SWT:Auto            Detector : Peak            Project : 940905-02</p>	 <p>Site : 03CH16-HY            Condition : PEAK(LINE) 3m 91200_1522 VERTICAL            RBW:1000.0000 Hz VSW:3000.0000 Hz SWT:Auto            Detector : Peak            Project : 940905-02</p>
Avg.	 <p>Site : 03CH16-HY            Condition : AVG_BE_54 3m 91200_1522 VERTICAL            RBW:1000.0000 Hz VSW:3000.0000 Hz SWT:Auto            Detector : Peak            Project : 940905-02</p>	Left blank





WIFI	Band 1 5150~5250MHz Band Edge @ 3m	
ANT	802.11ac VHT80 CH42 5210MHz - R	
2	Vertical	Fundamental
Peak	<p>Site : 03CH16-HY Condition : PEAK_BE_74 3m 91200_1522 VERTICAL RBW:3000.0000Hz VSW:3000.0000Hz SWT:Auto Detector : Peak Project : 940905-02</p>	Left blank
Avg.	<p>Site : 03CH16-HY Condition : AVG_BE_54 3m 91200_1522 VERTICAL RBW:3000.0000Hz VSW:3000.0000Hz SWT:Auto Detector : Peak Project : 940905-02</p>	Left blank



**Band 1 - 5150~5250MHz**  
**WIFI 802.11a (Harmonic @ 3m)**

<b>WIFI</b>	<b>Band 1 5150~5250MHz Harmonic @ 3m</b>	
<b>ANT</b>	<b>802.11a CH36 5180MHz</b>	
<b>2</b>	<b>Horizontal</b>	<b>Vertical</b>
<b>Peak</b> <b>Avg.</b>	<p>Site : 03CH16-HV          Condition : PEAK(UNIT) 3m 91200_1522 HORIZONTAL          Detector : Peak          Project : 940905-02</p>	<p>Site : 03CH16-HV          Condition : PEAK(UNIT) 3m 91200_1522 VERTICAL          Detector : Peak          Project : 940905-02</p>



WIFI	Band 1 5150~5250MHz Harmonic @ 3m	
ANT	802.11a CH44 5220MHz	
2	Horizontal	Vertical
Peak Avg.	<p>Site : 03C316-14V Condition : PEAK(LINE) 3m 91200_1522 HORIZONTAL Detector : Peak Project : 1940905-02</p>	<p>Site : 03C316-14V Condition : PEAK(LINE) 3m 91200_1522 VERTICAL Detector : Peak Project : 1940905-02</p>

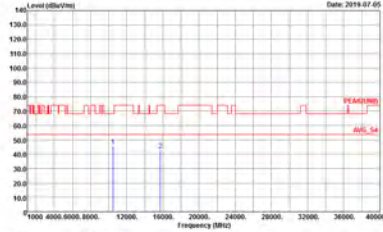
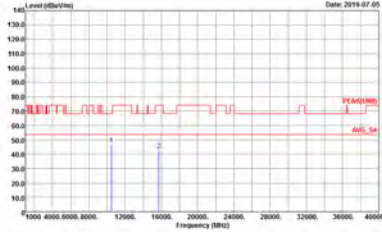

WIFI	Band 1 5150~5250MHz Harmonic @ 3m	
ANT	802.11a CH48 5240MHz	
2	Horizontal	Vertical
Peak Avg.	 <p>Site : 03C316-11V Condition : PEAK(LINE) 3m 91200_1522 HORIZONTAL Detector : Peak Project : 940905-02</p>	 <p>Site : 03C316-11V Condition : PEAK(LINE) 3m 91200_1522 VERTICAL Detector : Peak Project : 940905-02</p>



**Band 1 5150~5250MHz**  
**WIFI 802.11n HT20 (Harmonic @ 3m)**

<b>WIFI</b>	<b>Band 1 5150~5250MHz Harmonic @ 3m</b>	
<b>ANT</b>	<b>802.11n HT20 CH36 5180MHz</b>	
<b>2</b>	<b>Horizontal</b>	<b>Vertical</b>
<b>Peak</b> <b>Avg.</b>	<p>Site : 03CH16-HV          Condition : PEAK(LINE1) 3m 91200_1522 HORIZONTAL          Detector : Peak          Project : 940905-02</p>	<p>Site : 03CH16-HV          Condition : PEAK(LINE1) 3m 91200_1522 VERTICAL          Detector : Peak          Project : 940905-02</p>

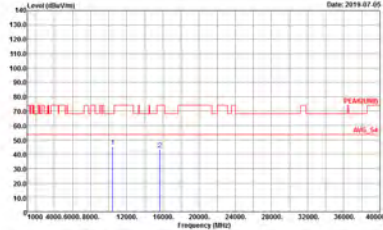
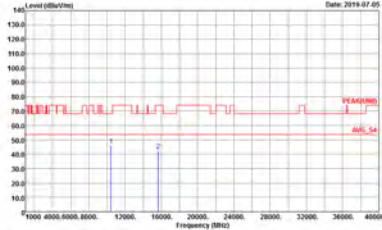

WIFI	Band 1 5150~5250MHz Harmonic @ 3m	
ANT	802.11n HT20 CH44 5220MHz	
2	Horizontal	Vertical
Peak Avg.	 <p>Site : 03C316-14V Condition : PEAK(LINE) 3m 91200_1522 HORIZONTAL Detector : Peak Project : 940905-02</p>	 <p>Site : 03C316-14V Condition : PEAK(LINE) 3m 91200_1522 VERTICAL Detector : Peak Project : 940905-02</p>

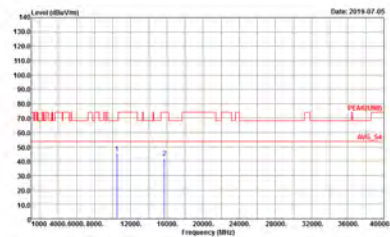
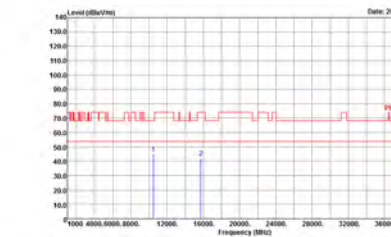

WIFI	Band 1 5150~5250MHz Harmonic @ 3m	
ANT	802.11n HT20 CH48 5240MHz	
2	Horizontal	Vertical
Peak Avg.	<div style="display: flex; justify-content: space-around;"> <div style="width: 45%;">  <p>Site : 03C316-14V Condition : PEAK(LINE) 3m 91200_1522 HORIZONTAL Detector : Peak Project : 940905-02</p> </div> <div style="width: 45%;">  <p>Site : 03C316-14V Condition : PEAK(LINE) 3m 91200_1522 VERTICAL Detector : Peak Project : 940905-02</p> </div> </div>	



**Band 1 5150~5250MHz**  
**WIFI 802.11n HT40 (Harmonic @ 3m)**

<b>WIFI</b>	<b>Band 1 5150~5250MHz Harmonic @ 3m</b>	
<b>ANT</b>	<b>802.11n HT40 CH38 5190MHz</b>	
<b>2</b>	<b>Horizontal</b>	<b>Vertical</b>
<b>Peak</b> <b>Avg.</b>	<p>Site : 03CH16-HV          Condition : PEAK(LINE1) 3m 91200_1522 HORIZONTAL          Detector : Peak          Project : 940905-02</p>	<p>Site : 03CH16-HV          Condition : PEAK(LINE1) 3m 91200_1522 VERTICAL          Detector : Peak          Project : 940905-02</p>



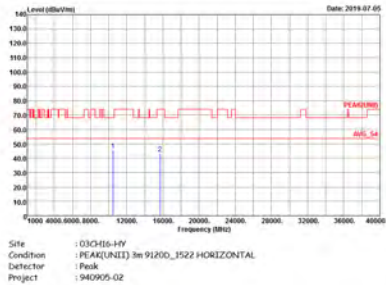
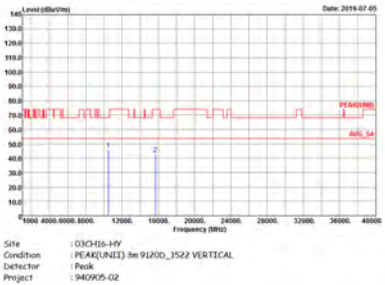

WIFI	Band 1 5150~5250MHz Harmonic @ 3m	
ANT	802.11n HT40 CH46 5230MHz	
2	Horizontal	Vertical
Peak Avg.		



**Band 1 5150~5250MHz**  
**WIFI 802.11ac VHT80 (Harmonic @ 3m)**

<b>WIFI</b>	<b>Band 1 5150~5250MHz Harmonic @ 3m</b>	
<b>ANT</b>	<b>802.11ac VHT80 CH42 5210MHz</b>	
<b>2</b>	<b>Horizontal</b>	<b>Vertical</b>
<b>Peak</b> <b>Avg.</b>	<p>Site : 03CH16-HV          Condition : PEAK(LINE) 3m 91200_1522 HORIZONTAL          Detector : Peak          Project : 940905-02</p>	<p>Site : 03CH16-HV          Condition : PEAK(LINE) 3m 91200_1522 VERTICAL          Detector : Peak          Project : 940905-02</p>



**Band 2 - 5250~5350MHz**  
**WIFI 802.11a (Band Edge @ 3m)**

WIFI	Band 2 5250~5350MHz Band Edge @ 3m	
ANT	802.11a CH52 5260MHz - L	
2	Horizontal	Fundamental
Peak	<p>Site : 03CH6-HY            Condition : PEAK_BE_74 3m 91200_1522 HORIZONTAL            RBW:1000.0000 Hz VSW:3000.0000 Hz SWT:Auto            Detector : Peak            Project : 940905-02</p>	<p>Site : 03CH6-HY            Condition : PEAK(FUND) 3m 91200_1522 HORIZONTAL            RBW:1000.0000 Hz VSW:3000.0000 Hz SWT:Auto            Detector : Peak            Project : 940905-02</p>
Avg.	<p>Site : 03CH6-HY            Condition : AVG_BE_54 3m 91200_1522 HORIZONTAL            RBW:1000.0000 Hz VSW:3000.0000 Hz SWT:Auto            Detector : Peak            Project : 940905-02</p>	Left blank

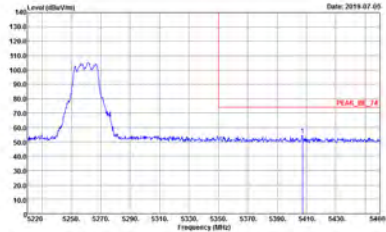
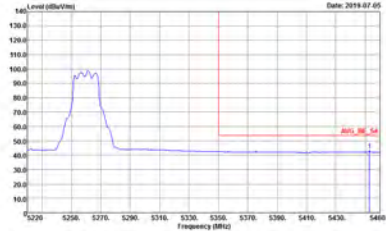

WIFI	Band 2 5250~5350MHz Band Edge @ 3m	
ANT	802.11a CH52 5260MHz - R	
2	Horizontal	Fundamental
<p><b>Peak</b></p>	 <p>Site : 03CH16-HY            Condition : PEAK_BE_74 3m 912GB_1522 HORIZONTAL            RBW:1000.0000 Hz VBW:3000.0000 Hz SWT:Auto            Detector : Peak            Project : 940905-02</p>	<p>Left blank</p>
<p><b>Avg.</b></p>	 <p>Site : 03CH16-HY            Condition : AVG_BE_54 3m 912GB_1522 HORIZONTAL            RBW:1000.0000 Hz VBW:3000.0000 Hz SWT:Auto            Detector : Peak            Project : 940905-02</p>	<p>Left blank</p>



WIFI	Band 2 5250~5350MHz Band Edge @ 3m	
ANT	802.11a CH52 5260MHz - L	
2	Vertical	Fundamental
Peak	<p>Site : 03CH16-HY            Condition : PEAK_BE_74 3m 91200_1522 VERTICAL            RBW:1000.0000 Hz VSW:3000.0000 Hz SWT:Auto            Detector : Peak            Project : 940905-02</p>	<p>Site : 03CH16-HY            Condition : PEAK(LINE) 3m 91200_1522 VERTICAL            RBW:1000.0000 Hz VSW:3000.0000 Hz SWT:Auto            Detector : Peak            Project : 940905-02</p>
Avg.	<p>Site : 03CH16-HY            Condition : AVG_BE_54 3m 91200_1522 VERTICAL            RBW:1000.0000 Hz VSW:3000.0000 Hz SWT:Auto            Detector : Peak            Project : 940905-02</p>	Left blank

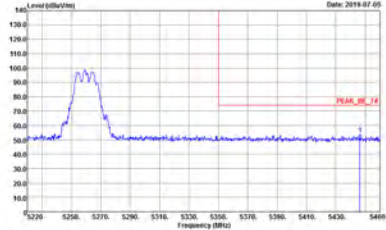
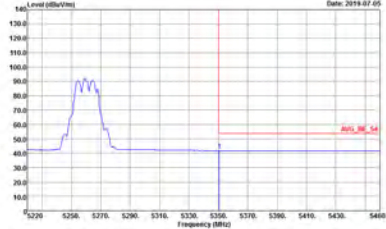

WIFI	Band 2 5250~5350MHz Band Edge @ 3m	
ANT	802.11a CH52 5260MHz - R	
2	Vertical	Fundamental
Peak	 <p>Site : 03CH16-HY            Condition : PEAK_BE_74 3m 912GB_152Z VERTICAL            RBW:1000.0000Hz VBW:3000.0000Hz SWT:Auto            Detector : Peak            Project : 940905-02</p>	Left blank
Avg.	 <p>Site : 03CH16-HY            Condition : AVG_BE_54 3m 912GB_152Z VERTICAL            RBW:1000.0000Hz VBW:3000.0000Hz SWT:Auto            Detector : Peak            Project : 940905-02</p>	Left blank

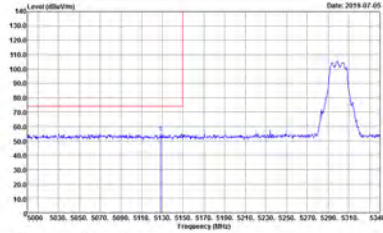
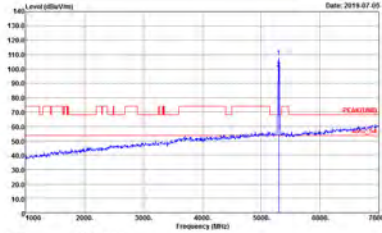
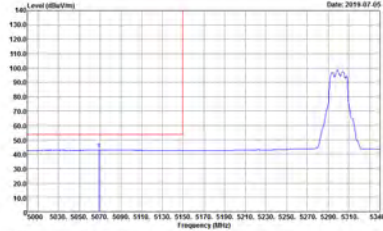

WIFI	Band 2 5250~5350MHz Band Edge @ 3m	
ANT	802.11a CH60 5300MHz - L	
2	Horizontal	Fundamental
Peak	 <p>Site : 03CH16-HY            Condition : PEAK_BE_74 3m 91200_1522 HORIZONTAL            RBW:1000.0000 Hz VSW:3000.0000 Hz SWT:Auto            Detector : Peak            Project : 940905-02</p>	 <p>Site : 03CH16-HY            Condition : PEAK(LINE) 3m 91200_1522 HORIZONTAL            RBW:1000.0000 Hz VSW:3000.0000 Hz SWT:Auto            Detector : Peak            Project : 940905-02</p>
Avg.	 <p>Site : 03CH16-HY            Condition : AVG_BE_54 3m 91200_1522 HORIZONTAL            RBW:1000.0000 Hz VSW:3000.0000 Hz SWT:Auto            Detector : Peak            Project : 940905-02</p>	Left blank

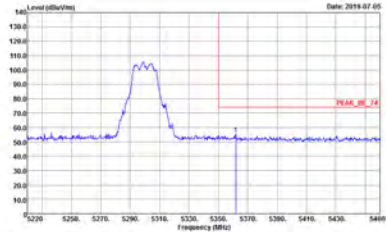
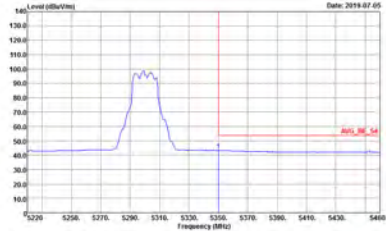

WIFI	Band 2 5250~5350MHz Band Edge @ 3m	
ANT	802.11a CH60 5300MHz - R	
2	Horizontal	Fundamental
Peak	 <p>Site : 03CH16-HY Condition : PEAK_BE_74 3m 91200_1522 HORIZONTAL RBW:1000.0000 Hz VBW:3000.0000 Hz SWT:Auto Detector : Peak Project : 940905-02</p>	Left blank
Avg.	 <p>Site : 03CH16-HY Condition : AVG_BE_54 3m 91200_1522 HORIZONTAL RBW:1000.0000 Hz VBW:3000.0000 Hz SWT:Auto Detector : Peak Project : 940905-02</p>	Left blank



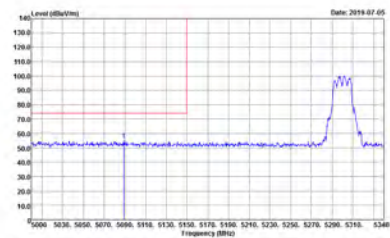
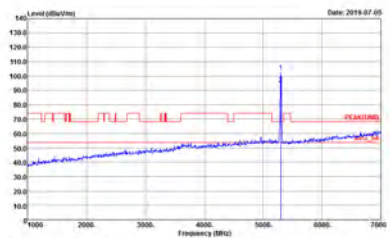
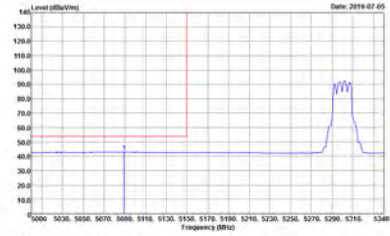

WIFI	Band 2 5250~5350MHz Band Edge @ 3m	
ANT	802.11a CH60 5300MHz - L	
2	Vertical	Fundamental
Peak	 <p>Site : 03CH16-HY            Condition : PEAK_BE_74 3m 91200_1522 VERTICAL            RBW:1000.0000 Hz VSW:3000.0000 Hz SWT:Auto            Detector : Peak            Project : 940905-02</p>	 <p>Site : 03CH16-HY            Condition : PEAK(LINE) 3m 91200_1522 VERTICAL            RBW:1000.0000 Hz VSW:3000.0000 Hz SWT:Auto            Detector : Peak            Project : 940905-02</p>
Avg.	 <p>Site : 03CH16-HY            Condition : AVG_BE_54 3m 91200_1522 VERTICAL            RBW:1000.0000 Hz VSW:3000.0000 Hz SWT:Auto            Detector : Peak            Project : 940905-02</p>	Left blank

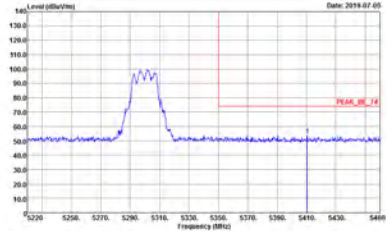
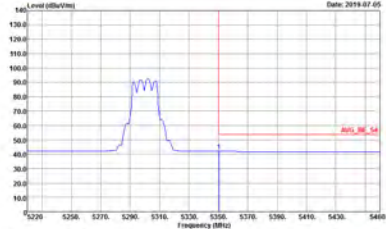

WIFI	Band 2 5250~5350MHz Band Edge @ 3m	
ANT	802.11a CH60 5300MHz - R	
2	Vertical	Fundamental
Peak	 <p>Site : 03CH16-HY            Condition : PEAK_BE_74 3m 91200_1522 VERTICAL            RBW:1000.0000 Hz VBW:3000.0000 Hz SWT:Auto            Detector : Peak            Project : 940905-02</p>	Left blank
Avg.	 <p>Site : 03CH16-HY            Condition : AVG_BE_54 3m 91200_1522 VERTICAL            RBW:1000.0000 Hz VBW:3000.0000 Hz SWT:Auto            Detector : Peak            Project : 940905-02</p>	Left blank

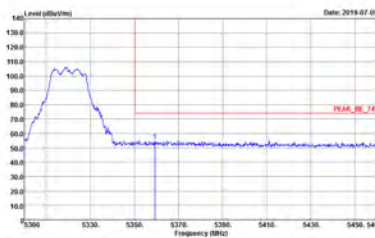
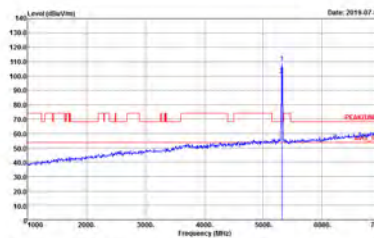
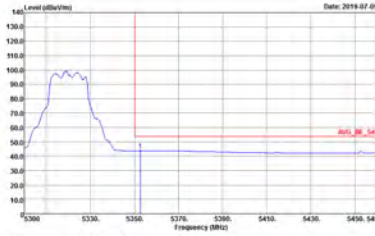

WIFI	Band 2 5250~5350MHz Band Edge @ 3m	
ANT	802.11a CH64 5320MHz	
2	Horizontal	Fundamental
Peak	 <p>Site : 03CH16-HY            Condition : PEAK_BE_74 3m 91200_1522 HORIZONTAL            RBW:1000.0000 Hz VSW:3000.0000 Hz SWT:Auto            Detector : Peak            Project : 940905-02</p>	 <p>Site : 03CH16-HY            Condition : PEAK(LINE) 3m 91200_1522 HORIZONTAL            RBW:1000.0000 Hz VSW:3000.0000 Hz SWT:Auto            Detector : Peak            Project : 940905-02</p>
Avg.	 <p>Site : 03CH16-HY            Condition : AVG_BE_54 3m 91200_1522 HORIZONTAL            RBW:1000.0000 Hz VSW:0.0000 Hz SWT:Auto            Detector : Peak            Project : 940905-02</p>	Left blank



WIFI	Band 2 5250~5350MHz Band Edge @ 3m	
ANT	802.11a CH64 5320MHz	
2	Vertical	Fundamental
Peak	<p>Site : 03CH16-HY            Condition : PEAK_BE_74 3m 91200_1522 VERTICAL            RBW:1000.0000 Hz VSW:3000.0000 Hz SWT:Auto            Detector : Peak            Project : 940905-02</p>	<p>Site : 03CH16-HY            Condition : PEAK(LINE) 3m 91200_1522 VERTICAL            RBW:1000.0000 Hz VSW:3000.0000 Hz SWT:Auto            Detector : Peak            Project : 940905-02</p>
Avg.	<p>Site : 03CH16-HY            Condition : AVG_BE_54 3m 91200_1522 VERTICAL            RBW:1000.0000 Hz VSW:3000.0000 Hz SWT:Auto            Detector : Peak            Project : 940905-02</p>	Left blank

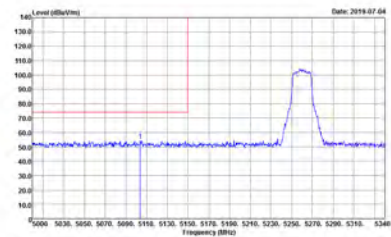
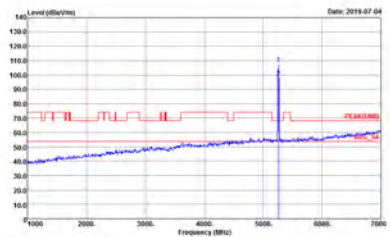
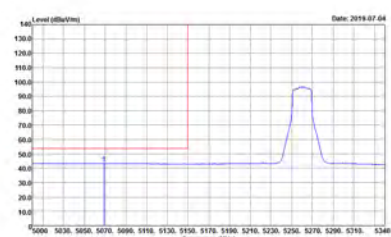

**Band 2 5250~5350MHz**  
**WIFI 802.11n HT20 (Band Edge @ 3m)**

WIFI	Band 2 5250~5350MHz Band Edge @ 3m	
ANT	802.11n HT20 CH52 5260MHz - L	
2	Horizontal	Fundamental
<b>Peak</b>	 <p>Site : 03CH6-HY            Condition : PEAK_BE_74 3m 91200_1522 HORIZONTAL            RBW:1000.0000 Hz VSW:3000.0000 Hz SWT:Auto            Detector : Peak            Project : 940905-02</p>	 <p>Site : 03CH6-HY            Condition : PEAK(FUN) 3m 91200_1522 HORIZONTAL            RBW:1000.0000 Hz VSW:3000.0000 Hz SWT:Auto            Detector : Peak            Project : 940905-02</p>
<b>Avg.</b>	 <p>Site : 03CH6-HY            Condition : AVG_BE_54 3m 91200_1522 HORIZONTAL            RBW:1000.0000 Hz VSW:3000.0000 Hz SWT:Auto            Detector : Peak            Project : 940905-02</p>	Left blank

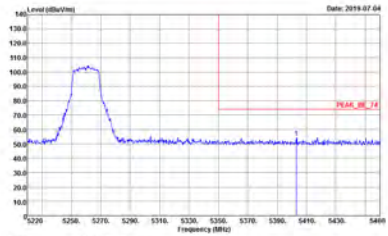
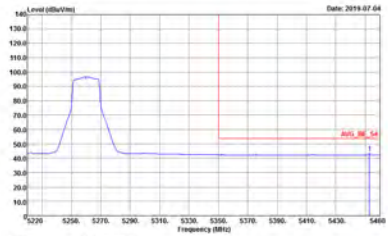

WIFI	Band 2 5250~5350MHz Band Edge @ 3m	
ANT	802.11n HT20 CH52 5260MHz - R	
2	Horizontal	Fundamental
Peak		Left blank
Avg.		Left blank

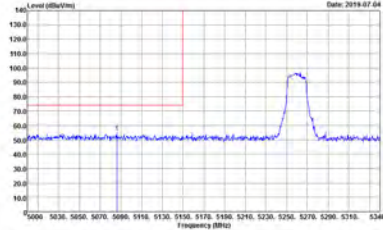
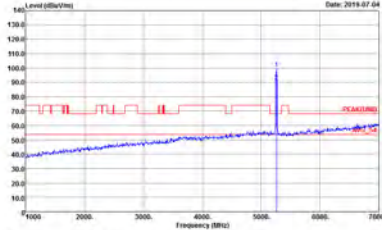
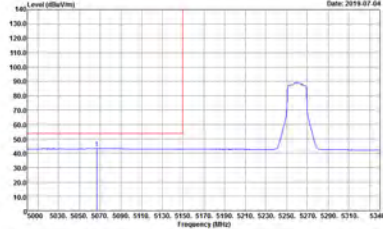

WIFI	Band 2 5250~5350MHz Band Edge @ 3m	
ANT	802.11n HT20 CH52 5260MHz - L	
2	Vertical	Fundamental
Peak	 <p>Site : 03CH16-HY            Condition : PEAK_BE_74 3m 912GB_1522 VERTICAL            RBW:1000.0000 Hz VSW:3000.0000 Hz SWT:Auto            Detector : Peak            Project : 940905-02</p>	 <p>Site : 03CH16-HY            Condition : PEAK(LINE) 3m 912GB_1522 VERTICAL            RBW:1000.0000 Hz VSW:3000.0000 Hz SWT:Auto            Detector : Peak            Project : 940905-02</p>
Avg.	 <p>Site : 03CH16-HY            Condition : AVG_BE_54 3m 912GB_1522 VERTICAL            RBW:1000.0000 Hz VSW:3000.0000 Hz SWT:Auto            Detector : Peak            Project : 940905-02</p>	Left blank



WIFI	Band 2 5250~5350MHz Band Edge @ 3m	
ANT	802.11n HT20 CH52 5260MHz - R	
2	Vertical	Fundamental
Peak		Left blank
Avg.		Left blank



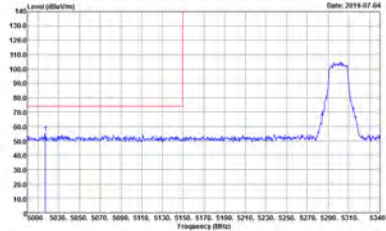
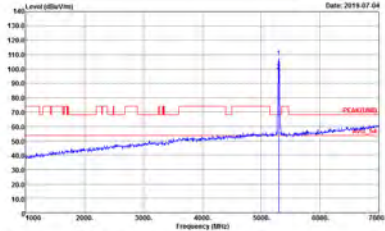
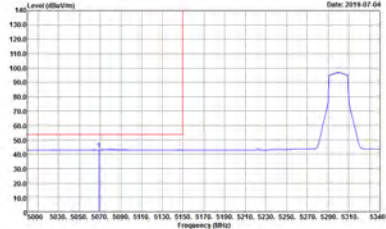

WIFI	Band 2 5250~5350MHz Band Edge @ 3m	
ANT	802.11n HT20 CH60 5300MHz - L	
2	Horizontal	Fundamental
Peak	 <p>Site : 03CH16-HY            Condition : PEAK_BE_74 3m 91200_1522 HORIZONTAL            RBW:1000.0000 Hz VSW:3000.0000 Hz SWT:Auto            Detector : Peak            Project : 940905-02</p>	 <p>Site : 03CH16-HY            Condition : PEAK(LINE) 3m 91200_1522 HORIZONTAL            RBW:1000.0000 Hz VSW:3000.0000 Hz SWT:Auto            Detector : Peak            Project : 940905-02</p>
Avg.	 <p>Site : 03CH16-HY            Condition : AVG_BE_54 3m 91200_1522 HORIZONTAL            RBW:1000.0000 Hz VSW:3000.0000 Hz SWT:Auto            Detector : Peak            Project : 940905-02</p>	Left blank



WIFI	Band 2 5250~5350MHz Band Edge @ 3m	
ANT	802.11n HT20 CH60 5300MHz - R	
2	Horizontal	Vertical
<p><b>Peak</b></p>		<p>Left blank</p>
<p><b>Avg.</b></p>		<p>Left blank</p>



WIFI	Band 2 5250~5350MHz Band Edge @ 3m	
ANT	802.11n HT20 CH60 5300MHz - L	
2	Vertical	Fundamental
Peak	<p>Site : 03CH16-HY            Condition : PEAK_BE_74 3m 91200_1522 VERTICAL            RBW:1000.0000 Hz VSW:3000.0000 Hz SWT:Auto            Detector : Peak            Project : 940905-02</p>	<p>Site : 03CH16-HY            Condition : PEAK(LINE) 3m 91200_1522 VERTICAL            RBW:1000.0000 Hz VSW:3000.0000 Hz SWT:Auto            Detector : Peak            Project : 940905-02</p>
Avg.	<p>Site : 03CH16-HY            Condition : AVG_BE_54 3m 91200_1522 VERTICAL            RBW:1000.0000 Hz VSW:3000.0000 Hz SWT:Auto            Detector : Peak            Project : 940905-02</p>	Left blank



WIFI	Band 2 5250~5350MHz Band Edge @ 3m	
ANT	802.11n HT20 CH60 5300MHz - R	
2	Vertical	Fundamental
Peak	<p>Site : 03CH16-HY Condition : PEAK_BE_74 3m 912GB_152Z VERTICAL RBW:3000.0000 Hz VBW:3000.0000 Hz SWT:Auto Detector : Peak Project : 940905-02</p>	Left blank
Avg.	<p>Site : 03CH16-HY Condition : AVG_BE_54 3m 912GB_152Z VERTICAL RBW:3000.0000 Hz VBW:3000.0000 Hz SWT:Auto Detector : Peak Project : 940905-02</p>	Left blank

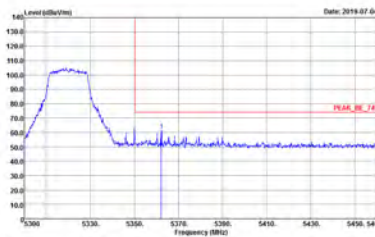
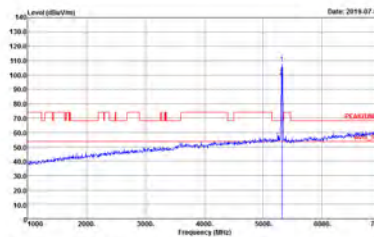
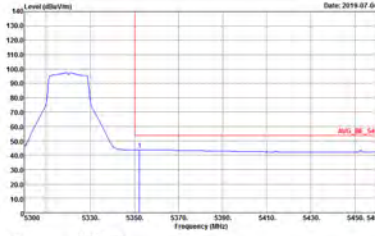

WIFI	Band 2 5250~5350MHz Band Edge @ 3m	
ANT	802.11n HT20 CH64 5320MHz	
2	Horizontal	Fundamental
Peak	 <p>Site : 03CH16-HY            Condition : PEAK_BE_74 3m 91200_1522 HORIZONTAL            RBW:1000.0000 Hz VSW:3000.0000 Hz SWT:Auto            Detector : Peak            Project : 940905-02</p>	 <p>Site : 03CH16-HY            Condition : PEAK(LINE) 3m 91200_1522 HORIZONTAL            RBW:1000.0000 Hz VSW:3000.0000 Hz SWT:Auto            Detector : Peak            Project : 940905-02</p>
Avg.	 <p>Site : 03CH16-HY            Condition : AVG_BE_54 3m 91200_1522 HORIZONTAL            RBW:1000.0000 Hz VSW:0.0000 Hz SWT:Auto            Detector : Peak            Project : 940905-02</p>	Left blank



WIFI	Band 2 5250~5350MHz Band Edge @ 3m	
ANT	802.11n HT20 CH64 5320MHz	
2	Vertical	Fundamental
Peak	<p>Site : 03CH16-HY            Condition : PEAK_BE_74 3m 91200_1522 VERTICAL            RBW:1000.0000 Hz VSW:3000.0000 Hz SWT:Auto            Detector : Peak            Project : 940905-02</p>	<p>Site : 03CH16-HY            Condition : PEAK(LINE) 3m 91200_1522 VERTICAL            RBW:1000.0000 Hz VSW:3000.0000 Hz SWT:Auto            Detector : Peak            Project : 940905-02</p>
Avg.	<p>Site : 03CH16-HY            Condition : AVG_BE_54 3m 91200_1522 VERTICAL            RBW:1000.0000 Hz VSW:3000.0000 Hz SWT:Auto            Detector : Peak            Project : 940905-02</p>	Left blank

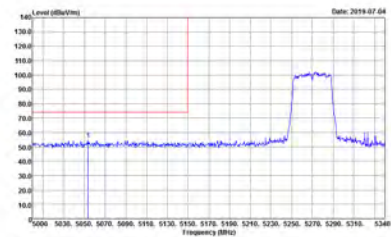
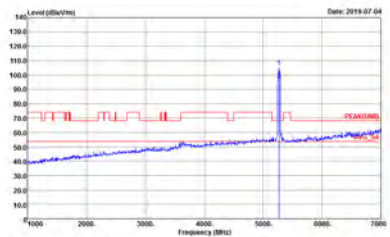
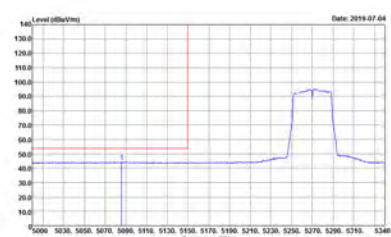

**Band 2 5250~5350MHz**  
**WIFI 802.11n HT40 (Band Edge @ 3m)**

WIFI	Band 2 5250~5350MHz Band Edge @ 3m	
ANT	802.11n HT40 CH54 5270 MHz - L	
2	Horizontal	Fundamental
<b>Peak</b>	 <p>Site : 03CH16-HY            Condition : PEAK_BE_74 3m 91200_1522 HORIZONTAL            RBW:1000.0000Hz VSW:3000.0000Hz SWT:Auto            Detector : Peak            Project : 940905-02</p>	 <p>Site : 03CH16-HY            Condition : PEAK(FUND) 3m 91200_1522 HORIZONTAL            RBW:1000.0000Hz VSW:3000.0000Hz SWT:Auto            Detector : Peak            Project : 940905-02</p>
<b>Avg.</b>	 <p>Site : 03CH16-HY            Condition : AVG_BE_54 3m 91200_1522 HORIZONTAL            RBW:1000.0000Hz VSW:1.0000Hz SWT:Auto            Detector : Peak            Project : 940905-02</p>	Left blank



WIFI	Band 2 5250~5350MHz Band Edge @ 3m	
ANT	802.11n HT40 CH54 5270 MHz - R	
2	Horizontal	Fundamental
Peak	<p>Site : 03CH16-HY Condition : PEAK_BE_74 3m 91200_1522 HORIZONTAL RBW:1000.0000 Hz VBW:3000.0000 Hz SWT:Auto Detector : Peak Project : 940905-02</p>	Left blank
Avg.	<p>Site : 03CH16-HY Condition : AVG_BE_54 3m 91200_1522 HORIZONTAL RBW:1000.0000 Hz VBW:10000Hz SWT:Auto Detector : Peak Project : 940905-02</p>	Left blank



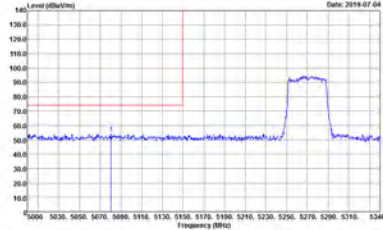
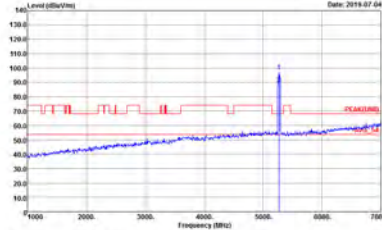
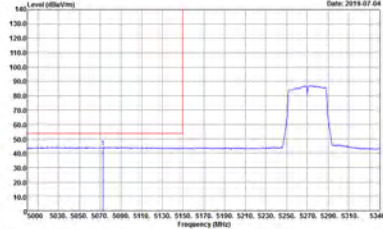

WIFI	Band 2 5250~5350MHz Band Edge @ 3m	
ANT	802.11n HT40 CH54 5270 MHz - L	
2	Vertical	Vertical
Peak	 <p>Site : 03CH16-HY            Condition : PEAK_BE_74 3m 91200_1522 VERTICAL            RBW:1000.0000 Hz VSW:3000.0000 Hz SWT:Auto            Detector : Peak            Project : 940905-02</p>	 <p>Site : 03CH16-HY            Condition : PEAK(LINE) 3m 91200_1522 VERTICAL            RBW:1000.0000 Hz VSW:3000.0000 Hz SWT:Auto            Detector : Peak            Project : 940905-02</p>
Avg.	 <p>Site : 03CH16-HY            Condition : AVG_BE_54 3m 91200_1522 VERTICAL            RBW:1000.0000 Hz VSW:10000 Hz SWT:Auto            Detector : Peak            Project : 940905-02</p>	Left blank



WIFI	Band 2 5250~5350MHz Band Edge @ 3m	
ANT	802.11n HT40 CH54 5270 MHz - R	
2	Vertical	Vertical
<p><b>Peak</b></p>		<p>Left blank</p>
<p><b>Avg.</b></p>		<p>Left blank</p>



WIFI	Band 2 5250~5350MHz Band Edge @ 3m	
ANT	802.11n HT40 CH62 5310 MHz - L	
2	Horizontal	Fundamental
Peak	<p>Site : 03CH16-HY            Condition : PEAK_BE_74 3m 91200_1522 HORIZONTAL            RBW:1000.0000 Hz VSW:3000.0000 Hz SWT:Auto            Detector : Peak            Project : 940905-02</p>	<p>Site : 03CH16-HY            Condition : PEAK(LINE) 3m 91200_1522 HORIZONTAL            RBW:1000.0000 Hz VSW:3000.0000 Hz SWT:Auto            Detector : Peak            Project : 940905-02</p>
Avg.	<p>Site : 03CH16-HY            Condition : AVG_BE_54 3m 91200_1522 HORIZONTAL            RBW:1000.0000 Hz VSW:1.0000 Hz SWT:Auto            Detector : Peak            Project : 940905-02</p>	Left blank

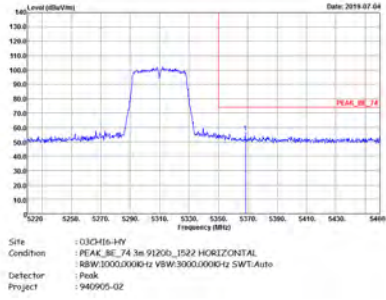
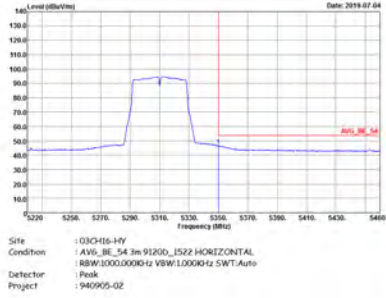

WIFI	Band 2 5250~5350MHz Band Edge @ 3m	
ANT	802.11n HT40 CH62 5310 MHz - R	
2	Horizontal	Fundamental
Peak		Left blank
Avg.		Left blank

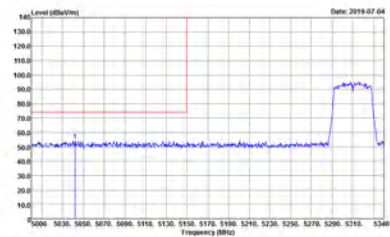
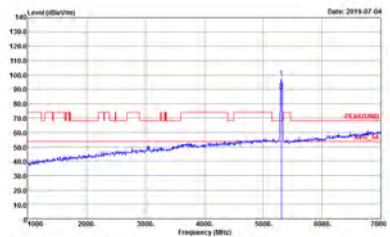
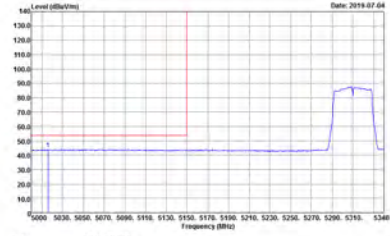

WIFI	Band 2 5250~5350MHz Band Edge @ 3m	
ANT	802.11n HT40 CH62 5310 MHz - L	
2	Vertical	Fundamental
Peak	 <p>Site : 03CH16-HY            Condition : PEAK_BE_74 3m 91200_1522 VERTICAL            RBW:1000.0000 Hz VSW:3000.0000 Hz SWT:Auto            Detector : Peak            Project : 940905-02</p>	 <p>Site : 03CH16-HY            Condition : PEAK(LINE) 3m 91200_1522 VERTICAL            RBW:1000.0000 Hz VSW:3000.0000 Hz SWT:Auto            Detector : Peak            Project : 940905-02</p>
Avg.	 <p>Site : 03CH16-HY            Condition : AVG_BE_54 3m 91200_1522 VERTICAL            RBW:1000.0000 Hz VSW:10000 Hz SWT:Auto            Detector : Peak            Project : 940905-02</p>	Left blank

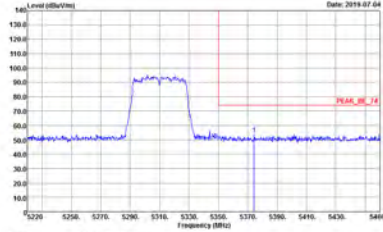
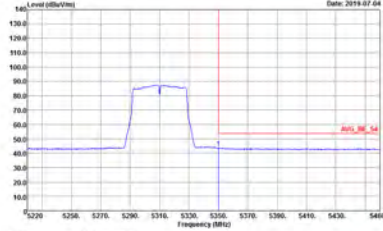

WIFI	Band 2 5250~5350MHz Band Edge @ 3m	
ANT	802.11n HT40 CH62 5310 MHz - R	
2	Vertical	Fundamental
Peak	 <p>Site : 03CH16-HY            Condition : PEAK_BE_74 3m 912GB_1522 VERTICAL            RBW:3000.0000 Hz VBW:3000.0000 Hz SWT:Auto            Detector : Peak            Project : 940905-02</p>	Left blank
Avg.	 <p>Site : 03CH16-HY            Condition : AVG_BE_54 3m 912GB_1522 VERTICAL            RBW:3000.0000 Hz VBW:3000.0000 Hz SWT:Auto            Detector : Peak            Project : 940905-02</p>	Left blank

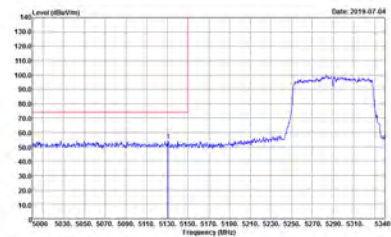
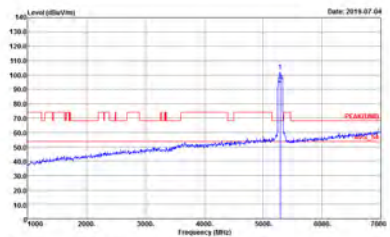
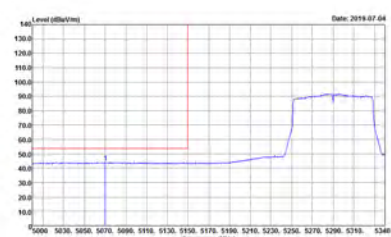

**Band 2 5250~5350MHz**  
**WIFI 802.11ac VHT80 (Band Edge @ 3m)**

WIFI	Band 2 5250~5350MHz Band Edge @ 3m	
ANT	802.11ac VHT80 CH58 5290MHz - L	
2	Horizontal	Fundamental
<b>Peak</b>	 <p>Site : 03CH6-HY            Condition : PEAK_BE_74 3m 91200_1522 HORIZONTAL            RBW:1000.0000Hz VSW:3000.0000Hz SWT:Auto            Detector : Peak            Project : 940905-02</p>	 <p>Site : 03CH6-HY            Condition : PEAK(FUND) 3m 91200_1522 HORIZONTAL            RBW:1000.0000Hz VSW:3000.0000Hz SWT:Auto            Detector : Peak            Project : 940905-02</p>
<b>Avg.</b>	 <p>Site : 03CH6-HY            Condition : AVG_BE_54 3m 91200_1522 HORIZONTAL            RBW:1000.0000Hz VSW:3.0000Hz SWT:Auto            Detector : Peak            Project : 940905-02</p>	Left blank

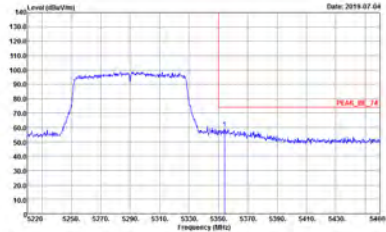
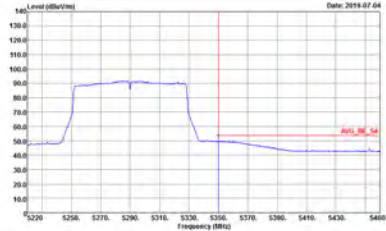

WIFI	Band 2 5250~5350MHz Band Edge @ 3m	
ANT	802.11ac VHT80 CH58 5290MHz - R	
2	Horizontal	Fundamental
<p><b>Peak</b></p>	 <p>Site : 03CH16-HY            Condition : PEAK_BE_74 3m 91200_1522 HORIZONTAL            RBW:3000.0000 Hz VSW:3000.0000 Hz SWT:Auto            Detector : Peak            Project : 940905-02</p>	<p>Left blank</p>
<p><b>Avg.</b></p>	 <p>Site : 03CH16-HY            Condition : AVG_BE_54 3m 91200_1522 HORIZONTAL            RBW:3000.0000 Hz VSW:3.0000 Hz SWT:Auto            Detector : Peak            Project : 940905-02</p>	<p>Left blank</p>





WIFI	Band 2 5250~5350MHz Band Edge @ 3m	
ANT	802.11ac VHT80 CH58 5290MHz - L	
2	Vertical	Fundamental
Peak	<p>Site : 03CH16-HY            Condition : PEAK_BE_74 3m 91200_1522 VERTICAL            RBW:1000.0000Hz VSW:3000.0000Hz SWT:Auto            Detector : Peak            Project : 940905-02</p>	<p>Site : 03CH16-HY            Condition : PEAK(LINE) 3m 91200_1522 VERTICAL            RBW:1000.0000Hz VSW:3000.0000Hz SWT:Auto            Detector : Peak            Project : 940905-02</p>
Avg.	<p>Site : 03CH16-HY            Condition : AVG_BE_54 3m 91200_1522 VERTICAL            RBW:1000.0000Hz VSW:3000.0000Hz SWT:Auto            Detector : Peak            Project : 940905-02</p>	Left blank



WIFI	Band 2 5250~5350MHz Band Edge @ 3m	
ANT	802.11ac VHT80 CH58 5290MHz - R	
2	Vertical	Fundamental
<p><b>Peak</b></p>		<p>Left blank</p>
<p><b>Avg.</b></p>		<p>Left blank</p>



**Band 2 - 5250~5350MHz**  
**WIFI 802.11a (Harmonic @ 3m)**

WIFI	Band 2 5250~5350MHz Harmonic @ 3m	
ANT	802.11a CH52 5260MHz	
2	<b>Horizontal</b>	<b>Vertical</b>
Peak Avg.	<p>Site : 03CH16-HV          Condition : PEAK(LINE) 3m 91200_1522 HORIZONTAL          Detector : Peak          Project : 940905-02</p>	<p>Site : 03CH16-HV          Condition : PEAK(LINE) 3m 91200_1522 VERTICAL          Detector : Peak          Project : 940905-02</p>



WIFI	Band 2 5250~5350MHz Harmonic @ 3m	
ANT	802.11a CH60 5300MHz	
2	Horizontal	Vertical
Peak Avg.	<p>Site : 03C116-11V Condition : PEAK(LINE) 3m 91200_1522 HORIZONTAL Detector : Peak Project : 940905-02</p>	<p>Site : 03C116-11V Condition : PEAK(LINE) 3m 91200_1522 VERTICAL Detector : Peak Project : 940905-02</p>

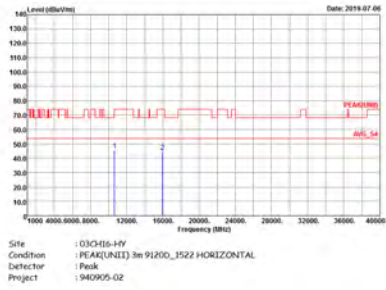
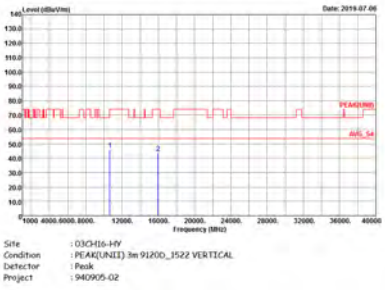

WIFI	Band 2 5250~5350MHz Harmonic @ 3m	
ANT	802.11a CH64 5320MHz	
2	Horizontal	Vertical
Peak Avg.	 <p>Site : 03C116-11V Condition : PEAK(LINE) 3m 91200_1522 HORIZONTAL Detector : Peak Project : 1940905-02</p>	 <p>Site : 03C116-11V Condition : PEAK(LINE) 3m 91200_1522 VERTICAL Detector : Peak Project : 1940905-02</p>



**Band 2 5250~5350MHz**  
**WIFI 802.11n HT20 (Harmonic @ 3m)**

<b>WIFI</b>	<b>Band 2 5250~5350MHz Harmonic @ 3m</b>	
<b>ANT</b>	<b>802.11n HT20 CH52 5260MHz</b>	
<b>2</b>	<b>Horizontal</b>	<b>Vertical</b>
<b>Peak</b> <b>Avg.</b>		

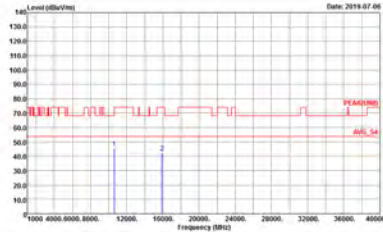
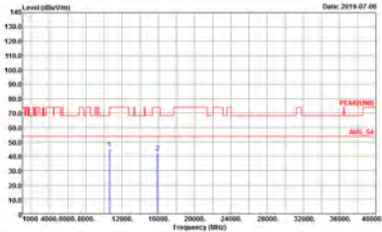

WIFI	Band 2 5250~5350MHz Harmonic @ 3m	
ANT	802.11n HT20 CH60 5300MHz	
2	Horizontal	Vertical
Peak Avg.	 <p>Site : 03C316-14V Condition : PEAK(LINE) 3m 91200_1522 HORIZONTAL Detector : Peak Project : 940905-02</p>	 <p>Site : 03C316-14V Condition : PEAK(LINE) 3m 91200_1522 VERTICAL Detector : Peak Project : 940905-02</p>

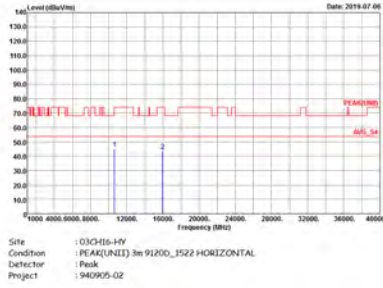
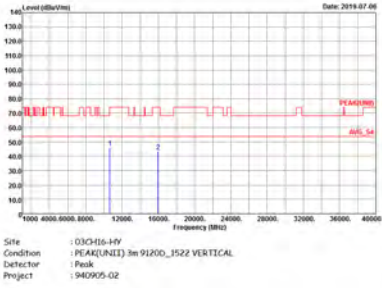

WIFI	Band 2 5250~5350MHz Harmonic @ 3m	
ANT	802.11n HT20 CH64 5320MHz	
2	Horizontal	Vertical
Peak Avg.		





**Band 2 5250~5350MHz**  
**WIFI 802.11n HT40 (Harmonic @ 3m)**

<b>WIFI</b>	<b>Band 2 5250~5350MHz Harmonic @ 3m</b>	
<b>ANT</b>	<b>802.11n HT40 CH54 5270 MHz</b>	
<b>2</b>	<b>Horizontal</b>	<b>Vertical</b>
<b>Peak</b> <b>Avg.</b>		



WIFI	Band 2 5250~5350MHz Harmonic @ 3m	
ANT	802.11n HT40 CH62 5310 MHz	
2	Horizontal	Vertical
Peak Avg.	<p>Site : 03C116-11V Condition : PEAK(LINE) 3m 91200_1522 HORIZONTAL Detector : Peak Project : 940905-02</p>	<p>Site : 03C116-11V Condition : PEAK(LINE) 3m 91200_1522 VERTICAL Detector : Peak Project : 940905-02</p>



**Band 2 5250~5350MHz**  
**WIFI 802.11ac VHT80 (Harmonic @ 3m)**

<b>WIFI</b>	<b>Band 2 5250~5350MHz Harmonic @ 3m</b>	
<b>ANT</b>	<b>802.11ac VHT80 CH58 5290MHz</b>	
<b>2</b>	<b>Horizontal</b>	<b>Vertical</b>
<b>Peak</b> <b>Avg.</b>	<p>Site : 03CH16-HV          Condition : PEAK(LINE) 3m 91200_1522 HORIZONTAL          Detector : Peak          Project : 940905-02</p>	<p>Site : 03CH16-HV          Condition : PEAK(LINE) 3m 91200_1522 VERTICAL          Detector : Peak          Project : 940905-02</p>

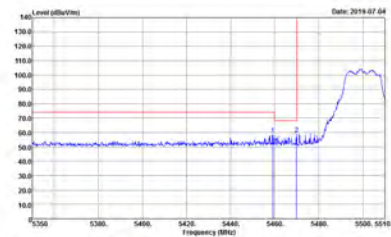
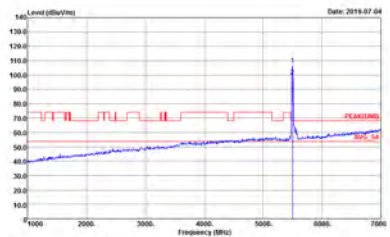
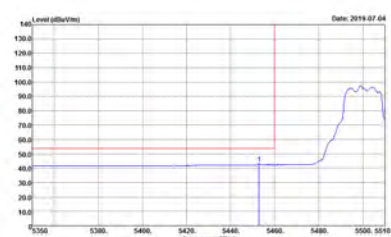

**Band 3 - 5470~5725MHz**  
**WIFI 802.11a (Band Edge @ 3m)**

WIFI	Band 3 5470~5725MHz Band Edge @ 3m	
ANT	802.11a CH100 5500MHz	
2	Horizontal	Fundamental
<b>Peak</b>	 <p>Site : 03CH16-HY            Condition : PEAK_BE[UNIT], B3 3m 91200_1522 HORIZONTAL            RBW:1000.0000Hz VSW:3000.0000Hz SWT:Auto            Detector : Peak            Project : 940905-02</p>	 <p>Site : 03CH16-HY            Condition : PEAK[UNIT] 3m 91200_1522 HORIZONTAL            RBW:1000.0000Hz VSW:3000.0000Hz SWT:Auto            Detector : Peak            Project : 940905-02</p>
<b>Avg.</b>	 <p>Site : 03CH16-HY            Condition : AVG_BE[UNIT], B3 3m 91200_1522 HORIZONTAL            RBW:1000.0000Hz VSW:3000.0000Hz SWT:Auto            Detector : Peak            Project : 940905-02</p>	Left blank

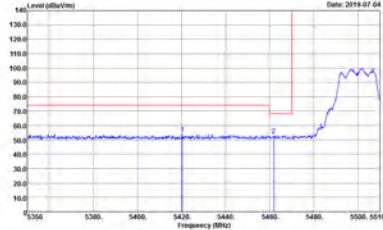
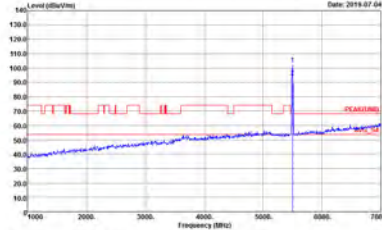
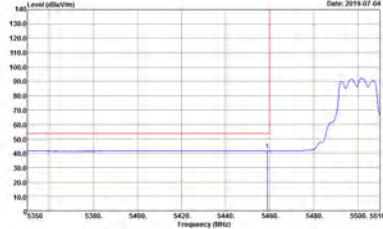

WIFI	Band 3 5470~5725MHz Band Edge @ 3m	
ANT	802.11a CH100 5500MHz	
2	Vertical	Fundamental
Peak	 <p>Site : 03CH16-HY            Condition : PEAK_BE(LINE1), 83 3m 91200_1522 VERTICAL            RBW:1000.0000 Hz VSW:3000.0000 Hz SWT:Auto            Detector : Peak            Project : 940905-02</p>	 <p>Site : 03CH16-HY            Condition : PEAK(LINE1) 3m 91200_1522 VERTICAL            RBW:1000.0000 Hz VSW:3000.0000 Hz SWT:Auto            Detector : Peak            Project : 940905-02</p>
Avg.	 <p>Site : 03CH16-HY            Condition : AVG_BE(LINE1), 83 3m 91200_1522 VERTICAL            RBW:1000.0000 Hz VSW:3000.0000 Hz SWT:Auto            Detector : Peak            Project : 940905-02</p>	Left blank

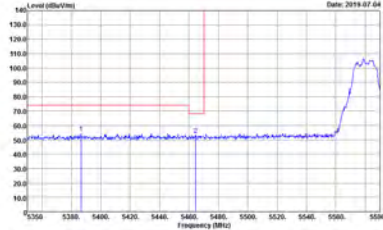
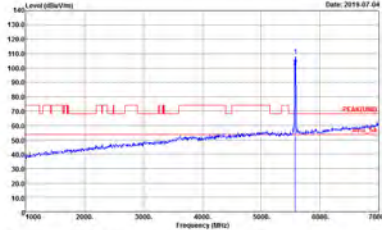
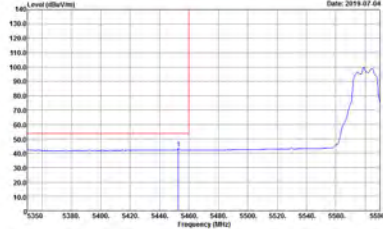

WIFI	Band 3 5470~5725MHz Band Edge @ 3m	
ANT	802.11a CH116 5580MHz - L	
2	Horizontal	Fundamental
Peak	 <p>Site : 03CH16-HY            Condition : PEAK_BE(LINE1), 83 3m 91200_1522 HORIZONTAL            RBW:1000.0000Hz VSW:3000.0000Hz SWT:Auto            Detector : Peak            Project : 940905-02</p>	 <p>Site : 03CH16-HY            Condition : PEAK(LINE1) 3m 91200_1522 HORIZONTAL            RBW:1000.0000Hz VSW:3000.0000Hz SWT:Auto            Detector : Peak            Project : 940905-02</p>
Avg.	 <p>Site : 03CH16-HY            Condition : AVG_BE(LINE1), 83 3m 91200_1522 HORIZONTAL            RBW:1000.0000Hz VSW:3000.0000Hz SWT:Auto            Detector : Peak            Project : 940905-02</p>	Left blank

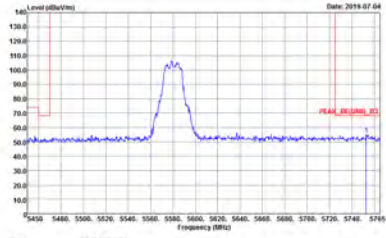

WIFI	Band 3 5470~5725MHz Band Edge @ 3m	
ANT	802.11a CH116 5580MHz - R	
2	Horizontal	Fundamental
Peak		Left blank

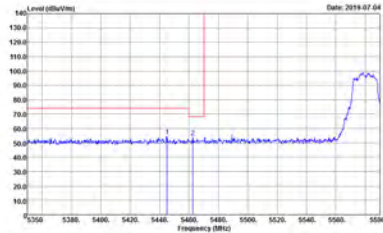
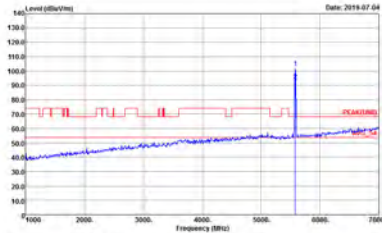
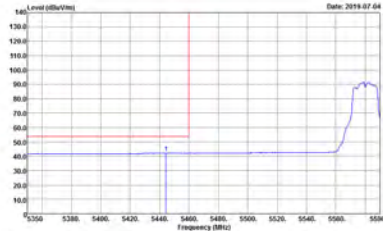

WIFI	Band 3 5470~5725MHz Band Edge @ 3m	
ANT	802.11a CH16 5580MHz - L	
2	Vertical	Fundamental
Peak	 <p>Site : 03CH16-HV            Condition : PEAK_BE[LINE], 83 3m 91200_1522 VERTICAL            RBW:1000.0000 Hz VSW:3000.0000 Hz SWT:Auto            Detector : Peak            Project : 940905-02</p>	 <p>Site : 03CH16-HV            Condition : PEAK[LINE], 3m 91200_1522 VERTICAL            RBW:1000.0000 Hz VSW:3000.0000 Hz SWT:Auto            Detector : Peak            Project : 940905-02</p>
Avg.	 <p>Site : 03CH16-HV            Condition : AVG_BE[LINE], 83 3m 91200_1522 VERTICAL            RBW:1000.0000 Hz VSW:3000.0000 Hz SWT:Auto            Detector : Peak            Project : 940905-02</p>	Left blank



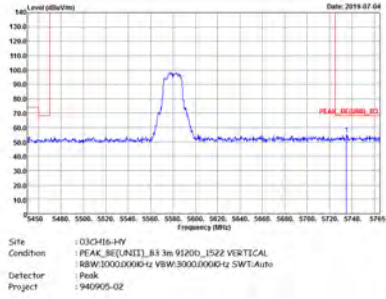

WIFI	Band 3 5470~5725MHz Band Edge @ 3m	
ANT	802.11a CH116 5580MHz - R	
2	Vertical	Fundamental
Peak		Left blank



WIFI	Band 3 5470~5725MHz Band Edge @ 3m	
ANT	802.11a CH140 5700MHz	
2	Horizontal	Fundamental
Peak	<p>Site: 03CH11a-14V Condition: PEAK_86(LINE1)_B3 3m 91200_1522 HORIZONTAL RBW:1000.0000 Hz VSW:3000.0000 Hz SWT:Auto Detector: Peak Project: 1940905-02</p>	<p>Site: 03CH11a-14V Condition: PEAK(LINE1)_3m 91200_1522 HORIZONTAL RBW:1000.0000 Hz VSW:3000.0000 Hz SWT:Auto Detector: Peak Project: 1940905-02</p>



WIFI	Band 3 5470~5725MHz Band Edge @ 3m	
ANT	802.11a CH140 5700MHz	
2	Vertical	Fundamental
Peak	<p>Site : 03CH11a-14V Condition : PEAK_8E[LINE], B3 3m 91200_1522 VERTICAL RBW:1000.0000 Hz VSW:3000.0000 Hz SWT:Auto Detector : Peak Project : 940905-02</p>	<p>Site : 03CH11a-14V Condition : PEAK(LINE) 3m 91200_1522 VERTICAL RBW:1000.0000 Hz VSW:3000.0000 Hz SWT:Auto Detector : Peak Project : 940905-02</p>

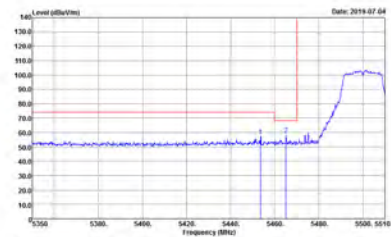
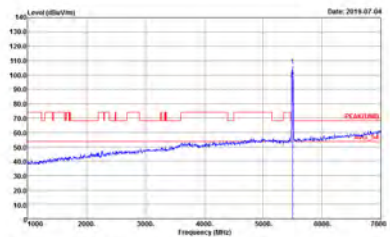
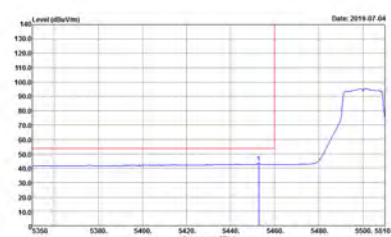

**Band 3 5470~5725MHz**  
**WIFI 802.11n HT20 (Band Edge @ 3m)**

WIFI	Band 3 5470~5725MHz Band Edge @ 3m	
ANT	802.11n HT20 CH100 5500MHz	
2	Horizontal	Fundamental
<b>Peak</b>	 <p>Site : 03CH16-HY            Condition : PFA4_BE[UNIT]_B3 3m 91200_1522 HORIZONTAL            RBW:1000.0000Hz VSW:3000.0000Hz SWT:Auto            Detector : Peak            Project : 940905-02</p>	 <p>Site : 03CH16-HY            Condition : PFA4[UNIT] 3m 91200_1522 HORIZONTAL            RBW:1000.0000Hz VSW:3000.0000Hz SWT:Auto            Detector : Peak            Project : 940905-02</p>
<b>Avg.</b>	 <p>Site : 03CH16-HY            Condition : AV6_BE[UNIT]_B3 3m 91200_1522 HORIZONTAL            RBW:1000.0000Hz VSW:3000.0000Hz SWT:Auto            Detector : Peak            Project : 940905-02</p>	Left blank

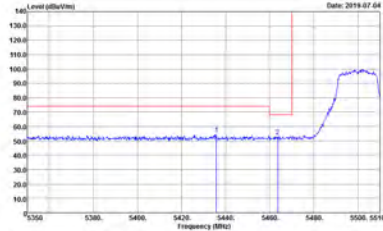
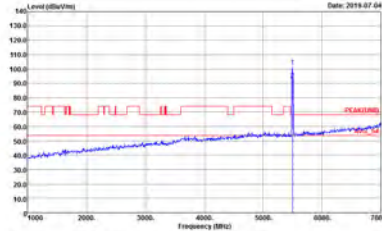
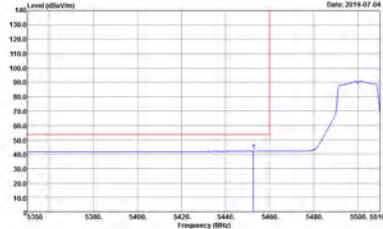

WIFI	Band 3 5470~5725MHz Band Edge @ 3m	
ANT	802.11n HT20 CH100 5500MHz	
2	Vertical	Fundamental
Peak	 <p>Site : 03CH16-HV            Condition : PEAK_BE[LINE1], 83 3m 91200_1522 VERTICAL            RBW:1000.0000Hz VSW:3000.0000Hz SWT:Auto            Detector : Peak            Project : 940905-02</p>	 <p>Site : 03CH16-HV            Condition : PEAK[LINE1] 3m 91200_1522 VERTICAL            RBW:1000.0000Hz VSW:3000.0000Hz SWT:Auto            Detector : Peak            Project : 940905-02</p>
Avg.	 <p>Site : 03CH16-HV            Condition : AVG_BE[LINE1], 83 3m 91200_1522 VERTICAL            RBW:1000.0000Hz VSW:3000.0000Hz SWT:Auto            Detector : Peak            Project : 940905-02</p>	Left blank

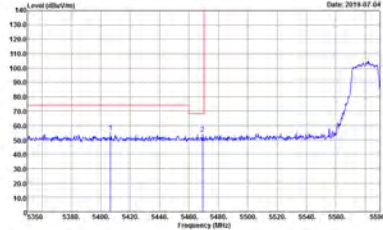
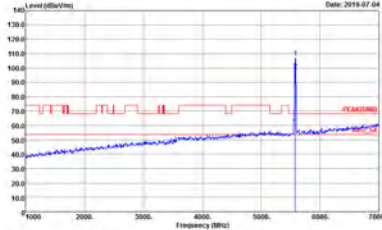
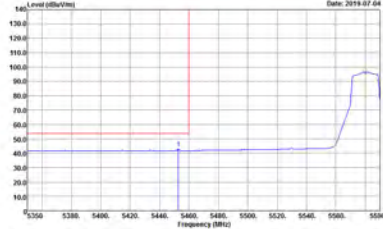

WIFI	Band 3 5470~5725MHz Band Edge @ 3m	
ANT	802.11n HT20 CH116 5580MHz - L	
2	Horizontal	Fundamental
Peak	 <p>Site : 03CH16-HV            Condition : PEAK_BE(LINE1), 83 3m 91200_1522 HORIZONTAL            RBW:1000.0000 Hz VSW:3000.0000 Hz SWT:Auto            Detector : Peak            Project : 940905-02</p>	 <p>Site : 03CH16-HV            Condition : PEAK(LINE1) 3m 91200_1522 HORIZONTAL            RBW:1000.0000 Hz VSW:3000.0000 Hz SWT:Auto            Detector : Peak            Project : 940905-02</p>
Avg.	 <p>Site : 03CH16-HV            Condition : AVG_BE(LINE1), 83 3m 91200_1522 HORIZONTAL            RBW:1000.0000 Hz VSW:3000.0000 Hz SWT:Auto            Detector : Peak            Project : 940905-02</p>	Left blank



WIFI	Band 3 5470~5725MHz Band Edge @ 3m	
ANT	802.11n HT20 CH116 5580MHz - R	
2	Horizontal	Fundamental
Peak	<p>Site : DISCH16-44V Condition : PEAK_86(UNIT)_B3 3m 91200_1522 HORIZONTAL RBW:1000.0000Hz VBW:3000.0000Hz SWT:Auto Detector : Peak Project : 940905-02</p>	Left blank

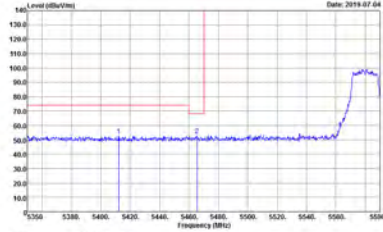
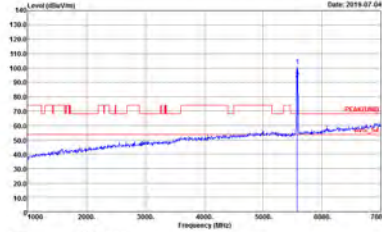
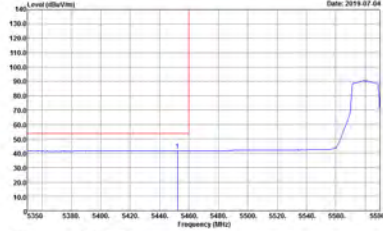

WIFI	Band 3 5470~5725MHz Band Edge @ 3m	
ANT	802.11n HT20 CH116 5580MHz - L	
2	Vertical	Fundamental
Peak	 <p>Site : 03CH16-HV            Condition : PEAK_BE[LINE1], 83 3m 91200_1522 VERTICAL            RBW:1000.0000Hz VSW:3000.0000Hz SWT:Auto            Detector : Peak            Project : 940905-02</p>	 <p>Site : 03CH16-HV            Condition : PEAK[LINE1] 3m 91200_1522 VERTICAL            RBW:1000.0000Hz VSW:3000.0000Hz SWT:Auto            Detector : Peak            Project : 940905-02</p>
Avg.	 <p>Site : 03CH16-HV            Condition : AVG_BE[LINE1], 83 3m 91200_1522 VERTICAL            RBW:1000.0000Hz VSW:3000.0000Hz SWT:Auto            Detector : Peak            Project : 940905-02</p>	Left blank



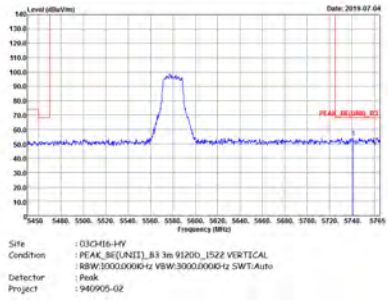

WIFI	Band 3 5470~5725MHz Band Edge @ 3m	
ANT	802.11n HT20 CH116 5580MHz - R	
2	Vertical	Fundamental
Peak		Left blank



WIFI	Band 3 5470~5725MHz Band Edge @ 3m	
ANT	802.11n HT20 CH140 5700MHz	
2	Horizontal	Fundamental
Peak	<p>Site : 03CH16-14V Condition : PEAK_86(LINE1)_B3 3m 91200_1522 HORIZONTAL RBW:1000.0000 Hz VSW:3000.0000 Hz SWT:Auto Detector : Peak Project : 940905-02</p>	<p>Site : 03CH16-14V Condition : PEAK(LINE1) 3m 91200_1522 HORIZONTAL RBW:1000.0000 Hz VSW:3000.0000 Hz SWT:Auto Detector : Peak Project : 940905-02</p>



WIFI	Band 3 5470~5725MHz Band Edge @ 3m	
ANT	802.11n HT20 CH140 5700MHz	
2	Vertical	Fundamental
Peak.	<p>Site : 03CH16-14V Condition : PEAK_86(LINE1), B3 3m 91200_1522 VERTICAL RBW:1000.0000 Hz VSW:3000.0000 Hz SWT:Auto Detector : Peak Project : 940905-02</p>	<p>Site : 03CH16-14V Condition : PEAK(LINE1) 3m 91200_1522 VERTICAL RBW:1000.0000 Hz VSW:3000.0000 Hz SWT:Auto Detector : Peak Project : 940905-02</p>

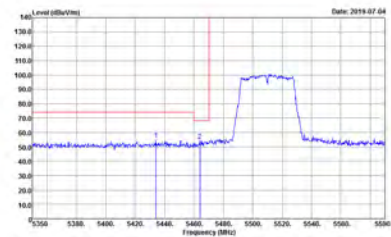
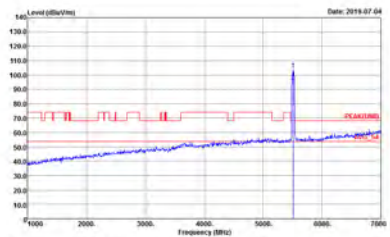
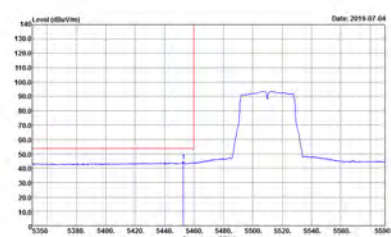

**Band 3 5470~5725MHz**  
**WIFI 802.11n HT40 (Band Edge @ 3m)**

WIFI	Band 3 5470~5725MHz Band Edge @ 3m	
ANT	802.11n HT40 CH102 5510MHz - L	
2	Horizontal	Fundamental
<b>Peak</b>	 <p>Site : 03CH16-HY            Condition : PEAK_8E[UNIT]_B3 3m 91200_1522 HORIZONTAL            RBW:1000.0000Hz VSW:3000.0000Hz SWT:Auto            Detector : Peak            Project : 940905-02</p>	 <p>Site : 03CH16-HY            Condition : PEAK[UNIT] 3m 91200_1522 HORIZONTAL            RBW:1000.0000Hz VSW:3000.0000Hz SWT:Auto            Detector : Peak            Project : 940905-02</p>
<b>Avg.</b>	 <p>Site : 03CH16-HY            Condition : AVG_BE[UNIT]_B3 3m 91200_1522 HORIZONTAL            RBW:1000.0000Hz VSW:10000Hz SWT:Auto            Detector : Peak            Project : 940905-02</p>	Left blank

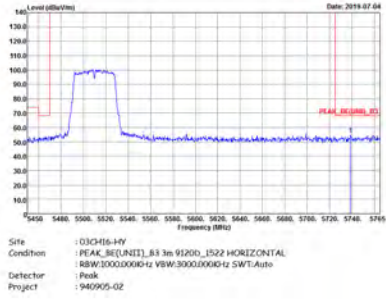

WIFI	Band 3 5470~5725MHz Band Edge @ 3m	
ANT	802.11n HT40 CH102 5510MHz - R	
2	Horizontal	Fundamental
Peak		Left blank

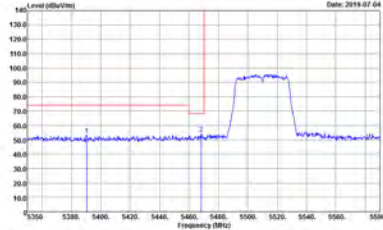
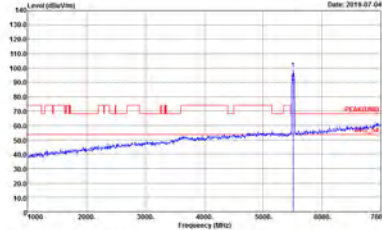
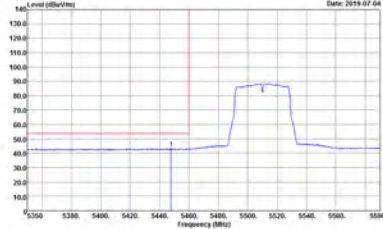

WIFI	Band 3 5470~5725MHz Band Edge @ 3m	
ANT	802.11n HT40 CH102 5510MHz - L	
2	Vertical	Fundamental
Peak	 <p>Site : 03CH16-HV            Condition : PEAK_BE[LINE], 83 3m 91200_1522 VERTICAL            RBW:1000.0000Hz VSW:3000.0000Hz SWT:Auto            Detector : Peak            Project : 940905-02</p>	 <p>Site : 03CH16-HV            Condition : PEAK[LINE], 3m 91200_1522 VERTICAL            RBW:1000.0000Hz VSW:3000.0000Hz SWT:Auto            Detector : Peak            Project : 940905-02</p>
Avg.	 <p>Site : 03CH16-HV            Condition : AVG_BE[LINE], 83 3m 91200_1522 VERTICAL            RBW:1000.0000Hz VSW:10000Hz SWT:Auto            Detector : Peak            Project : 940905-02</p>	Left blank

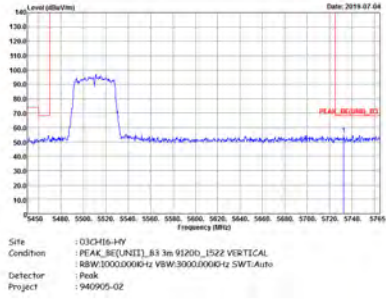

WIFI	Band 3 5470~5725MHz Band Edge @ 3m	
ANT	802.11n HT40 CH102 5510MHz - R	
2	Vertical	Fundamental
Peak		Left blank

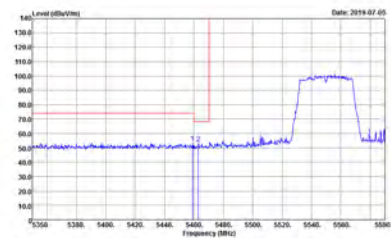
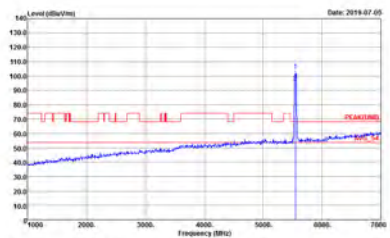
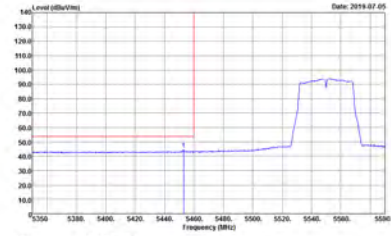

WIFI	Band 3 5470~5725MHz Band Edge @ 3m	
ANT	802.11n HT40 CH110 5550MHz - L	
2	Horizontal	Fundamental
Peak	 <p>Site : 03CH16-HV            Condition : PEAK_BE[LINE], 83 3m 91200_1522 HORIZONTAL            RBW:1000.0000Hz VSW:3000.0000Hz SWT:Auto            Detector : Peak            Project : 940905-02</p>	 <p>Site : 03CH16-HV            Condition : PEAK[LINE] 3m 91200_1522 HORIZONTAL            RBW:1000.0000Hz VSW:3000.0000Hz SWT:Auto            Detector : Peak            Project : 940905-02</p>
Avg.	 <p>Site : 03CH16-HV            Condition : AVG_BE[LINE], 83 3m 91200_1522 HORIZONTAL            RBW:1000.0000Hz VSW:3000.0000Hz SWT:Auto            Detector : Peak            Project : 940905-02</p>	Left blank



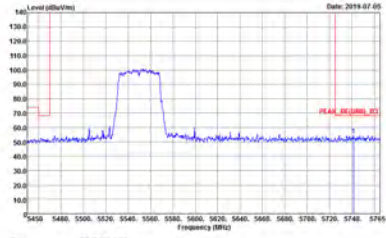

WIFI	Band 3 5470~5725MHz Band Edge @ 3m	
ANT	802.11n HT40 CH110 5550MHz - R	
2	Horizontal	Fundamental
Peak	 <p>Site: D3CH16-4M Condition: PEAK_B3([LINE]), B3 3m 91200_1522 HORIZONTAL Detector: Peak Project: 940905-02</p>	Left blank

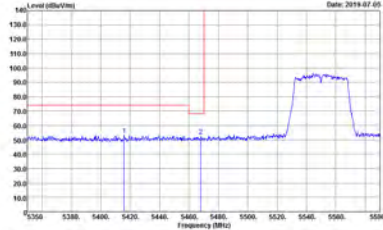
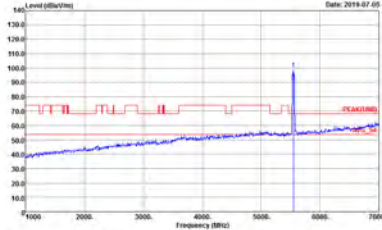
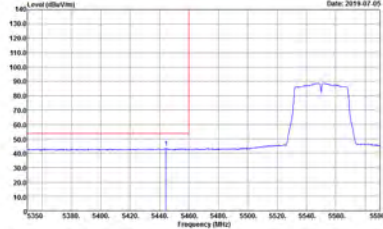

WIFI	Band 3 5470~5725MHz Band Edge @ 3m	
ANT	802.11n HT40 CH110 5550MHz - L	
2	Vertical	Fundamental
Peak	 <p>Site : 03CH16-HV            Condition : PEAK_BE[LINE1], 83 3m 91200_1522 VERTICAL            RBW:1000.0000Hz VSW:3000.0000Hz SWT:Auto            Detector : Peak            Project : 940905-02</p>	 <p>Site : 03CH16-HV            Condition : PEAK[LINE1] 3m 91200_1522 VERTICAL            RBW:1000.0000Hz VSW:3000.0000Hz SWT:Auto            Detector : Peak            Project : 940905-02</p>
Avg.	 <p>Site : 03CH16-HV            Condition : AVG_BE[LINE1], 83 3m 91200_1522 VERTICAL            RBW:1000.0000Hz VSW:10000Hz SWT:Auto            Detector : Peak            Project : 940905-02</p>	Left blank

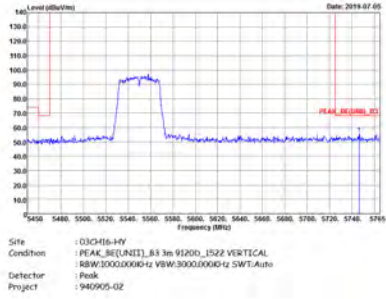

WIFI	Band 3 5470~5725MHz Band Edge @ 3m	
ANT	802.11n HT40 CH110 5550MHz - R	
2	Vertical	Fundamental
Peak		Left blank

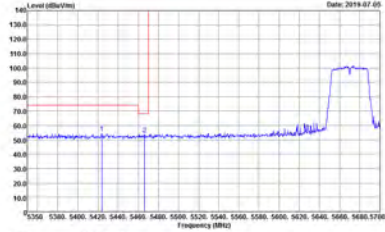
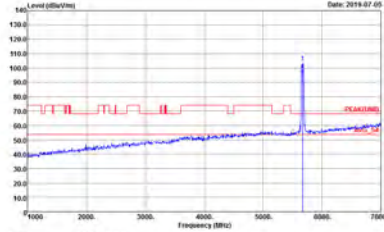
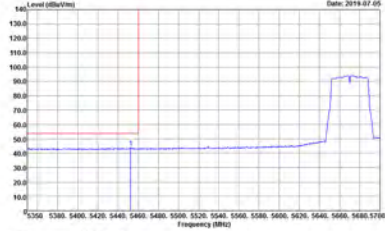

WIFI	Band 3 5470~5725MHz Band Edge @ 3m	
ANT	802.11n HT40 CH134 5670MHz - L	
2	Horizontal	Fundamental
Peak	 <p>Site : 03CH16-HV            Condition : PEAK_BE(LINE1), 83 3m 91200_1522 HORIZONTAL            RBW:1000.0000Hz VSW:3000.0000Hz SWT:Auto            Detector : Peak            Project : 940905-02</p>	 <p>Site : 03CH16-HV            Condition : PEAK(LINE1) 3m 91200_1522 HORIZONTAL            RBW:1000.0000Hz VSW:3000.0000Hz SWT:Auto            Detector : Peak            Project : 940905-02</p>
Avg.	 <p>Site : 03CH16-HV            Condition : AVG_BE(LINE1), 83 3m 91200_1522 HORIZONTAL            RBW:1000.0000Hz VSW:3000.0000Hz SWT:Auto            Detector : Peak            Project : 940905-02</p>	Left blank

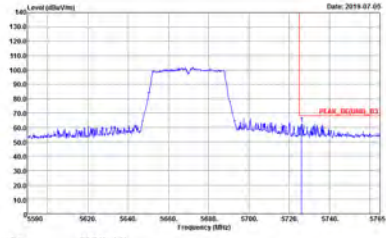

WIFI	Band 3 5470~5725MHz Band Edge @ 3m	
ANT	802.11n HT40 CH134 5670MHz - R	
2	Horizontal	Fundamental
Peak		Left blank

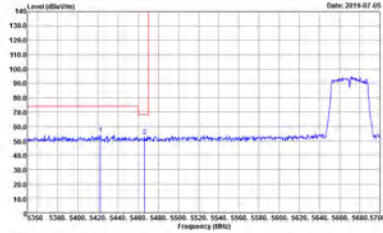
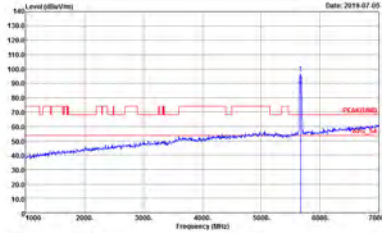
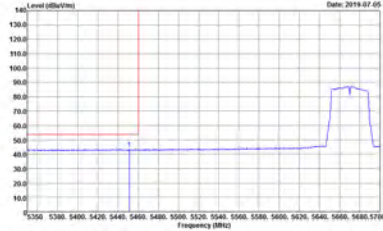

WIFI	Band 3 5470~5725MHz Band Edge @ 3m	
ANT	802.11n HT40 CH134 5670MHz - L	
2	Vertical	Fundamental
Peak	 <p>Site : 03CH16-HV            Condition : PEAK_BE[LINE], 83 3m 91200_1522 VERTICAL            RBW:1000.0000Hz VSW:3000.0000Hz SWT:Auto            Detector : Peak            Project : 940905-02</p>	 <p>Site : 03CH16-HV            Condition : PEAK[LINE] 3m 91200_1522 VERTICAL            RBW:1000.0000Hz VSW:3000.0000Hz SWT:Auto            Detector : Peak            Project : 940905-02</p>
Avg.	 <p>Site : 03CH16-HV            Condition : AVG_BE[LINE], 83 3m 91200_1522 VERTICAL            RBW:1000.0000Hz VSW:3000.0000Hz SWT:Auto            Detector : Peak            Project : 940905-02</p>	Left blank

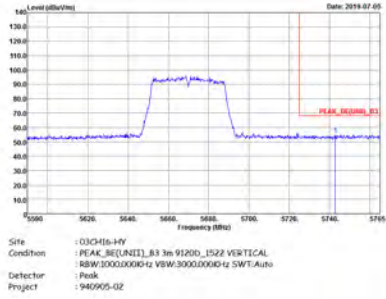

WIFI	Band 3 5470~5725MHz Band Edge @ 3m	
ANT	802.11n HT40 CH134 5670MHz - R	
2	Vertical	Fundamental
Peak		Left blank

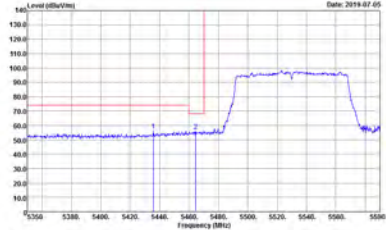
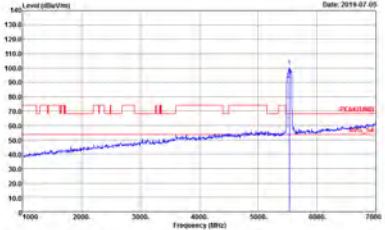
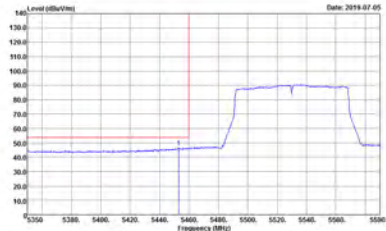

**Band 3 5470~5725MHz**  
**WIFI 802.11ac VHT80 (Band Edge @ 3m)**

WIFI	Band 3 5470~5725MHz Band Edge @ 3m	
ANT	802.11ac VHT80 CH106 5530MHz - L	
2	Horizontal	Fundamental
<b>Peak</b>	 <p>Site : 03CH16-HY            Condition : PFA4_8E[UNIT], B3 3m 91200_1522 HORIZONTAL            RBW:1000.0000Hz VSW:3000.0000Hz SWT:Auto            Detector : Peak            Project : 940905-02</p>	 <p>Site : 03CH16-HY            Condition : PFA4[UNIT] 3m 91200_1522 HORIZONTAL            RBW:1000.0000Hz VSW:3000.0000Hz SWT:Auto            Detector : Peak            Project : 940905-02</p>
<b>Avg.</b>	 <p>Site : 03CH16-HY            Condition : AV6_8E[UNIT], B3 3m 91200_1522 HORIZONTAL            RBW:1000.0000Hz VSW:3.0000Hz SWT:Auto            Detector : Peak            Project : 940905-02</p>	Left blank



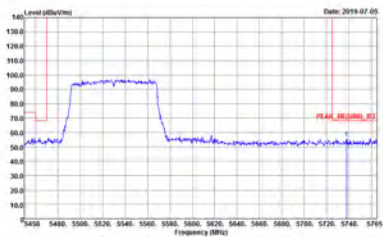

WIFI	Band 3 5470~5725MHz Band Edge @ 3m	
ANT	802.11ac VHT80 CH106 5530MHz - R	
2	Horizontal	Fundamental
Peak	 <p>Site : D:\CH16-4\4 Condition : PEAK_RE[LINE], B3 3m 91200_1522 HORIZONTAL Detector : Peak Project : 940905-02</p>	Left blank

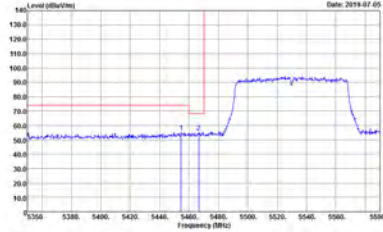
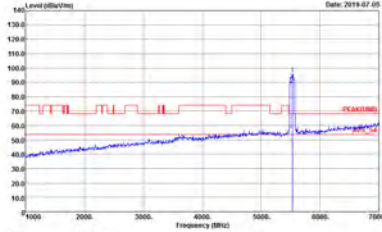
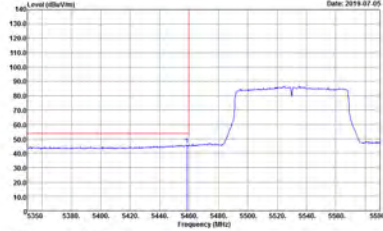

WIFI	Band 3 5470~5725MHz Band Edge @ 3m	
ANT	802.11ac VHT80 CH106 5530MHz - L	
2	Vertical	Fundamental
Peak	 <p>Site : 03CH16-HY          Condition : PEAK_BE(LINE1), 83 3m 91200_1522 VERTICAL          RBW:1000.0000Hz VSW:3000.0000Hz SWT:Auto          Detector : Peak          Project : 940905-02</p>	 <p>Site : 03CH16-HY          Condition : PEAK(LINE1) 3m 91200_1522 VERTICAL          RBW:1000.0000Hz VSW:3000.0000Hz SWT:Auto          Detector : Peak          Project : 940905-02</p>
Avg.	 <p>Site : 03CH16-HY          Condition : AVG_BE(LINE1), 83 3m 91200_1522 VERTICAL          RBW:1000.0000Hz VSW:3000.0000Hz SWT:Auto          Detector : Peak          Project : 940905-02</p>	Left blank

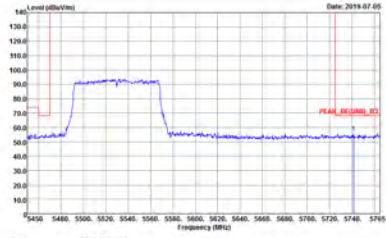

WIFI	Band 3 5470~5725MHz Band Edge @ 3m	
ANT	802.11ac VHT80 CH106 5530MHz - R	
2	Vertical	Fundamental
Peak	 <p>Site : D:\CH16-4\4 Condition : PEAK_RE[LINE], B3 3m 91200_1522 VERTICAL Detector : Peak Project : 940905-02</p>	Left blank

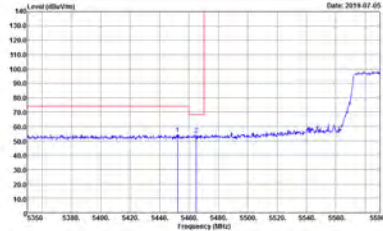
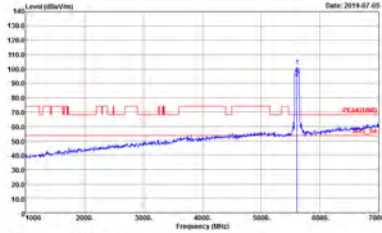
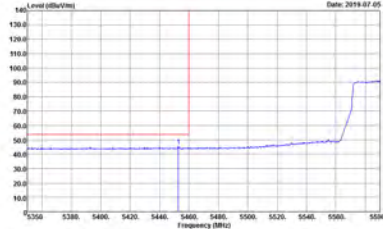

WIFI	Band 3 5470~5725MHz Band Edge @ 3m	
ANT	802.11ac VHT80 CH122 5610MHz - L	
2	Horizontal	Fundamental
Peak	 <p>Site : 03CH16-HY          Condition : PEAK_BE[LINE], 83 3m 91200_1522 HORIZONTAL          RBW:1000.0000Hz VSW:3000.0000Hz SWT:Auto          Detector : Peak          Project : 940905-02</p>	 <p>Site : 03CH16-HY          Condition : PEAK[LINE], 3m 91200_1522 HORIZONTAL          RBW:1000.0000Hz VSW:3000.0000Hz SWT:Auto          Detector : Peak          Project : 940905-02</p>
Avg.	 <p>Site : 03CH16-HY          Condition : AVG_BE[LINE], 83 3m 91200_1522 HORIZONTAL          RBW:1000.0000Hz VSW:3000.0000Hz SWT:Auto          Detector : Peak          Project : 940905-02</p>	Left blank



WIFI	Band 3 5470~5725MHz Band Edge @ 3m	
ANT	802.11ac VHT80 CH122 5610MHz - R	
2	Horizontal	Fundamental
Peak	<p>Site : D:\CH16-4\4 Condition : PEAK_RE[LINE], B3 3m 91200_1522 HORIZONTAL Detector : Peak Project : 940905-02</p>	Left blank

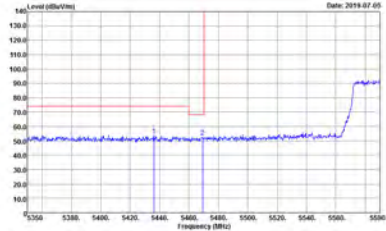
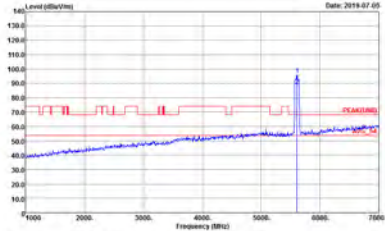
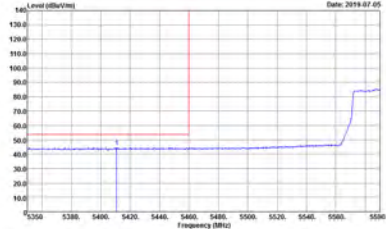

WIFI	Band 3 5470~5725MHz Band Edge @ 3m	
ANT	802.11ac VHT80 CH122 5610MHz - L	
2	Vertical	Fundamental
Peak	 <p>Site : 03CH16-HY            Condition : PEAK_BE[LINE1], 83 3m 91200_1522 VERTICAL            RBW:1000.0000Hz VSW:3000.0000Hz SWT:Auto            Detector : Peak            Project : 940905-02</p>	 <p>Site : 03CH16-HY            Condition : PEAK[LINE1] 3m 91200_1522 VERTICAL            RBW:1000.0000Hz VSW:3000.0000Hz SWT:Auto            Detector : Peak            Project : 940905-02</p>
Avg.	 <p>Site : 03CH16-HY            Condition : AVG_BE[LINE1], 83 3m 91200_1522 VERTICAL            RBW:1000.0000Hz VSW:3000.0000Hz SWT:Auto            Detector : Peak            Project : 940905-02</p>	Left blank

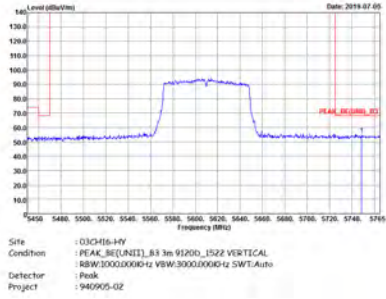

WIFI	Band 3 5470~5725MHz Band Edge @ 3m	
ANT	802.11ac VHT80 CH122 5610MHz - R	
2	Vertical	Fundamental
Peak		Left blank



Band 3 - 5470~5725MHz
WIFI 802.11a (Harmonic @ 3m)

Table with 3 columns: WIFI, ANT, and measurement results for Horizontal and Vertical orientations. Includes spectral plots and metadata like Site, Condition, Detector, and Project.



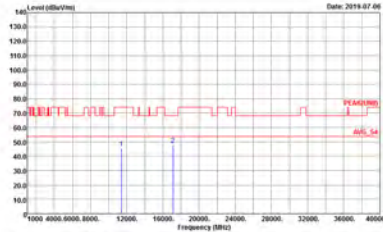
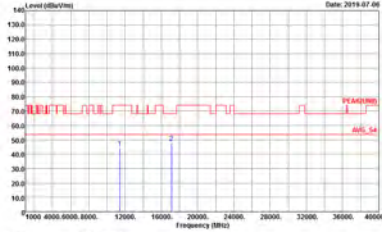

WIFI	Band 3 5470~5725MHz Harmonic @ 3m	
ANT	802.11a CH116 5580MHz	
2	Horizontal	Vertical
Peak Avg.	 <p>Site : 03C16-11V Condition : PEAK(LINE) 3m 91200_1522 HORIZONTAL Detector : Peak Project : 940905-02</p>	 <p>Site : 03C16-11V Condition : PEAK(LINE) 3m 91200_1522 VERTICAL Detector : Peak Project : 940905-02</p>



WIFI	Band 3 5470~5725MHz Harmonic @ 3m	
ANT	802.11a CH140 5700MHz	
2	Horizontal	Vertical
Peak Avg.	<p>Site : 03C166-89V Condition : PEAK(LINE) 3m 91200_1522 HORIZONTAL Detector : Peak Project : 940905-02</p>	<p>Site : 03C166-89V Condition : PEAK(LINE) 3m 91200_1522 VERTICAL Detector : Peak Project : 940905-02</p>



**Band 3 5470~5725MHz**  
**WIFI 802.11n HT20 (Harmonic @ 3m)**

<b>WIFI</b>	<b>Band 3 5470~5725MHz Harmonic @ 3m</b>	
<b>ANT</b>	<b>802.11n HT20 CH100 5500MHz</b>	
<b>2</b>	<b>Horizontal</b>	<b>Vertical</b>
<b>Peak</b> <b>Avg.</b>	<p>Site : 03CH16-HV          Condition : PEAK(LINE1) 3m 91200_1522 HORIZONTAL          Detector : Peak          Project : 940905-02</p>	<p>Site : 03CH16-HV          Condition : PEAK(LINE1) 3m 91200_1522 VERTICAL          Detector : Peak          Project : 940905-02</p>



WIFI	Band 3 5470~5725MHz Harmonic @ 3m	
ANT	802.11n HT20 CH116 5580MHz	
2	Horizontal	Vertical
Peak Avg.	<p>Site : 03C116-14V Condition : PEAK(LINE) 3m 91200_1522 HORIZONTAL Detector : Peak Project : 940905-02</p>	<p>Site : 03C116-14V Condition : PEAK(LINE) 3m 91200_1522 VERTICAL Detector : Peak Project : 940905-02</p>

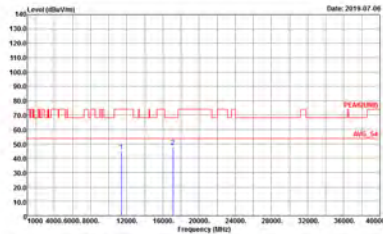
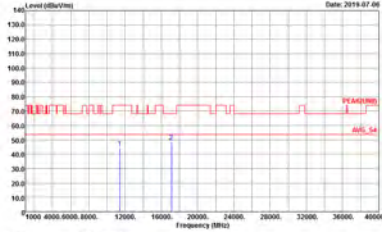

WIFI	Band 3 5470~5725MHz Harmonic @ 3m	
ANT	802.11n HT20 CH140 5700MHz	
2	Horizontal	Vertical
Peak Avg.	 <p>Site : 03C16-11V Condition : PEAK(LINE) 3m 91200_1522 HORIZONTAL Detector : Peak Project : 940905-02</p>	 <p>Site : 03C16-11V Condition : PEAK(LINE) 3m 91200_1522 VERTICAL Detector : Peak Project : 940905-02</p>

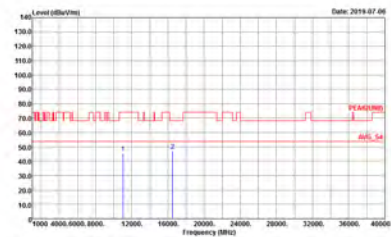
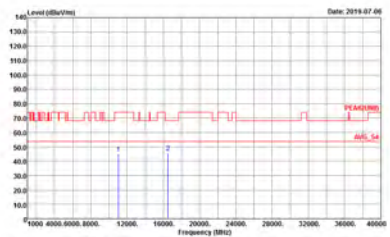

**Band 3 5470~5725MHz**  
**WIFI 802.11n HT40 (Harmonic @ 3m)**

WIFI	Band 3 5470~5725MHz Harmonic @ 3m	
ANT	802.11n HT40 CH102 5510MHz	
2	Horizontal	Vertical
Peak Avg.	 <p>Site : 03CH16-HV          Condition : PEAK(LINE1) 3m 91200_3522 HORIZONTAL          Detector : Peak          Project : 940905-02</p>	 <p>Site : 03CH16-HV          Condition : PEAK(LINE1) 3m 91200_3522 VERTICAL          Detector : Peak          Project : 940905-02</p>



WIFI	Band 3 5470~5725MHz Harmonic @ 3m	
ANT	802.11n HT40 CH110 5550MHz	
2	Horizontal	Vertical
Peak Avg.	<p>Site : 03C116-14V Condition : PEAK(LINE) 3m 91200_1522 HORIZONTAL Detector : Peak Project : 940905-02</p>	<p>Site : 03C116-14V Condition : PEAK(LINE) 3m 91200_1522 VERTICAL Detector : Peak Project : 940905-02</p>

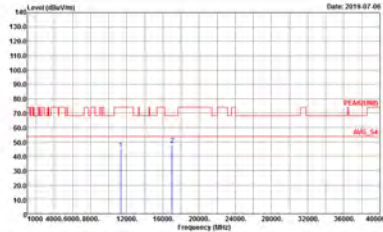
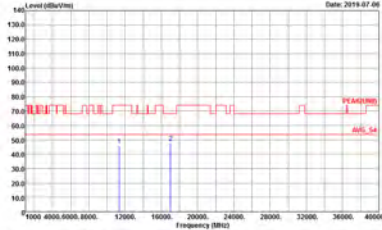

WIFI	Band 3 5470~5725MHz Harmonic @ 3m	
ANT	802.11n HT40 CH134 5670MHz	
2	Horizontal	Vertical
Peak Avg.	 <p>Site : 03C116-14V Condition : PEAK(LINE) 3m 91200_1522 HORIZONTAL Detector : Peak Project : 940905-02</p>	 <p>Site : 03C116-14V Condition : PEAK(LINE) 3m 91200_1522 VERTICAL Detector : Peak Project : 940905-02</p>





**Band 3 5470~5725MHz**  
**WIFI 802.11ac VHT80 (Harmonic @ 3m)**

<b>WIFI</b>	<b>Band 3 5470~5725MHz Harmonic @ 3m</b>	
<b>ANT</b>	<b>802.11ac VHT80 CH106 5530MHz</b>	
<b>2</b>	<b>Horizontal</b>	<b>Vertical</b>
<b>Peak</b> <b>Avg.</b>	<p>Site : 03CH16-HV          Condition : PEAK(UNIT) 3m 91200_1522 HORIZONTAL          Detector : Peak          Project : 940905-02</p>	<p>Site : 03CH16-HV          Condition : PEAK(UNIT) 3m 91200_1522 VERTICAL          Detector : Peak          Project : 940905-02</p>

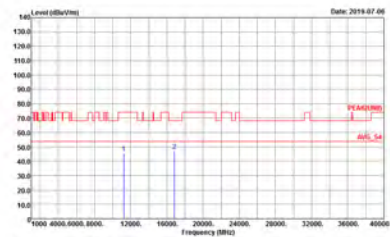
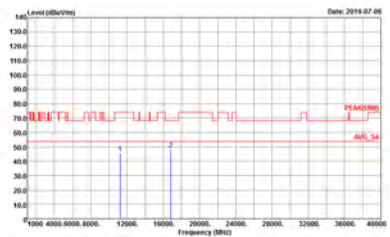

WIFI	Band 3 5470~5725MHz Harmonic @ 3m	
ANT	802.11ac VHT80 CH122 5610MHz	
2	Horizontal	Vertical
Peak Avg.	 <p>Site : 03C156-89V Condition : PEAK(LINE) 3m 91200_1522 HORIZONTAL Detector : Peak Project : 940905-02</p>	 <p>Site : 03C156-89V Condition : PEAK(LINE) 3m 91200_1522 VERTICAL Detector : Peak Project : 940905-02</p>



Band 3 - Straddle Channel
WIFI 802.11a (Fundamental @ 3m)

Table with 3 columns: WIFI, ANT, and test results for Horizontal and Vertical orientations. Includes spectral plots and technical details like Site, Condition, Detector, and Project.



**Band 3 – Straddle Channel**  
**WIFI 802.11n HT20 (Fundamental @ 3m)**

<b>WIFI</b>	<b>Band 3 Straddle Channel Fundamental @ 3m</b>	
<b>ANT</b>	<b>802.11n HT20 CH144 5720MHz</b>	
<b>2</b>	<b>Horizontal</b>	<b>Vertical</b>
<b>Peak Avg.</b>	<p>Site : 03CH6-HV          Condition : STRADDLES U-NIT-142A 3m 91200_1522 HORIZONTAL          RBW:1000.0000Hz VSW:3000.0000Hz SWT:Auto          Detector : Peak          Project : 940905-02</p>	<p>Site : 03CH6-HV          Condition : U-NIT-142A AVERAGE 3m 91200_1522 HORIZONTAL          RBW:1000.0000Hz VSW:0.0100Hz SWT:Auto          Detector : Peak          Project : 940905-02</p>



Band 3 – Straddle Channel  
WIFI 802.11n HT40 (Fundamental @ 3m)

WIFI	Band 3 Straddle Channel Fundamental @ 3m	
ANT	802.11n HT40 CH142 5710MHz	
2	Horizontal	Vertical
Peak Avg.	<p>Site : 03CH06-HV  Condition : STRADDLES U-NIT-142A 3m 91200_1522 HORIZONTAL  RBW:1000.0000Hz VSW:3000.0000Hz SWT:Auto  Detector : Peak  Project : 940905-02</p>	<p>Site : 03CH06-HV  Condition : U-NIT-142A AVERAGE 3m 91200_1522 HORIZONTAL  RBW:1000.0000Hz VSW:10000Hz SWT:Auto  Detector : Peak  Project : 940905-02</p>



Band 3 – Straddle Channel  
WIFI 802.11ac VHT80 (Fundamental @ 3m)

WIFI	Band 3 Straddle Channel Fundamental @ 3m	
ANT	802.11ac VHT80 CH138 5690MHz	
2	Horizontal	Vertical
Peak Avg.	<p>Site : 03CH6-HV Condition : STRADDLES U-NIT-1A2A 3m 91200_1522 HORIZONTAL RBW:1000.0000Hz VSW:3000.0000Hz SWT:Auto Detector : Peak Project : 940905-02</p>	<p>Site : 03CH6-HV Condition : U-NIT-1A2A AVERAGE 3m 91200_1522 HORIZONTAL RBW:1000.0000Hz VSW:3.0000Hz SWT:Auto Detector : Peak Project : 940905-02</p>



**Band 3 - Straddle Channel**  
**WIFI 802.11a (Harmonic @ 3m)**

<b>WIFI</b>	<b>Band 3 Straddle Channel Harmonic @ 3m</b>	
<b>ANT</b>	<b>802.11a CH144 5720MHz</b>	
<b>2</b>	<b>Horizontal</b>	<b>Vertical</b>
<b>Peak</b> <b>Avg.</b>	<p>Site : 03CH16-HV          Condition : PEAK(LINE1) 3m 91200_1522 HORIZONTAL          Detector : Peak          Project : 940905-02</p>	<p>Site : 03CH16-HV          Condition : PEAK(LINE1) 3m 91200_1522 VERTICAL          Detector : Peak          Project : 940905-02</p>



**Band 3 – Straddle Channel**  
**WIFI 802.11n HT20 (Harmonic @ 3m)**

<b>WIFI</b>	<b>Band 3 Straddle Channel Harmonic @ 3m</b>	
<b>ANT</b>	<b>802.11n HT20 CH144 5720MHz</b>	
<b>2</b>	<b>Horizontal</b>	<b>Vertical</b>
<b>Peak</b> <b>Avg.</b>	<p>Site : 03CH16-HV          Condition : PEAK(LINE1) 3m 91200_1522 HORIZONTAL          Detector : Peak          Project : 940905-02</p>	<p>Site : 03CH16-HV          Condition : PEAK(LINE1) 3m 91200_1522 VERTICAL          Detector : Peak          Project : 940905-02</p>





Band 3 – Straddle Channel  
WIFI 802.11n HT40 (Harmonic @ 3m)

WIFI	Band 3 Straddle Channel Harmonic @ 3m	
ANT	802.11n HT40 CH142 5710MHz	
2	Horizontal	Vertical
Peak Avg.	<p>Site : 03CH16-HV Condition : PEAK(LINE1) 3m 91200_1522 HORIZONTAL Detector : Peak Project : 940905-02</p>	<p>Site : 03CH16-HV Condition : PEAK(LINE1) 3m 91200_1522 VERTICAL Detector : Peak Project : 940905-02</p>



**Band 3 – Straddle Channel**  
**WIFI 802.11ac VHT80 (Harmonic @ 3m)**

<b>WIFI</b>	<b>Band 3 Straddle Channel Harmonic @ 3m</b>	
<b>ANT</b>	<b>802.11ac VHT80 CH138 5690MHz</b>	
<b>2</b>	<b>Horizontal</b>	<b>Vertical</b>
<b>Peak</b> <b>Avg.</b>	<p>Site : 03CH16-HV          Condition : PEAK(UNIT) 3m 91200_1522 HORIZONTAL          Detector : Peak          Project : 940905-02</p>	<p>Site : 03CH16-HV          Condition : PEAK(UNIT) 3m 91200_1522 VERTICAL          Detector : Peak          Project : 940905-02</p>



Emission below 1GHz  
5GHz WIFI 802.11n HT20 (LF)

WIFI	5GHz WIFI	
ANT	802.11n HT20 LF	
2	Horizontal	Vertical
QP / Peak	<p>Site : 03CH16-HY Condition : QP 3m BTEL06_47020406 HORIZONTAL Detector : Peak Project : 940905-02</p>	<p>Site : 03CH16-HY Condition : QP 3m BTEL06_47020406 VERTICAL Detector : Peak Project : 940905-02</p>

**Appendix E. Duty Cycle Plots**

Antenna	Band	Duty Cycle(%)	T(us)	1/T(kHz)	VBW Setting	Duty Factor(dB)
1	802.11a	98.07	-	-	10Hz	0.08
2	802.11a	98.54	-	-	10Hz	0.06
1+2	802.11a for Ant. 1	98.54	-	-	10Hz	0.06
1+2	802.11a for Ant. 2	98.07	-	-	10Hz	0.08
1	5GHz 802.11n HT20	99.20	-	-	10Hz	0.03
2	5GHz 802.11n HT20	99.10	-	-	10Hz	0.04
1+2	5GHz 802.11n HT20 for Ant. 1	98.43	-	-	10Hz	0.07
1+2	5GHz 802.11n HT20 for Ant. 2	98.82	-	-	10Hz	0.05
1	5GHz 802.11n HT40	98.77	-	-	10Hz	0.05
2	5GHz 802.11n HT40	98.73	-	-	10Hz	0.06
1+2	5GHz 802.11n HT40 for Ant. 1	96.84	1225	0.82	1kHz	0.14
1+2	5GHz 802.11n HT40 for Ant. 2	96.84	1225	0.82	1kHz	0.14
1	5GHz 802.11ac VHT20	98.91	-	-	10Hz	0.05
2	5GHz 802.11ac VHT20	99.50	-	-	10Hz	0.02
1+2	5GHz 802.11ac VHT20 for Ant. 1	98.43	-	-	10Hz	0.07
1+2	5GHz 802.11ac VHT20 for Ant. 2	98.43	-	-	10Hz	0.07
1	5GHz 802.11ac VHT40	98.78	-	-	10Hz	0.05
2	5GHz 802.11ac VHT40	98.78	-	-	10Hz	0.05
1+2	5GHz 802.11ac VHT40 for Ant. 1	97.23	1230	0.81	1kHz	0.12
1+2	5GHz 802.11ac VHT40 for Ant. 2	96.85	1230	0.81	1kHz	0.14
1	5GHz 802.11ac VHT80	97.01	1135	0.88	1kHz	0.13
2	5GHz 802.11ac VHT80	97.02	1140	0.88	1kHz	0.13
1+2	5GHz 802.11ac VHT80 for Ant. 1	93.81	591	1.69	3kHz	0.28
1+2	5GHz 802.11ac VHT80 for Ant. 2	94.29	594	1.68	3kHz	0.26



<Ant. 1>

802.11a

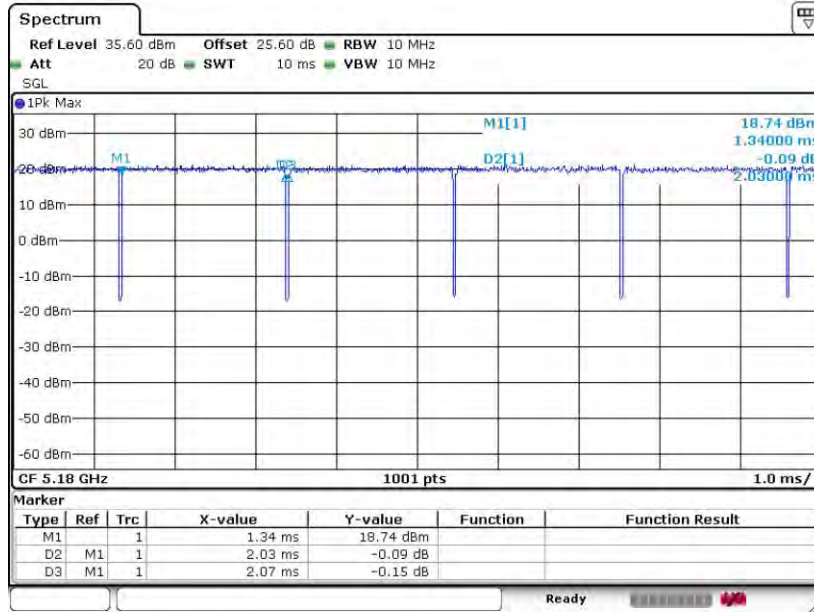

Date: 18.JUN.2019 09:27:20

802.11n HT20

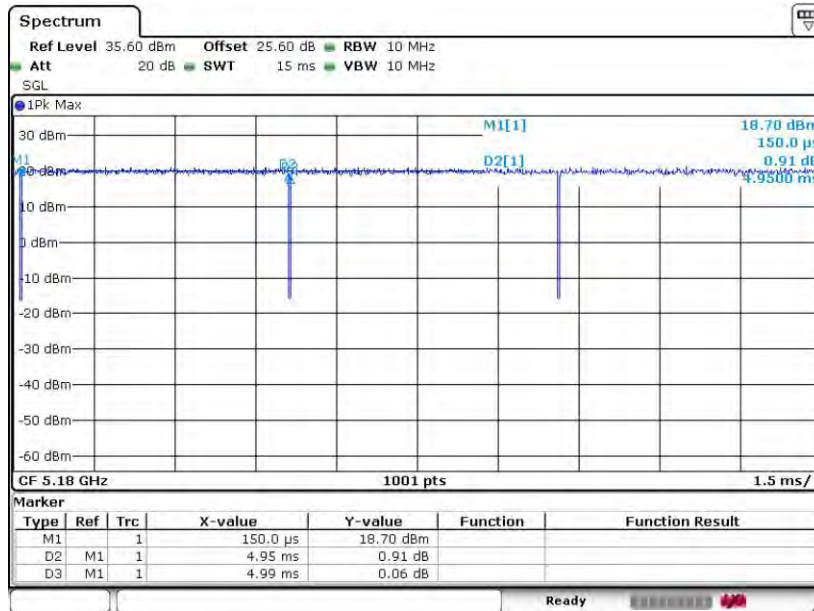

Date: 18.JUN.2019 09:43:11



802.11n HT40

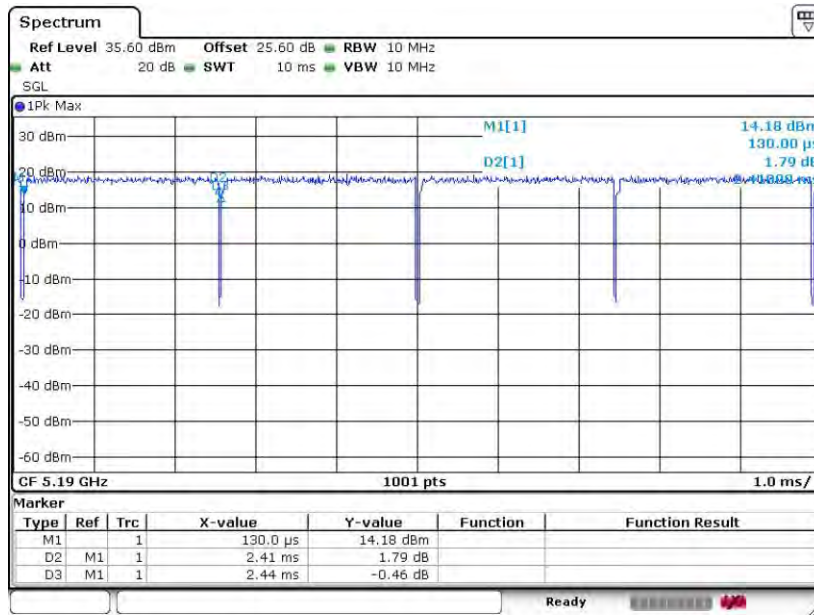

Date: 18.JUN.2019 10:13:03

802.11ac VHT20

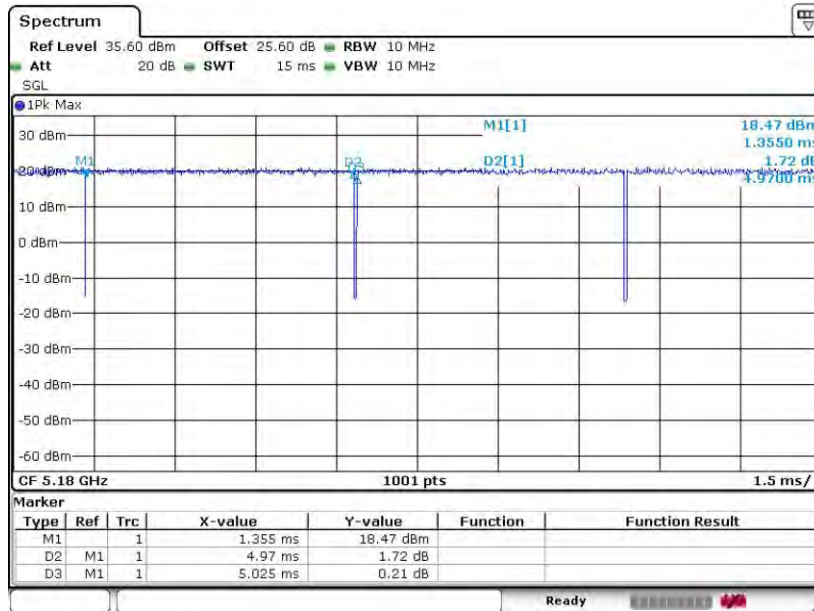

Date: 18.JUN.2019 10:20:09



802.11ac VHT40

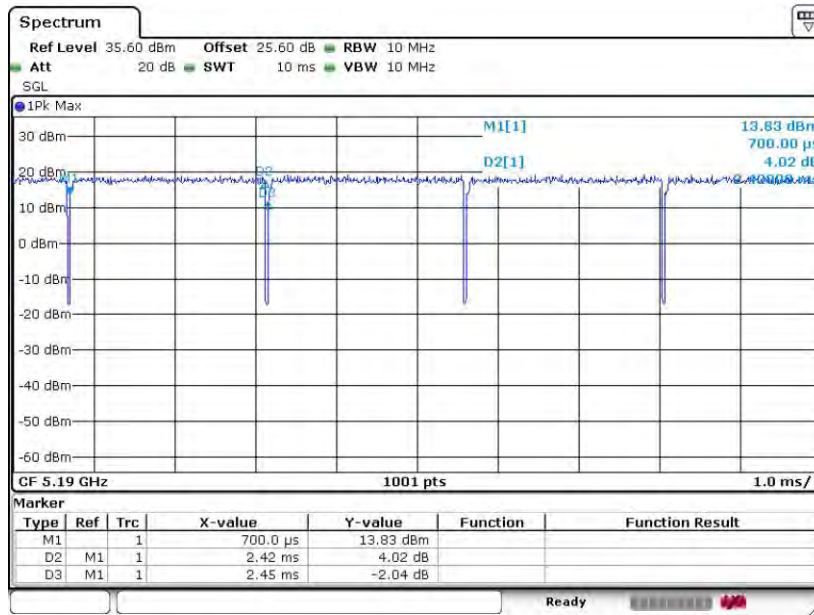

Date: 18.JUN.2019 10:23:39

802.11ac VHT80

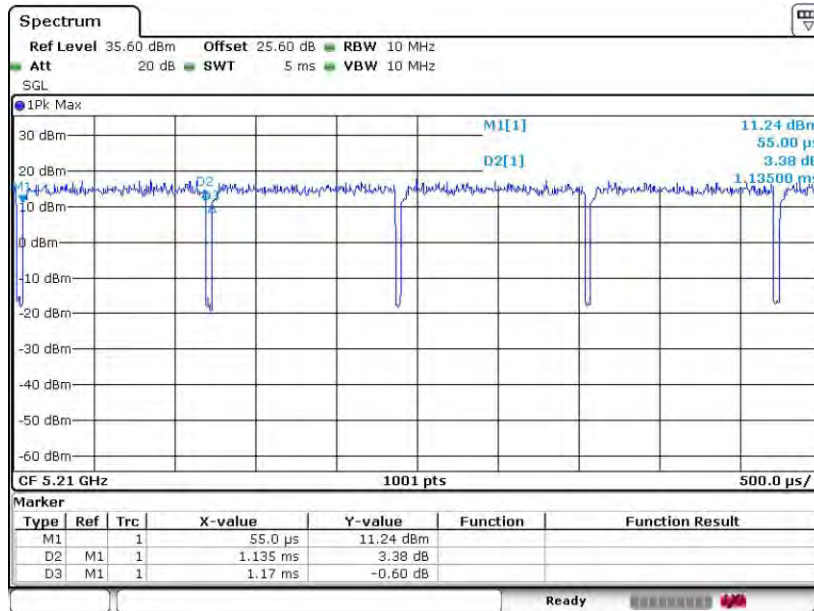

Date: 18.JUN.2019 10:32:21



<Ant. 2>

802.11a

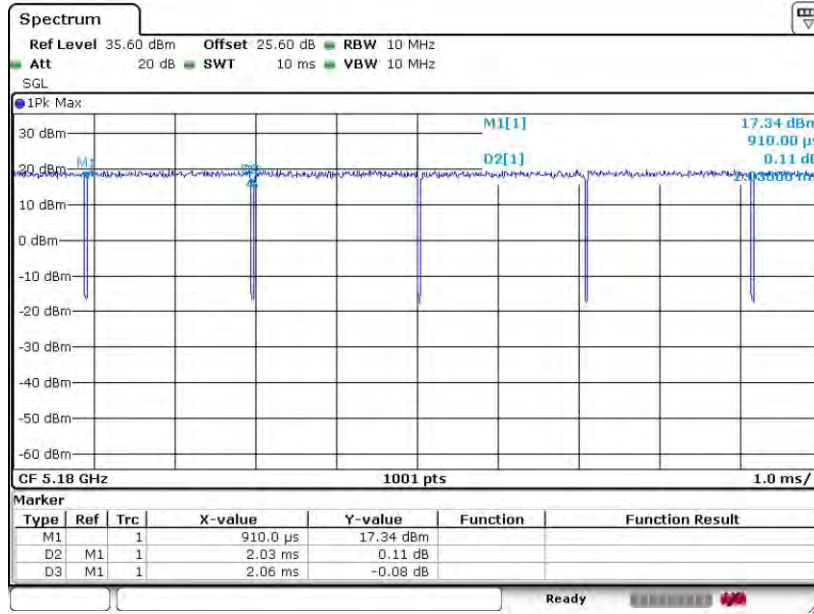

Date: 18.JUN.2019 09:29:55

802.11n HT20

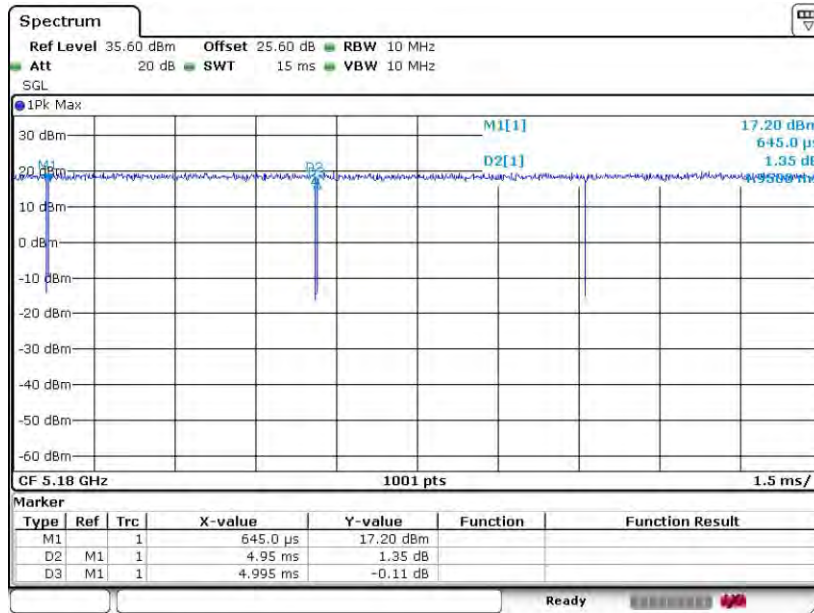

Date: 18.JUN.2019 10:00:47





802.11n HT40

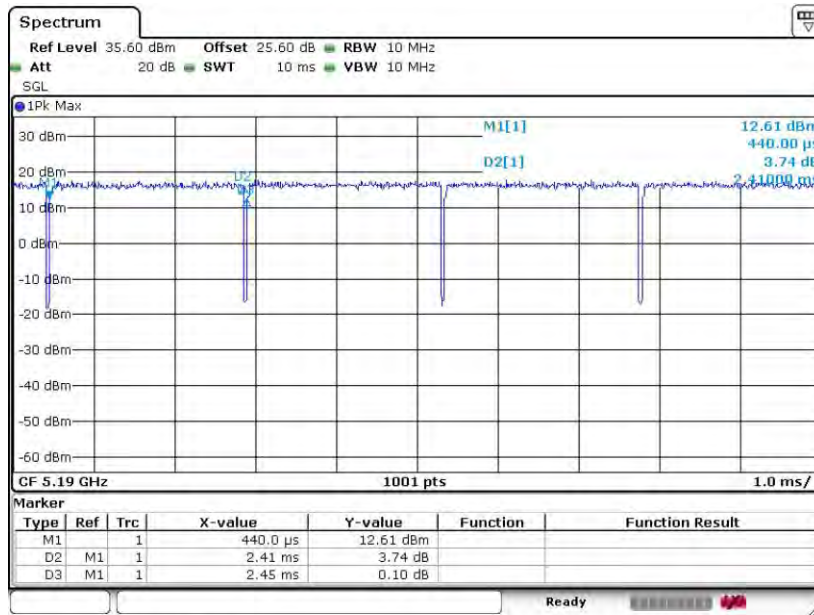

Date: 18.JUN.2019 10:09:46

802.11ac VHT20

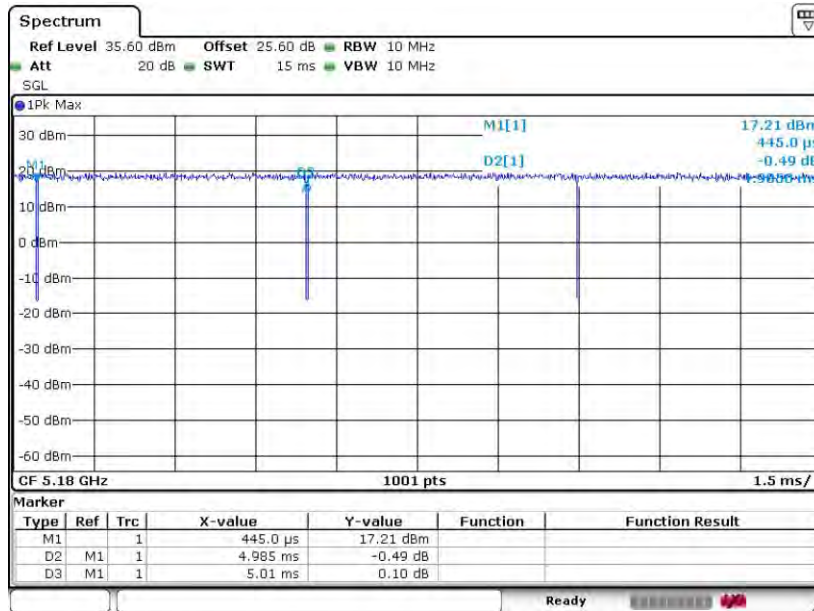

Date: 18.JUN.2019 10:21:31



802.11ac VHT40

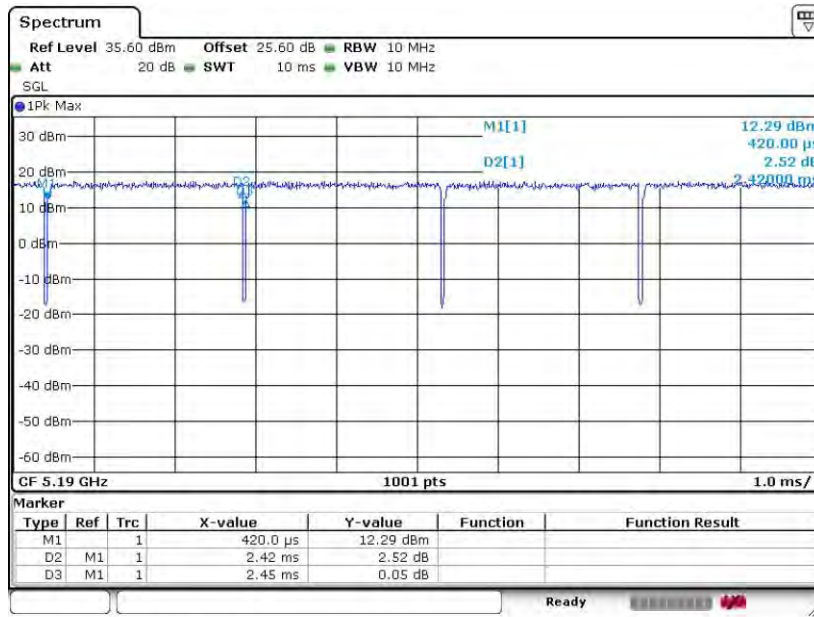

Date: 18.JUN.2019 10:22:49

802.11ac VHT80

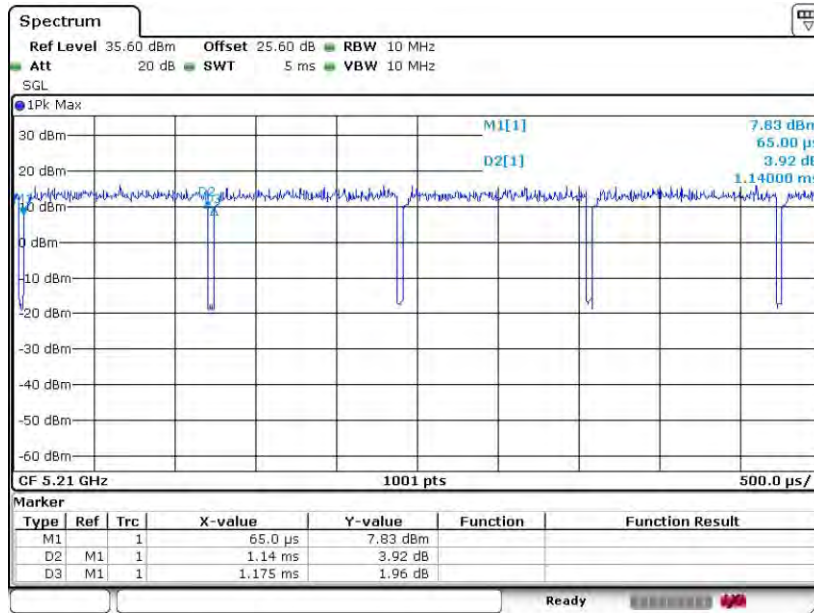

Date: 18.JUN.2019 10:34:42



MIMO <Ant. 1>

802.11a

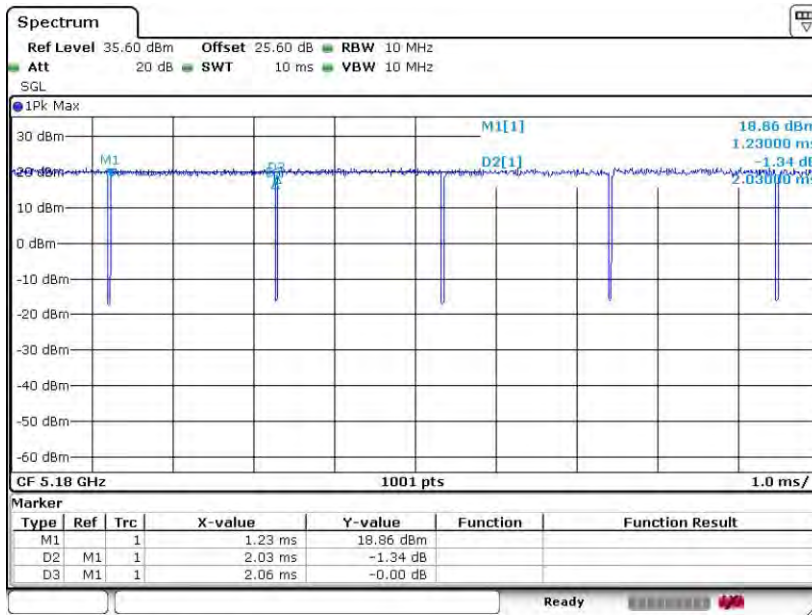

Date: 18.JUN.2019 09:33:29

802.11n HT20

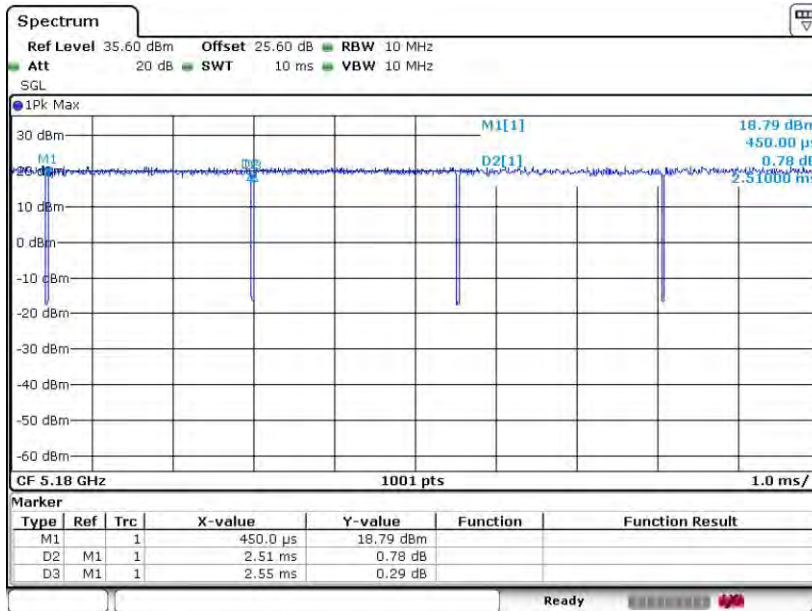

Date: 18.JUN.2019 09:39:11



802.11n HT40

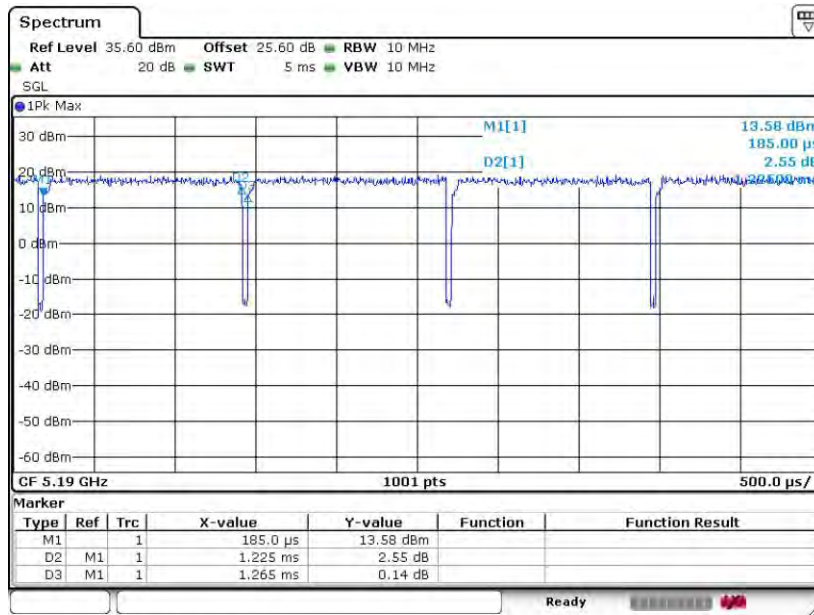

Date: 18.JUN.2019 10:14:19

802.11ac VHT20

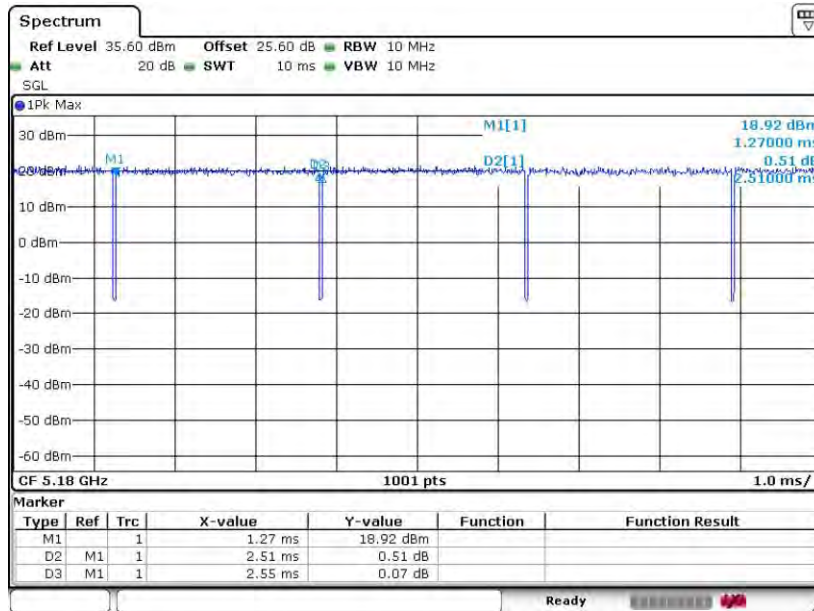

Date: 18.JUN.2019 10:18:36



802.11ac VHT40

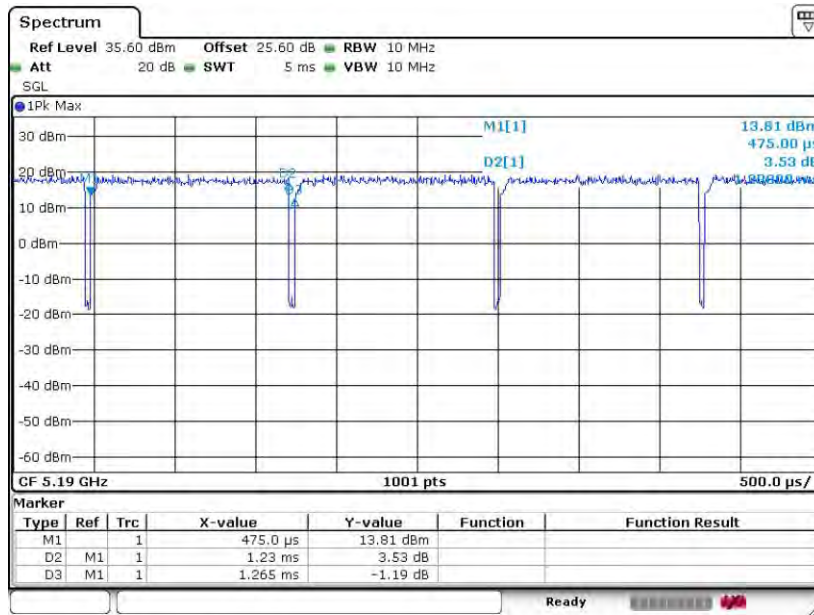

Date: 18.JUN.2019 10:25:03

802.11ac VHT80

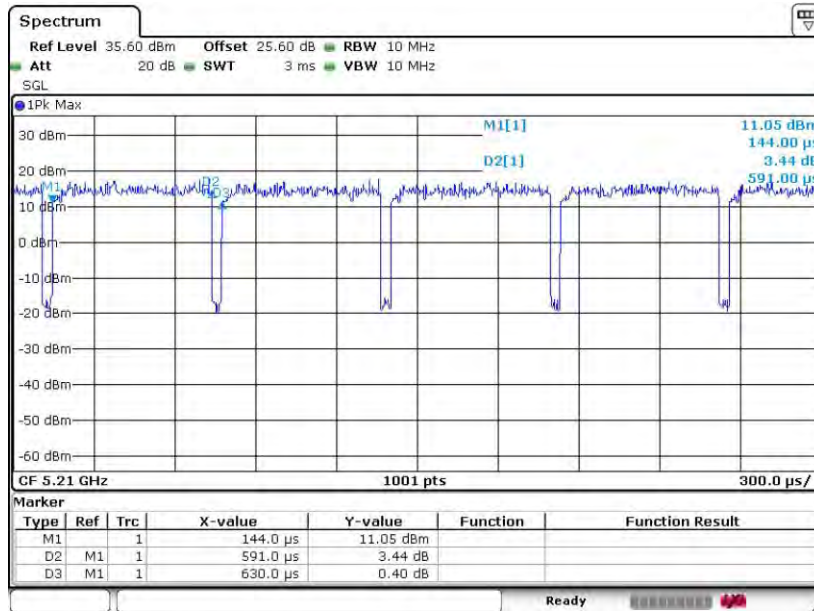

Date: 18.JUN.2019 10:30:06



MIMO <Ant. 2>

802.11a

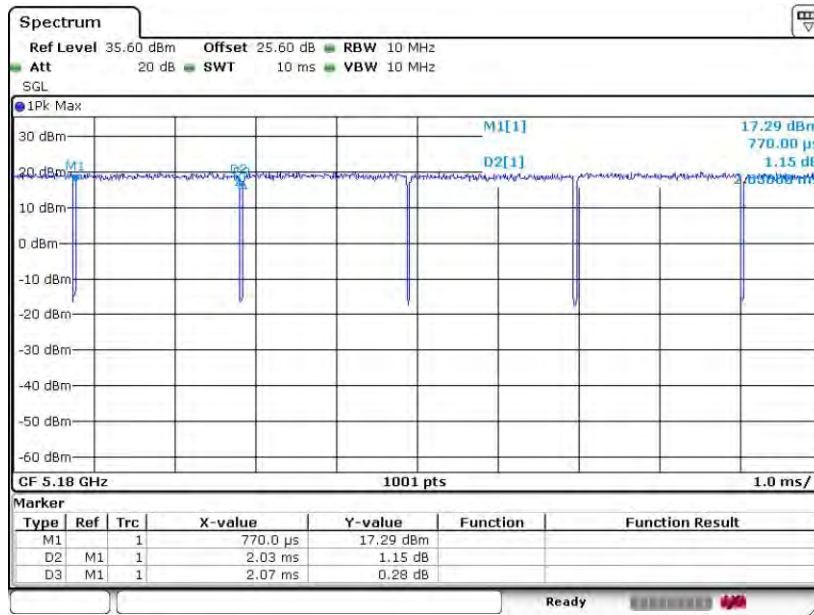

Date: 18.JUN.2019 09:34:48

802.11n HT20

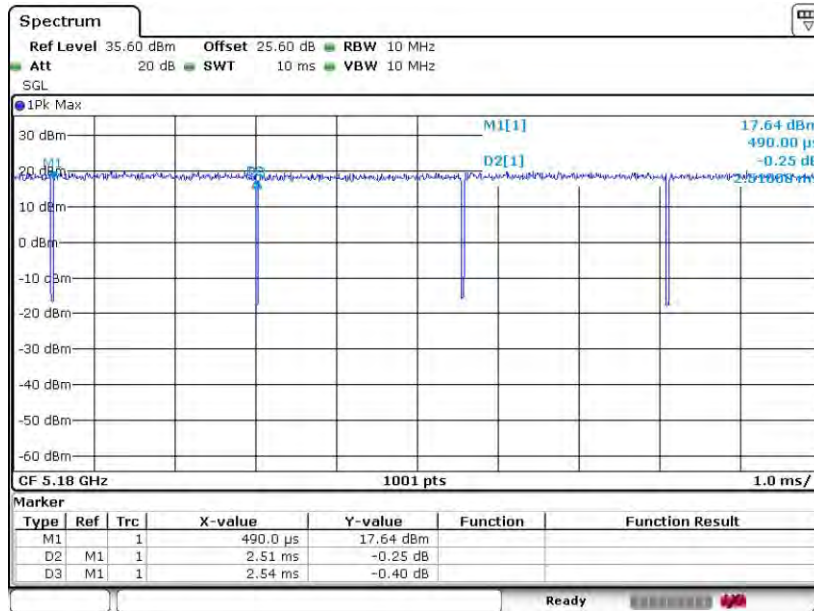

Date: 18.JUN.2019 09:37:51



802.11n HT40

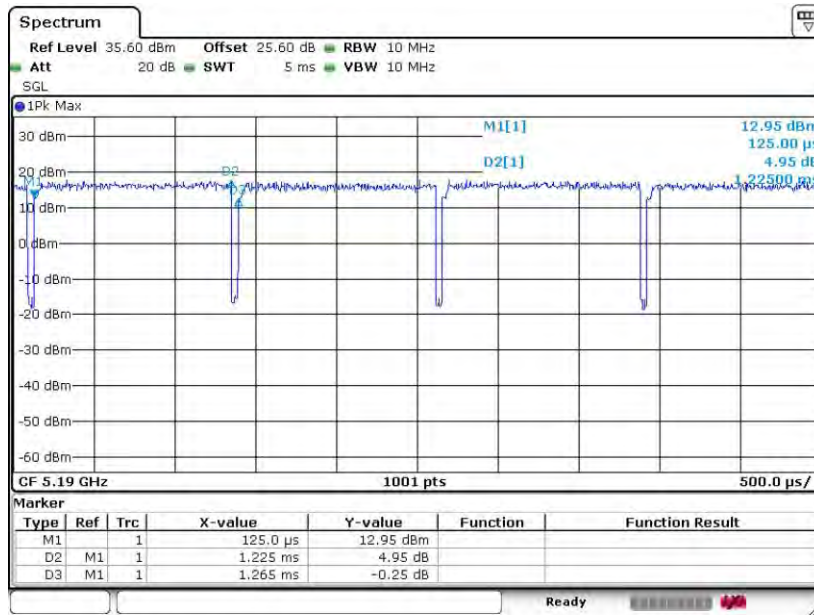

Date: 18.JUN.2019 10:15:11

802.11ac VHT20

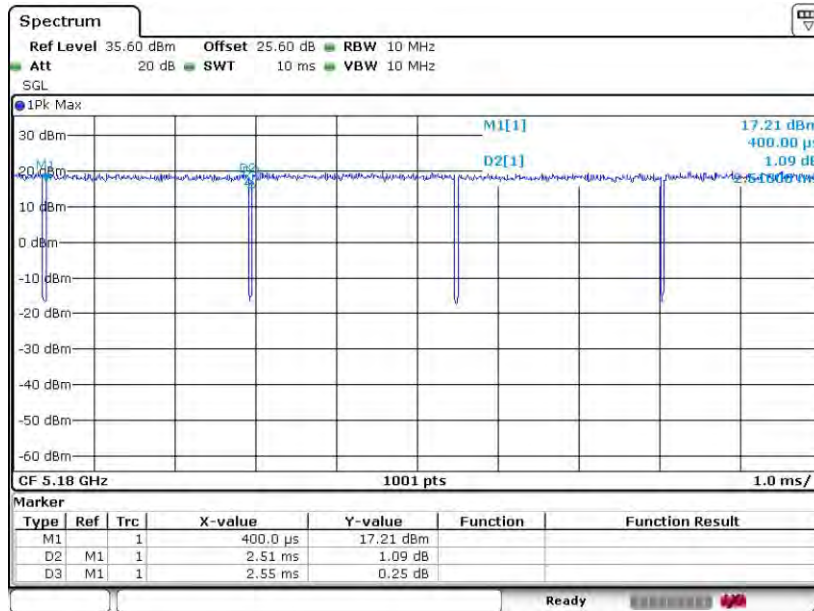

Date: 18.JUN.2019 10:16:50



802.11ac VHT40

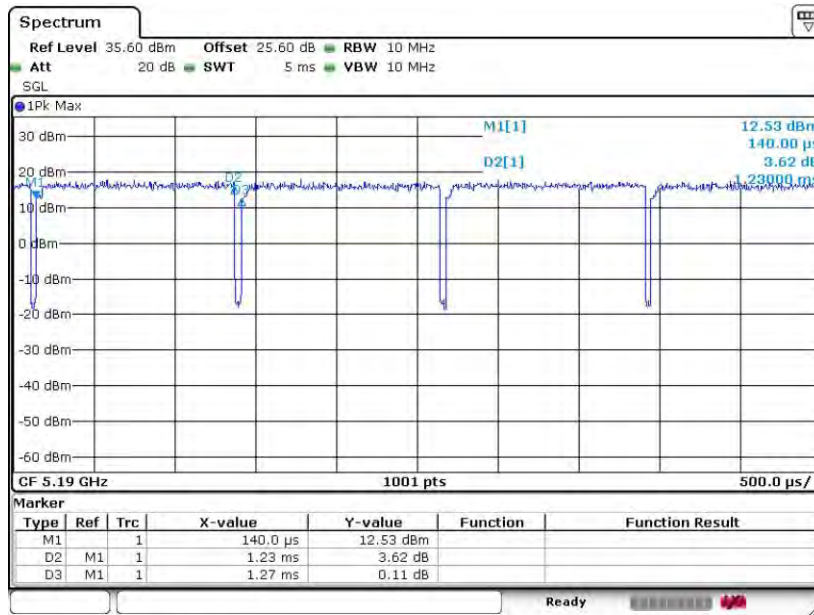

Date: 18.JUN.2019 10:26:40

802.11ac VHT80

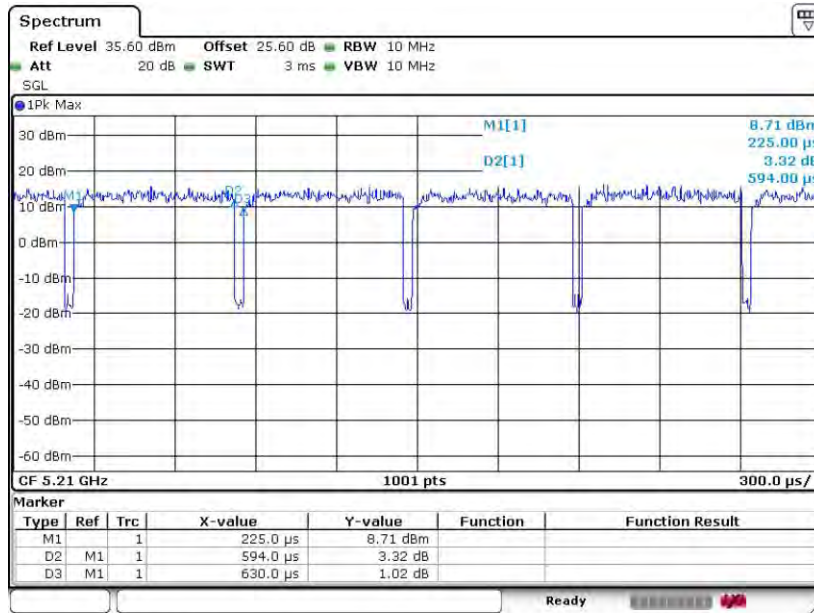

Date: 18.JUN.2019 10:28:31

—THE END—