



CERTIFICATION TEST REPORT

Report Number. : 12132731-E3V1

Applicant : SONY MOBILE COMMUNICATIONS, INC.
4-12-3 HIGASHI-SHINAGAWA,
SHINAGAWA -KU, TOKYO, 140-0002, JAPAN

FCC ID : PY7-68553C

EUT Description : GSM/WCDMA/LTE Phone with BT, DTS/UNII a/b/g/n/ac &
NFC

Test Standard(s) : FCC 47 CFR PART 15 SUBPART C

Date Of Issue:

April 19, 2018

Prepared by:

UL Verification Services Inc.
47173 Benicia Street
Fremont, CA 94538, U.S.A.
TEL: (510) 771-1000
FAX: (510) 661-0888



REPORT REVISION HISTORY

Rev.	Issue Date	Revisions	Revised By
V1	04/19/18	Initial Issue	

TABLE OF CONTENTS

REPORT REVISION HISTORY	2
TABLE OF CONTENTS	3
1. ATTESTATION OF TEST RESULTS	5
2. TEST METHODOLOGY	6
3. FACILITIES AND ACCREDITATION	6
4. CALIBRATION AND UNCERTAINTY	7
4.1. <i>MEASURING INSTRUMENT CALIBRATION</i>	<i>7</i>
4.2. <i>SAMPLE CALCULATION</i>	<i>7</i>
4.3. <i>MEASUREMENT UNCERTAINTY.....</i>	<i>7</i>
5. EQUIPMENT UNDER TEST.....	8
5.1. <i>EUT DESCRIPTION.....</i>	<i>8</i>
5.2. <i>MAXIMUM OUTPUT POWER.....</i>	<i>8</i>
5.3. <i>DESCRIPTION OF AVAILABLE ANTENNAS.....</i>	<i>8</i>
5.4. <i>SOFTWARE AND FIRMWARE.....</i>	<i>8</i>
5.5. <i>WORST-CASE CONFIGURATION AND MODE.....</i>	<i>8</i>
5.6. <i>DESCRIPTION OF TEST SETUP.....</i>	<i>9</i>
6. MEASUREMENT METHOD.....	12
7. TEST AND MEASUREMENT EQUIPMENT	13
8. ANTENNA PORT TEST RESULTS.....	14
8.1. <i>ON TIME AND DUTY CYCLE.....</i>	<i>14</i>
8.2. <i>6 dB BANDWIDTH.....</i>	<i>16</i>
8.2.1. <i>BLE (1Mbps).....</i>	<i>17</i>
8.2.2. <i>BLE (2Mbps).....</i>	<i>18</i>
8.3. <i>OUTPUT POWER.....</i>	<i>19</i>
8.3.1. <i>BLE (1Mbps).....</i>	<i>20</i>
8.3.2. <i>BLE (2Mbps).....</i>	<i>20</i>
8.4. <i>AVERAGE POWER.....</i>	<i>21</i>
8.4.1. <i>BLE (1Mbps).....</i>	<i>21</i>
8.4.2. <i>BLE (2Mbps).....</i>	<i>22</i>
8.5. <i>POWER SPECTRAL DENSITY.....</i>	<i>23</i>
8.5.1. <i>BLE (1Mbps).....</i>	<i>24</i>
8.5.2. <i>BLE (2Mbps).....</i>	<i>25</i>
8.6. <i>CONDUCTED SPURIOUS EMISSIONS.....</i>	<i>26</i>
8.6.1. <i>BLE (1Mbps).....</i>	<i>27</i>

8.6.2.	BLE (2Mbps).....	28
9.	RADIATED TEST RESULTS.....	29
9.1.	LIMITS AND PROCEDURE.....	29
9.2.	TRANSMITTER ABOVE 1 GHz.....	30
9.2.1.	BLE (1Mbps).....	30
9.2.2.	BLE (2Mbps).....	40
9.3.	SPURIOUS EMISSIONS BELOW 30 MHz (WORST-CASE CONFIGURATION).....	50
9.4.	Worst Case Below 1 GHz.....	51
9.5.	Worst Case 18-26 GHz.....	53
10.	AC POWER LINE CONDUCTED EMISSIONS	55
11.	SETUP PHOTOS	58

1. ATTESTATION OF TEST RESULTS

COMPANY NAME: SONY MOBILE COMMUNICATIONS, INC.
4-12-3 HIGASHI-SHINAGAWA,
SHINAGAWA -KU, TOKYO, 140-0002, JAPAN

EUT DESCRIPTION: GSM/WCDMA/LTE Phone with BT, DTS/UNII a/b/g/n/ac &
NFC

SERIAL NUMBER: CB512FH68Z (RADIATED)
CB512FHBUA (CONDUCTED)

DATE TESTED: March 22 –April 06, 2018

APPLICABLE STANDARDS	
STANDARD	TEST RESULTS
CFR 47 Part 15 Subpart C	Complies

UL Verification Services Inc. tested the above equipment in accordance with the requirements set forth in the above standards. All indications of Pass/Fail in this report are opinions expressed by UL Verification Services Inc. based on interpretations and/or observations of test results. Measurement Uncertainties were not taken into account and are published for informational purposes only. The test results show that the equipment tested is capable of demonstrating compliance with the requirements as documented in this report.

Note: The results documented in this report apply only to the tested sample, under the conditions and modes of operation as described herein. This document may not be altered or revised in any way unless done so by UL Verification Services Inc. and all revisions are duly noted in the revisions section. Any alteration of this document not carried out by UL Verification Services Inc. will constitute fraud and shall nullify the document. This report must not be used by the client to claim product certification, approval, or endorsement by NVLAP, NIST, any agency of the Federal Government, or any agency of the U.S. government.

Approved & Released For
UL Verification Services Inc. By:

Reviewed By:



Dan Corona
CONSUMER TECHNOLOGY DIVISION
Operations Leader
UL Verification Services Inc.

Kiya Kedida
CONSUMER TECHNOLOGY DIVISION
Project Engineer
UL Verification Services Inc.

2. TEST METHODOLOGY

The tests documented in this report were performed in accordance with FCC CFR 47 Part 2, FCC CFR 47 Part 15, KDB 558074 D01 v04, ANSI C63.10-2013

3. FACILITIES AND ACCREDITATION

The test sites and measurement facilities used to collect data are located at 47173 and 47266 Benicia Street, Fremont, California, USA. Line conducted emissions are measured only at the 47173 address. The following table identifies which facilities were utilized for radiated emission measurements documented in this report. Specific facilities are also identified in the test results sections.

47173 Benicia Street	47266 Benicia Street
<input checked="" type="checkbox"/> Chamber A (ISED:2324B-1)	<input type="checkbox"/> Chamber D (ISED:22541-1)
<input checked="" type="checkbox"/> Chamber B (ISED:2324B-2)	<input type="checkbox"/> Chamber E (ISED:22541-2)
<input checked="" type="checkbox"/> Chamber C (ISED:2324B-3)	<input type="checkbox"/> Chamber F (ISED:22541-3)
	<input type="checkbox"/> Chamber G (ISED:22541-4)
	<input type="checkbox"/> Chamber H (ISED:22541-5)

The above test sites and facilities are covered under FCC Test Firm Registration # 208313. Chambers A through C are covered under ISED company address code 2324B with site numbers 2324B -1 through 2324B-3, respectively. Chambers D through H are covered under ISED Canada company address code 22541 with site numbers 22541 -1 through 22541-5, respectively.

UL Verification Services Inc. is accredited by NVLAP, Laboratory Code 200065-0. The full scope of accreditation can be viewed at <http://nist.gov/standards/scopes/2000650.htm>.

4. CALIBRATION AND UNCERTAINTY

4.1. MEASURING INSTRUMENT CALIBRATION

The measuring equipment utilized to perform the tests documented in this report has been calibrated in accordance with the manufacturer's recommendations, and is traceable to recognized national standards.

4.2. SAMPLE CALCULATION

Where relevant, the following sample calculation is provided:

$$\begin{aligned} \text{Field Strength (dBuV/m)} &= \text{Measured Voltage (dBuV)} + \text{Antenna Factor (dB/m)} + \\ &\text{Cable Loss (dB)} - \text{Preamp Gain (dB)} \\ 36.5 \text{ dBuV} + 18.7 \text{ dB/m} + 0.6 \text{ dB} - 26.9 \text{ dB} &= 28.9 \text{ dBuV/m} \end{aligned}$$

4.3. MEASUREMENT UNCERTAINTY

Where relevant, the following measurement uncertainty levels have been estimated for tests performed on the apparatus:

PARAMETER	UNCERTAINTY
Worst Case Conducted Disturbance, 9KHz to 0.15 MHz	3.84 dB
Worst Case Conducted Disturbance, 0.15 to 30 MHz	3.65 dB
Worst Case Radiated Disturbance, 9KHz to 30 MHz	3.15 dB
Worst Case Radiated Disturbance, 30 to 1000 MHz	5.36 dB
Worst Case Radiated Disturbance, 1000 to 18000 MHz	4.32 dB
Worst Case Radiated Disturbance, 18000 to 26000 MHz	4.45 dB
Worst Case Radiated Disturbance, 26000 to 40000 MHz	5.24 dB

Uncertainty figures are valid to a confidence level of 95%.

5. EQUIPMENT UNDER TEST

5.1. EUT DESCRIPTION

The EUT is a GSM/WCDMA/LTE Phone with BT, DTS/UNII a/b/g/n/ac & NFC.

5.2. MAXIMUM OUTPUT POWER

The transmitter has a maximum peak conducted output power as follows:

Frequency Range (MHz)	Mode	Output Power (dBm)	Output Power (mW)
2402 - 2480	BLE (1 Mbps)	5.26	3.36
2402 - 2480	BLE (2 Mbps)	5.28	3.37

5.3. DESCRIPTION OF AVAILABLE ANTENNAS

The radio utilizes Loop Type antenna, with the following maximum gain:

Frequency Band (GHz)	Antenna Gain (dBi)
2402-2480	-1.20

5.4. SOFTWARE AND FIRMWARE

The firmware installed in the EUT during testing was s_atp_XXX_0_00403_A_9.
The test utility software used during testing was Tera Term Ver 4.79.

5.5. WORST-CASE CONFIGURATION AND MODE

Radiated emissions below 30MHz, below 1GHz and above 18GHz, and AC power line conducted emission were performed with the EUT set to transmit at the channel with highest output power as worst-case scenario.

Band edge and radiated emissions between 1GHz and 18GHz were performed with the EUT set to transmit at the highest power on low, middle and high channels.

The fundamental of the EUT was investigated in three orthogonal orientations X, Y, & Z, and it was determined that X-Axis with AC/DC Adapter was worst-case orientation; therefore, all final radiated testing was performed with the EUT in X-Axis with AC/DC Adapter orientation.

5.6. DESCRIPTION OF TEST SETUP

SUPPORT EQUIPMENT

Support Equipment List				
Description	Manufacturer	Model	Serial Number	FCC ID
Laptop	Lenovo	20B7S0A200	PC015REW	NA
AC Adapter	SONY	UCH12	4016W40310044	NA
DC Power Supply	Ametek	XT 15-4	T463	N/A

I/O CABLES (CONDUCTED TEST)

I/O Cable List						
Cable No	Port	# of identical ports	Connector Type	Cable Type	Cable Length (m)	Remarks
1	Antenna	1	RF	Shielded	0.2	To spectrum Analyzer
2	USB	1	USB	Shielded	1	N/A
3	DC	1	DC	Shielded	0.3	N/A

I/O CABLES (RADIATED AND CONDUCTED EMISSIONS)

I/O Cable List						
Cable No	Port	# of identical ports	Connector Type	Cable Type	Cable Length (m)	Remarks
1	USB	1	USB	Shielded	3	N/A

TEST SETUP

CONDUCTED TEST SETUP DIAGRAM

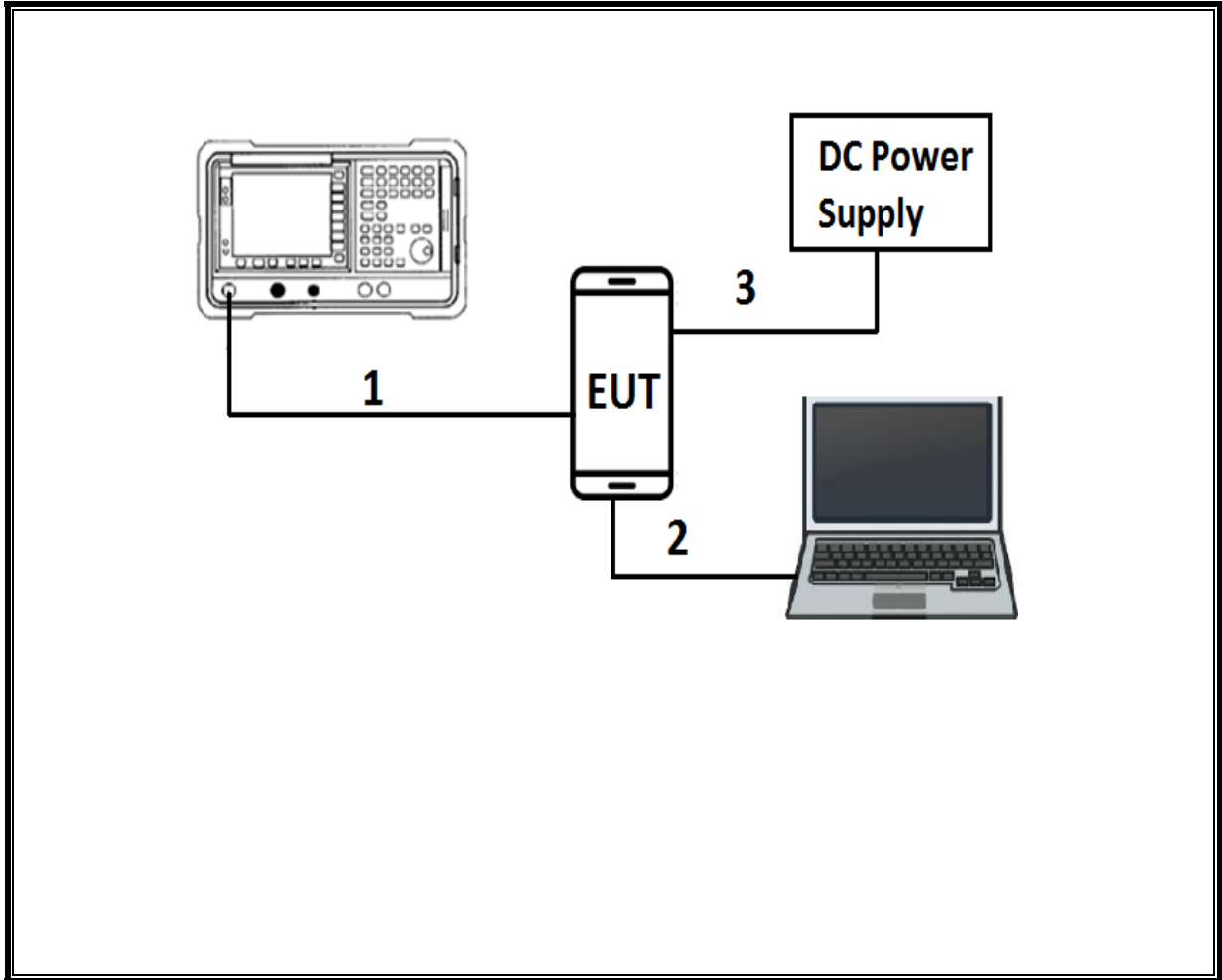

TEST SETUP

RADIATED AND AC LINE CONDUCTED EMISSIONS SETUP DIAGRAM

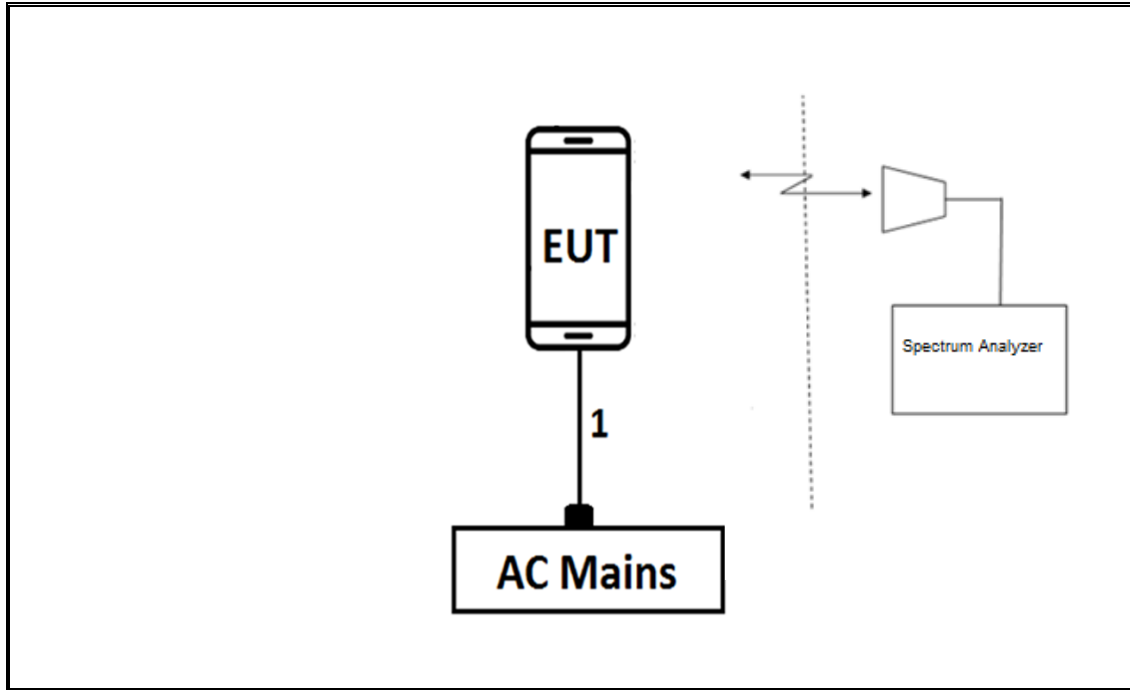

6. MEASUREMENT METHOD

On Time and Duty Cycle: KDB 558074 D01 v04, Section 6.

6 dB BW: KDB 558074 D01 v04, Section 8.1.

Output Power: KDB 558074 D01 v04, Section 9.1.3.

Power Spectral Density: KDB 558074 D01 v04, Section 10.2.

Out-of-band emissions in non-restricted bands: KDB 558074 D01 v04, Section 11.0.

Out-of-band emissions in restricted bands: KDB 558074 D01 v04, Section 12.1.

Band-edge: KDB 558074 D01 v04, Section 12.1.

AC Power Line Conducted Emissions: ANSI C63.10-2013, Section 6.2.

7. TEST AND MEASUREMENT EQUIPMENT

The following test and measurement equipment was utilized for the tests documented in this report:

TEST EQUIPMENT LIST				
Description	Manufacturer	Model	Asset	Cal Due
Amplifier, 10KHz to 1GHz, 32dB	Agilent (Keysight) Technologies	8447D	T15	08/14/2018
Amplifier, 1 - 18GHz	MITEQ	AFS42-00101800-25-S-42	T931	09/20/2018
Amplifier, 1 to 18GHz	Miteq	AFS42-00101800-25-S-42	T493	04/03/2019
RF Preamplifier, 1 - 26GHz	Agilent	8449B	T404	07/23/2018
Antenna, Active Loop 9kHz-30MHz	Com-Power Corp.	AL-130R	T1866	10/10/2018
Antenna, Broadband Hybrid, 30MHz to 2000MHz	Sunol Sciences Corp.	JB3	T130	06/15/2018
Antenna, Horn 1-18GHz	ETS-Lindgren	3117	T120	06/26/2018
Antenna, Horn 1-18GHz	ETS-Lindgren	3117	T863	06/09/2018
Antenna Horn, 18 to 26GHz	ARA	MWH-1826	T89	01/18/2019
Power Meter, P-series single channel	Keysight	N1912A	T1245	05/12/2018
Power Sensor	Keysight	N1921A	T413	06/22/2018
Spectrum Analyzer, PXA, 3Hz to 44GHz	Agilent (Keysight) Technologies	N9030A	T1466	04/11/2018
Spectrum Analyzer, PXA, 3Hz to 44GHz	Agilent (Keysight) Technologies	N9030A	T1454	01/08/2019
Spectrum Analyzer, PXA, 3Hz to 44GHz	Agilent (Keysight) Technologies	N9030A	T1113	12/21/2018
Spectrum Analyzer, PXA, 3Hz to 44GHz	Agilent (Keysight) Technologies	N9030A	T1450	02/05/2019
AC Line Conducted				
EMI Test Receiver 9KHz-7GHz	Rohde & Schwarz	ESC17	T1124	11/07/2018
LISN for Conducted Emissions CISPR-16	Fischer	50/250-25-2-01	T1310	06/15/2018
Power Cable, Line Conducted Emissions	UL	PG1	T861	08/31/2018
UL AUTOMATION SOFTWARE				
Radiated Software	UL	UL EMC	Ver 9.5, Dec 01, 2016	
Antenna Port Software	UL	UL EMC	Ver 8.2, Feb 28, 2018	
AC Line Conducted Software	UL	UL EMC	Ver 9.5, May 26, 2015	

NOTES:

1. Equipment listed above that calibrated during the testing period was set for test after the calibration.
2. Equipment listed above that has a calibration due date during the testing period, the testing is completed before equipment expiration date.

8. ANTENNA PORT TEST RESULTS

8.1. ON TIME AND DUTY CYCLE

LIMITS

None; for reporting purposes only.

PROCEDURE

KDB 558074 Zero-Span Spectrum Analyzer Method.

ON TIME AND DUTY CYCLE RESULTS

Mode	ON Time B (msec)	Period (msec)	Duty Cycle x (linear)	Duty Cycle (%)	Duty Cycle Correction Factor (dB)	1/B Minimum VBW (kHz)
BLE 1Mbps	2.137	2.507	0.852	85.24%	0.69	0.468
BLE 2Mbps	1.074	1.872	0.574	57.37%	2.41	0.931

DUTY CYCLE PLOTS

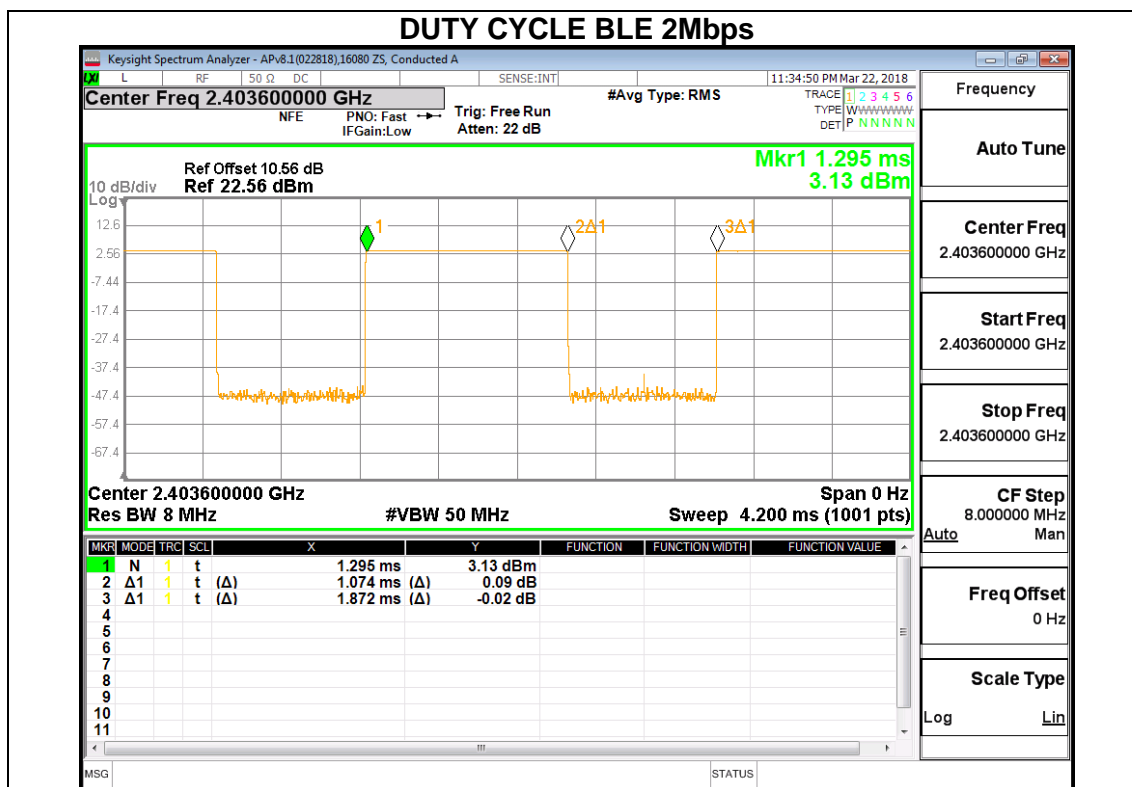
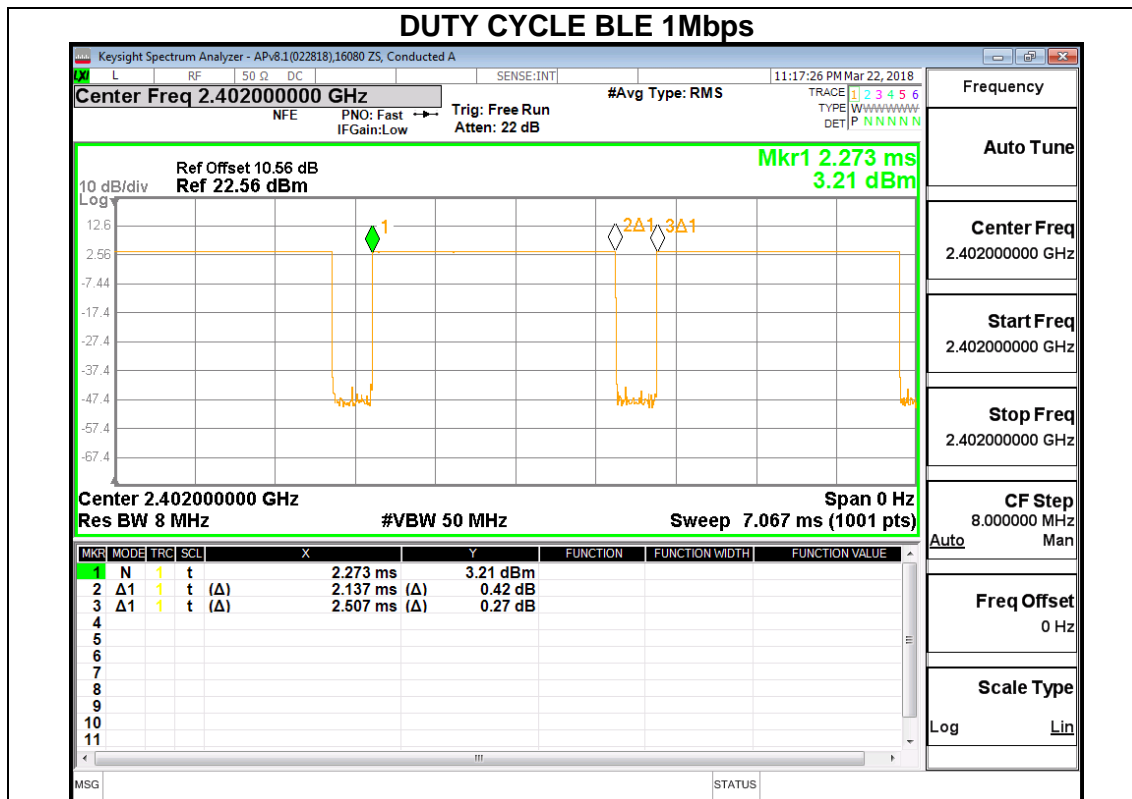

8.2. 6 dB BANDWIDTH

LIMITS

FCC §15.247 (a) (2)

The minimum 6 dB bandwidth shall be at least 500 kHz.

TEST PROCEDURE

The transmitter output is connected to a power meter. The cable assembly insertion loss was entered as an offset in the power meter to allow for a gated peak reading of power.

RESULTS

8.2.1. BLE (1Mbps)

Channel	Frequency (MHz)	6 dB Bandwidth (MHz)	Minimum Limit (MHz)
Low	2402	0.6780	0.5
Middle	2440	0.6870	0.5
High	2480	0.6720	0.5

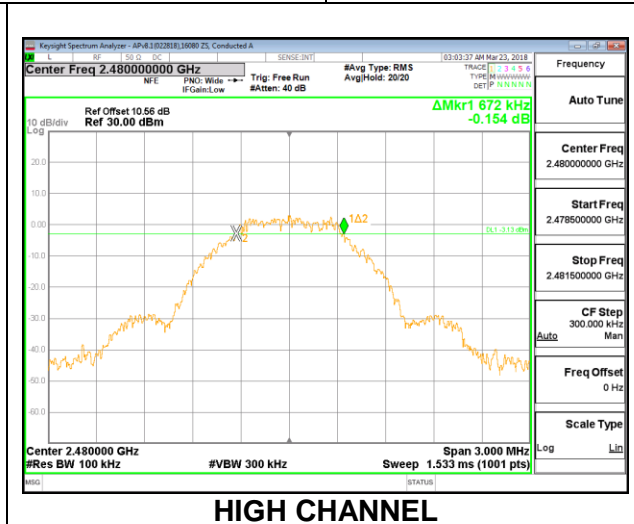
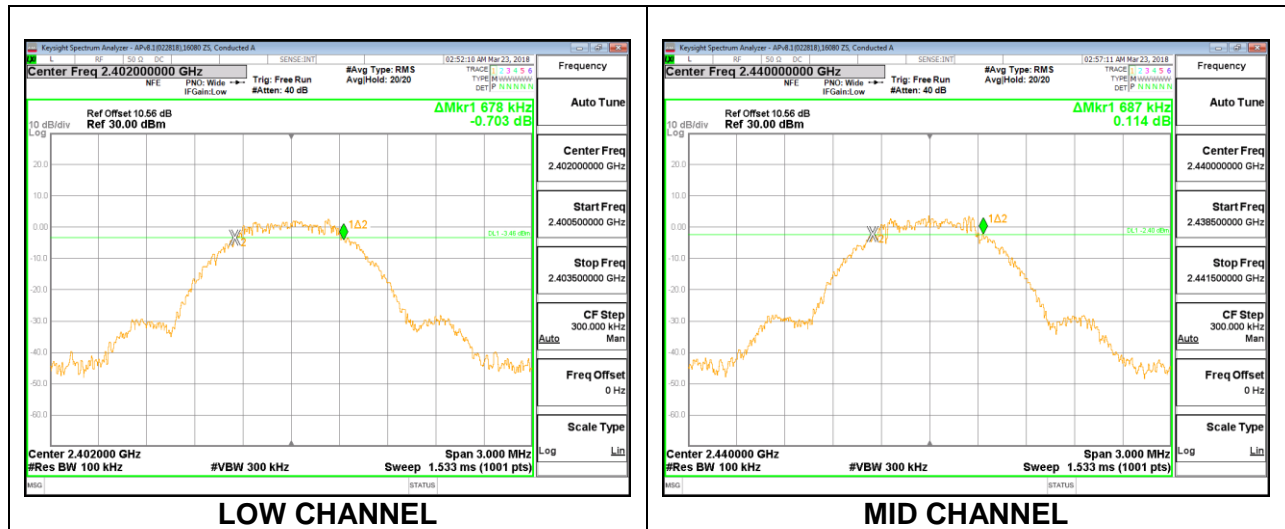

8.2.2. BLE (2Mbps)

Channel	Frequency (MHz)	6 dB Bandwidth (MHz)	Minimum Limit (MHz)
Low	2402	1.0950	0.5
Middle	2440	1.1370	0.5
High	2480	1.2210	0.5

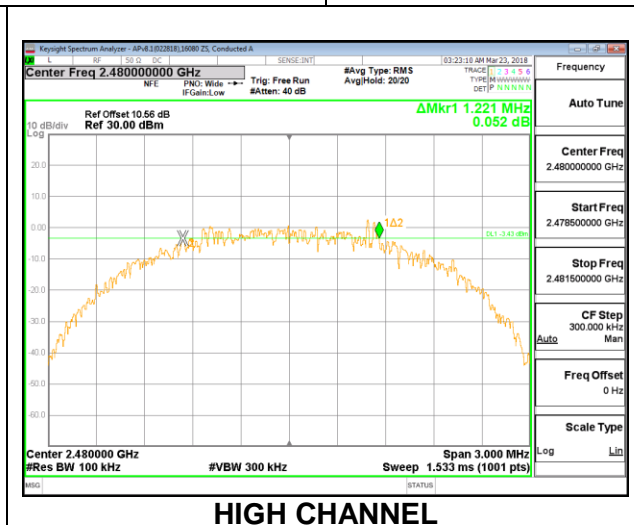
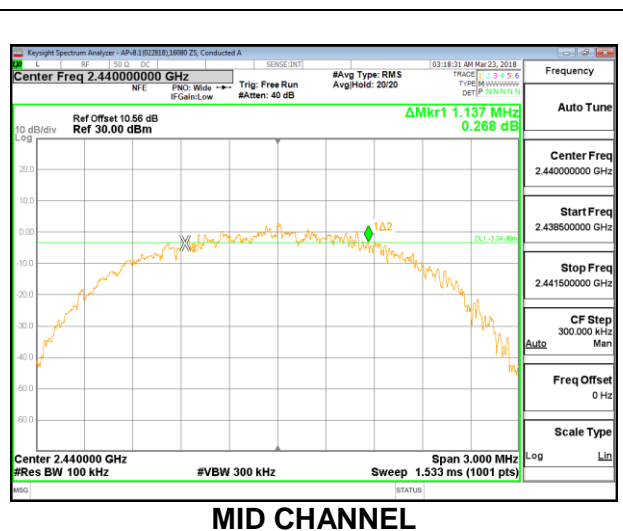
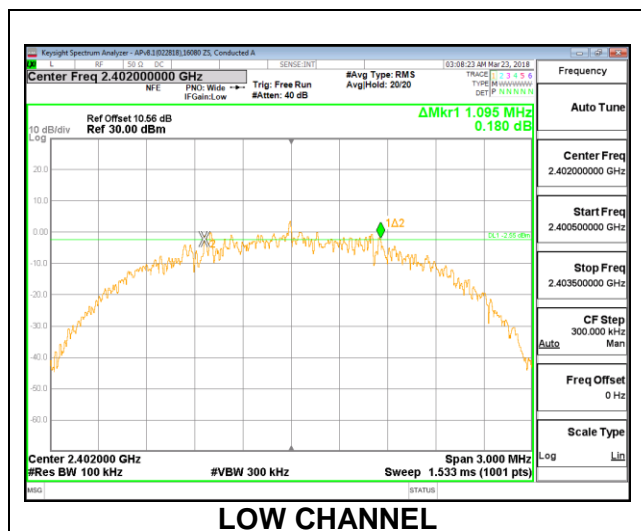

8.3. OUTPUT POWER

LIMITS

FCC §15.247 (b) (3)

The maximum antenna gain is less than or equal to 6 dBi, therefore the limit is 30 dBm.

TEST PROCEDURE

The transmitter output is connected to a power meter. The cable assembly insertion loss was entered as an offset in the power meter to allow for a gated peak reading of power.

RESULTS

8.3.1. BLE (1Mbps)

Tested By:	16080 ZS
Date:	4/2/2018

Channel	Frequency (MHz)	Peak Power Reading (dBm)	Limit (dBm)	Margin (dB)
Low	2402	4.49	30	-25.51
Middle	2440	5.26	30	-24.74
High	2480	4.99	30	-25.01

8.3.2. BLE (2Mbps)

Tested By:	16080 ZS
Date:	4/2/2018

Channel	Frequency (MHz)	Peak Power Reading (dBm)	Limit (dBm)	Margin (dB)
Low	2402	4.81	30	-25.19
Middle	2440	5.28	30	-24.72
High	2480	5.03	30	-24.97

8.4. AVERAGE POWER

LIMITS

None; for reporting purposes only.

TEST PROCEDURE

The transmitter output is connected to a power meter. The cable assembly insertion loss was entered as an offset in the power meter to allow for a gated Average reading of power.

RESULTS

8.4.1. BLE (1Mbps)

Tested By:	16080 ZS
Date:	4/2/2018

Channel	Frequency (MHz)	AV power (dBm)
Low	2402	3.50
Middle	2440	4.65
High	2480	4.13

8.4.2. BLE (2Mbps)

Tested By:	16080 ZS
Date:	4/2/2018

Channel	Frequency (MHz)	AV power (dBm)
Low	2402	3.52
Middle	2440	4.10
High	2480	4.12

8.5. POWER SPECTRAL DENSITY

LIMITS

FCC §15.247 (e)

The power spectral density conducted from the transmitter to the antenna shall not be greater than 8 dBm in any 3 kHz band during any time interval of continuous transmission.

RESULTS

8.5.1. BLE (1Mbps)

Channel	Frequency (MHz)	PSD (dBm/3kHz)	Limit (dBm/3kHz)	Margin (dB)
Low	2402	-12.36	8	-20.36
Middle	2440	-11.03	8	-19.03
High	2480	-11.69	8	-19.69

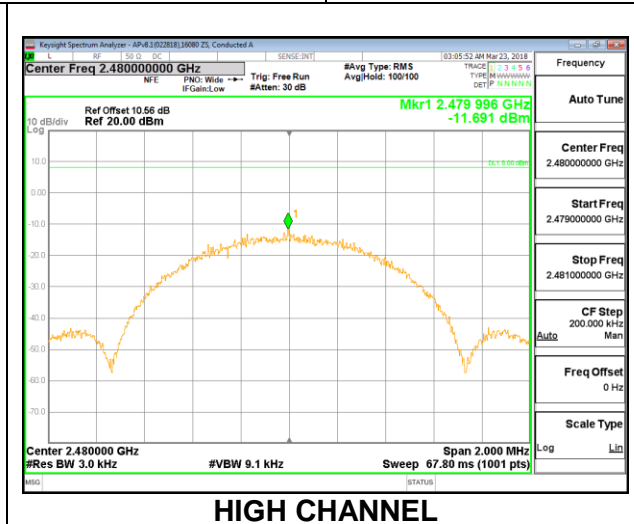
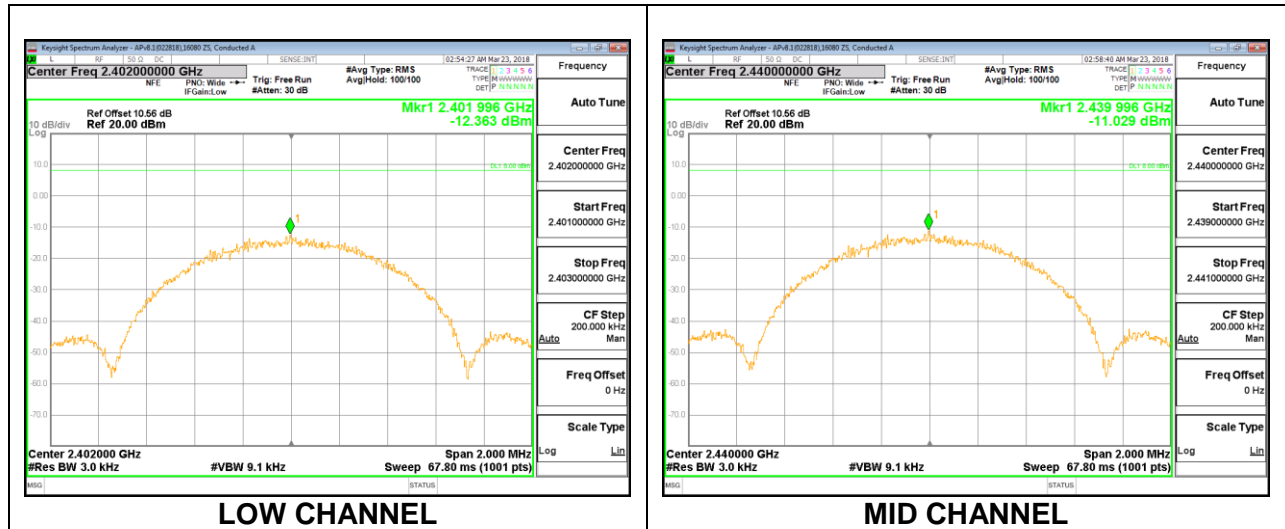

8.5.2. BLE (2Mbps)

Channel	Frequency (MHz)	PSD (dBm/3kHz)	Limit (dBm/3kHz)	Margin (dB)
Low	2402	-15.53	8	-23.53
Middle	2440	-14.42	8	-22.42
High	2480	-15.10	8	-23.10

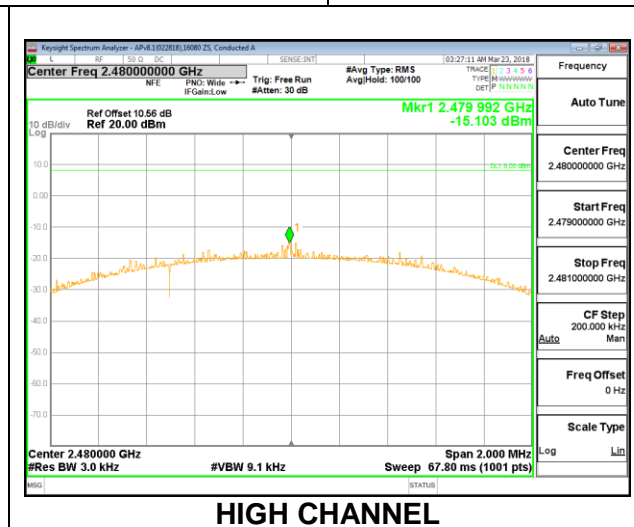
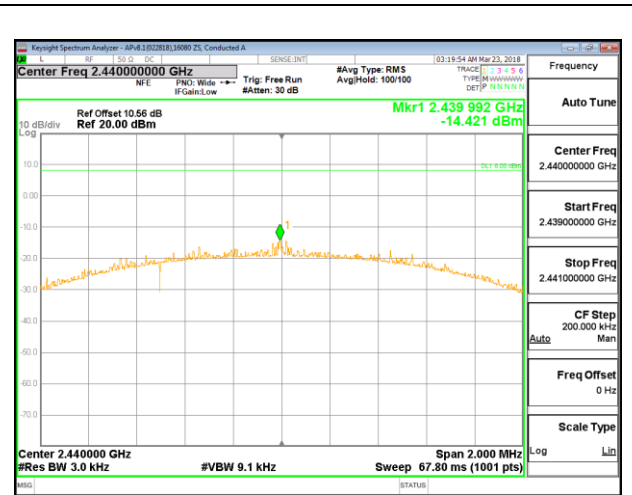
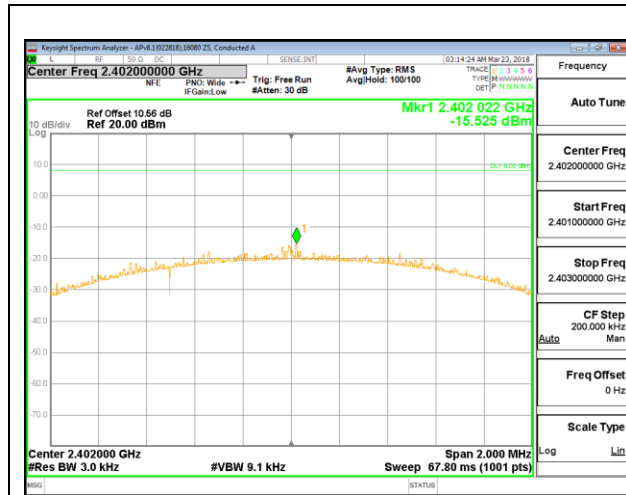

8.6. CONDUCTED SPURIOUS EMISSIONS

LIMITS

FCC §15.247 (d)

Output power was measured based on the use of a peak measurement, therefore the required attenuation is 20 dB.

TEST PROCEDURE

The transmitter output is connected to a spectrum analyzer. The resolution bandwidth is set to 100 kHz. The video bandwidth is set to 300 kHz.

The spectrum from 30 MHz to 26 GHz is investigated with the transmitter set to the lowest, middle, and highest channels.

RESULTS

8.6.1. BLE (1Mbps)

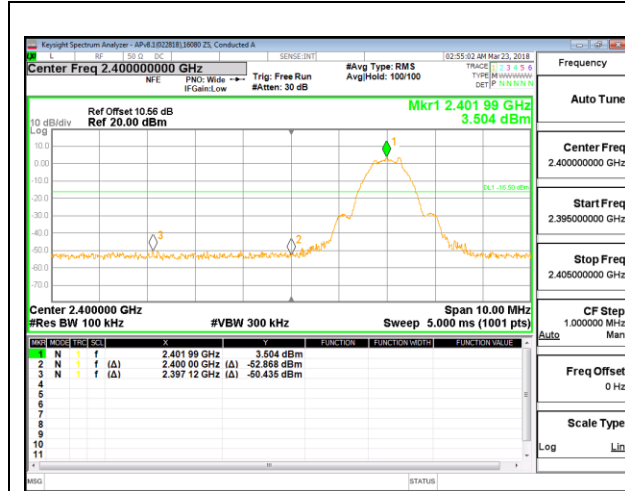

LOW CHANNEL BANDEDGE

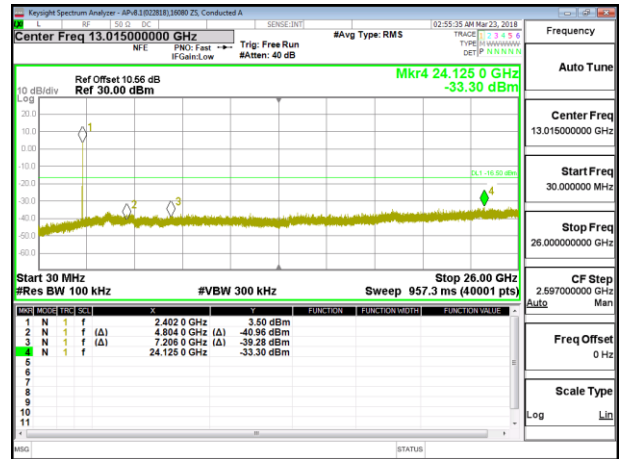

LOW CHANNEL BANDEDGE

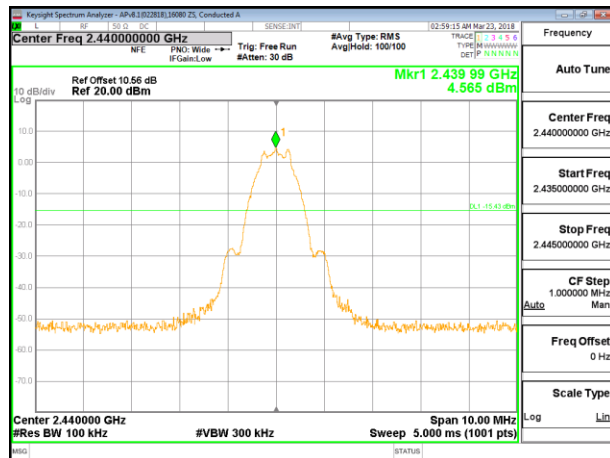

IN-BAND REFERENCE LEVEL

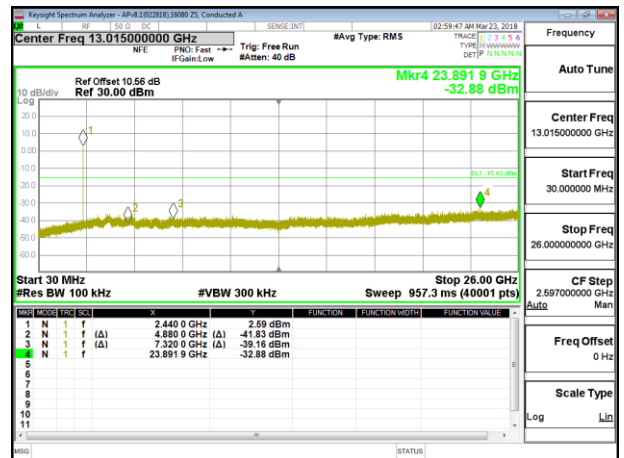

OUT-OF-BAND MID CHANNEL

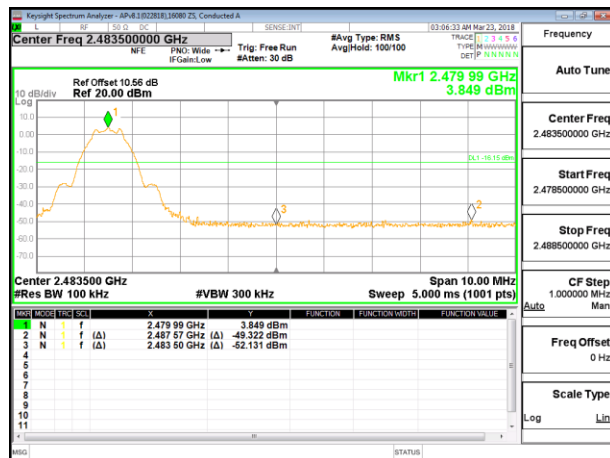

HIGH CHANNEL BANDEDGE

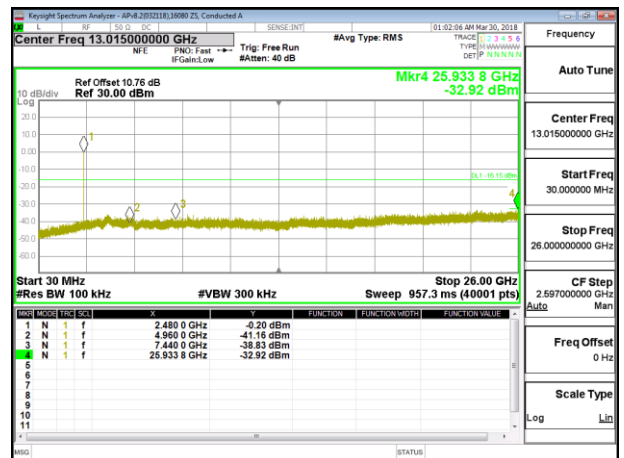

HIGH CHANNEL BANDEDGE

8.6.2. BLE (2Mbps)

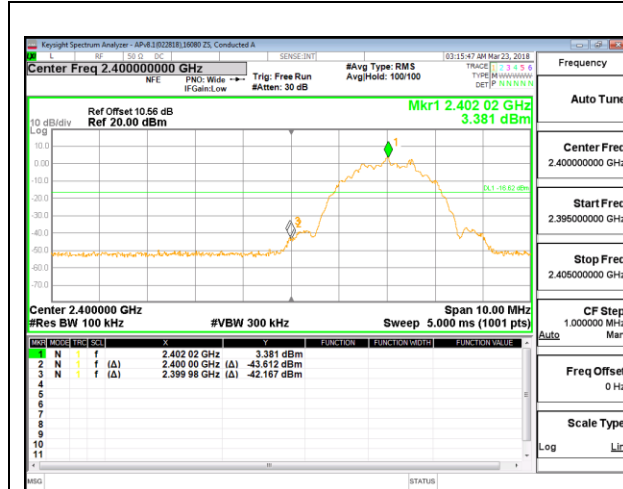

LOW CHANNEL BANDEDGE

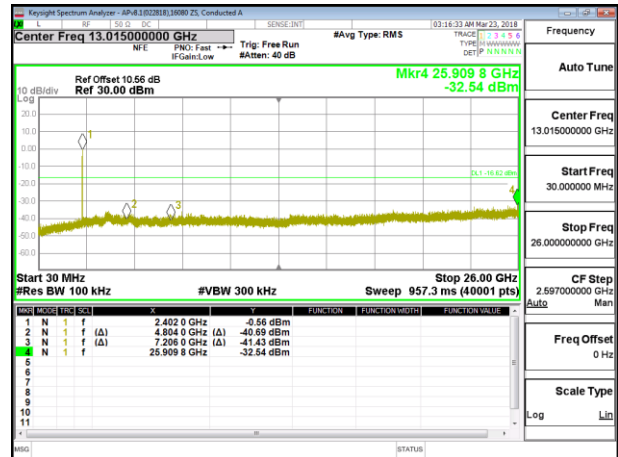

LOW CHANNEL BANDEDGE

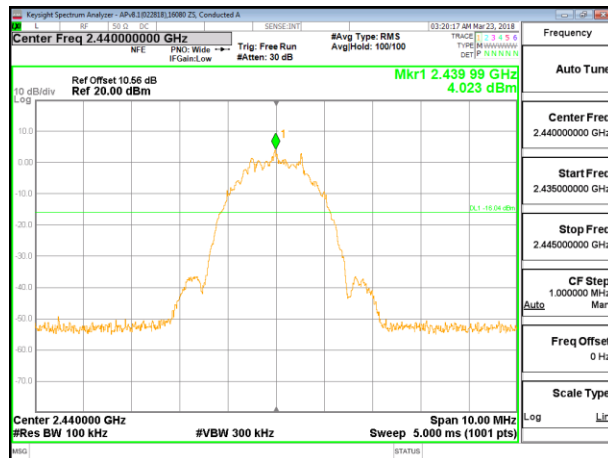

IN-BAND REFERENCE LEVEL

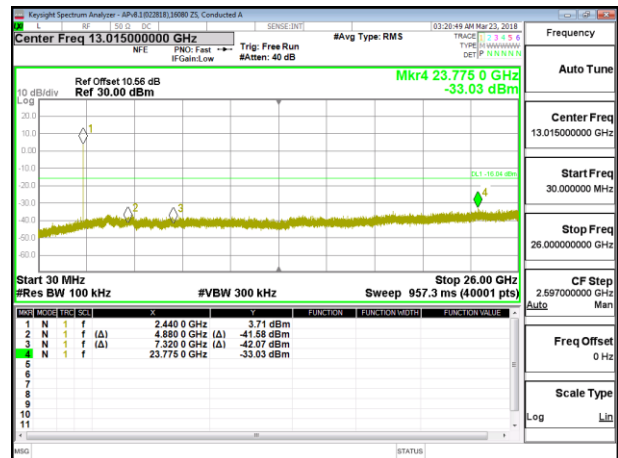

OUT-OF-BAND MID CHANNEL

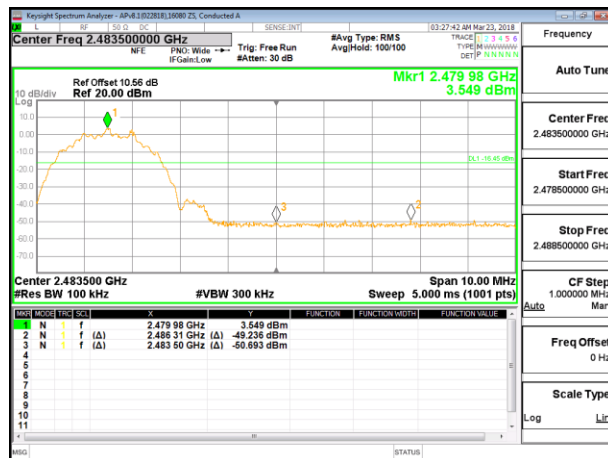

HIGH CHANNEL BANDEDGE

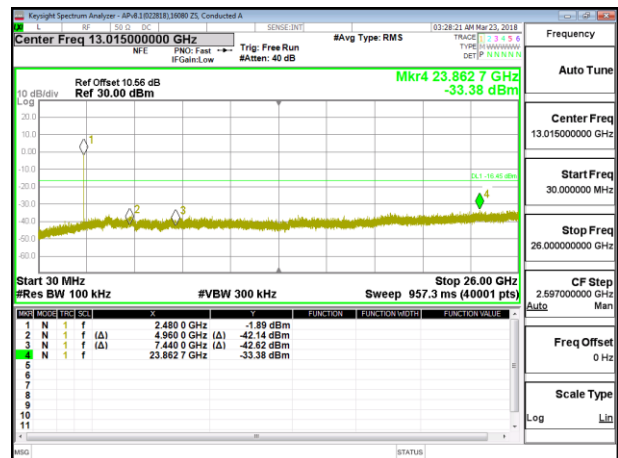

HIGH CHANNEL BANDEDGE

9. RADIATED TEST RESULTS

9.1. LIMITS AND PROCEDURE

LIMITS

FCC §15.205 and §15.209

Frequency Range (MHz)	Field Strength Limit (uV/m) at 3 m	Field Strength Limit (dBuV/m) at 3 m
0.009-0.490	2400/F(kHz) @ 300 m	-
0.490-1.705	24000/F(kHz) @ 30 m	-
1.705 - 30	30 @ 30m	-
30 - 88	100	40
88 - 216	150	43.5
216 - 960	200	46
Above 960	500	54

TEST PROCEDURE

The EUT is placed on a non-conducting table 80 cm above the ground plane for measurement below 1GHz; 1.5 m above the ground plane for measurement above 1GHz. The antenna to EUT distance is 3 meters. The EUT is configured in accordance with ANSI C63.10. The EUT is set to transmit in a continuous mode.

For measurements below 1 GHz the resolution bandwidth is set to 100 kHz for peak detection measurements or 120 kHz for quasi-peak detection measurements. Peak detection is used unless otherwise noted as quasi-peak.

For pre-scans above 1 GHz the resolution bandwidth is set to 1 MHz; the video bandwidth is set to 30 KHz for peak measurements.

For final measurements above 1 GHz the resolution bandwidth is set to 1 MHz; the video bandwidth is set to 3 MHz for peak measurements and as applicable for average measurements.

The spectrum from 1 GHz to 18 GHz is investigated with the transmitter set to the lowest, middle, and highest channels in each applicable band. Below 30MHz, below 1GHz and above 18GHz emissions, the channel with the highest output power was tested.

The frequency range of interest is monitored at a fixed antenna height and EUT azimuth. The EUT is rotated through 360 degrees to maximize emissions received. The antenna is scanned from 1 to 4 meters above the ground plane to further maximize the emission. Measurements are made with the antenna polarized in both the vertical and the horizontal positions.

9.2. TRANSMITTER ABOVE 1 GHz

9.2.1. BLE (1Mbps)

BANDEDGE (LOW CHANNEL)

HORIZONTAL RESULT

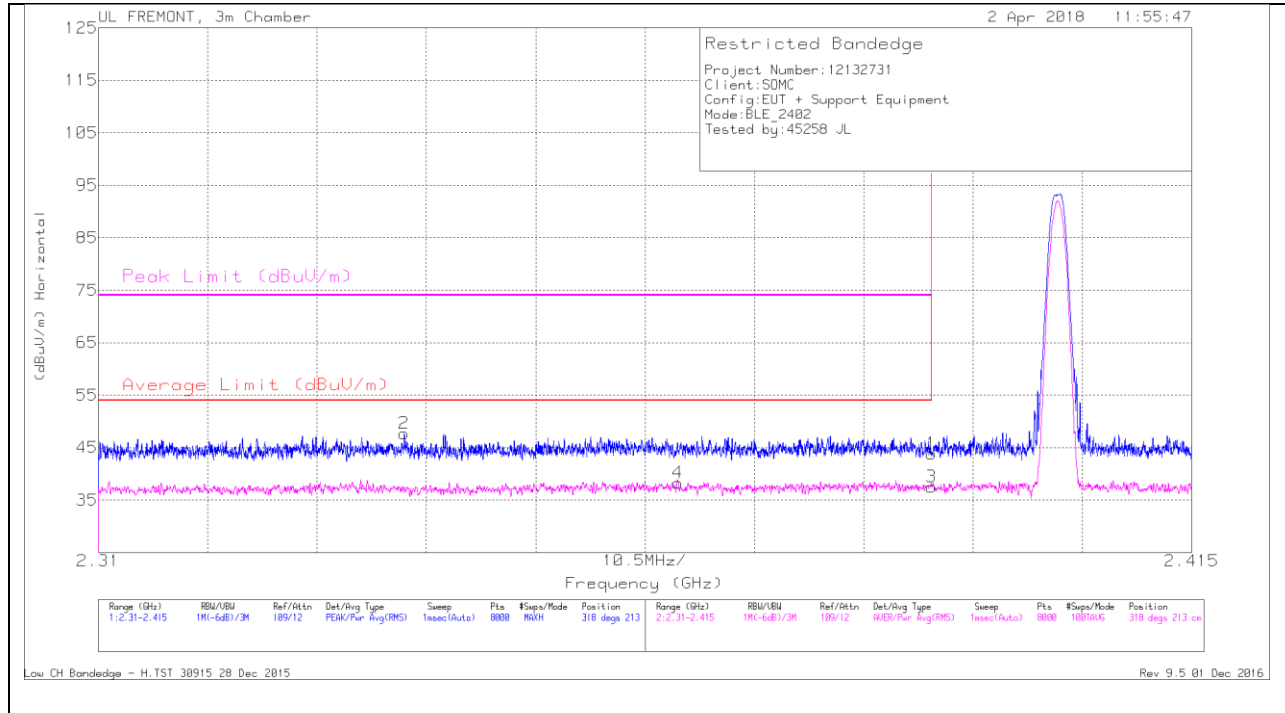

Trace Markers

Marker	Frequency (GHz)	Meter Reading (dBuV)	Det	AF T120 (dB/m)	Amp/Ch/Flt/Pad (dB)	DC Corr (dB)	Corrected Reading (dBuV/m)	Average Limit (dBuV/m)	Margin (dB)	Peak Limit (dBuV/m)	PK Margin (dB)	Azimuth (Degs)	Height (cm)	Polarity
2	2.339	37.58	Pk	31.7	-21.6	0	47.68	-	-	74	-26.32	318	213	H
4	2.366	27.64	RMS	31.8	-21.2	.69	38.93	54	-15.07	-	-	318	213	H
1	2.39	33.38	Pk	31.9	-21.4	0	43.88	-	-	74	-30.12	318	213	H
3	2.39	27.05	RMS	31.9	-21.4	.69	38.24	54	-15.76	-	-	318	213	H

* - indicates frequency in CFR47 Pt 15 Restricted Band

Pk - Peak detector

RMS - RMS detection

VERTICAL RESULT

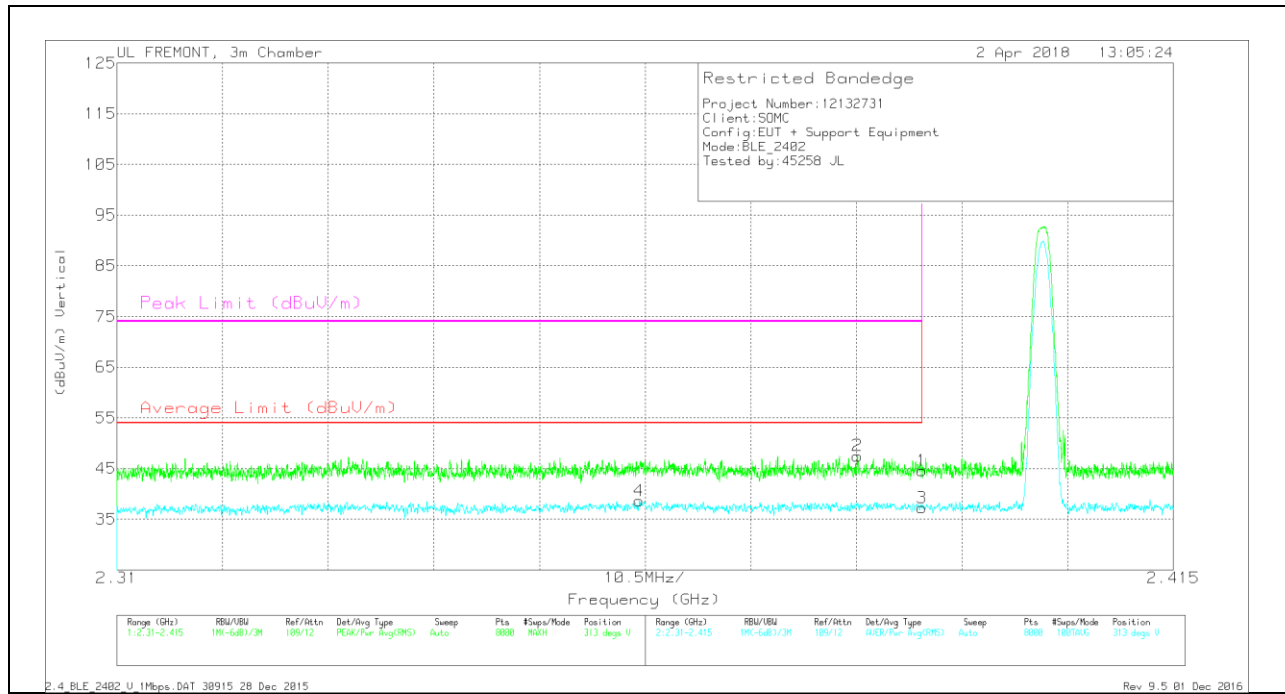

Trace Markers

Marker	Frequency (GHz)	Meter Reading (dBuV)	Det	AF T120 (dB/m)	Amp/Cb/Ftr/Pad (dB)	DC Corr (dB)	Corrected Reading (dBuV/m)	Average Limit (dBuV/m)	Margin (dB)	Peak Limit (dBuV/m)	PK Margin (dB)	Azimuth (Degs)	Height (cm)	Polarity
4	2.362	27.31	RMS	31.7	-21.1	.69	38.6	54	-15.4	-	-	313	193	V
2	2.384	36.8	Pk	31.9	-21.2	0	47.5	-	-	74	-26.5	313	193	V
1	2.39	34.05	Pk	31.9	-21.4	0	44.55	-	-	74	-29.45	313	193	V
3	2.39	26.05	RMS	31.9	-21.4	.69	37.24	54	-16.76	-	-	313	193	V

* - indicates frequency in CFR47 Pt 15 Restricted Band

Pk - Peak detector

RMS - RMS detection

BANEDGE (HIGH CHANNEL)

HORIZONTAL RESULT

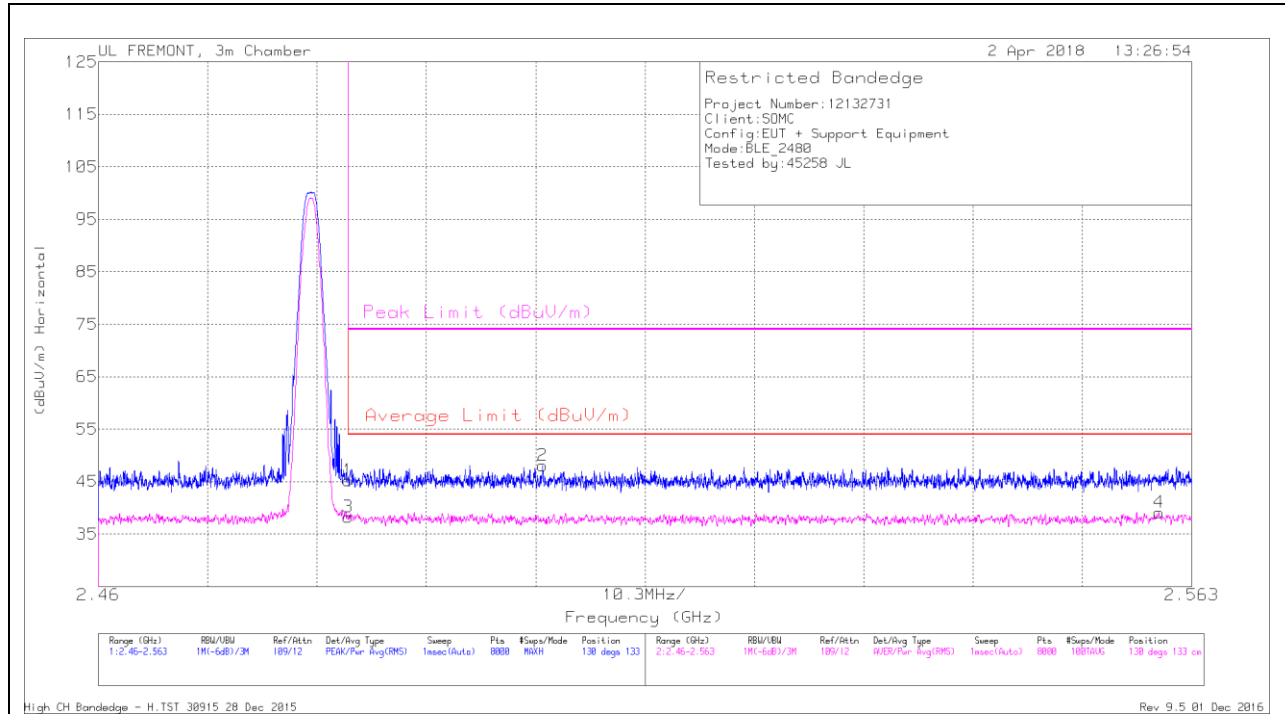

Trace Markers

Marker	Frequency (GHz)	Meter Reading (dBuV)	Det	AF T120 (dB/m)	Amp/Cbl/Filt/Pad (dB)	DC Corr (dB)	Corrected Reading (dBuV/m)	Average Limit (dBuV/m)	Margin (dB)	Peak Limit (dBuV/m)	PK Margin (dB)	Azimuth (Degs)	Height (cm)	Polarity
1	2.484	34.85	Pk	32.2	-21.8	0	45.25	-	-	74	-28.75	130	133	H
3	2.484	27.15	RMS	32.2	-21.8	.69	38.24	54	-15.76	-	-	130	133	H
2	2.502	37.5	Pk	32.3	-21.7	0	48.1	-	-	74	-25.9	130	133	H
4	2.56	27.88	RMS	32.3	-21.7	.69	39.17	54	-14.83	-	-	130	133	H

* - indicates frequency in CFR47 Pt 15 Restricted Band

Pk - Peak detector

RMS - RMS detection

VERTICAL RESULT

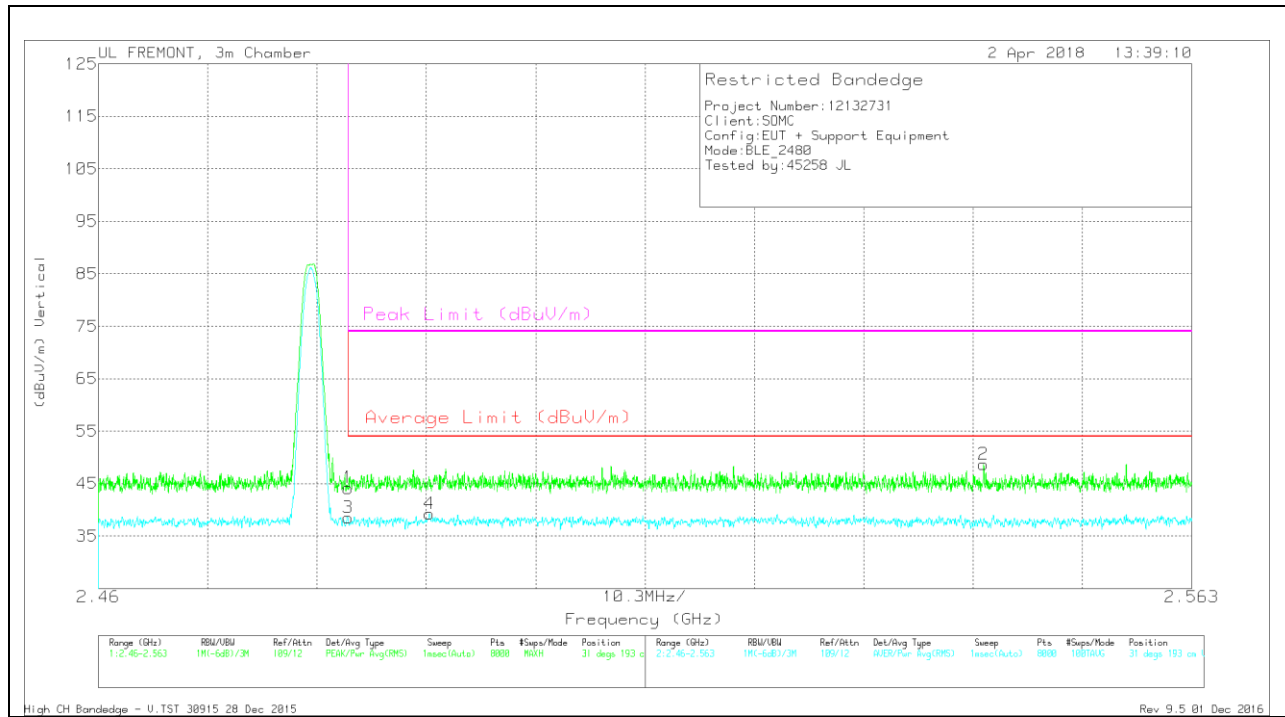

Trace Markers

Marker	Frequency (GHz)	Meter Reading (dBuV)	Det	AF T120 (dB/m)	Amp/Ch/Flr/Pad (dB)	DC Corr (dB)	Corrected Reading (dBuV/m)	Average Limit (dBuV/m)	Margin (dB)	Peak Limit (dBuV/m)	PK Margin (dB)	Azimuth (Degs)	Height (cm)	Polarity
1	2.484	33.75	Pk	32.2	-21.8	0	44.15	-	-	74	-29.85	31	193	V
3	2.484	27.36	RMS	32.2	-21.8	.69	38.45	54	-15.55	-	-	31	193	V
4	2.491	27.95	RMS	32.2	-21.6	.69	39.24	54	-14.76	-	-	31	193	V
2	2.543	38.14	Pk	32.3	-21.8	0	48.64	-	-	74	-25.36	31	193	V

* - indicates frequency in CFR47 Pt 15 Restricted Band

Pk - Peak detector

RMS - RMS detection

HARMONICS AND SPURIOUS EMISSIONS

LOW CHANNEL RESULTS

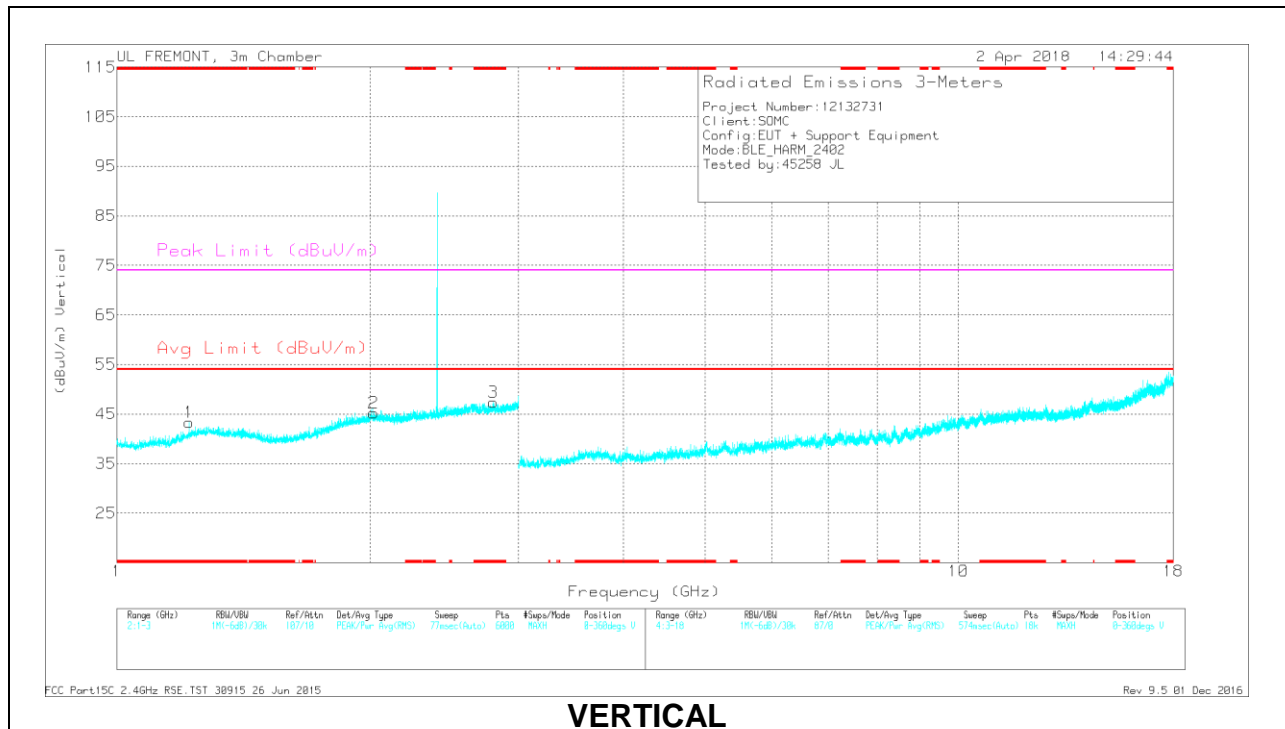
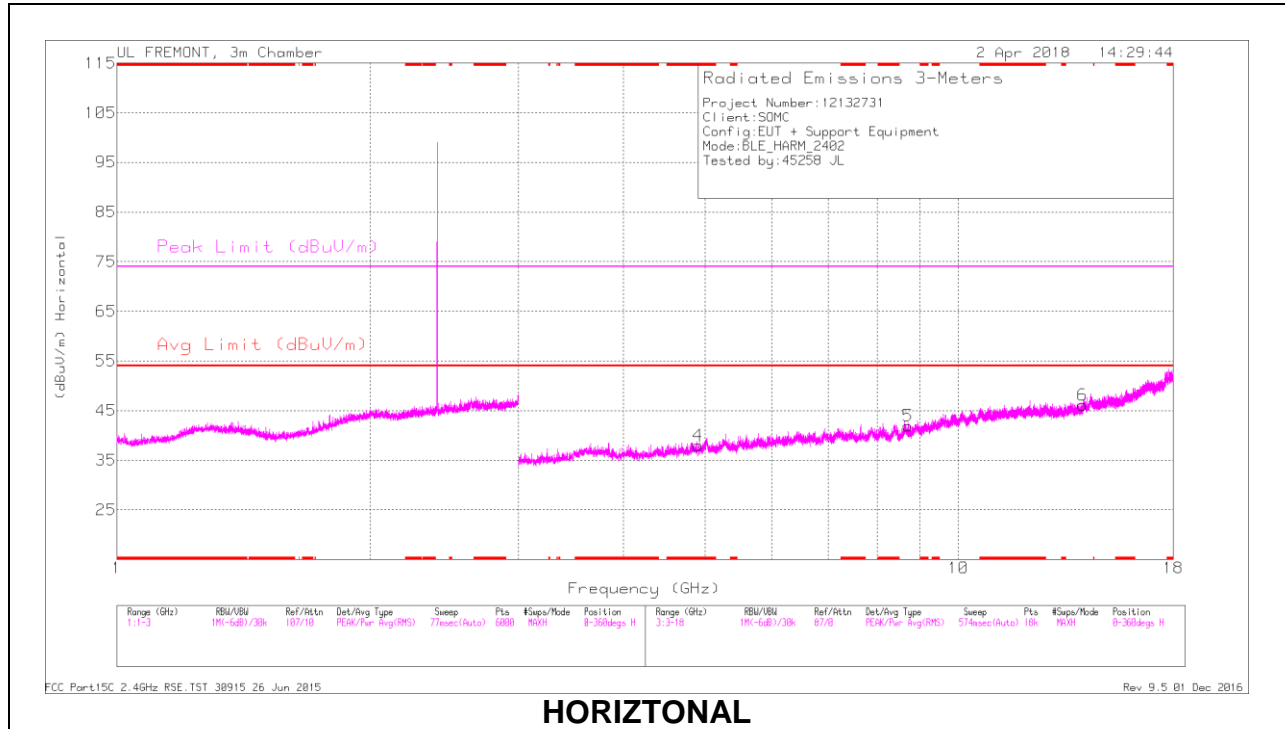

RADIATED EMISSIONS

Radiated Emissions

Frequency (GHz)	Meter Reading (dBuV)	Det	AF T120 (dB/m)	Amp/Cbl/Filtr/ Pad (dB)	DC Corr (dB)	Corrected Reading (dBuV/m)	Avg Limit (dBuV/m)	Margin (dB)	Peak Limit (dBuV/m)	PK Margin (dB)	Azimuth (Degs)	Height (cm)	Polarity
* 1.216	41.03	PK2	29.2	-22.1	0	48.13	-	-	74	-25.87	306	214	V
* 1.217	29.4	MAv1	29.3	-22.1	.69	37.29	54	-16.71	-	-	306	214	V
* 2.8	40.52	PK2	32.7	-19.9	0	53.32	-	-	74	-20.68	223	218	V
* 2.799	28.97	MAv1	32.7	-20	.69	42.36	54	-11.64	-	-	223	218	V
* 4.909	37.34	PK2	34	-27.2	0	44.14	-	-	74	-29.86	155	275	H
* 4.91	26.87	MAv1	34	-27.5	.69	34.06	54	-19.94	-	-	155	275	H
2.019	40.21	PK2	31.8	-21	0	51.01	-	-	-	-	247	125	V
8.711	34.95	PK2	35.9	-23.6	0	47.25	-	-	-	-	185	324	H
14.051	36.01	PK2	39.1	-22.8	0	52.31	-	-	-	-	208	221	H

* - indicates frequency in CFR47 Pt 15 Restricted Band

PK2 - KDB558074 Method: Maximum Peak

MAv1 - KDB558074 Option 1 Maximum RMS Average

MID CHANNEL RESULTS

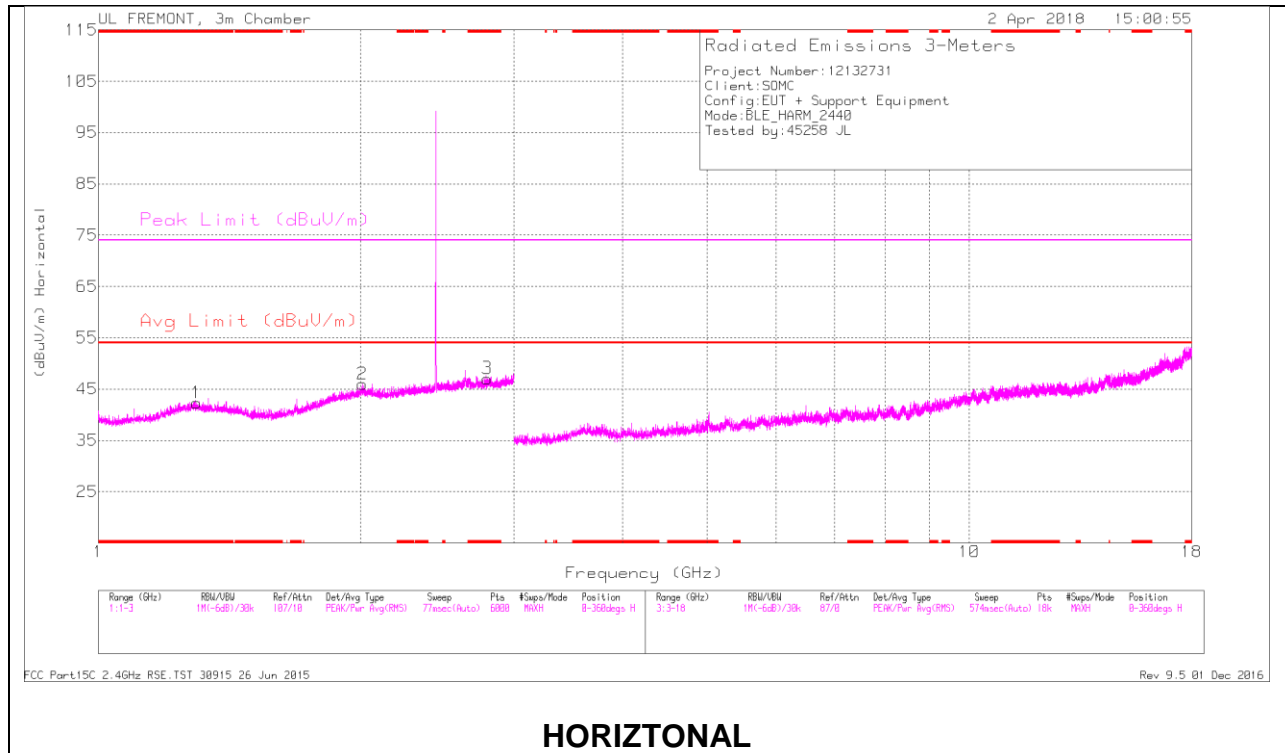

HORIZONTAL

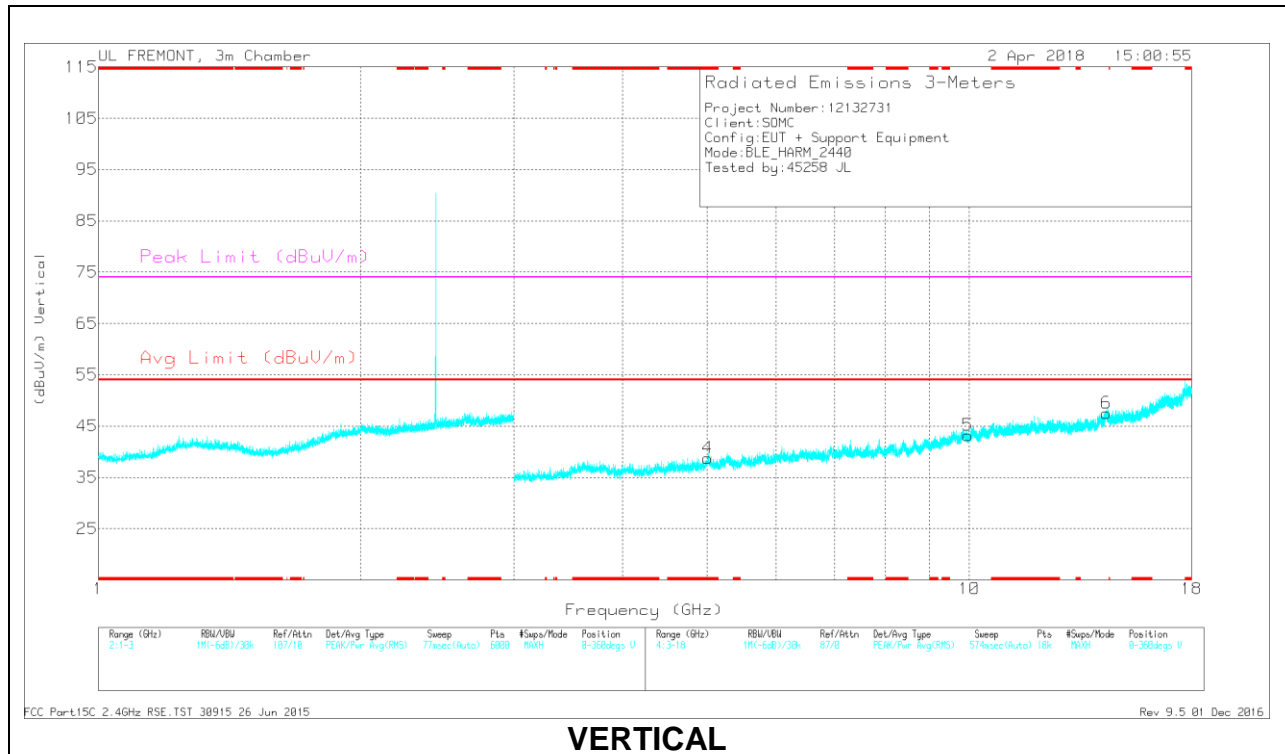

VERTICAL

RADIATED EMISSIONS

Frequency (GHz)	Meter Reading (dBuV)	Det	AF T120 (dB/m)	Amp/Cbl/Filtr/P ad (dB)	DC Corr (dB)	Corrected Reading (dBuV/m)	Avg Limit (dBuV/m)	Margin (dB)	Peak Limit (dBuV/m)	PK Margin (dB)	Azimuth (Degs)	Height (cm)	Polarity
* 1.297	41.29	PK2	29.9	-22	0	49.19	-	-	74	-24.81	273	212	H
* 1.297	29.56	MAv1	29.9	-22	.69	38.15	54	-15.85	-	-	273	212	H
* 2.794	41.25	PK2	32.7	-20.4	0	53.55	-	-	74	-20.45	243	229	H
* 2.795	29.18	MAv1	32.7	-20.3	.69	42.27	54	-11.73	-	-	243	229	H
* 5.006	38.16	PK2	34.2	-27.2	0	45.16	-	-	74	-28.84	183	129	V
* 5.006	27.18	MAv1	34.2	-27.4	.69	34.67	54	-19.33	-	-	183	129	V
2.007	40.3	PK2	31.8	-20.3	0	51.8	-	-	-	-	304	136	H
9.96	34	PK2	37.3	-21.5	0	49.8	-	-	-	-	124	282	V
14.365	36.35	PK2	39.6	-21.6	0	54.35	-	-	-	-	81	339	V

* - indicates frequency in CFR47 Pt 15 Restricted Band
 PK2 - KDB558074 Method: Maximum Peak
 MAv1 - KDB558074 Option 1 Maximum RMS Average

HIGH CHANNEL RESULTS

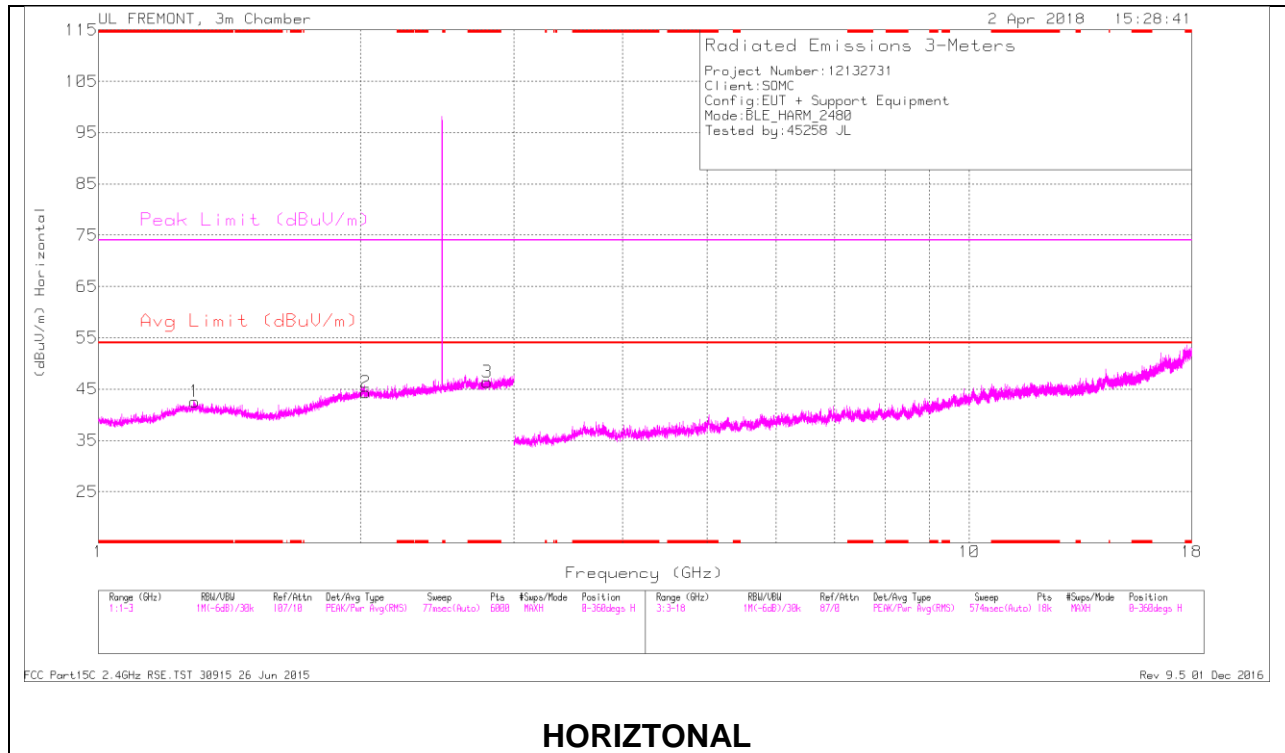

HORIZONTAL

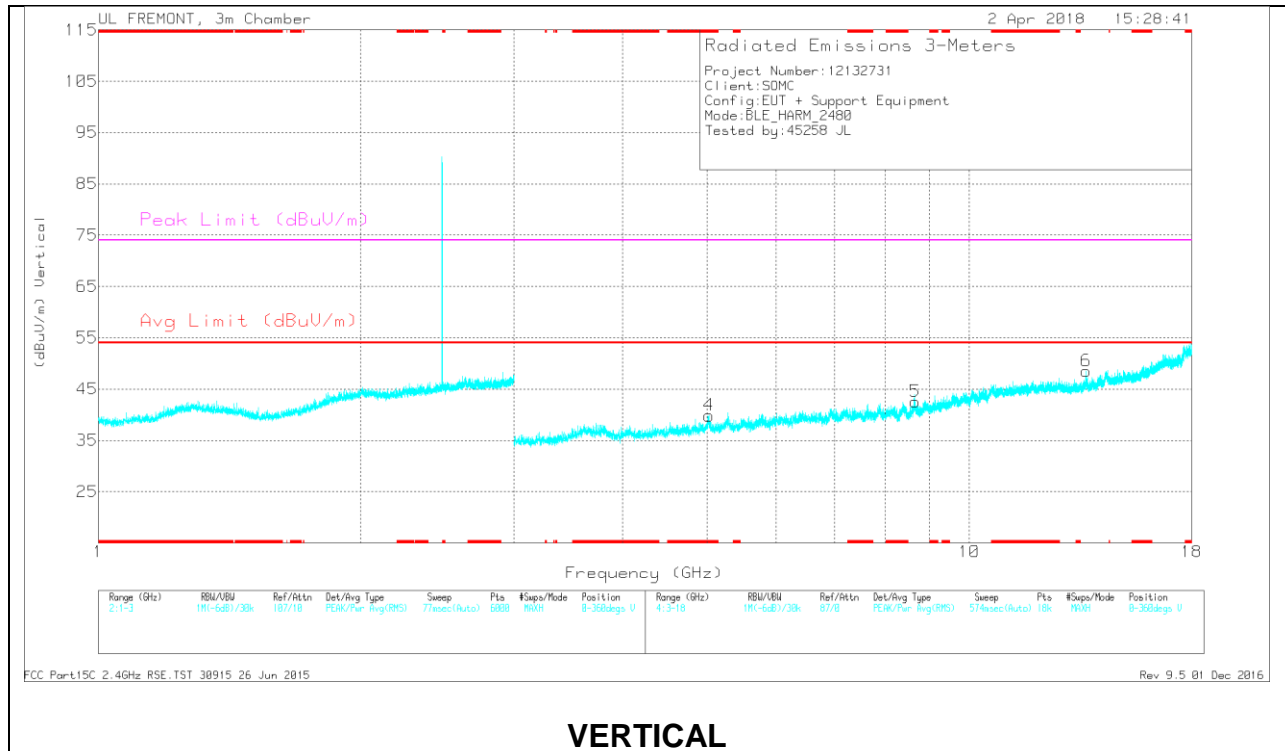

VERTICAL

RADIATED EMISSIONS

Frequency (GHz)	Meter Reading (dBuV)	Det	AF T120 (dB/m)	Amp/Cb/Fltr/Paid (dB)	DC Corr (dB)	Corrected Reading (dBuV/m)	Avg Limit (dBuV/m)	Margin (dB)	Peak Limit (dBuV/m)	PK Margin (dB)	Azimuth (Degs)	Height (cm)	Polarity
* 1.292	41.41	PK2	29.9	-21.9	0	49.41	-	-	74	-24.59	57	206	H
* 1.29	29.5	MAV1	29.9	-21.9	.69	38.19	54	-15.81	-	-	57	206	H
* 2.794	40.33	PK2	32.7	-20.4	0	52.63	-	-	74	-21.37	170	319	H
* 2.792	29.22	MAV1	32.6	-20.4	.69	42.11	54	-11.89	-	-	170	319	H
* 5.024	36.55	PK2	34.2	-24.8	0	45.95	-	-	74	-28.05	229	240	V
* 5.021	25.57	MAV1	34.2	-24.2	.69	36.26	54	-17.74	-	-	229	240	V
2.025	41.05	PK2	31.8	-21.2	0	51.65	-	-	-	-	111	274	H
8.665	34.96	PK2	35.9	-22.6	0	48.26	-	-	-	-	199	151	V
13.611	36.28	PK2	38.8	-21.7	0	53.38	-	-	-	-	269	242	V

* - indicates frequency in CFR47 Pt 15 Restricted Band

PK2 - KDB558074 Method: Maximum Peak

MAV1 - KDB558074 Option 1 Maximum RMS Average

9.2.2. BLE (2Mbps)

BANDEDGE (LOW CHANNEL)

HORIZONTAL RESULT

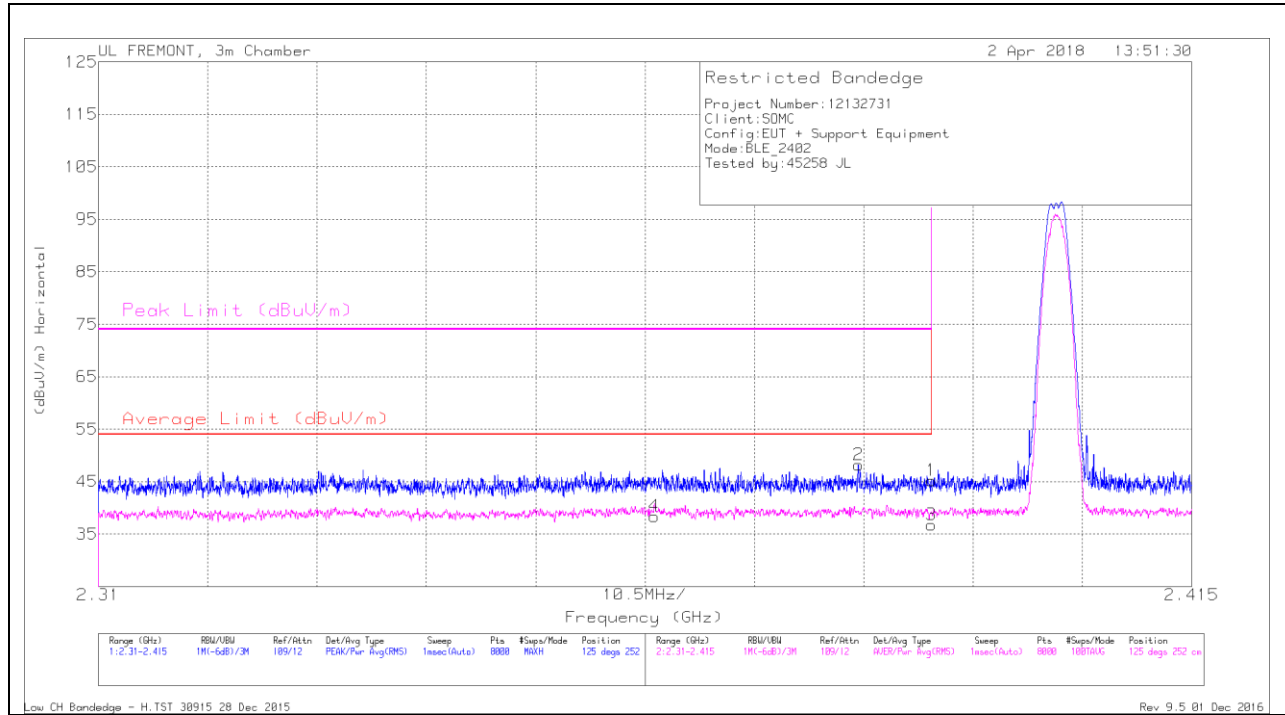

Trace Markers

Marker	Frequency (GHz)	Meter Reading (dBuV)	Det	AF T120 (dB/m)	Amp/Ch/Flt/Pad (dB)	DC Corr (dB)	Corrected Reading (dBuV/m)	Average Limit (dBuV/m)	Margin (dB)	Peak Limit (dBuV/m)	PK Margin (dB)	Azimuth (Degs)	Height (cm)	Polarity
4	2.363	27.79	RMS	31.7	-21.1	2.41	40.8	54	-13.2	-	-	125	252	H
2	2.383	37.59	Pk	31.9	-21.3	0	48.19	-	-	74	-25.81	125	252	H
1	2.39	34.69	Pk	31.9	-21.4	0	45.19	-	-	74	-28.81	125	252	H
3	2.39	26.28	RMS	31.9	-21.4	2.41	39.19	54	-14.81	-	-	125	252	H

PK - Peak detector
 RMS - RMS detection

VERTICAL RESULT

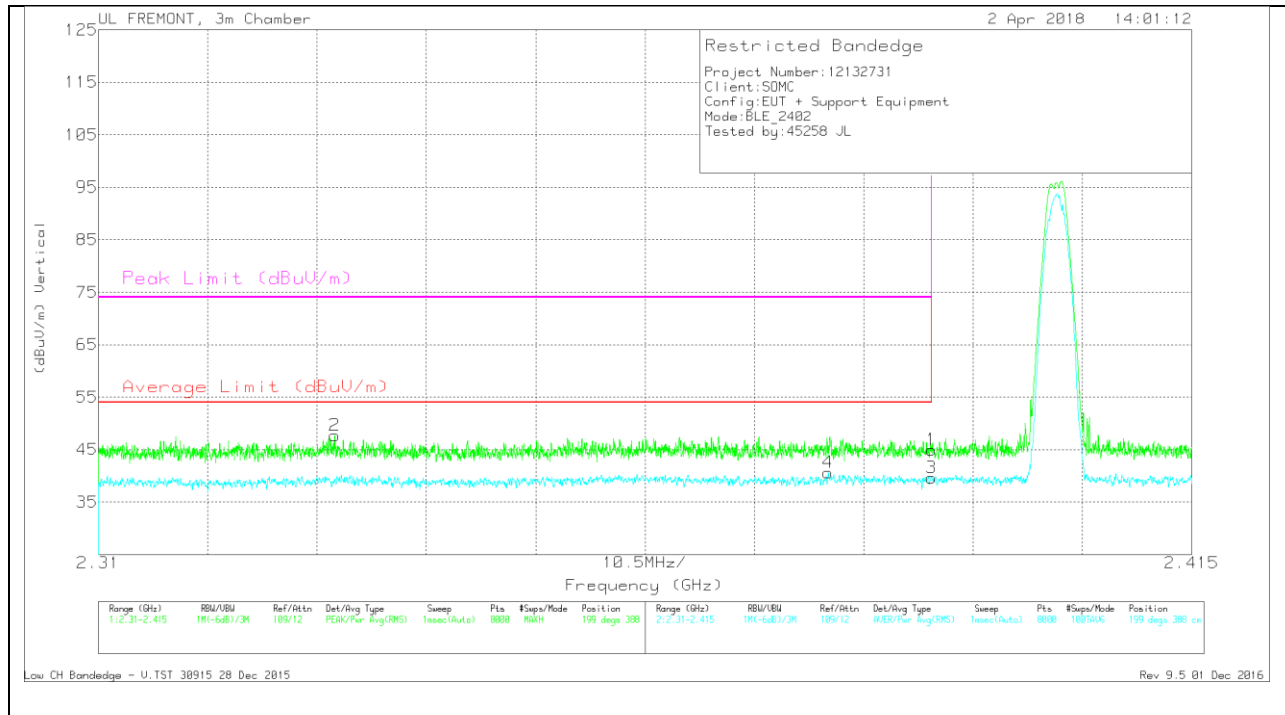

Trace Markers

Marker	Frequency (GHz)	Meter Reading (dBuV)	Det	AF T120 (dB/m)	Amp/Cb/Ftr/Pad (dB)	DC Corr (dB)	Corrected Reading (dBuV/m)	Average Limit (dBuV/m)	Margin (dB)	Peak Limit (dBuV/m)	PK Margin (dB)	Azimuth (Degs)	Height (cm)	Polarity
2	2.333	37.21	Pk	31.7	-21.2	0	47.71	-	-	74	-26.29	199	388	V
4	2.38	27.75	RMS	31.8	-21.3	2.41	40.66	54	-13.34	-	-	199	388	V
1	2.39	34.48	Pk	31.9	-21.4	0	44.98	-	-	74	-29.02	199	388	V
3	2.39	26.73	RMS	31.9	-21.4	2.41	39.64	54	-14.36	-	-	199	388	V

Pk - Peak detector
 RMS - RMS detection

BANDEDGE (HIGH CHANNEL)

HORIZONTAL RESULT

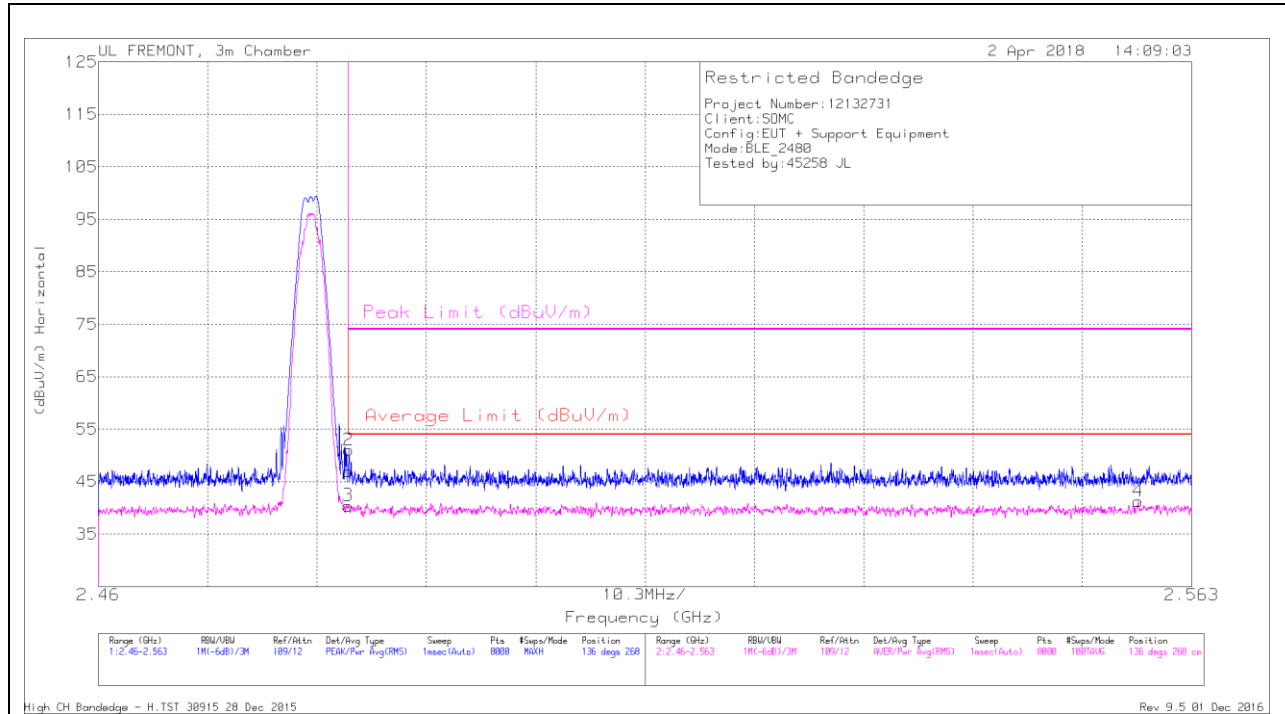

Trace Markers

Marker	Frequency (GHz)	Meter Reading (dBuV)	Det	AF T120 (dB/m)	Amp/Ch/Flt/Pad (dB)	DC Corr (dB)	Corrected Reading (dBuV/m)	Average Limit (dBuV/m)	Margin (dB)	Peak Limit (dBuV/m)	PK Margin (dB)	Azimuth (Degs)	Height (cm)	Polarity
1	2.484	36.51	Pk	32.2	-21.8	0	46.91	-	-	74	-27.09	136	268	H
2	2.484	40.66	Pk	32.2	-21.8	0	51.06	-	-	74	-22.94	136	268	H
3	2.484	27.61	RMS	32.2	-21.8	2.41	40.42	54	-13.58	-	-	136	268	H
4	2.558	28.31	RMS	32.3	-21.8	2.41	41.22	54	-12.78	-	-	136	268	H

Pk - Peak detector
 RMS - RMS detection

VERTICAL RESULT

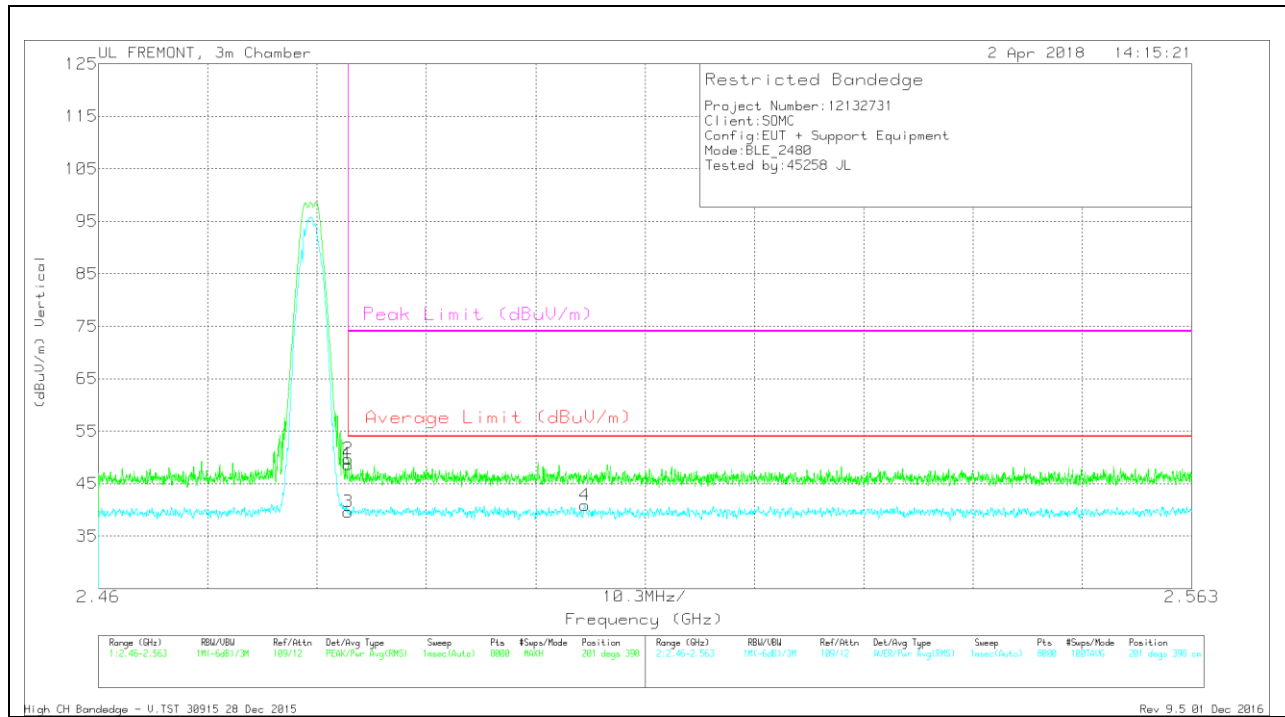

Trace Markers

Marker	Frequency (GHz)	Meter Reading (dBuV)	Det	AF T120 (dB/m)	Amp/Cb/Flr/Pad (dB)	DC Corr (dB)	Corrected Reading (dBuV/m)	Average Limit (dBuV/m)	Margin (dB)	Peak Limit (dBuV/m)	PK Margin (dB)	Azimuth (Degs)	Height (cm)	Polarity
1	2.484	38.27	Pk	32.2	-21.8	0	48.67	-	-	74	-25.33	201	398	V
2	2.484	39.22	Pk	32.2	-21.8	0	49.62	-	-	74	-24.38	201	398	V
3	2.484	26.83	RMS	32.2	-21.8	2.41	39.64	54	-14.36	-	-	201	398	V
4	2.506	27.94	RMS	32.3	-21.8	2.41	40.85	54	-13.15	-	-	201	398	V

PK - Peak detector
 RMS - RMS detection

HARMONICS AND SPURIOUS EMISSIONS

LOW CHANNEL RESULTS

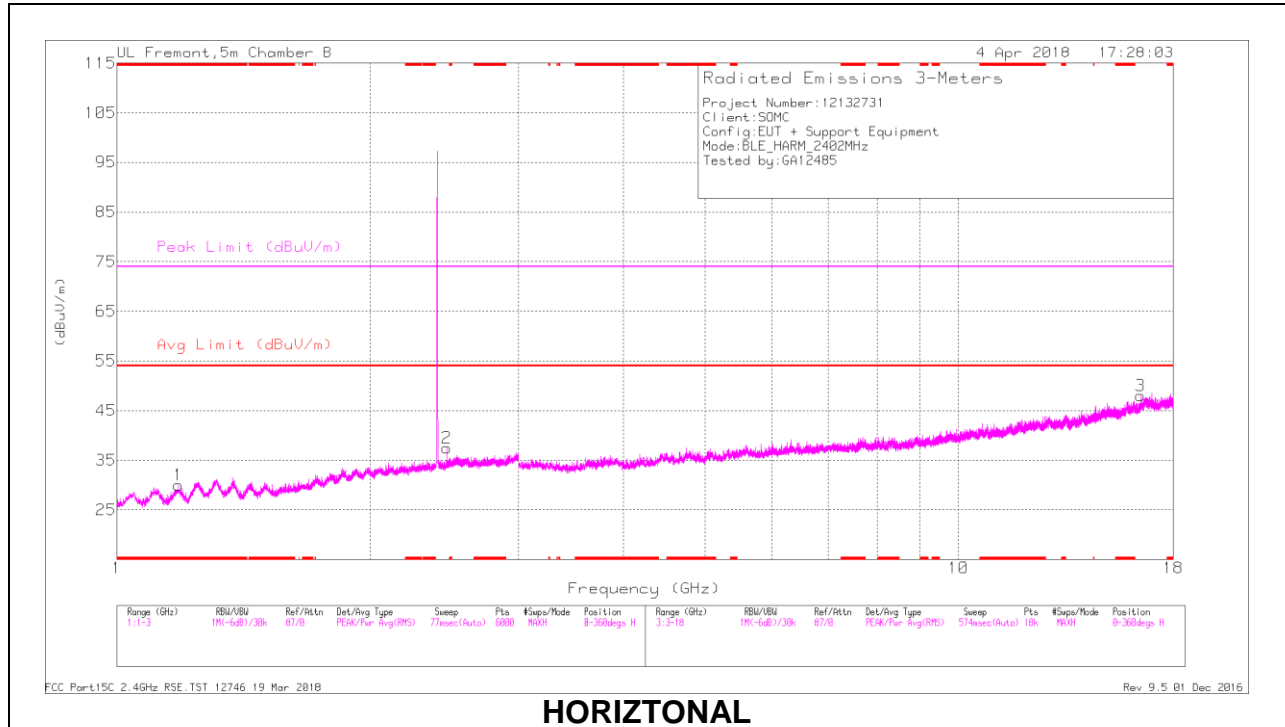

HORIZONTAL

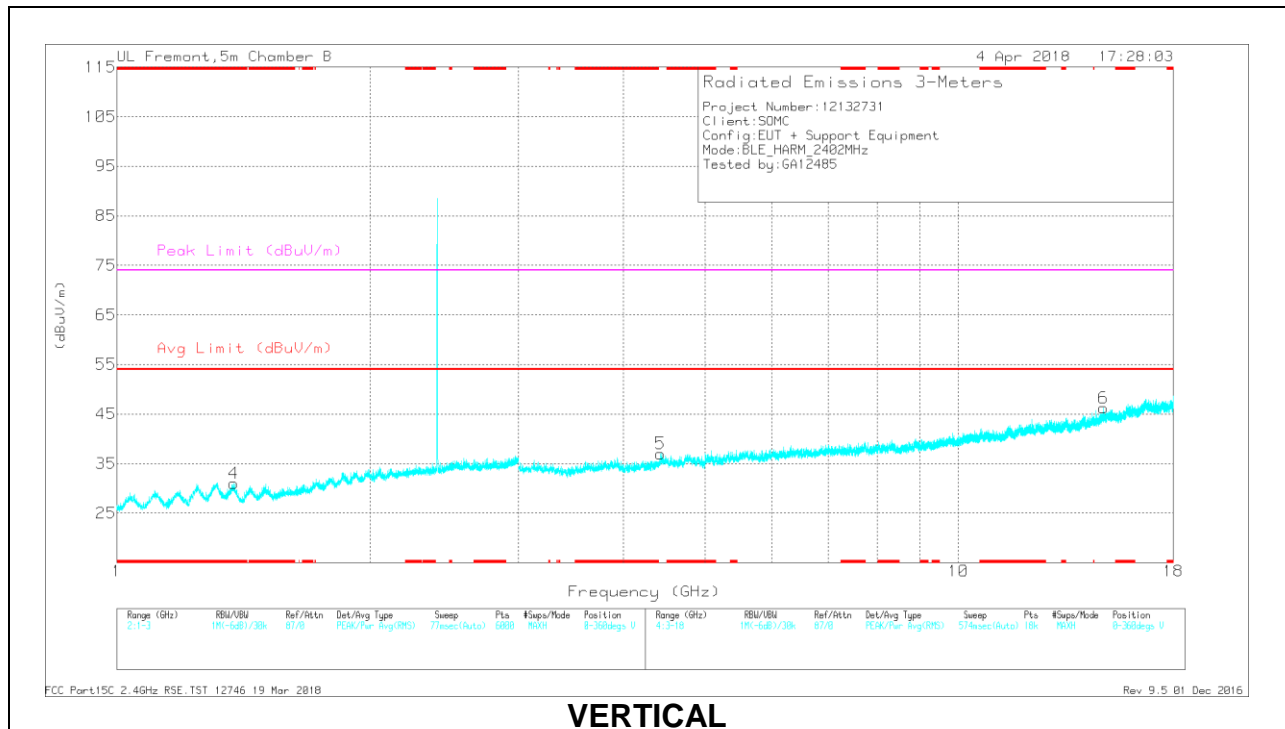

VERTICAL

RADIATED EMISSIONS

Marker	Frequency (GHz)	Meter Reading (dBuV)	Det	AF T863 (dB/m)	Amp/Cb/Ftr/ Pad (dB)	DC Corr (dB)	Corrected Reading (dBuV/m)	Avg Limit (dBuV/m)	Margin (dB)	Peak Limit (dBuV/m)	PK Margin (dB)	Azimuth (Degs)	Height (cm)	Polarity
1	* 1.182	31.03	PK2	27.8	-22.9	0	35.93	-	-	74	-38.07	110	369	H
	* 1.181	19.14	MAv1	27.8	-22.9	2.41	26.45	54	-27.55	-	-	110	369	H
4	* 1.377	30.47	PK2	28.5	-22.1	0	36.87	-	-	74	-37.13	137	387	V
	* 1.378	18.64	MAv1	28.5	-22.1	2.41	27.45	54	-26.55	-	-	137	387	V
2	2.466	32.92	PK2	32.4	-21.8	0	43.52	-	-	-	-	199	113	H
5	4.423	38.7	PK2	33.8	-29.4	0	43.1	-	-	-	-	303	381	V
6	14.856	34.56	PK2	40.6	-23.1	0	52.06	-	-	-	-	98	113	V
3	16.456	32.57	PK2	41.6	-21.4	0	52.77	-	-	-	-	264	258	H

* - indicates frequency in CFR47 Pt 15 Restricted Band
 PK2 - KDB558074 Method: Maximum Peak
 MAv1 - KDB558074 Option 1 Maximum RMS Average

MID CHANNEL RESULTS

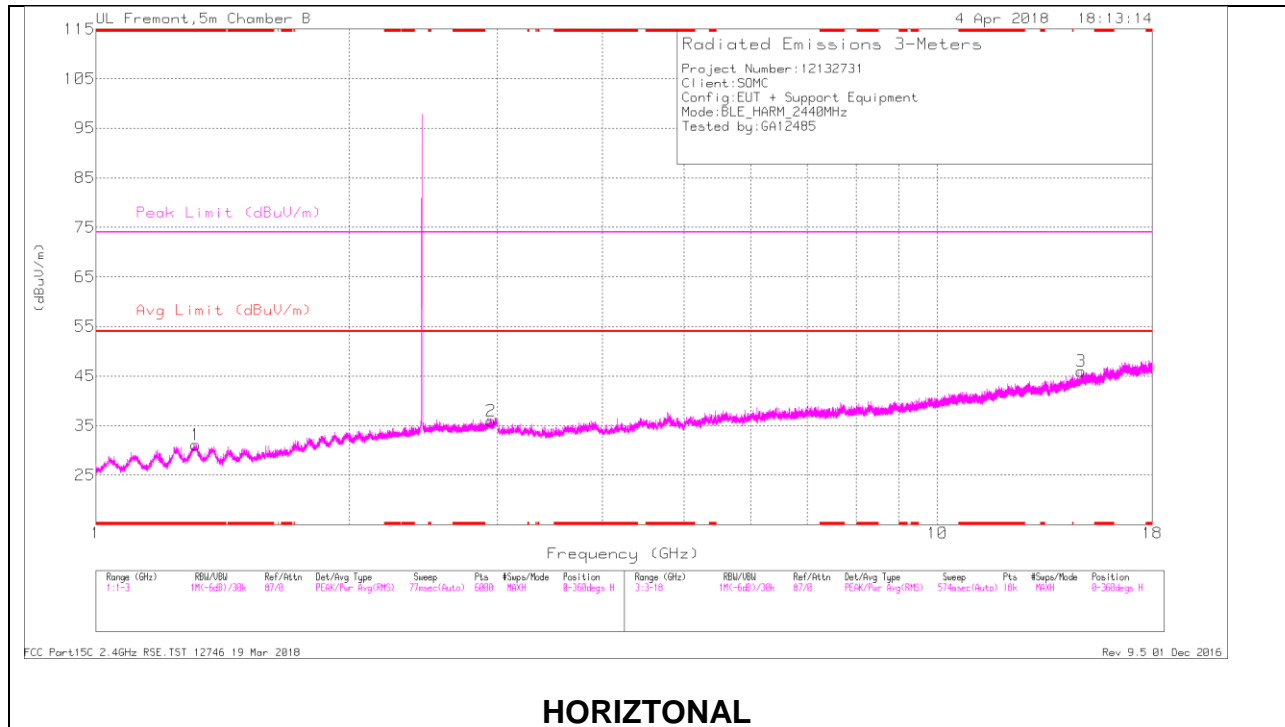

HORIZONTAL

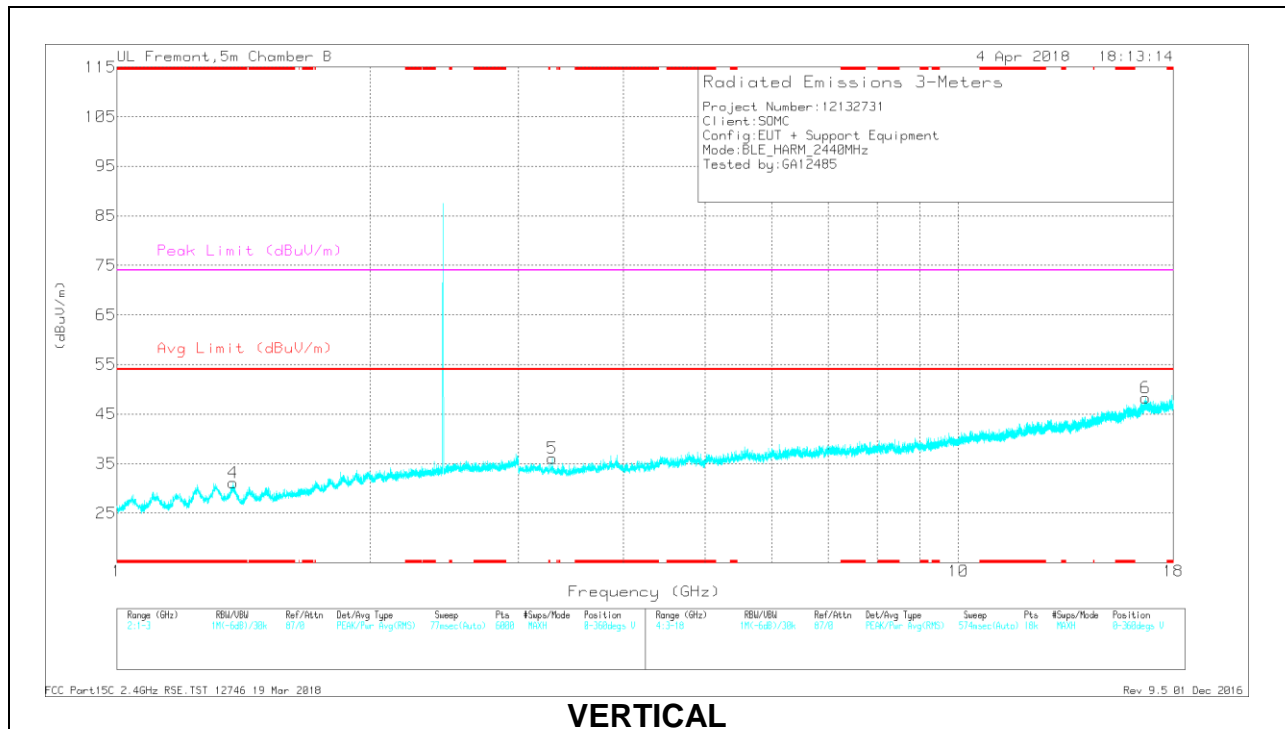

VERTICAL

RADIATED EMISSIONS

Marker	Frequency (GHz)	Meter Reading (dBuV)	Det	AF T863 (dB/m)	Amp/Cb/Fitr/ Pad (dB)	DC Corr (dB)	Corrected Reading (dBuV/m)	Avg Limit (dBuV/m)	Margin (dB)	Peak Limit (dBuV/m)	PK Margin (dB)	Azimuth (Degs)	Height (cm)	Polarity
1	* 1.315	31.12	PK2	28.9	-22	0	38.02	-	-	74	-35.98	205	147	H
	* 1.314	18.59	MAv1	28.9	-22	2.41	27.9	54	-26.1	-	-	205	147	H
4	* 1.373	30.39	PK2	28.6	-22.1	0	36.89	-	-	74	-37.11	150	112	V
	* 1.377	18.63	MAv1	28.5	-22.1	2.41	27.44	54	-26.56	-	-	150	112	V
2	2.951	29.29	PK2	32.6	-20.2	0	41.69	-	-	-	-	56	357	H
5	3.292	40	PK2	32.9	-31.4	0	41.5	-	-	-	-	142	168	V
3	14.814	34.11	PK2	40.5	-23.4	0	51.21	-	-	-	-	61	223	H
6	16.677	32.52	PK2	42.2	-21.2	0	53.52	-	-	-	-	308	128	V

* - indicates frequency in CFR47 Pt 15 Restricted Band

PK2 - KDB558074 Method: Maximum Peak

MAv1 - KDB558074 Option 1 Maximum RMS Average

HIGH CHANNEL RESULTS

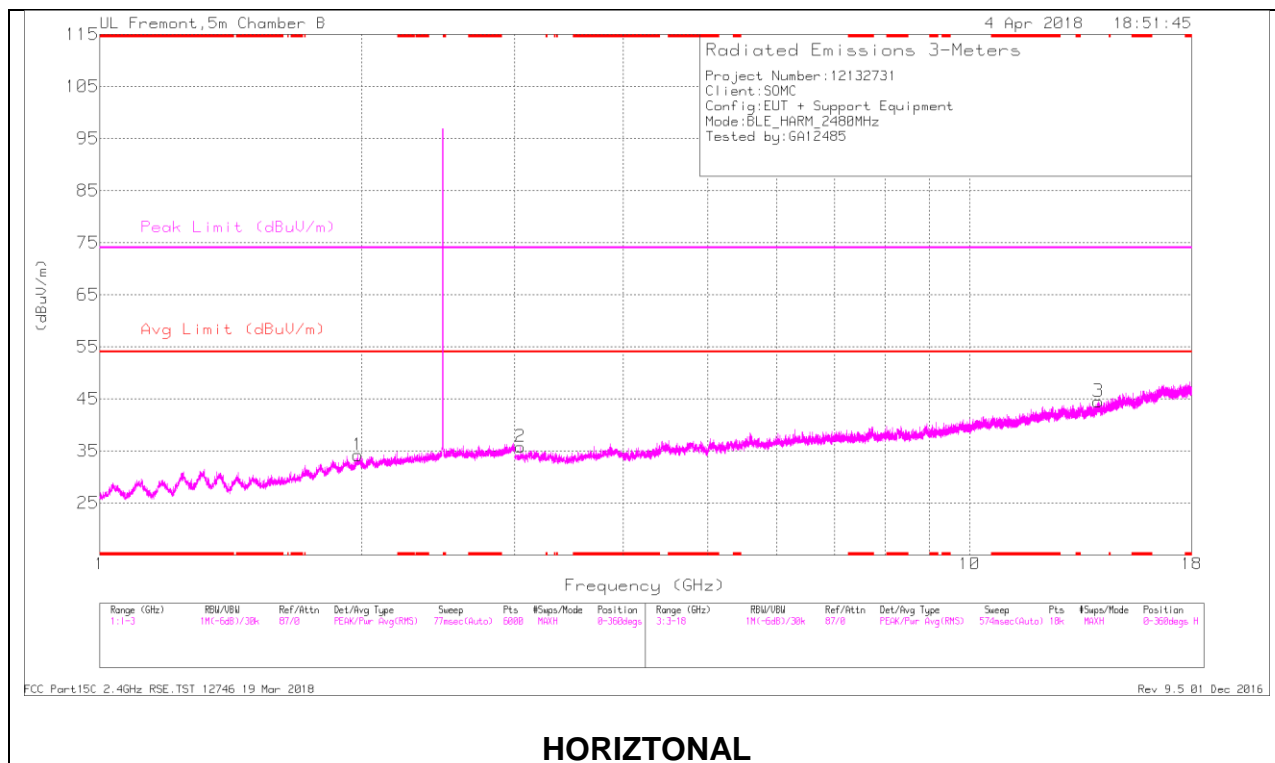

HORIZONTAL

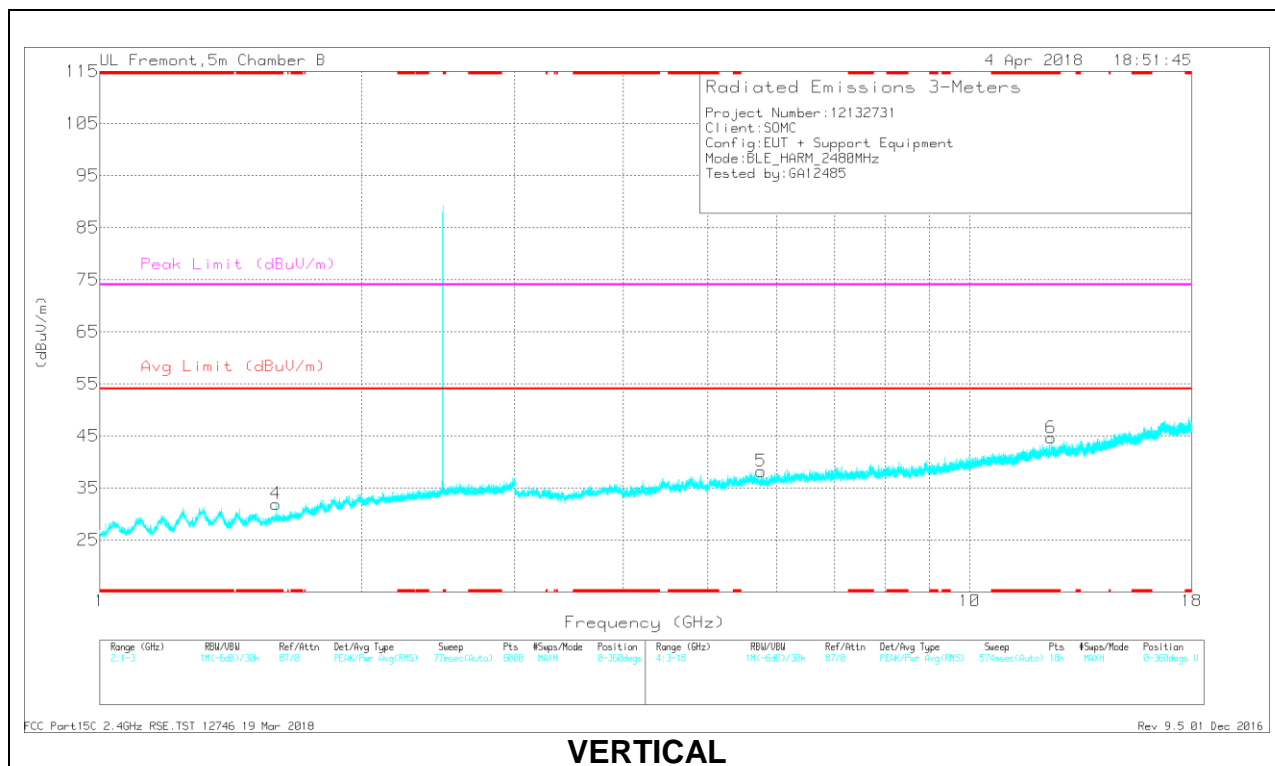

VERTICAL

RADIATED EMISSIONS

Marker	Frequency (GHz)	Meter Reading (dBuV)	Det	AF T863 (dB/m)	Amp/Cb/Fitr/Pa d (dB)	DC Corr (dB)	Corrected Reading (dBuV/m)	Avg Limit (dBuV/m)	Margin (dB)	Peak Limit (dBuV/m)	PK Margin (dB)	Azimuth (Degs)	Height (cm)	Polarity
4	* 1.595	29.56	PK2	28.3	-21.7	0	36.16	-	-	74	-37.84	176	154	V
	* 1.595	17.58	MAv1	28.3	-21.7	2.41	26.59	54	-27.41	-	-	176	154	V
6	* 12.409	33.9	PK2	39	-23.6	0	49.3	-	-	74	-24.7	25	123	V
	* 12.408	22	MAv1	39	-23.6	2.41	39.81	54	-14.19	-	-	25	123	V
1	1.983	30.07	PK2	31.2	-21.4	0	39.87	-	-	-	-	92	230	H
2	3.047	39.9	PK2	33	-31.8	0	41.1	-	-	-	-	113	370	H
5	5.761	38.47	PK2	35	-30.4	0	43.07	-	-	-	-	357	129	V
3	14.059	33.82	PK2	39.2	-23.2	0	49.82	-	-	-	-	98	272	H

* - indicates frequency in CFR47 Pt 15 Restricted Band
 PK2 - KDB558074 Method: Maximum Peak
 MAv1 - KDB558074 Option 1 Maximum RMS Average

9.3. SPURIOUS EMISSIONS BELOW 30 MHz (WORST-CASE CONFIGURATION)

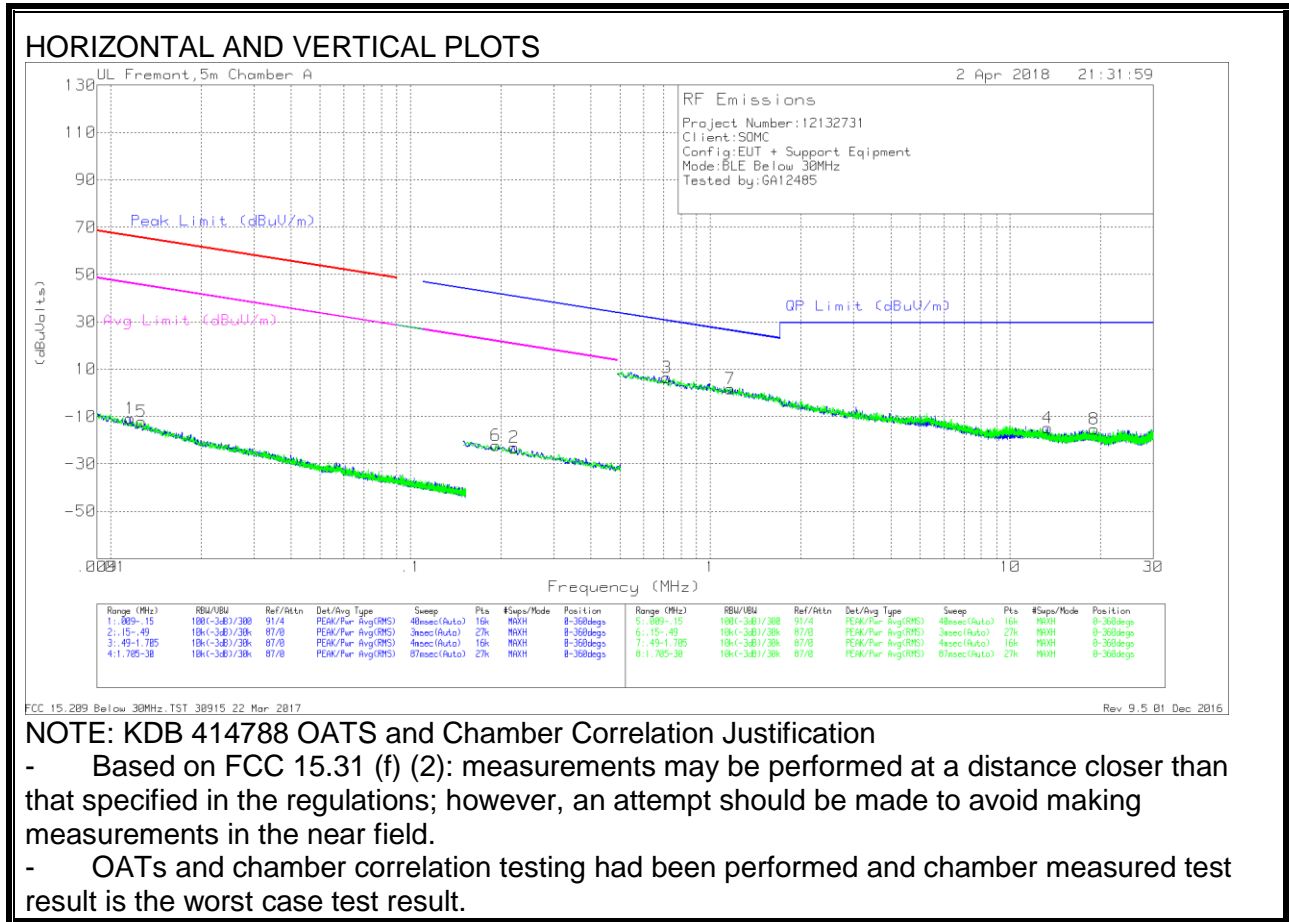

Trace Markers

Marker	Frequency (MHz)	Meter Reading (dBuV)	Det	Loop Antenna (dB/m)	CM (dB)	Dist Corr 30m	Corrected Reading (dBuV/m)	Peak Limit (dBuV/m)	Margin (dB)	Avg Limit (dBuV/m)	Margin (dB)	Peak Limit (dBuV/m)	Margin (dB)	Avg Limit (dBuV/m)	Margin (dB)	Azimuth (Degs)
1	.01159	51.02	Pk	18	.1	-80	-10.88	66.3	-77.18	46.3	-57.18	-	-	-	-	0-360
5	.01267	50.29	Pk	17.5	.1	-80	-12.11	65.53	-77.64	45.53	-57.64	-	-	-	-	0-360
6	.19287	46.76	Pk	11	.1	-80	-22.14	-	-	-	-	41.91	-64.05	21.91	-44.05	0-360
2	.22153	45.77	Pk	11	.1	-80	-23.13	-	-	-	-	40.71	-63.84	20.71	-43.84	0-360

Pk - Peak detector

Marker	Frequency (MHz)	Meter Reading (dBuV)	Det	Loop Antenna (dB/m)	CM (dB)	Dist Corr 30m	Corrected Reading (dBuV/m)	OP Limit (dBuV/m)	Margin (dB)	Azimuth (Degs)
3	.71618	35.48	Pk	11	.1	-40	6.58	30.51	-23.93	0-360
7	1.16739	30.28	Pk	11.3	.2	-40	1.78	26.28	-24.5	0-360
4	13.29798	13.56	Pk	11	.6	-40	-14.84	29.5	-44.34	0-360
8	19.06617	13.26	Pk	10.9	.6	-40	-15.24	29.5	-44.74	0-360

Pk - Peak detector

9.4. Worst Case Below 1 GHz

SPURIOUS EMISSIONS 30 TO 1000 MHz (WORST-CASE CONFIGURATION)

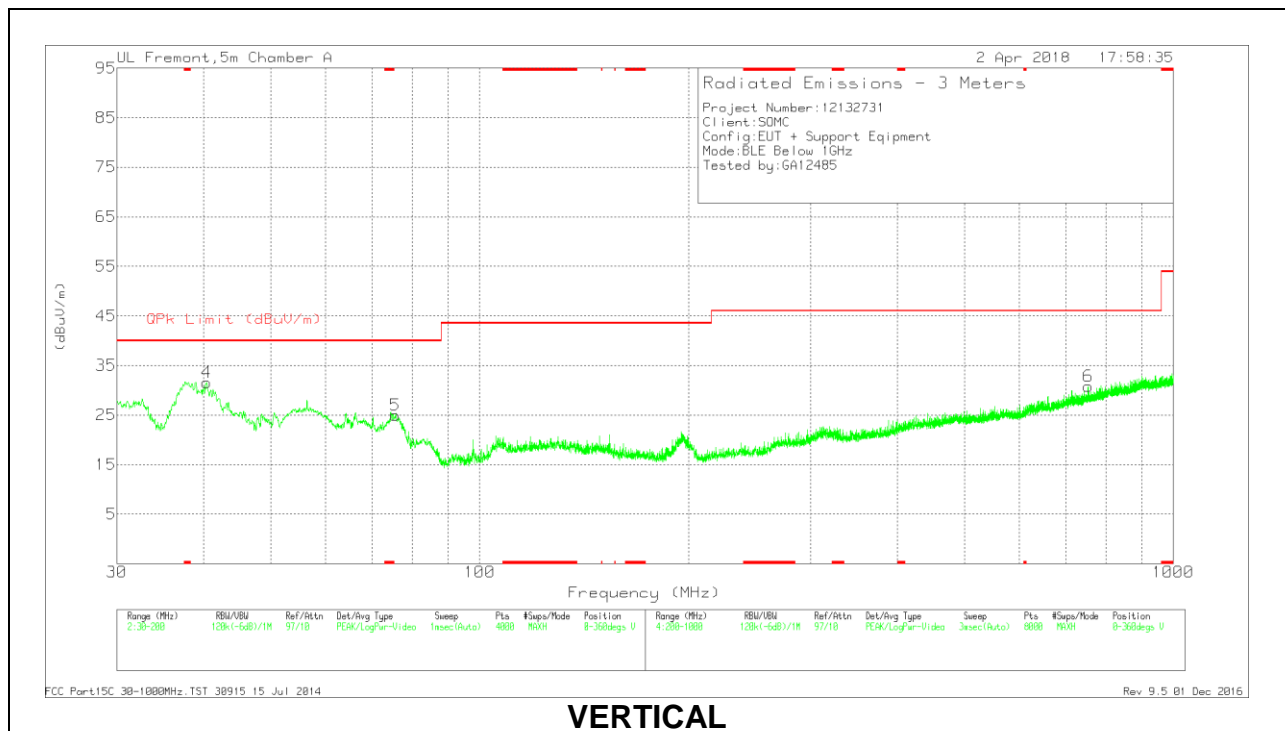
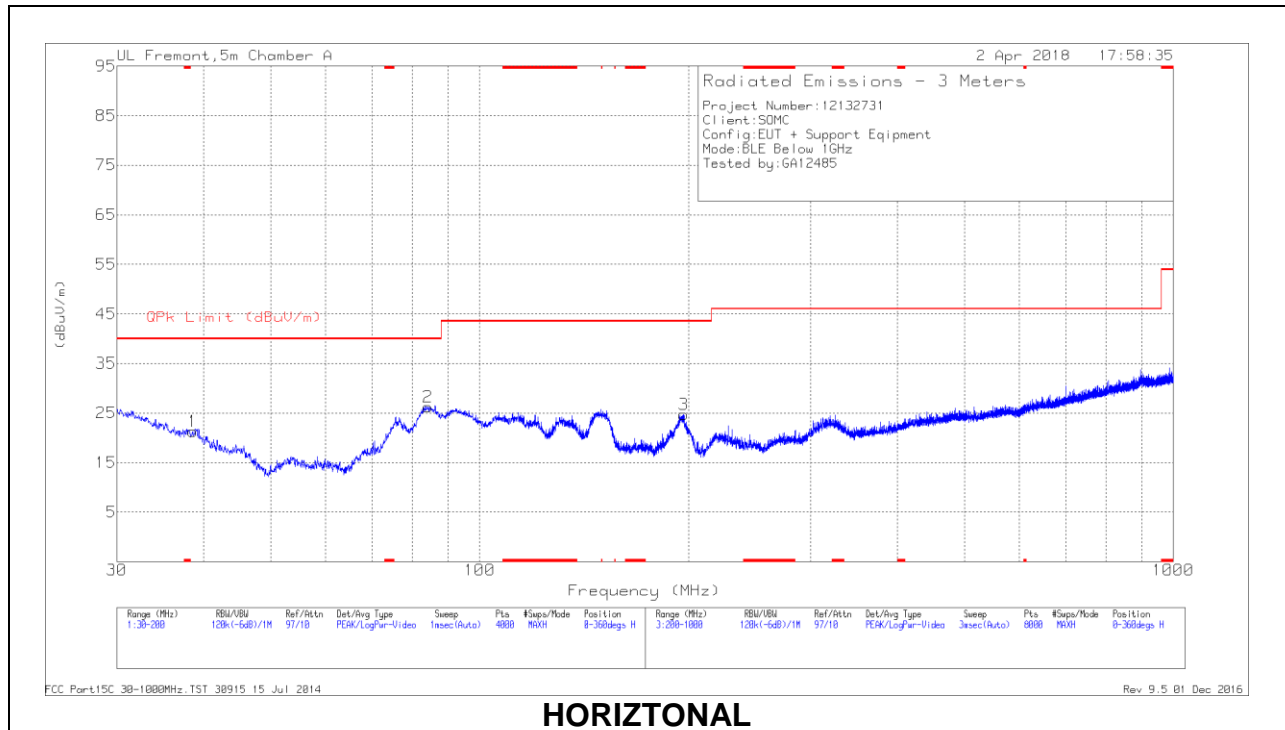

Below 1GHz Data

Trace Markers

Marker	Frequency (MHz)	Meter Reading (dBuV)	Det	AF T130 (dB/m)	Amp/Cbl (dB/m)	Corrected Reading (dBuV/m)	QPk Limit (dBuV/m)	Margin (dB)	Azimuth (Degs)	Height (cm)	Polarity
1	38.5872	29.51	Pk	19	-27.2	21.31	40	-18.69	0-360	400	H
4	40.4152	40.92	Pk	17.7	-27.1	31.52	40	-8.48	0-360	100	V
5	75.6143	39.72	Pk	11.9	-26.7	24.92	40	-15.08	0-360	100	V
2	84.2015	41.53	Pk	11.3	-26.6	26.23	40	-13.77	0-360	200	H
3	196.6856	33.96	Pk	16.1	-25.4	24.66	43.52	-18.86	0-360	101	H
6	753.572	30	Pk	24.8	-24	30.8	46.02	-15.22	0-360	300	V

Pk - Peak detector

9.5. Worst Case 18-26 GHz

SPURIOUS EMISSIONS 18-26 GHz (WORST-CASE CONFIGURATION)

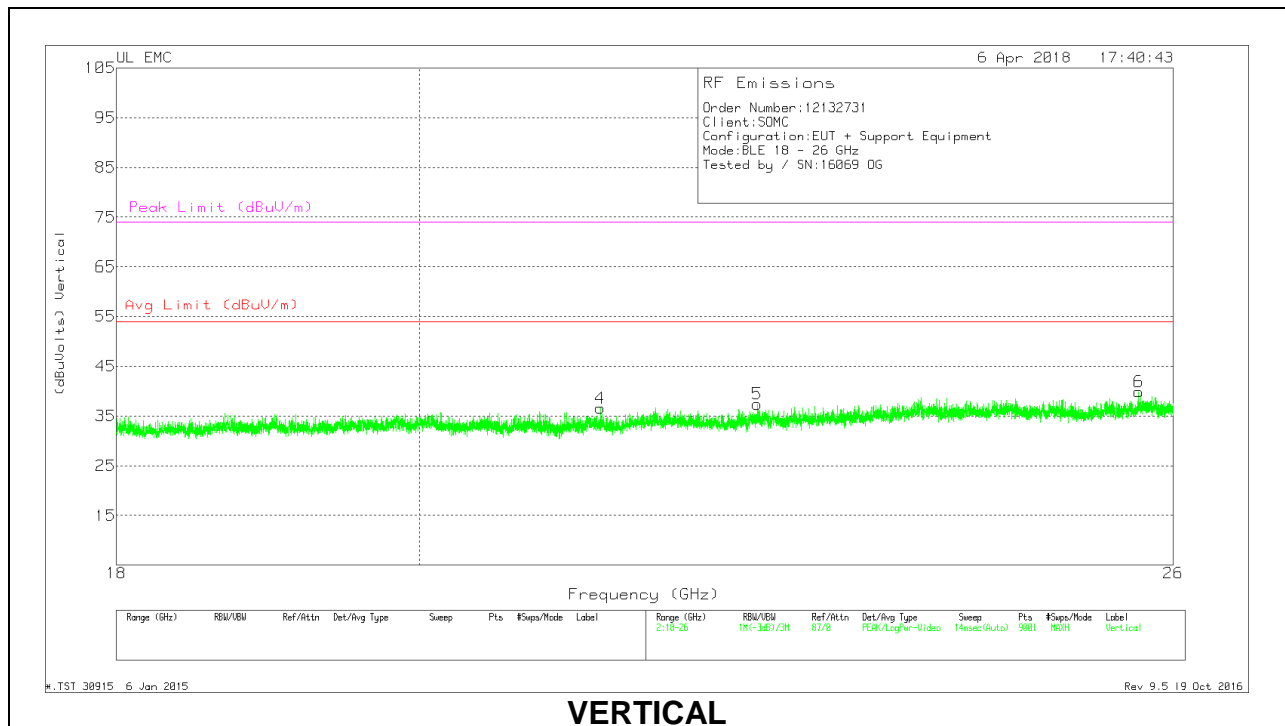
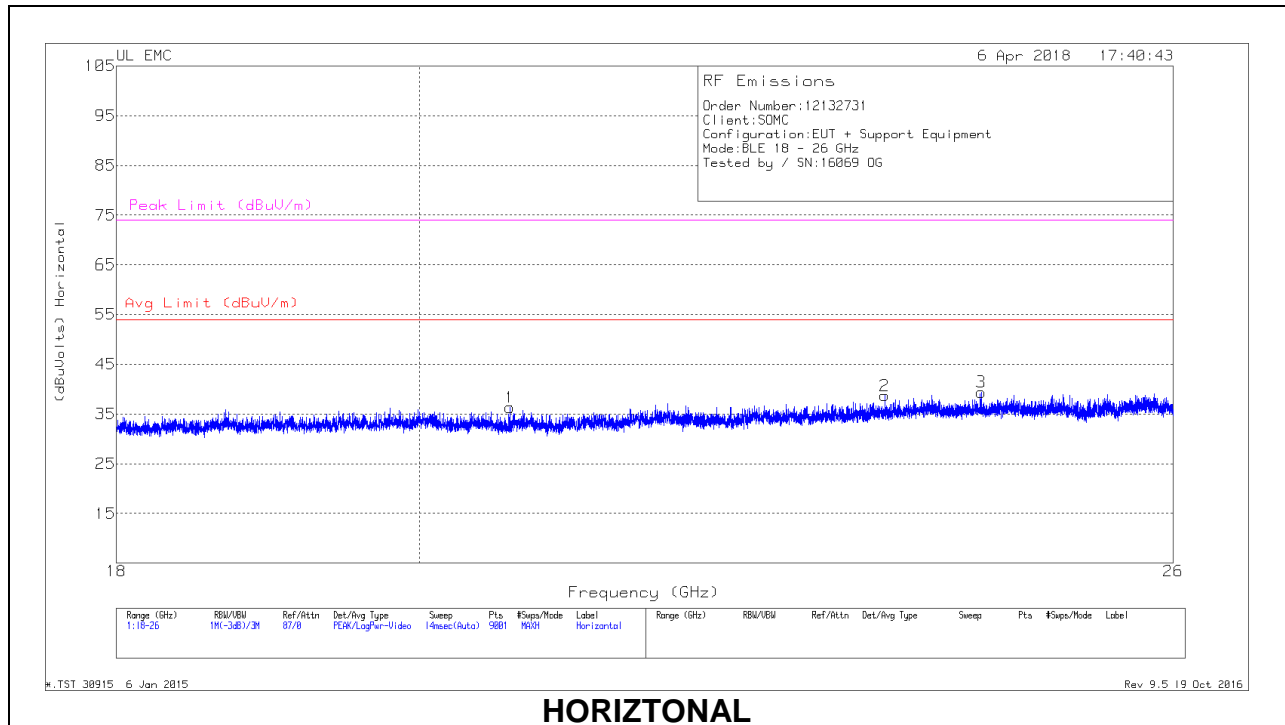

18 – 26GHz Data

Marker	Frequency (GHz)	Meter Reading (dBuV)	Det	T89 AF (dB/m)	Amp/Cbl (dB)	Dist Corr (dB)	Corrected Reading (dBuVolts)	Avg Limit (dBuV/m)	Margin (dB)	Peak Limit (dBuV/m)	PK Margin (dB)
1	20.642	38.62	Pk	32.7	-25.5	-9.5	36.32	54	-17.68	74	-37.68
2	23.516	39.69	Pk	33.2	-24.7	-9.5	38.69	54	-15.31	74	-35.31
3	24.318	39.58	Pk	33.7	-24.4	-9.5	39.38	54	-14.62	74	-34.62
4	21.3	38.28	Pk	33.2	-25.4	-9.5	36.58	54	-17.42	74	-37.42
5	22.496	38.29	Pk	33.4	-24.8	-9.5	37.39	54	-16.61	74	-36.61
6	25.688	39.96	Pk	34.1	-24.7	-9.5	39.86	54	-14.14	74	-34.14

Pk - Peak detector

10. AC POWER LINE CONDUCTED EMISSIONS

LIMITS

FCC §15.207 (a)

Frequency of Emission (MHz)	Conducted Limit (dBuV)	
	Quasi-peak	Average
0.15-0.5	66 to 56*	56 to 46*
0.5-5	56	46
5-30	60	50

*Decreases with the logarithm of the frequency.

RESULTS

LINE 1 RESULTS

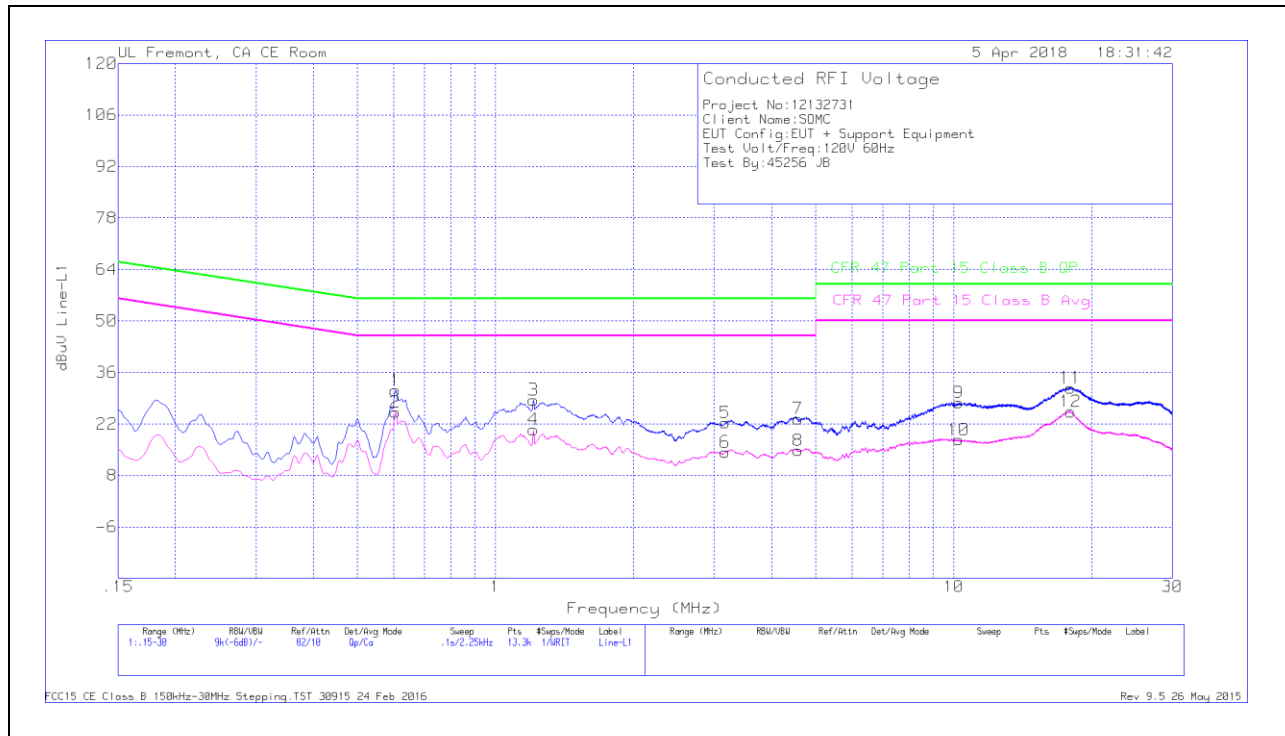

Range 1: Line-L1 .15 - 30MHz

Marker	Frequency (MHz)	Meter Reading (dBuV)	Det	LISN L1	LC Cables C1&C3	Limiter (dB)	Corrected Reading dBuV	CFR 47 Part 15 Class B QP	QP Margin (dB)	CFR 47 Part 15 Class B Avg	Av(CISPR) Margin (dB)
1	.6045	21.03	Qp	0	0	10.1	31.13	56	-24.87	-	-
2	.6045	15.09	Ca	0	0	10.1	25.19	-	-	46	-20.81
3	1.20975	18.28	Qp	0	.1	10.1	28.48	56	-27.52	-	-
4	1.20975	10.25	Ca	0	.1	10.1	20.45	-	-	46	-25.55
5	3.17288	12.08	Qp	0	.1	10.1	22.28	56	-33.72	-	-
6	3.174	4.1	Ca	0	.1	10.1	14.3	-	-	46	-31.7
7	4.57125	13.2	Qp	0	.1	10.1	23.4	56	-32.6	-	-
8	4.569	4.53	Ca	0	.1	10.1	14.73	-	-	46	-31.27
9	10.25025	17.34	Qp	0	.2	10.2	27.74	60	-32.26	-	-
10	10.248	7.24	Ca	0	.2	10.2	17.64	-	-	50	-32.36
11	17.98125	21.17	Qp	0	.3	10.3	31.77	60	-28.23	-	-
12	17.99025	14.71	Ca	0	.3	10.3	25.31	-	-	50	-24.69

Qp - Quasi-Peak detector

Ca - CISPR average detection

LINE 2 RESULTS

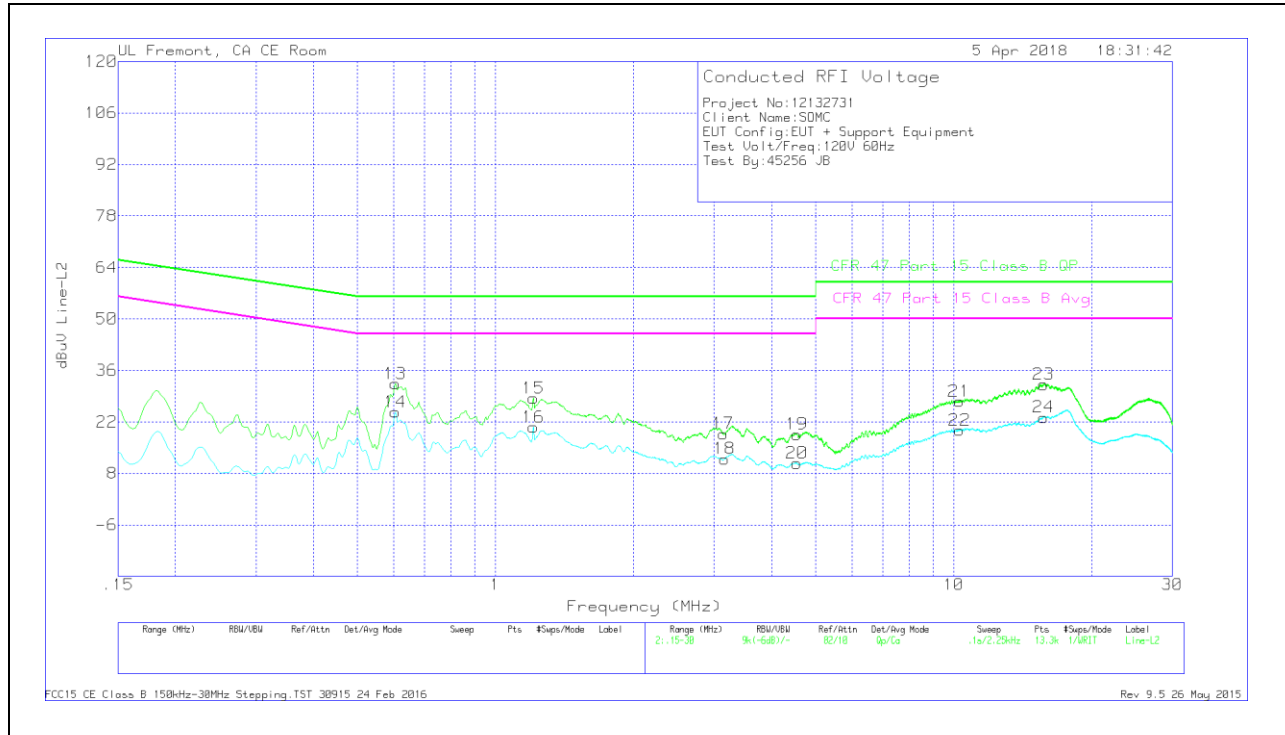

Range 2: Line-L2 .15 - 30MHz

Marker	Frequency (MHz)	Meter Reading (dBuV)	Det	LISN L2	LC Cables C2&C3	Limiter (dB)	Corrected Reading dBuV	CFR 47 Part 15 Class B QP	QP Margin (dB)	CFR 47 Part 15 Class B Avg	Av(CISPR) Margin (dB)
13	.6045	22.3	Qp	0	0	10.1	32.4	56	-23.6	-	-
14	.6045	14.59	Ca	0	0	10.1	24.69	-	-	46	-21.31
15	1.20975	18.21	Qp	0	.1	10.1	28.41	56	-27.59	-	-
16	1.20975	10.39	Ca	0	.1	10.1	20.59	-	-	46	-25.41
17	3.14025	8.59	Qp	0	.1	10.1	18.79	56	-37.21	-	-
18	3.16275	1.74	Ca	0	.1	10.1	11.94	-	-	46	-34.06
19	4.54875	8.41	Qp	0	.1	10.1	18.61	56	-37.39	-	-
20	4.54875	.57	Ca	0	.1	10.1	10.77	-	-	46	-35.23
21	10.28175	17.18	Qp	0	.2	10.2	27.58	60	-32.42	-	-
22	10.302	9.35	Ca	0	.2	10.2	19.75	-	-	50	-30.25
23	15.7155	21.56	Qp	0	.3	10.3	32.16	60	-27.84	-	-
24	15.7155	12.64	Ca	0	.3	10.3	23.24	-	-	50	-26.76

Qp - Quasi-Peak detector

Ca - CISPR average detection