



# **CERTIFICATION TEST REPORT**

**Report Number. :** 12380932-E5V1

**Applicant :** SONY MOBILE COMMUNICATIONS, INC.  
4-12-3 HIGASHI-SHINAGAWA  
SHINAGAWA-KU, TOKYO, 140-0002, JAPAN

**FCC ID :** PY7-12644J

**EUT Description :** GSM/WCDMA/LTE Phone with BT, DTS/UNII a/b/g/n/ac &  
NFC

**Test Standard(s) :** FCC 47 CFR PART 15 SUBPART E

**Date Of Issue:**

July 20, 2018

**Prepared by:**

UL Verification Services Inc.  
47173 Benicia Street  
Fremont, CA 94538 U.S.A.  
TEL: (510) 771-1000  
FAX: (510) 661-0888



NVLAP Lab code: 200065-0

---

## REPORT REVISION HISTORY

Rev.	Issue Date	Revisions	Revised By
V1	7/20/2018	Initial Issue	

## TABLE OF CONTENTS

<b>REPORT REVISION HISTORY .....</b>	<b>2</b>
<b>TABLE OF CONTENTS .....</b>	<b>3</b>
<b>1. ATTESTATION OF TEST RESULTS .....</b>	<b>6</b>
<b>2. TEST METHODOLOGY .....</b>	<b>7</b>
<b>3. FACILITIES AND ACCREDITATION .....</b>	<b>7</b>
<b>4. CALIBRATION AND UNCERTAINTY .....</b>	<b>8</b>
4.1. <i>MEASURING INSTRUMENT CALIBRATION .....</i>	<i>8</i>
4.2. <i>SAMPLE CALCULATION .....</i>	<i>8</i>
4.3. <i>MEASUREMENT UNCERTAINTY.....</i>	<i>8</i>
<b>5. EQUIPMENT UNDER TEST .....</b>	<b>9</b>
5.1. <i>EUT DESCRIPTION .....</i>	<i>9</i>
5.2. <i>MAXIMUM OUTPUT POWER.....</i>	<i>10</i>
5.3. <i>DESCRIPTION OF AVAILABLE ANTENNAS .....</i>	<i>11</i>
5.4. <i>SOFTWARE AND FIRMWARE.....</i>	<i>11</i>
5.5. <i>WORST-CASE CONFIGURATION AND MODE.....</i>	<i>12</i>
5.6. <i>DESCRIPTION OF TEST SETUP.....</i>	<i>13</i>
<b>6. MEASUREMENT METHOD.....</b>	<b>16</b>
<b>7. TEST AND MEASUREMENT EQUIPMENT .....</b>	<b>17</b>
<b>8. ANTENNA PORT TEST RESULTS .....</b>	<b>19</b>
8.1. <i>ON TIME AND DUTY CYCLE.....</i>	<i>19</i>
8.2. <i>26 dB BANDWIDTH.....</i>	<i>21</i>
8.2.1. <i>802.11a MODE IN THE 5.2 GHz BAND.....</i>	<i>22</i>
8.2.2. <i>802.11n HT20 MODE IN THE 5.2 GHz BAND .....</i>	<i>24</i>
8.2.3. <i>802.11n HT40 MODE IN THE 5.2 GHz BAND .....</i>	<i>26</i>
8.2.4. <i>802.11ac VHT80 MODE IN THE 5.2 GHz BAND .....</i>	<i>27</i>
8.2.5. <i>802.11a MODE IN THE 5.3 GHz BAND.....</i>	<i>28</i>
8.2.6. <i>802.11n HT20 MODE IN THE 5.3 GHz BAND .....</i>	<i>30</i>
8.2.7. <i>802.11n HT40 MODE IN THE 5.3 GHz BAND .....</i>	<i>32</i>
8.2.8. <i>802.11ac VHT80 MODE IN THE 5.3 GHz BAND .....</i>	<i>33</i>
8.2.9. <i>802.11a MODE IN THE 5.6 GHz BAND.....</i>	<i>34</i>
8.2.10. <i>802.11n HT20 MODE IN THE 5.6 GHz BAND .....</i>	<i>36</i>
8.2.11. <i>802.11n HT40 MODE IN THE 5.6 GHz BAND .....</i>	<i>38</i>
8.2.12. <i>802.11ac VHT80 MODE IN THE 5.6 GHz BAND .....</i>	<i>40</i>
8.2.13. <i>802.11a MODE IN THE 5.8 GHz BAND.....</i>	<i>42</i>
8.2.14. <i>802.11n HT20 MODE IN THE 5.8 GHz BAND .....</i>	<i>44</i>

---

8.2.15.	802.11n HT40 MODE IN THE 5.8 GHz BAND .....	46
8.2.16.	802.11ac VHT80 MODE IN THE 5.8 GHz BAND .....	47
8.3.	<i>99% BANDWIDTH</i> .....	48
8.3.1.	802.11a MODE IN THE 5.2 GHz BAND .....	49
8.3.2.	802.11n HT20 MODE IN THE 5.2 GHz BAND .....	51
8.3.3.	802.11n HT40 MODE IN THE 5.2 GHz BAND .....	53
8.3.4.	802.11ac VHT80 MODE IN THE 5.2 GHz BAND .....	54
8.3.5.	802.11a MODE IN THE 5.3 GHz BAND .....	55
8.3.6.	802.11n HT20 MODE IN THE 5.3 GHz BAND .....	57
8.3.7.	802.11n HT40 MODE IN THE 5.3 GHz BAND .....	59
8.3.8.	802.11ac VHT80 MODE IN THE 5.3 GHz BAND .....	60
8.3.9.	802.11a MODE IN THE 5.6 GHz BAND .....	61
8.3.10.	802.11n HT20 MODE IN THE 5.6 GHz BAND .....	63
8.3.11.	802.11n HT40 MODE IN THE 5.6 GHz BAND .....	65
8.3.12.	802.11ac VHT80 MODE IN THE 5.6 GHz BAND .....	67
8.3.13.	802.11a MODE IN THE 5.8 GHz BAND .....	69
8.3.14.	802.11n HT20 MODE IN THE 5.8 GHz BAND .....	71
8.3.15.	802.11n HT40 MODE IN THE 5.8 GHz BAND .....	73
8.3.16.	802.11ac VHT80 MODE IN THE 5.8 GHz BAND .....	74
8.4.	<i>6 dB BANDWIDTH</i> .....	75
8.4.1.	802.11a MODE IN THE 5.8 GHz BAND .....	76
8.4.2.	802.11n HT20 MODE IN THE 5.8 GHz BAND .....	78
8.4.3.	802.11n HT40 MODE IN THE 5.8 GHz BAND .....	80
8.4.4.	802.11ac VHT80 MODE IN THE 5.8 GHz BAND .....	82
8.5.	<i>OUTPUT POWER AND PSD</i> .....	83
8.5.1.	802.11a MODE IN THE 5.2 GHz BAND .....	87
8.5.2.	802.11n HT20 MODE IN THE 5.2 GHz BAND .....	89
8.5.3.	802.11n HT40 MODE IN THE 5.2 GHz BAND .....	91
8.5.4.	802.11ac VHT80 MODE IN THE 5.2 GHz BAND .....	93
8.5.5.	802.11a MODE IN THE 5.3 GHz BAND .....	95
8.5.6.	802.11n HT20 MODE IN THE 5.3 GHz BAND .....	97
8.5.7.	802.11n HT40 MODE IN THE 5.3 GHz BAND .....	99
8.5.8.	802.11ac VHT80 MODE IN THE 5.3 GHz BAND .....	101
8.5.9.	802.11a MODE IN THE 5.6 GHz BAND .....	103
8.5.10.	802.11n HT20 MODE IN THE 5.6 GHz BAND .....	106
8.5.11.	802.11n HT40 MODE IN THE 5.6 GHz BAND .....	109
8.5.12.	802.11ac VHT80 MODE IN THE 5.6 GHz BAND .....	112
8.5.13.	802.11a MODE IN THE 5.8 GHz BAND .....	114
8.5.14.	802.11n HT20 MODE IN THE 5.8 GHz BAND .....	116
8.5.15.	802.11n HT40 MODE IN THE 5.8 GHz BAND .....	118
8.5.16.	802.11ac VHT80 MODE IN THE 5.8 GHz BAND .....	120
<b>9.</b>	<b>RADIATED TEST RESULTS</b> .....	<b>122</b>
9.1.	<i>TRANSMITTER ABOVE 1 GHz</i> .....	123
9.1.1.	TX ABOVE 1 GHz 802.11a MODE IN THE 5.2 GHz BAND .....	123
9.1.2.	TX ABOVE 1 GHz 802.11n HT20 MODE IN THE 5.2 GHz BAND .....	131
9.1.3.	TX ABOVE 1 GHz 802.11n HT40 MODE IN THE 5.2 GHz BAND .....	139
9.1.4.	TX ABOVE 1 GHz 802.11ac VHT80 MODE IN THE 5.2 GHz BAND .....	145
9.1.5.	TX ABOVE 1 GHz 802.11a MODE IN THE 5.3 GHz BAND .....	149
9.1.6.	TX ABOVE 1 GHz 802.11n HT20 MODE IN THE 5.3 GHz BAND .....	157
9.1.7.	TX ABOVE 1 GHz 802.11n HT40 MODE IN THE 5.3 GHz BAND .....	165

---

9.1.8.	TX ABOVE 1 GHz 802.11ac VHT80 MODE IN THE 5.3 GHz BAND .....	171
9.1.9.	TX ABOVE 1 GHz 802.11a MODE IN THE 5.6 GHz BAND .....	175
9.1.10.	TX ABOVE 1 GHz 802.11n HT20 MODE IN THE 5.6 GHz BAND.....	187
9.1.11.	TX ABOVE 1 GHz 802.11n HT40 MODE IN THE 5.6 GHz BAND.....	199
9.1.12.	TX ABOVE 1 GHz 802.11ac VHT80 MODE IN THE 5.6 GHz BAND .....	211
9.1.13.	TX ABOVE 1 GHz 802.11a MODE IN THE 5.8 GHz BAND .....	221
9.1.14.	TX ABOVE 1 GHz 802.11n HT20 MODE IN THE 5.8 GHz BAND.....	231
9.1.15.	TX ABOVE 1 GHz 802.11n HT40 MODE IN THE 5.8 GHz BAND.....	241
9.1.16.	TX ABOVE 1 GHz 802.11ac VHT80 MODE IN THE 5.8 GHz BAND .....	249
9.2.	<i>Worst Case Below 30 MHz</i> .....	255
9.3.	<i>Worst Case Below 1 GHz</i> .....	256
9.4.	<i>Worst Case 18-26 GHz</i> .....	258
9.5.	<i>Worst Case 26-40 GHz</i> .....	260
<b>10.</b>	<b>AC POWER LINE CONDUCTED EMISSIONS</b> .....	<b>262</b>
10.1.1.	AC Power Line Norm .....	263
<b>11.</b>	<b>SETUP PHOTOS</b> .....	<b>265</b>

# 1. ATTESTATION OF TEST RESULTS

**COMPANY NAME:** SONY MOBILE COMMUNICATIONS, INC.  
4-12-3 HIGASHI-SHINAGAWA,  
SHINAGAWA-KU, TOKYO, 140-0002, JAPAN

**EUT DESCRIPTION:** GSM/WCDMA/LTE Phone with BT, DTS/UNII a/b/g/n/ac & NFC

**SERIAL NUMBER:** BH93001DDB, BH93004YDB (Conducted),  
BH930006D8, BH930043D8, BH930004D8 (Radiated)

**DATE TESTED:** JULY 7 – 18, 2018

APPLICABLE STANDARDS	
STANDARD	TEST RESULTS
CFR 47 Part 15 Subpart E	Complies

UL Verification Services Inc. tested the above equipment in accordance with the requirements set forth in the above standards. All indications of Pass/Fail in this report are opinions expressed by UL Verification Services Inc. based on interpretations and/or observations of test results. Measurement Uncertainties were not taken into account and are published for informational purposes only. The test results show that the equipment tested is capable of demonstrating compliance with the requirements as documented in this report.

**Note:** The results documented in this report apply only to the tested sample, under the conditions and modes of operation as described herein. This document may not be altered or revised in any way unless done so by UL Verification Services Inc. and all revisions are duly noted in the revisions section. Any alteration of this document not carried out by UL Verification Services Inc. will constitute fraud and shall nullify the document. This report must not be used by the client to claim product certification, approval, or endorsement by NVLAP, NIST, any agency of the Federal Government, or any agency of the U.S. government.

Approved & Released For  
UL Verification Services Inc. By:



Dan Corona  
CONSUMER TECHNOLOGY DIVISION  
Operations Leader  
UL Verification Services Inc.

Reviewed By:



Kiya Kedida  
CONSUMER TECHNOLOGY DIVISION  
Project Engineer  
UL Verification Services Inc.

## 2. TEST METHODOLOGY

The tests documented in this report were performed in accordance with FCC CFR 47 Part 2, FCC CFR 47 Part 15, FCC 14-30, FCC KDB 662911 D01 v02r01, FCC KDB 905462 D02 v02/D03 v01r02/D06 v02, FCC KDB 789033 D02 v02r01, FCC KDB 644545 D03 v01, ANSI C63.10-2013, FCC 06-96, and FCC KDB 905462 D02 and D03.

## 3. FACILITIES AND ACCREDITATION

The test sites and measurement facilities used to collect data are located at 47173 and 47266 Benicia Street, and 47658 Kato Road, Fremont, California, USA. Line conducted emissions are measured only at the 47173 address. The following table identifies which facilities were utilized for radiated emission measurements documented in this report. Specific facilities are also identified in the test results sections.

47173 Benicia Street	47266 Benicia Street	47658 Kato Rd
<input checked="" type="checkbox"/> Chamber A (ISED:2324B-1)	<input type="checkbox"/> Chamber D (ISED:22541-1)	<input type="checkbox"/> Chamber K (ISED:2324A-1)
<input checked="" type="checkbox"/> Chamber B (ISED:2324B-2)	<input type="checkbox"/> Chamber E (ISED:22541-2)	<input checked="" type="checkbox"/> Chamber L (ISED:2324A-3)
<input type="checkbox"/> Chamber C (ISED:2324B-3)	<input type="checkbox"/> Chamber F (ISED:22541-3)	
	<input type="checkbox"/> Chamber G (ISED:22541-4)	
	<input type="checkbox"/> Chamber H (ISED:22541-5)	

The above test sites and facilities are covered under FCC Test Firm Registration # 208313. Chambers A through C are covered under ISED company address code 2324B with site numbers 2324B -1 through 2324B-3, respectively. Chambers D through H are covered under ISED company address code 22541 with site numbers 22541 -1 through 22541-5, respectively. Chambers K and L are covered under ISED company address code 2324A with site numbers 2324A-1 and 2324A-3, respectively.

UL Verification Services Inc. is accredited by NVLAP, Laboratory Code 200065-0

## 4. CALIBRATION AND UNCERTAINTY

### 4.1. MEASURING INSTRUMENT CALIBRATION

The measuring equipment utilized to perform the tests documented in this report has been calibrated in accordance with the manufacturer's recommendations, and is traceable to recognized national standards.

### 4.2. SAMPLE CALCULATION

Where relevant, the following sample calculation is provided:

$$\begin{aligned} \text{Field Strength (dBuV/m)} &= \text{Measured Voltage (dBuV)} + \text{Antenna Factor (dB/m)} + \\ &\text{Cable Loss (dB)} - \text{Preamp Gain (dB)} \\ 36.5 \text{ dBuV} + 18.7 \text{ dB/m} + 0.6 \text{ dB} - 26.9 \text{ dB} &= 28.9 \text{ dBuV/m} \end{aligned}$$

### 4.3. MEASUREMENT UNCERTAINTY

Where relevant, the following measurement uncertainty levels have been estimated for tests performed on the apparatus:

PARAMETER	UNCERTAINTY
Worst Case Conducted Disturbance, 9KHz to 0.15 MHz	3.84 dB
Worst Case Conducted Disturbance, 0.15 to 30 MHz	3.65 dB
Worst Case Radiated Disturbance, 9KHz to 30 MHz	3.15 dB
Worst Case Radiated Disturbance, 30 to 1000 MHz	5.36 dB
Worst Case Radiated Disturbance, 1000 to 18000 MHz	4.32 dB
Worst Case Radiated Disturbance, 18000 to 26000 MHz	4.45 dB
Worst Case Radiated Disturbance, 26000 to 40000 MHz	5.24 dB

Uncertainty figures are valid to a confidence level of 95%.



---

## 5. EQUIPMENT UNDER TEST

### 5.1. EUT DESCRIPTION

The EUT is a GSM/WCDMA/LTE Phone with BT, DTS/UNII a/b/g/n/ac & NFC.

## 5.2. MAXIMUM OUTPUT POWER

The transmitter has a maximum conducted output power as follows:

### 5.2 GHz BAND

Frequency Range (MHz)	Mode	Output Power (dBm)	Output Power (mW)	Uncorrelated Chains Directional Gain	Maximum EIRP (dBm)	Maximum EIRP (mW)
<b>5.2 GHz band, 2TX</b>						
5180-5240	802.11a CDD	16.60	45.71	-3.99	12.61	18.24
5180-5240	802.11n HT20 CDD	16.54	45.08	-3.99	12.55	17.99
5190-5230	802.11n HT40 CDD	16.75	47.32	-3.99	12.76	18.88
5210	802.11ac VHT80 CDD	13.98	25.00	-3.99	9.99	9.98

### 5.3 GHz BAND

Frequency Range (MHz)	Mode	Output Power (dBm)	Output Power (mW)	Uncorrelated Chains Directional	Maximum EIRP (dBm)	Maximum EIRP (mW)
<b>5.3 GHz band, 2TX</b>						
5260 - 5320	802.11a CDD	16.56	45.29	-3.99	12.57	18.07
5260 - 5320	802.11n HT20 CDD	16.61	45.81	-3.99	12.62	18.28
5270 - 5310	802.11n HT40 CDD	16.50	44.67	-3.99	12.51	17.82
5290	802.11ac VHT80 CDD	13.61	22.96	-3.99	9.62	9.16

### 5.6 GHz BAND

Frequency Range (MHz)	Mode	Output Power (dBm)	Output Power (mW)	Uncorrelated Chains Directional	Maximum EIRP (dBm)	Maximum EIRP (mW)
<b>5.6 GHz band, 2TX</b>						
5500-5720	802.11a CDD	16.55	45.19	-2.64	13.91	24.60
5500-5720	802.11n HT20 CDD	16.66	46.34	-2.64	14.02	25.23
5510-5710	802.11n HT40 CDD	16.70	46.77	-2.64	14.06	25.47
5530-5690	802.11ac VHT80 CDD	17.22	52.72	-2.64	14.58	28.71

### 5.8 GHz BAND

Frequency Range (MHz)	Mode	Output Power (dBm)	Output Power (mW)	Uncorrelated Chains Directional	Maximum EIRP (dBm)	Maximum EIRP (mW)
<b>5.8 GHz band, 2TX</b>						
5745-5825	802.11a CDD	16.41	43.75	-4.35	12.06	16.07
5745-5825	802.11n HT20 CDD	16.33	42.95	-4.35	11.98	15.78
5755-5795	802.11n HT40 CDD	16.46	44.26	-4.35	12.11	16.26
5775	802.11ac VHT80 CDD	13.61	22.96	-4.35	9.26	8.43

TPC is not required since the maximum EIRP is less than 500 mW (27 dBm).

---

### 5.3. DESCRIPTION OF AVAILABLE ANTENNAS

The radio utilizes Loop Type antennas, with the following maximum gains:

Frequency (GHz)	Peak Antenna Gain (dBi)	
	Main (Chain 0)	Sub (Chain 1)
5180-5320	-4.30	-3.70
5500-5700	-4.20	-1.50
5725-5850	-4.50	-4.20

### 5.4. SOFTWARE AND FIRMWARE

The firmware installed in the EUT during testing was s\_atp\_0\_00436\_A\_12\_16.  
The test utility software used during testing was Tera Term Ver 4.79

---

## 5.5. WORST-CASE CONFIGURATION AND MODE

Radiated emissions below 1GHz, above 18GHz, and power line conducted emission were performed with the EUT set to transmit at the channel with highest output power as worst-case scenario.

Band edge and radiated emissions between 1GHz and 18GHz were performed with the EUT set to transmit at the highest power on low, middle and high channels.

The fundamental of the EUT was investigated in three orthogonal orientations X,Y,Z, it was determined that Y orientation was worst-case orientation; therefore, all final radiated testing was performed with the EUT in Y orientation with AC/DC Adapter orientation..

Worst-case data rates as provided by the client were:

802.11a mode: 6 Mbps

802.11n HT20mode: MCS0

802.11n HT40mode: MCS0

802.11ac VHT80 mode: MCS0

802.11ac VHT20 and VHT40 mode are different from 802.11nHT20 and HT40 only in control messages and have the same power settings.

The simultaneous mode (SISO 2.4GHz Chain 0 and 5GHz chain 1) was checked and stand-alone (MIMO) 2.4 GHz / 5GHz remain worst case.

NOTE: SISO mode is covered by MIMO mode due to same maximum tune-up limit (power).

## 5.6. DESCRIPTION OF TEST SETUP

### SUPPORT EQUIPMENT

Support Equipment List				
Description	Manufacturer	Model	Serial Number	FCC ID
Laptop	Lenovo	20B7S0A200	PC015REW	N/A
Desktop	Lenovo	ThinkCentre	MJ00QA59	N/A
AC Adapter	SONY	UCH20	3416W45305784	N/A
DC Power Supply	Ametek	XT 15-4	T463	N/A

### I/O CABLES (CONDUCTED TEST)

I/O Cable List						
Cable No	Port	# of identical ports	Connector Type	Cable Type	Cable Length (m)	Remarks
1	Antenna	1	RF	Shielded	0.2	To spectrum Analyzer
2	USB	1	USB Type C	Shielded	1	N/A
3	DC	1	DC	Shielded	0.3	N/A

### I/O CABLES (RADIATED AND CONDUCTED EMISSIONS)

I/O Cable List						
Cable No	Port	# of identical ports	Connector Type	Cable Type	Cable Length (m)	Remarks
1	USB	1	USB Type C	Shielded	3	N/A

### TEST SETUP

The EUT is connected to a test laptop/desktop during the tests. Test software exercised the radio card.

**CONDCUTED TEST SETUP DIAGRAM**

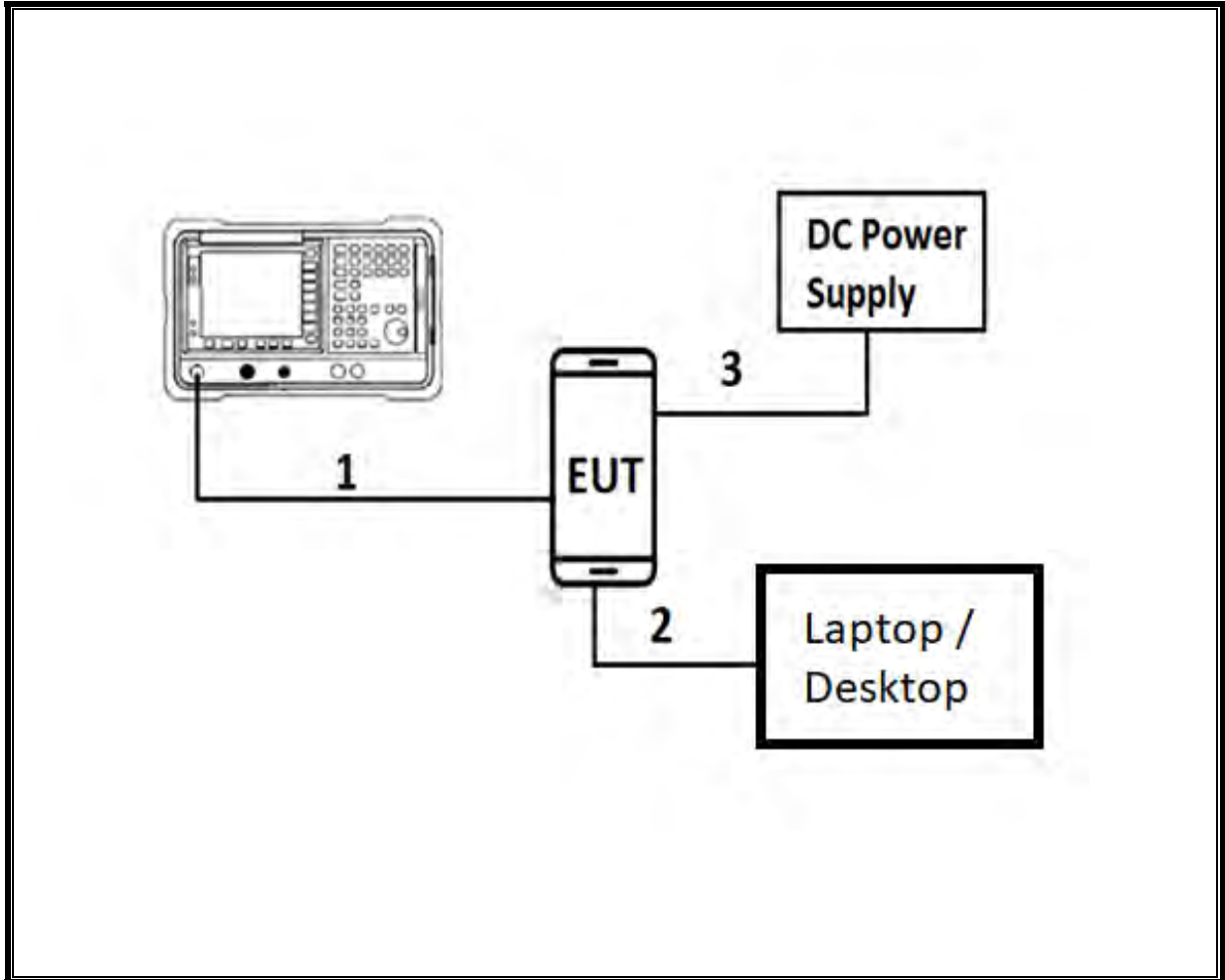

**RADIATED AND AC LINE CONDUCTED EMISSIONS SETUP DIAGRAM**

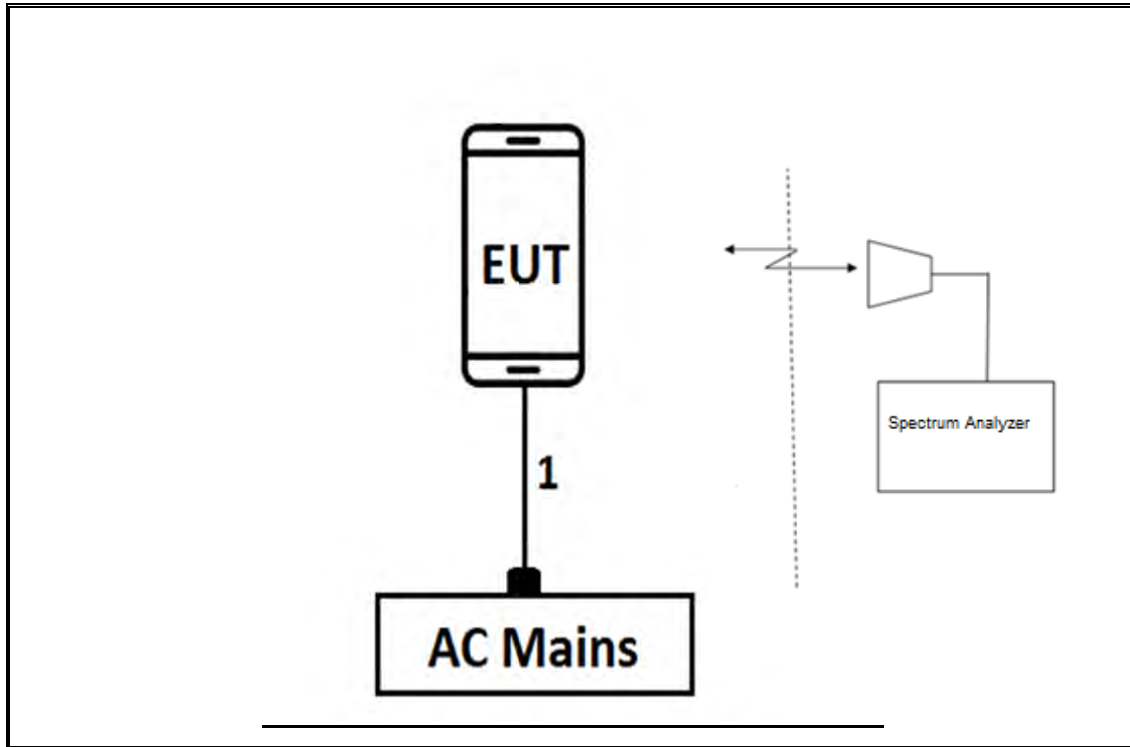

---

## 6. MEASUREMENT METHOD

On Time and Duty Cycle: KDB 789033 D02 v02r01, Section B.

6 dB Emission BW: KDB 789033 D02 v02r01, Section C.2

26 dB Emission BW: KDB 789033 D02 v02r01, Section C.1

99% Occupied BW: KDB 789033 D02 v02r01, Section D.

Conducted Output Power: KDB 789033 D02 v02r01, Section E.3.b (Method PM-G) and KDB 789033 D02 v02r01, Section E.2.b (Method SA-1)

Power Spectral Density: KDB 789033 D02 v02r01, Section F

Unwanted emissions in restricted bands: KDB 789033 D02 v02r01, Sections G.3, G.4, G.5, and G.6.

Unwanted emissions in non-restricted bands: KDB 789033 D02 v02r01, Sections G.3, G.4, and G.5.

AC Power Line Conducted Emissions: ANSI C63.10-2013, Section 6.2.



## 7. TEST AND MEASUREMENT EQUIPMENT

The following test and measurement equipment was utilized for the tests documented in this report:

TEST EQUIPMENT LIST				
Description	Manufacturer	Model	ID Num	Cal Due
Amplifier, 100kHz to 1GHz, 32dB	Hewlet Packard	8447D	T15	08/14/2018
Antenna, Broadband Hybrid, 30MHz to 2000MHz	Sunol Sciences Corp.	JB1	T130	10/16/2018
Antenna, Horn 1-18GHz	ETS-Lindgren	3117	T863	06/21/2019
Antenna, Horn 1-18GHz	ETS-Lindgren	3117	T345	04/25/2019
Antenna, Horn 1-18GHz	ETS-Lindgren	3117	T4294	04/30/2019
RF Amplifier	MITEQ	AFS42-00101800-25-S-42	T1165	04/23/2019
RF Amplifier	MITEQ	AFS42-00101800-25-S-42	T1568	06/21/2019
RF Amplifier	MITEQ	AFS42-00101800-25-S-42	T493	04/03/2019
Amplifier, 1 to 8GHz, 35dB	Miteq Inc.	AMF-4D-01000800-30-29P	T1573	04/03/2019
Amplifier 1-8GHz 30dB gain	L3 Narda	AMF-4D-01000800-30-29P	167495	06/22/2019
Amplifier, 1 to 8GHz, 35dB	Miteq Inc.	AMF-4D-01000800-30-29P	T1156	04/03/2019
EMI TEST RECEIVER	Rohde & Schwarz	ESW44	PRE0179522	05/11/2019
Spectrum Analyzer, PSA, 3Hz to 44GHz	Agilent (Keysight) Technologies	N9030A	T1466	04/16/2019
Spectrum Analyzer, PXA, 3Hz to 44GHz	Agilent (Keysight) Technologies	N9030A	T1450	02/05/2019
Spectrum Analyzer, PXA, 3Hz to 44GHz	Agilent (Keysight) Technologies	N9030A	T1113	12/21/2018
Spectrum Analyzer, PSA, 3Hz to 44GHz	Agilent (Keysight) Technologies	N9030A	T1454	01/08/2019
Spectrum Analyzer, PSA, 3Hz to 44GHz	Agilent (Keysight) Technologies	N9030A	T146	07/18/2018
Power Meter, P-series single channel	Agilent (Keysight) Technologies	N1911A	T1271	07/17/2018
Power Sensor, P-series, 50MHz to 18GHz, Wideband	Agilent (Keysight) Technologies	N1921A	T1225	04/10/2019
Filter, HPF 6.0GHz	MICRO-TRONICS	HPS17542	T1017	06/21/2019
Filter, HPF 6.0GHz	MICRO-TRONICS	HPS17542	T483	04/03/2019
Filter, HPF 6.0GHz	MICRO-TRONICS	HPS17542	T484	04/03/2019
Filter, LPF 5.0GHz	MICRO-TRONICS	LPS17541	T1020	06/21/2019
Filter, LPF 5.0GHz	MICRO-TRONICS	LPS17541	T482	04/03/2019
Filter, LPF 5.0GHz	MICRO-TRONICS	LPS17541	T481	04/03/2019
Antenna, Active Loop 9kHz-30MHz	Com-Power Corp.	AL-130R	T1866	10/10/2018
18 - 26.5 GHz Horn Antenna	Seavey Division	MWH-1826/B	T89	01/18/2019
26.5 - 40 GHz Horn Antenna	ARA	MWH-2640/B	T90	08/25/2018
Pre-Amp 1-26.5 GHz	Agilent	8449B	T404	03/09/2019
Pre-Amp, 26-40GHz	MITEQ	NSTTA2640-35-HG	T1864	03/09/2019
EMI Reciever	Rohde & Schwarz	ESR	T1436	02/21/2019
L.I.S.N.	FCC INC.	FCC LISN 50/250	T1310	06/15/2019
L.I.S.N.	FCC INC.	FCC LISN 50/250	T24	03/06/2019
Thermometer - Digital	Control Company	14-650-118	PRE0177862	02/22/2019

---

UL AUTOMATION SOFTWARE			
Radiated Software	UL	UL EMC	Ver 9.5, June 22, 2018
Antenna Port Software	UL	UL EMC	Ver 8.4, June 12, 2018

NOTE: \*testing was completed before equipment calibration expiration date.

## 8. ANTENNA PORT TEST RESULTS

### 8.1. ON TIME AND DUTY CYCLE

#### LIMITS

None; for reporting purposes only.

#### PROCEDURE

KDB 789033 Zero-Span Spectrum Analyzer Method.

#### ON TIME AND DUTY CYCLE RESULTS

Mode	ON Time B (msec)	Period (msec)	Duty Cycle x (linear)	Duty Cycle (%)	Duty Cycle Correction Factor (dB)	1/B Minimum VBW (kHz)
802.11a CDD	2.028	2.064	0.983	98.26%	0.00	0.010
802.11n HT20 CDD	2.508	2.564	0.978	97.82%	0.10	0.399
802.11n HT40 CDD	1.227	1.310	0.937	93.66%	0.28	0.815
802.11ac VHT80 CDD	0.592	0.675	0.877	87.72%	0.57	1.689

**DUTY CYCLE PLOTS**



**DUTY CYCLE 802.11a CDD MODE**



**DUTY CYCLE 802.11n HT20 CDD MODE**



**DUTY CYCLE 802.11n HT40 CDD MODE**



**DUTY CYCLE 802.11ac VHT80 CDD MODE**

---

## **8.2. 26 dB BANDWIDTH**

### **LIMITS**

None; for reporting purposes only.

### **RESULTS**

### 8.2.1. 802.11a MODE IN THE 5.2 GHz BAND

#### 2TX Antenna 1 + Antenna 2 CDD MODE

Channel	Frequency (MHz)	26 dB Bandwidth Chain 0 (MHz)	26 dB Bandwidth Chain 1 (MHz)
Low	5180	21.65	21.80
Mid	5200	22.70	21.55
High	5240	22.40	22.80

#### LOW CHANNEL

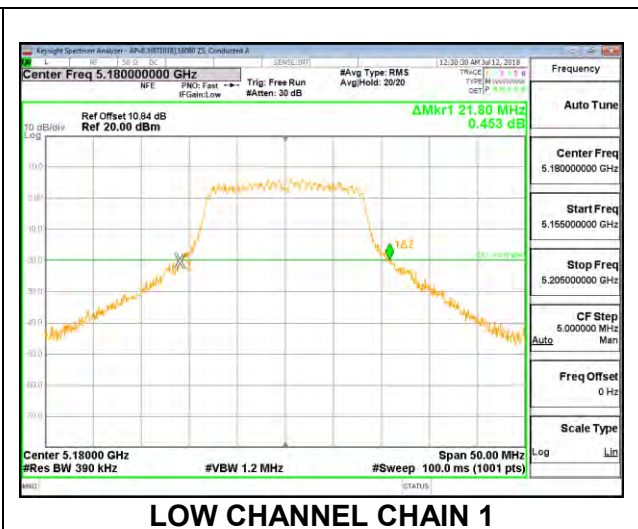
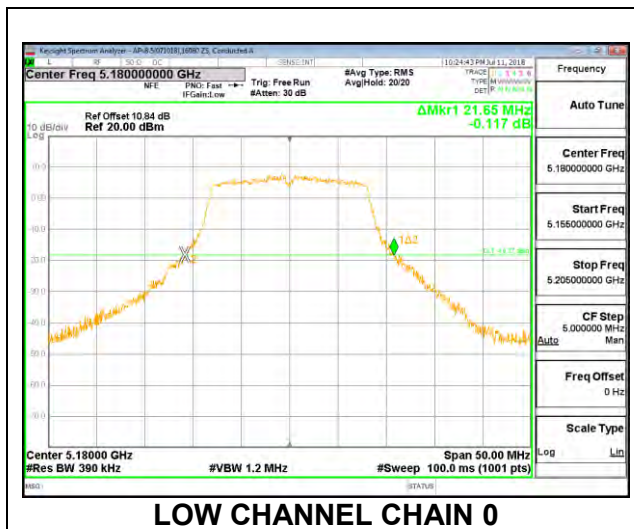

#### MID CHANNEL

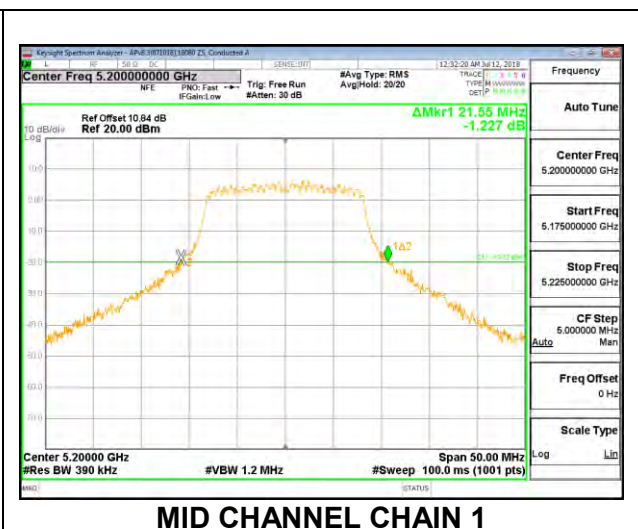
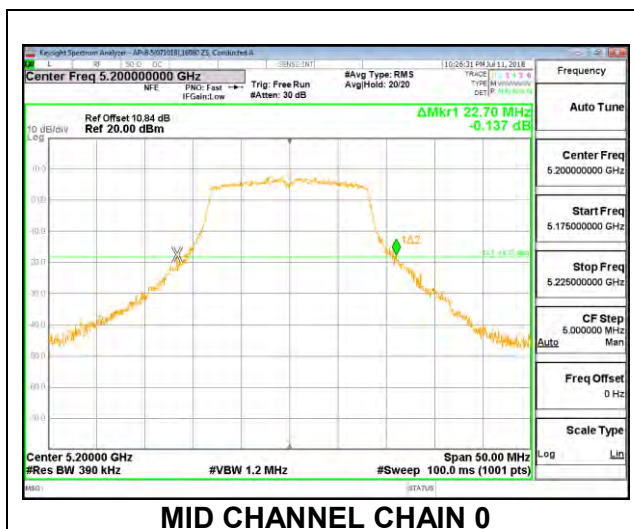

### HIGH CHANNEL

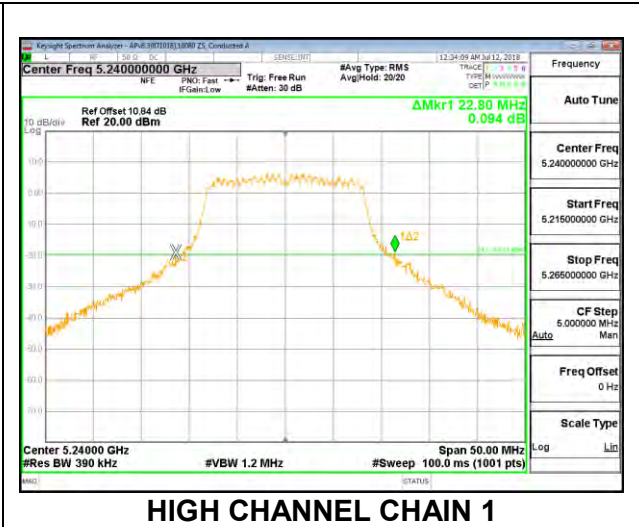
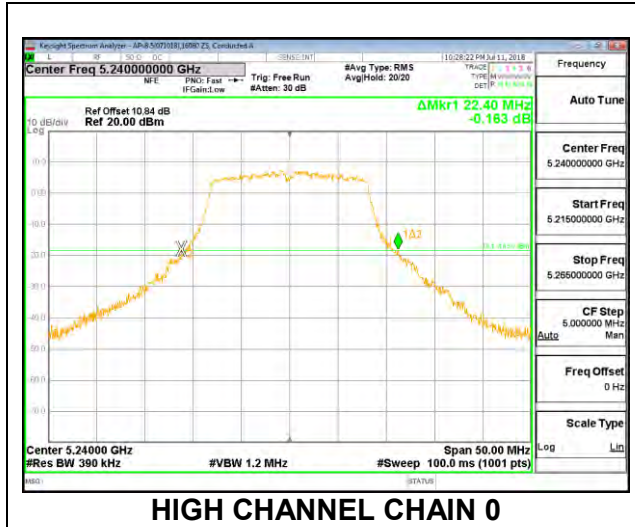

### 8.2.2. 802.11n HT20 MODE IN THE 5.2 GHz BAND

#### 2TX Antenna 1 + Antenna 2 CDD MODE

Channel	Frequency (MHz)	26 dB Bandwidth Chain 0 (MHz)	26 dB Bandwidth Chain 1 (MHz)
Low	5180	23.05	22.60
Mid	5200	22.90	23.45
High	5240	23.00	23.30

#### LOW CHANNEL

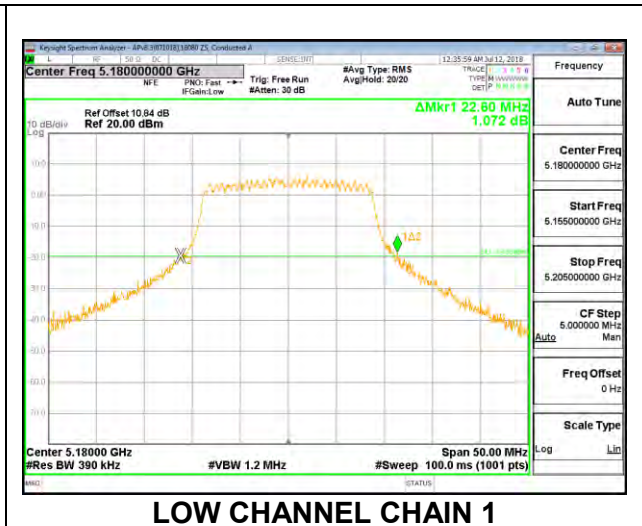
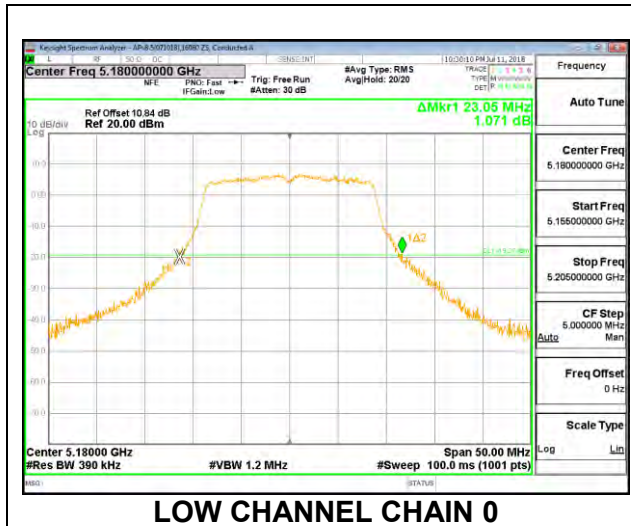

#### MID CHANNEL

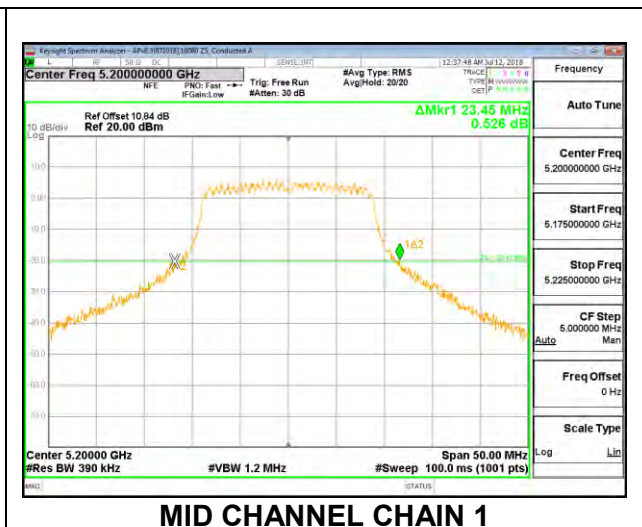
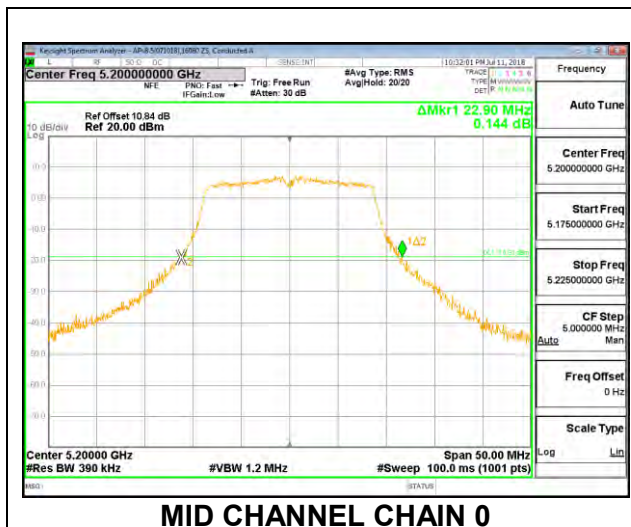



### HIGH CHANNEL

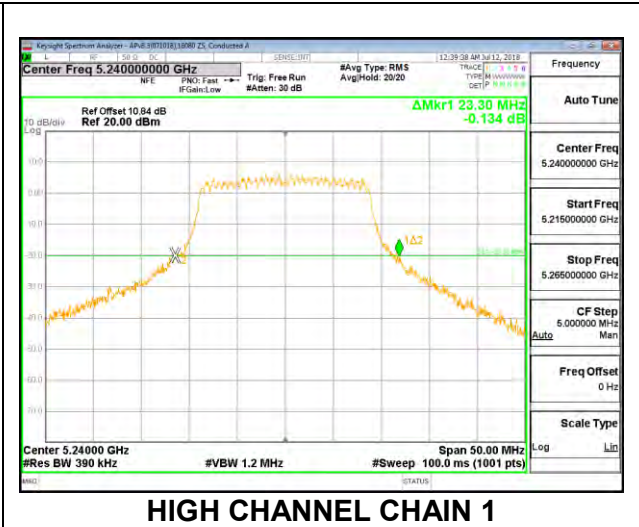
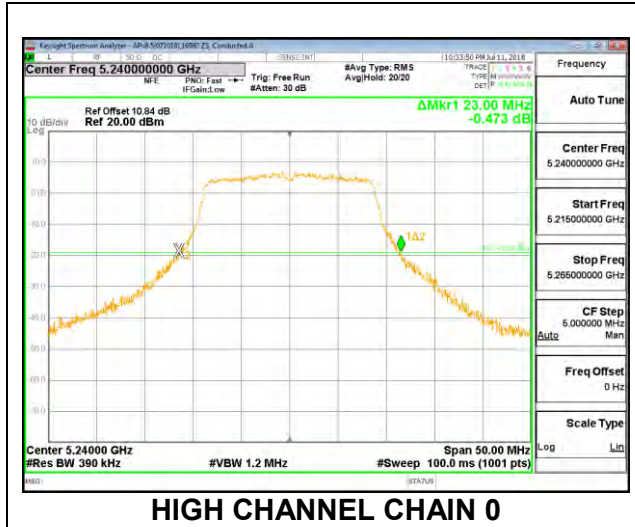

### 8.2.3. 802.11n HT40 MODE IN THE 5.2 GHz BAND

#### 2TX Antenna 1 + Antenna 2 CDD MODE

Channel	Frequency (MHz)	26 dB Bandwidth Chain 0 (MHz)	26 dB Bandwidth Chain 1 (MHz)
Low	5190	41.40	41.10
High	5230	41.70	41.20

#### LOW CHANNEL

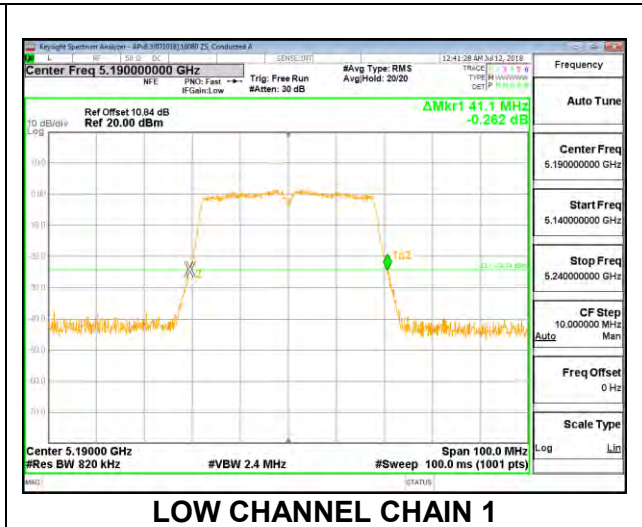
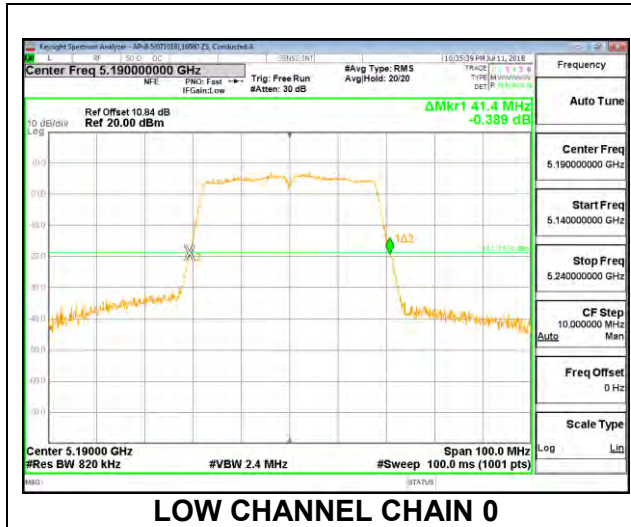

#### HIGH CHANNEL

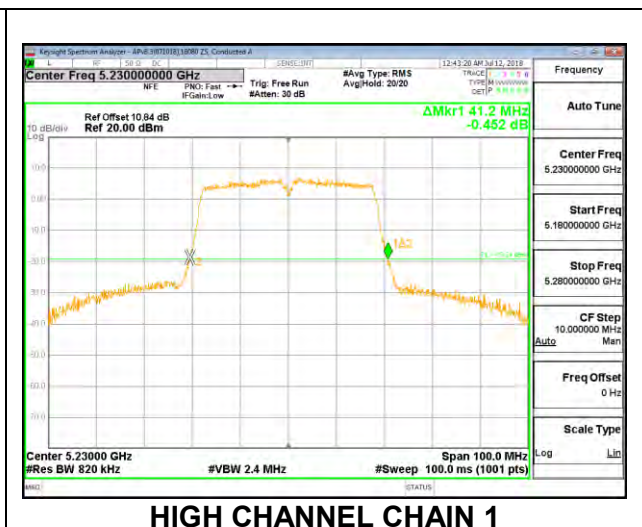
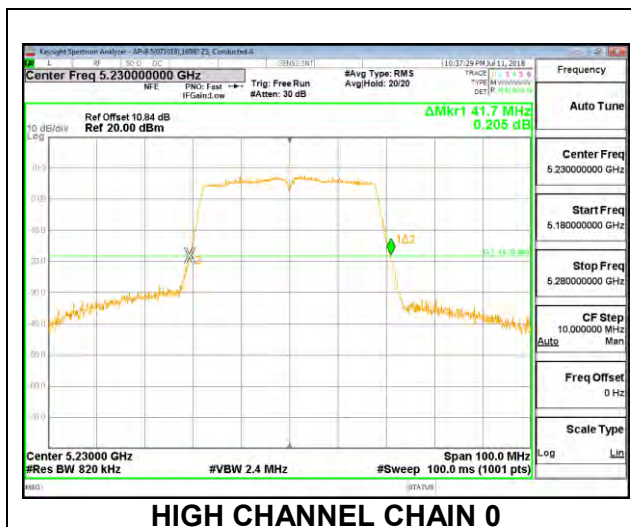

**8.2.4. 802.11ac VHT80 MODE IN THE 5.2 GHz BAND**

**2TX Antenna 1 + Antenna 2 CDD MODE**

Channel	Frequency (MHz)	26 dB Bandwidth Chain 0 (MHz)	26 dB Bandwidth Chain 1 (MHz)
Mid	5210	83.80	83.60

**MID CHANNEL**

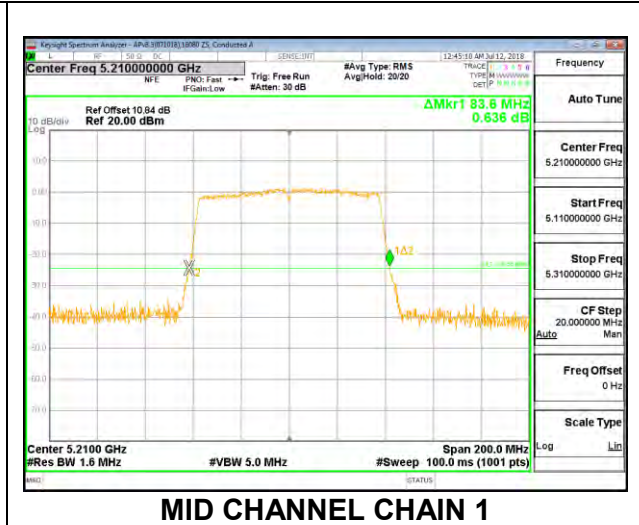
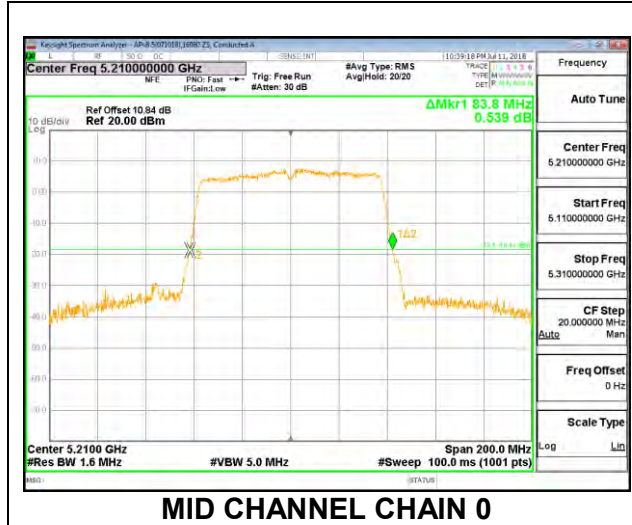

### 8.2.5. 802.11a MODE IN THE 5.3 GHz BAND

#### 2TX Antenna 1 + Antenna 2 CDD MODE

Channel	Frequency (MHz)	26 dB Bandwidth Chain 0 (MHz)	26 dB Bandwidth Chain 1 (MHz)
Low	5260	21.50	21.85
Mid	5300	22.35	21.55
High	5320	22.00	22.00

#### LOW CHANNEL

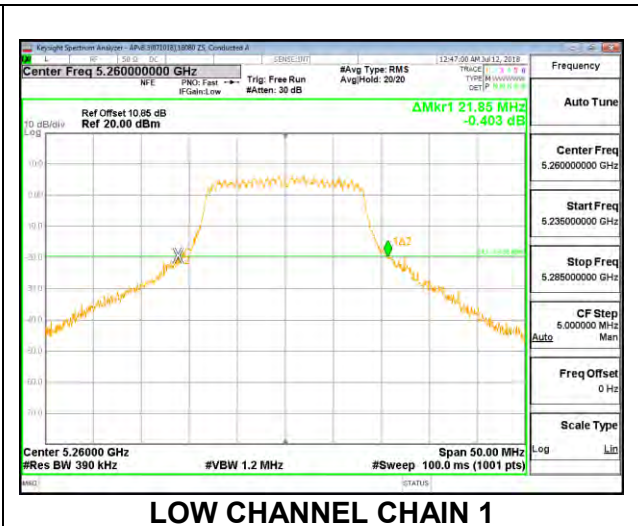
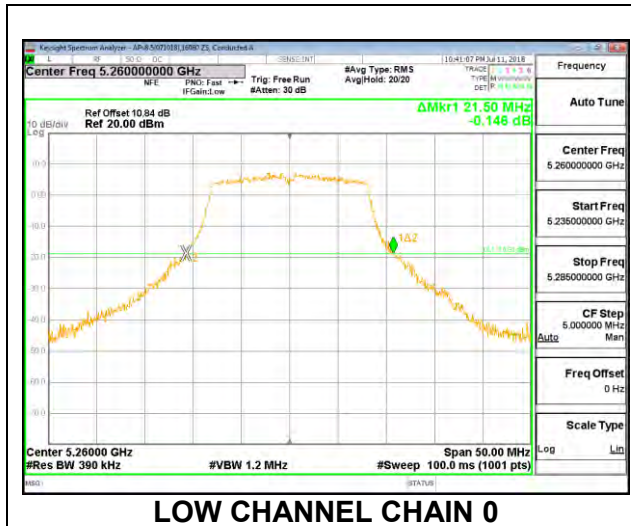

#### MID CHANNEL

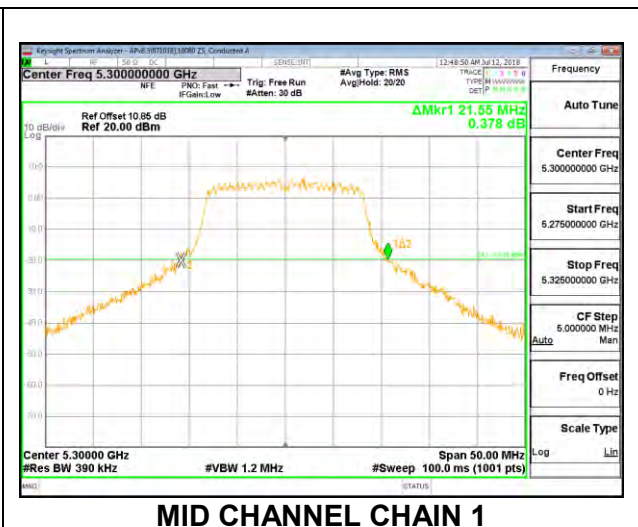
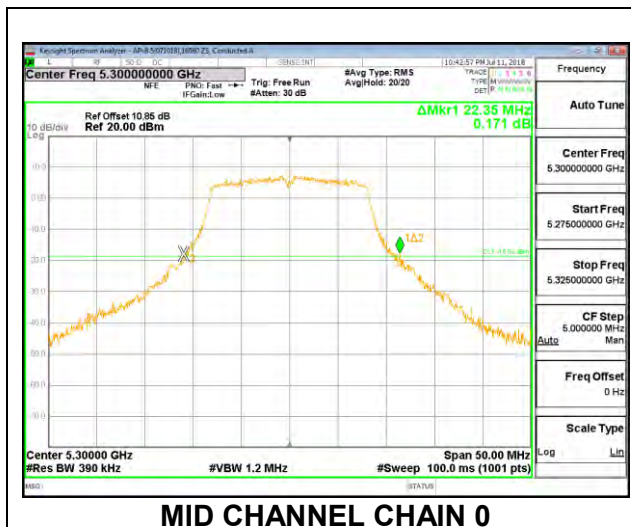

### HIGH CHANNEL

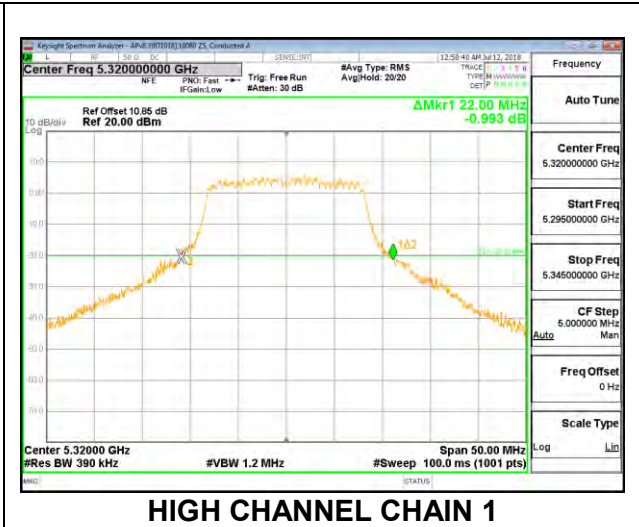
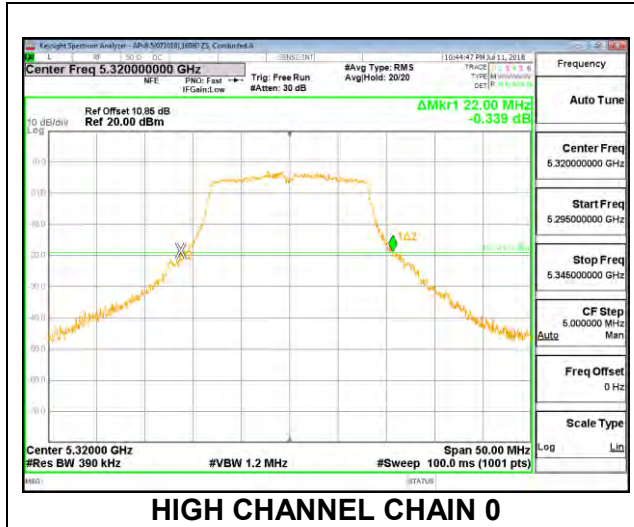

### 8.2.6. 802.11n HT20 MODE IN THE 5.3 GHz BAND

#### 2TX Antenna 1 + Antenna 2 CDD MODE

Channel	Frequency (MHz)	26 dB Bandwidth Chain 0 (MHz)	26 dB Bandwidth Chain 1 (MHz)
Low	5260	22.70	23.20
Mid	5300	22.85	23.10
High	5320	22.90	22.90

#### LOW CHANNEL

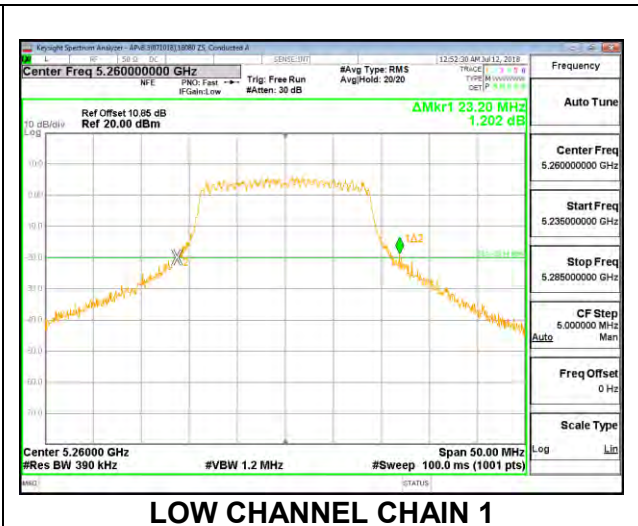
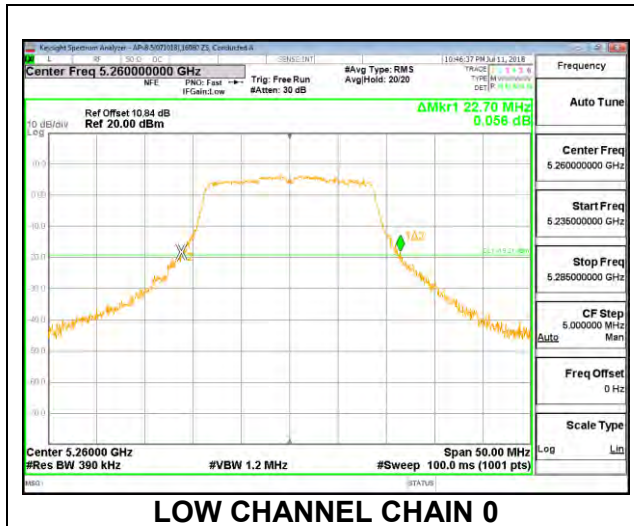

#### MID CHANNEL

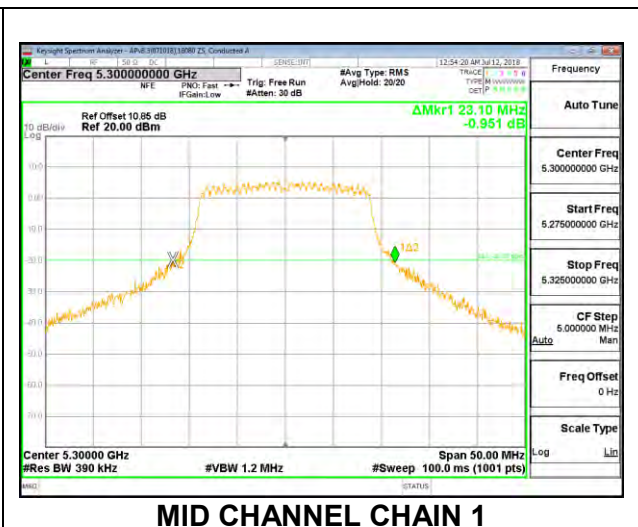
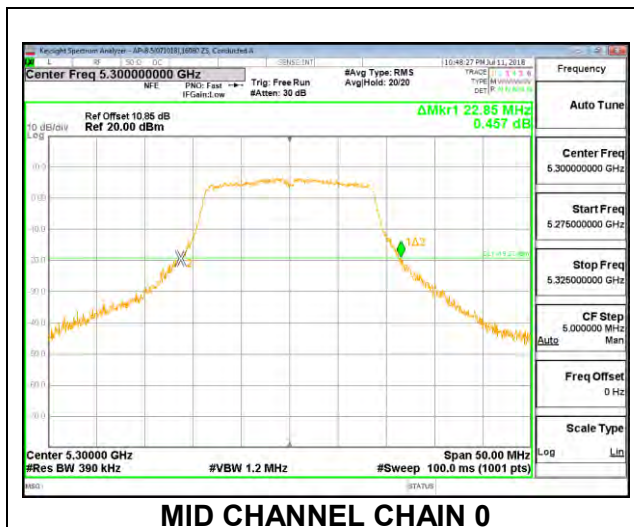

**HIGH CHANNEL**

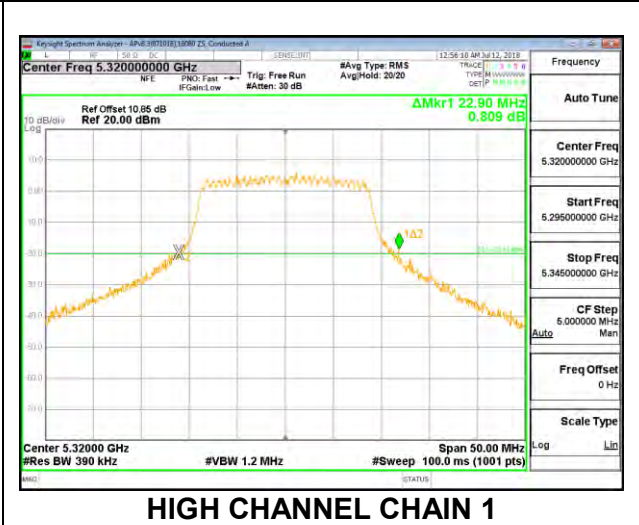
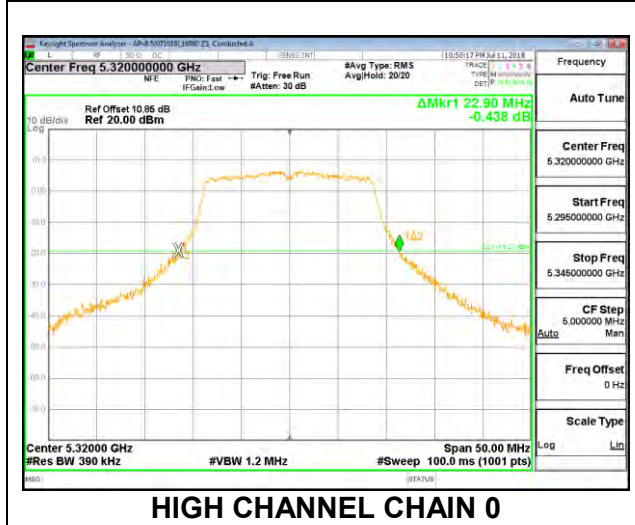

### 8.2.7. 802.11n HT40 MODE IN THE 5.3 GHz BAND

#### 2TX Antenna 1 + Antenna 2 CDD MODE

Channel	Frequency (MHz)	26 dB Bandwidth Chain 0 (MHz)	26 dB Bandwidth Chain 1 (MHz)
Low	5270	41.80	41.10
High	5310	41.90	41.10

#### LOW CHANNEL

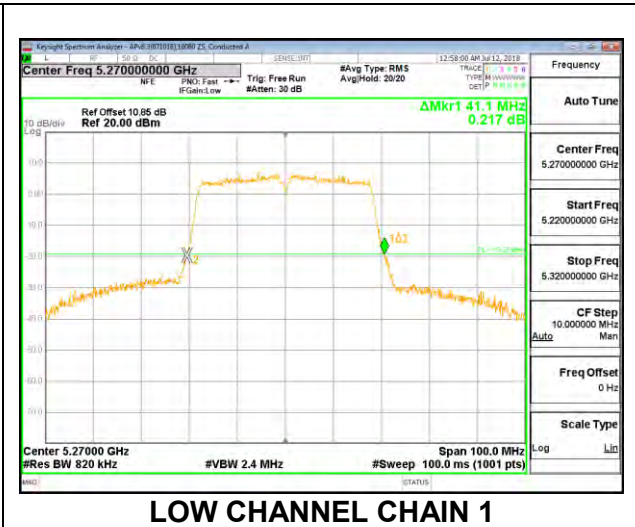
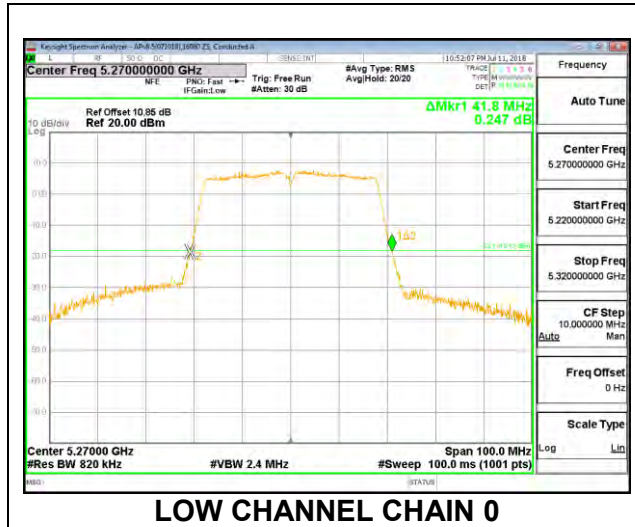

#### HIGH CHANNEL

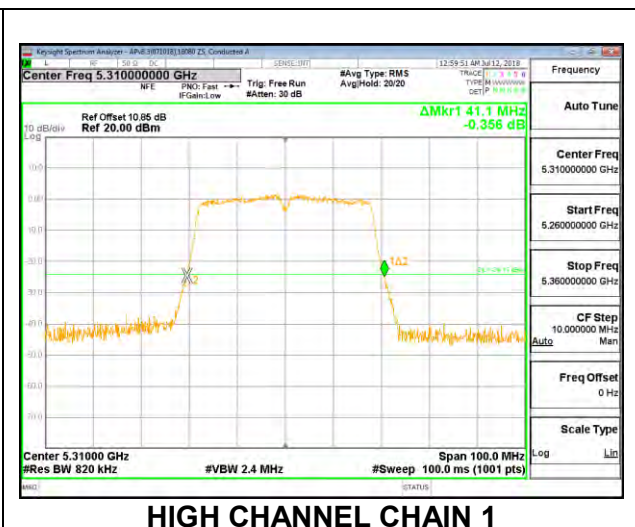
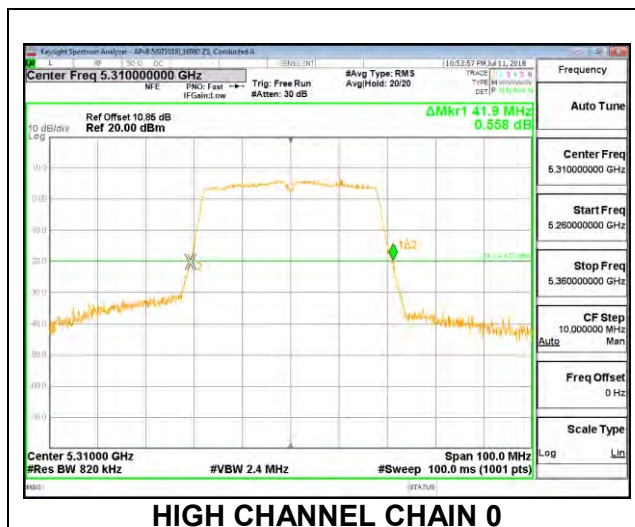



**8.2.8. 802.11ac VHT80 MODE IN THE 5.3 GHz BAND**

**2TX Antenna 1 + Antenna 2 CDD MODE**

Channel	Frequency (MHz)	26 dB Bandwidth Chain 0 (MHz)	26 dB Bandwidth Chain 1 (MHz)
Mid	5290	84.20	83.60

**MID CHANNEL**

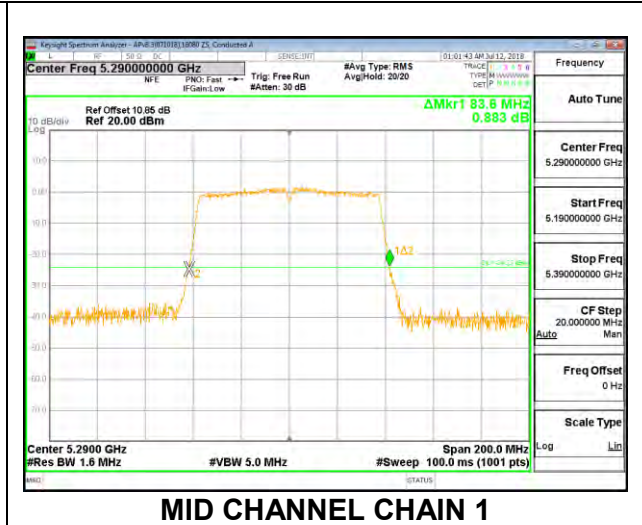
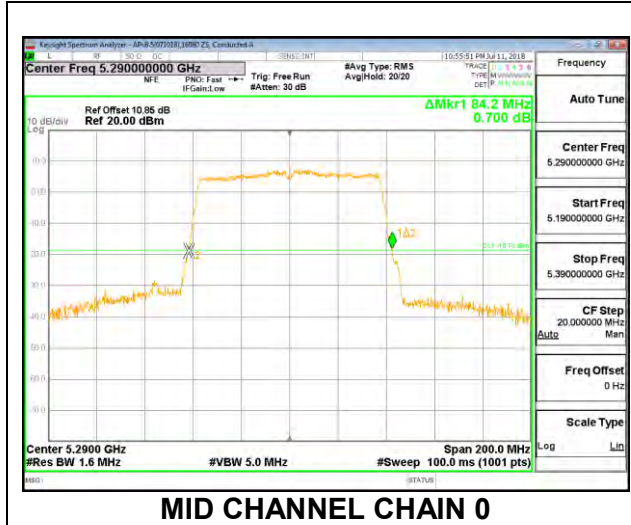

### 8.2.9. 802.11a MODE IN THE 5.6 GHz BAND

#### 2TX Antenna 1 + Antenna 2 CDD MODE

Channel	Frequency (MHz)	26 dB Bandwidth Chain 0 (MHz)	26 dB Bandwidth Chain 1 (MHz)
Low	5500	21.40	22.05
Mid	5580	21.60	21.15
High	5700	21.95	21.10
144	5720	<b>22.05</b>	<b>22.40</b>

#### LOW CHANNEL

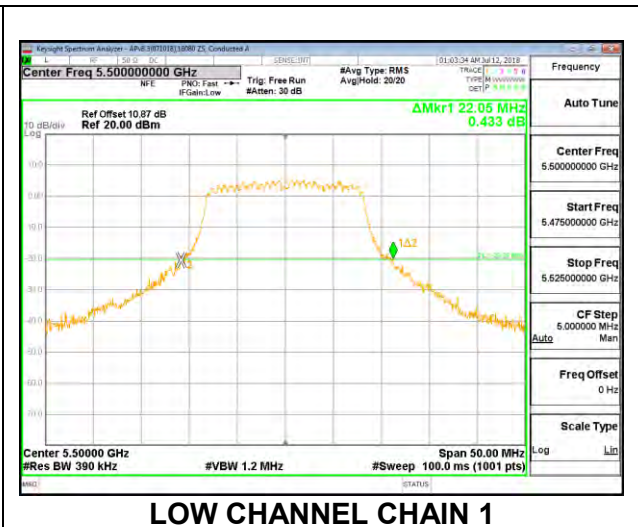
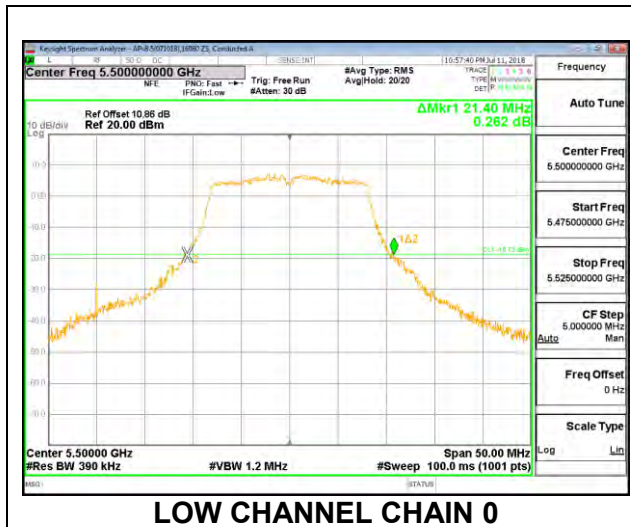

#### MID CHANNEL

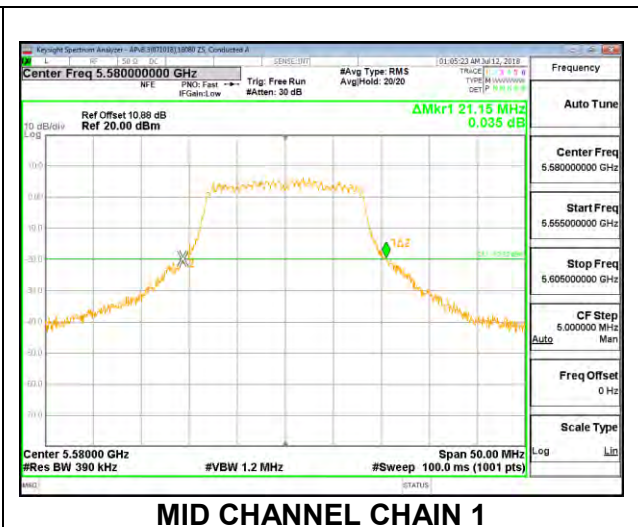
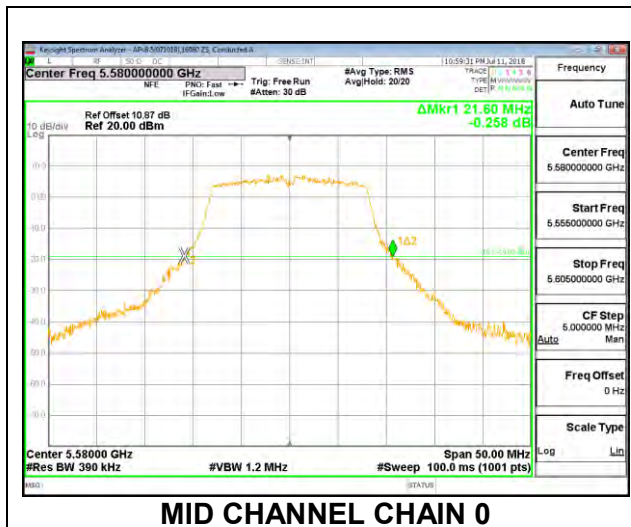

**HIGH CHANNEL**

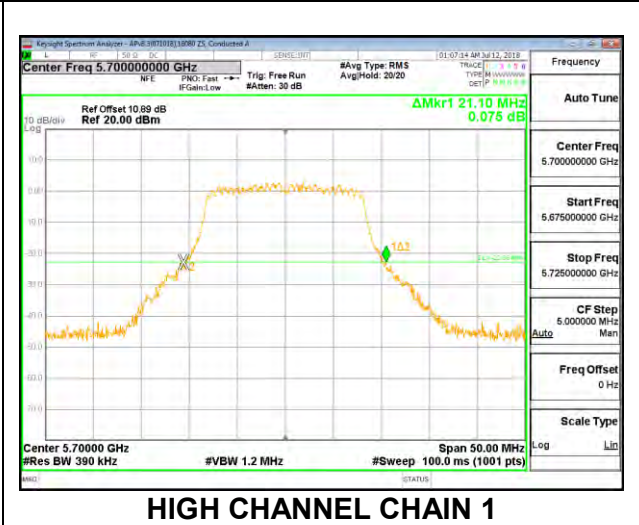
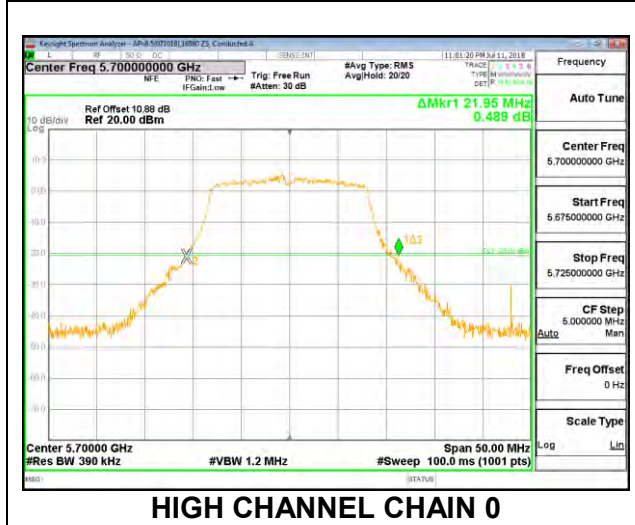

**CHANNEL 144**

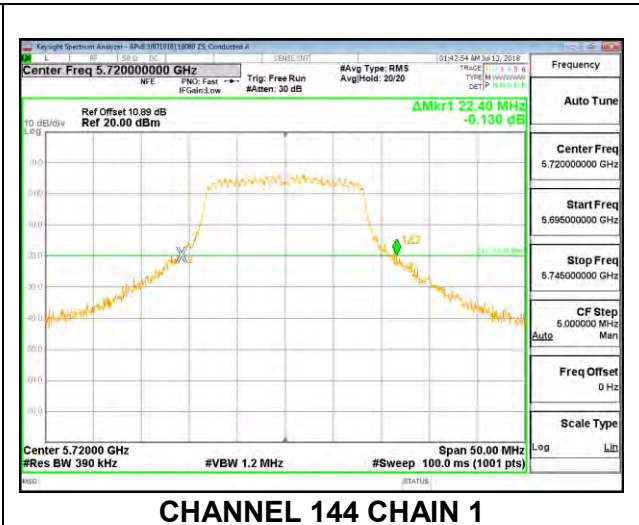
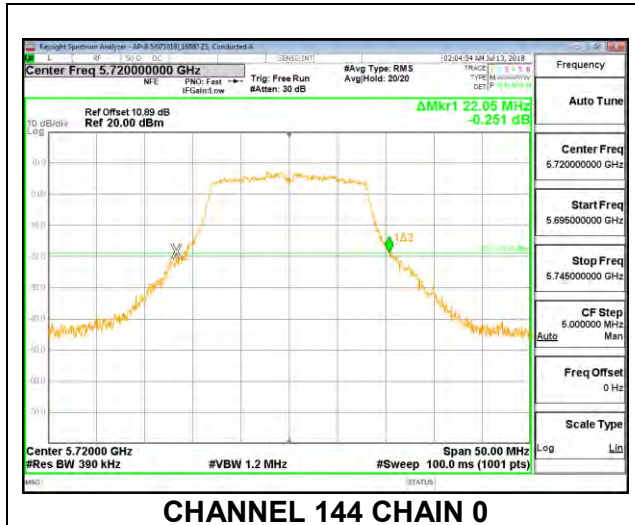

**8.2.10. 802.11n HT20 MODE IN THE 5.6 GHz BAND**

**2TX Antenna 1 + Antenna 2 CDD MODE**

Channel	Frequency (MHz)	26 dB Bandwidth Chain 0 (MHz)	26 dB Bandwidth Chain 1 (MHz)
Low	5500	23.40	23.40
Mid	5580	22.95	22.90
High	5700	22.55	21.45
144	5720	23.20	23.25

**LOW CHANNEL**

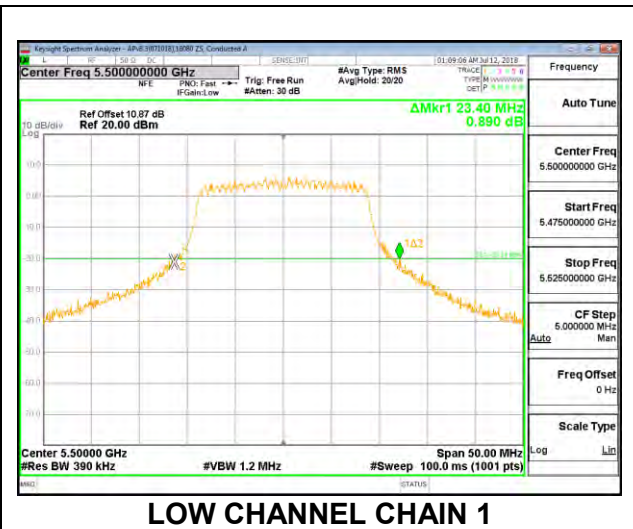
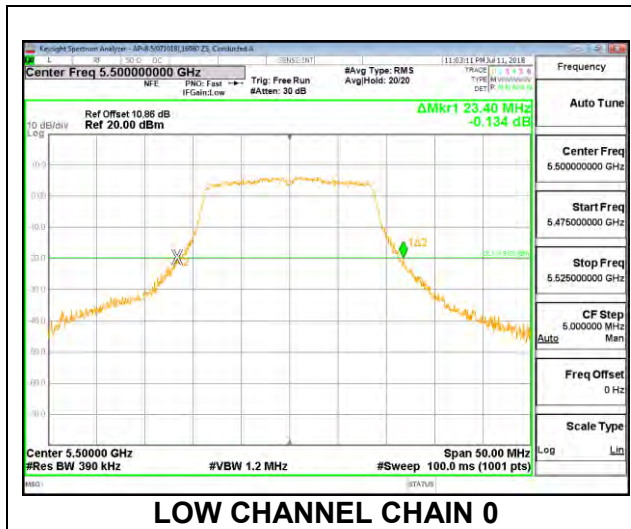

**MID CHANNEL**

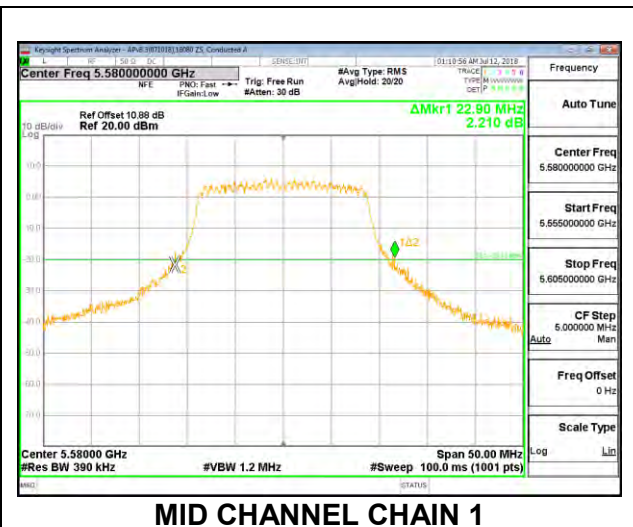
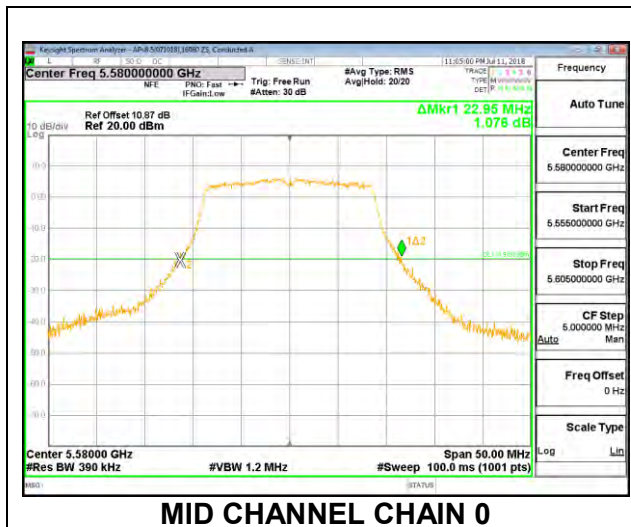

**HIGH CHANNEL**

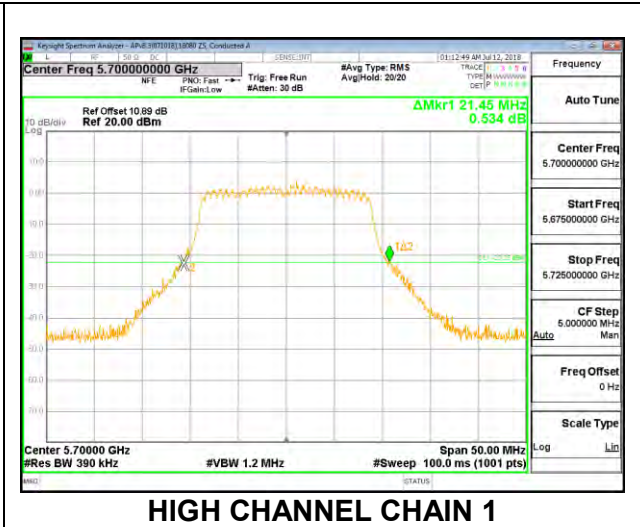
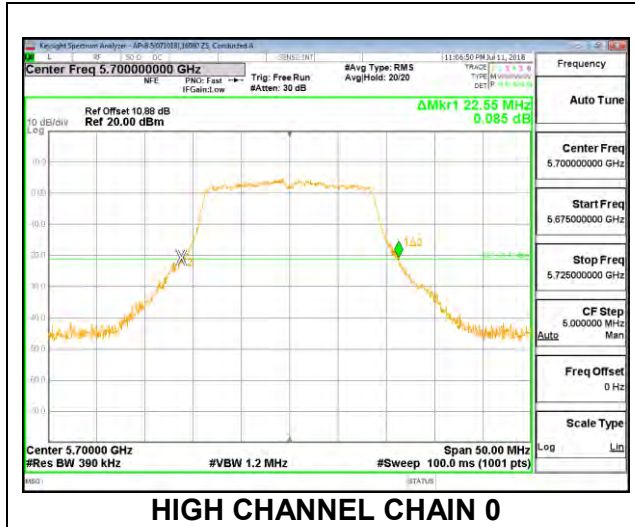

**CHANNEL 144**

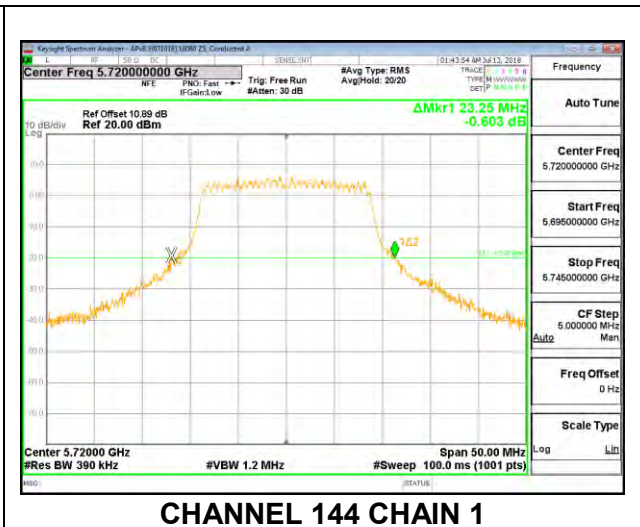
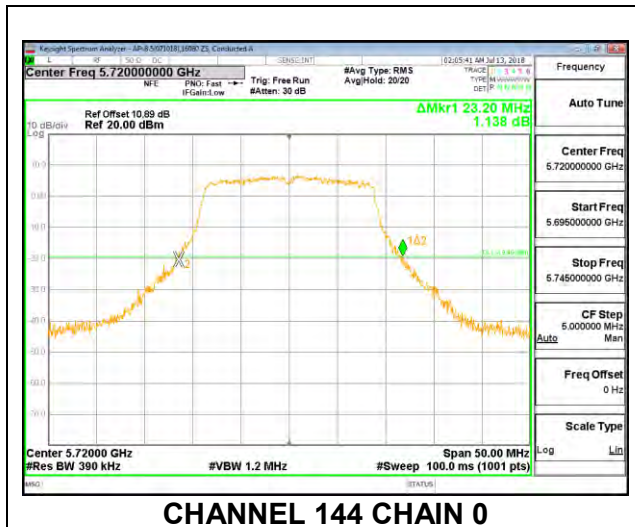

**8.2.11. 802.11n HT40 MODE IN THE 5.6 GHz BAND**

**2TX Antenna 1 + Antenna 2 CDD MODE**

Channel	Frequency (MHz)	26 dB Bandwidth Chain 0 (MHz)	26 dB Bandwidth Chain 1 (MHz)
Low	5510	41.60	<b>41.20</b>
Mid	5550	41.60	41.10
High	5670	<b>41.70</b>	41.20
142	5710	41.60	41.20

**LOW CHANNEL**

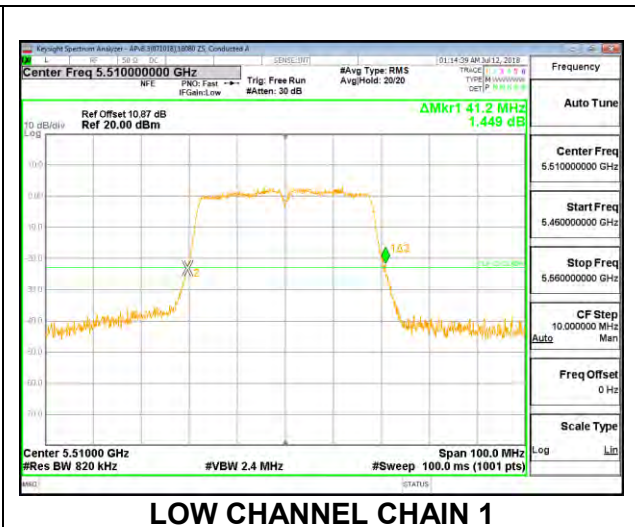
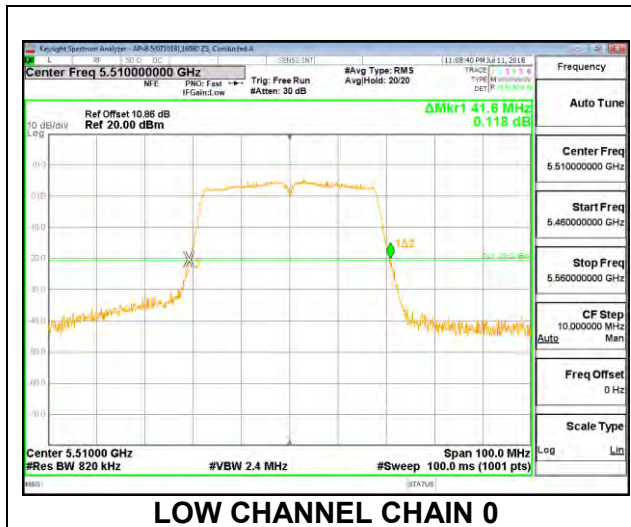

**MID CHANNEL**

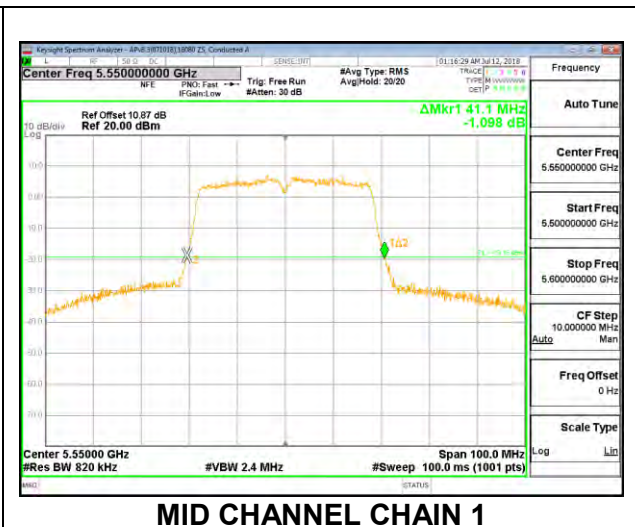
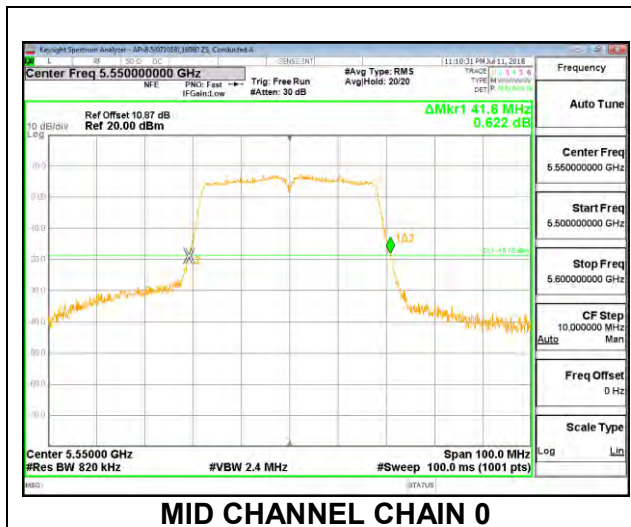

**HIGH CHANNEL**

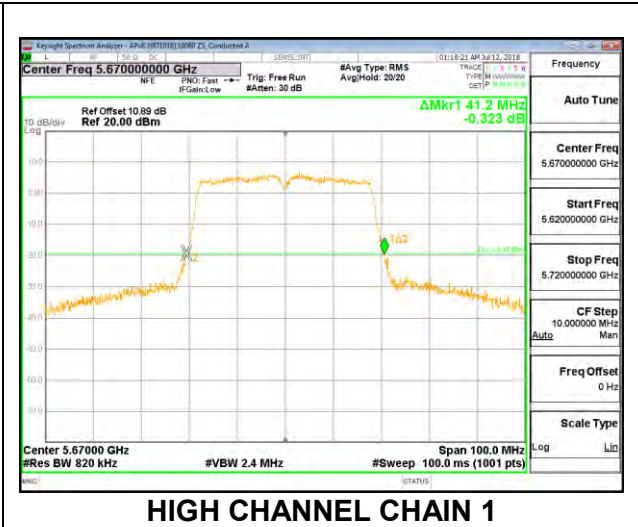
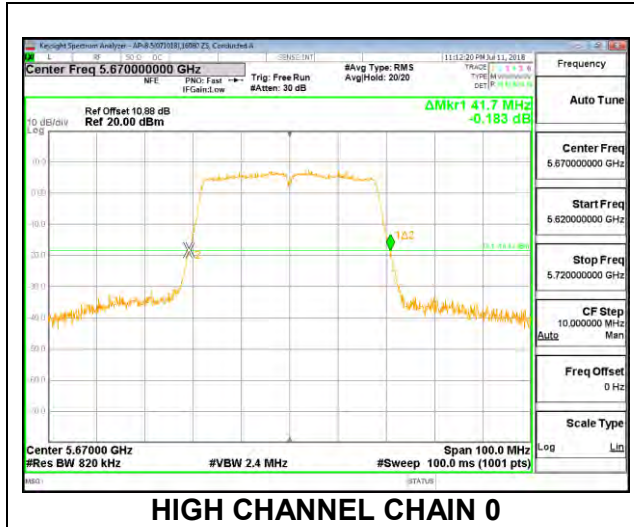

**CHANNEL 142**

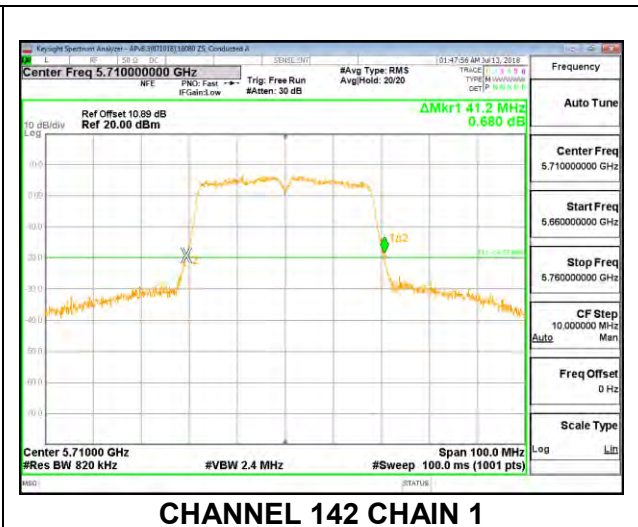
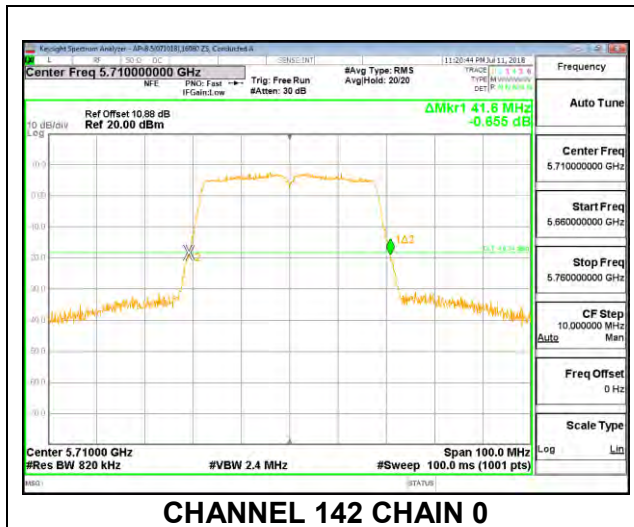

**8.2.12. 802.11ac VHT80 MODE IN THE 5.6 GHz BAND**

**2TX Antenna 1 + Antenna 2 CDD MODE**

Channel	Frequency (MHz)	26 dB Bandwidth Chain 0 (MHz)	26 dB Bandwidth Chain 1 (MHz)
Low	5530	83.60	83.20
High	5610	83.80	<b>87.00</b>
138	5690	<b>84.40</b>	84.60

**LOW CHANNEL**

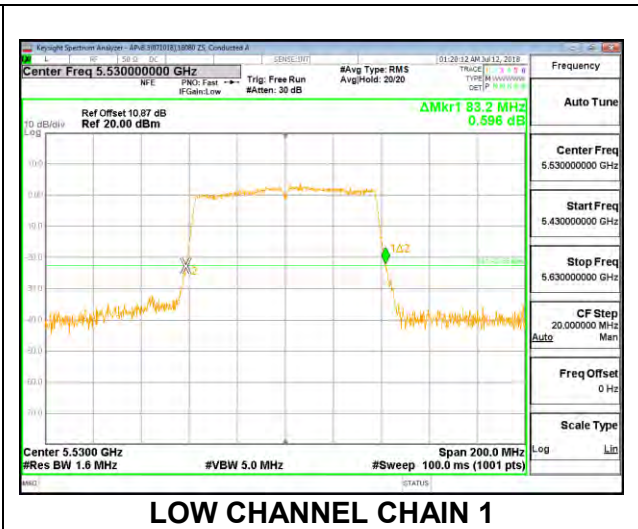
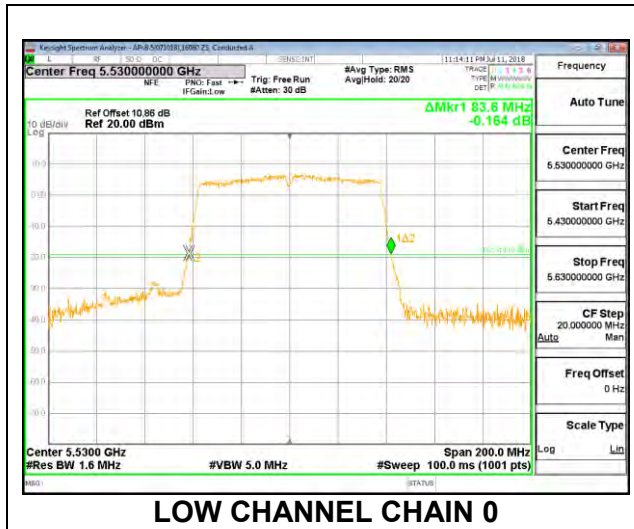

**HIGH CHANNEL**

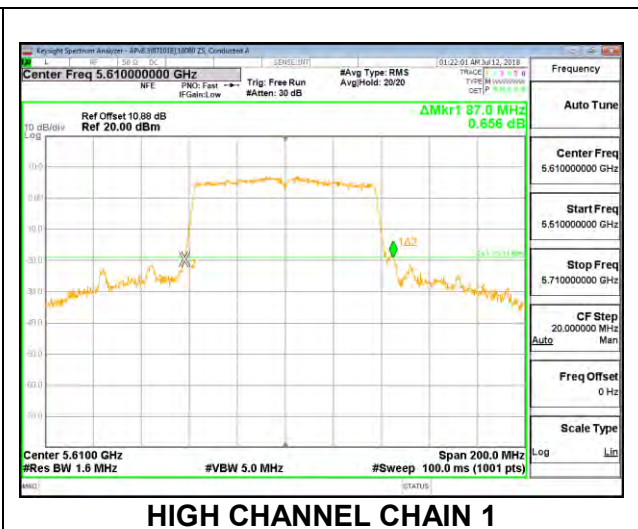
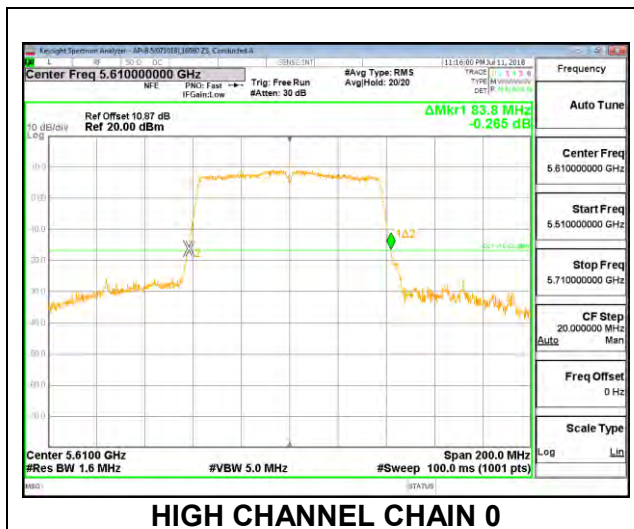



**CHANNEL 138**

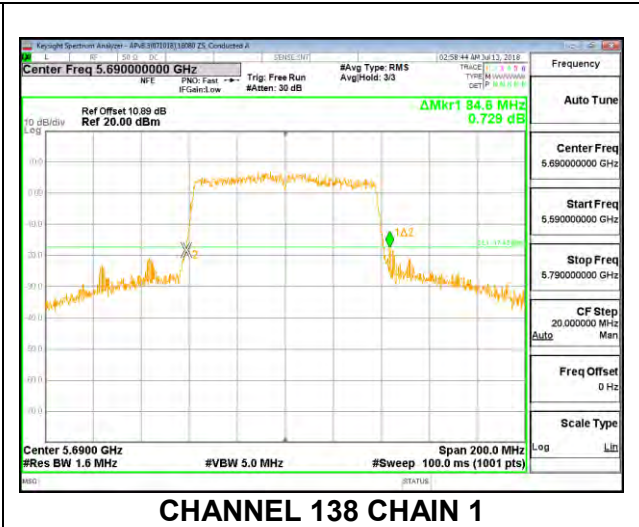
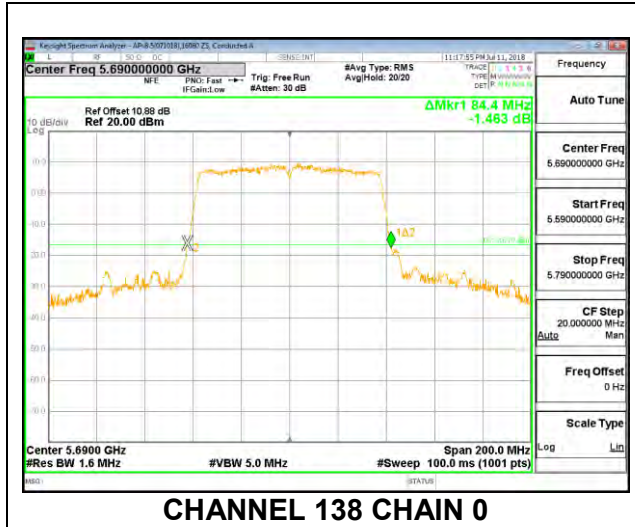

**8.2.13. 802.11a MODE IN THE 5.8 GHz BAND**

**2TX Antenna 1 + Antenna 2 CDD MODE**

Channel	Frequency (MHz)	26 dB Bandwidth Chain 0 (MHz)	26 dB Bandwidth Chain 1 (MHz)
Low	5745	21.45	21.50
Mid	5785	21.85	23.75
High	5825	21.85	21.30

**LOW CHANNEL**

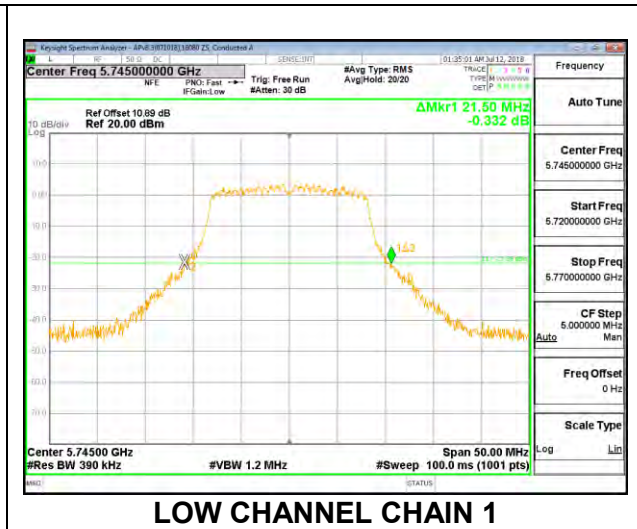
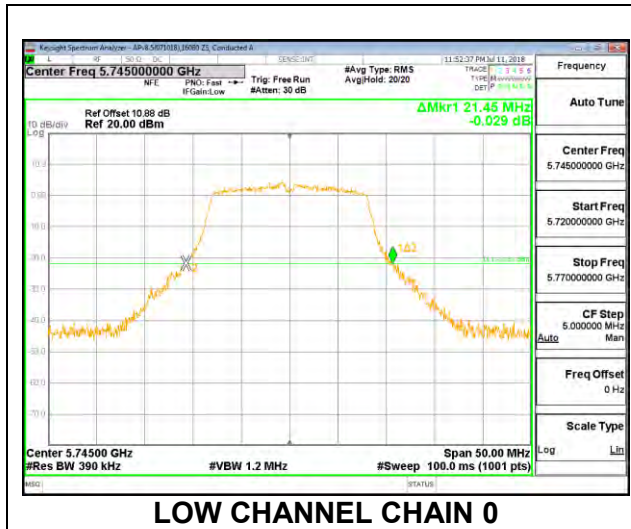

**MID CHANNEL**

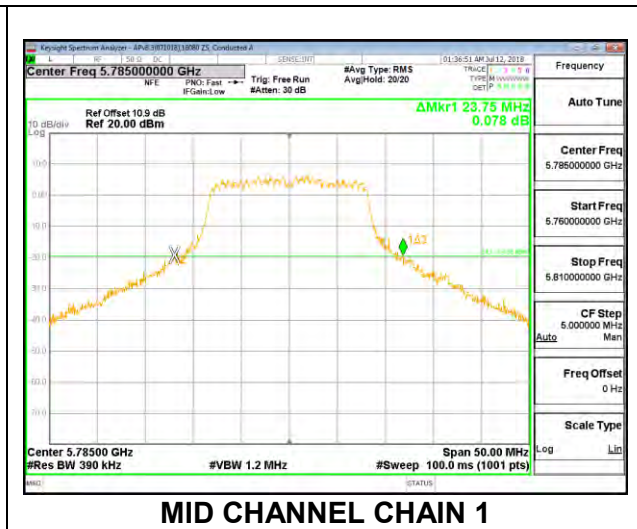
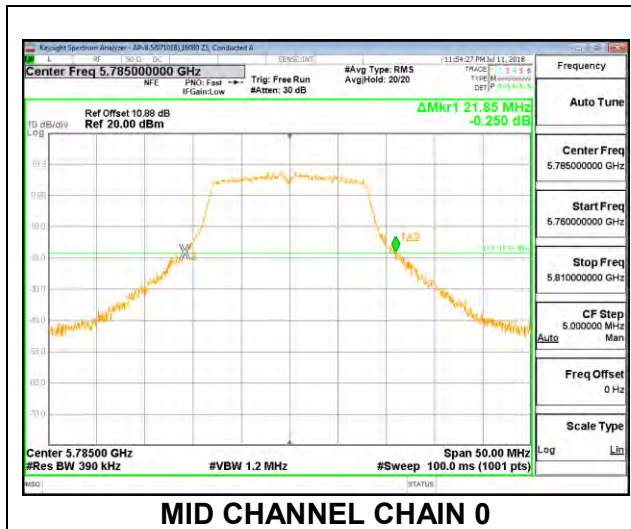

### HIGH CHANNEL

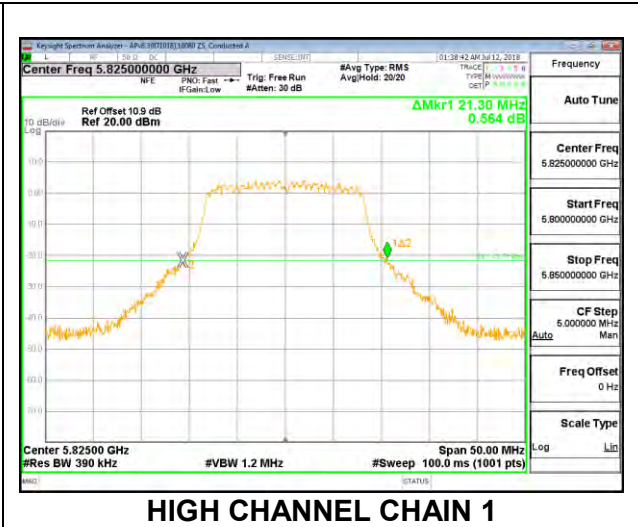
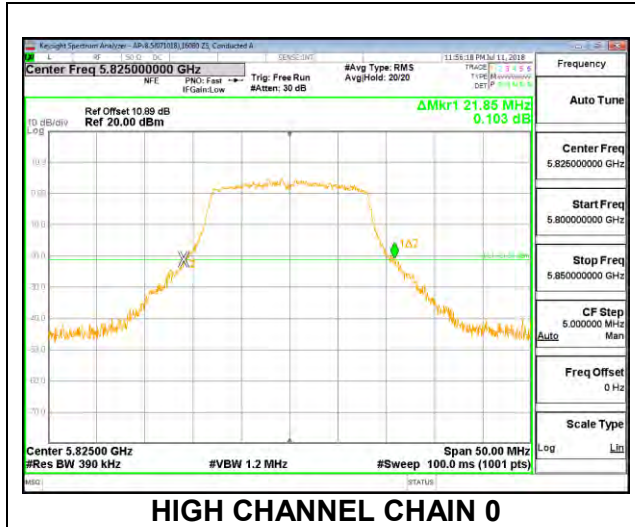

### 8.2.14. 802.11n HT20 MODE IN THE 5.8 GHz BAND

#### 2TX Antenna 1 + Antenna 2 CDD MODE

Channel	Frequency (MHz)	26 dB Bandwidth Chain 0 (MHz)	26 dB Bandwidth Chain 1 (MHz)
Low	5745	22.80	22.30
Mid	5785	23.70	23.90
High	5825	22.55	22.10

#### LOW CHANNEL

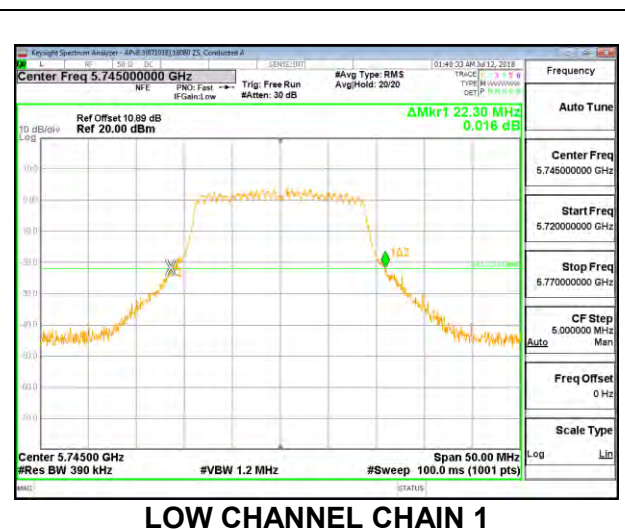
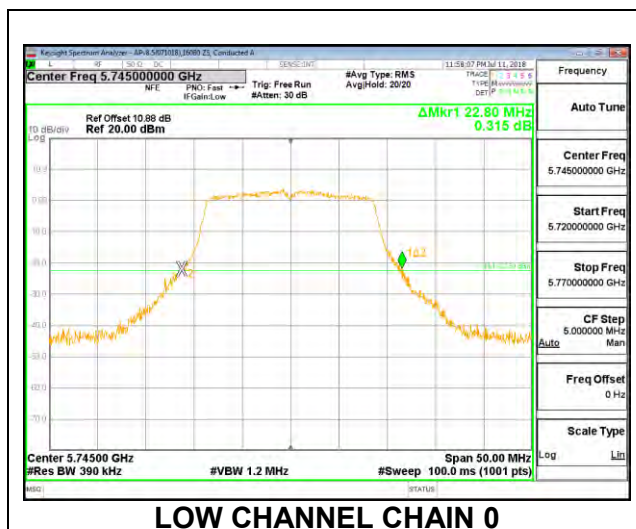

#### MID CHANNEL

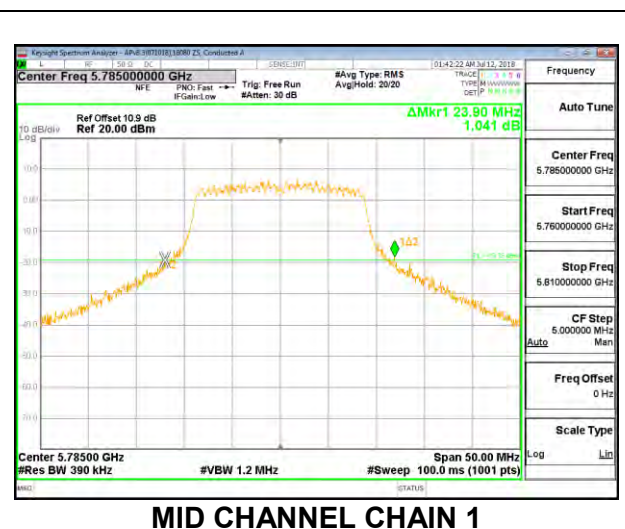
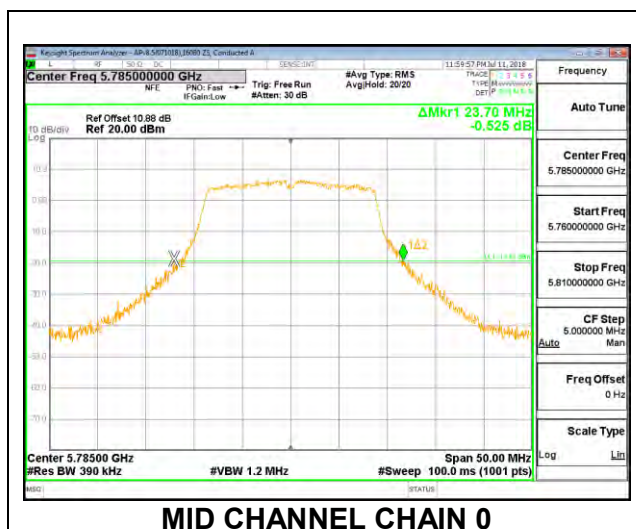

### HIGH CHANNEL

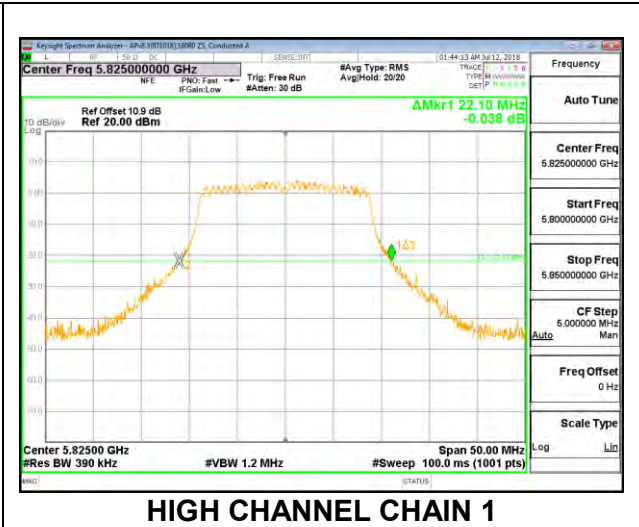
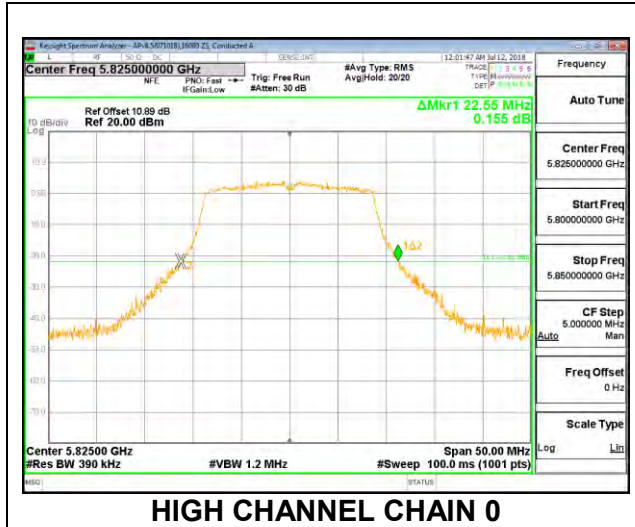

**8.2.15. 802.11n HT40 MODE IN THE 5.8 GHz BAND**

**2TX Antenna 1 + Antenna 2 CDD MODE**

Channel	Frequency (MHz)	26 dB Bandwidth Chain 0 (MHz)	26 dB Bandwidth Chain 1 (MHz)
Low	5755	41.50	41.30
High	5795	41.70	42.50

**LOW CHANNEL**

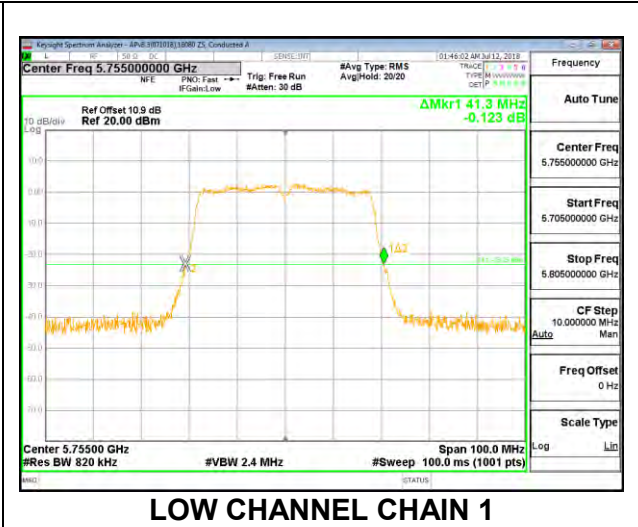
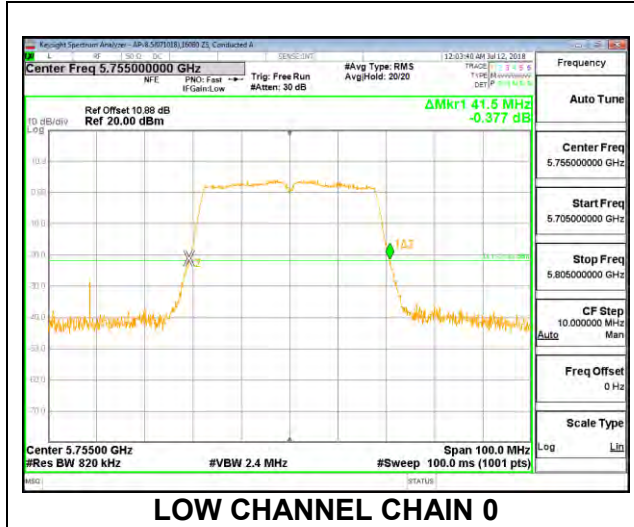

**HIGH CHANNEL**

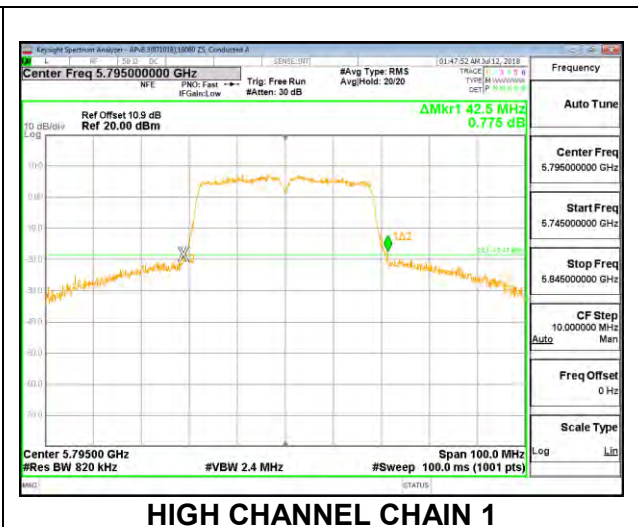
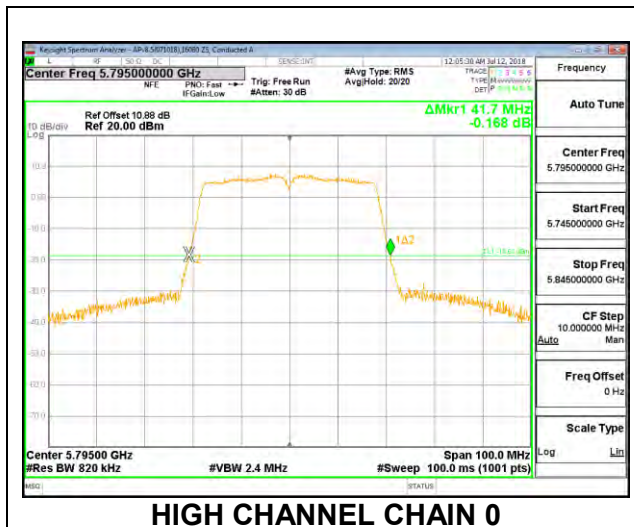

**8.2.16. 802.11ac VHT80 MODE IN THE 5.8 GHz BAND**

**2TX Antenna 1 + Antenna 2 CDD MODE**

Channel	Frequency (MHz)	26 dB Bandwidth Chain 0 (MHz)	26 dB Bandwidth Chain 1 (MHz)
Mid	5775	84.00	83.80

**MID CHANNEL**

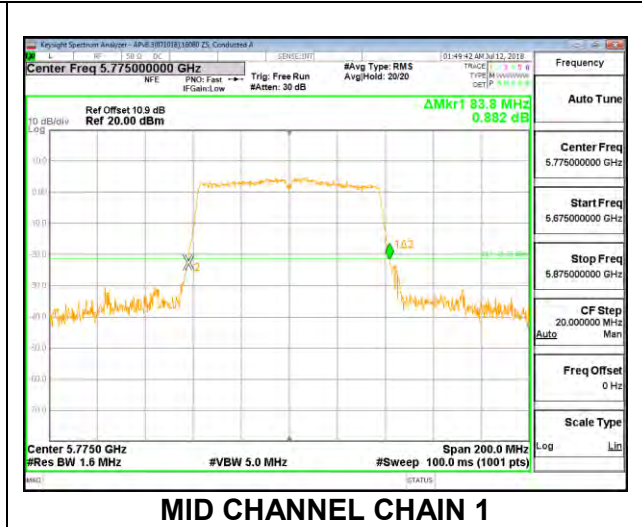
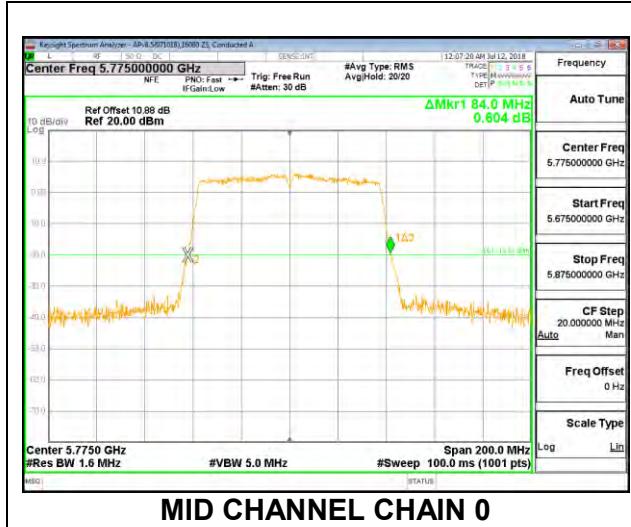

---

### **8.3. 99% BANDWIDTH**

#### **LIMITS**

None; for reporting purposes only.

#### **RESULTS**



### 8.3.1. 802.11a MODE IN THE 5.2 GHz BAND

#### 2TX Antenna 1 + Antenna 2 CDD MODE

Channel	Frequency (MHz)	99% Bandwidth Chain 0 (MHz)	99% Bandwidth Chain 1 (MHz)
Low	5180	16.567	<b>16.584</b>
Mid	5200	<b>16.587</b>	16.562
High	5240	16.517	16.579

#### LOW CHANNEL

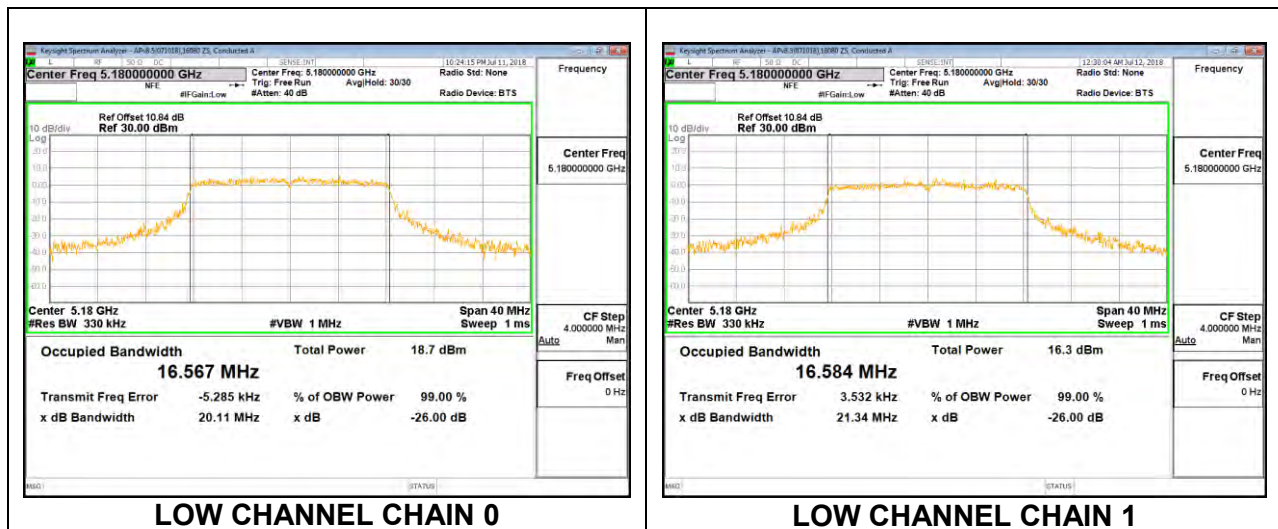

#### MID CHANNEL

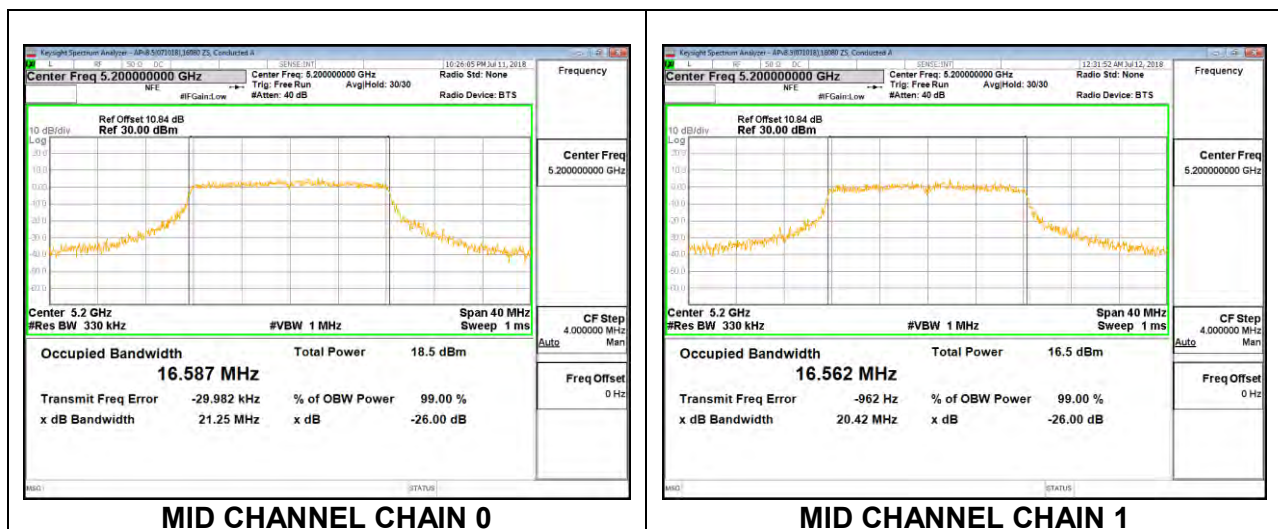

**HIGH CHANNEL**

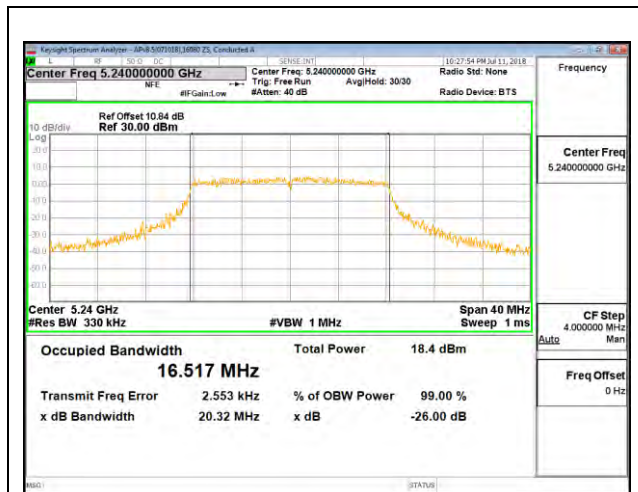

**HIGH CHANNEL CHAIN 0**

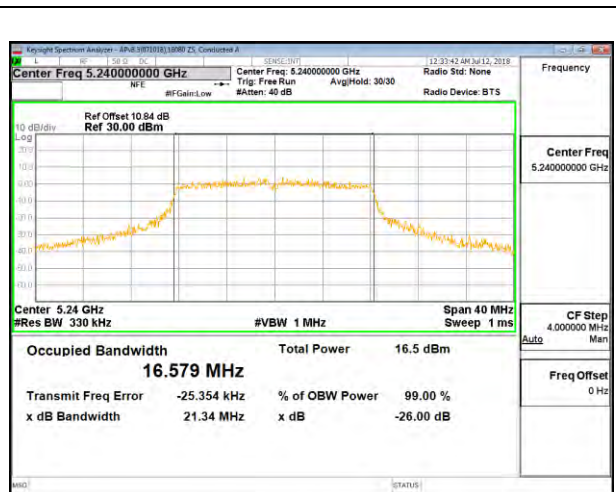

**HIGH CHANNEL CHAIN 1**

### 8.3.2. 802.11n HT20 MODE IN THE 5.2 GHz BAND

#### 2TX Antenna 1 + Antenna 2 CDD MODE

Channel	Frequency (MHz)	99% Bandwidth Chain 0 (MHz)	99% Bandwidth Chain 1 (MHz)
Low	5180	17.786	<b>17.777</b>
Mid	5200	17.784	17.732
High	5240	<b>17.820</b>	17.732

#### LOW CHANNEL

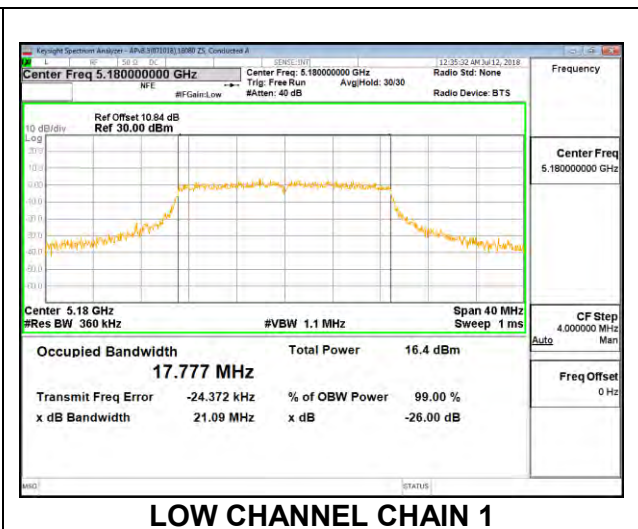
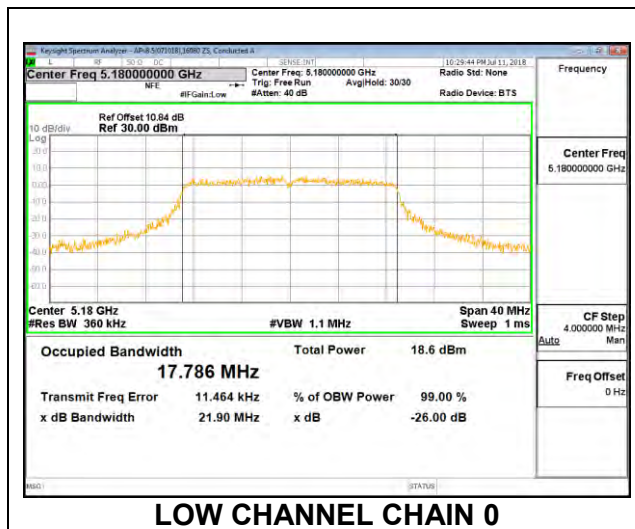

#### MID CHANNEL

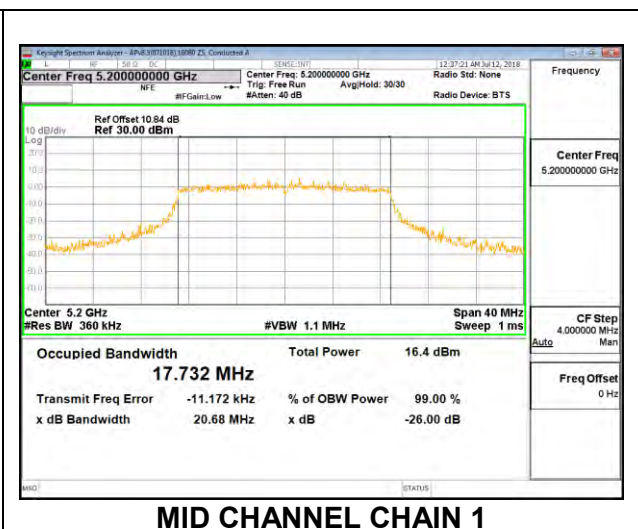
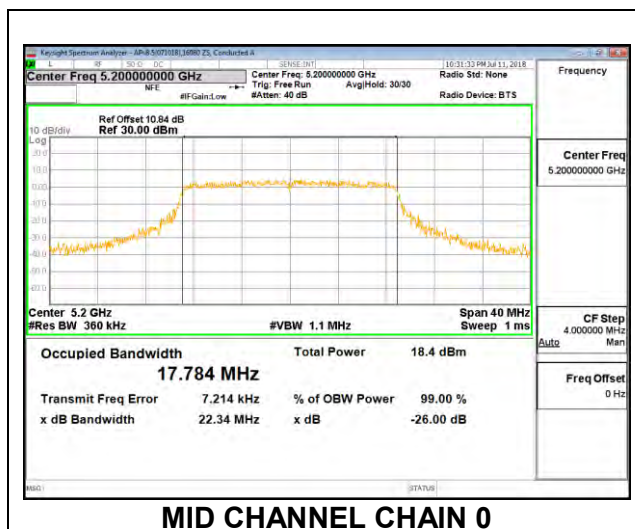

**HIGH CHANNEL**

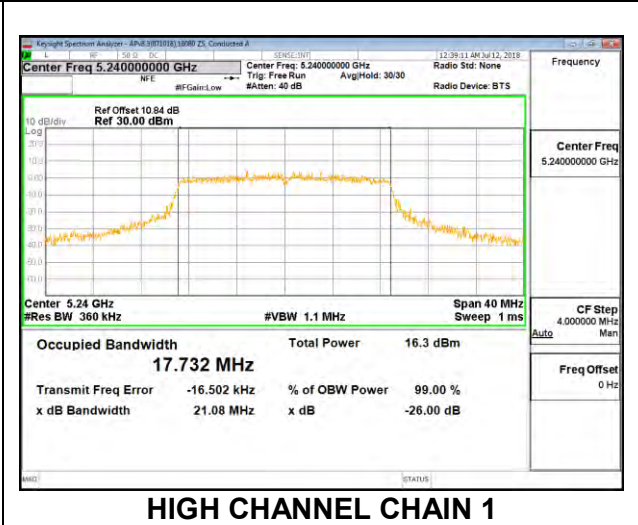
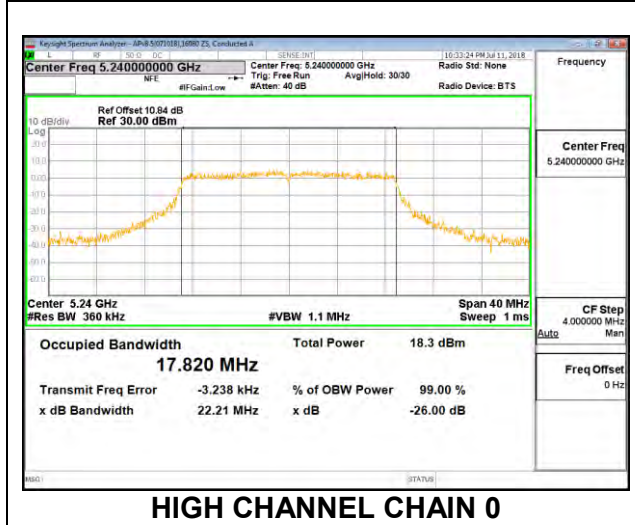

### 8.3.3. 802.11n HT40 MODE IN THE 5.2 GHz BAND

#### 2TX Antenna 1 + Antenna 2 CDD MODE

Channel	Frequency (MHz)	99% Bandwidth Chain 0 (MHz)	99% Bandwidth Chain 1 (MHz)
Low	5190	36.292	36.322
High	5230	36.311	36.400

#### LOW CHANNEL

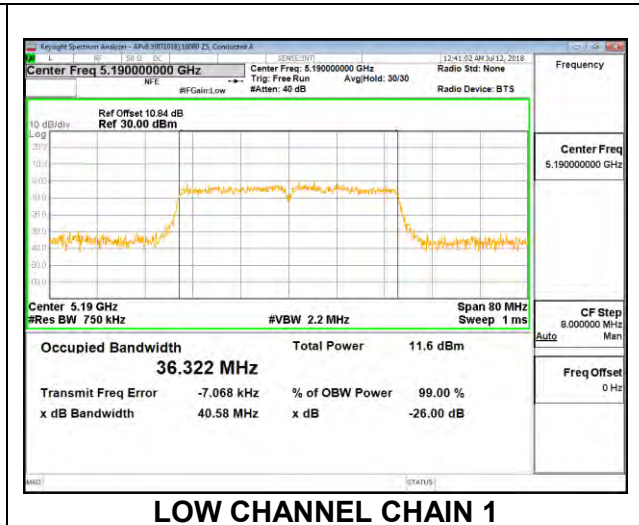
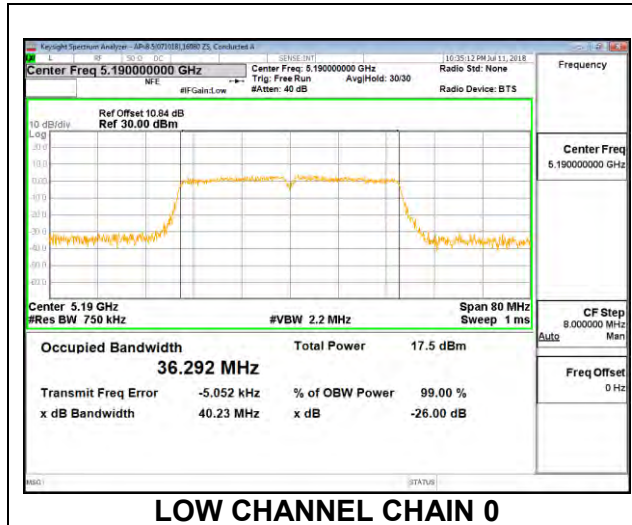

#### HIGH CHANNEL

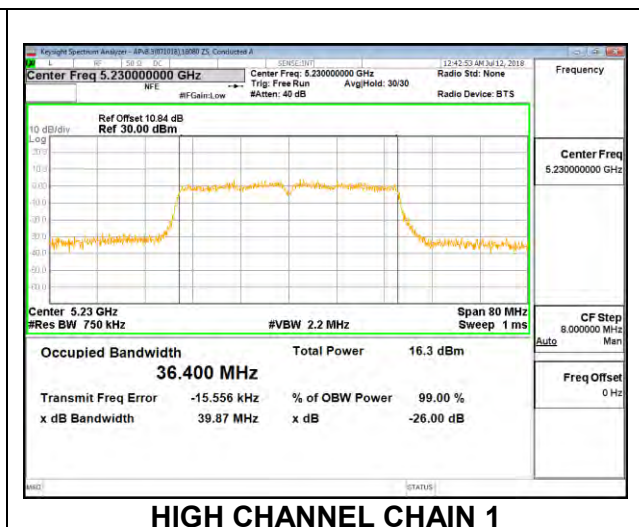
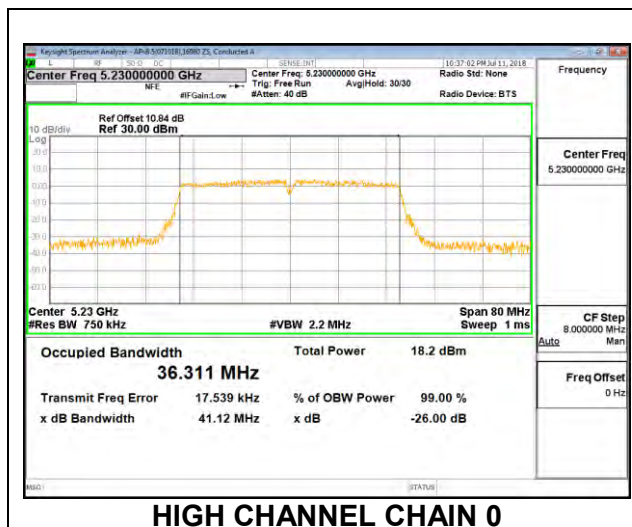

**8.3.4. 802.11ac VHT80 MODE IN THE 5.2 GHz BAND**

**2TX Antenna 1 + Antenna 2 CDD MODE**

Channel	Frequency (MHz)	99% Bandwidth Chain 0 (MHz)	99% Bandwidth Chain 1 (MHz)
Mid	5210	76.167	76.255

**MID CHANNEL**

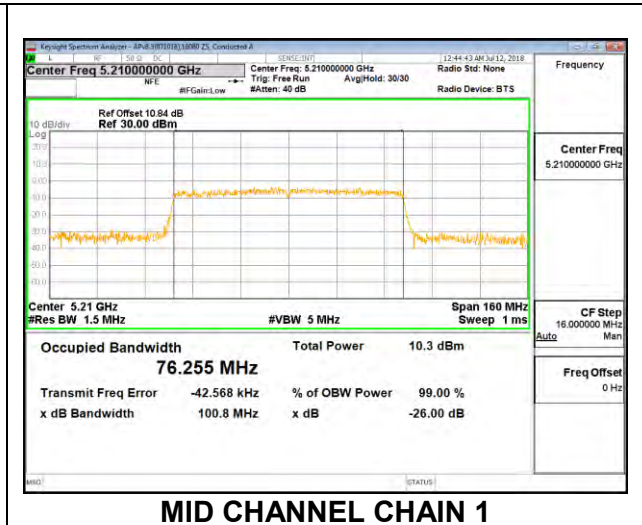
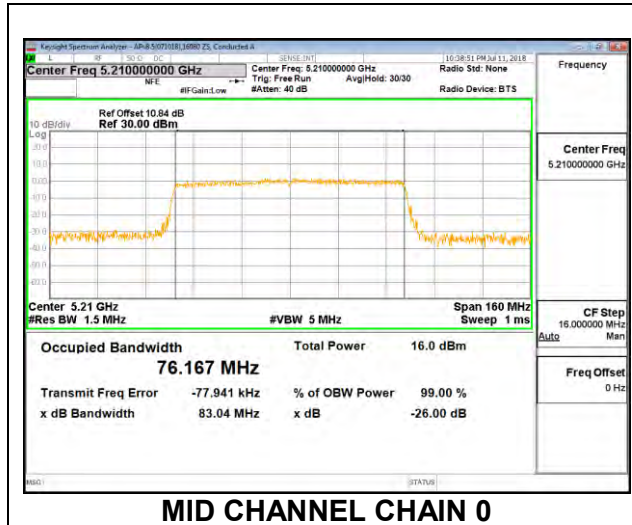

### 8.3.5. 802.11a MODE IN THE 5.3 GHz BAND

#### 2TX Antenna 1 + Antenna 2 CDD MODE

Channel	Frequency (MHz)	99% Bandwidth Chain 0 (MHz)	99% Bandwidth Chain 1 (MHz)
Low	5260	<b>16.565</b>	16.571
Mid	5300	16.517	16.563
High	5320	16.529	<b>16.591</b>

#### LOW CHANNEL

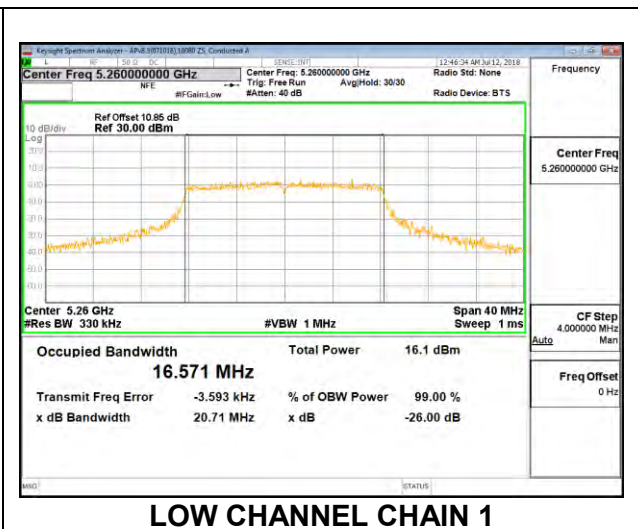
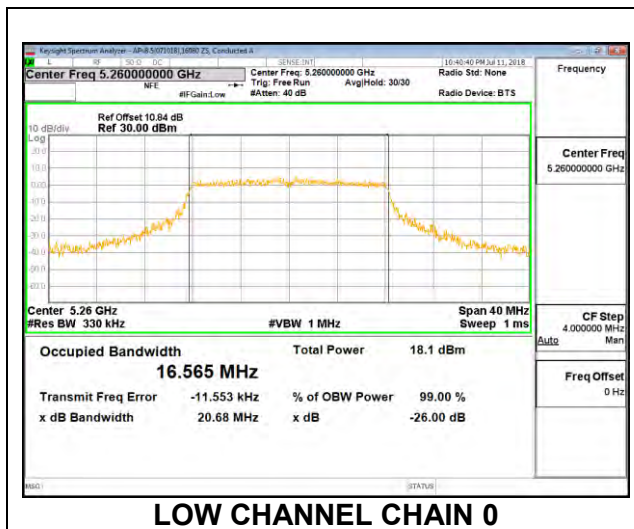

#### MID CHANNEL

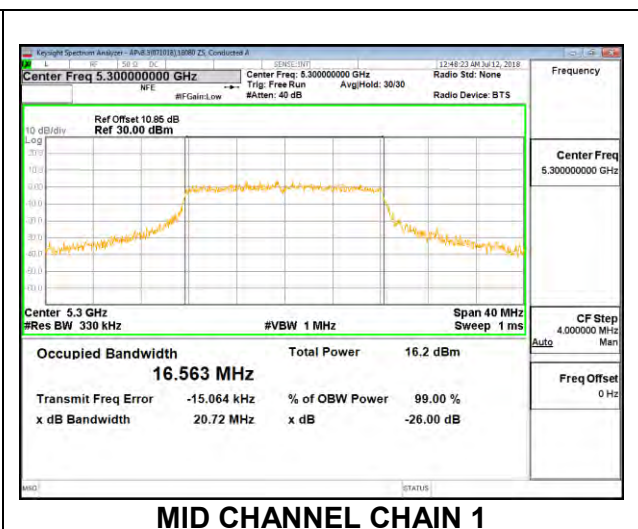
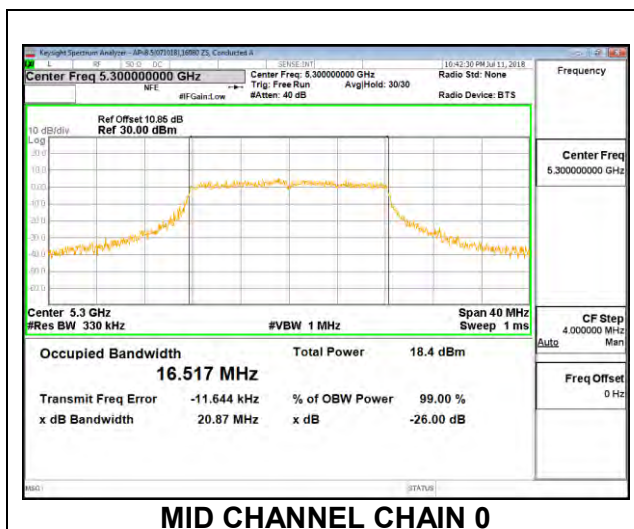

**HIGH CHANNEL**

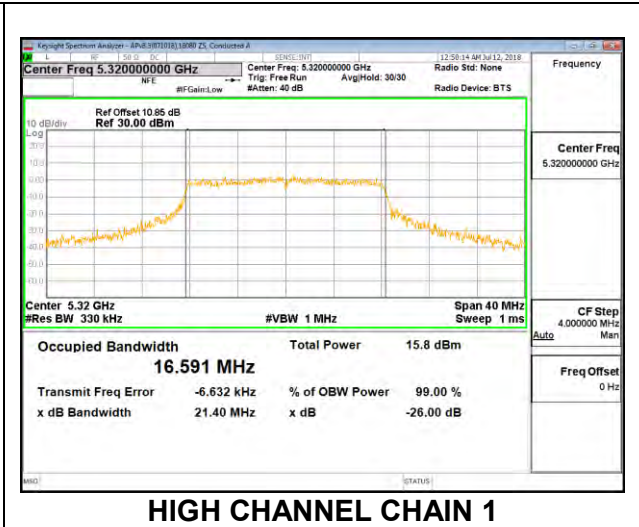
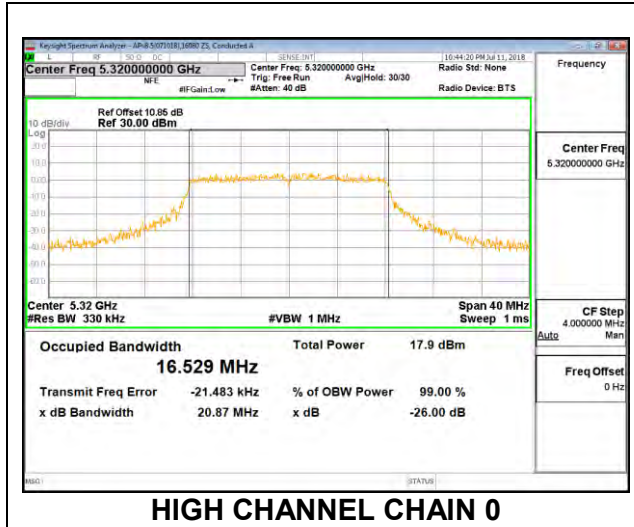



### 8.3.6. 802.11n HT20 MODE IN THE 5.3 GHz BAND

#### 2TX Antenna 1 + Antenna 2 CDD MODE

Channel	Frequency (MHz)	99% Bandwidth Chain 0 (MHz)	99% Bandwidth Chain 1 (MHz)
Low	5260	17.765	17.817
Mid	5300	17.785	<b>17.850</b>
High	5320	<b>17.802</b>	17.773

#### LOW CHANNEL

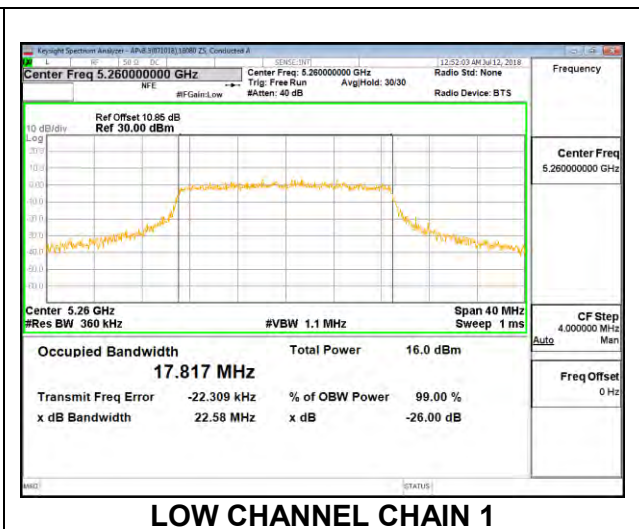
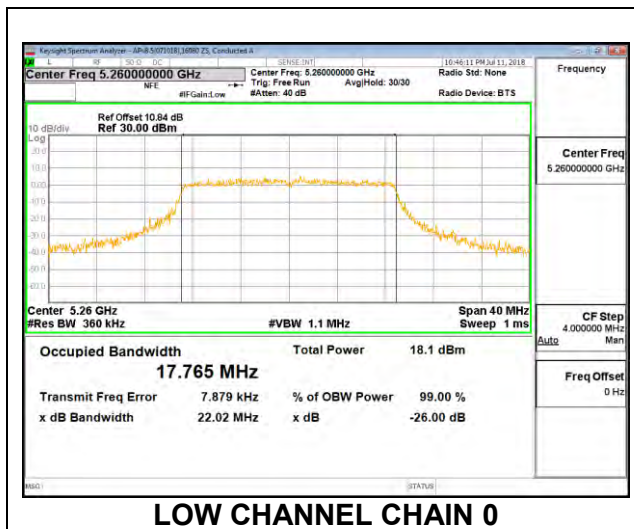

#### MID CHANNEL

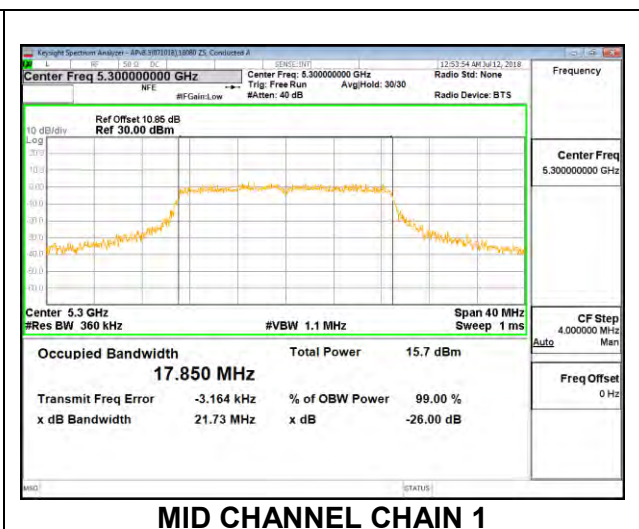
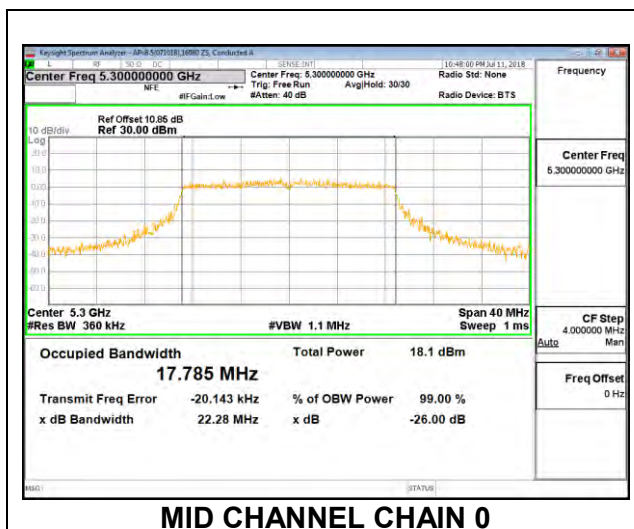

**HIGH CHANNEL**

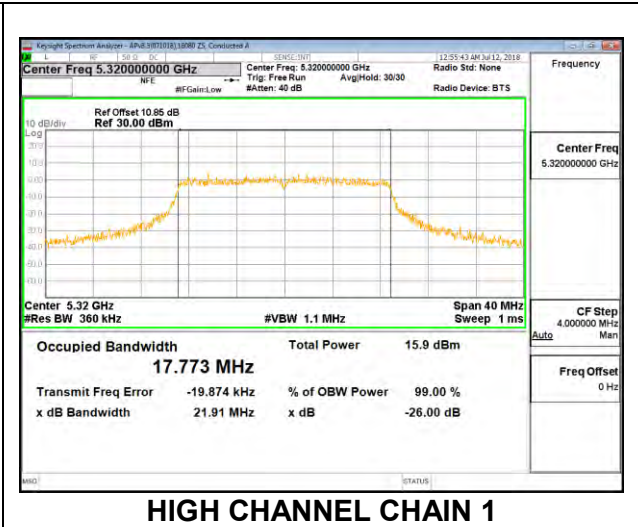
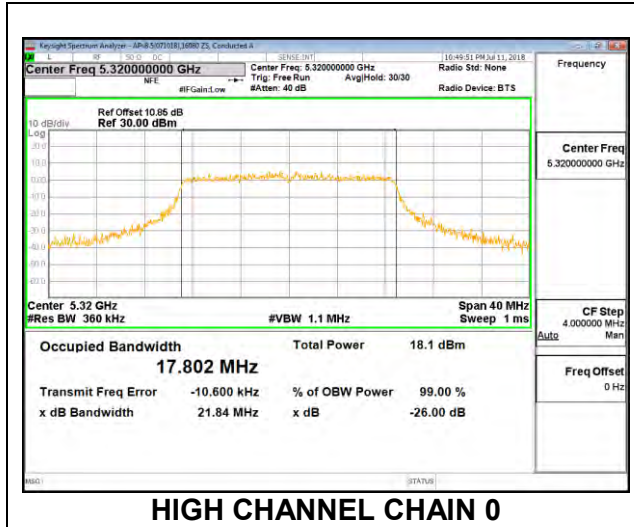

### 8.3.7. 802.11n HT40 MODE IN THE 5.3 GHz BAND

#### 2TX Antenna 1 + Antenna 2 CDD MODE

Channel	Frequency (MHz)	99% Bandwidth Chain 0 (MHz)	99% Bandwidth Chain 1 (MHz)
Low	5270	36.306	<b>36.361</b>
High	5310	<b>36.361</b>	36.263

#### LOW CHANNEL

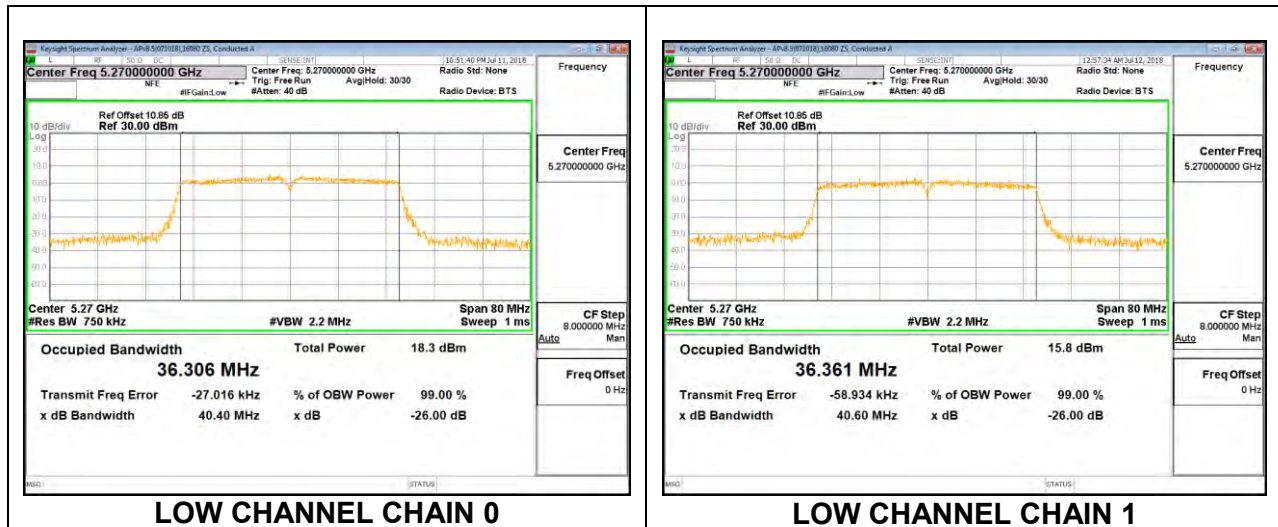

#### HIGH CHANNEL

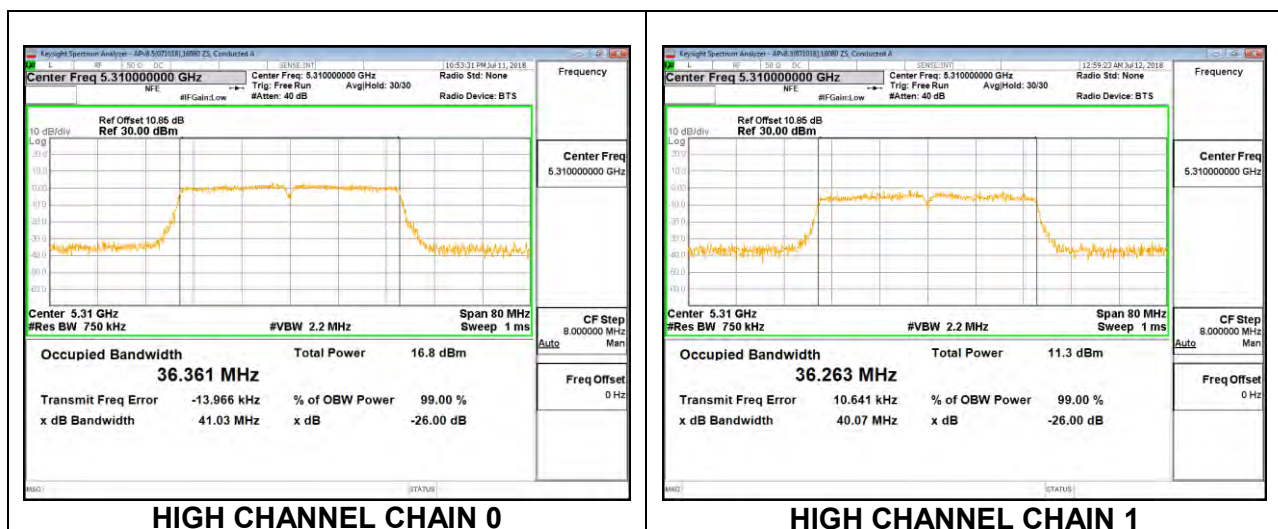

**8.3.8. 802.11ac VHT80 MODE IN THE 5.3 GHz BAND**

**2TX Antenna 1 + Antenna 2 CDD MODE**

Channel	Frequency (MHz)	99% Bandwidth Chain 0 (MHz)	99% Bandwidth Chain 1 (MHz)
Mid	5290	76.162	76.247

**MID CHANNEL**

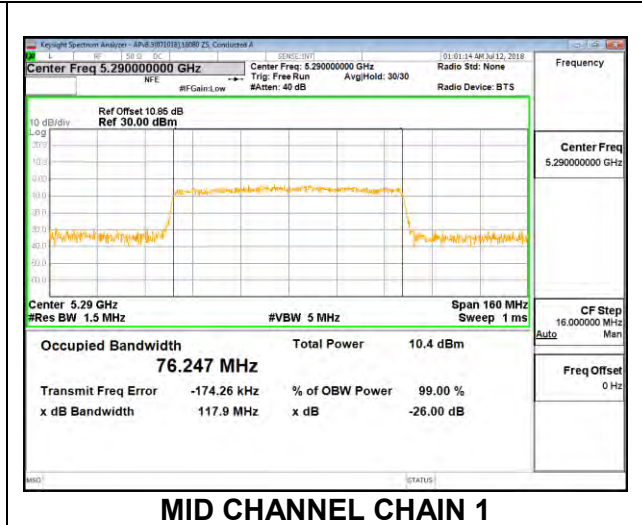
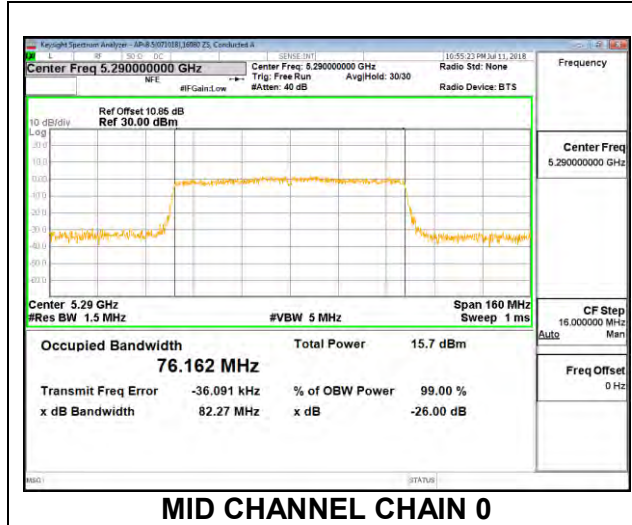

### 8.3.9. 802.11a MODE IN THE 5.6 GHz BAND

#### 2TX Antenna 1 + Antenna 2 CDD MODE

Channel	Frequency (MHz)	99% Bandwidth Chain 0 (MHz)	99% Bandwidth Chain 1 (MHz)
Low	5500	16.552	<b>16.624</b>
Mid	5580	16.509	16.571
High	5700	16.537	16.619
144	5720	<b>16.660</b>	16.586

#### LOW CHANNEL

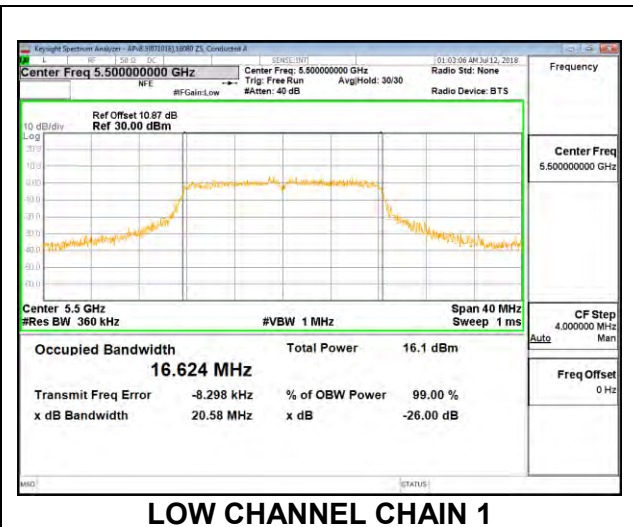
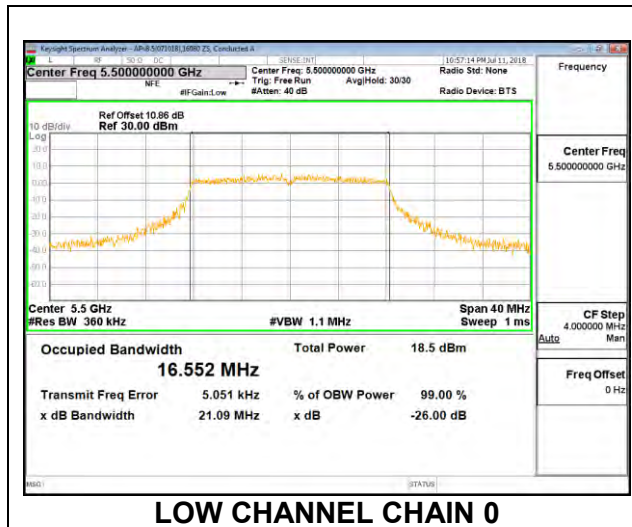

#### MID CHANNEL

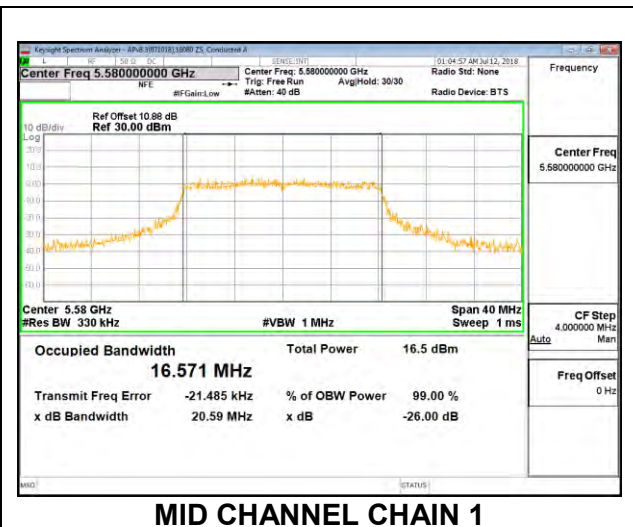
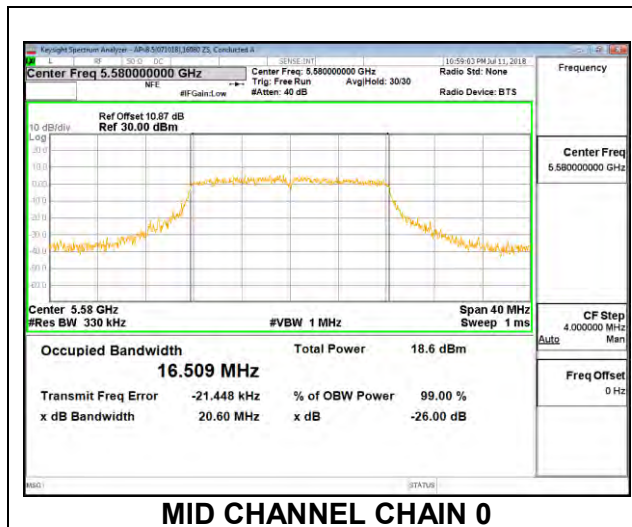

### HIGH CHANNEL

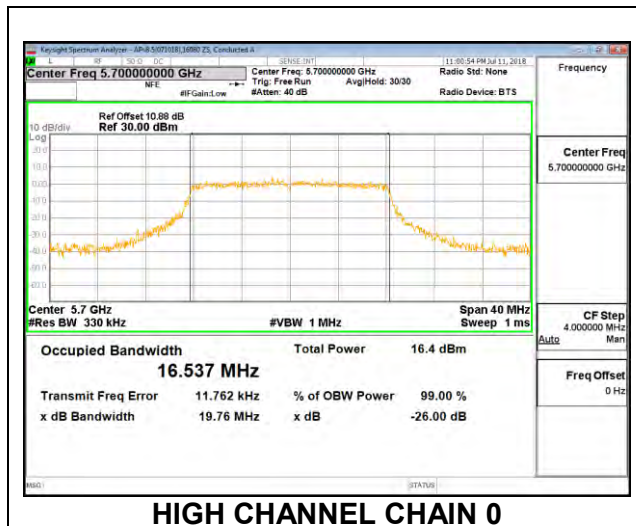

**HIGH CHANNEL CHAIN 0**

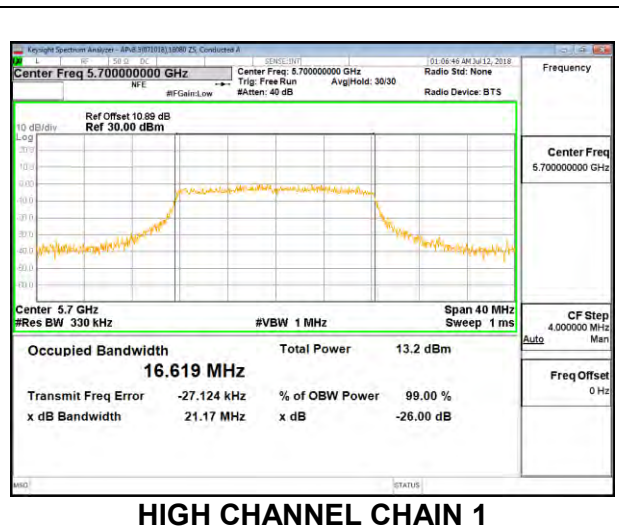

**HIGH CHANNEL CHAIN 1**

### CHANNEL 144

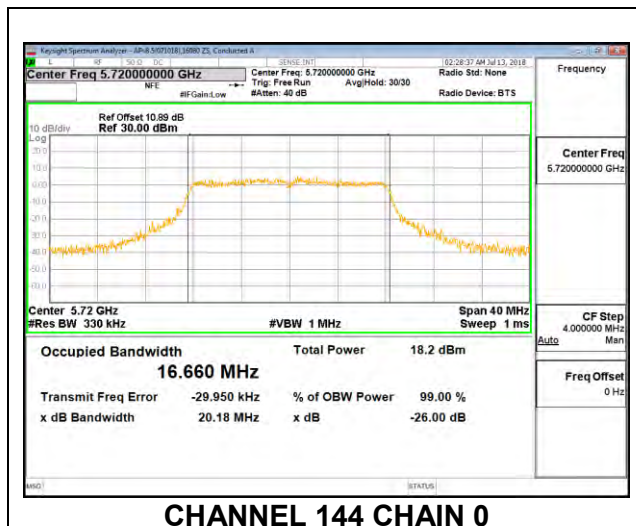

**CHANNEL 144 CHAIN 0**

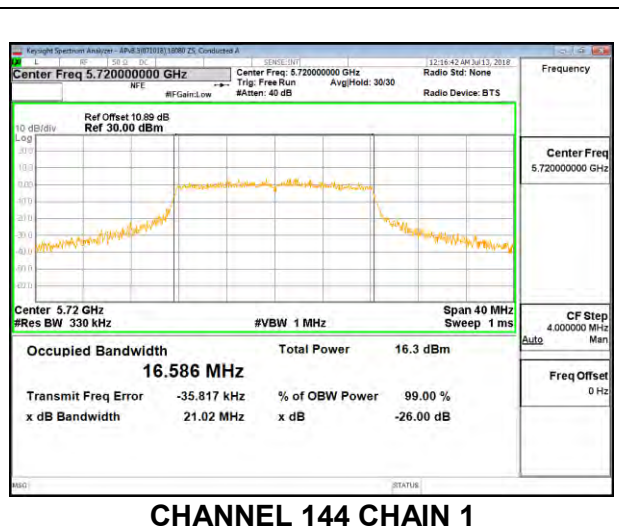

**CHANNEL 144 CHAIN 1**

### 8.3.10. 802.11n HT20 MODE IN THE 5.6 GHz BAND

#### 2TX Antenna 1 + Antenna 2 CDD MODE

Channel	Frequency (MHz)	99% Bandwidth Chain 0 (MHz)	99% Bandwidth Chain 1 (MHz)
Low	5500	<b>17.797</b>	17.786
Mid	5580	17.767	17.792
High	5700	17.763	17.749
144	5720	17.792	<b>17.808</b>

#### LOW CHANNEL

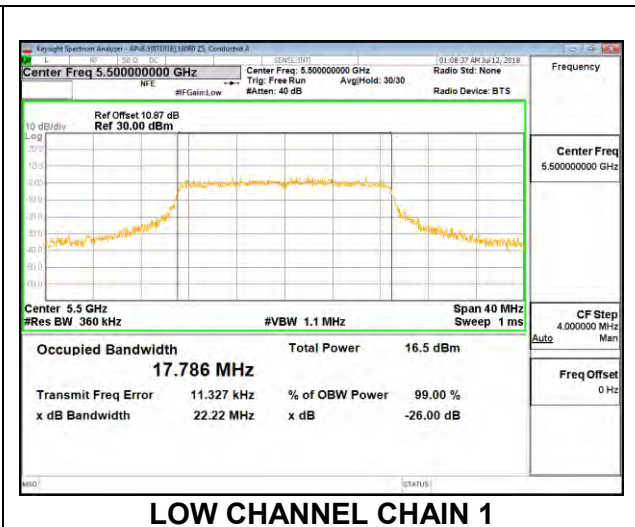
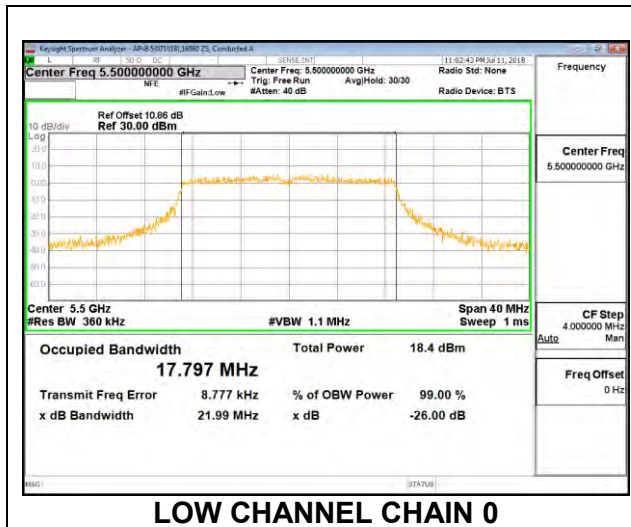

#### MID CHANNEL

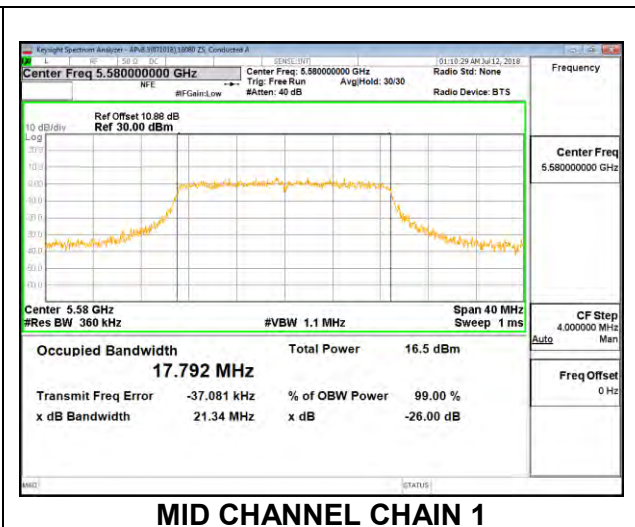
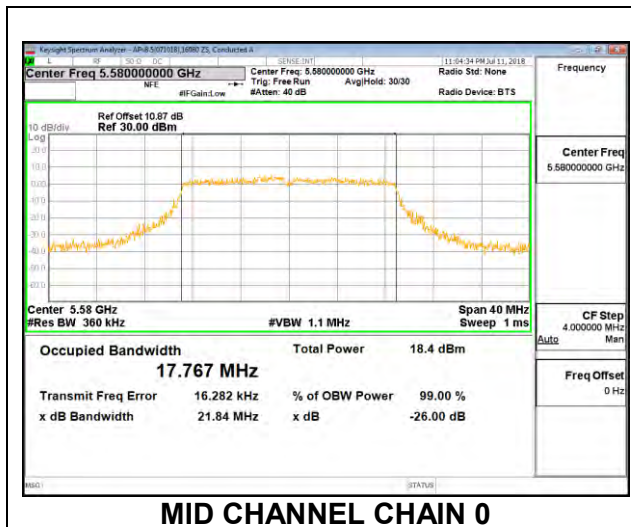

**HIGH CHANNEL**

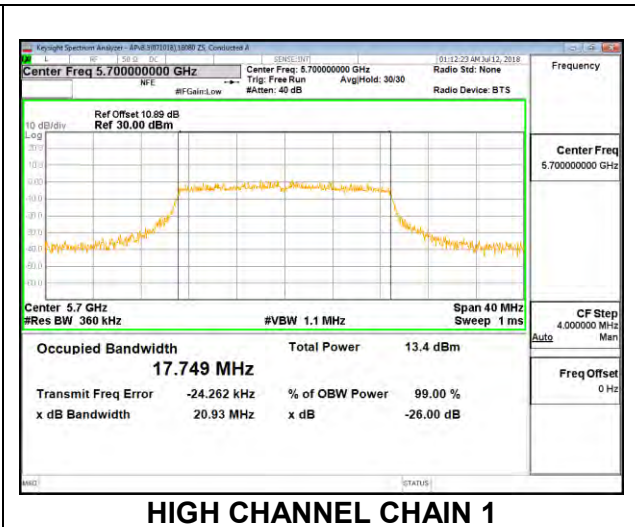
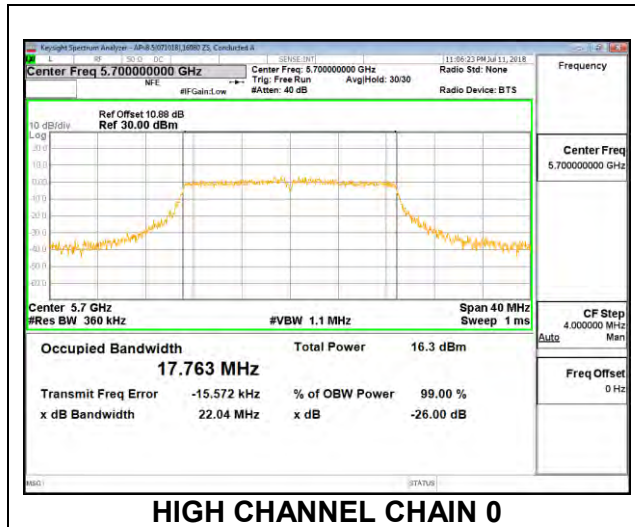

**CHANNEL 144**

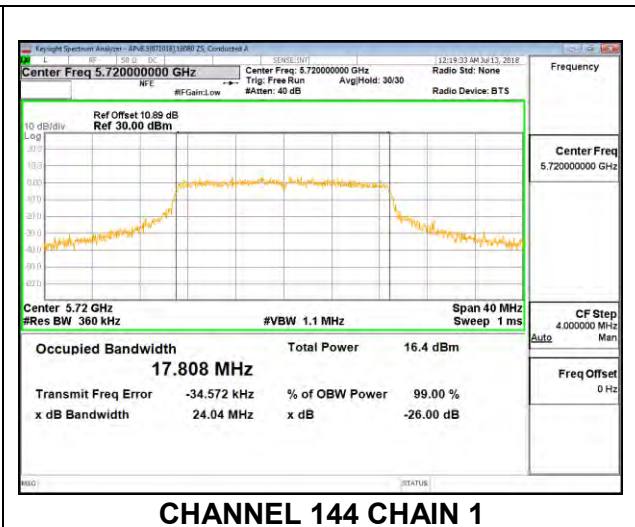
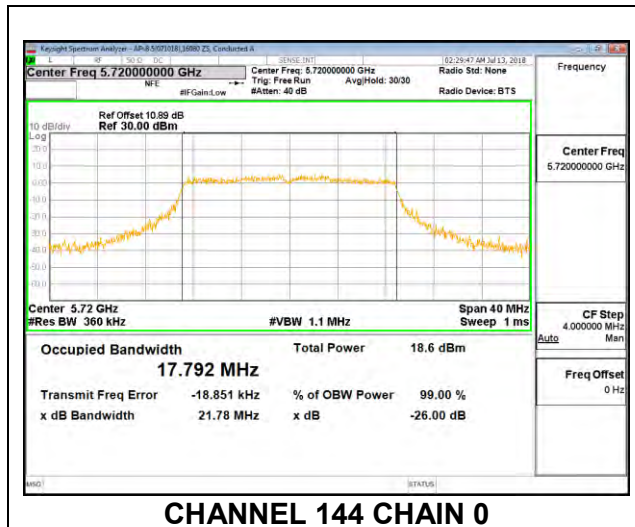



### 8.3.11. 802.11n HT40 MODE IN THE 5.6 GHz BAND

#### 2TX Antenna 1 + Antenna 2 CDD MODE

Channel	Frequency (MHz)	99% Bandwidth Chain 0 (MHz)	99% Bandwidth Chain 1 (MHz)
Low	5510	<b>36.357</b>	36.356
Mid	5550	36.347	36.330
High	5670	36.349	36.352
142	5710	36.296	<b>36.374</b>

#### LOW CHANNEL

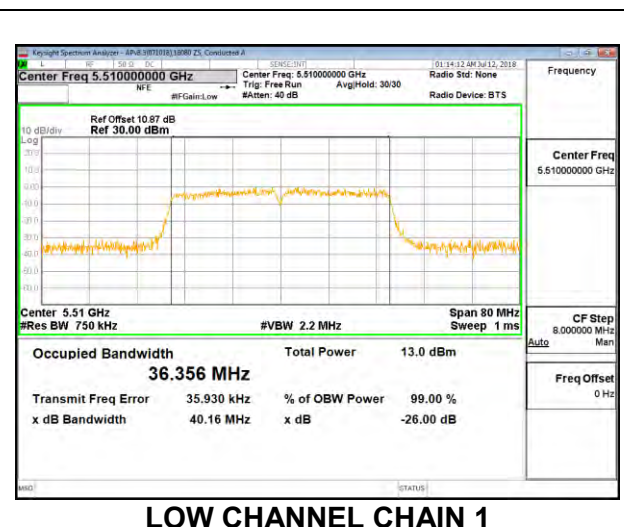
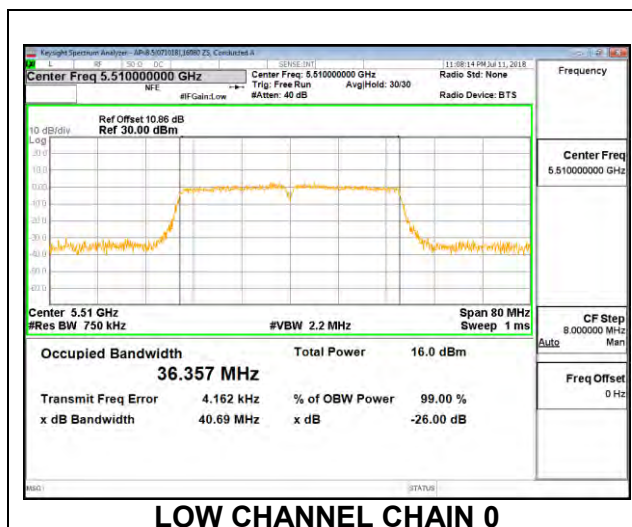

#### MID CHANNEL

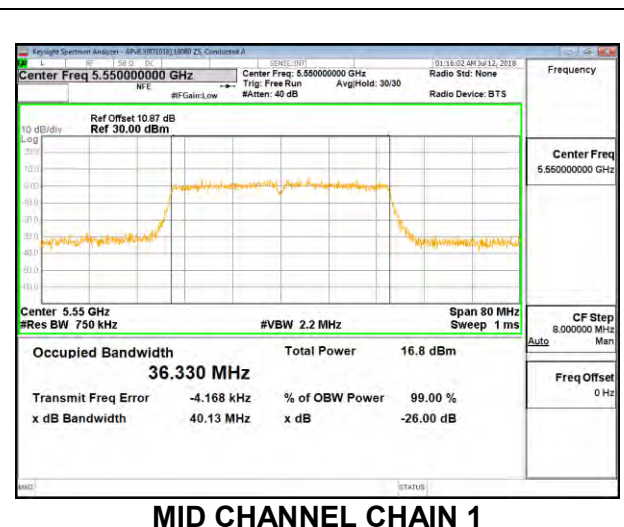
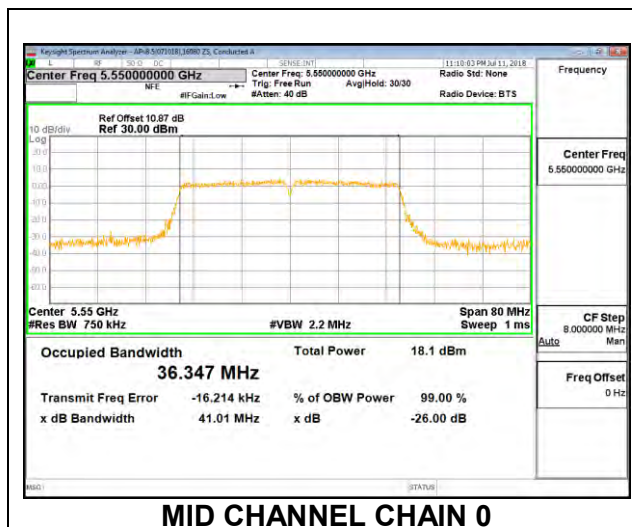

**HIGH CHANNEL**

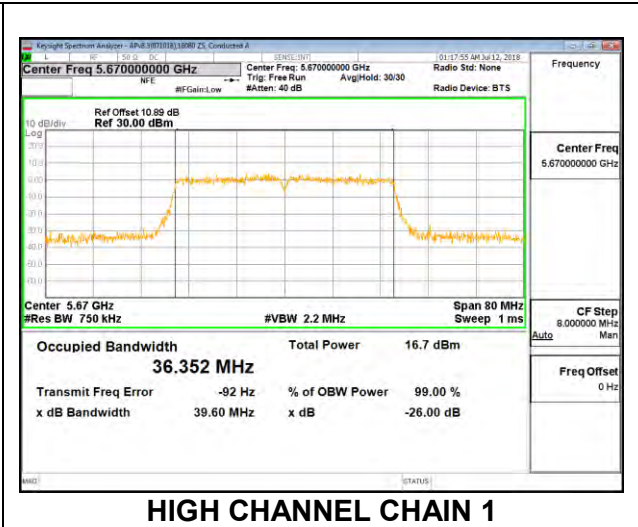
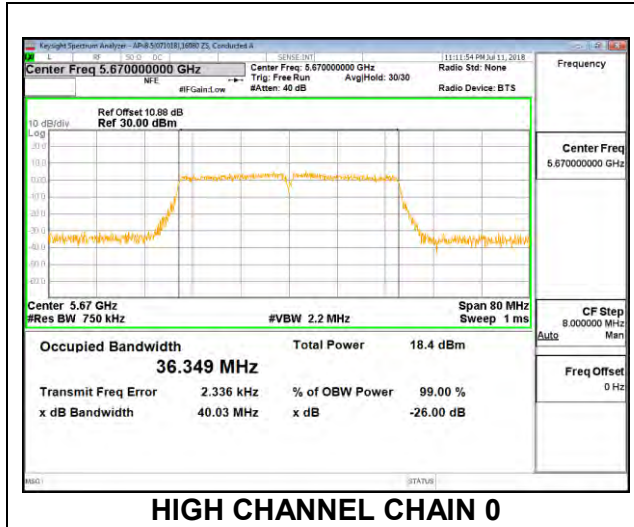

**CHANNEL 142**

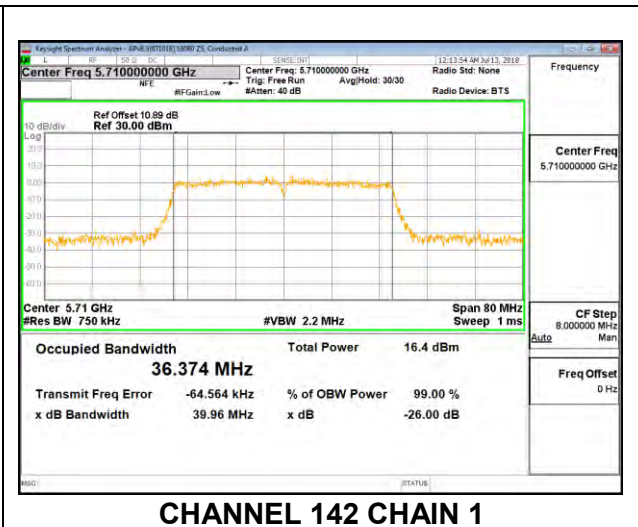
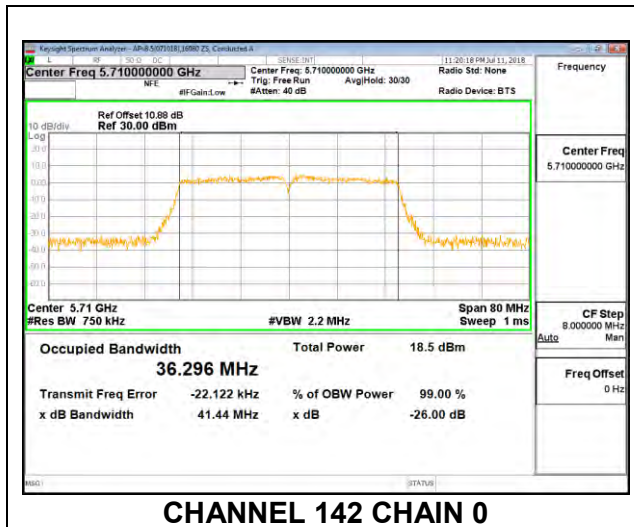

### 8.3.12. 802.11ac VHT80 MODE IN THE 5.6 GHz BAND

#### 2TX Antenna 1 + Antenna 2 CDD MODE

Channel	Frequency (MHz)	99% Bandwidth Chain 0 (MHz)	99% Bandwidth Chain 1 (MHz)
Low	5530	76.049	75.991
High	5610	76.017	75.982
138	5690	<b>76.058</b>	<b>76.073</b>

#### LOW CHANNEL

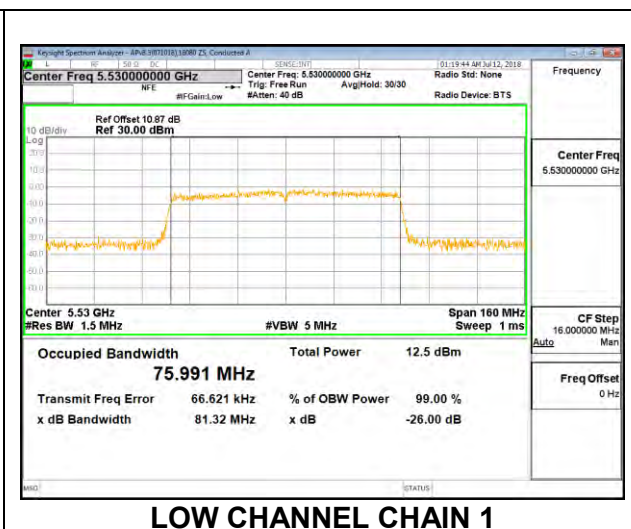
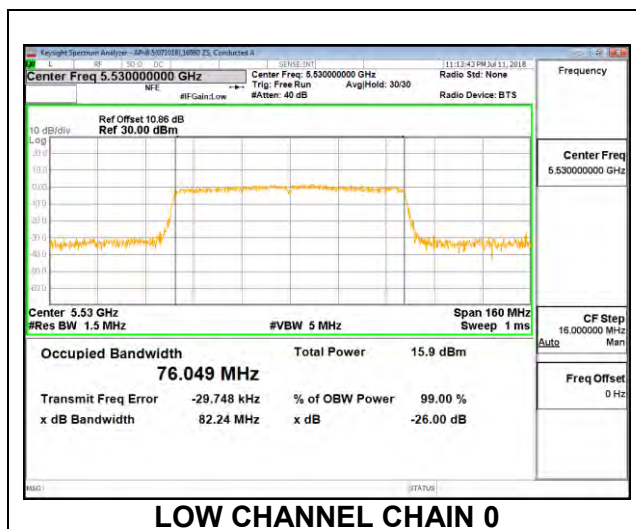

#### HIGH CHANNEL

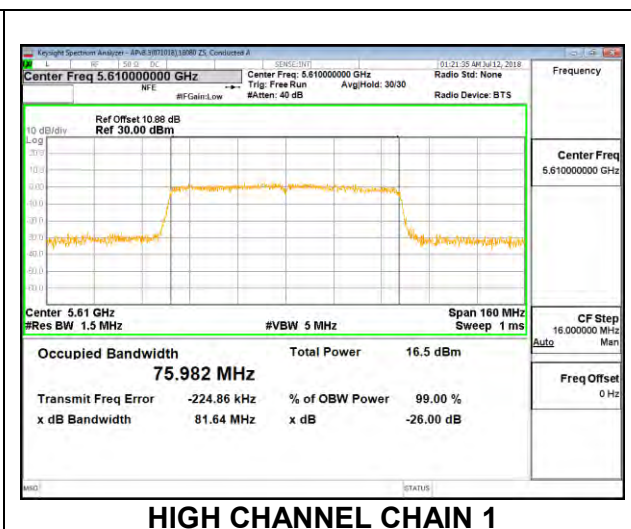
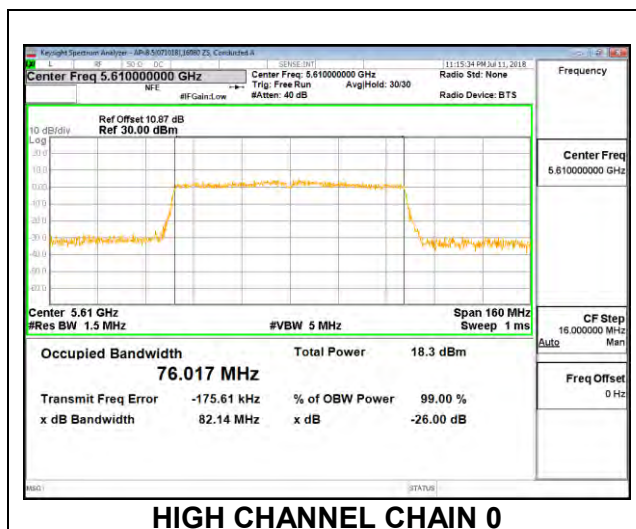

**CHANNEL 138**

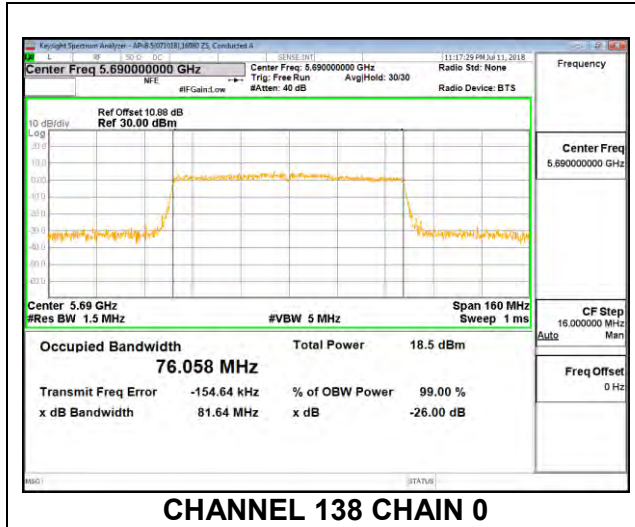

**CHANNEL 138 CHAIN 0**

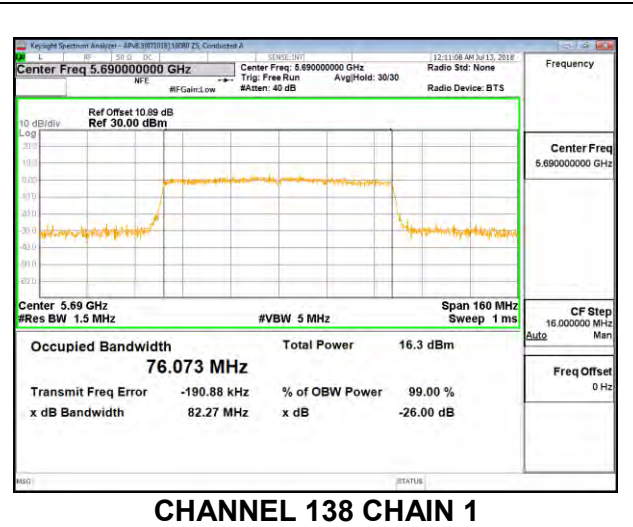

**CHANNEL 138 CHAIN 1**

**8.3.13. 802.11a MODE IN THE 5.8 GHz BAND**

**2TX Antenna 1 + Antenna 2 CDD MODE**

Channel	Frequency (MHz)	99% Bandwidth Chain 0 (MHz)	99% Bandwidth Chain 1 (MHz)
Low	5745	<b>16.575</b>	16.525
Mid	5785	16.525	<b>16.602</b>
High	5825	16.519	16.558

**LOW CHANNEL**

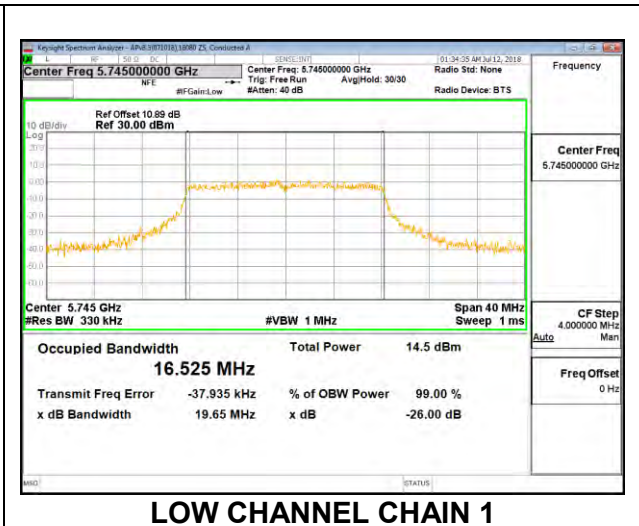
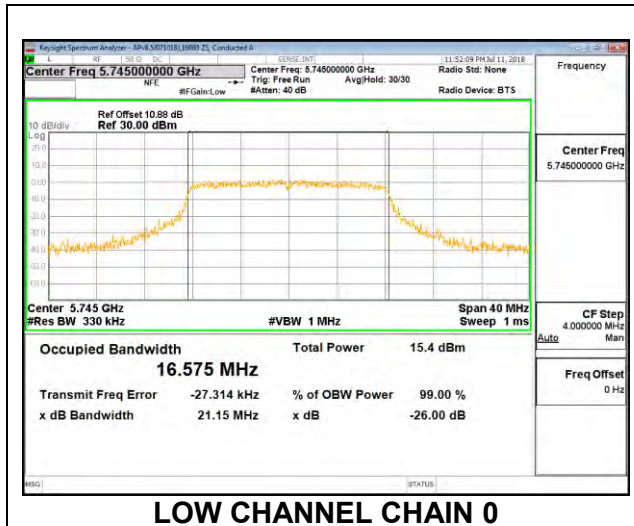

**MID CHANNEL**

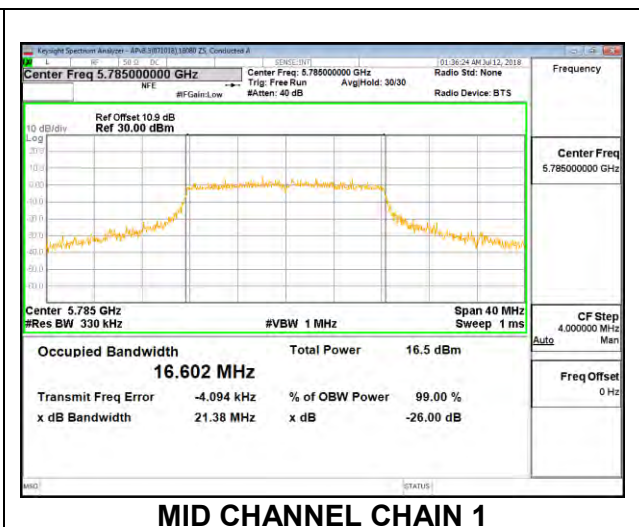
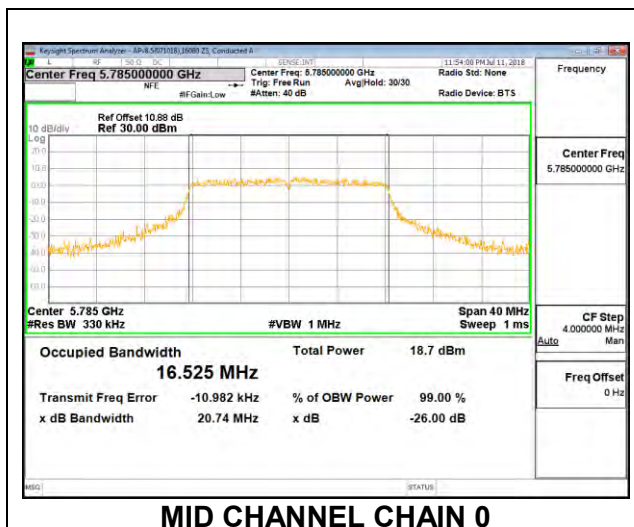

**HIGH CHANNEL**

