



# FCC RADIO TEST REPORT

**FCC ID** : PY7-58241M  
**Equipment** : GSM/WCDMA/LTE Phone+Bluetooth,  
DTS/UNII a/b/g/n/ac and NFC  
**Brand Name** : Sony  
**Applicant** : Sony Mobile Communications Inc.  
4-12-3 Higashi-Shinagawa, Shinagawa-ku,  
Tokyo, 140-0002, Japan  
**Manufacturer** : Sony Mobile Communications Inc.  
4-12-3 Higashi-Shinagawa, Shinagawa-ku,  
Tokyo, 140-0002, Japan  
**Standard** : FCC Part 15 Subpart E §15.407

The product was received on Aug. 14, 2018 and testing was started from Aug. 27, 2018 and completed on Nov. 09, 2018. We, SPORTON INTERNATIONAL INC., would like to declare that the tested sample has been evaluated in accordance with the test procedures and has been in compliance with the applicable technical standards.

The report must not be used by the client to claim product certification, approval, or endorsement by TAF or any agency of government.

The test results in this report apply exclusively to the tested model / sample. Without written approval of SPORTON INTERNATIONAL INC. EMC & Wireless Communications Laboratory, the test report shall not be reproduced except in full.

Approved by: Joseph Lin

**SPORTON INTERNATIONAL INC. EMC & Wireless Communications Laboratory**

No. 52, Huaya 1st Rd., Guishan Dist., Taoyuan City, Taiwan (R.O.C.)



## Table of Contents

History of this test report .....	3
Summary of Test Result .....	4
<b>1 General Description.....</b>	<b>5</b>
1.1 Product Feature of Equipment Under Test .....	5
1.2 Modification of EUT .....	5
1.3 Testing Location .....	6
1.4 Applicable Standards .....	6
<b>2 Test Configuration of Equipment Under Test .....</b>	<b>7</b>
2.1 Carrier Frequency and Channel .....	7
2.2 Test Mode.....	8
2.3 Connection Diagram of Test System.....	10
2.4 Support Unit used in test configuration and system .....	11
2.5 EUT Operation Test Setup .....	11
2.6 Measurement Results Explanation Example .....	11
<b>3 Test Result .....</b>	<b>12</b>
3.1 26dB & 99% Occupied Bandwidth Measurement .....	12
3.2 Maximum Conducted Output Power Measurement .....	14
3.3 Power Spectral Density Measurement .....	16
3.4 Unwanted Emissions Measurement .....	19
3.5 AC Conducted Emission Measurement .....	24
3.6 Automatically Discontinue Transmission .....	26
3.7 Antenna Requirements .....	27
<b>4 List of Measuring Equipment .....</b>	<b>28</b>
<b>5 Uncertainty of Evaluation .....</b>	<b>30</b>
<b>Appendix A. Conducted Test Results</b>	
<b>Appendix B. AC Conducted Emission Test Result</b>	
<b>Appendix C. Radiated Spurious Emission</b>	
<b>Appendix D. Radiated Spurious Emission Plots</b>	
<b>Appendix E. Duty Cycle Plots</b>	





### Summary of Test Result

Report Clause	Ref Std. Clause	Test Items	Result (PASS/FAIL)	Remark
3.1	15.403(i)	26dB Bandwidth	Pass	-
3.1	2.1049	99% Occupied Bandwidth	Reporting only	-
3.2	15.407(a)	Maximum Conducted Output Power	Pass	-
3.3	15.407(a)	Power Spectral Density	Pass	-
3.4	15.407(b)	Unwanted Emissions	Pass	Under limit 6.08 dB at 5149.260 MHz
3.5	15.207	AC Conducted Emission	Pass	Under limit 8.11 dB at 1.068 MHz
3.6	15.407(c)	Automatically Discontinue Transmission	Pass	-
3.7	15.203 15.407(a)	Antenna Requirement	Pass	-

Reviewed by: Wii Chang

Report Producer: Natasha Hsieh



# 1 General Description

## 1.1 Product Feature of Equipment Under Test

GSM/WCDMA/LTE, Bluetooth, DTS/UNII a/b/g/n/ac, FM Receiver, NFC, and GNSS.

Standards-related Product Specification	
Antenna Type	Coupling Antenna
Antenna Type / Gain	<5150 MHz ~ 5250 MHz> -3.30 dBi
	<5250 MHz ~ 5350 MHz> -2.80 dBi
	<5470 MHz ~ 5725 MHz> -2.40 dBi

EUT Information List			
HW Version	SW Version	S/N	Performed Test Item
A	1.27	CQ30013BRU	RF conducted measurement
		CQ300199ZW	Radiated Spurious Emission
		CQ30013CF3	AC Conducted Emission

Accessory List	
AC Adapter	Model Name: UCH32
	S/N: 6218W30200215 (for radiated emission) 6218W30200140 (for conducted emission)
Earphone	Model Name: MH410c
	S/N: N/A
USB Cable	Model Name: UCB24
	S/N: N/A

**Note:**

1. Above EUT list used are electrically identical per declared by manufacturer.
2. Above the accessories list are used to exercise the EUT during test, and the serial number of each type of accessories is listed in each section of this report. .
3. For other wireless features of this EUT, test report will be issued separately.

## 1.2 Modification of EUT

No modifications are made to the EUT during all test items.



### 1.3 Testing Location

Sporton Lab is accredited to ISO 17025 by Taiwan Accreditation Foundation (TAF code : 1190) and the FCC designation No. TW1190 and TW0007 under the FCC 2.948(e) by Mutual Recognition Agreement (MRA) in FCC Test.

<b>Test Site</b>	SPORTON INTERNATIONAL INC.	
<b>Test Site Location</b>	No.52, Huaya 1st Rd., Guishan Dist., Taoyuan City, Taiwan (R.O.C.) TEL: +886-3-327-3456 FAX: +886-3-328-4978	
<b>Test Site No.</b>	<b>Sporton Site No.</b>	
	TH05-HY	CO05-HY

**Note:** The test site complies with ANSI C63.4 2014 requirement.

<b>Test Site</b>	SPORTON INTERNATIONAL INC.	
<b>Test Site Location</b>	No.58, Aly. 75, Ln. 564, Wenhua 3rd, Rd., Guishan Dist., Taoyuan City, Taiwan (R.O.C.) TEL: +886-3-327-0868 FAX: +886-3-327-0855	
<b>Test Site No.</b>	<b>Sporton Site No.</b>	
	03CH11-HY	

**Note:** The test site complies with ANSI C63.4 2014 requirement.

### 1.4 Applicable Standards

According to the specifications of the manufacturer, the EUT must comply with the requirements of the following standards:

- ♦ FCC Part 15 Subpart E
- ♦ FCC KDB 789033 D02 General UNII Test Procedures New Rules v02r01.
- ♦ FCC KDB 414788 D01 Radiated Test Site v01r01.
- ♦ ANSI C63.10-2013

**Remark:**

1. All test items were verified and recorded according to the standards and without any deviation during the test.
2. This EUT has also been tested and complied with the requirements of FCC Part 15, Subpart B, recorded in a separate test report.



## 2 Test Configuration of Equipment Under Test

- a. The EUT has been associated with peripherals and configuration operated in a manner tended to maximize its emission characteristics in a typical application. Frequency range investigated: conduction emission (150 kHz to 30 MHz), radiation emission (9 kHz to the 10th harmonic of the highest fundamental frequency or to 40 GHz, whichever is lower). For radiated measurement, pre-scanned in three orthogonal panels, X, Y, Z. The worst cases (X plane) were recorded in this report.
- b. AC power line Conducted Emission was tested under maximum output power.

### 2.1 Carrier Frequency and Channel

Frequency Band	Channel	Freq. (MHz)	Channel	Freq. (MHz)
5150-5250 MHz Band 1 (U-NII-1)	36	5180	44	5220
	38*	5190	46*	5230
	40	5200	48	5240
	42 <sup>#</sup>	5210		

Frequency Band	Channel	Freq. (MHz)	Channel	Freq. (MHz)
5250-5350 MHz Band 2 (U-NII-2A)	52	5260	60	5300
	54*	5270	62*	5310
	56	5280	64	5320
	58 <sup>#</sup>	5290		

Frequency Band	Channel	Freq. (MHz)	Channel	Freq. (MHz)
5470-5725 MHz Band 3 (U-NII-2C)	100	5500	112	5560
	102*	5510	116	5580
	104	5520	132	5660
	106 <sup>#</sup>	5530	134*	5670
	108	5540	136	5680
	110*	5550	140	5700



Frequency Band	Channel	Freq. (MHz)	Channel	Freq. (MHz)
TDWR Channel	118*	5590	124	5620
	120	5600	126*	5630
	122 <sup>#</sup>	5610	128	5640

Frequency Band	Channel	Freq. (MHz)	Channel	Freq. (MHz)
Straddle Channel	138 <sup>#</sup>	5690	144	5720
	142*	5710		

Note:

1. The above Frequency and Channel in "\*" were 802.11n HT40 and 802.11ac VHT40.
2. The above Frequency and Channel in "<sup>#</sup>" were 802.11ac VHT80.

## 2.2 Test Mode

Final test modes are considering the modulation and worse data rates as below table.

Modulation	Data Rate
802.11a	6 Mbps
802.11n HT20	MCS0
802.11n HT40	MCS0
802.11ac VHT20 (Covered by HT20)	MCS0
802.11ac VHT40	MCS0
802.11ac VHT80	MCS0

Test Cases	
AC Conducted Emission	Mode 1 : Bluetooth Link + WLAN (5GHz) Link + Earphone + Battery + USB Cable (Charging from Adapter)





Ch. #		Band I : 5150-5250 MHz	Band II : 5250-5350 MHz	Band III : 5470-5725MHz
		802.11a	802.11a	802.11a
L	Low	36	52	100
M	Middle	44	60	116
H	High	48	64	140
Straddle		-	-	144

Ch. #		Band I : 5150-5250 MHz	Band II : 5250-5350 MHz	Band III : 5470-5725MHz
		802.11n HT20	802.11n HT20	802.11n HT20
L	Low	36	52	100
M	Middle	44	60	116
H	High	48	64	140
Straddle		-	-	144

Ch. #		Band I : 5150-5250 MHz	Band II : 5250-5350 MHz	Band III : 5470-5725MHz
		802.11n HT40	802.11n HT40	802.11n HT40
L	Low	38	54	102
M	Middle	-	-	110
H	High	46	62	134
Straddle		-	-	142

Ch. #		Band I : 5150-5250 MHz	Band II : 5250-5350 MHz	Band III : 5470-5725MHz
		802.11ac VHT40	802.11ac VHT40	802.11ac VHT40
L	Low	38	54	102
M	Middle	-	-	110
H	High	46	62	134
Straddle		-	-	142

Ch. #		Band I : 5150-5250 MHz	Band II : 5250-5350 MHz	Band III : 5470-5725MHz
		802.11ac VHT80	802.11ac VHT80	802.11ac VHT80
L	Low	-	-	106
M	Middle	42	58	-
H	High	-	-	-
Straddle		-	-	138

## 2.3 Connection Diagram of Test System

<WLAN Tx Mode>

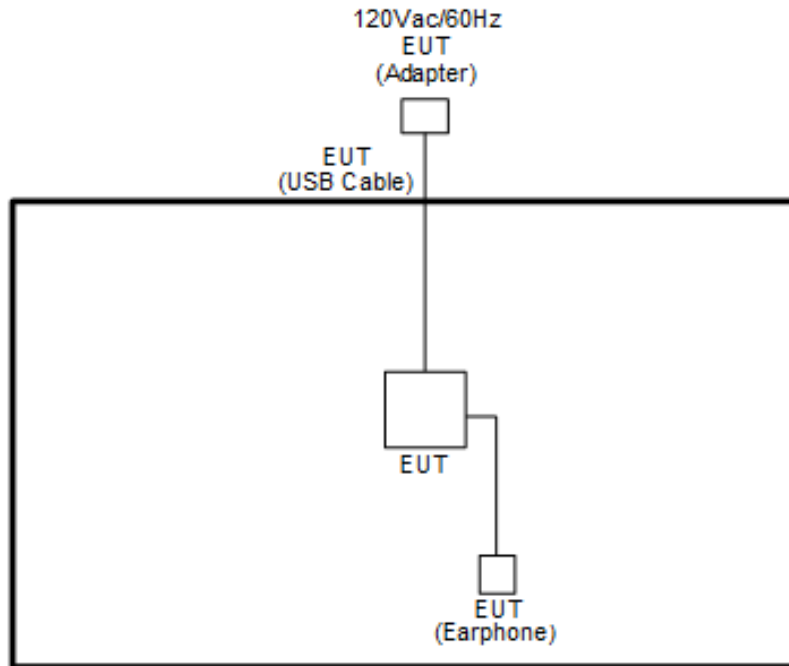

<AC Conducted Emissions Mode>

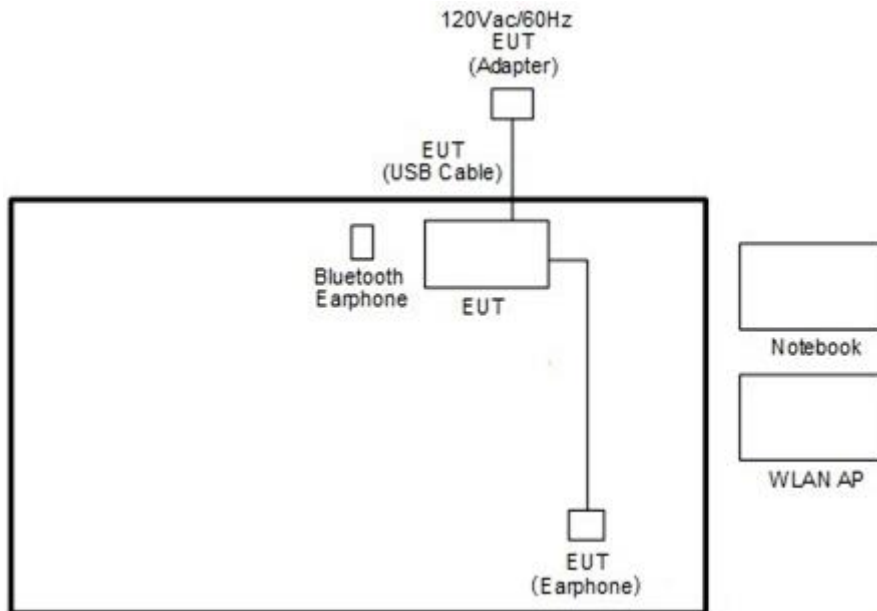

## 2.4 Support Unit used in test configuration and system

Item	Equipment	Trade Name	Model Name	FCC ID	Data Cable	Power Cord
1.	WLAN AP	ASUS	RT-AC66U	MSQ-RTAC66U	N/A	Unshielded, 1.8 m
2.	Bluetooth Earphone	Sony	SBH20	PY7-RD0010	N/A	N/A
3.	Notebook	DELL	P20G	FCC DoC/ Contains FCC ID: QDS-BRCM1051	N/A	AC I/P: Unshielded, 1.2 m DC O/P: Shielded, 1.8 m
4.	SD Card	SanDisk	MicroSD HC	FCC DoC	N/A	N/A

## 2.5 EUT Operation Test Setup

The RF test items, utility “QRCT” was installed in Notebook which was programmed in order to make the EUT get into the engineering modes to provide channel selection, power level, data rate and the application type and for continuous transmitting signals.

## 2.6 Measurement Results Explanation Example

**For all conducted test items:**

The offset level is set in the spectrum analyzer to compensate the RF cable loss and attenuator factor between EUT conducted output port and spectrum analyzer. With the offset compensation, the spectrum analyzer reading level is exactly the EUT RF output level.

Example :

The spectrum analyzer offset is derived from RF cable loss and attenuator factor.

*Offset = RF cable loss + attenuator factor.*

Following shows an offset computation example with cable loss 4.2 dB and 10dB attenuator.

$$\begin{aligned}
 \text{Offset(dB)} &= \text{RF cable loss(dB)} + \text{attenuator factor(dB)}. \\
 &= 4.2 + 10 = 14.2 \text{ (dB)}
 \end{aligned}$$

### 3 Test Result

#### 3.1 26dB & 99% Occupied Bandwidth Measurement

##### 3.1.1 Description of 26dB & 99% Occupied Bandwidth

This section is for reporting purpose only.

There is no restriction limits for bandwidth.

For Straddle Channel, according to KDB 789033 D02 General UNII Test Procedures New Rules v02r01, if the power and PSD of the devices are uniform and comply with the lower limits specified for the U-NII-2 bands, a single measurement over the entire emission bandwidth can be performed to show compliance.

##### 3.1.2 Measuring Instruments

See list of measuring equipment of this test report.

##### 3.1.3 Test Procedures

1. The testing follows FCC KDB 789033 D02 General UNII Test Procedures New Rules v02r01. Section C) Emission bandwidth
2. Set RBW = approximately 1% of the emission bandwidth.
3. Set the VBW > RBW.
4. Detector = Peak.
5. Trace mode = max hold
6. Measure the maximum width of the emission that is 26 dB down from the peak of the emission. Compare this with the RBW setting of the analyzer. Readjust RBW and repeat measurement as needed until the RBW/EBW ratio is approximately 1%.
7. For 99% Bandwidth Measurement, the spectrum analyzer's resolution bandwidth (RBW) is set 1-5% of the emission bandwidth and set the Video bandwidth (VBW)  $\geq 3 * RBW$ .
8. Measure and record the results in the test report.

##### 3.1.4 Test Setup

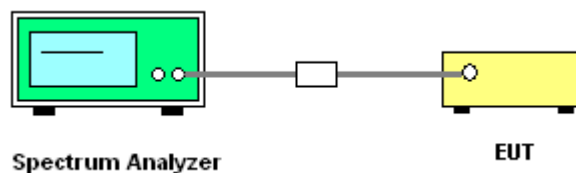

##### 3.1.5 Test Result of 26dB & 99% Occupied Bandwidth

Please refer to Appendix A.

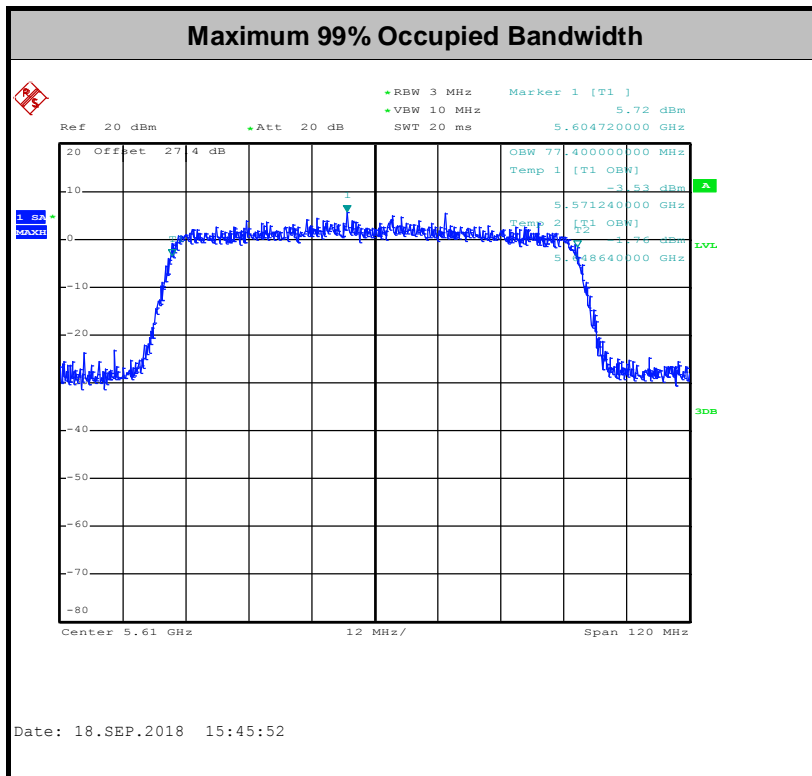
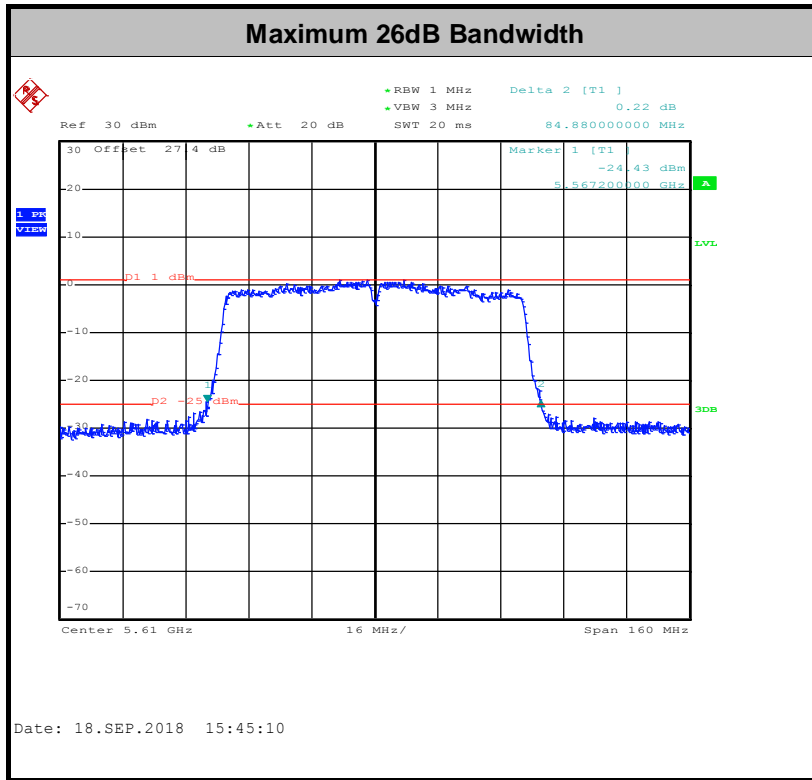

**Note:** The occupied channel bandwidth is maintained within the band of operation for all of the modulations.



## 3.2 Maximum Conducted Output Power Measurement

### 3.2.1 Limit of Maximum Conducted Output Power

<FCC 14-30 CFR 15.407>

**For the 5.15–5.25 GHz bands:**

- For mobile and portable client devices in the 5.15–5.25 GHz band, the maximum conducted output power over the frequency band of operation shall not exceed 250 mW. For an indoor access point operating in the band 5.15-5.25 GHz, the maximum conducted output power over the frequency band of operation shall not exceed 1 W.

**For the 5.25–5.725 GHz bands:**

- The maximum conducted output power over the frequency bands of operation shall not exceed the lesser of 250 mW or  $11 \text{ dBm} + 10 \log B$ , where B is the 26 dB emission bandwidth in megahertz.

For Straddle Channel, according to KDB 789033 D02 General UNII Test Procedures New Rules v02r01, if the power and PSD of the devices are uniform and comply with the lower limits specified for the U-NII-2 bands, a single measurement over the entire emission bandwidth can be performed to show compliance.

If transmitting antennas of directional gain greater than 6 dBi are used, the peak output power shall be reduced by the amount in dB that the directional gain of the antenna exceeds 6 dBi.

Note that U-NII-2 band, devices with a maximum e.i.r.p. greater than 500 mW shall implement TPC in order to have the capability to operate at least 6 dB below the maximum permitted e.i.r.p. of 1 W.

### 3.2.2 Measuring Instruments

See list of measuring equipment of this test report.

### 3.2.3 Test Procedures

The testing follows Method PM of FCC KDB 789033 D02 General UNII Test Procedures New Rules v02r01.

Method PM (Measurement using an RF average power meter):

1. Measurement is performed using a wideband RF power meter.
2. The EUT is configured to transmit continuously with a consistent duty cycle at its maximum power control level.
3. Measure the average power of the transmitter, and the average power is corrected with duty factor,  $10 \log(1/x)$ , where  $x$  is the duty cycle.

For Straddle Channel, according to KDB 789033 D02 General UNII Test Procedures New Rules v02r01, if the power and PSD of the devices are uniform and comply with the lower limits specified for the U-NII-2 bands, a single measurement over the entire emission bandwidth can be performed to show compliance.

### 3.2.4 Test Setup

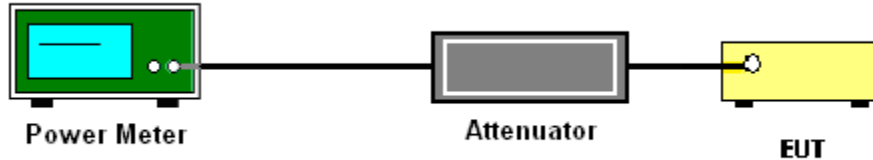

### 3.2.5 Test Result of Maximum Conducted Output Power

Please refer to Appendix A.



### **3.3 Power Spectral Density Measurement**

#### **3.3.1 Limit of Power Spectral Density**

**<FCC 14-30 CFR 15.407>**

**For the 5.15–5.25 GHz bands:**

For mobile and portable client devices in the 5.15–5.25 GHz band, the maximum power spectral density shall not exceed 11 dBm in any 1.0 MHz band. For an indoor access point operating in the band 5.15-5.25 GHz, the maximum power spectral density shall not exceed 17 dBm in any 1.0 MHz band.

**For the 5.25–5.725 GHz bands:**

The maximum power spectral density shall not exceed 11 dBm in any 1.0 MHz band.

For Straddle Channel, according to KDB 789033 D02 General UNII Test Procedures New Rules v02r01, if the power and PSD of the devices are uniform and comply with the lower limits specified for the U-NII-2 bands, a single measurement over the entire emission bandwidth can be performed to show compliance.

If transmitting antennas of directional gain greater than 6 dBi are used, the peak output power shall be reduced by the amount in dB that the directional gain of the antenna exceeds 6 dBi.

#### **3.3.2 Measuring Instruments**

See list of measuring equipment of this test report.



### 3.3.3 Test Procedures

The testing follows FCC KDB 789033 D02 General UNII Test Procedures New Rules v02r01.  
Section F) Maximum power spectral density.

#### # Method SA-2 #

(trace averaging across on and off times of the EUT transmissions, followed by duty cycle correction).

- Measure the duty cycle.
  - Set span to encompass the entire emission bandwidth (EBW) of the signal.
  - Set RBW = 1 MHz.
  - Set VBW  $\geq$  3 MHz.
  - Number of points in sweep  $\geq$  2 Span / RBW.
  - Sweep time = auto.
  - Detector = RMS
  - Trace average at least 100 traces in power averaging mode.
  - Add  $10 \log(1/x)$ , where x is the duty cycle, to the measured power in order to compute the average power during the actual transmission times. For example, add  $10 \log(1/0.25) = 6$  dB if the duty cycle is 25 percent.
1. The RF output of EUT was connected to the spectrum analyzer by a low loss cable.
  2. Each plot has already offset with cable loss, and attenuator loss. Measure the PPSD and record it.

### 3.3.4 Test Setup

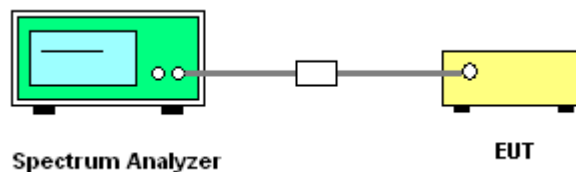

### 3.3.5 Test Result of Power Spectral Density

Please refer to Appendix A.

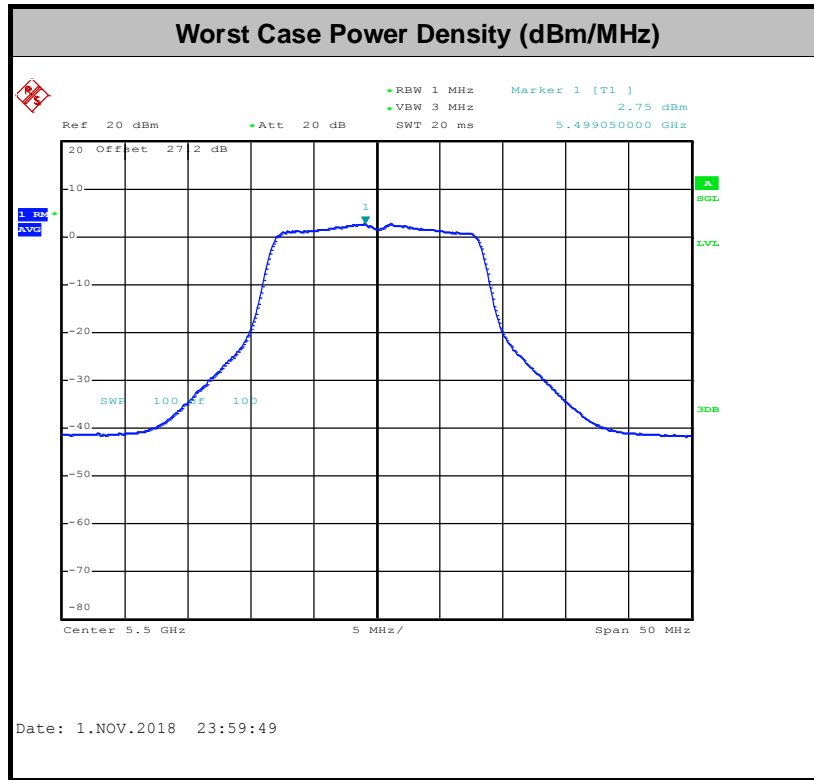

**Note:** Average Power Density (dB) = Measured value+ Duty Factor



### 3.4 Unwanted Emissions Measurement

This section is to measure unwanted emissions through radiated measurement for band edge spurious emissions and out of band emissions measurement.

#### 3.4.1 Limit of Unwanted Emissions

- (1) For transmitters operating in the 5150-5250 MHz band: all emissions outside of the 5150-5350 MHz band shall not exceed an EIRP of -27dBm/MHz.

For transmitters operating in the 5250-5350 MHz band: all emissions outside of the 5150-5350 MHz band shall not exceed an EIRP of -27 dBm/MHz. Devices operating in the 5250-5350 MHz band that generate emissions in the 5150-5250 MHz band must meet all applicable technical requirements for operation in the 5150-5250 MHz band (including indoor use) or alternatively meet an out-of-band emission EIRP limit of -27 dBm/MHz in the 5150-5250 MHz band.

For transmitters operating in the 5470-5600 MHz and 5650-5725MHz band: all emissions outside of the 5470-5600 MHz and 5650-5725MHz band shall not exceed an EIRP of -27 dBm/MHz.

- (2) Unwanted spurious emissions fallen in restricted bands shall comply with the general field strength limits as below table,

Frequency (MHz)	Field Strength (microvolts/meter)	Measurement Distance (meters)
0.009 – 0.490	2400/F(kHz)	300
0.490 – 1.705	24000/F(kHz)	30
1.705 – 30.0	30	30
30 – 88	100	3
88 – 216	150	3
216 - 960	200	3
Above 960	500	3

**Note:** The following formula is used to convert the EIRP to field strength.

$$E = \frac{1000000\sqrt{30P}}{3} \mu\text{V/m, where P is the eirp (Watts)}$$



EIRP (dBm)	Field Strength at 3m (dBµV/m)
- 27	68.3

(3) KDB789033 D02 v02r01 G)2)c)

- (i) Section 15.407(b)(1) to (b)(3) specify the unwanted emission limits for the U-NII-1 and U-NII-2 bands. As specified, emissions above 1000 MHz that are outside of the restricted bands are subject to a peak emission limit of -27 dBm/MHz.<sup>3</sup>
- (ii) Section 15.407(b)(4) specifies the unwanted emission limit for the U-NII-3 band. A band emissions mask is specified in Section 15.407(b)(4)(i). The emission limits are in terms of a Peak detector. An alternative to the band emissions mask is specified in Section 15.407(b)(4)(ii). The alternative limits are based on the highest antenna gain specified in the filing. There are also marketing and importation restrictions for the devices using the alternative limit.<sup>4</sup>

**Note 3:** An out-of-band emission that complies with both the average and peak limits of Section 15.209 is not required to satisfy the -27 dBm/MHz peak emission limit.

**Note 4:** Only devices with antenna gains of 10 dBi or less may be approved using the emission limits specified in Section 15.247(d) till March 2, 2018; all other devices operating in this band must use the mask specified in Section 15.407(b)(4)(i).

### 3.4.2 Measuring Instruments

See list of measuring equipment of this test report.

### 3.4.3 Test Procedures

1. The testing follows FCC KDB 789033 D02 General UNII Test Procedures New Rules v02r01. Section G) Unwanted emissions measurement.
  - (1) Procedure for Unwanted Emissions Measurements Below 1000MHz
    - RBW = 120 kHz
    - VBW = 300 kHz
    - Detector = Peak
    - Trace mode = max hold
  - (2) Procedure for Peak Unwanted Emissions Measurements Above 1000 MHz
    - RBW = 1 MHz
    - VBW ≥ 3 MHz
    - Detector = Peak
    - Sweep time = auto
    - Trace mode = max hold



(3) Procedures for Average Unwanted Emissions Measurements Above 1000MHz

- RBW = 1 MHz
  - VBW = 10 Hz, when duty cycle is no less than 98 percent.
  - $VBW \geq 1/T$ , when duty cycle is less than 98 percent where T is the minimum transmission duration over which the transmitter is on and is transmitting at its maximum power control level for the tested mode of operation.
2. The EUT was placed on a turntable with 0.8 meter for frequency below 1GHz and 1.5 meter for frequency above 1GHz respectively above ground.
  3. The EUT was set 3 meters from the interference receiving antenna which was mounted on the top of a variable height antenna tower.
  4. The antenna is a broadband antenna and its height is adjusted between one meter and four meters above ground to find the maximum value of the field strength for both horizontal polarization and vertical polarization of the antenna.
  5. For each suspected emission, the EUT was arranged to its worst case and then adjust the antenna tower (from 1 m to 4 m) and turntable (from 0 degree to 360 degrees) to find the maximum reading.
  6. For testing below 1GHz, if the emission level of the EUT in peak mode was 3 dB lower than the limit specified, then peak values of EUT will be reported, otherwise, the emissions will be repeated one by one using the CISPR quasi-peak method and reported.
  7. For testing above 1GHz, the emission level of the EUT in peak mode was 20dB lower than average limit (that means the emission level in average mode also complies with the limit in average mode), then peak values of EUT will be reported, otherwise, the emissions will be measured in average mode again and reported.

### 3.4.4 Test Setup

For radiated emissions below 30MHz

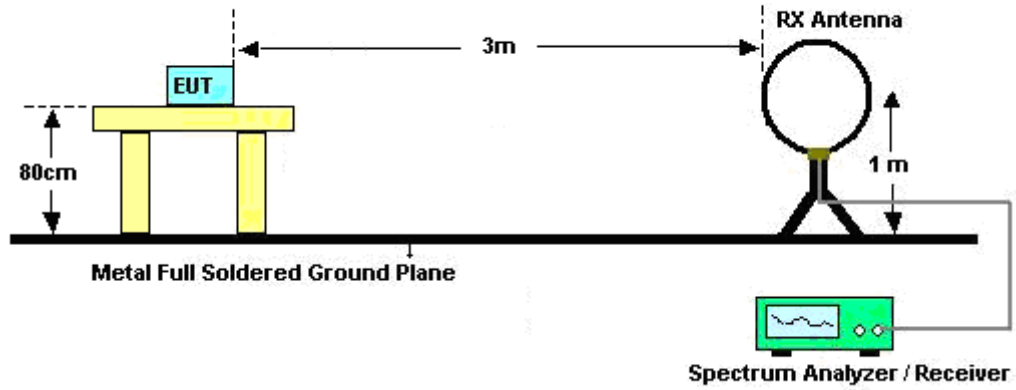

For radiated emissions from 30MHz to 1GHz

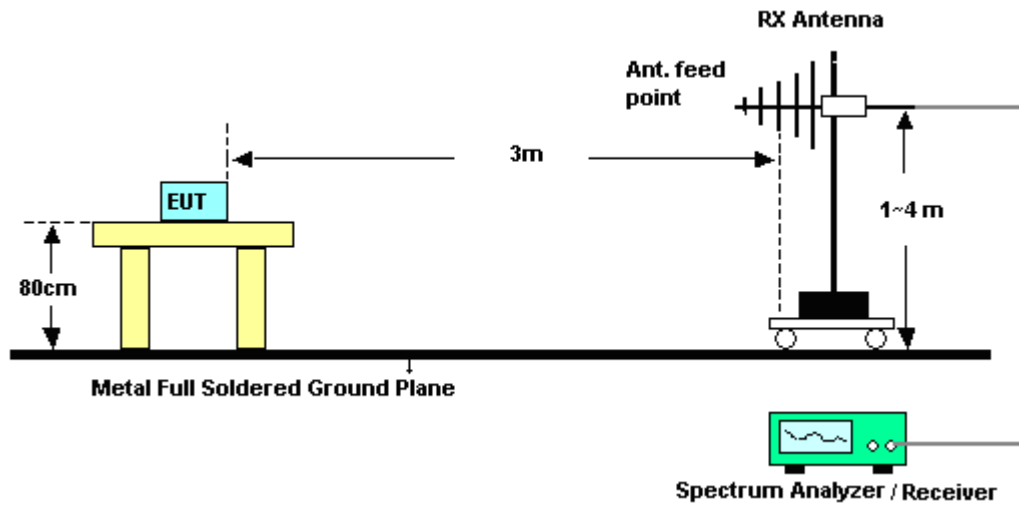

For radiated emissions above 1GHz

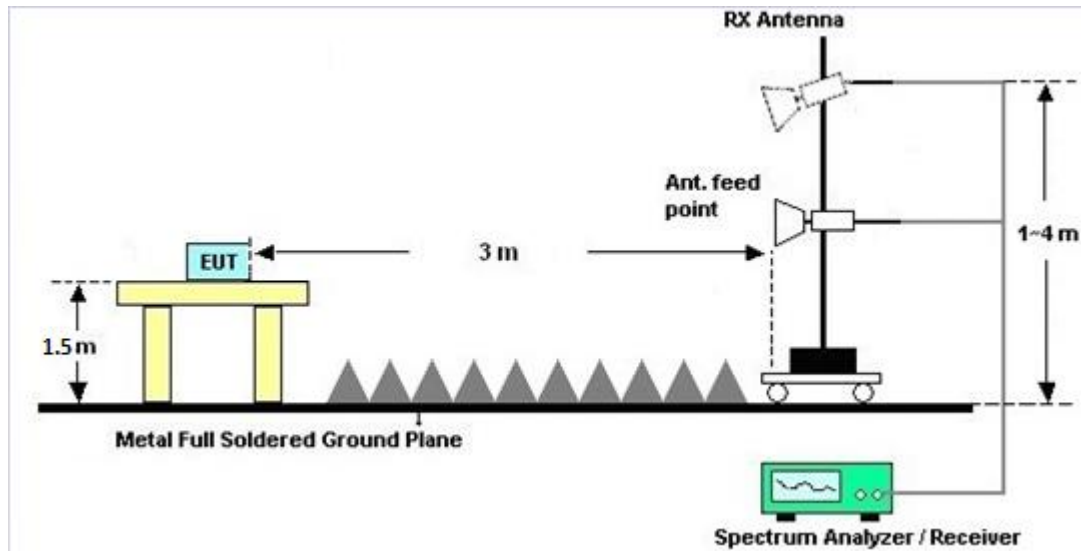

### 3.4.5 Test Results of Radiated Spurious Emissions (9 kHz ~ 30 MHz)

The low frequency, which started from 9 kHz to 30MHz, was pre-scanned and the result which was 20dB lower than the limit line was not reported.

There is a comparison data of both open-field test site and alternative test site - semi-Anechoic chamber according to 414788 D01 Radiated Test Site v01r01, and the result came out very similar.

### 3.4.6 Test Result of Radiated Spurious at Band Edges

Please refer to Appendix C and D.

### 3.4.7 Duty Cycle

Please refer to Appendix E.

### 3.4.8 Test Result of Radiated Spurious Emissions (30MHz ~ 10th Harmonic)

Please refer to Appendix C and D.



### 3.5 AC Conducted Emission Measurement

#### 3.5.1 Limit of AC Conducted Emission

For equipment that is designed to be connected to the public utility (AC) power line, the radio frequency voltage that is conducted back onto the AC power line on any frequency or frequencies within the band 150 kHz to 30 MHz shall not exceed the limits in the following table.

Frequency of emission (MHz)	Conducted limit (dB $\mu$ V)	
	Quasi-peak	Average
0.15-0.5	66 to 56*	56 to 46*
0.5-5	56	46
5-30	60	50

\*Decreases with the logarithm of the frequency.

#### 3.5.2 Measuring Instruments

See list of measuring equipment of this test report.

#### 3.5.3 Test Procedures

1. The EUT was placed 0.4 meter from the conducting wall of the shielding room was kept at least 80 centimeters from any other grounded conducting surface.
2. Connect EUT to the power mains through a line impedance stabilization network (LISN).
3. All the support units are connecting to the other LISN.
4. The LISN provides 50 ohm coupling impedance for the measuring instrument.
5. The FCC states that a 50 ohm, 50 microhenry LISN should be used.
6. Both sides of AC line were checked for maximum conducted interference.
7. The frequency range from 150 kHz to 30 MHz was searched.
8. Set the test-receiver system to Peak Detect Function and specified bandwidth with Maximum Hold Mode.



### 3.5.4 Test Setup

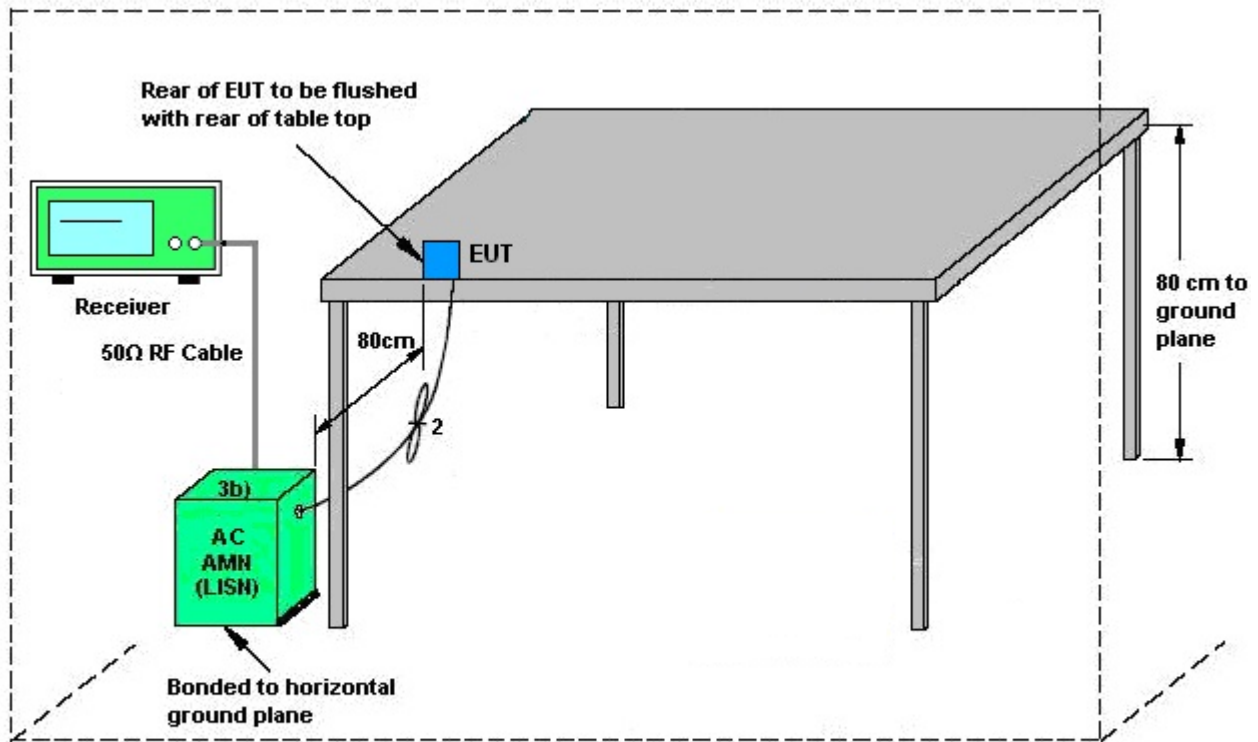

AMN = Artificial mains network (LISH)  
 AE = Associated equipment  
 EUT = Equipment under test  
 ISN = Impedance stabilization network

### 3.5.5 Test Result of AC Conducted Emission

Please refer to Appendix B.



## **3.6 Automatically Discontinue Transmission**

### **3.6.1 Limit of Automatically Discontinue Transmission**

The device shall automatically discontinue transmission in case of either absence of information to transmit or operational failure. These provisions are not intended to preclude the transmission of control or signaling information or the use of repetitive codes used by certain digital technologies to complete frame or burst intervals. Applicants shall include in their application for equipment authorization to describe how this requirement is met.

### **3.6.2 Measuring Instruments**

See list of measuring equipment of this test report.

### **3.6.3 Test Result of Automatically Discontinue Transmission**

While the EUT is not transmitting any information, the EUT can automatically discontinue transmission and become standby mode for power saving. The EUT can detect the controlling signal of ACK message transmitting from remote device and verify whether it shall resend or discontinue transmission.



## **3.7 Antenna Requirements**

### **3.7.1 Standard Applicable**

If transmitting antenna directional gain is greater than 6 dBi, both the peak transmit power and the peak power spectral density shall be reduced by the amount in dB that the directional gain of the antenna exceeds 6 dBi.

### **3.7.2 Antenna Anti-Replacement Construction**

An embedded-in antenna design is used.

### **3.7.3 Antenna Gain**

The antenna peak gain of EUT is less than 6 dBi. Therefore, it is not necessary to reduce maximum peak output power limit.



## 4 List of Measuring Equipment

Instrument	Manufacturer	Model No.	Serial No.	Characteristics	Calibration Date	Test Date	Due Date	Remark
Hygrometer	Testo	DTM-303A	TP157075	N/A	Mar. 06, 2018	Aug. 27, 2018~ Nov. 02, 2018	Mar. 05, 2019	Conducted (TH05-HY)
Power Meter	Anritsu	ML2495A	1132003	N/A	Aug. 16, 2018	Aug. 27, 2018~ Nov. 02, 2018	Aug. 15, 2019	Conducted (TH05-HY)
Power Sensor	Anritsu	MA2411B	1126017	300MHz~40GHz	Aug. 16, 2018	Aug. 27, 2018~ Nov. 02, 2018	Aug. 15, 2019	Conducted (TH05-HY)
Spectrum Analyzer	Rohde & Schwarz	FSP40	100057	9kHz-40GHz	Nov. 21, 2017	Aug. 27, 2018~ Nov. 02, 2018	Nov. 20, 2018	Conducted (TH05-HY)
Switch Box & RF Cable	Burgeon	ETF-058	EC1300484	N/A	Mar. 01, 2018	Aug. 27, 2018~ Nov. 02, 2018	Feb. 28, 2019	Conducted (TH05-HY)
AC Power Source	ChainTek	APC-1000W	N/A	N/A	N/A	Sep. 10, 2018	N/A	Conduction (CO05-HY)
EMI Test Receiver	Rohde & Schwarz	ESR3	102388	9KHz~3.6GHz	Dec. 08, 2017	Sep. 10, 2018	Dec. 07, 2018	Conduction (CO05-HY)
Hygrometer	Testo	608-H1	34913912	N/A	Mar. 06, 2018	Sep. 10, 2018	Mar. 05, 2019	Conduction (CO05-HY)
LISN	Rohde & Schwarz	ENV216	100080	9kHz~30MHz	Nov. 30, 2017	Sep. 10, 2018	Nov. 29, 2018	Conduction (CO05-HY)
Software	Rohde & Schwarz	EMC32 V10.30	N/A	N/A	N/A	Sep. 10, 2018	N/A	Conduction (CO05-HY)
LF Cable	HUBER + SUHNER	RG-214/U	LF01	N/A	Jan. 03, 2018	Sep. 10, 2018	Jan. 02, 2019	Conduction (CO05-HY)
Pulse Limiter	Rohde & Schwarz	ESH3-Z2	100851	N/A	Jan. 03, 2018	Sep. 10, 2018	Jan. 02, 2019	Conduction (CO05-HY)
Amplifier	MITEQ	TTA1840-35-HG	1871923	18GHz~40GHz, VSWR : 2.5:1 max	Jul. 16, 2018	Sep. 05, 2018~ Nov. 09, 2018	Jul. 15, 2019	Radiation (03CH11-HY)
Amplifier	SONOMA	310N	187312	9kHz~1GHz	Jan. 16, 2018	Sep. 05, 2018~ Nov. 09, 2018	Jan. 15, 2019	Radiation (03CH11-HY)
Bilog Antenna	TESEQ	CBL 6111D&N-6-06	35414&AT-N0602	30MHz~1GHz	Oct. 14, 2017	Sep. 05, 2018~ Sep. 11, 2018	Oct. 13, 2018	Radiation (03CH11-HY)
Bilog Antenna	TESEQ	CBL 6111D &00800N1D01N-06	35413&02	30MHz~1GHz	Dec. 18, 2017	Nov. 08, 2018~ Nov. 09, 2018	Dec. 17, 2018	Radiation (03CH11-HY)
Horn Antenna	SCHWARZBECK	BBHA 9120 D	9120D-1326	1GHz ~ 18GHz	Oct. 16, 2017	Sep. 05, 2018~ Sep. 11, 2018	Oct. 15, 2018	Radiation (03CH11-HY)
Horn Antenna	SCHWARZBECK	BBHA 9120 D	9120D-1326	1GHz ~ 18GHz	Oct. 30, 2018	Nov. 08, 2018~ Nov. 09, 2018	Oct. 29, 2019	Radiation (03CH11-HY)
Hygrometer	TECPEL	DTN-303B	TP140325	N/A	Oct. 12, 2017	Sep. 05, 2018~ Sep. 11, 2018	Oct. 11, 2018	Radiation (03CH11-HY)
Hygrometer	TECPEL	DTN-303B	TP161233	N/A	May 12, 2018	Nov. 08, 2018~ Nov. 09, 2018	May 11, 2019	Radiation (03CH11-HY)
Loop Antenna	Rohde & Schwarz	HFH2-Z2	100488	9 kHz~30 MHz	Nov. 23, 2017	Sep. 05, 2018~ Nov. 09, 2018	Nov. 22, 2018	Radiation (03CH11-HY)
Preamplifier	Keysight	83017A	MY53270080	1GHz~26.5GHz	Jan. 16, 2018	Sep. 05, 2018~ Nov. 09, 2018	Jan. 15, 2019	Radiation (03CH11-HY)



Instrument	Manufacturer	Model No.	Serial No.	Characteristics	Calibration Date	Test Date	Due Date	Remark
Spectrum Analyzer	Keysight	N9010A	MY5420048 6	10Hz ~ 44GHz	Oct. 19, 2017	Sep. 05, 2018~ Sep. 11, 2018	Oct. 18, 2018	Radiation (03CH11-HY)
Spectrum Analyzer	Keysight	N9010A	MY5420048 6	10Hz ~ 44GHz	Oct. 19, 2018	Nov. 08, 2018~ Nov. 09 2018	Oct. 18, 2019	Radiation (03CH11-HY)
Controller	EMEC	EM 1000	N/A	Control Turn table & Ant Mast	N/A	Sep. 05, 2018~ Nov. 09, 2018	N/A	Radiation (03CH11-HY)
Antenna Mast	EMEC	AM-BS-4500 -B	N/A	1~4m	N/A	Sep. 05, 2018~ Nov. 09, 2018	N/A	Radiation (03CH11-HY)
Turn Table	EMEC	TT 2000	N/A	0~360 Degree	N/A	Sep. 05, 2018~ Nov. 09, 2018	N/A	Radiation (03CH11-HY)
Preamplifier	Jet-Power	JPA0118-55- 303K	1710001800 054002	1GHz~18GHz	Apr. 17, 2018	Sep. 05, 2018~ Nov. 09, 2018	Apr. 16, 2019	Radiation (03CH11-HY)
SHF-EHF Horn Antenna	SCHWARZBE CK	BBHA 9170	BBHA91705 84	18GHz- 40GHz	Nov. 27, 2017	Sep. 05, 2018~ Nov. 09, 2018	Nov. 26, 2018	Radiation (03CH11-HY)
Software	Audix	E3 6.2009-8-24	RK-001042	N/A	N/A	Sep. 05, 2018~ Nov. 09, 2018	N/A	Radiation (03CH11-HY)
RF Cable	HUBER + SUHNER	SUCOFLEX 104	MY9837/4P E	9kHz-30MHz	Mar. 14, 2018	Sep. 05, 2018~ Nov. 09, 2018	Mar. 13, 2019	Radiation (03CH11-HY)
RF Cable	HUBER + SUHNER	SUCOFLEX 102	MY2859/2	30MHz-40GHz	Mar. 14, 2018	Sep. 05, 2018~ Nov. 09, 2018	Mar. 13, 2019	Radiation (03CH11-HY)
RF Cable	HUBER + SUHNER	SUCOFLEX 104	MY9837/4P E	30M-18G	Mar. 14, 2018	Sep. 05, 2018~ Nov. 09, 2018	Mar. 13, 2019	Radiation (03CH11-HY)
RF Cable	HUBER + SUHNER	SUCOFLEX 102	MY4274/2	30MHz-40GHz	Mar. 14, 2018	Sep. 05, 2018~ Nov. 09, 2018	Mar. 13, 2019	Radiation (03CH11-HY)
Filter	Wainwright	WLK4-1000- 1530-8000-4 0SS	SN11	1G Low Pass	Sep. 18, 2017	Sep. 05, 2018~ Sep. 11, 2018	Sep. 17, 2018	Radiation (03CH11-HY)
Filter	Wainwright	WLK4-1000- 1530-8000-4 0SS	SN11	1G Low Pass	Sep. 17, 2018	Nov. 08, 2018~ Nov. 09 2018	Sep. 16, 2019	Radiation (03CH11-HY)
Filter	Wainwright	WHKX12-27 00-3000-180 00-60SS	SN2	3G High Pass	Sep. 18, 2017	Sep. 05, 2018~ Sep. 11, 2018	Sep. 17, 2018	Radiation (03CH11-HY)
Filter	Wainwright	WHKX12-27 00-3000-180 00-60SS	SN2	3G High Pass	Sep. 17, 2018	Nov. 08, 2018~ Nov. 09 2018	Sep. 16, 2019	Radiation (03CH11-HY)
Filter	Wainwright	WHKX8-587 2.5-6750-18 000-40ST	SN3	6.75GHz High Pass	Sep. 18, 2017	Sep. 05, 2018~ Sep. 11, 2018	Sep. 17, 2018	Radiation (03CH11-HY)
Filter	Wainwright	WHKX8-587 2.5-6750-18 000-40ST	SN3	6.75GHz High Pass	Sep. 17, 2018	Nov. 08, 2018~ Nov. 09 2018	Sep. 16, 2019	Radiation (03CH11-HY)



## 5 Uncertainty of Evaluation

### Uncertainty of Conducted Emission Measurement (150kHz ~ 30MHz)

Measuring Uncertainty for a Level of Confidence of 95% ( $U = 2Uc(y)$ )	2.20
---	------

### Uncertainty of Radiated Emission Measurement (30 MHz ~ 1000 MHz)

Measuring Uncertainty for a Level of Confidence of 95% ( $U = 2Uc(y)$ )	5.20
---	------

### Uncertainty of Radiated Emission Measurement (1000 MHz ~ 18000 MHz)

Measuring Uncertainty for a Level of Confidence of 95% ( $U = 2Uc(y)$ )	5.50
---	------

### Uncertainty of Radiated Emission Measurement (18000 MHz ~ 40000 MHz)

Measuring Uncertainty for a Level of Confidence of 95% ( $U = 2Uc(y)$ )	5.20
---	------

**Appendix A. Test Result of Conducted Test Items**

Test Engineer:	Luffy Lin / Allen Lin / Aking Chang	Temperature:	21~25	°C
Test Date:	2018/8/27~2018/11/02	Relative Humidity:	51~54	%

**TEST RESULTS DATA**  
**26dB and 99% OBW**

Band I													
Mod.	Data Rate	NTX	CH.	Freq. (MHz)	99% Bandwidth (MHz)		26 dB Bandwidth (MHz)		IC 99% Bandwidth Power Limit (dBm)		IC 99% Bandwidth EIRP Limit (dBm)		Note
					Ant 1	Ant 2	Ant 1	Ant 2	Ant 1	Ant 2	Ant 1	Ant 2	
11a	6Mbps	1	36	5180	16.80	-	25.00	-	-	-	22.25	-	
11a	6Mbps	1	44	5220	16.85	-	25.60	-	-	-	22.27	-	
11a	6Mbps	1	48	5240	16.80	-	26.35	-	-	-	22.25	-	
HT20	MCS0	1	36	5180	17.95	-	26.80	-	-	-	22.54	-	
HT20	MCS0	1	44	5220	17.95	-	25.30	-	-	-	22.54	-	
HT20	MCS0	1	48	5240	17.95	-	25.45	-	-	-	22.54	-	
HT40	MCS0	1	38	5190	36.70	-	42.30	-	-	-	23.01	-	
HT40	MCS0	1	46	5230	36.70	-	41.97	-	-	-	23.01	-	
VHT40	MCS0	1	38	5190	36.76	-	42.35	-	-	-	23.01	-	
VHT40	MCS0	1	46	5230	36.56	-	42.71	-	-	-	23.01	-	
VHT80	MCS0	1	42	5210	77.04	-	84.48	-	-	-	23.01	-	



**TEST RESULTS DATA**  
**Average Power Table**

FCC Band I														
Mod.	Data Rate	NTX	CH.	Freq. (MHz)	Duty Factor (dB)		Average Conducted Power (dBm)			FCC Conducted Power Limit (dBm)		DG (dBi)		Pass/Fail
					Ant 1	Ant 2	Ant 1	Ant 2	SUM	Ant 1	Ant 2	Ant 1	Ant 2	
11a	6Mbps	1	36	5180	0.13	-	13.38	-		24.00	24.00	-3.30	0.00	Pass
11a	6Mbps	1	44	5220	0.13	-	13.37	-		24.00	24.00	-3.30	0.00	Pass
11a	6Mbps	1	48	5240	0.13	-	13.15	-		24.00	24.00	-3.30	0.00	Pass
HT20	MCS0	1	36	5180	0.14	-	9.43	-		24.00	24.00	-3.30	0.00	Pass
HT20	MCS0	1	44	5220	0.14	-	9.31	-		24.00	24.00	-3.30	0.00	Pass
HT20	MCS0	1	48	5240	0.14	-	9.29	-		24.00	24.00	-3.30	0.00	Pass
HT40	MCS0	1	38	5190	0.18	-	8.48	-		24.00	24.00	-3.30	0.00	Pass
HT40	MCS0	1	46	5230	0.18	-	8.46	-		24.00	24.00	-3.30	0.00	Pass
VHT20	MCS0	1	36	5180	0.13	-	9.28	-		24.00	24.00	-3.30	0.00	Pass
VHT20	MCS0	1	44	5220	0.13	-	9.27	-		24.00	24.00	-3.30	0.00	Pass
VHT20	MCS0	1	48	5240	0.13	-	9.26	-		24.00	24.00	-3.30	0.00	Pass
VHT40	MCS0	1	38	5190	0.18	-	9.40	-		24.00	24.00	-3.30	0.00	Pass
VHT40	MCS0	1	46	5230	0.18	-	9.39	-		24.00	24.00	-3.30	0.00	Pass
VHT80	MCS0	1	42	5210	0.39	-	8.34	-		24.00	24.00	-3.30	0.00	Pass

***TEST RESULTS DATA***  
***Power Spectral Density***

FCC Band I														
Mod.	Data Rate	NTX	CH.	Freq. (MHz)	Duty Factor (dB)		Average Power Density (dBm/MHz)			Average PSD Limit (dBm/MHz)		DG (dBi)		Pass /Fail
					Ant 1	Ant 2	Ant 1	Ant 2	SUM	Ant 1	Ant 2	Ant 1	Ant 2	
11a	6Mbps	1	36	5180	0.13	-	2.48	-		11.00	-	-3.30	0.00	Pass
11a	6Mbps	1	44	5220	0.13	-	2.43	-		11.00	-	-3.30	0.00	Pass
11a	6Mbps	1	48	5240	0.13	-	2.13	-		11.00	-	-3.30	0.00	Pass
HT20	MCS0	1	36	5180	0.14	-	-1.59	-		11.00	-	-3.30	0.00	Pass
HT20	MCS0	1	44	5220	0.14	-	-1.58	-		11.00	-	-3.30	0.00	Pass
HT20	MCS0	1	48	5240	0.14	-	-1.56	-		11.00	-	-3.30	0.00	Pass
HT40	MCS0	1	38	5190	0.18	-	-5.25	-		11.00	-	-3.30	0.00	Pass
HT40	MCS0	1	46	5230	0.18	-	-5.30	-		11.00	-	-3.30	0.00	Pass
VHT40	MCS0	1	38	5190	0.18	-	-4.94	-		11.00	-	-3.30	0.00	Pass
VHT40	MCS0	1	46	5230	0.18	-	-4.26	-		11.00	-	-3.30	0.00	Pass
VHT80	MCS0	1	42	5210	0.39	-	-8.38	-		11.00	-	-3.30	0.00	Pass

**TEST RESULTS DATA**  
**26dB and 99% OBW**

Band II															
Mod.	Data Rate	NTX	CH.	Freq. (MHz)	99% Bandwidth (MHz)		26 dB Bandwidth (MHz)		IC 99% Bandwidth Power Limit (dBm)		IC 99% Bandwidth EIRP Limit (dBm)		FCC 26dB Bandwidth Power Limit (dBm)		Note
					Ant 1	Ant 2	Ant 1	Ant 2	Ant 1	Ant 2	Ant 1	Ant 2	Ant 1	Ant 2	
11a	6Mbps	1	52	5260	16.80	-	25.25	-	23.25	-	29.25	-	23.98	-	
11a	6Mbps	1	60	5300	16.85	-	25.50	-	23.27	-	29.27	-	23.98	-	
11a	6Mbps	1	64	5320	16.80	-	25.40	-	23.25	-	29.25	-	23.98	-	
HT20	MCS0	1	52	5260	18.00	-	26.20	-	23.55	-	29.55	-	23.98	-	
HT20	MCS0	1	60	5300	17.95	-	26.85	-	23.54	-	29.54	-	23.98	-	
HT20	MCS0	1	64	5320	18.00	-	26.40	-	23.55	-	29.55	-	23.98	-	
HT40	MCS0	1	54	5270	36.70	-	42.66	-	23.98	-	30.00	-	23.98	-	
HT40	MCS0	1	62	5310	36.70	-	42.48	-	23.98	-	30.00	-	23.98	-	
VHT40	MCS0	1	54	5270	36.76	-	41.90	-	23.98	-	30.00	-	23.98	-	
VHT40	MCS0	1	62	5310	36.76	-	42.35	-	23.98	-	30.00	-	23.98	-	
VHT80	MCS0	1	58	5290	77.04	-	84.28	-	23.98	-	30.00	-	23.98	-	

**TEST RESULTS DATA**  
**Average Power Table**

FCC Band II															
Mod.	Data Rate	NTX	CH.	Freq. (MHz)	Duty Factor (dB)		Average Conducted Power (dBm)			FCC Conducted Power Limit (dBm)		DG (dBi)		EIRP Power Limit (dBm)	Pass/Fail
					Ant 1	Ant 2	Ant 1	Ant 2	SUM	Ant 1	Ant 2	Ant 1	Ant 2		
11a	6Mbps	1	52	5260	0.13	-	13.22	-		23.98	-	-2.80	0.00	26.99	Pass
11a	6Mbps	1	60	5300	0.13	-	13.36	-		23.98	-	-2.80	0.00	26.99	Pass
11a	6Mbps	1	64	5320	0.13	-	13.48	-		23.98	-	-2.80	0.00	26.99	Pass
HT20	MCS0	1	52	5260	0.14	-	9.24	-		23.98	-	-2.80	0.00	26.99	Pass
HT20	MCS0	1	60	5300	0.14	-	9.32	-		23.98	-	-2.80	0.00	26.99	Pass
HT20	MCS0	1	64	5320	0.14	-	9.44	-		23.98	-	-2.80	0.00	26.99	Pass
HT40	MCS0	1	54	5270	0.18	-	8.43	-		23.98	-	-2.80	0.00	26.99	Pass
HT40	MCS0	1	62	5310	0.18	-	8.06	-		23.98	-	-2.80	0.00	26.99	Pass
VHT20	MCS0	1	52	5260	0.13	-	9.23	-		23.98	-	-2.80	0.00	26.99	Pass
VHT20	MCS0	1	60	5300	0.13	-	9.31	-		23.98	-	-2.80	0.00	26.99	Pass
VHT20	MCS0	1	64	5320	0.13	-	9.43	-		23.98	-	-2.80	0.00	26.99	Pass
VHT40	MCS0	1	54	5270	0.18	-	9.29	-		23.98	-	-2.80	0.00	26.99	Pass
VHT40	MCS0	1	62	5310	0.18	-	9.41	-		23.98	-	-2.80	0.00	26.99	Pass
VHT80	MCS0	1	58	5290	0.39	-	8.49	-		23.98	-	-2.80	0.00	26.99	Pass

***TEST RESULTS DATA***  
***Power Spectral Density***

Band II														
Mod.	Data Rate	NTX	CH.	Freq. (MHz)	Duty Factor (dB)		Average Power Density (dBm/MHz)			Average PSD Limit (dBm/MHz)		DG (dBi)		Pass /Fail
					Ant 1	Ant 2	Ant 1	Ant 2	SUM	Ant 1	Ant 2	Ant 1	Ant 2	
11a	6Mbps	1	52	5260	0.13	-	2.42	-		11.00	-	-2.80	0.00	Pass
11a	6Mbps	1	60	5300	0.13	-	2.51	-		11.00	-	-2.80	0.00	Pass
11a	6Mbps	1	64	5320	0.13	-	2.60	-		11.00	-	-2.80	0.00	Pass
HT20	MCS0	1	52	5260	0.14	-	-1.57	-		11.00	-	-2.80	0.00	Pass
HT20	MCS0	1	60	5300	0.14	-	-1.21	-		11.00	-	-2.80	0.00	Pass
HT20	MCS0	1	64	5320	0.14	-	-0.95	-		11.00	-	-2.80	0.00	Pass
HT40	MCS0	1	54	5270	0.18	-	-5.75	-		11.00	-	-2.80	0.00	Pass
HT40	MCS0	1	62	5310	0.18	-	-6.04	-		11.00	-	-2.80	0.00	Pass
VHT40	MCS0	1	54	5270	0.18	-	-5.23	-		11.00	-	-2.80	0.00	Pass
VHT40	MCS0	1	62	5310	0.18	-	-4.40	-		11.00	-	-2.80	0.00	Pass
VHT80	MCS0	1	58	5290	0.39	-	-8.41	-		11.00	-	-2.80	0.00	Pass

**TEST RESULTS DATA**  
**26dB and 99% OBW**

Band III																
Mod.	Data Rate	NTX	CH.	Freq. (MHz)	99% Bandwidth In U-NII 2C (MHz)		26 dB Bandwidth In U-NII 2C (MHz)		IC 99% Bandwidth Power Limit (dBm)		IC 99% Bandwidth EIRP Limit (dBm)		FCC 26dB Bandwidth Power Limit (dBm)		6 dB Bandwidth for Straddle Channel (MHz)	
					Ant 1	Ant 2	Ant 1	Ant 2	Ant 1	Ant 2	Ant 1	Ant 2	Ant 1	Ant 2	Ant 1	Ant 2
11a	6Mbps	1	100	5500	16.75	-	24.85	-	23.24	-	29.24	-	23.98	-	----	----
11a	6Mbps	1	116	5580	16.85	-	26.15	-	23.27	-	29.27	-	23.98	-	----	----
11a	6Mbps	1	140	5700	16.85	-	25.30	-	23.27	-	29.27	-	23.98	-	----	----
11a	6Mbps	1	144	5720	13.50	-	18.35	-	22.30	-	28.30	-	23.64	-	2.9	-
HT20	MCS0	1	100	5500	18.00	-	26.75	-	23.55	-	29.55	-	23.98	-	----	----
HT20	MCS0	1	116	5580	17.95	-	26.45	-	23.54	-	29.54	-	23.98	-	----	----
HT20	MCS0	1	140	5700	18.00	-	26.15	-	23.55	-	29.55	-	23.98	-	----	----
HT20	MCS0	1	144	5720	14.05	-	18.55	-	22.48	-	28.48	-	23.68	-	3.1	-
HT40	MCS0	1	102	5510	36.70	-	42.30	-	23.98	-	30.00	-	23.98	-	----	----
HT40	MCS0	1	110	5550	36.60	-	42.48	-	23.98	-	30.00	-	23.98	-	----	----
HT40	MCS0	1	134	5670	36.60	-	42.48	-	23.98	-	30.00	-	23.98	-	----	----
HT40	MCS0	1	142	5710	33.85	-	36.60	-	23.98	-	30.00	-	23.98	-	2.6	-
VHT40	MCS0	1	102	5510	36.86	-	42.71	-	23.98	-	30.00	-	23.98	-	----	----
VHT40	MCS0	1	110	5550	36.76	-	42.89	-	23.98	-	30.00	-	23.98	-	----	----
VHT40	MCS0	1	134	5670	36.86	-	43.34	-	23.98	-	30.00	-	23.98	-	----	----
VHT40	MCS0	1	142	5710	33.48	-	36.76	-	23.98	-	30.00	-	23.98	-	2.8	-
VHT80	MCS0	1	106	5530	77.16	-	84.80	-	23.98	-	30.00	-	23.98	-	----	----
VHT80	MCS0	1	122	5610	77.40	-	84.88	-	23.98	-	30.00	-	23.98	-	----	----
VHT80	MCS0	1	138	5690	73.76	-	78.04	-	23.98	-	30.00	-	23.98	-	2.6	-

**TEST RESULTS DATA**  
**Average Power Table**

FCC Band III															
Mod.	Data Rate	NTX	CH.	Freq. (MHz)	Duty Factor (dB)		Average Conducted Power (dBm)			FCC Conducted Power Limit (dBm)		DG (dBi)		EIRP Power Limit (dBm)	Pass/Fail
					Ant 1	Ant 2	Ant 1	Ant 2	SUM	Ant 1	Ant 2	Ant 1	Ant 2		
11a	6Mbps	1	100	5500	0.13	-	13.26	-		23.98	-	-2.40	0.00	26.99	Pass
11a	6Mbps	1	116	5580	0.13	-	13.22	-		23.98	-	-2.40	0.00	26.99	Pass
11a	6Mbps	1	140	5700	0.13	-	13.48	-		23.98	-	-2.40	0.00	26.99	Pass
11a	6Mbps	1	144	5720	0.13	-	13.26	-		23.64	-	-2.40	0.00	26.99	Pass
HT20	MCS0	1	100	5500	0.14	-	9.34	-		23.98	-	-2.40	0.00	26.99	Pass
HT20	MCS0	1	116	5580	0.14	-	9.32	-		23.98	-	-2.40	0.00	26.99	Pass
HT20	MCS0	1	140	5700	0.14	-	9.30	-		23.98	-	-2.40	0.00	26.99	Pass
HT20	MCS0	1	144	5720	0.14	-	9.24	-		23.68	-	-2.40	0.00	26.99	Pass
HT40	MCS0	1	102	5510	0.18	-	8.47	-		23.98	-	-2.40	0.00	26.99	Pass
HT40	MCS0	1	110	5550	0.18	-	8.44	-		23.98	-	-2.40	0.00	26.99	Pass
HT40	MCS0	1	134	5670	0.18	-	8.30	-		23.98	-	-2.40	0.00	26.99	Pass
HT40	MCS0	1	142	5710	0.18	-	8.08	-		23.98	-	-2.40	0.00	26.99	Pass
VHT20	MCS0	1	100	5500	0.13	-	9.26	-		23.98	-	-2.40	0.00	26.99	Pass
VHT20	MCS0	1	116	5580	0.13	-	9.30	-		23.98	-	-2.40	0.00	26.99	Pass
VHT20	MCS0	1	144	5720	0.13	-	9.19	-		23.98	-	-2.40	0.00	26.99	Pass
VHT40	MCS0	1	102	5510	0.18	-	9.13	-		23.98	-	-2.40	0.00	26.99	Pass
VHT40	MCS0	1	110	5550	0.18	-	9.09	-		23.98	-	-2.40	0.00	26.99	Pass
VHT40	MCS0	1	134	5670	0.18	-	9.37	-		23.98	-	-2.40	0.00	26.99	Pass
VHT40	MCS0	1	142	5710	0.18	-	9.21	-		23.98	-	-2.40	0.00	26.99	Pass
VHT80	MCS0	1	106	5530	0.39	-	8.10	-		23.98	-	-2.40	0.00	26.99	Pass
VHT80	MCS0	1	122	5610	0.39	-	8.01	-		23.98	-	-2.40	0.00	26.99	Pass
VHT80	MCS0	1	138	5690	0.39	-	8.11	-		23.98	-	-2.40	0.00	26.99	Pass

**TEST RESULTS DATA**  
**Power Spectral Density**

Band III														
Mod.	Data Rate	NTX	CH.	Freq. (MHz)	Duty Factor (dB)		Average Power Density (dBm/MHz)			Average PSD Limit (dBm/MHz)		DG (dBi)		Pass /Fail
					Ant 1	Ant 2	Ant 1	Ant 2	SUM	Ant 1	Ant 2	Ant 1	Ant 2	
11a	6Mbps	1	100	5500	0.13	-	2.88	-		11.00	-	-2.40	0.00	Pass
11a	6Mbps	1	116	5580	0.13	-	2.84	-		11.00	-	-2.40	0.00	Pass
11a	6Mbps	1	140	5700	0.13	-	2.36	-		11.00	-	-2.40	0.00	Pass
11a	6Mbps	1	144	5720	0.13	-	2.19	-		11.00	-	-2.40	0.00	Pass
HT20	MCS0	1	100	5500	0.14	-	-1.62	-		11.00	-	-2.40	0.00	Pass
HT20	MCS0	1	116	5580	0.14	-	-1.21	-		11.00	-	-2.40	0.00	Pass
HT20	MCS0	1	140	5700	0.14	-	-1.45	-		11.00	-	-2.40	0.00	Pass
HT20	MCS0	1	144	5720	0.14	-	-1.82	-		11.00	-	-2.40	0.00	Pass
HT40	MCS0	1	102	5510	0.18	-	-5.34	-		11.00	-	-2.40	0.00	Pass
HT40	MCS0	1	110	5550	0.18	-	-4.89	-		11.00	-	-2.40	0.00	Pass
HT40	MCS0	1	134	5670	0.18	-	-5.10	-		11.00	-	-2.40	0.00	Pass
HT40	MCS0	1	142	5710	0.18	-	-6.00	-		11.00	-	-2.40	0.00	Pass
VHT40	MCS0	1	102	5510	0.18	-	-4.85	-		11.00	-	-2.40	0.00	Pass
VHT40	MCS0	1	110	5550	0.18	-	-5.13	-		11.00	-	-2.40	0.00	Pass
VHT40	MCS0	1	134	5670	0.18	-	-4.68	-		11.00	-	-2.40	0.00	Pass
VHT40	MCS0	1	142	5710	0.18	-	-4.54	-		11.00	-	-2.40	0.00	Pass
VHT80	MCS0	1	106	5530	0.39	-	-8.24	-		11.00	-	-2.40	0.00	Pass
VHT80	MCS0	1	122	5610	0.39	-	-8.56	-		11.00	-	-2.40	0.00	Pass
VHT80	MCS0	1	138	5690	0.39	-	-8.46	-		11.00	-	-2.40	0.00	Pass





## Appendix B. AC Conducted Emission Test Results

Test Engineer :	Rick Lin	Temperature :	22~23°C
		Relative Humidity :	58~60%

# EUT Information

Report NO : 881329-01  
 Test Mode : Mode 1  
 Test Voltage : 120Vac/60Hz  
 Phase : Line

Full Spectrum

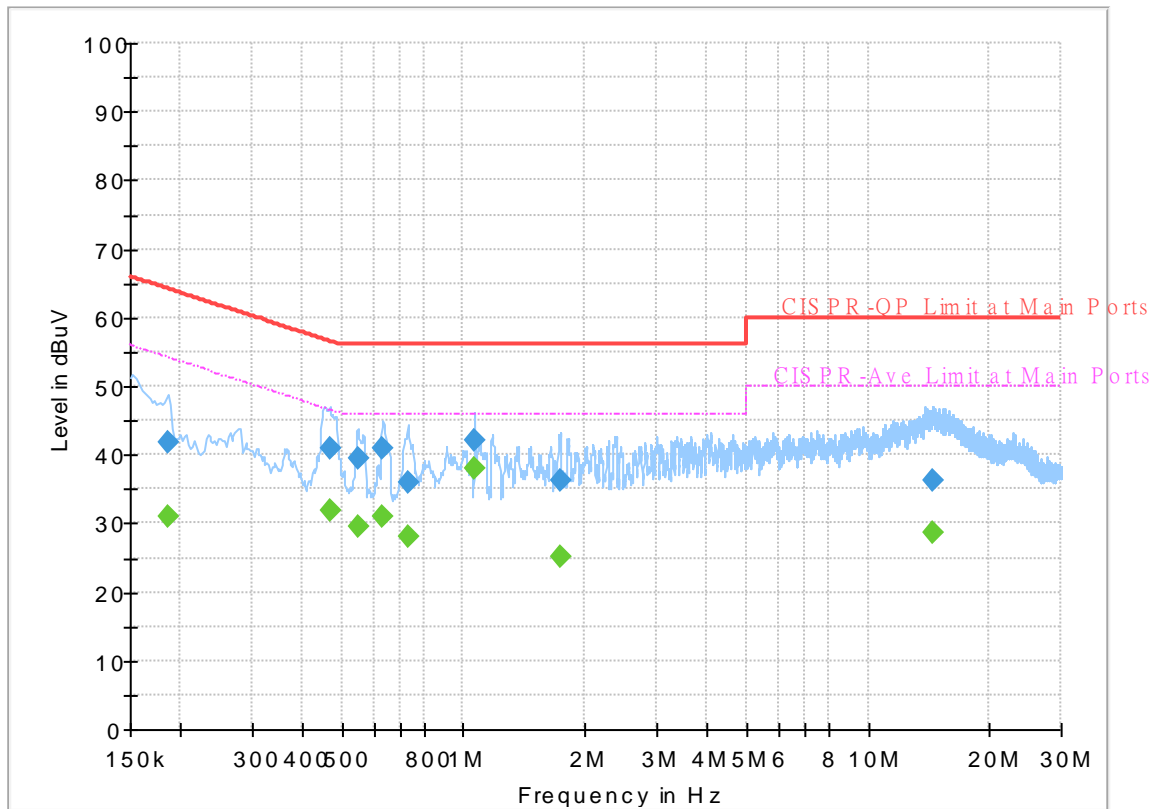

## Final Result

Frequency (MHz)	QuasiPeak (dBuV)	CAverage (dBuV)	Limit (dBuV)	Margin (dB)	Line	Filter	Corr. (dB)
0.186000	---	31.12	54.21	23.09	L1	OFF	19.5
0.186000	41.85	---	64.21	22.36	L1	OFF	19.5
0.467250	---	31.89	46.56	14.67	L1	OFF	19.5
0.467250	40.99	---	56.56	15.57	L1	OFF	19.5
0.548250	---	29.46	46.00	16.54	L1	OFF	19.5
0.548250	39.55	---	56.00	16.45	L1	OFF	19.5
0.633750	---	30.86	46.00	15.14	L1	OFF	19.6
0.633750	40.93	---	56.00	15.07	L1	OFF	19.6
0.728250	---	28.04	46.00	17.96	L1	OFF	19.6
0.728250	35.85	---	56.00	20.15	L1	OFF	19.6
1.068000	---	37.89	46.00	8.11	L1	OFF	19.6
1.068000	42.15	---	56.00	13.85	L1	OFF	19.6
1.731750	---	25.26	46.00	20.74	L1	OFF	19.6
1.731750	36.25	---	56.00	19.75	L1	OFF	19.6
14.401500	---	28.60	50.00	21.40	L1	OFF	20.1
14.401500	36.32	---	60.00	23.68	L1	OFF	20.1

## EUT Information

Report NO : 881329-01  
 Test Mode : Mode 1  
 Test Voltage : 120Vac/60Hz  
 Phase : Neutral

Full Spectrum

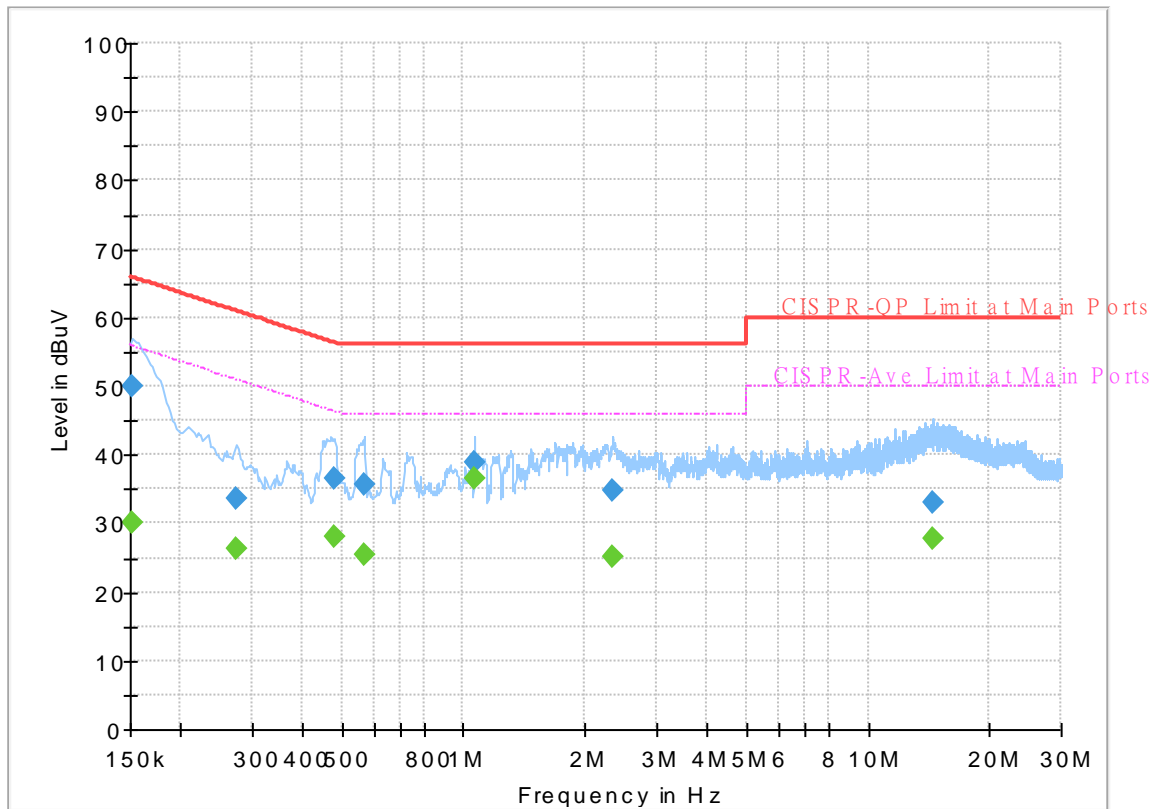

## Final Result

Frequency (MHz)	QuasiPeak (dBuV)	CAverage (dBuV)	Limit (dBuV)	Margin (dB)	Line	Filter	Corr. (dB)
0.152250	---	30.00	55.88	25.88	N	OFF	19.5
0.152250	50.02	---	65.88	15.86	N	OFF	19.5
0.273750	---	26.45	51.00	24.55	N	OFF	19.5
0.273750	33.60	---	61.00	27.40	N	OFF	19.5
0.478500	---	28.17	46.37	18.20	N	OFF	19.5
0.478500	36.67	---	56.37	19.70	N	OFF	19.5
0.568500	---	25.56	46.00	20.44	N	OFF	19.5
0.568500	35.53	---	56.00	20.47	N	OFF	19.5
1.065750	---	36.63	46.00	9.37	N	OFF	19.6
1.065750	38.97	---	56.00	17.03	N	OFF	19.6
2.341500	---	25.07	46.00	20.93	N	OFF	19.5
2.341500	34.72	---	56.00	21.28	N	OFF	19.5
14.511750	---	27.80	50.00	22.20	N	OFF	20.1
14.511750	33.07	---	60.00	26.93	N	OFF	20.1



### Appendix C. Radiated Spurious Emission

Test Engineer :	Hao Hsu, Ken Wu, Chuan Zhu, Bill Chang, and	Temperature :	21~26°C
	Wilson Wu	Relative Humidity :	51~56%

**Band 1 - 5150~5250MHz**  
**WIFI 802.11a (Band Edge @ 3m)**

WIFI Ant.	Note	Frequency ( MHz )	Level ( dBμV/m )	Over Limit ( dB )	Limit Line ( dBμV/m )	Read Level ( dBμV )	Antenna Factor ( dB/m )	Path Loss ( dB )	Preamp Factor ( dB )	Ant Pos ( cm )	Table Pos ( deg )	Peak Avg. ( P/A )	Pol. ( H/V )	
802.11a CH 36 5180MHz		5140.66	52.68	-21.32	74	44.16	31.88	9.67	33.03	111	232	P	H	
		5147.68	44.04	-9.96	54	35.49	31.9	9.68	33.03	111	232	A	H	
	*	5180	107.49	-	-	99.07	31.72	9.73	33.03	111	232	P	H	
	*	5180	99.9	-	-	91.48	31.72	9.73	33.03	111	232	A	H	
													H	
														H
			5051.48	51.01	-22.99	74	42.9	31.61	9.54	33.04	400	146	P	V
			5147.16	41.59	-12.41	54	33.05	31.89	9.68	33.03	400	146	A	V
	*		5180	100.99	-	-	92.57	31.72	9.73	33.03	400	146	P	V
	*		5180	93.53	-	-	85.11	31.72	9.73	33.03	400	146	A	V
														V
														V
802.11a CH 44 5220MHz		5150	53.06	-20.94	74	45.29	31.75	9.05	33.03	100	239	P	H	
		5150	44.47	-9.53	54	36.7	31.75	9.05	33.03	100	239	A	H	
	*	5220	111.58	-	-	103.68	31.82	9.11	33.03	100	239	P	H	
	*	5220	103.94	-	-	96.04	31.82	9.11	33.03	100	239	A	H	
			5372.26	49.59	-24.41	74	41.45	31.97	9.2	33.03	100	239	P	H
			5353.63	39.89	-14.11	54	31.78	31.95	9.19	33.03	100	239	A	H
			5094.12	50.15	-23.85	74	42.48	31.7	9.01	33.04	397	168	P	V
			5101.14	40.83	-13.17	54	33.16	31.7	9.01	33.04	397	168	A	V
	*		5220	107.55	-	-	99.65	31.82	9.11	33.03	397	168	P	V
	*		5220	100.2	-	-	92.3	31.82	9.11	33.03	397	168	A	V
			5457.31	47.99	-26.01	74	39.67	32.05	9.29	33.02	397	168	P	V
			5457.04	39.76	-14.24	54	31.44	32.05	9.29	33.02	397	168	A	V



<b>802.11a</b> <b>CH 48</b> <b>5240MHz</b>		5127.4	51.42	-22.58	74	43.69	31.73	9.03	33.03	100	243	P	H
		5148.72	42.41	-11.59	54	34.64	31.75	9.05	33.03	100	243	A	H
	*	5240	111.25	-	-	103.33	31.83	9.12	33.03	100	243	P	H
	*	5240	103.87	-	-	95.95	31.83	9.12	33.03	100	243	A	H
		5407.09	48.11	-25.89	74	39.91	32	9.22	33.02	100	243	P	H
		5351.2	40.18	-13.82	54	32.07	31.95	9.19	33.03	100	243	A	H
		5017.42	50.82	-23.18	74	43.29	31.62	8.95	33.04	392	167	P	V
		5126.88	40.86	-13.14	54	33.13	31.73	9.03	33.03	392	167	A	V
	*	5240	106.59	-	-	98.67	31.83	9.12	33.03	392	167	P	V
	*	5240	98.95	-	-	91.03	31.83	9.12	33.03	392	167	A	V
		5365.78	48.5	-25.5	74	40.37	31.97	9.19	33.03	392	167	P	V
		5456.23	39.84	-14.16	54	31.52	32.05	9.29	33.02	392	167	A	V
Remark	1. No other spurious found. 2. All results are PASS against Peak and Average limit line.												



**Band 1 5150~5250MHz  
WIFI 802.11a (Harmonic @ 3m)**

WIFI	Note	Frequency	Level	Over	Limit	Read	Antenna	Path	Preamp	Ant	Table	Peak	Pol.
Ant.				Limit	Line	Level	Factor	Loss	Factor	Pos	Pos	Avg.	
1		( MHz )	( dBμV/m )	( dB )	( dBμV/m )	( dBμV )	( dB/m )	( dB )	( dB )	( cm )	( deg )	( P/A )	( H/V )
802.11a CH 36 5180MHz		10360	44.58	-23.62	68.2	49.71	39.54	15.34	60.01	100	0	P	H
		15540	43.61	-30.39	74	44.57	38.3	18.79	58.05	100	0	P	H
													H
													H
		10360	45.41	-22.79	68.2	50.54	39.54	15.34	60.01	100	0	P	V
		15540	43.53	-30.47	74	44.49	38.3	18.79	58.05	100	0	P	V
													V
													V
802.11a CH 44 5220MHz		10440	45.62	-22.58	68.2	51.17	39.61	14.99	60.15	100	0	P	H
		15660	42.9	-31.1	74	44.7	37.67	18.41	57.88	100	0	P	H
													H
													H
		10440	48.64	-19.56	68.2	54.19	39.61	14.99	60.15	100	0	P	V
		15660	42.64	-31.36	74	44.44	37.67	18.41	57.88	100	0	P	V
													V
													V
802.11a CH 48 5240MHz		10480	44.68	-23.52	68.2	50.23	39.68	15.03	60.26	100	0	P	H
		15720	43.35	-30.65	74	45.24	37.47	18.43	57.79	100	0	P	H
													H
													H
		10480	46.12	-22.08	68.2	51.67	39.68	15.03	60.26	100	0	P	V
		15720	42.88	-31.12	74	44.77	37.47	18.43	57.79	100	0	P	V
													V
													V
Remark	1. No other spurious found. 2. All results are PASS against Peak and Average limit line.												



**Band 1 5150~5250MHz**  
**WIFI 802.11n HT20 (Band Edge @ 3m)**

WIFI	Note	Frequency	Level	Over	Limit	Read	Antenna	Path	Preamp	Ant	Table	Peak	Pol.	
Ant.				Limit	Line	Level	Factor	Loss	Factor	Pos	Pos	Avg.		
1		( MHz )	( dBμV/m )	( dB )	( dBμV/m )	( dBμV )	( dB/m )	( dB )	( dB )	( cm )	( deg )	( P/A )	( H/V )	
802.11n HT20 CH 36 5180MHz		5134.42	53.32	-20.68	74	45.57	31.73	9.05	33.03	100	237	P	H	
		5149.5	46.09	-7.91	54	38.32	31.75	9.05	33.03	100	237	A	H	
	*	5180	108.86	-	-	101.04	31.78	9.07	33.03	100	237	P	H	
	*	5180	101.15	-	-	93.33	31.78	9.07	33.03	100	237	A	H	
													H	
													H	
			5149.24	50.23	-23.77	74	42.46	31.75	9.05	33.03	400	170	P	V
			5148.2	41.49	-12.51	54	33.72	31.75	9.05	33.03	400	170	A	V
	*		5180	104.37	-	-	96.55	31.78	9.07	33.03	400	170	P	V
	*		5180	96.34	-	-	88.52	31.78	9.07	33.03	400	170	A	V
													V	
													V	
802.11n HT20 CH 44 5220MHz		5146.38	50.77	-23.23	74	43	31.75	9.05	33.03	100	241	P	H	
		5148.98	42.34	-11.66	54	34.57	31.75	9.05	33.03	100	241	A	H	
	*	5220	108.08	-	-	100.18	31.82	9.11	33.03	100	241	P	H	
	*	5220	100.65	-	-	92.75	31.82	9.11	33.03	100	241	A	H	
			5424.91	49.23	-24.77	74	40.97	32.02	9.26	33.02	100	241	P	H
			5448.94	39.88	-14.12	54	31.56	32.05	9.29	33.02	100	241	A	H
			5002.08	49.34	-24.66	74	41.85	31.6	8.93	33.04	396	168	P	V
			5070.98	40.57	-13.43	54	32.95	31.67	8.99	33.04	396	168	A	V
	*		5220	103.82	-	-	95.92	31.82	9.11	33.03	396	168	P	V
	*		5220	96.16	-	-	88.26	31.82	9.11	33.03	396	168	A	V
		5425.99	48.81	-25.19	74	40.55	32.02	9.26	33.02	396	168	P	V	
		5457.58	39.8	-14.2	54	31.48	32.05	9.29	33.02	396	168	A	V	



<b>802.11n</b> <b>HT20</b> <b>CH 48</b> <b>5240MHz</b>		5009.88	49.59	-24.41	74	42.06	31.62	8.95	33.04	100	243	P	H
		5145.86	41.16	-12.84	54	33.39	31.75	9.05	33.03	100	243	A	H
	*	5240	108.1	-	-	100.18	31.83	9.12	33.03	100	243	P	H
	*	5240	100.29	-	-	92.37	31.83	9.12	33.03	100	243	A	H
		5450.29	49.76	-24.24	74	41.44	32.05	9.29	33.02	100	243	P	H
		5445.43	39.73	-14.27	54	31.43	32.03	9.29	33.02	100	243	A	H
		5064.74	49.44	-24.56	74	41.82	31.67	8.99	33.04	392	174	P	V
		5094.38	40.48	-13.52	54	32.81	31.7	9.01	33.04	392	174	A	V
	*	5240	103.21	-	-	95.29	31.83	9.12	33.03	392	174	P	V
	*	5240	95.59	-	-	87.67	31.83	9.12	33.03	392	174	A	V
		5352.01	48.53	-25.47	74	40.42	31.95	9.19	33.03	392	174	P	V
		5441.65	39.65	-14.35	54	31.38	32.03	9.26	33.02	392	174	A	V
<b>Remark</b>	1. No other spurious found. 2. All results are PASS against Peak and Average limit line.												





**Band 1 5150~5250MHz  
WIFI 802.11n HT20 (Harmonic @ 3m)**

WIFI	Note	Frequency	Level	Over	Limit	Read	Antenna	Path	Preamp	Ant	Table	Peak	Pol.
Ant.				Limit	Line	Level	Factor	Loss	Factor	Pos	Pos	Avg.	
1		( MHz )	( dBµV/m )	( dB )	( dBµV/m )	( dBµV )	( dB/m )	( dB )	( dB )	( cm )	( deg )	( P/A )	( H/V )
802.11n HT20 CH 36 5180MHz		10360	45.04	-23.16	68.2	50.6	39.51	14.94	60.01	100	0	P	H
		15540	42.87	-31.13	74	44.58	38	18.34	58.05	100	0	P	H
													H
													H
802.11n HT20 CH 44 5220MHz		10440	44.2	-24	68.2	49.75	39.61	14.99	60.15	100	0	P	H
		15660	42.73	-31.27	74	44.53	37.67	18.41	57.88	100	0	P	H
													H
													H
802.11n HT20 CH 48 5240MHz		10480	44.15	-24.05	68.2	49.7	39.68	15.03	60.26	100	0	P	H
		15720	42.57	-31.43	74	44.46	37.47	18.43	57.79	100	0	P	H
													H
													H
802.11n HT20 CH 48 5240MHz		10480	43.74	-24.46	68.2	49.29	39.68	15.03	60.26	100	0	P	V
		15720	42.69	-31.31	74	44.58	37.47	18.43	57.79	100	0	P	V
													V
													V
Remark	1. No other spurious found. 2. All results are PASS against Peak and Average limit line.												



**Band 1 5150~5250MHz**  
**WIFI 802.11ac VHT40 (Band Edge @ 3m)**

WIFI	Note	Frequency	Level	Over	Limit	Read	Antenna	Path	Preamp	Ant	Table	Peak	Pol.
Ant.				Limit	Line	Level	Factor	Loss	Factor	Pos	Pos	Avg.	
1		( MHz )	( dBμV/m )	( dB )	( dBμV/m )	( dBμV )	( dB/m )	( dB )	( dB )	( cm )	( deg )	( P/A )	( H/V )
802.11ac VHT40 CH 38 5190MHz		5149.5	50.9	-23.1	74	42.35	31.9	9.68	33.03	107	233	P	H
		5139.88	42.35	-11.65	54	33.83	31.88	9.67	33.03	107	233	A	H
	*	5190	99.21	-	-	90.84	31.66	9.74	33.03	107	233	P	H
	*	5190	91.66	-	-	83.29	31.66	9.74	33.03	107	233	A	H
		5358.64	48.96	-25.04	74	40.82	31.35	9.82	33.03	107	233	P	H
		5451.32	40.64	-13.36	54	32.06	31.71	9.89	33.02	107	233	A	H
		5120.9	50.22	-23.78	74	41.77	31.84	9.64	33.03	400	146	P	V
		5088.92	41.81	-12.19	54	33.5	31.76	9.59	33.04	400	146	A	V
	*	5190	91.79	-	-	83.42	31.66	9.74	33.03	400	146	P	V
	*	5190	84.01	-	-	75.64	31.66	9.74	33.03	400	146	A	V
	5412.96	48.6	-25.4	74	40.14	31.63	9.85	33.02	400	146	P	V	
	5451.6	40.48	-13.52	54	31.9	31.71	9.89	33.02	400	146	A	V	
802.11ac VHT40 CH 46 5230MHz		5148.98	51.53	-22.47	74	43.76	31.75	9.05	33.03	100	237	P	H
		5150	44.23	-9.77	54	36.46	31.75	9.05	33.03	100	237	A	H
	*	5230	105.37	-	-	97.46	31.83	9.11	33.03	100	237	P	H
	*	5230	97.55	-	-	89.64	31.83	9.11	33.03	100	237	A	H
		5359.48	47.67	-26.33	74	39.56	31.95	9.19	33.03	100	237	P	H
		5459.44	40.72	-13.28	54	32.4	32.05	9.29	33.02	100	237	A	H
		5085.02	48.9	-25.1	74	41.25	31.68	9.01	33.04	395	170	P	V
		5080.86	41.42	-12.58	54	33.79	31.68	8.99	33.04	395	170	A	V
	*	5230	100.74	-	-	92.83	31.83	9.11	33.03	395	170	P	V
	*	5230	92.84	-	-	84.93	31.83	9.11	33.03	395	170	A	V
	5438.16	48.18	-25.82	74	39.91	32.03	9.26	33.02	395	170	P	V	
	5434.24	40.24	-13.76	54	31.97	32.03	9.26	33.02	395	170	A	V	
Remark	1. No other spurious found. 2. All results are PASS against Peak and Average limit line.												



**Band 1 5150~5250MHz  
WIFI 802.11ac VHT40 (Harmonic @ 3m)**

WIFI	Note	Frequency	Level	Over	Limit	Read	Antenna	Path	Preamp	Ant	Table	Peak	Pol.
Ant.				Limit	Line	Level	Factor	Loss	Factor	Pos	Pos	Avg.	
1		( MHz )	( dBμV/m )	( dB )	( dBμV/m )	( dBμV )	( dB/m )	( dB )	( dB )	( cm )	( deg )	( P/A )	( H/V )
802.11ac VHT40 CH 38 5190MHz		10380	45.13	-23.07	68.2	50.2	39.62	15.35	60.04	100	0	P	H
		15570	43.55	-30.45	74	44.6	38.15	18.8	58	100	0	P	H
													H
													H
802.11ac VHT40 CH 46 5230MHz		10460	42.97	-25.23	68.2	48.53	39.63	15	60.19	100	0	P	H
		15690	42.95	-31.05	74	44.8	37.57	18.41	57.83	100	0	P	H
													H
													H
802.11ac VHT40 CH 46 5230MHz		10460	42.62	-25.58	68.2	48.18	39.63	15	60.19	100	0	P	V
		15690	42.06	-31.94	74	43.91	37.57	18.41	57.83	100	0	P	V
													V
													V
<b>Remark</b>	1. No other spurious found. 2. All results are PASS against Peak and Average limit line.												



**Band 1 5150~5250MHz  
WIFI 802.11ac VHT80 (Band Edge @ 3m)**

WIFI	Note	Frequency	Level	Over	Limit	Read	Antenna	Path	Preamp	Ant	Table	Peak	Pol.
Ant.				Limit	Line	Level	Factor	Loss	Factor	Pos	Pos	Avg.	
1		( MHz )	( dBμV/m )	( dB )	( dBμV/m )	( dBμV )	( dB/m )	( dB )	( dB )	( cm )	( deg )	( P/A )	( H/V )
<b>802.11ac VHT80 CH 42 5210MHz</b>		5141.78	61.95	-12.05	74	54.18	31.75	9.05	33.03	100	235	P	H
		5149.26	47.92	-6.08	54	40.15	31.75	9.05	33.03	100	235	A	H
	*	5210	99.21	-	-	91.33	31.82	9.09	33.03	100	235	P	H
	*	5210	91.75	-	-	83.87	31.82	9.09	33.03	100	235	A	H
		5350.28	50.06	-23.94	74	41.95	31.95	9.19	33.03	100	235	P	H
		5459.74	40.68	-13.32	54	32.36	32.05	9.29	33.02	100	235	A	H
		5147.22	55.23	-18.77	74	47.46	31.75	9.05	33.03	397	173	P	V
		5144.84	42.66	-11.34	54	34.89	31.75	9.05	33.03	397	173	A	V
	*	5210	96.11	-	-	88.23	31.82	9.09	33.03	397	173	P	V
	*	5210	88.78	-	-	80.9	31.82	9.09	33.03	397	173	A	V
		5355.22	50.06	-23.94	74	41.95	31.95	9.19	33.03	397	173	P	V
		5459.22	40.29	-13.71	54	31.97	32.05	9.29	33.02	397	173	A	V
<b>Remark</b>	1. No other spurious found. 2. All results are PASS against Peak and Average limit line.												



**Band 1 5150~5250MHz  
WIFI 802.11ac VHT80 (Harmonic @ 3m)**

WIFI	Note	Frequency	Level	Over	Limit	Read	Antenna	Path	Preamp	Ant	Table	Peak	Pol.
Ant.				Limit	Line	Level	Factor	Loss	Factor	Pos	Pos	Avg.	
1		( MHz )	( dBμV/m )	( dB )	( dBμV/m )	( dBμV )	( dB/m )	( dB )	( dB )	( cm )	( deg )	( P/A )	( H/V )
<b>802.11ac</b>		10420	44.01	-24.19	68.2	49.57	39.58	14.98	60.12	100	0	P	H
		15630	42.34	-31.66	74	44.15	37.71	18.39	57.91	100	0	P	H
													H
													H
<b>CH 42</b>		10420	44.13	-24.07	68.2	49.69	39.58	14.98	60.12	100	0	P	V
		15630	43.61	-30.39	74	45.42	37.71	18.39	57.91	100	0	P	V
													V
													V
<b>Remark</b>	1. No other spurious found. 2. All results are PASS against Peak and Average limit line.												



**Band 2 - 5250~5350MHz**  
**WIFI 802.11a (Band Edge @ 3m)**

WIFI	Note	Frequency	Level	Over	Limit	Read	Antenna	Path	Preamp	Ant	Table	Peak	Pol.
Ant.				Limit	Line	Level	Factor	Loss	Factor	Pos	Pos	Avg.	
1		( MHz )	( dBµV/m )	( dB )	( dBµV/m )	( dBµV )	( dB/m )	( dB )	( dB )	( cm )	( deg )	( P/A )	( H/V )
802.11a CH 52 5260MHz		5136.68	50.01	-23.99	74	42.26	31.73	9.05	33.03	100	243	P	H
		5145.52	41.55	-12.45	54	33.78	31.75	9.05	33.03	100	243	A	H
	*	5260	111.22	-	-	103.26	31.87	9.12	33.03	100	243	P	H
	*	5260	103.74	-	-	95.78	31.87	9.12	33.03	100	243	A	H
		5400.48	50.01	-23.99	74	41.81	32	9.22	33.02	100	243	P	H
		5350.32	41.35	-12.65	54	33.24	31.95	9.19	33.03	100	243	A	H
		5089.08	49.77	-24.23	74	42.1	31.7	9.01	33.04	389	170	P	V
		5149.26	40.79	-13.21	54	33.02	31.75	9.05	33.03	389	170	A	V
	*	5260	106.64	-	-	98.68	31.87	9.12	33.03	389	170	P	V
	*	5260	99.13	-	-	91.17	31.87	9.12	33.03	389	170	A	V
		5410.56	49.74	-24.26	74	41.54	32	9.22	33.02	389	170	P	V
		5456.88	40.03	-13.97	54	31.71	32.05	9.29	33.02	389	170	A	V
802.11a CH 60 5300MHz		5101.32	49.95	-24.05	74	42.28	31.7	9.01	33.04	100	243	P	H
		5085.34	40.78	-13.22	54	33.13	31.68	9.01	33.04	100	243	A	H
	*	5300	110.26	-	-	102.23	31.9	9.16	33.03	100	243	P	H
	*	5300	102.72	-	-	94.69	31.9	9.16	33.03	100	243	A	H
		5353.44	52.24	-21.76	74	44.13	31.95	9.19	33.03	100	243	P	H
		5350.08	43.53	-10.47	54	35.42	31.95	9.19	33.03	100	243	A	H
		5052.36	50.44	-23.56	74	42.86	31.65	8.97	33.04	381	172	P	V
		5029.24	40.79	-13.21	54	33.23	31.63	8.97	33.04	381	172	A	V
	*	5300	105.16	-	-	97.13	31.9	9.16	33.03	381	172	P	V
	*	5300	97.67	-	-	89.64	31.9	9.16	33.03	381	172	A	V
		5350.56	49.13	-24.87	74	41.02	31.95	9.19	33.03	381	172	P	V
		5350.56	40.52	-13.48	54	32.41	31.95	9.19	33.03	381	172	A	V



<b>802.11a</b> <b>CH 64</b> <b>5320MHz</b>	*	5320	108.01	-	-	99.93	31.3	9.81	33.03	109	234	P	H
	*	5320	99.88	-	-	91.8	31.3	9.81	33.03	109	234	A	H
		5380.8	59.13	-14.87	74	50.84	31.48	9.83	33.02	109	234	P	H
		5350.08	44.87	-9.13	54	36.78	31.3	9.82	33.03	109	234	A	H
													H
													H
	*	5320	103.45	-	-	95.37	31.3	9.81	33.03	376	161	P	V
	*	5320	95.45	-	-	87.37	31.3	9.81	33.03	376	161	A	V
		5387.52	50.66	-23.34	74	42.31	31.53	9.84	33.02	376	161	P	V
		5352	40.77	-13.23	54	32.67	31.31	9.82	33.03	376	161	A	V
													V
													V
<b>Remark</b>	1. No other spurious found. 2. All results are PASS against Peak and Average limit line.												



**Band 2 5250~5350MHz**  
**WIFI 802.11a (Harmonic @ 3m)**

WIFI	Note	Frequency	Level	Over	Limit	Read	Antenna	Path	Preamp	Ant	Table	Peak	Pol.
Ant.				Limit	Line	Level	Factor	Loss	Factor	Pos	Pos	Avg.	
1		( MHz )	( dBμV/m )	( dB )	( dBμV/m )	( dBμV )	( dB/m )	( dB )	( dB )	( cm )	( deg )	( P/A )	( H/V )
802.11a CH 52 5260MHz		10520	43.93	-24.27	68.2	49.51	39.71	15.05	60.34	100	0	P	H
		15780	43.93	-30.07	74	45.85	37.33	18.46	57.71	100	0	P	H
													H
													H
		10520	44.48	-23.72	68.2	50.06	39.71	15.05	60.34	100	0	P	V
		15780	42.97	-31.03	74	44.89	37.33	18.46	57.71	100	0	P	V
													V
													V
802.11a CH 60 5300MHz		10600	44.27	-29.73	74	49.93	39.78	15.11	60.55	100	0	P	H
		15900	42.7	-31.3	74	44.72	36.99	18.53	57.54	100	0	P	H
													H
													H
		10600	42.69	-31.31	74	48.35	39.78	15.11	60.55	100	0	P	V
		15900	42.1	-31.9	74	44.12	36.99	18.53	57.54	100	0	P	V
													V
													V
802.11a CH 64 5320MHz		10640	44.77	-29.23	74	50.25	39.66	15.49	60.63	100	0	P	H
		15960	42.52	-31.48	74	44.02	37.02	18.93	57.45	100	0	P	H
													H
													H
		10640	43.95	-30.05	74	49.43	39.66	15.49	60.63	100	0	P	V
		15960	42.82	-31.18	74	44.32	37.02	18.93	57.45	100	0	P	V
													V
													V
Remark	1. No other spurious found. 2. All results are PASS against Peak and Average limit line.												





**Band 2 5250~5350MHz**  
**WIFI 802.11n HT20 (Band Edge @ 3m)**

WIFI	Note	Frequency	Level	Over	Limit	Read	Antenna	Path	Preamp	Ant	Table	Peak	Pol.
Ant.				Limit	Line	Level	Factor	Loss	Factor	Pos	Pos	Avg.	
1		( MHz )	( dBμV/m )	( dB )	( dBμV/m )	( dBμV )	( dB/m )	( dB )	( dB )	( cm )	( deg )	( P/A )	( H/V )
802.11n HT20 CH 52 5260MHz		5081.6	49.42	-24.58	74	41.77	31.68	9.01	33.04	100	238	P	H
		5080.92	40.59	-13.41	54	32.96	31.68	8.99	33.04	100	238	A	H
	*	5260	108.26	-	-	100.3	31.87	9.12	33.03	100	238	P	H
	*	5260	100.58	-	-	92.62	31.87	9.12	33.03	100	238	A	H
		5451.84	48.81	-25.19	74	40.49	32.05	9.29	33.02	100	238	P	H
		5350.32	39.97	-14.03	54	31.86	31.95	9.19	33.03	100	238	A	H
		5117.64	49.57	-24.43	74	41.86	31.72	9.03	33.04	389	164	P	V
		5066.64	40.46	-13.54	54	32.84	31.67	8.99	33.04	389	164	A	V
	*	5260	103.35	-	-	95.39	31.87	9.12	33.03	389	164	P	V
	*	5260	96.08	-	-	88.12	31.87	9.12	33.03	389	164	A	V
		5408.16	49.44	-24.56	74	41.24	32	9.22	33.02	389	164	P	V
		5425.44	39.6	-14.4	54	31.34	32.02	9.26	33.02	389	164	A	V
802.11n HT20 CH 60 5300MHz		5136.68	48.89	-25.11	74	41.14	31.73	9.05	33.03	100	240	P	H
		5074.46	40.74	-13.26	54	33.11	31.68	8.99	33.04	100	240	A	H
	*	5300	107.22	-	-	99.19	31.9	9.16	33.03	100	240	P	H
	*	5300	99.4	-	-	91.37	31.9	9.16	33.03	100	240	A	H
		5351.04	52.52	-21.48	74	44.41	31.95	9.19	33.03	100	240	P	H
		5350.8	43.33	-10.67	54	35.22	31.95	9.19	33.03	100	240	A	H
		5023.46	49.28	-24.72	74	41.74	31.63	8.95	33.04	383	162	P	V
		5073.44	40.46	-13.54	54	32.83	31.68	8.99	33.04	383	162	A	V
	*	5300	102.74	-	-	94.71	31.9	9.16	33.03	383	162	P	V
	*	5300	94.12	-	-	86.09	31.9	9.16	33.03	383	162	A	V
		5352.72	48.7	-25.3	74	40.59	31.95	9.19	33.03	383	162	P	V
		5350.32	40.37	-13.63	54	32.26	31.95	9.19	33.03	383	162	A	V



<b>802.11n</b> <b>HT20</b> <b>CH 64</b> <b>5320MHz</b>	*	5320	107.87	-	-	99.81	31.92	9.17	33.03	103	239	P	H
	*	5320	100.17	-	-	92.11	31.92	9.17	33.03	103	239	A	H
		5351.68	53.91	-20.09	74	45.8	31.95	9.19	33.03	103	239	P	H
		5350.72	46.01	-7.99	54	37.9	31.95	9.19	33.03	103	239	A	H
													H
													H
	*	5320	102.1	-	-	94.04	31.92	9.17	33.03	400	170	P	V
	*	5320	94.55	-	-	86.49	31.92	9.17	33.03	400	170	A	V
		5374.08	49.84	-24.16	74	41.69	31.97	9.2	33.02	400	170	P	V
		5350.08	42.28	-11.72	54	34.17	31.95	9.19	33.03	400	170	A	V
													V
													V
<b>Remark</b>	1. No other spurious found. 2. All results are PASS against Peak and Average limit line.												



**Band 2 5250~5350MHz**  
**WIFI 802.11n HT20 (Harmonic @ 3m)**

WIFI	Note	Frequency	Level	Over	Limit	Read	Antenna	Path	Preamp	Ant	Table	Peak	Pol.
Ant.				Limit	Line	Level	Factor	Loss	Factor	Pos	Pos	Avg.	
1		( MHz )	( dBμV/m )	( dB )	( dBμV/m )	( dBμV )	( dB/m )	( dB )	( dB )	( cm )	( deg )	( P/A )	( H/V )
802.11n HT20 CH 52 5260MHz		10520	44.45	-23.75	68.2	50.03	39.71	15.05	60.34	100	0	P	H
		15780	42.72	-31.28	74	44.64	37.33	18.46	57.71	100	0	P	H
													H
													H
802.11n HT20 CH 60 5300MHz		10600	42.73	-31.27	74	48.39	39.78	15.11	60.55	100	0	P	H
		15900	41.73	-32.27	74	43.75	36.99	18.53	57.54	100	0	P	H
													H
													H
802.11n HT20 CH 64 5320MHz		10640	42.01	-31.99	74	47.71	39.81	15.12	60.63	100	0	P	H
		15960	41.74	-32.26	74	43.83	36.8	18.56	57.45	100	0	P	H
													H
													H
802.11n HT20 CH 64 5320MHz		10640	42.82	-31.18	74	48.52	39.81	15.12	60.63	100	0	P	V
		15960	42.12	-31.88	74	44.21	36.8	18.56	57.45	100	0	P	V
													V
													V
Remark	1. No other spurious found. 2. All results are PASS against Peak and Average limit line.												



**Band 2 5250~5350MHz**  
**WIFI 802.11ac VHT40 (Band Edge @ 3m)**

WIFI	Note	Frequency	Level	Over	Limit	Read	Antenna	Path	Preamp	Ant	Table	Peak	Pol.
Ant.				Limit	Line	Level	Factor	Loss	Factor	Pos	Pos	Avg.	
1		( MHz )	( dBμV/m )	( dB )	( dBμV/m )	( dBμV )	( dB/m )	( dB )	( dB )	( cm )	( deg )	( P/A )	( H/V )
802.11ac VHT40 CH 54 5270MHz		5019.72	48.98	-25.02	74	41.45	31.62	8.95	33.04	100	235	P	H
		5144.16	41.92	-12.08	54	34.15	31.75	9.05	33.03	100	235	A	H
	*	5270	104.92	-	-	96.94	31.87	9.14	33.03	100	235	P	H
	*	5270	96.99	-	-	89.01	31.87	9.14	33.03	100	235	A	H
		5352.48	50.24	-23.76	74	42.13	31.95	9.19	33.03	100	235	P	H
		5350.08	42.83	-11.17	54	34.72	31.95	9.19	33.03	100	235	A	H
		5055.42	48.6	-25.4	74	40.98	31.67	8.99	33.04	367	163	P	V
		5065.62	41.49	-12.51	54	33.87	31.67	8.99	33.04	367	163	A	V
	*	5270	99.17	-	-	91.19	31.87	9.14	33.03	367	163	P	V
	*	5270	90.82	-	-	82.84	31.87	9.14	33.03	367	163	A	V
		5454.72	48.95	-25.05	74	40.63	32.05	9.29	33.02	367	163	P	V
		5429.04	40.51	-13.49	54	32.24	32.03	9.26	33.02	367	163	A	V
802.11ac VHT40 CH 62 5310MHz		5068.34	49.43	-24.57	74	41.81	31.67	8.99	33.04	100	240	P	H
		5128.52	41.49	-12.51	54	33.76	31.73	9.03	33.03	100	240	A	H
	*	5310	103.28	-	-	95.23	31.92	9.16	33.03	100	240	P	H
	*	5310	95.56	-	-	87.51	31.92	9.16	33.03	100	240	A	H
		5352	55.2	-18.8	74	47.09	31.95	9.19	33.03	100	240	P	H
		5350.8	46.4	-7.6	54	38.29	31.95	9.19	33.03	100	240	A	H
		5116.62	49.53	-24.47	74	41.82	31.72	9.03	33.04	384	171	P	V
		5146.54	41.48	-12.52	54	33.71	31.75	9.05	33.03	384	171	A	V
	*	5310	98.77	-	-	90.72	31.92	9.16	33.03	384	171	P	V
	*	5310	91.27	-	-	83.22	31.92	9.16	33.03	384	171	A	V
	5394	49.55	-24.45	74	41.37	31.98	9.22	33.02	384	171	P	V	
	5350.08	42.4	-11.6	54	34.29	31.95	9.19	33.03	384	171	A	V	
Remark	1. No other spurious found. 2. All results are PASS against Peak and Average limit line.												



**Band 2 5250~5350MHz  
WIFI 802.11ac VHT40 (Harmonic @ 3m)**

WIFI	Note	Frequency	Level	Over	Limit	Read	Antenna	Path	Preamp	Ant	Table	Peak	Pol.
Ant.				Limit	Line	Level	Factor	Loss	Factor	Pos	Pos	Avg.	
1		( MHz )	( dBμV/m )	( dB )	( dBμV/m )	( dBμV )	( dB/m )	( dB )	( dB )	( cm )	( deg )	( P/A )	( H/V )
802.11ac VHT40 CH 54 5270MHz		10540	42.71	-25.49	68.2	48.29	39.73	15.07	60.38	100	0	P	H
		15810	41.96	-32.04	74	43.91	37.23	18.49	57.67	100	0	P	H
													H
													H
802.11ac VHT40 CH 62 5310MHz		10620	42.7	-31.3	74	48.38	39.8	15.11	60.59	100	0	P	H
		15930	40.96	-33.04	74	43.02	36.89	18.55	57.5	100	0	P	H
													H
													H
802.11ac VHT40 CH 62 5310MHz		10620	42.6	-31.4	74	48.28	39.8	15.11	60.59	100	0	P	V
		15930	41.25	-32.75	74	43.31	36.89	18.55	57.5	100	0	P	V
													V
													V
<b>Remark</b>	1. No other spurious found. 2. All results are PASS against Peak and Average limit line.												



**Band 2 5250~5350MHz**  
**WIFI 802.11ac VHT80 (Band Edge @ 3m)**

WIFI	Note	Frequency	Level	Over	Limit	Read	Antenna	Path	Preamp	Ant	Table	Peak	Pol.
Ant.				Limit	Line	Level	Factor	Loss	Factor	Pos	Pos	Avg.	
1		( MHz )	( dBμV/m )	( dB )	( dBμV/m )	( dBμV )	( dB/m )	( dB )	( dB )	( cm )	( deg )	( P/A )	( H/V )
802.11ac VHT80 CH 58 5290MHz		5078.6	50.42	-23.58	74	42.79	31.68	8.99	33.04	100	237	P	H
		5135.3	41.48	-12.52	54	33.73	31.73	9.05	33.03	100	237	A	H
	*	5290	99.01	-	-	91	31.88	9.16	33.03	100	237	P	H
	*	5290	91.18	-	-	83.17	31.88	9.16	33.03	100	237	A	H
		5357.76	58.89	-15.11	74	50.78	31.95	9.19	33.03	100	237	P	H
		5350.8	46.52	-7.48	54	38.41	31.95	9.19	33.03	100	237	A	H
		5010.5	50.67	-23.33	74	43.14	31.62	8.95	33.04	363	167	P	V
		5067.8	41.17	-12.83	54	33.55	31.67	8.99	33.04	363	167	A	V
	*	5290	94.55	-	-	86.54	31.88	9.16	33.03	363	167	P	V
	*	5290	86.68	-	-	78.67	31.88	9.16	33.03	363	167	A	V
		5350.32	52.5	-21.5	74	44.39	31.95	9.19	33.03	363	167	P	V
	5350.32	41.96	-12.04	54	33.85	31.95	9.19	33.03	363	167	A	V	
Remark	1. No other spurious found. 2. All results are PASS against Peak and Average limit line.												



**Band 2 5250~5350MHz  
WIFI 802.11ac VHT80 (Harmonic @ 3m)**

WIFI	Note	Frequency	Level	Over	Limit	Read	Antenna	Path	Preamp	Ant	Table	Peak	Pol.
Ant.				Limit	Line	Level	Factor	Loss	Factor	Pos	Pos	Avg.	
1		( MHz )	( dBμV/m )	( dB )	( dBμV/m )	( dBμV )	( dB/m )	( dB )	( dB )	( cm )	( deg )	( P/A )	( H/V )
802.11ac VHT80 CH 58 5290MHz		10580	42.96	-25.24	68.2	48.61	39.77	15.09	60.51	100	0	P	H
		15870	41.48	-32.52	74	43.5	37.04	18.51	57.57	100	0	P	H
													H
													H
5290MHz		10580	43.18	-25.02	68.2	48.83	39.77	15.09	60.51	100	0	P	V
		15870	41.95	-32.05	74	43.97	37.04	18.51	57.57	100	0	P	V
													V
													V
<b>Remark</b>	1. No other spurious found. 2. All results are PASS against Peak and Average limit line.												



**Band 3 - 5470~5725MHz**  
**WIFI 802.11a (Band Edge @ 3m)**

WIFI	Note	Frequency	Level	Over	Limit	Read	Antenna	Path	Preamp	Ant	Table	Peak	Pol.	
Ant.				Limit	Line	Level	Factor	Loss	Factor	Pos	Pos	Avg.		
1		( MHz )	( dBµV/m )	( dB )	( dBµV/m )	( dBµV )	( dB/m )	( dB )	( dB )	( cm )	( deg )	( P/A )	( H/V )	
802.11a CH 100 5500MHz		5445.36	52.96	-21.04	74	44.41	31.69	9.88	33.02	100	238	P	H	
		5462.48	53.83	-14.37	68.2	45.2	31.75	9.9	33.02	100	238	P	H	
		5454	43.86	-10.14	54	35.27	31.72	9.89	33.02	100	238	A	H	
	*	5500	106.09	-	-	97.28	31.9	9.93	33.02	100	238	P	H	
	*	5500	98.53	-	-	89.72	31.9	9.93	33.02	100	238	A	H	
														H
			5443.44	50.47	-23.53	74	41.92	31.69	9.88	33.02	352	14	P	V
			5461.2	50.52	-17.68	68.2	41.9	31.74	9.9	33.02	352	14	P	V
			5454.64	41.07	-12.93	54	32.48	31.72	9.89	33.02	352	14	A	V
	*		5500	101.17	-	-	92.36	31.9	9.93	33.02	352	14	P	V
	*		5500	93.61	-	-	84.8	31.9	9.93	33.02	352	14	A	V
														V
802.11a CH 116 5580MHz		5418.64	49.3	-24.7	74	41.08	32.02	9.22	33.02	100	243	P	H	
		5467.12	48.19	-20.01	68.2	39.85	32.07	9.29	33.02	100	243	P	H	
		5455.12	40.32	-13.68	54	32	32.05	9.29	33.02	100	243	A	H	
	*	5580	106.64	-	-	98.01	32.22	9.48	33.07	100	243	P	H	
	*	5580	99.16	-	-	90.53	32.22	9.48	33.07	100	243	A	H	
			5747.36	49.28	-18.92	68.2	40.02	32.53	9.88	33.15	100	243	P	H
			5383.36	50.09	-23.91	74	41.93	31.98	9.2	33.02	387	164	P	V
			5470	49.2	-19	68.2	40.86	32.07	9.29	33.02	387	164	P	V
			5444.8	40.07	-13.93	54	31.77	32.03	9.29	33.02	387	164	A	V
	*		5580	104.53	-	-	95.9	32.22	9.48	33.07	387	164	P	V
	*		5580	97.11	-	-	88.48	32.22	9.48	33.07	387	164	A	V
			5755.55	50.5	-17.7	68.2	41.2	32.57	9.88	33.15	387	164	P	V





<b>802.11a</b> <b>CH 140</b> <b>5700MHz</b>	*	5700	108.84	-	-	99.77	32.44	9.75	33.12	100	238	P	H
	*	5700	101.25	-	-	92.18	32.44	9.75	33.12	100	238	A	H
		5726.52	58.68	-9.52	68.2	49.5	32.5	9.81	33.13	100	238	P	H
													H
													H
													H
	*	5700	105.95	-	-	96.88	32.44	9.75	33.12	370	157	P	V
	*	5700	98.36	-	-	89.29	32.44	9.75	33.12	370	157	A	V
		5725.4	56.27	-11.93	68.2	47.09	32.5	9.81	33.13	370	157	P	V
													V
													V
													V
<b>Remark</b>	1. No other spurious found. 2. All results are PASS against Peak and Average limit line.												



**Band 3 - 5470~5725MHz**  
**WIFI 802.11a (Harmonic @ 3m)**

WIFI	Note	Frequency	Level	Over	Limit	Read	Antenna	Path	Preamp	Ant	Table	Peak	Pol.
Ant.				Limit	Line	Level	Factor	Loss	Factor	Pos	Pos	Avg.	
1		( MHz )	( dBμV/m )	( dB )	( dBμV/m )	( dBμV )	( dB/m )	( dB )	( dB )	( cm )	( deg )	( P/A )	( H/V )
802.11a CH 100 5500MHz		11000	45.8	-28.2	74	51.6	40	15.7	61.5	100	0	P	H
		16500	43.64	-24.56	68.2	42.83	38.7	19.41	57.3	100	0	P	H
													H
													H
		11000	45.44	-28.56	74	51.24	40	15.7	61.5	100	0	P	V
		16500	44.65	-23.55	68.2	43.84	38.7	19.41	57.3	100	0	P	V
													V
													V
802.11a CH 116 5580MHz		11160	46.22	-27.78	74	52.19	40.07	15.49	61.53	100	0	P	H
		16740	44.1	-24.1	68.2	42.59	39.08	19.25	56.82	100	0	P	H
													H
													H
		11160	46.3	-27.7	74	52.27	40.07	15.49	61.53	100	0	P	V
		16740	45.38	-22.82	68.2	43.87	39.08	19.25	56.82	100	0	P	V
													V
													V
802.11a CH 140 5700MHz		11400	45.51	-28.49	74	51.41	40.02	15.66	61.58	100	0	P	H
		17100	45.93	-22.27	68.2	42.42	40.06	19.53	56.08	100	0	P	H
													H
													H
		11400	44.24	-29.76	74	50.14	40.02	15.66	61.58	100	0	P	V
		17100	45.94	-22.26	68.2	42.43	40.06	19.53	56.08	100	0	P	V
													V
													V
Remark	1. No other spurious found. 2. All results are PASS against Peak and Average limit line.												



**Band 3 - 5470~5725MHz**  
**WIFI 802.11n HT20 (Band Edge @ 3m)**

WIFI	Note	Frequency	Level	Over	Limit	Read	Antenna	Path	Preamp	Ant	Table	Peak	Pol.	
Ant.				Limit	Line	Level	Factor	Loss	Factor	Pos	Pos	Avg.		
1		( MHz )	( dBμV/m )	( dB )	( dBμV/m )	( dBμV )	( dB/m )	( dB )	( dB )	( cm )	( deg )	( P/A )	( H/V )	
802.11n HT20 CH 100 5500MHz		5454.32	51.57	-22.43	74	42.98	31.72	9.89	33.02	112	237	P	H	
		5467.28	50.35	-17.85	68.2	41.7	31.77	9.9	33.02	112	237	P	H	
		5460	41.79	-12.21	54	33.18	31.74	9.89	33.02	112	237	A	H	
	*	5500	103.17	-	-	94.36	31.9	9.93	33.02	112	237	P	H	
	*	5500	94.32	-	-	85.51	31.9	9.93	33.02	112	237	A	H	
														H
			5425.52	48.98	-25.02	74	40.49	31.65	9.86	33.02	398	159	P	V
			5466.64	48.58	-19.62	68.2	39.93	31.77	9.9	33.02	398	159	P	V
			5459.6	40.35	-13.65	54	31.74	31.74	9.89	33.02	398	159	A	V
	*		5500	99.21	-	-	90.4	31.9	9.93	33.02	398	159	P	V
	*		5500	90.31	-	-	81.5	31.9	9.93	33.02	398	159	A	V
													V	
802.11n HT20 CH 116 5580MHz		5446.24	47.84	-26.16	74	39.52	32.05	9.29	33.02	100	335	P	H	
		5464.24	47.25	-20.95	68.2	38.91	32.07	9.29	33.02	100	335	P	H	
		5458.48	39.68	-14.32	54	31.36	32.05	9.29	33.02	100	335	A	H	
	*	5580	102.13	-	-	93.5	32.22	9.48	33.07	100	335	P	H	
	*	5580	94.75	-	-	86.12	32.22	9.48	33.07	100	335	A	H	
			5731.925	49.68	-18.52	68.2	40.45	32.5	9.88	33.15	100	335	P	H
			5452.96	47.83	-26.17	74	39.51	32.05	9.29	33.02	387	164	P	V
			5466.88	47.63	-20.57	68.2	39.29	32.07	9.29	33.02	387	164	P	V
			5458.48	39.87	-14.13	54	31.55	32.05	9.29	33.02	387	164	A	V
	*		5580	100.89	-	-	92.26	32.22	9.48	33.07	387	164	P	V
	*		5580	93.38	-	-	84.75	32.22	9.48	33.07	387	164	A	V
		5753.345	49.76	-18.44	68.2	40.46	32.57	9.88	33.15	387	164	P	V	



<b>802.11n</b> <b>HT20</b> <b>CH 140</b> <b>5700MHz</b>	*	5700	104.16	-	-	95.09	32.44	9.75	33.12	100	238	P	H
	*	5700	96.47	-	-	87.4	32.44	9.75	33.12	100	238	A	H
		5725.64	52.85	-15.35	68.2	43.67	32.5	9.81	33.13	100	238	P	H
													H
													H
													H
	*	5700	101.87	-	-	92.8	32.44	9.75	33.12	368	154	P	V
	*	5700	94.2	-	-	85.13	32.44	9.75	33.12	368	154	A	V
		5739.08	51.99	-16.21	68.2	42.73	32.53	9.88	33.15	368	154	P	V
													V
													V
													V
<b>Remark</b>	1. No other spurious found. 2. All results are PASS against Peak and Average limit line.												



**Band 3 - 5470~5725MHz**  
**WIFI 802.11n HT20 (Harmonic @ 3m)**

WIFI	Note	Frequency	Level	Over	Limit	Read	Antenna	Path	Preamp	Ant	Table	Peak	Pol.
Ant.				Limit	Line	Level	Factor	Loss	Factor	Pos	Pos	Avg.	
1		( MHz )	( dBμV/m )	( dB )	( dBμV/m )	( dBμV )	( dB/m )	( dB )	( dB )	( cm )	( deg )	( P/A )	( H/V )
802.11n HT20 CH 100 5500MHz		11000	47.03	-26.97	74	52.83	40	15.7	61.5	100	0	P	H
		16500	45.96	-22.24	68.2	45.15	38.7	19.41	57.3	100	0	P	H
													H
													H
802.11n HT20 CH 116 5580MHz		11160	45.79	-28.21	74	51.76	40.07	15.49	61.53	100	0	P	H
		16740	44.43	-23.77	68.2	42.92	39.08	19.25	56.82	100	0	P	H
													H
													H
802.11n HT20 CH 140 5700MHz		11400	45.88	-28.12	74	51.78	40.02	15.66	61.58	100	0	P	H
		17100	45.47	-22.73	68.2	41.96	40.06	19.53	56.08	100	0	P	H
													H
													H
802.11n HT20 CH 140 5700MHz		11400	44.78	-29.22	74	50.68	40.02	15.66	61.58	100	0	P	V
		17100	45.59	-22.61	68.2	42.08	40.06	19.53	56.08	100	0	P	V
													V
													V
Remark	1. No other spurious found. 2. All results are PASS against Peak and Average limit line.												



**Band 3 - 5470~5725MHz**  
**WIFI 802.11ac VHT40 (Band Edge @ 3m)**

WIFI	Note	Frequency	Level	Over	Limit	Read	Antenna	Path	Preamp	Ant	Table	Peak	Pol.
Ant.				Limit	Line	Level	Factor	Loss	Factor	Pos	Pos	Avg.	
1		( MHz )	( dBµV/m )	( dB )	( dBµV/m )	( dBµV )	( dB/m )	( dB )	( dB )	( cm )	( deg )	(P/A)	(H/V)
802.11ac VHT40 CH 102 5510MHz		5440	51.87	-22.13	74	43.6	32.03	9.26	33.02	112	243	P	H
		5469.52	51.83	-16.37	68.2	43.49	32.07	9.29	33.02	112	243	P	H
		5459.68	43.78	-10.22	54	35.46	32.05	9.29	33.02	112	243	A	H
	*	5510	100.14	-	-	91.7	32.1	9.37	33.03	112	243	P	H
	*	5510	92.08	-	-	83.64	32.1	9.37	33.03	112	243	A	H
		5725.31	49.14	-19.06	68.2	39.96	32.5	9.81	33.13	112	243	P	H
		5422.72	49.39	-24.61	74	41.13	32.02	9.26	33.02	396	154	P	V
		5467.12	48.89	-19.31	68.2	40.55	32.07	9.29	33.02	396	154	P	V
		5455.84	42.01	-11.99	54	33.69	32.05	9.29	33.02	396	154	A	V
	*	5510	98.72	-	-	90.28	32.1	9.37	33.03	396	154	P	V
	*	5510	90.53	-	-	82.09	32.1	9.37	33.03	396	154	A	V
	5731.61	50.18	-18.02	68.2	40.95	32.5	9.88	33.15	396	154	P	V	
802.11ac VHT40 CH 110 5550MHz		5414.8	49.75	-24.25	74	41.53	32.02	9.22	33.02	100	244	P	H
		5463.04	48.59	-19.61	68.2	40.25	32.07	9.29	33.02	100	244	P	H
		5459.68	41.54	-12.46	54	33.22	32.05	9.29	33.02	100	244	A	H
	*	5550	99.31	-	-	90.73	32.19	9.44	33.05	100	244	P	H
	*	5550	91.54	-	-	82.96	32.19	9.44	33.05	100	244	A	H
		5726.885	50.67	-17.53	68.2	41.49	32.5	9.81	33.13	100	244	P	H
		5442.16	49.33	-24.67	74	41.06	32.03	9.26	33.02	389	164	P	V
		5465.68	47.86	-20.34	68.2	39.52	32.07	9.29	33.02	389	164	P	V
		5441.68	40.55	-13.45	54	32.28	32.03	9.26	33.02	389	164	A	V
	*	5550	97.85	-	-	89.27	32.19	9.44	33.05	389	164	P	V
	*	5550	89.37	-	-	80.79	32.19	9.44	33.05	389	164	A	V
	5762.795	49.18	-19.02	68.2	39.82	32.57	9.95	33.16	389	164	P	V	



<b>802.11ac</b>  <b>VHT40</b>  <b>CH 134</b>  <b>5670MHz</b>		5364.7	47.49	-26.51	74	39.36	31.97	9.19	33.03	103	242	P	H
		5460.95	48.02	-20.18	68.2	39.7	32.05	9.29	33.02	103	242	P	H
		5446.6	40.53	-13.47	54	32.21	32.05	9.29	33.02	103	242	A	H
	*	5670	100.48	-	-	91.5	32.41	9.68	33.11	103	242	P	H
	*	5670	92.12	-	-	83.14	32.41	9.68	33.11	103	242	A	H
		5741.375	51.57	-16.63	68.2	42.31	32.53	9.88	33.15	103	242	P	H
		5437.5	47.99	-26.01	74	39.72	32.03	9.26	33.02	395	157	P	V
		5470	48.68	-19.52	68.2	40.34	32.07	9.29	33.02	395	157	P	V
		5456.4	40.22	-13.78	54	31.9	32.05	9.29	33.02	395	157	A	V
	*	5670	98.63	-	-	89.65	32.41	9.68	33.11	395	157	P	V
	*	5670	90.47	-	-	81.49	32.41	9.68	33.11	395	157	A	V
		5748.725	49.58	-18.62	68.2	40.32	32.53	9.88	33.15	395	157	P	V
<b>Remark</b>	1. No other spurious found. 2. All results are PASS against Peak and Average limit line.												



**Band 3 - 5470~5725MHz**  
**WIFI 802.11ac VHT40 (Harmonic @ 3m)**

WIFI	Note	Frequency	Level	Over	Limit	Read	Antenna	Path	Preamp	Ant	Table	Peak	Pol.
Ant.				Limit	Line	Level	Factor	Loss	Factor	Pos	Pos	Avg.	
1		( MHz )	( dBµV/m )	( dB )	( dBµV/m )	( dBµV )	( dB/m )	( dB )	( dB )	( cm )	( deg )	( P/A )	( H/V )
802.11ac VHT40 CH 102 5510MHz		11020	44.66	-29.34	74	50.66	40.1	15.4	61.5	100	0	P	H
		16530	43.37	-24.83	68.2	42.96	38.58	19.06	57.23	100	0	P	H
													H
													H
		11020	42.89	-31.11	74	48.89	40.1	15.4	61.5	100	0	P	V
		16530	42.9	-25.3	68.2	42.49	38.58	19.06	57.23	100	0	P	V
													V
802.11ac VHT40 CH 110 5550MHz		11100	43.3	-30.7	74	49.29	40.08	15.45	61.52	100	0	P	H
		16650	42.73	-25.47	68.2	41.68	38.87	19.17	56.99	100	0	P	H
													H
													H
		11100	42.65	-31.35	74	48.64	40.08	15.45	61.52	100	0	P	V
		16650	43.13	-25.07	68.2	42.08	38.87	19.17	56.99	100	0	P	V
													V
802.11ac VHT40 CH 134 5670MHz		11340	43.35	-30.65	74	49.27	40.03	15.62	61.57	100	0	P	H
		17010	44.51	-23.69	68.2	41.53	39.76	19.48	56.26	100	0	P	H
													H
													H
		11340	44.22	-29.78	74	50.14	40.03	15.62	61.57	100	0	P	V
		17010	44	-24.2	68.2	41.02	39.76	19.48	56.26	100	0	P	V
													V
Remark	1. No other spurious found.												
	2. All results are PASS against Peak and Average limit line.												





**Band 3 - 5470~5725MHz**  
**WIFI 802.11ac VHT80 (Band Edge @ 3m)**

WIFI	Note	Frequency	Level	Over	Limit	Read	Antenna	Path	Preamp	Ant	Table	Peak	Pol.
Ant.				Limit	Line	Level	Factor	Loss	Factor	Pos	Pos	Avg.	
1		( MHz )	( dBμV/m )	( dB )	( dBμV/m )	( dBμV )	( dB/m )	( dB )	( dB )	( cm )	( deg )	( P/A )	( H/V )
802.11ac VHT80 CH 106 5530MHz		5459.2	61.54	-12.46	74	53.22	32.05	9.29	33.02	100	241	P	H
		5460.88	61.3	-6.9	68.2	52.98	32.05	9.29	33.02	100	241	P	H
		5458	45.97	-8.03	54	37.65	32.05	9.29	33.02	100	241	A	H
	*	5530	96.5	-	-	88.01	32.13	9.41	33.05	100	241	P	H
	*	5530	88.2	-	-	79.71	32.13	9.41	33.05	100	241	A	H
		5740.115	50.49	-17.71	68.2	41.23	32.53	9.88	33.15	100	241	P	H
		5459.68	55.87	-18.13	74	47.55	32.05	9.29	33.02	391	158	P	V
		5460.64	57.36	-10.84	68.2	49.04	32.05	9.29	33.02	391	158	P	V
		5459.68	43.08	-10.92	54	34.76	32.05	9.29	33.02	391	158	A	V
	*	5530	93.87	-	-	85.38	32.13	9.41	33.05	391	158	P	V
	*	5530	86.06	-	-	77.57	32.13	9.41	33.05	391	158	A	V
	5736.335	51.08	-17.12	68.2	41.82	32.53	9.88	33.15	391	158	P	V	
802.11ac VHT80 CH 122 5610MHz		5419.65	49.62	-24.38	74	41.36	32.02	9.26	33.02	106	244	P	H
		5466.55	49.63	-18.57	68.2	41.29	32.07	9.29	33.02	106	244	P	H
		5438.9	40.46	-13.54	54	32.19	32.03	9.26	33.02	106	244	A	H
	*	5610	95.13	-	-	86.37	32.29	9.55	33.08	106	244	P	H
	*	5610	86.91	-	-	78.15	32.29	9.55	33.08	106	244	A	H
		5734.375	51.14	-17.06	68.2	41.91	32.5	9.88	33.15	106	244	P	H
		5387.1	49.86	-24.14	74	41.7	31.98	9.2	33.02	400	165	P	V
		5466.9	49.97	-18.23	68.2	41.63	32.07	9.29	33.02	400	165	P	V
		5453.6	40.41	-13.59	54	32.09	32.05	9.29	33.02	400	165	A	V
	*	5610	93.8	-	-	85.04	32.29	9.55	33.08	400	165	P	V
	*	5610	85.69	-	-	76.93	32.29	9.55	33.08	400	165	A	V
	5739.275	50.63	-17.57	68.2	41.37	32.53	9.88	33.15	400	165	P	V	
Remark	1. No other spurious found. 2. All results are PASS against Peak and Average limit line.												



**Band 3 5470~5725MHz  
WIFI 802.11ac VHT80 (Harmonic @ 3m)**

WIFI	Note	Frequency	Level	Over	Limit	Read	Antenna	Path	Preamp	Ant	Table	Peak	Pol.
Ant.				Limit	Line	Level	Factor	Loss	Factor	Pos	Pos	Avg.	
1		( MHz )	( dBμV/m )	( dB )	( dBμV/m )	( dBμV )	( dB/m )	( dB )	( dB )	( cm )	( deg )	( P/A )	( H/V )
802.11ac VHT80 CH 106 5530MHz		11060	44.92	-29.08	74	50.92	40.09	15.42	61.51	100	0	P	H
		16590	43.95	-24.25	68.2	43.26	38.71	19.11	57.13	100	0	P	H
													H
													H
802.11ac VHT80 CH 122 5610MHz		11060	43.99	-30.01	74	49.99	40.09	15.42	61.51	100	0	P	V
		16590	43.36	-24.84	68.2	42.67	38.71	19.11	57.13	100	0	P	V
													V
													V
802.11ac VHT80 CH 122 5610MHz		11220	46.71	-27.29	74	52.65	40.06	15.54	61.54	100	0	P	H
		16830	44.97	-23.23	68.2	42.99	39.29	19.33	56.64	100	0	P	H
													H
													H
802.11ac VHT80 CH 122 5610MHz		11220	45.25	-28.75	74	51.19	40.06	15.54	61.54	100	0	P	V
		16830	44.79	-23.41	68.2	42.81	39.29	19.33	56.64	100	0	P	V
													V
													V
<b>Remark</b>	1. No other spurious found. 2. All results are PASS against Peak and Average limit line.												



**Band 3 - Straddle Channel  
WIFI 802.11a (Band Edge @ 3m)**

WIFI	Note	Frequency	Level	Over	Limit	Read	Antenna	Path	Preamp	Ant	Table	Peak	Pol.
Ant.				Limit	Line	Level	Factor	Loss	Factor	Pos	Pos	Avg.	
1		( MHz )	( dBμV/m )	( dB )	( dBμV/m )	( dBμV )	( dB/m )	( dB )	( dB )	( cm )	( deg )	( P/A )	( H/V )
802.11a CH 144 5720MHz	*	5720	107.54	-	-	98.36	32.5	9.81	33.13	100	242	P	H
	*	5720	99.89	-	-	90.71	32.5	9.81	33.13	100	242	A	H
													H
													H
													H
													H
	*	5720	105.88	-	-	96.7	32.5	9.81	33.13	386	156	P	V
	*	5720	98.48	-	-	89.3	32.5	9.81	33.13	386	156	A	V
													V
													V
													V
	<b>Remark</b>	1. No other spurious found. 2. All results are PASS against Peak and Average limit line.											



Band 3 - Straddle Channel
WIFI 802.11a (Harmonic @ 3m)

Table with 14 columns: WIFI Ant., Note, Frequency (MHz), Level (dBµV/m), Over Limit (dB), Limit Line (dBµV/m), Read Level (dBµV), Antenna Factor (dB/m), Path Loss (dB), Preamp Factor (dB), Ant Pos (cm), Table Pos (deg), Peak Avg. (P/A), Pol. (H/V). Rows include data for 802.11a CH 144 at 5720MHz and a Remark section.



**Band 3 - Straddle Channel  
WIFI 802.11n HT20 (Band Edge @ 3m)**

WIFI	Note	Frequency	Level	Over	Limit	Read	Antenna	Path	Preamp	Ant	Table	Peak	Pol.
Ant.				Limit	Line	Level	Factor	Loss	Factor	Pos	Pos	Avg.	
1		( MHz )	( dBµV/m )	( dB )	( dBµV/m )	(dBµV)	( dB/m )	( dB )	( dB )	( cm )	( deg )	(P/A)	(H/V)
802.11n HT20 CH 144 5720MHz	*	5720	103.18	-	-	94	32.5	9.81	33.13	100	240	P	H
	*	5720	95.62	-	-	86.44	32.5	9.81	33.13	100	240	A	H
													H
													H
													H
													H
	*	5720	101.39	-	-	92.21	32.5	9.81	33.13	388	152	P	V
	*	5720	93.87	-	-	84.69	32.5	9.81	33.13	388	152	A	V
													V
													V
<b>Remark</b>	1. No other spurious found. 2. All results are PASS against Peak and Average limit line.												



**Band 3 - Straddle Channel  
WIFI 802.11n HT20 (Harmonic @ 3m)**

WIFI	Note	Frequency	Level	Over	Limit	Read	Antenna	Path	Preamp	Ant	Table	Peak	Pol.
Ant.				Limit	Line	Level	Factor	Loss	Factor	Pos	Pos	Avg.	
1		( MHz )	( dBμV/m )	( dB )	( dBμV/m )	( dBμV )	( dB/m )	( dB )	( dB )	( cm )	( deg )	( P/A )	( H/V )
802.11n HT20 CH 144		11440	45.36	-28.64	74	51.26	40.01	15.68	61.59	100	0	P	H
		17160	44.26	-23.94	68.2	40.33	40.3	19.56	55.93	100	0	P	H
													H
													H
5720MHz		11440	44.91	-29.09	74	50.81	40.01	15.68	61.59	100	0	P	V
		17160	45.35	-22.85	68.2	41.42	40.3	19.56	55.93	100	0	P	V
													V
													V
<b>Remark</b>	1. No other spurious found. 2. All results are PASS against Peak and Average limit line.												



**Band 3 - Straddle Channel**  
**WIFI 802.11ac VHT40 (Band Edge @ 3m)**

WIFI	Note	Frequency	Level	Over	Limit	Read	Antenna	Path	Preamp	Ant	Table	Peak	Pol.
Ant.				Limit	Line	Level	Factor	Loss	Factor	Pos	Pos	Avg.	
1		( MHz )	( dBμV/m )	( dB )	( dBμV/m )	( dBμV )	( dB/m )	( dB )	( dB )	( cm )	( deg )	( P/A )	( H/V )
802.11ac VHT40 CH 142 5710MHz	*	5710	99.94	-	-	90.79	32.47	9.81	33.13	103	243	P	H
	*	5710	91.88	-	-	82.73	32.47	9.81	33.13	103	243	A	H
													H
													H
													H
													H
	*	5710	99.18	-	-	90.03	32.47	9.81	33.13	386	160	P	V
	*	5710	90.76	-	-	81.61	32.47	9.81	33.13	386	160	A	V
													V
													V
<b>Remark</b>	1. No other spurious found. 2. All results are PASS against Peak and Average limit line.												



**Band 3 - Straddle Channel  
WIFI 802.11ac VHT40 (Harmonic @ 3m)**

WIFI	Note	Frequency	Level	Over	Limit	Read	Antenna	Path	Preamp	Ant	Table	Peak	Pol.
Ant.				Limit	Line	Level	Factor	Loss	Factor	Pos	Pos	Avg.	
1		( MHz )	( dB $\mu$ V/m )	( dB )	( dB $\mu$ V/m )	( dB $\mu$ V )	( dB/m )	( dB )	( dB )	( cm )	( deg )	( P/A )	( H/V )
802.11ac VHT40 CH 142 5710MHz		11420	44.19	-29.81	74	50.08	40.02	15.67	61.58	100	0	P	H
		17130	45.57	-22.63	68.2	41.85	40.18	19.55	56.01	100	0	P	H
													H
													H
		11420	44.4	-29.6	74	50.29	40.02	15.67	61.58	100	0	P	V
		17130	45.57	-22.63	68.2	41.85	40.18	19.55	56.01	100	0	P	V
													V
<b>Remark</b>	1. No other spurious found. 2. All results are PASS against Peak and Average limit line.												





**Band 3 - Straddle Channel  
WIFI 802.11ac VHT80 (Band Edge @ 3m)**

WIFI	Note	Frequency	Level	Over	Limit	Read	Antenna	Path	Preamp	Ant	Table	Peak	Pol.
Ant.				Limit	Line	Level	Factor	Loss	Factor	Pos	Pos	Avg.	
1		( MHz )	( dBμV/m )	( dB )	( dBμV/m )	(dBμV)	( dB/m )	( dB )	( dB )	( cm )	( deg )	(P/A)	(H/V)
802.11ac VHT80 CH 138 5690MHz	*	5690	95.78	-	-	86.71	32.44	9.75	33.12	100	241	P	H
	*	5690	87.62	-	-	78.55	32.44	9.75	33.12	100	241	A	H
													H
													H
													H
													H
	*	5690	94.38	-	-	85.31	32.44	9.75	33.12	390	161	P	V
	*	5690	86.28	-	-	77.21	32.44	9.75	33.12	390	161	A	V
													V
													V
<b>Remark</b>	1. No other spurious found. 2. All results are PASS against Peak and Average limit line.												



**Band 3 - Straddle Channel**  
**WIFI 802.11ac VHT80 (Harmonic @ 3m)**

WIFI	Note	Frequency	Level	Over	Limit	Read	Antenna	Path	Preamp	Ant	Table	Peak	Pol.
Ant.				Limit	Line	Level	Factor	Loss	Factor	Pos	Pos	Avg.	
1		( MHz )	( dBµV/m )	( dB )	( dBµV/m )	( dBµV )	( dB/m )	( dB )	( dB )	( cm )	( deg )	( P/A )	( H/V )
802.11ac VHT80 CH 138 5690MHz		11380	44.83	-29.17	74	50.74	40.02	15.65	61.58	100	0	P	H
		17070	46.25	-21.95	68.2	42.94	39.94	19.52	56.15	100	0	P	H
													H
													H
		11380	44.63	-29.37	74	50.54	40.02	15.65	61.58	100	0	P	V
		17070	45.45	-22.75	68.2	42.14	39.94	19.52	56.15	100	0	P	V
													V
<b>Remark</b>	1. No other spurious found. 2. All results are PASS against Peak and Average limit line.												



Emission below 1GHz  
WIFI 802.11a (LF @ 3m)

WIFI	Note	Frequency	Level	Over	Limit	Read	Antenna	Path	Preamp	Ant	Table	Peak	Pol.	
Ant.		( MHz )	( dBμV/m )	( dB )	( dBμV/m )	( dBμV )	( dB/m )	( dB )	( dB )	( cm )	( deg )	( P/A )	( H/V )	
802.11a LF		47.28	24.21	-15.79	40	40.33	15.44	0.93	32.49			P	H	
		142.05	32.12	-11.38	43.5	45.79	17.12	1.65	32.44	100	122	P	H	
		172.29	30.5	-13	43.5	45.88	15.23	1.81	32.42			P	H	
		460.3	25.19	-20.81	46	31.66	23.13	2.76	32.36			P	H	
		764.1	30	-16	46	30.72	27.88	3.68	32.28			P	H	
		958	33.32	-12.68	46	29.37	30.92	4.16	31.13			P	H	
													H	
													H	
													H	
													H	
													H	
													H	
			35.94	26.43	-13.57	40	36.82	21.29	0.81	32.49			P	V
			47.28	27.97	-12.03	40	44.09	15.44	0.93	32.49	100	305	P	V
			66.72	27.22	-12.78	40	46.86	11.74	1.11	32.49			P	V
			557.6	27.18	-18.82	46	30.61	25.88	3.12	32.43			P	V
			739.6	29.76	-16.24	46	30.84	27.66	3.61	32.35			P	V
			953.1	33.49	-12.51	46	29.81	30.71	4.14	31.17			P	V
												V		
												V		
												V		
												V		
												V		
												V		
Remark	1. No other spurious found. 2. All results are PASS against limit line.													



**Note symbol**

*	<b>Fundamental Frequency</b> which can be ignored. However, the level of any unwanted emissions shall not exceed the level of the fundamental frequency.
!	Test result is <b>over limit</b> line.
P/A	<b>Peak</b> or <b>Average</b>
H/V	<b>Horizontal</b> or <b>Vertical</b>



A calculation example for radiated spurious emission is shown as below:

WIFI Ant.	Note	Frequency	Level	Over Limit	Limit Line	Read Level	Antenna Factor	Path Loss	Preamp Factor	Ant Pos	Table Pos	Peak Avg.	Pol.
1		( MHz )	( dBμV/m )	( dB )	( dBμV/m )	( dBμV )	( dB/m )	( dB )	( dB )	( cm )	( deg )	( P/A )	( H/V )
802.11b CH 01		2390	55.45	-18.55	74	54.51	32.22	4.58	35.86	103	308	P	H
2412MHz		2390	43.54	-10.46	54	42.6	32.22	4.58	35.86	103	308	A	H

1. Path Loss(dB) = Cable loss(dB) + Filter loss(dB) + Attenuator loss(dB)
2. Level(dBμV/m) = Antenna Factor(dB/m) + Path Loss(dB) + Read Level(dBμV) - Preamp Factor(dB)
3. Over Limit(dB) = Level(dBμV/m) – Limit Line(dBμV/m)

**For Peak Limit @ 2390MHz:**

1. Level(dBμV/m)  
= Antenna Factor(dB/m) + Path Loss(dB) + Read Level(dBμV) - Preamp Factor(dB)  
= 32.22(dB/m) + 4.58(dB) + 54.51(dBμV) – 35.86 (dB)  
= 55.45 (dBμV/m)
2. Over Limit(dB)  
= Level(dBμV/m) – Limit Line(dBμV/m)  
= 55.45(dBμV/m) – 74(dBμV/m)  
= -18.55(dB)

**For Average Limit @ 2390MHz:**

1. Level(dBμV/m)  
= Antenna Factor(dB/m) + Path Loss(dB) + Read Level(dBμV) - Preamp Factor(dB)  
= 32.22(dB/m) + 4.58(dB) + 42.6(dBμV) – 35.86 (dB)  
= 43.54 (dBμV/m)
2. Over Limit(dB) = Level(dBμV/m) – Limit Line(dBμV/m)  
= 43.54(dBμV/m) – 54(dBμV/m)  
= -10.46(dB)

Both peak and average measured complies with the limit line, so test result is “PASS”.



### Appendix D. Radiated Spurious Emission

Test Engineer :	Hao Hsu, Ken Wu, Chuan Zhu, Bill Chang, and Wilson Wu	Temperature :	21~26°C
		Relative Humidity :	51~56%

#### Note symbol

-L	Low channel location
-R	High channel location



**Band 1 - 5150~5250MHz**  
**WIFI 802.11a (Band Edge @ 3m)**

WIFI	Band 1 5150~5250MHz Band Edge @ 3m	
ANT	802.11a CH36 5180MHz	
1	Horizontal	Fundamental
<b>Peak</b>	<p>Site : 03CHI1-HY Condition : PEAK_BE_74 3m HORN 91200-HF HORIZONTAL RBW:1000.000KHz VBW:3000.000KHz SWT:Auto Detector : Peak Project : 881329-01 Setting : 12</p>	<p>Site : 03CHI1-HY Condition : PEAK(LINE) 3m HORN 91200-HF HORIZONTAL RBW:1000.000KHz VBW:3000.000KHz SWT:Auto Detector : Peak Project : 881329-01 Setting : 12</p>
<b>Avg.</b>	<p>Site : 03CHI1-HY Condition : AVG_BE_54 3m HORN 91200-HF HORIZONTAL RBW:1000.000KHz VBW:1.000KHz SWT:Auto Detector : Peak Project : 881329-01 Setting : 12</p>	Left blank

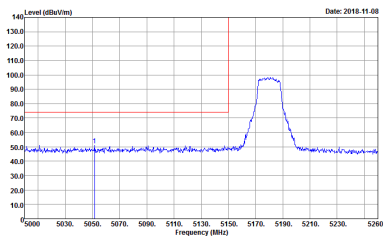
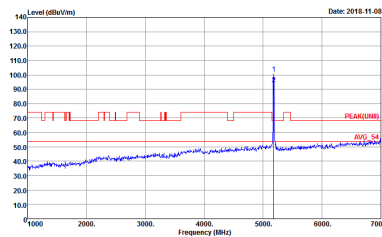
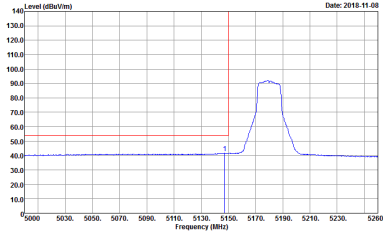

WIFI	Band 1 5150~5250MHz Band Edge @ 3m	
ANT	802.11a CH36 5180MHz	
1	Vertical	Fundamental
<p><b>Peak</b></p>	 <p>Site : 03CH11-HY            Condition : PEAK_BE_74 3m HORN 91200-HF VERTICAL            Detector : Peak            Project : 881329-01            Setting : 12</p>	 <p>Site : 03CH11-HY            Condition : PEAK(LINE) 3m HORN 91200-HF VERTICAL            Detector : Peak            Project : 881329-01            Setting : 12</p>
<p><b>Avg.</b></p>	 <p>Site : 03CH11-HY            Condition : AVG_BE_54 3m HORN 91200-HF VERTICAL            Detector : Peak            Project : 881329-01            Setting : 12</p>	<p>Left blank</p>



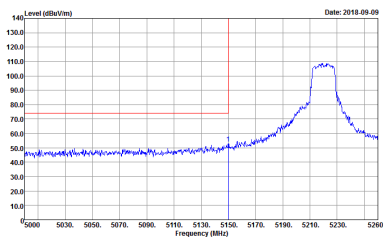
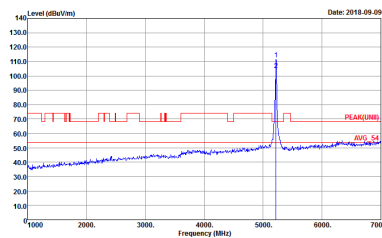
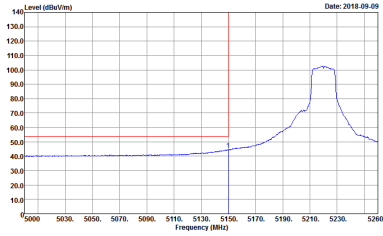

WIFI	Band 1 5150~5250MHz Band Edge @ 3m	
ANT	802.11a CH44 5220MHz - L	
1	Horizontal	Fundamental
Peak	 <p>Site : 03CH11-HY            Condition : PEAK_BE_74 3m HORN 9120D-HF HORIZONTAL            RBW:1000.000KHz VBW:3000.000KHz SWT:Auto            Detector : Peak            Project : 881329-01</p>	 <p>Site : 03CH11-HY            Condition : PEAK(LINE) 3m HORN 9120D-HF HORIZONTAL            RBW:1000.000KHz VBW:3000.000KHz SWT:Auto            Detector : Peak            Project : 881329-01</p>
Avg.	 <p>Site : 03CH11-HY            Condition : AVG_BE_54 3m HORN 9120D-HF HORIZONTAL            RBW:1000.000KHz VBW:1000KHz SWT:Auto            Detector : Peak            Project : 881329-01</p>	Left blank



WIFI	Band 1 5150~5250MHz Band Edge @ 3m	
ANT	802.11a CH44 5220MHz - R	
1	Horizontal	Fundamental
Peak	<p>Site : 03CH11-HY Condition : PEAK_BE_74 3m HORN 91200-HF HORIZONTAL Detector : Peak Project : 881329-01</p>	Left blank
Avg.	<p>Site : 03CH11-HY Condition : AVG_BE_54 3m HORN 91200-HF HORIZONTAL Detector : Peak Project : 881329-01</p>	Left blank

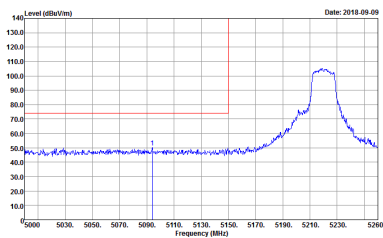
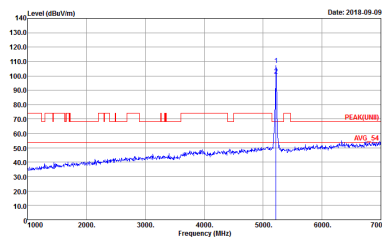
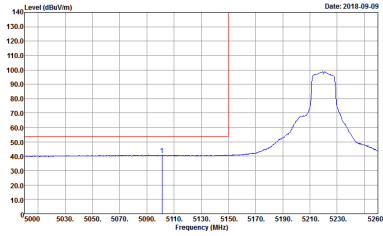

WIFI	Band 1 5150~5250MHz Band Edge @ 3m	
ANT	802.11a CH44 5220MHz - L	
1	Vertical	Fundamental
Peak	 <p>Site : 03CH11-HY            Condition : PEAK_BE_74 3m HORN 9120D-HF VERTICAL            Detector : Peak            Project : 881329-01</p>	 <p>Site : 03CH11-HY            Condition : PEAK(LINE) 3m HORN 9120D-HF VERTICAL            Detector : Peak            Project : 881329-01</p>
Avg.	 <p>Site : 03CH11-HY            Condition : AVG_BE_54 3m HORN 9120D-HF VERTICAL            Detector : Peak            Project : 881329-01</p>	Left blank



WIFI	Band 1 5150~5250MHz Band Edge @ 3m	
ANT	802.11a CH44 5220MHz - R	
1	Vertical	Fundamental
<b>Peak</b>	<p>Site : 03CH11-HY Condition : PEAK_BE_74 3m HORN 91200-HF VERTICAL RBW:1000.000kHz VBW:3000.000kHz SWF:Auto Detector : Peak Project : 881329-01</p>	Left blank
<b>Avg.</b>	<p>Site : 03CH11-HY Condition : AVG_BE_54 3m HORN 91200-HF VERTICAL RBW:1000.000kHz VBW:1000kHz SWF:Auto Detector : Peak Project : 881329-01</p>	Left blank

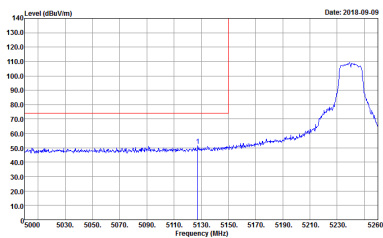
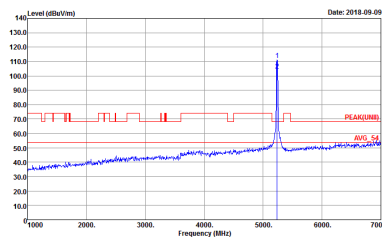
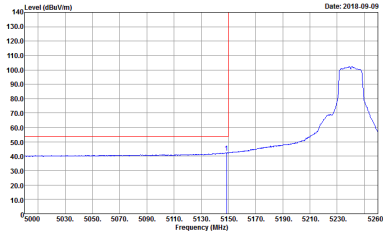

WIFI	Band 1 5150~5250MHz Band Edge @ 3m	
ANT	802.11a CH48 5240MHz - L	
1	Horizontal	Fundamental
Peak	 <p>Site : 03CH11-HY            Condition : PEAK_BE_74 3m HORN 91200-HF HORIZONTAL            RBW:1000.000kHz VBW:3000.000kHz SWT:Auto            Detector : Peak            Project : 881329-01</p>	 <p>Site : 03CH11-HY            Condition : PEAK(LINE) 3m HORN 91200-HF HORIZONTAL            RBW:1000.000kHz VBW:3000.000kHz SWT:Auto            Detector : Peak            Project : 881329-01</p>
Avg.	 <p>Site : 03CH11-HY            Condition : AVG_BE_54 3m HORN 91200-HF HORIZONTAL            RBW:1000.000kHz VBW:1000kHz SWT:Auto            Detector : Peak            Project : 881329-01</p>	Left blank

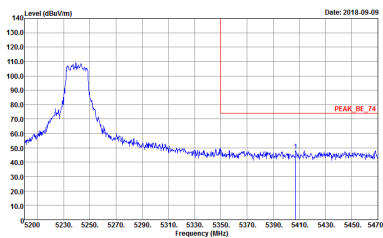
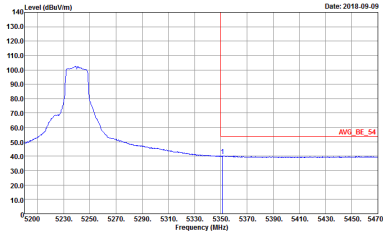

WIFI	Band 1 5150~5250MHz Band Edge @ 3m	
ANT	802.11a CH48 5240MHz - R	
1	Horizontal	Fundamental
<p><b>Peak</b></p>	 <p>Site : 03CH11-HY            Condition : PEAK_BE_74 3m HORN 91200-HF HORIZONTAL            Detector : Peak            Project : 881329-01</p>	<p>Left blank</p>
<p><b>Avg.</b></p>	 <p>Site : 03CH11-HY            Condition : AVG_BE_54 3m HORN 91200-HF HORIZONTAL            Detector : Peak            Project : 881329-01</p>	<p>Left blank</p>

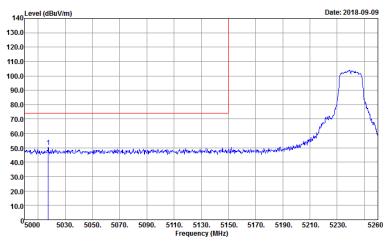
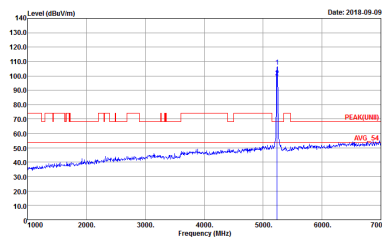
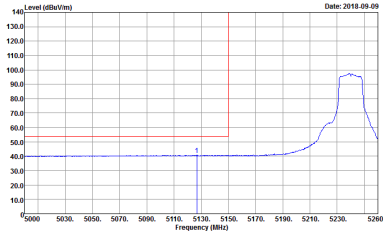

WIFI	Band 1 5150~5250MHz Band Edge @ 3m	
ANT	802.11a CH48 5240MHz - L	
1	Vertical	Fundamental
Peak	 <p>Site : 03CH11-HY            Condition : PEAK_BE_74 3m HORN 9120D-HF VERTICAL            Detector : Peak            Project : 881329-01</p>	 <p>Site : 03CH11-HY            Condition : PEAK(LINE) 3m HORN 9120D-HF VERTICAL            Detector : Peak            Project : 881329-01</p>
Avg.	 <p>Site : 03CH11-HY            Condition : AVG_BE_54 3m HORN 9120D-HF VERTICAL            Detector : Peak            Project : 881329-01</p>	Left blank



WIFI	Band 1 5150~5250MHz Band Edge @ 3m	
ANT	802.11a CH48 5240MHz - R	
1	Vertical	Fundamental
<p><b>Peak</b></p>		<p>Left blank</p>
<p><b>Avg.</b></p>		<p>Left blank</p>





**Band 1 5150~5250MHz  
WIFI 802.11n HT20 (Band Edge @ 3m)**

WIFI	Band 1 5150~5250MHz Band Edge @ 3m	
ANT	802.11n HT20 CH36 5180MHz	
1	Horizontal	Fundamental
<b>Peak</b>	<p>Site : 03CHI1-HY Condition : PEAK_BE_74 3m HORN 91200-HF HORIZONTAL Detector : Peak Project : 881329-01</p>	<p>Site : 03CHI1-HY Condition : PEAK(UNIT) 3m HORN 91200-HF HORIZONTAL Detector : Peak Project : 881329-01</p>
<b>Avg.</b>	<p>Site : 03CHI1-HY Condition : AVG_BE_54 3m HORN 91200-HF HORIZONTAL Detector : Peak Project : 881329-01</p>	Left blank

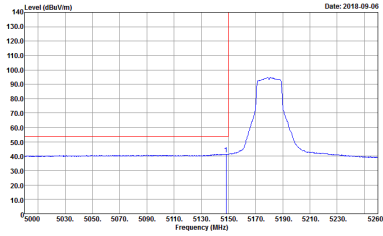

WIFI	Band 1 5150~5250MHz Band Edge @ 3m	
ANT	802.11n HT20 CH36 5180MHz	
1	Vertical	Fundamental
<p><b>Peak</b></p>	 <p>Site : 03CH11-HY            Condition : PEAK_BE_74 3m HORN 9120D-HF VERTICAL            Detector : Peak            Project : 881329-01</p>	 <p>Site : 03CH11-HY            Condition : PEAK(LINE) 3m HORN 9120D-HF VERTICAL            Detector : Peak            Project : 881329-01</p>
<p><b>Avg.</b></p>	 <p>Site : 03CH11-HY            Condition : AVG_BE_54 3m HORN 9120D-HF VERTICAL            Detector : Peak            Project : 881329-01</p>	<p>Left blank</p>

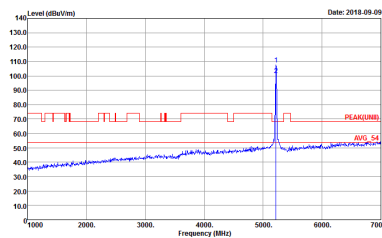
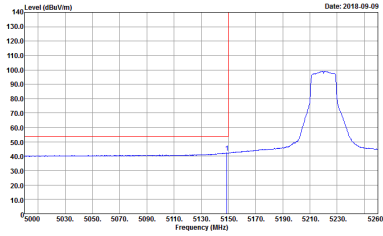

WIFI	Band 1 5150~5250MHz Band Edge @ 3m	
ANT	802.11n HT20 CH44 5220MHz - L	
1	Horizontal	Fundamental
Peak	 <p>Site : 03CH11-HY            Condition : PEAK_BE_74 3m HORN 9120D-HF HORIZONTAL            Detector : Peak            Project : 881329-01</p>	 <p>Site : 03CH11-HY            Condition : PEAK(LINE) 3m HORN 9120D-HF HORIZONTAL            Detector : Peak            Project : 881329-01</p>
Avg.	 <p>Site : 03CH11-HY            Condition : AVG_BE_54 3m HORN 9120D-HF HORIZONTAL            Detector : Peak            Project : 881329-01</p>	Left blank

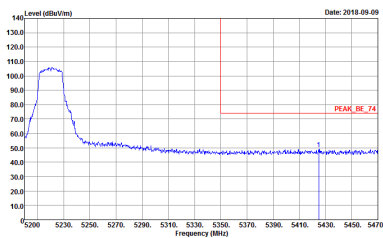
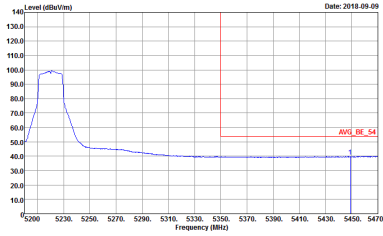

WIFI	Band 1 5150~5250MHz Band Edge @ 3m	
ANT	802.11n HT20 CH44 5220MHz - R	
1	Horizontal	Fundamental
<p><b>Peak</b></p>	 <p>Site : 03CH11-HY            Condition : PEAK_BE_74 3m HORN 91200-HF HORIZONTAL            Detector : Peak            Project : 881329-01</p>	<p>Left blank</p>
<p><b>Avg.</b></p>	 <p>Site : 03CH11-HY            Condition : AVG_BE_54 3m HORN 91200-HF HORIZONTAL            Detector : Peak            Project : 881329-01</p>	<p>Left blank</p>



WIFI	Band 1 5150~5250MHz Band Edge @ 3m	
ANT	802.11n HT20 CH44 5220MHz - L	
1	Vertical	Fundamental
Peak	<p>Site : 03CH11-HY            Condition : PEAK_BE_74 3m HORN 9120D-HF VERTICAL            RBW:1000.000KHz VBW:3000.000KHz SWT:Auto            Detector : Peak            Project : 881329-01</p>	<p>Site : 03CH11-HY            Condition : PEAK(LINB) 3m HORN 9120D-HF VERTICAL            RBW:1000.000KHz VBW:3000.000KHz SWT:Auto            Detector : Peak            Project : 881329-01</p>
Avg.	<p>Site : 03CH11-HY            Condition : AVG_BE_54 3m HORN 9120D-HF VERTICAL            RBW:1000.000KHz VBW:1000KHz SWT:Auto            Detector : Peak            Project : 881329-01</p>	Left blank



WIFI	Band 1 5150~5250MHz Band Edge @ 3m	
ANT	802.11n HT20 CH44 5220MHz - R	
1	Vertical	Fundamental
<b>Peak</b>	<p>Site : 03CH11-HY Condition : PEAK_BE_74 3m HORN 91200-HF VERTICAL RBW:1000.000kHz VBW:3000.000kHz SWF:Auto Detector : Peak Project : 881329-01</p>	Left blank
<b>Avg.</b>	<p>Site : 03CH11-HY Condition : AVG_BE_54 3m HORN 91200-HF VERTICAL RBW:1000.000kHz VBW:1000kHz SWF:Auto Detector : Peak Project : 881329-01</p>	Left blank



WIFI	Band 1 5150~5250MHz Band Edge @ 3m	
ANT	802.11n HT20 CH48 5240MHz - L	
1	Horizontal	Fundamental
Peak	 <p>Site : 03CH11-HY            Condition : PEAK_BE_74 3m HORN 9120D-HF HORIZONTAL            RBW:1000.000KHz VBW:3000.000KHz SWT:Auto            Detector : Peak            Project : 881329-01</p>	 <p>Site : 03CH11-HY            Condition : PEAK(LINE) 3m HORN 9120D-HF HORIZONTAL            RBW:1000.000KHz VBW:3000.000KHz SWT:Auto            Detector : Peak            Project : 881329-01</p>
Avg.	 <p>Site : 03CH11-HY            Condition : AVG_BE_54 3m HORN 9120D-HF HORIZONTAL            RBW:1000.000KHz VBW:1000KHz SWT:Auto            Detector : Peak            Project : 881329-01</p>	Left blank



WIFI	Band 1 5150~5250MHz Band Edge @ 3m	
ANT	802.11n HT20 CH48 5240MHz - R	
1	Horizontal	Fundamental
<b>Peak</b>	<p>Site : 03CH11-HY Condition : PEAK_BE_74 3m HORN 91200-HF HORIZONTAL RBW:1000.000kHz VBW:3000.000kHz SWT:Auto Detector : Peak Project : 881329-01</p>	Left blank
<b>Avg.</b>	<p>Site : 03CH11-HY Condition : AVG_BE_54 3m HORN 91200-HF HORIZONTAL RBW:1000.000kHz VBW:1000kHz SWT:Auto Detector : Peak Project : 881329-01</p>	Left blank





WIFI	Band 1 5150~5250MHz Band Edge @ 3m	
ANT	802.11n HT20 CH48 5240MHz - L	
1	Vertical	Fundamental
<p><b>Peak</b></p>	<p>Site : 03CH11-HY            Condition : PEAK_BE_74 3m HORN 9120D-HF VERTICAL            Detector : Peak            Project : 881329-01</p>	<p>Site : 03CH11-HY            Condition : PEAK(LINB) 3m HORN 9120D-HF VERTICAL            Detector : Peak            Project : 881329-01</p>
<p><b>Avg.</b></p>	<p>Site : 03CH11-HY            Condition : AVG_BE_54 3m HORN 9120D-HF VERTICAL            Detector : Peak            Project : 881329-01</p>	<p>Left blank</p>



WIFI	Band 1 5150~5250MHz Band Edge @ 3m	
ANT	802.11n HT20 CH48 5240MHz - R	
1	Vertical	Fundamental
<b>Peak</b>	<p>Site : 03CH11-HY Condition : PEAK_BE_74 3m HORN 91200-HF VERTICAL RBW:1000.000kHz VBW:3000.000kHz SWF:Auto Detector : Peak Project : 881329-01</p>	Left blank
<b>Avg.</b>	<p>Site : 03CH11-HY Condition : AVG_BE_54 3m HORN 91200-HF VERTICAL RBW:1000.000kHz VBW:1000kHz SWF:Auto Detector : Peak Project : 881329-01</p>	Left blank



**Band 1 5150~5250MHz  
WIFI 802.11ac VHT40 (Band Edge @ 3m)**

WIFI	Band 1 5150~5250MHz Band Edge @ 3m	
ANT	802.11ac VHT40 CH38 5190MHz - L	
1	Horizontal	Fundamental
<b>Peak</b>	<p>Site : 03CHI1-HY Condition : PEAK_BE_74 3m HORN 91200-HF HORIZONTAL Detector : Peak Project : 881329-01 Setting : 6.5</p>	<p>Site : 03CHI1-HY Condition : PEAK(UNIT) 3m HORN 91200-HF HORIZONTAL Detector : Peak Project : 881329-01 Setting : 6.5</p>
<b>Avg.</b>	<p>Site : 03CHI1-HY Condition : AVG_BE_54 3m HORN 91200-HF HORIZONTAL Detector : Peak Project : 881329-01 Setting : 6.5</p>	Left blank

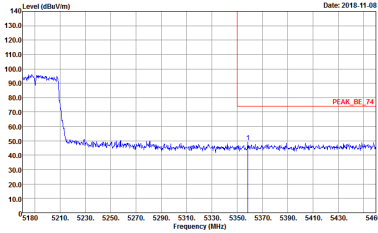
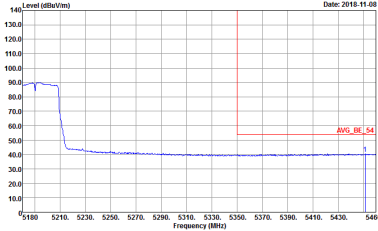

WIFI	Band 1 5150~5250MHz Band Edge @ 3m	
ANT	802.11ac VHT40 CH38 5190MHz - R	
1	Horizontal	Fundamental
<p><b>Peak</b></p>	 <p>Site : 03CH11-HY            Condition : PEAK_BE_74 3m HORN 91200-HF HORIZONTAL            Detector : Peak            Project : 881329-01            Setting : 6.5</p>	<p>Left blank</p>
<p><b>Avg.</b></p>	 <p>Site : 03CH11-HY            Condition : AVG_BE_54 3m HORN 91200-HF HORIZONTAL            Detector : Peak            Project : 881329-01            Setting : 6.5</p>	<p>Left blank</p>

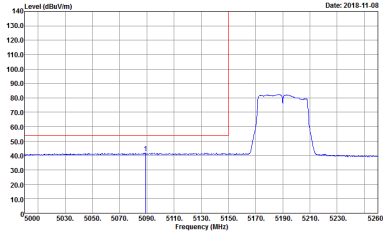

WIFI	Band 1 5150~5250MHz Band Edge @ 3m	
ANT	802.11ac VHT40 CH38 5190MHz - L	
1	Vertical	Fundamental
Peak	 <p>Site : 03CH11-HY            Condition : PEAK_BE_74 3m HORN 91200-HF VERTICAL            Detector : Peak            Project : 881329-01            Setting : 6.5</p>	 <p>Site : 03CH11-HY            Condition : PEAK(LINE) 3m HORN 91200-HF VERTICAL            Detector : Peak            Project : 881329-01            Setting : 6.5</p>
Avg.	 <p>Site : 03CH11-HY            Condition : AVG_BE_54 3m HORN 91200-HF VERTICAL            Detector : Peak            Project : 881329-01            Setting : 6.5</p>	Left blank

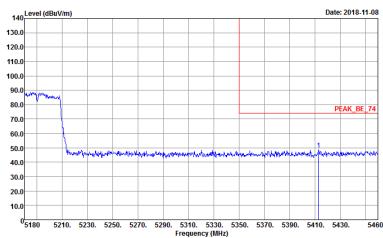
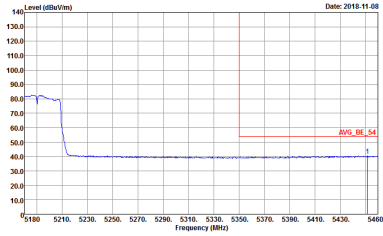

WIFI	Band 1 5150~5250MHz Band Edge @ 3m	
ANT	802.11ac VHT40 CH38 5190MHz - R	
1	Vertical	Fundamental
<p><b>Peak</b></p>	 <p>Site : 03CH11-HY            Condition : PEAK_BE_74 3m HORN 91200-HF VERTICAL            Detector : Peak            Project : 881329-01            Setting : 6.5</p>	<p>Left blank</p>
<p><b>Avg.</b></p>	 <p>Site : 03CH11-HY            Condition : AVG_BE_54 3m HORN 91200-HF VERTICAL            Detector : Peak            Project : 881329-01            Setting : 6.5</p>	<p>Left blank</p>



WIFI	Band 1 5150~5250MHz Band Edge @ 3m	
ANT	802.11ac VHT40 CH46 5230MHz - L	
1	Horizontal	Fundamental
Peak	 <p>Site : 03CH11-HY            Condition : PEAK_BE_74 3m HORN 91200-HF HORIZONTAL            RBW:1000.000KHz VBW:3000.000KHz SWT:Auto            Detector : Peak            Project : 881329-01</p>	 <p>Site : 03CH11-HY            Condition : PEAK(LINE) 3m HORN 91200-HF HORIZONTAL            RBW:1000.000KHz VBW:3000.000KHz SWT:Auto            Detector : Peak            Project : 881329-01</p>
Avg.	 <p>Site : 03CH11-HY            Condition : AVG_BE_54 3m HORN 91200-HF HORIZONTAL            RBW:1000.000KHz VBW:3.000KHz SWT:Auto            Detector : Peak            Project : 881329-01</p>	Left blank

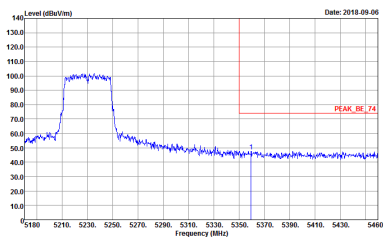
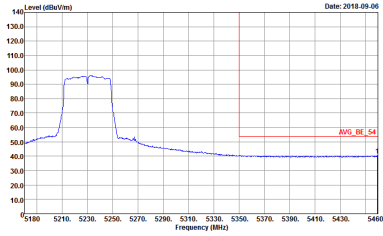

WIFI	Band 1 5150~5250MHz Band Edge @ 3m	
ANT	802.11ac VHT40 CH46 5230MHz - R	
1	Horizontal	Fundamental
<p><b>Peak</b></p>	 <p>Site : 03CH11-HY            Condition : PEAK_BE_74 3m HORN 91200-HF HORIZONTAL            Detector : Peak            Project : 881329-01</p>	<p>Left blank</p>
<p><b>Avg.</b></p>	 <p>Site : 03CH11-HY            Condition : AVG_BE_54 3m HORN 91200-HF HORIZONTAL            Detector : Peak            Project : 881329-01</p>	<p>Left blank</p>



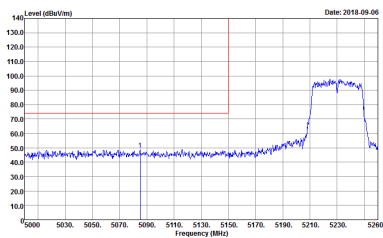
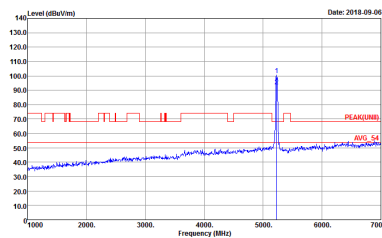

WIFI	Band 1 5150~5250MHz Band Edge @ 3m	
ANT	802.11ac VHT40 CH46 5230MHz - L	
1	Vertical	Fundamental
<p><b>Peak</b></p>	 <p>Site : 03CH11-HY            Condition : PEAK_BE_74 3m HORN 9120D-HF VERTICAL            Detector : Peak            Project : 881329-01</p>	 <p>Site : 03CH11-HY            Condition : PEAK(LINE) 3m HORN 9120D-HF VERTICAL            Detector : Peak            Project : 881329-01</p>
<p><b>Avg.</b></p>	 <p>Site : 03CH11-HY            Condition : AVG_BE_54 3m HORN 9120D-HF VERTICAL            Detector : Peak            Project : 881329-01</p>	<p>Left blank</p>

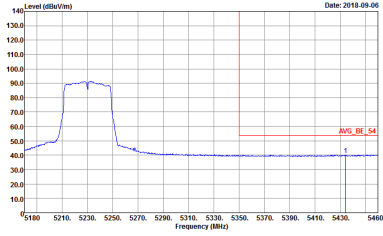

WIFI	Band 1 5150~5250MHz Band Edge @ 3m	
ANT	802.11ac VHT40 CH46 5230MHz - R	
1	Vertical	Fundamental
<p><b>Peak</b></p>	 <p>Site : 03CHI1-HY            Condition : PEAK_BE_74 3m HORN 91200-HF VERTICAL            Detector : Peak            Project : 881329-01</p>	<p>Left blank</p>
<p><b>Avg.</b></p>	 <p>Site : 03CHI1-HY            Condition : AVG_BE_54 3m HORN 91200-HF VERTICAL            Detector : Peak            Project : 881329-01</p>	<p>Left blank</p>

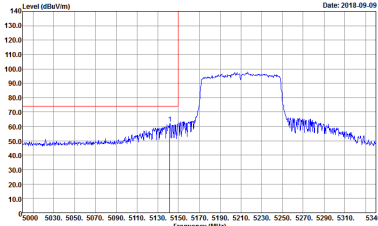
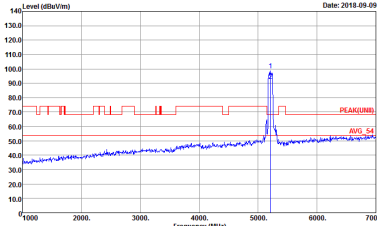
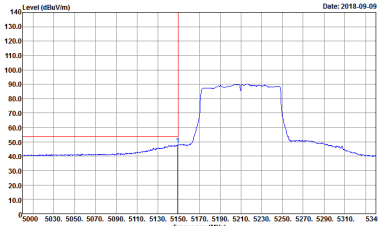

**Band 1 5150~5250MHz**  
**WIFI 802.11ac VHT80 (Band Edge @ 3m)**

WIFI ANT	Band 1 5150~5250MHz Band Edge @ 3m 802.11ac VHT80 CH42 5210MHz - L	
1	Horizontal	Fundamental
Peak	 <p>Site : 03CHI1-HY            Condition : PEAK_BE_74 3m HORN 91200-HF HORIZONTAL            Detector : Peak            Project : 881329-01</p>	 <p>Site : 03CHI1-HY            Condition : PEAK(UNIT) 3m HORN 91200-HF HORIZONTAL            Detector : Peak            Project : 881329-01</p>
Avg.	 <p>Site : 03CHI1-HY            Condition : AVG_BE_54 3m HORN 91200-HF HORIZONTAL            Detector : Peak            Project : 881329-01</p>	Left blank

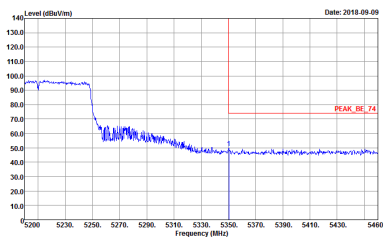
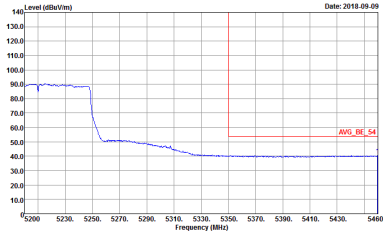

WIFI	Band 1 5150~5250MHz Band Edge @ 3m	
ANT	802.11ac VHT80 CH42 5210MHz - R	
1	Horizontal	Fundamental
<p><b>Peak</b></p>	 <p>Site : 03CH11-HY            Condition : PEAK_BE_74 3m HORN 91200-HF HORIZONTAL            Detector : Peak            Project : 881329-01</p>	<p>Left blank</p>
<p><b>Avg.</b></p>	 <p>Site : 03CH11-HY            Condition : AVG_BE_54 3m HORN 91200-HF HORIZONTAL            Detector : Peak            Project : 881329-01</p>	<p>Left blank</p>

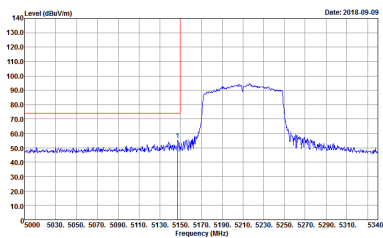
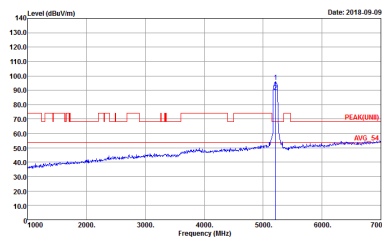
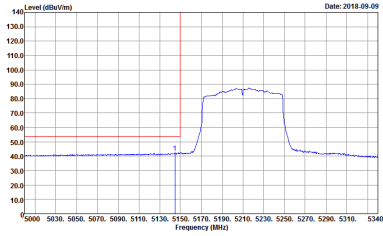

WIFI	Band 1 5150~5250MHz Band Edge @ 3m	
ANT	802.11ac VHT80 CH42 5210MHz - L	
1	Vertical	Fundamental
Peak	 <p>Site : 03CH11-HY            Condition : PEAK_BE_74 3m HORN 9120D-HF VERTICAL            RBW:1000.000KHz VBW:3000.000KHz SWT:Auto            Detector : Peak            Project : 881329-01</p>	 <p>Site : 03CH11-HY            Condition : PEAK(LINE) 3m HORN 9120D-HF VERTICAL            RBW:1000.000KHz VBW:3000.000KHz SWT:Auto            Detector : Peak            Project : 881329-01</p>
Avg.	 <p>Site : 03CH11-HY            Condition : AVG_BE_54 3m HORN 9120D-HF VERTICAL            RBW:1000.000KHz VBW:3.000KHz SWT:Auto            Detector : Peak            Project : 881329-01</p>	Left blank



WIFI	Band 1 5150~5250MHz Band Edge @ 3m	
ANT	802.11ac VHT80 CH42 5210MHz - R	
1	Vertical	Fundamental
<p><b>Peak</b></p>	 <p>Site : 03CH11-HY            Condition : PEAK_BE_74 3m HORN 91200-HF VERTICAL            Detector : Peak            Project : 881329-01</p>	<p>Left blank</p>
<p><b>Avg.</b></p>	 <p>Site : 03CH11-HY            Condition : AVG_BE_54 3m HORN 91200-HF VERTICAL            Detector : Peak            Project : 881329-01</p>	<p>Left blank</p>



**Band 1 - 5150~5250MHz**  
**WIFI 802.11a (Harmonic @ 3m)**

<b>WIFI</b>	<b>Band 1 5150~5250MHz Harmonic @ 3m</b>	
<b>ANT</b>	<b>802.11a CH36 5180MHz</b>	
<b>1</b>	<b>Horizontal</b>	<b>Vertical</b>
<b>Peak</b> <b>Avg.</b>	<p>Site : 03CH11-HY          Condition : PEAK(LINE1) 3m HORN 9120D-HF HORIZONTAL          Detector : Peak          Project : 881329-01          Setting : 12</p>	<p>Site : 03CH11-HY          Condition : PEAK(LINE1) 3m HORN 9120D-HF VERTICAL          Detector : Peak          Project : 881329-01          Setting : 12</p>



WIFI	Band 1 5150~5250MHz Harmonic @ 3m	
ANT	802.11a CH44 5220MHz	
1	Horizontal	Vertical
<b>Peak</b> <b>Avg.</b>	<p>Horizontal spectrum plot showing Level (dBm/Vm) vs Frequency (MHz). The plot displays a noisy baseline around 70 dBm/Vm. Two distinct peaks are visible at approximately 12000 MHz and 16000 MHz. The plot includes a red line for the average level (AVG. 54) and a red box for the peak level (PEAK(UNEE)).</p> <p>Site : 03CH11-14Y Condition : PEAK(UNEE) 3m HORN 9120D-HF HORIZONTAL Detector : Peak Project : 881329-01</p>	<p>Vertical spectrum plot showing Level (dBm/Vm) vs Frequency (MHz). The plot displays a noisy baseline around 70 dBm/Vm. Two distinct peaks are visible at approximately 12000 MHz and 16000 MHz. The plot includes a red line for the average level (AVG. 54) and a red box for the peak level (PEAK(UNEE)).</p> <p>Site : 03CH11-14Y Condition : PEAK(UNEE) 3m HORN 9120D-HF VERTICAL Detector : Peak Project : 881329-01</p>



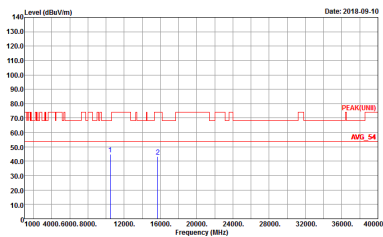
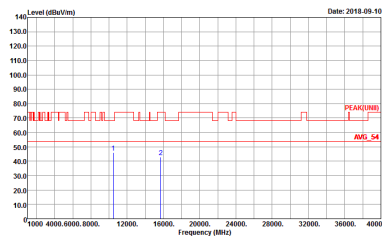

WIFI	Band 1 5150~5250MHz Harmonic @ 3m	
ANT	802.11a CH48 5240MHz	
1	Horizontal	Vertical
<p>Peak</p> <p>Avg.</p>	 <p>Site : 03CH11-14Y          Condition : PEAK(UNEE) 3m HORN 9120D-HF HORIZONTAL          Detector : Peak          Project : 881329-01</p>	 <p>Site : 03CH11-14Y          Condition : PEAK(UNEE) 3m HORN 9120D-HF VERTICAL          Detector : Peak          Project : 881329-01</p>



Band 1 5150~5250MHz
WIFI 802.11n HT20 (Harmonic @ 3m)

Table with 3 columns: WIFI, ANT, and test results for Horizontal and Vertical orientations. Includes two graphs showing Level (dBm/1m) vs Frequency (MHz) and associated metadata like Site, Condition, and Project.



WIFI	Band 1 5150~5250MHz Harmonic @ 3m	
ANT	802.11n HT20 CH44 5220MHz	
1	Horizontal	Vertical
<b>Peak</b> <b>Avg.</b>	<p>Horizontal spectrum plot showing Level (dBm/Vm) vs Frequency (MHz). The plot displays a noisy baseline around 70 dBm/Vm. Two distinct peaks are marked with blue vertical lines and labeled '1' and '2'. Peak 1 is at approximately 11.5 MHz and Peak 2 is at approximately 13.5 MHz. A red horizontal line indicates the average level (AVG. 54). The plot includes a 'PEAK(LINE)' label and a date of 2018-09-10. Metadata below the plot: Site: 03CH11-14Y, Condition: PEAK(LINE) 3m HORN 9120D-HF HORIZONTAL, Detector: Peak, Project: 881329-01.</p>	<p>Vertical spectrum plot showing Level (dBm/Vm) vs Frequency (MHz). The plot displays a noisy baseline around 70 dBm/Vm. Two distinct peaks are marked with blue vertical lines and labeled '1' and '2'. Peak 1 is at approximately 11.5 MHz and Peak 2 is at approximately 13.5 MHz. A red horizontal line indicates the average level (AVG. 54). The plot includes a 'PEAK(LINE)' label and a date of 2018-09-10. Metadata below the plot: Site: 03CH11-14Y, Condition: PEAK(LINE) 3m HORN 9120D-HF VERTICAL, Detector: Peak, Project: 881329-01.</p>



WIFI	Band 1 5150~5250MHz Harmonic @ 3m	
ANT	802.11n HT20 CH48 5240MHz	
1	Horizontal	Vertical
<b>Peak</b> <b>Avg.</b>	<p>Horizontal spectrum plot showing Level (dBm/Vm) vs Frequency (MHz). The plot displays a noisy baseline around 70 dBm/Vm. Two distinct peaks are visible at approximately 12000 MHz and 16000 MHz. A red horizontal line indicates the average level (AVG. 54). The plot includes a 'PEAK(LINEI)' label and a date of 2018-09-10. Metadata below the plot: Site: 03CH11-14Y, Condition: PEAK(LINEI) 3m HORN 9120D-HF HORIZONTAL, Detector: Peak, Project: 881329-01.</p>	<p>Vertical spectrum plot showing Level (dBm/Vm) vs Frequency (MHz). The plot displays a noisy baseline around 70 dBm/Vm. Two distinct peaks are visible at approximately 12000 MHz and 16000 MHz. A red horizontal line indicates the average level (AVG. 54). The plot includes a 'PEAK(LINEI)' label and a date of 2018-09-10. Metadata below the plot: Site: 03CH11-14Y, Condition: PEAK(LINEI) 3m HORN 9120D-HF VERTICAL, Detector: Peak, Project: 881329-01.</p>



Band 1 5150~5250MHz
WIFI 802.11ac VHT40 (Harmonic @ 3m)

Table with 2 columns: Horizontal and Vertical. Each column contains a spectral plot showing Level (dBm/m) vs Frequency (MHz) with peak and average markers. Includes site and condition details for both orientations.



WIFI	Band 1 5150~5250MHz Harmonic @ 3m	
ANT	802.11ac VHT40 CH46 5230MHz	
1	Horizontal	Vertical
<p>Peak</p> <p>Avg.</p>		

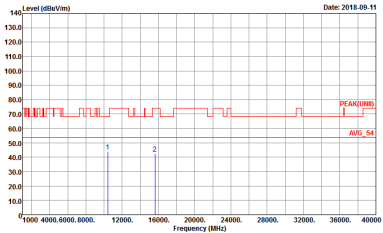
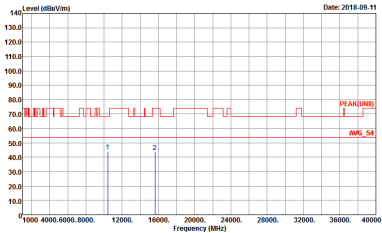

**Band 1 5150~5250MHz  
WIFI 802.11ac VHT80 (Harmonic @ 3m)**

WIFI	Band 1 5150~5250MHz Harmonic @ 3m	
ANT	802.11ac VHT80 CH42 5210MHz	
1	Horizontal	Vertical
<p><b>Peak</b></p> <p><b>Avg.</b></p>	 <p>Site : 03CHI1-HY Condition : PEAK(UNII) 3m HORN 9120D-HF HORIZONTAL Detector : Peak Project : 881329-01</p>	 <p>Site : 03CHI1-HY Condition : PEAK(UNII) 3m HORN 9120D-HF VERTICAL Detector : Peak Project : 881329-01</p>



**Band 2 - 5250~5350MHz**  
**WIFI 802.11a (Band Edge @ 3m)**

WIFI	Band 2 5250~5350MHz Band Edge @ 3m	
ANT	802.11a CH52 5260MHz - L	
<b>1</b>	<b>Horizontal</b>	<b>Fundamental</b>
<b>Peak</b>	<p>Site : 03CH11-HY            Condition : PEAK_BE_74 3m HORN 91200-HF HORIZONTAL            RBW:1000.000KHz VBW:3000.000KHz SWT:Auto            Detector : Peak            Project : 881329-01</p>	<p>Site : 03CH11-HY            Condition : PEAK(LINE) 3m HORN 91200-HF HORIZONTAL            RBW:1000.000KHz VBW:3000.000KHz SWT:Auto            Detector : Peak            Project : 881329-01</p>
<b>Avg.</b>	<p>Site : 03CH11-HY            Condition : AVG_BE_54 3m HORN 91200-HF HORIZONTAL            RBW:1000.000KHz VBW:1.000KHz SWT:Auto            Detector : Peak            Project : 881329-01</p>	<b>Left blank</b>





WIFI	Band 2 5250~5350MHz Band Edge @ 3m	
ANT	802.11a CH52 5260MHz - R	
1	Horizontal	Fundamental
<b>Peak</b>	<p>Site : 03CH11-HY Condition : PEAK_BE_74 3m HORN 91200-HF HORIZONTAL Detector : Peak Project : 881329-01</p>	Left blank
<b>Avg.</b>	<p>Site : 03CH11-HY Condition : AVG_BE_54 3m HORN 91200-HF HORIZONTAL Detector : Peak Project : 881329-01</p>	Left blank

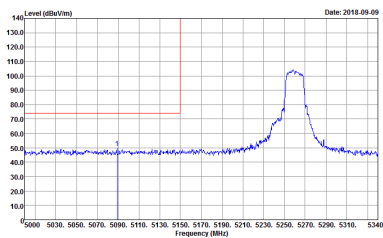
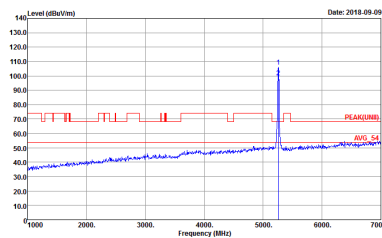
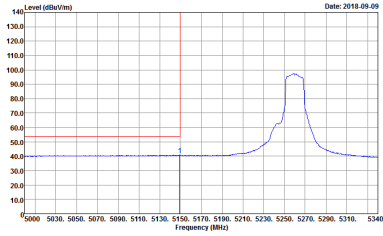

WIFI	Band 2 5250~5350MHz Band Edge @ 3m	
ANT	802.11a CH52 5260MHz - L	
1	Vertical	Fundamental
Peak	 <p>Site : 03CH11-HY            Condition : PEAK_BE_74 3m HORN 91200-HF VERTICAL            : RBW:1000.000KHz VBW:3000.000KHz SWT:Auto            Detector : Peak            Project : 881329-01</p>	 <p>Site : 03CH11-HY            Condition : PEAK(LINB) 3m HORN 91200-HF VERTICAL            : RBW:1000.000KHz VBW:3000.000KHz SWT:Auto            Detector : Peak            Project : 881329-01</p>
Avg.	 <p>Site : 03CH11-HY            Condition : AVG_BE_54 3m HORN 91200-HF VERTICAL            : RBW:1000.000KHz VBW:1.000KHz SWT:Auto            Detector : Peak            Project : 881329-01</p>	Left blank



WIFI	Band 2 5250~5350MHz Band Edge @ 3m	
ANT	802.11a CH52 5260MHz - R	
1	Vertical	Fundamental
<p><b>Peak</b></p>	 <p>Site : 03CH11-HY            Condition : PEAK_BE_74 3m HORN 91200-HF VERTICAL            Detector : Peak            Project : 881329-01</p>	<p>Left blank</p>
<p><b>Avg.</b></p>	 <p>Site : 03CH11-HY            Condition : AVG_BE_54 3m HORN 91200-HF VERTICAL            Detector : Peak            Project : 881329-01</p>	<p>Left blank</p>

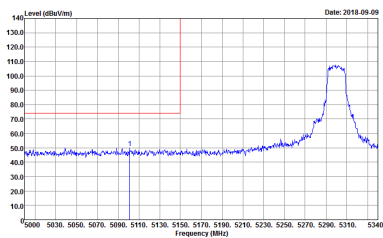
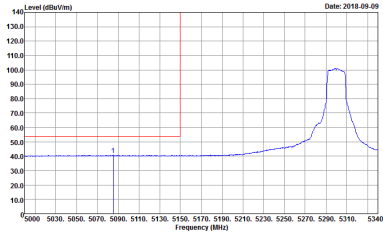

WIFI	Band 2 5250~5350MHz Band Edge @ 3m	
ANT	802.11a CH60 5300MHz - L	
1	Horizontal	Fundamental
Peak	 <p>Site : 03CH11-HY            Condition : PEAK_BE_74 3m HORN 9120D-HF HORIZONTAL            Detector : Peak            Project : 881329-01</p>	 <p>Site : 03CH11-HY            Condition : PEAK(LINE) 3m HORN 9120D-HF HORIZONTAL            Detector : Peak            Project : 881329-01</p>
Avg.	 <p>Site : 03CH11-HY            Condition : AVG_BE_54 3m HORN 9120D-HF HORIZONTAL            Detector : Peak            Project : 881329-01</p>	Left blank



WIFI	Band 2 5250~5350MHz Band Edge @ 3m	
ANT	802.11a CH60 5300MHz - R	
1	Horizontal	Fundamental
Peak	<p>Site : 03CH11-HY Condition : PEAK_BE_74 3m HORN 91200-HF HORIZONTAL RBW:1000.000kHz VBW:3000.000kHz SWT:Auto Detector : Peak Project : 881329-01</p>	Left blank
Avg.	<p>Site : 03CH11-HY Condition : AVG_BE_54 3m HORN 91200-HF HORIZONTAL RBW:1000.000kHz VBW:1000kHz SWT:Auto Detector : Peak Project : 881329-01</p>	Left blank



WIFI	Band 2 5250~5350MHz Band Edge @ 3m	
ANT	802.11a CH60 5300MHz - L	
1	Vertical	Fundamental
Peak	<p>Site : 03CH11-HY            Condition : PEAK_BE_74 3m HORN 9120D-HF VERTICAL            Detector : Peak            Project : 881329-01</p>	<p>Site : 03CH11-HY            Condition : PEAK(LINB) 3m HORN 9120D-HF VERTICAL            Detector : Peak            Project : 881329-01</p>
Avg.	<p>Site : 03CH11-HY            Condition : AVG_BE_54 3m HORN 9120D-HF VERTICAL            Detector : Peak            Project : 881329-01</p>	Left blank

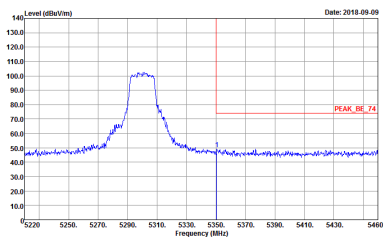
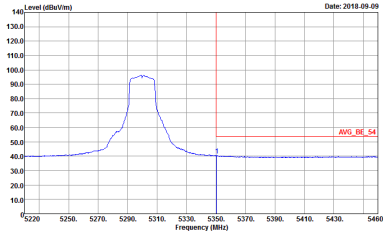

WIFI	Band 2 5250~5350MHz Band Edge @ 3m	
ANT	802.11a CH60 5300MHz - R	
1	Vertical	Fundamental
<p><b>Peak</b></p>	 <p>Site : 03CH11-HY            Condition : PEAK_BE_74 3m HORN 91200-HF VERTICAL            Detector : Peak            Project : 881329-01</p>	<p>Left blank</p>
<p><b>Avg.</b></p>	 <p>Site : 03CH11-HY            Condition : AVG_BE_54 3m HORN 91200-HF VERTICAL            Detector : Peak            Project : 881329-01</p>	<p>Left blank</p>

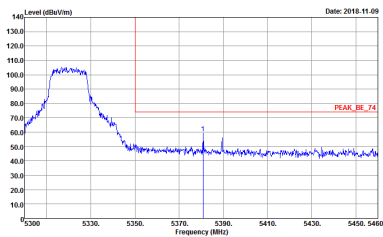
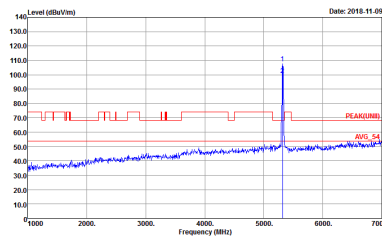
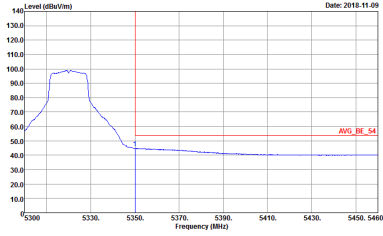

WIFI	Band 2 5250~5350MHz Band Edge @ 3m	
ANT	802.11a CH64 5320MHz	
1	Horizontal	Fundamental
<p><b>Peak</b></p>	 <p>Site : 03CH11-HY            Condition : PEAK_BE_74 3m HORN 91200-HF HORIZONTAL            Detector : Peak            Project : 881329-01            Setting : 11</p>	 <p>Site : 03CH11-HY            Condition : PEAKUNII 3m HORN 91200-HF HORIZONTAL            Detector : Peak            Project : 881329-01            Setting : 11</p>
<p><b>Avg.</b></p>	 <p>Site : 03CH11-HY            Condition : AVG_BE_54 3m HORN 91200-HF HORIZONTAL            Detector : Peak            Project : 881329-01            Setting : 11</p>	<p>Left blank</p>



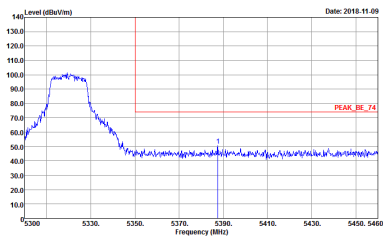
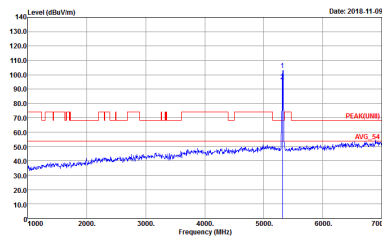
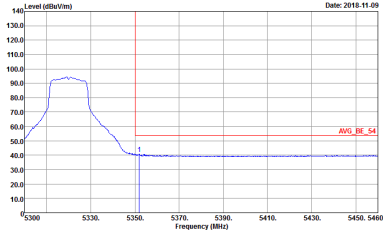

WIFI	Band 2 5250~5350MHz Band Edge @ 3m	
ANT	802.11a CH64 5320MHz	
1	Vertical	Fundamental
Peak	 <p>Site : 03CH11-HY            Condition : PEAK_BE_74 3m HORN 9120D-HF VERTICAL            : RBW:1000.000KHz VBW:3000.000KHz SWT:Auto            Detector : Peak            Project : 881329-01            Setting : 11</p>	 <p>Site : 03CH11-HY            Condition : PEAKUMB 3m HORN 9120D-HF VERTICAL            : RBW:1000.000KHz VBW:3000.000KHz SWT:Auto            Detector : Peak            Project : 881329-01            Setting : 11</p>
Avg.	 <p>Site : 03CH11-HY            Condition : AVG_BE_54 3m HORN 9120D-HF VERTICAL            : RBW:1000.000KHz VBW:1000KHz SWT:Auto            Detector : Peak            Project : 881329-01            Setting : 11</p>	Left blank



**Band 2 5250~5350MHz  
WIFI 802.11n HT20 (Band Edge @ 3m)**

WIFI	Band 2 5250~5350MHz Band Edge @ 3m	
ANT	802.11n HT20 CH52 5260MHz - L	
1	Horizontal	Fundamental
<b>Peak</b>	<p>Site : 03CHI1-HY Condition : PEAK_BE_74 3m HORN 91200-HF HORIZONTAL Detector : Peak Project : 881329-01</p>	<p>Site : 03CHI1-HY Condition : PEAK(UNIT) 3m HORN 91200-HF HORIZONTAL Detector : Peak Project : 881329-01</p>
<b>Avg.</b>	<p>Site : 03CHI1-HY Condition : AVG_BE_54 3m HORN 91200-HF HORIZONTAL Detector : Peak Project : 881329-01</p>	Left blank

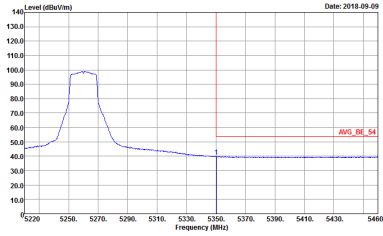

WIFI	Band 2 5250~5350MHz Band Edge @ 3m	
ANT	802.11n HT20 CH52 5260MHz - R	
1	Horizontal	Fundamental
<p><b>Peak</b></p>	 <p>Site : 03CH11-HY            Condition : PEAK_BE_74 3m HORN 91200-HF HORIZONTAL            Detector : Peak            Project : 881329-01</p>	<p>Left blank</p>
<p><b>Avg.</b></p>	 <p>Site : 03CH11-HY            Condition : AVG_BE_54 3m HORN 91200-HF HORIZONTAL            Detector : Peak            Project : 881329-01</p>	<p>Left blank</p>



WIFI	Band 2 5250~5350MHz Band Edge @ 3m	
ANT	802.11n HT20 CH52 5260MHz - L	
1	Vertical	Fundamental
Peak	 <p>Site : 03CH11-HY            Condition : PEAK_BE_74 3m HORN 9120D-HF VERTICAL            : RBW:1000.000KHz VBW:3000.000KHz SWT:Auto            Detector : Peak            Project : 881329-01</p>	 <p>Site : 03CH11-HY            Condition : PEAK(LINE) 3m HORN 9120D-HF VERTICAL            : RBW:1000.000KHz VBW:3000.000KHz SWT:Auto            Detector : Peak            Project : 881329-01</p>
Avg.	 <p>Site : 03CH11-HY            Condition : AVG_BE_54 3m HORN 9120D-HF VERTICAL            : RBW:1000.000KHz VBW:1.000KHz SWT:Auto            Detector : Peak            Project : 881329-01</p>	Left blank



WIFI	Band 2 5250~5350MHz Band Edge @ 3m	
ANT	802.11n HT20 CH52 5260MHz - R	
1	Vertical	Fundamental
<b>Peak</b>	<p>Site : 03CH11-HY Condition : PEAK_BE_74 3m HORN 91200-HF VERTICAL Detector : Peak Project : 881329-01</p>	Left blank
<b>Avg.</b>	<p>Site : 03CH11-HY Condition : AVG_BE_54 3m HORN 91200-HF VERTICAL Detector : Peak Project : 881329-01</p>	Left blank



WIFI	Band 2 5250~5350MHz Band Edge @ 3m	
ANT	802.11n HT20 CH60 5300MHz - L	
1	Horizontal	Fundamental
Peak	<p>Site : 03CH11-HY            Condition : PEAK_BE_74 3m HORN 9120D-HF HORIZONTAL            Detector : Peak            Project : 881329-01</p>	<p>Site : 03CH11-HY            Condition : PEAK(LINB) 3m HORN 9120D-HF HORIZONTAL            Detector : Peak            Project : 881329-01</p>
Avg.	<p>Site : 03CH11-HY            Condition : AVG_BE_54 3m HORN 9120D-HF HORIZONTAL            Detector : Peak            Project : 881329-01</p>	Left blank

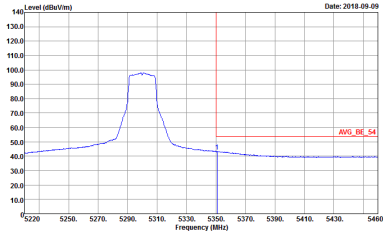

WIFI	Band 2 5250~5350MHz Band Edge @ 3m	
ANT	802.11n HT20 CH60 5300MHz - R	
1	Horizontal	Vertical
<p><b>Peak</b></p>	 <p>Site : 03CH11-HY            Condition : PEAK_BE_74 3m HORN 91200-HF HORIZONTAL            Detector : Peak            Project : 881329-01</p>	<p>Left blank</p>
<p><b>Avg.</b></p>	 <p>Site : 03CH11-HY            Condition : AVG_BE_54 3m HORN 91200-HF HORIZONTAL            Detector : Peak            Project : 881329-01</p>	<p>Left blank</p>

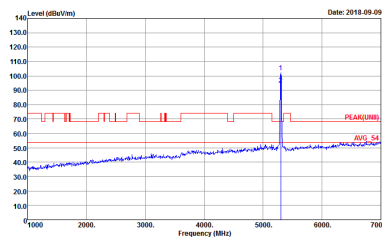
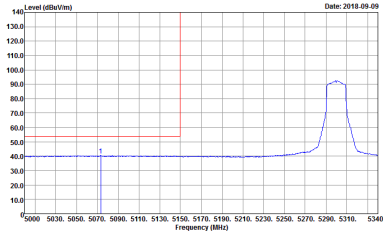

WIFI	Band 2 5250~5350MHz Band Edge @ 3m	
ANT	802.11n HT20 CH60 5300MHz - L	
1	Vertical	Fundamental
Peak	 <p>Site : 03CH11-HY            Condition : PEAK_BE_74 3m HORN 9120D-HF VERTICAL            Detector : Peak            Project : 881329-01</p>	 <p>Site : 03CH11-HY            Condition : PEAK(LINE) 3m HORN 9120D-HF VERTICAL            Detector : Peak            Project : 881329-01</p>
Avg.	 <p>Site : 03CH11-HY            Condition : AVG_BE_54 3m HORN 9120D-HF VERTICAL            Detector : Peak            Project : 881329-01</p>	Left blank





WIFI	Band 2 5250~5350MHz Band Edge @ 3m	
ANT	802.11n HT20 CH60 5300MHz - R	
1	Vertical	Fundamental
<b>Peak</b>	<p>Site : 03CH11-HY Condition : PEAK_BE_74 3m HORN 91200-HF VERTICAL Detector : Peak Project : 881329-01</p>	Left blank
<b>Avg.</b>	<p>Site : 03CH11-HY Condition : AVG_BE_54 3m HORN 91200-HF VERTICAL Detector : Peak Project : 881329-01</p>	Left blank

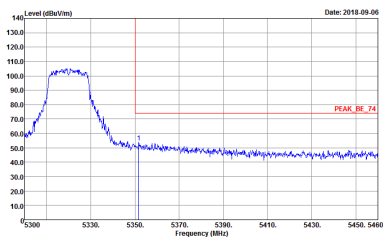
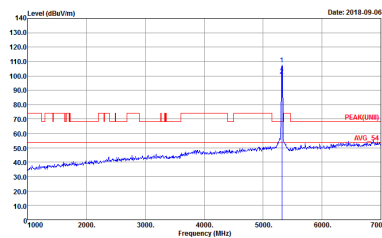
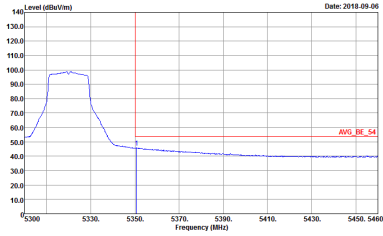

WIFI	Band 2 5250~5350MHz Band Edge @ 3m	
ANT	802.11n HT20 CH64 5320MHz	
1	Horizontal	Fundamental
Peak	 <p>Site : 03CH11-HY            Condition : PEAK_BE_74 3m HORN 9120D-HF HORIZONTAL            : RBW:1000.000kHz VBW:3000.000kHz SWT:Auto            Detector : Peak            Project : 881329-01</p>	 <p>Site : 03CH11-HY            Condition : PEAK(LINE) 3m HORN 9120D-HF HORIZONTAL            : RBW:1000.000kHz VBW:3000.000kHz SWT:Auto            Detector : Peak            Project : 881329-01</p>
Avg.	 <p>Site : 03CH11-HY            Condition : AVG_BE_54 3m HORN 9120D-HF HORIZONTAL            : RBW:1000.000kHz VBW:1.000kHz SWT:Auto            Detector : Peak            Project : 881329-01</p>	Left blank



WIFI	Band 2 5250~5350MHz Band Edge @ 3m	
ANT	802.11n HT20 CH64 5320MHz	
1	Vertical	Fundamental
<p><b>Peak</b></p>	<p>Site : 03CH11-HY            Condition : PEAK_BE_74 3m HORN 9120D-HF VERTICAL            : RBW:1000.000KHz VBW:3000.000KHz SWT:Auto            Detector : Peak            Project : 881329-01</p>	<p>Site : 03CH11-HY            Condition : PEAK(LINE) 3m HORN 9120D-HF VERTICAL            : RBW:1000.000KHz VBW:3000.000KHz SWT:Auto            Detector : Peak            Project : 881329-01</p>
<p><b>Avg.</b></p>	<p>Site : 03CH11-HY            Condition : AVG_BE_54 3m HORN 9120D-HF VERTICAL            : RBW:1000.000KHz VBW:1000KHz SWT:Auto            Detector : Peak            Project : 881329-01</p>	<p>Left blank</p>



**Band 2 5250~5350MHz  
WIFI 802.11ac VHT40 (Band Edge @ 3m)**

WIFI	Band 2 5250~5350MHz Band Edge @ 3m	
ANT	802.11ac VHT40 CH54 5270 MHz - L	
1	Horizontal	Fundamental
<b>Peak</b>	<p>Site : 03CHI1-HY Condition : PEAK_BE_74 3m HORN 91200-HF HORIZONTAL RBW:1000.000kHz VBW:3000.000kHz SWT:Auto Detector : Peak Project : 881329-01</p>	<p>Site : 03CHI1-HY Condition : PEAK(UNIT) 3m HORN 91200-HF HORIZONTAL RBW:1000.000kHz VBW:3000.000kHz SWT:Auto Detector : Peak Project : 881329-01</p>
<b>Avg.</b>	<p>Site : 03CHI1-HY Condition : AVG_BE_54 3m HORN 91200-HF HORIZONTAL RBW:1000.000kHz VBW:3.000kHz SWT:Auto Detector : Peak Project : 881329-01</p>	Left blank



WIFI	Band 2 5250~5350MHz Band Edge @ 3m	
ANT	802.11ac VHT40 CH54 5270 MHz - R	
1	Horizontal	Fundamental
<b>Peak</b>	<p>Site : 03CH11-HY Condition : PEAK_BE_74 3m HORN 91200-HF HORIZONTAL Detector : Peak Project : 881329-01</p>	Left blank
<b>Avg.</b>	<p>Site : 03CH11-HY Condition : AVG_BE_54 3m HORN 91200-HF HORIZONTAL Detector : Peak Project : 881329-01</p>	Left blank



WIFI	Band 2 5250~5350MHz Band Edge @ 3m	
ANT	802.11ac VHT40 CH54 5270 MHz - L	
1	Vertical	Vertical
Peak	<p>Site : 03CH11-HY            Condition : PEAK_BE_74 3m HORN 9120D-HF VERTICAL            Detector : Peak            Project : 881329-01</p>	<p>Site : 03CH11-HY            Condition : PEAK(LIN1) 3m HORN 9120D-HF VERTICAL            Detector : Peak            Project : 881329-01</p>
Avg.	<p>Site : 03CH11-HY            Condition : AVG_BE_54 3m HORN 9120D-HF VERTICAL            Detector : Peak            Project : 881329-01</p>	Left blank



WIFI	Band 2 5250~5350MHz Band Edge @ 3m	
ANT	802.11ac VHT40 CH54 5270 MHz - R	
1	Vertical	Vertical
<p><b>Peak</b></p>		<p>Left blank</p>
<p><b>Avg.</b></p>		<p>Left blank</p>



WIFI	Band 2 5250~5350MHz Band Edge @ 3m	
ANT	802.11ac VHT40 CH62 5310 MHz - L	
1	Horizontal	Fundamental
Peak	<p>Site : 03CH11-HY            Condition : PEAK_BE_74 3m HORN 91200-HF HORIZONTAL            Detector : Peak            Project : 881329-01</p>	<p>Site : 03CH11-HY            Condition : PEAK(LINE) 3m HORN 91200-HF HORIZONTAL            Detector : Peak            Project : 881329-01</p>
Avg.	<p>Site : 03CH11-HY            Condition : AVG_BE_54 3m HORN 91200-HF HORIZONTAL            Detector : Peak            Project : 881329-01</p>	Left blank



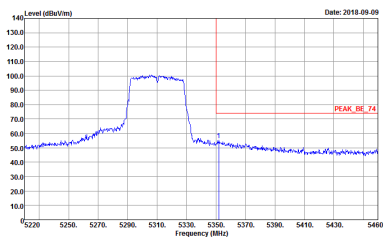

WIFI	Band 2 5250~5350MHz Band Edge @ 3m	
ANT	802.11ac VHT40 CH62 5310 MHz - R	
1	Horizontal	Fundamental
<p><b>Peak</b></p>	 <p>Site : 03CH11-HY            Condition : PEAK_BE_74 3m HORN 91200-HF HORIZONTAL            RBW:1000.000kHz VBW:3000.000kHz SWT:Auto            Detector : Peak            Project : 881329-01</p>	<p>Left blank</p>
<p><b>Avg.</b></p>	 <p>Site : 03CH11-HY            Condition : AVG_BE_54 3m HORN 91200-HF HORIZONTAL            RBW:1000.000kHz VBW:3.000kHz SWT:Auto            Detector : Peak            Project : 881329-01</p>	<p>Left blank</p>

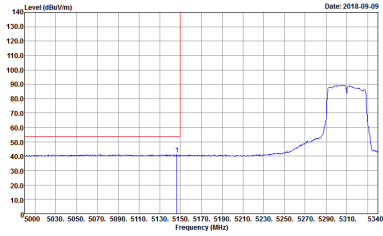

WIFI	Band 2 5250~5350MHz Band Edge @ 3m	
ANT	802.11ac VHT40 CH62 5310 MHz - L	
1	Vertical	Fundamental
Peak	 <p>Site : 03CH11-HY            Condition : PEAK_BE_74 3m HORN 91200-HF VERTICAL            RBW:1000.000KHz VBW:3000.000KHz SWT:Auto            Detector : Peak            Project : 881329-01</p>	 <p>Site : 03CH11-HY            Condition : PEAK(LINE) 3m HORN 91200-HF VERTICAL            RBW:1000.000KHz VBW:3000.000KHz SWT:Auto            Detector : Peak            Project : 881329-01</p>
Avg.	 <p>Site : 03CH11-HY            Condition : AVG_BE_54 3m HORN 91200-HF VERTICAL            RBW:1000.000KHz VBW:3.000KHz SWT:Auto            Detector : Peak            Project : 881329-01</p>	Left blank

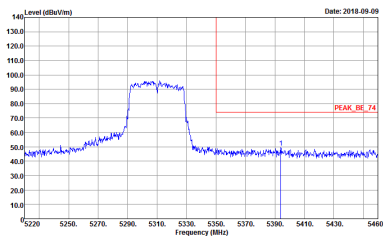
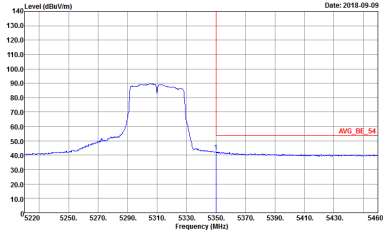

WIFI	Band 2 5250~5350MHz Band Edge @ 3m	
ANT	802.11ac VHT40 CH62 5310 MHz - R	
1	Vertical	Fundamental
<p><b>Peak</b></p>	 <p>Site : 03CH11-HY            Condition : PEAK_BE_74 3m HORN 91200-HF VERTICAL            Detector : Peak            Project : 881329-01</p>	<p>Left blank</p>
<p><b>Avg.</b></p>	 <p>Site : 03CH11-HY            Condition : AVG_BE_54 3m HORN 91200-HF VERTICAL            Detector : Peak            Project : 881329-01</p>	<p>Left blank</p>



**Band 2 5250~5350MHz**  
**WIFI 802.11ac VHT80 (Band Edge @ 3m)**

WIFI	Band 2 5250~5350MHz Band Edge @ 3m	
ANT	802.11ac VHT80 CH58 5290MHz - L	
1	Horizontal	Fundamental
<b>Peak</b>	<p>Site : 03CHI1-HY            Condition : PEAK_BE_74 3m HORN 91200-HF HORIZONTAL            RBW:1000.000kHz VBW:3000.000kHz SWT:Auto            Detector : Peak            Project : 881329-01</p>	<p>Site : 03CHI1-HY            Condition : PEAK(UNIT) 3m HORN 91200-HF HORIZONTAL            RBW:1000.000kHz VBW:3000.000kHz SWT:Auto            Detector : Peak            Project : 881329-01</p>
<b>Avg.</b>	<p>Site : 03CHI1-HY            Condition : AVG_BE_54 3m HORN 91200-HF HORIZONTAL            RBW:1000.000kHz VBW:3.000kHz SWT:Auto            Detector : Peak            Project : 881329-01</p>	Left blank

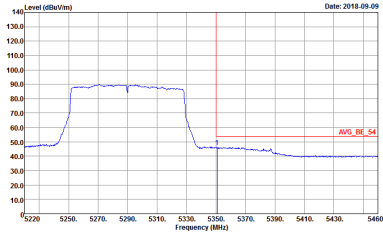

WIFI	Band 2 5250~5350MHz Band Edge @ 3m	
ANT	802.11ac VHT80 CH58 5290MHz - R	
1	Horizontal	Fundamental
<p><b>Peak</b></p>	 <p>Site : 03CHI1-HY            Condition : PEAK_BE_74 3m HORN 91200-HF HORIZONTAL            Detector : Peak            Project : 881329-01</p>	<p>Left blank</p>
<p><b>Avg.</b></p>	 <p>Site : 03CHI1-HY            Condition : AVG_BE_54 3m HORN 91200-HF HORIZONTAL            Detector : Peak            Project : 881329-01</p>	<p>Left blank</p>



WIFI	Band 2 5250~5350MHz Band Edge @ 3m	
ANT	802.11ac VHT80 CH58 5290MHz - L	
1	Vertical	Fundamental
Peak	 <p>Site : 03CH11-HY            Condition : PEAK_BE_74 3m HORN 9120D-HF VERTICAL            RBW:1000.000KHz VBW:3000.000KHz SWT:Auto            Detector : Peak            Project : 881329-01</p>	 <p>Site : 03CH11-HY            Condition : PEAK(LINE) 3m HORN 9120D-HF VERTICAL            RBW:1000.000KHz VBW:3000.000KHz SWT:Auto            Detector : Peak            Project : 881329-01</p>
Avg.	 <p>Site : 03CH11-HY            Condition : AVG_BE_54 3m HORN 9120D-HF VERTICAL            RBW:1000.000KHz VBW:3.000KHz SWT:Auto            Detector : Peak            Project : 881329-01</p>	Left blank



WIFI	Band 2 5250~5350MHz Band Edge @ 3m	
ANT	802.11ac VHT80 CH58 5290MHz - R	
1	Vertical	Fundamental
<p><b>Peak</b></p>	 <p>Site : 03CHI1-HY            Condition : PEAK_BE_74 3m HORN 91200-HF VERTICAL            Detector : Peak            Project : 881329-01</p>	<p>Left blank</p>
<p><b>Avg.</b></p>	 <p>Site : 03CHI1-HY            Condition : AVG_BE_54 3m HORN 91200-HF VERTICAL            Detector : Peak            Project : 881329-01</p>	<p>Left blank</p>



**Band 2 - 5250~5350MHz**  
**WIFI 802.11a (Harmonic @ 3m)**

<b>WIFI</b>	<b>Band 2 5250~5350MHz Harmonic @ 3m</b>	
<b>ANT</b>	<b>802.11a CH52 5260MHz</b>	
<b>1</b>	<b>Horizontal</b>	<b>Vertical</b>
<b>Peak</b> <b>Avg.</b>	<p>Site : 03CH11-HY          Condition : PEAK(UWB) 3m HORN 9120D-HF HORIZONTAL          Detector : Peak          Project : 881329-01</p>	<p>Site : 03CH11-HY          Condition : PEAK(UWB) 3m HORN 9120D-HF VERTICAL          Detector : Peak          Project : 881329-01</p>





WIFI	Band 2 5250~5350MHz Harmonic @ 3m	
ANT	802.11a CH60 5300MHz	
1	Horizontal	Vertical
Peak Avg.	<p>Site : 03CH11-14Y Condition : PEAK(LINEI) 3m HORN 9120D-HF HORIZONTAL Detector : Peak Project : 881329-01</p>	<p>Site : 03CH11-14Y Condition : PEAK(LINEI) 3m HORN 9120D-HF VERTICAL Detector : Peak Project : 881329-01</p>



<b>WIFI</b>	<b>Band 2 5250~5350MHz Harmonic @ 3m</b>	
<b>ANT</b>	<b>802.11a CH64 5320MHz</b>	
<b>1</b>	<b>Horizontal</b>	<b>Vertical</b>
<p><b>Peak</b></p> <p><b>Avg.</b></p>	<p>Site : 03CH11-14Y          Condition : PEAK(LINE) 3m HORN 9120D-HF HORIZONTAL          Detector : Peak          Project : 881329-01</p>	<p>Site : 03CH11-14Y          Condition : PEAK(LINE) 3m HORN 9120D-HF VERTICAL          Detector : Peak          Project : 881329-01</p>



**Band 2 5250~5350MHz**  
**WIFI 802.11n HT20 (Harmonic @ 3m)**

WIFI	Band 2 5250~5350MHz Harmonic @ 3m	
ANT	802.11n HT20 CH52 5260MHz	
1	Horizontal	Vertical
<p><b>Peak</b></p> <p><b>Avg.</b></p>	<p>Site : 03CHI1-HY            Condition : PEAK(UNII) 3m HORN 9120D-HF HORIZONTAL            Detector : Peak            Project : 881329-01</p>	<p>Site : 03CHI1-HY            Condition : PEAK(UNII) 3m HORN 9120D-HF VERTICAL            Detector : Peak            Project : 881329-01</p>

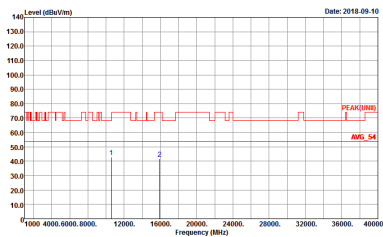
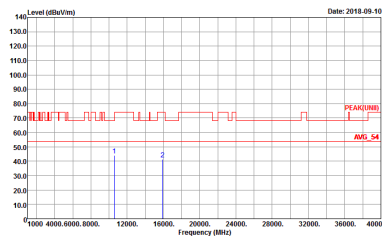

<b>WIFI</b>	<b>Band 2 5250~5350MHz Harmonic @ 3m</b>	
<b>ANT</b>	<b>802.11n HT20 CH60 5300MHz</b>	
<b>1</b>	<b>Horizontal</b>	<b>Vertical</b>
<p><b>Peak</b></p> <p><b>Avg.</b></p>	 <p>Site : 03CH11-14Y          Condition : PEAK(UWB) 3m HORN 9120D-HF HORIZONTAL          Detector : Peak          Project : 881329-01</p>	 <p>Site : 03CH11-14Y          Condition : PEAK(UWB) 3m HORN 9120D-HF VERTICAL          Detector : Peak          Project : 881329-01</p>



WIFI	Band 2 5250~5350MHz Harmonic @ 3m	
ANT	802.11n HT20 CH64 5320MHz	
1	Horizontal	Vertical
<b>Peak</b> <b>Avg.</b>	<p>Horizontal spectrum plot showing Level (dBm/Vm) vs Frequency (MHz). The plot displays a noisy baseline around 70 dBm/Vm. Two peaks are marked with blue vertical lines and labeled '1' and '2'. Peak 1 is at approximately 11.5 MHz and Peak 2 is at approximately 15.5 MHz. A red horizontal line indicates the average level at 54 dBm/Vm. The plot includes a 'PEAK(LINEI)' label and a date of 2018-09-11. Metadata below the plot: Site: 03CH11-14Y, Condition: PEAK(LINEI) 3m HORN 9120D-HF HORIZONTAL, Detector: Peak, Project: 881329-01.</p>	<p>Vertical spectrum plot showing Level (dBm/Vm) vs Frequency (MHz). The plot displays a noisy baseline around 70 dBm/Vm. Two peaks are marked with blue vertical lines and labeled '1' and '2'. Peak 1 is at approximately 11.5 MHz and Peak 2 is at approximately 15.5 MHz. A red horizontal line indicates the average level at 54 dBm/Vm. The plot includes a 'PEAK(LINEI)' label and a date of 2018-09-11. Metadata below the plot: Site: 03CH11-14Y, Condition: PEAK(LINEI) 3m HORN 9120D-HF VERTICAL, Detector: Peak, Project: 881329-01.</p>



**Band 2 5250~5350MHz  
WIFI 802.11ac VHT40 (Harmonic @ 3m)**

WIFI	Band 2 5250~5350MHz Harmonic @ 3m	
ANT	802.11ac VHT40 CH54 5270 MHz	
1	Horizontal	Vertical
<b>Peak</b> <b>Avg.</b>	<p>Site : 03CHI1-HY Condition : PEAK(LINII) 3m HORN 9120D-HF HORIZONTAL Detector : Peak Project : 881329-01</p>	<p>Site : 03CHI1-HY Condition : PEAK(LINII) 3m HORN 9120D-HF VERTICAL Detector : Peak Project : 881329-01</p>



WIFI	Band 2 5250~5350MHz Harmonic @ 3m	
ANT	802.11ac VHT40 CH62 5310 MHz	
1	Horizontal	Vertical
<p><b>Peak</b></p> <p><b>Avg.</b></p>	<p>Site : 03CH11-14Y Condition : PEAK(LINEI) 3m HORN 9120D-HF HORIZONTAL Detector : Peak Project : 881329-01</p>	<p>Site : 03CH11-14Y Condition : PEAK(LINEI) 3m HORN 9120D-HF VERTICAL Detector : Peak Project : 881329-01</p>



Band 2 5250~5350MHz
WIFI 802.11ac VHT80 (Harmonic @ 3m)

Table with 3 columns: WIFI, ANT, and measurement results for Horizontal and Vertical orientations. Includes two graphs showing Level (dBm/1m) vs Frequency (MHz) and associated site/condition details.





**Band 3 - 5470~5725MHz**  
**WIFI 802.11a (Band Edge @ 3m)**

WIFI	Band 3 5470~5725MHz Band Edge @ 3m	
ANT	802.11a CH100 5500MHz	
1	Horizontal	Fundamental
<b>Peak</b>	<p>Site : 03CHI1-HY            Condition : PEAK_BE(UNIT)_B3 3m HORN 9120D-HF HORIZONTAL            Detector : Peak            Project : 881329-01            Setting : 12</p>	<p>Site : 03CHI1-HY            Condition : PEAK(UNIT) 3m HORN 9120D-HF HORIZONTAL            Detector : Peak            Project : 881329-01            Setting : 12</p>
<b>Avg.</b>	<p>Site : 03CHI1-HY            Condition : AVG_BE(UNIT)_B3 3m HORN 9120D-HF HORIZONTAL            Detector : Peak            Project : 881329-01            Setting : 12</p>	Left blank

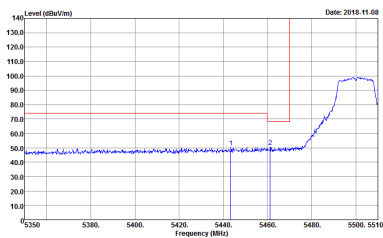
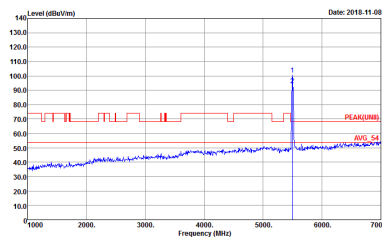
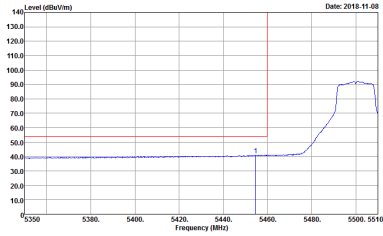

WIFI	Band 3 5470~5725MHz Band Edge @ 3m	
ANT	802.11a CH100 5500MHz	
1	Vertical	Fundamental
Peak	 <p>Site : 03CH11-HY            Condition : PEAK_BE[UNII]_B3 3m HORN 9120D-HF VERTICAL            : RBW:1000.000KHz VBW:3000.000KHz SWT:Auto            Detector : Peak            Project : 881329-01            Setting : 12</p>	 <p>Site : 03CH11-HY            Condition : PEAK[UNII] 3m HORN 9120D-HF VERTICAL            : RBW:1000.000KHz VBW:3000.000KHz SWT:Auto            Detector : Peak            Project : 881329-01            Setting : 12</p>
Avg.	 <p>Site : 03CH11-HY            Condition : AVG_BE[UNII]_B3 3m HORN 9120D-HF VERTICAL            : RBW:1000.000KHz VBW:1000KHz SWT:Auto            Detector : Peak            Project : 881329-01            Setting : 12</p>	Left blank

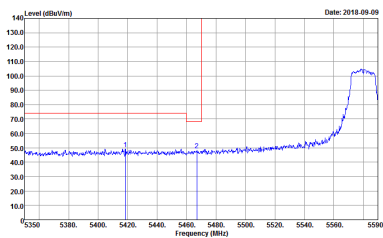
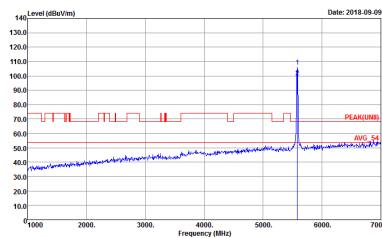
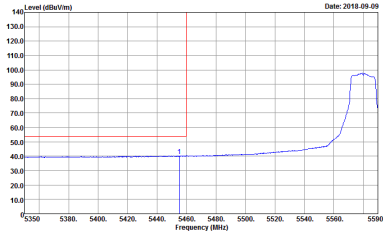

WIFI	Band 3 5470~5725MHz Band Edge @ 3m	
ANT	802.11a CH116 5580MHz - L	
1	Horizontal	Fundamental
<p><b>Peak</b></p>	 <p>Site : 03CH11-HY            Condition : PEAK_BE(UNIT)_B3 3m HORN 9120D-HF HORIZONTAL            Detector : Peak            Project : 881329-01</p>	 <p>Site : 03CH11-HY            Condition : PEAK(UNIT) 3m HORN 9120D-HF HORIZONTAL            Detector : Peak            Project : 881329-01</p>
<p><b>Avg.</b></p>	 <p>Site : 03CH11-HY            Condition : AVG_BE(UNIT)_B3 3m HORN 9120D-HF HORIZONTAL            Detector : Peak            Project : 881329-01</p>	<p>Left blank</p>



WIFI	Band 3 5470~5725MHz Band Edge @ 3m	
ANT	802.11a CH116 5580MHz - R	
1	Horizontal	Fundamental
Peak	<p>Site : :D8CH11A-F Condition : :PEAK_BE([UNIT])_B3 3m HORN 91200-HF HORIZONTAL Detector : :Peak Project : :881329-01</p>	Left blank



WIFI	Band 3 5470~5725MHz Band Edge @ 3m	
ANT	802.11a CH116 5580MHz - L	
1	Vertical	Fundamental
<p><b>Peak</b></p>		
<p><b>Avg.</b></p>		<p><b>Left blank</b></p>



WIFI	Band 3 5470~5725MHz Band Edge @ 3m	
ANT	802.11a CH116 5580MHz - R	
1	Vertical	Fundamental
Peak	<p>Site : D8CH116-F Condition : PEAK_BE([UNIT]), B3 3m HORN 91200-HF VERTICAL Detector : Peak Project : 881329-01</p>	Left blank

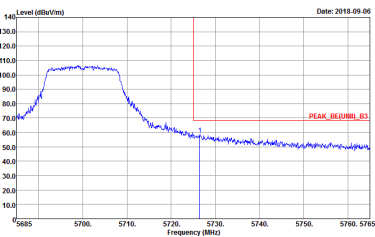
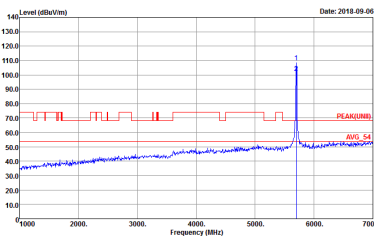

WIFI	Band 3 5470~5725MHz Band Edge @ 3m	
ANT	802.11a CH140 5700MHz	
1	Horizontal	Fundamental
Peak	 <p>Site : 03CH11-14Y            Condition : PEAK_BE(UNI)_B3 3m HORN 9120D-HF HORIZONTAL            Detector : Peak            Project : 881329-01</p>	 <p>Site : 03CH11-14Y            Condition : PEAK(UNI) 3m HORN 9120D-HF HORIZONTAL            Detector : Peak            Project : 881329-01</p>

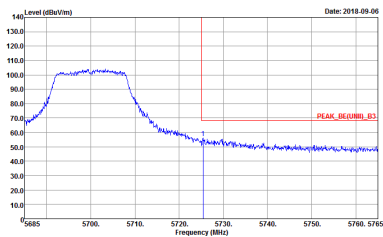
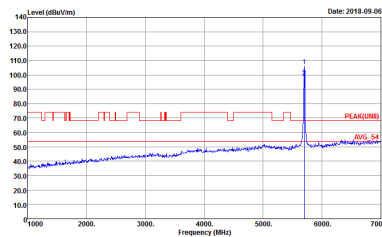

WIFI	Band 3 5470~5725MHz Band Edge @ 3m	
ANT	802.11a CH140 5700MHz	
1	Vertical	Fundamental
Peak	 <p>Site : 03CH11-14Y            Condition : PEAK_BE(UNI)_B3 3m HORN 9120D-HF VERTICAL            RBW:1000.000KHz VBW:3000.000KHz SWT:Auto            Detector : Peak            Project : 881329-01</p>	 <p>Site : 03CH11-14Y            Condition : PEAK(UNI) 3m HORN 9120D-HF VERTICAL            RBW:1000.000KHz VBW:3000.000KHz SWT:Auto            Detector : Peak            Project : 881329-01</p>





**Band 3 5470~5725MHz  
WIFI 802.11n HT20 (Band Edge @ 3m)**

WIFI	Band 3 5470~5725MHz Band Edge @ 3m	
ANT	802.11n HT20 CH100 5500MHz	
1	Horizontal	Fundamental
<b>Peak</b>	<p>Site : 03CH11-HY Condition : PEAK_BE(UNIT1)_B3 3m HORN 9120D-HF HORIZONTAL Detector : Peak Project : 881329-01 Setting : 7.5</p>	<p>Site : 03CH11-HY Condition : PEAK(UNIT1) 3m HORN 9120D-HF HORIZONTAL Detector : Peak Project : 881329-01 Setting : 7.5</p>
<b>Avg.</b>	<p>Site : 03CH11-HY Condition : AVG_BE(UNIT1)_B3 3m HORN 9120D-HF HORIZONTAL Detector : Peak Project : 881329-01 Setting : 7.5</p>	<b>Left blank</b>

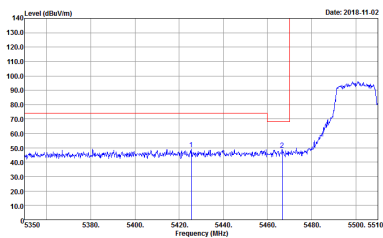
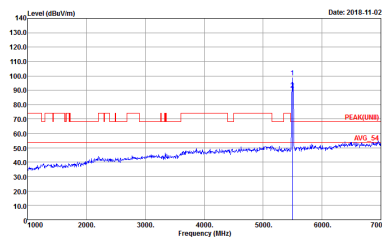
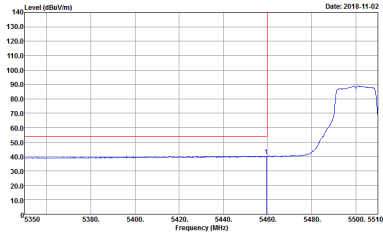

WIFI	Band 3 5470~5725MHz Band Edge @ 3m	
ANT	802.11n HT20 CH100 5500MHz	
1	Vertical	Fundamental
<p><b>Peak</b></p>	 <p>Site : 03CH11-HY            Condition : PEAK_BE[UNII]_B3 3m HORN 9120D-HF VERTICAL            Detector : Peak            Project : 881329-01            Setting : 7.5</p>	 <p>Site : 03CH11-HY            Condition : PEAK[UNII] 3m HORN 9120D-HF VERTICAL            Detector : Peak            Project : 881329-01            Setting : 7.5</p>
<p><b>Avg.</b></p>	 <p>Site : 03CH11-HY            Condition : AVG_BE[UNII]_B3 3m HORN 9120D-HF VERTICAL            Detector : Peak            Project : 881329-01            Setting : 7.5</p>	<p>Left blank</p>

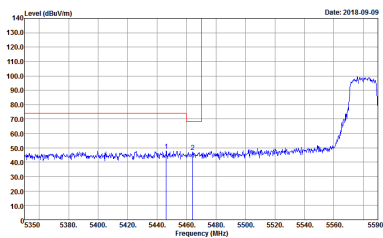
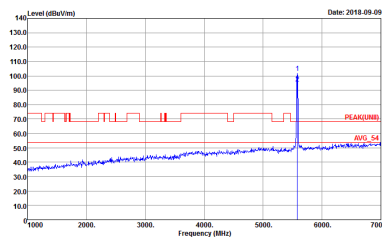
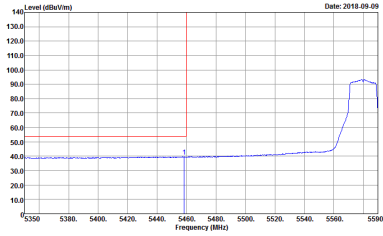

WIFI	Band 3 5470~5725MHz Band Edge @ 3m	
ANT	802.11n HT20 CH116 5580MHz - L	
1	Horizontal	Fundamental
Peak	 <p>Site : 03CH11-HY            Condition : PEAK_BE[UNIT],_B3 3m HORN 9120D-HF HORIZONTAL            RBW:1000.000KHz VBW:3000.000KHz SWT:Auto            Detector : Peak            Project : 881329-01</p>	 <p>Site : 03CH11-HY            Condition : PEAK[UNIT] 3m HORN 9120D-HF HORIZONTAL            RBW:1000.000KHz VBW:3000.000KHz SWT:Auto            Detector : Peak            Project : 881329-01</p>
Avg.	 <p>Site : 03CH11-HY            Condition : AVG_BE[UNIT],_B3 3m HORN 9120D-HF HORIZONTAL            RBW:1000.000KHz VBW:1000KHz SWT:Auto            Detector : Peak            Project : 881329-01</p>	Left blank



WIFI	Band 3 5470~5725MHz Band Edge @ 3m	
ANT	802.11n HT20 CH116 5580MHz - R	
1	Horizontal	Fundamental
Peak	<p>Site : D3CH11-RF Condition : PEAK_BE(UNIT)_B3 3m HORN 91200-HF HORIZONTAL Detector : Peak Project : 881329-01</p>	Left blank

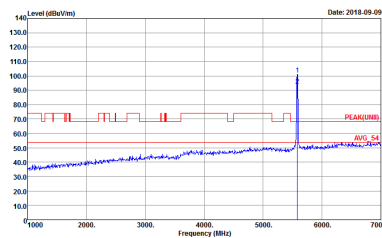
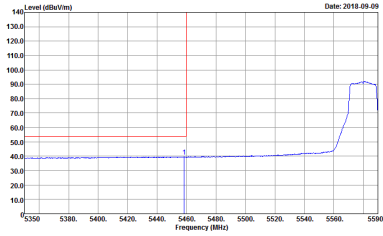

WIFI	Band 3 5470~5725MHz Band Edge @ 3m	
ANT	802.11n HT20 CH116 5580MHz - L	
1	Vertical	Fundamental
<p><b>Peak</b></p>	 <p>Site : 03CH11-HY            Condition : PEAK_BE(UNIT)_B3 3m HORN 9120D-HF VERTICAL            Detector : Peak            Project : 881329-01</p>	 <p>Site : 03CH11-HY            Condition : PEAK(UNIT) 3m HORN 9120D-HF VERTICAL            Detector : Peak            Project : 881329-01</p>
<p><b>Avg.</b></p>	 <p>Site : 03CH11-HY            Condition : AVG_BE(UNIT)_B3 3m HORN 9120D-HF VERTICAL            Detector : Peak            Project : 881329-01</p>	<p>Left blank</p>



WIFI	Band 3 5470~5725MHz Band Edge @ 3m	
ANT	802.11n HT20 CH116 5580MHz - R	
1	Vertical	Fundamental
Peak	<p>Site : D8CH11-RF Condition : PEAK_BE([UNIT], B3 3m HORN 91200-HF VERTICAL) Detector : Peak Project : 881329-01</p>	Left blank

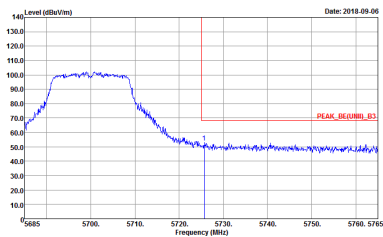
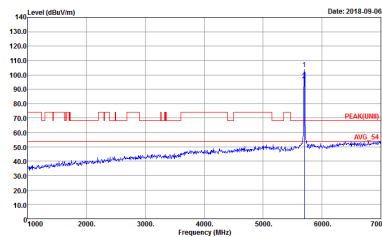

WIFI	Band 3 5470~5725MHz Band Edge @ 3m	
ANT	802.11n HT20 CH140 5700MHz	
1	Horizontal	Fundamental
Peak	 <p>Site : 03CH11-14Y            Condition : PEAK_BE(UNI)_B3 3m HORN 9120D-HF HORIZONTAL            Detector : Peak            Project : 881329-01</p>	 <p>Site : 03CH11-14Y            Condition : PEAK(UNI)_B3 3m HORN 9120D-HF HORIZONTAL            Detector : Peak            Project : 881329-01</p>



WIFI	Band 3 5470~5725MHz Band Edge @ 3m	
ANT	802.11n HT20 CH140 5700MHz	
1	Vertical	Fundamental
<p><b>Peak.</b></p>	<p>Site : 03CH11-14Y            Condition : PEAK_BE[UNII]_B3 3m HORN 9120D-HF VERTICAL            Detector : Peak            Project : 881329-01</p>	<p>Site : 03CH11-14Y            Condition : PEAK[UNII] 3m HORN 9120D-HF VERTICAL            Detector : Peak            Project : 881329-01</p>





**Band 3 5470~5725MHz  
WIFI 802.11ac VHT40 (Band Edge @ 3m)**

WIFI	Band 3 5470~5725MHz Band Edge @ 3m	
ANT	802.11ac VHT40 CH102 5510MHz - L	
1	Horizontal	Fundamental
<b>Peak</b>	<p>Site : 03CH11-HY Condition : PEAK_BE(UNIT1)_B3 3m HORN 9120D-HF HORIZONTAL Detector : Peak Project : 881329-01</p>	<p>Site : 03CH11-HY Condition : PEAK(UNIT1) 3m HORN 9120D-HF HORIZONTAL Detector : Peak Project : 881329-01</p>
<b>Avg.</b>	<p>Site : 03CH11-HY Condition : AVG_BE(UNIT1)_B3 3m HORN 9120D-HF HORIZONTAL Detector : Peak Project : 881329-01</p>	<b>Left blank</b>



WIFI	Band 3 5470~5725MHz Band Edge @ 3m	
ANT	802.11ac VHT40 CH102 5510MHz - R	
1	Horizontal	Fundamental
Peak	<p>Site : D13CH11-4-F Condition : PEAK_BE([UNIT]),_B3 3m HORN 91200-HF HORIZONTAL Detector : Peak Project : 881329-01</p>	Left blank

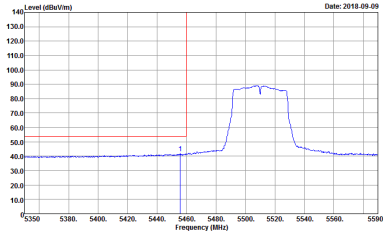

WIFI	Band 3 5470~5725MHz Band Edge @ 3m	
ANT	802.11ac VHT40 CH102 5510MHz - L	
1	Vertical	Fundamental
Peak	 <p>Site : 03CH11-HY            Condition : PEAK_BE[UNII]_B3 3m HORN 9120D-HF VERTICAL            Detector : Peak            Project : 881329-01</p>	 <p>Site : 03CH11-HY            Condition : PEAK[UNII] 3m HORN 9120D-HF VERTICAL            Detector : Peak            Project : 881329-01</p>
Avg.	 <p>Site : 03CH11-HY            Condition : AVG_BE[UNII]_B3 3m HORN 9120D-HF VERTICAL            Detector : Peak            Project : 881329-01</p>	Left blank



WIFI	Band 3 5470~5725MHz Band Edge @ 3m	
ANT	802.11ac VHT40 CH102 5510MHz - R	
1	Vertical	Fundamental
Peak	<p>Site : D2CH11-4-F Condition : PEAK_BE([UNIT]), B3 3m HORN 91200-HF VERTICAL Detector : Peak Project : 881329-01</p>	Left blank

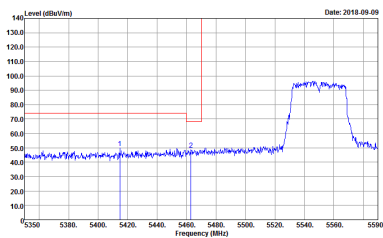
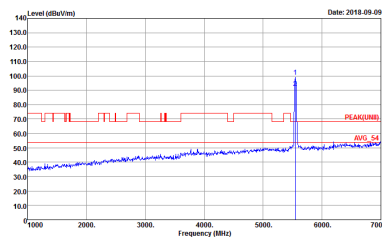

WIFI	Band 3 5470~5725MHz Band Edge @ 3m	
ANT	802.11ac VHT40 CH110 5550MHz - L	
1	Horizontal	Fundamental
Peak	 <p>Site : 03CH11-HY            Condition : PEAK_BE[UNIT],_B3 3m HORN 9120D-HF HORIZONTAL            Detector : Peak            Project : 881329-01</p>	 <p>Site : 03CH11-HY            Condition : PEAK[UNIT] 3m HORN 9120D-HF HORIZONTAL            Detector : Peak            Project : 881329-01</p>
Avg.	 <p>Site : 03CH11-HY            Condition : AVG_BE[UNIT],_B3 3m HORN 9120D-HF HORIZONTAL            Detector : Peak            Project : 881329-01</p>	Left blank



WIFI	Band 3 5470~5725MHz Band Edge @ 3m	
ANT	802.11ac VHT40 CH110 5550MHz - R	
1	Horizontal	Fundamental
Peak	<p>Site : D1CH11-RF Condition : PEAK_BE([UNIT]), B3 3m HORN 91200-HF HORIZONTAL Detector : Peak Project : 881329-01</p>	Left blank



WIFI	Band 3 5470~5725MHz Band Edge @ 3m	
ANT	802.11ac VHT40 CH110 5550MHz - L	
1	Vertical	Fundamental
Peak	 <p>Site : 03CH11-HY            Condition : PEAK_BE(UNIT)_B3 3m HORN 9120D-HF VERTICAL            RBW:1000.000KHz VBW:3000.000KHz SWT:Auto            Detector : Peak            Project : 881329-01</p>	 <p>Site : 03CH11-HY            Condition : PEAK(UNIT) 3m HORN 9120D-HF VERTICAL            RBW:1000.000KHz VBW:3000.000KHz SWT:Auto            Detector : Peak            Project : 881329-01</p>
Avg.	 <p>Site : 03CH11-HY            Condition : AVG_BE(UNIT)_B3 3m HORN 9120D-HF VERTICAL            RBW:1000.000KHz VBW:3.000KHz SWT:Auto            Detector : Peak            Project : 881329-01</p>	Left blank



WIFI	Band 3 5470~5725MHz Band Edge @ 3m	
ANT	802.11ac VHT40 CH110 5550MHz - R	
1	Vertical	Fundamental
Peak	<p>Site : D1329-01-F Condition : PEAK_BE[UNII]_B3 3m HORN 91200-HF VERTICAL Detector : Peak Project : 881329-01</p>	Left blank





WIFI	Band 3 5470~5725MHz Band Edge @ 3m	
ANT	802.11ac VHT40 CH134 5670MHz - L	
1	Horizontal	Fundamental
<p><b>Peak</b></p>	<p>Site : 03CH11-HY            Condition : PEAK_BE[UNIT], B3 3m HORN 9120D-HF HORIZONTAL            Detector : Peak            Project : 881329-01</p>	<p>Site : 03CH11-HY            Condition : PEAK[UNIT] 3m HORN 9120D-HF HORIZONTAL            Detector : Peak            Project : 881329-01</p>
<p><b>Avg.</b></p>	<p>Site : 03CH11-HY            Condition : AVG_BE[UNIT], B3 3m HORN 9120D-HF HORIZONTAL            Detector : Peak            Project : 881329-01</p>	<p><b>Left blank</b></p>



WIFI	Band 3 5470~5725MHz Band Edge @ 3m	
ANT	802.11ac VHT40 CH134 5670MHz - R	
1	Horizontal	Fundamental
Peak	<p>Site : DCCH11-4-F Condition : PEAK_BE(UNIT)_B3 3m HORN 91200-HF HORIZONTAL Detector : Peak Project : 881329-01</p>	Left blank



WIFI	Band 3 5470~5725MHz Band Edge @ 3m	
ANT	802.11ac VHT40 CH134 5670MHz - L	
1	Vertical	Fundamental
<p><b>Peak</b></p>	<p>Site : 03CH11-HY            Condition : PEAK_BE[UNII]_B3 3m HORN 9120D-HF VERTICAL            Detector : Peak            Project : 881329-01</p>	<p>Site : 03CH11-HY            Condition : PEAK[UNII] 3m HORN 9120D-HF VERTICAL            Detector : Peak            Project : 881329-01</p>
<p><b>Avg.</b></p>	<p>Site : 03CH11-HY            Condition : AVG_BE[UNII]_B3 3m HORN 9120D-HF VERTICAL            Detector : Peak            Project : 881329-01</p>	<p><b>Left blank</b></p>



WIFI	Band 3 5470~5725MHz Band Edge @ 3m	
ANT	802.11ac VHT40 CH134 5670MHz - R	
1	Vertical	Fundamental
Peak	<p>Site : DCCH11-4-F Condition : PEAK_BE(UNIT)_B3 3m HORN 91200-HF VERTICAL Detector : Peak Project : 881329-01</p>	Left blank



**Band 3 5470~5725MHz  
WIFI 802.11ac VHT80 (Band Edge @ 3m)**

WIFI	Band 3 5470~5725MHz Band Edge @ 3m	
ANT	802.11ac VHT80 CH106 5530MHz - L	
1	Horizontal	Fundamental
<b>Peak</b>	<p>Site : 03CH11-HY Condition : PEAK_BE(UNIT1)_B3 3m HORN 9120D-HF HORIZONTAL Detector : Peak Project : 881329-01</p>	<p>Site : 03CH11-HY Condition : PEAK(UNIT1) 3m HORN 9120D-HF HORIZONTAL Detector : Peak Project : 881329-01</p>
<b>Avg.</b>	<p>Site : 03CH11-HY Condition : AVG_BE(UNIT1)_B3 3m HORN 9120D-HF HORIZONTAL Detector : Peak Project : 881329-01</p>	<b>Left blank</b>



WIFI	Band 3 5470~5725MHz Band Edge @ 3m	
ANT	802.11ac VHT80 CH106 5530MHz - R	
1	Horizontal	Fundamental
Peak	<p>Site : D11329-01 Condition : PEAK_BE([UNIT]), B3 3m HORN 91200-HF HORIZONTAL Detector : Peak Project : 881329-01</p>	Left blank

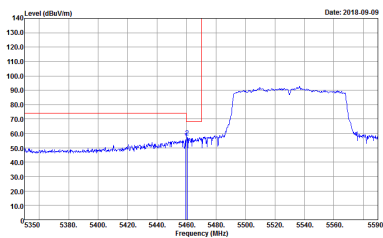
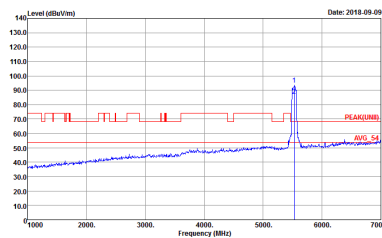
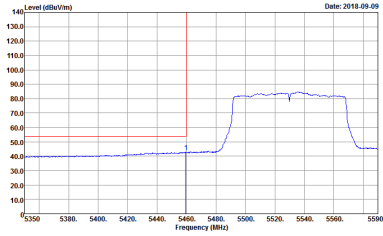

WIFI	Band 3 5470~5725MHz Band Edge @ 3m	
ANT	802.11ac VHT80 CH106 5530MHz - L	
1	Vertical	Fundamental
Peak	 <p>Site : 03CH11-HY          Condition : PEAK_BE(UNIT)_B3 3m HORN 9120D-HF VERTICAL          Detector : Peak          Project : 881329-01</p>	 <p>Site : 03CH11-HY          Condition : PEAK(UNIT) 3m HORN 9120D-HF VERTICAL          Detector : Peak          Project : 881329-01</p>
Avg.	 <p>Site : 03CH11-HY          Condition : AVG_BE(UNIT)_B3 3m HORN 9120D-HF VERTICAL          Detector : Peak          Project : 881329-01</p>	Left blank



WIFI	Band 3 5470~5725MHz Band Edge @ 3m	
ANT	802.11ac VHT80 CH106 5530MHz - R	
1	Vertical	Fundamental
Peak	<p>Site : D115-11-F Condition : PEAK_BE([UNIT]), B3 3m HORN 91200-HF VERTICAL Detector : Peak Project : 881329-01</p>	Left blank



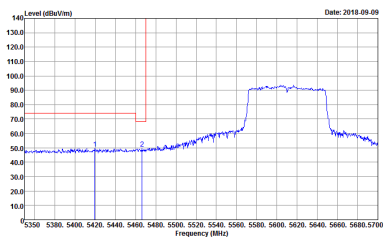
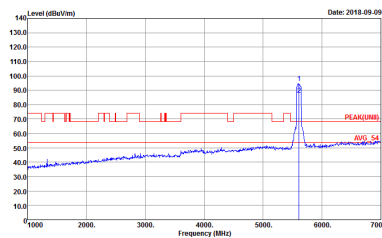
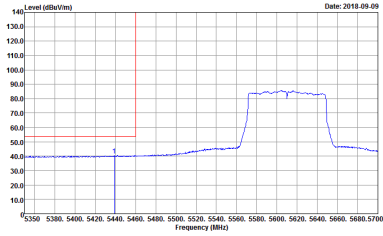

WIFI	Band 3 5470~5725MHz Band Edge @ 3m	
ANT	802.11ac VHT80 CH122 5610MHz - L	
1	Horizontal	Fundamental
Peak	 <p>Site : 03CH11-HY            Condition : PEAK_BE(UNIT)_B3 3m HORN 9120D-HF HORIZONTAL            Detector : Peak            Project : 881329-01</p>	 <p>Site : 03CH11-HY            Condition : PEAK(UNIT) 3m HORN 9120D-HF HORIZONTAL            Detector : Peak            Project : 881329-01</p>
Avg.	 <p>Site : 03CH11-HY            Condition : AVG_BE(UNIT)_B3 3m HORN 9120D-HF HORIZONTAL            Detector : Peak            Project : 881329-01</p>	Left blank



WIFI	Band 3 5470~5725MHz Band Edge @ 3m	
ANT	802.11ac VHT80 CH122 5610MHz - R	
1	Horizontal	Fundamental
Peak	<p>Site : DCCH11-4-F Condition : PEAK_BE([UNIT]),_B3 3m HORN 91200-HF HORIZONTAL Detector : Peak Project : 881329-01</p>	Left blank



WIFI	Band 3 5470~5725MHz Band Edge @ 3m	
ANT	802.11ac VHT80 CH122 5610MHz - L	
1	Vertical	Fundamental
Peak	<p>Site : 03CH11-HY            Condition : PEAK_BE(UNIT)_B3 3m HORN 9120D-HF VERTICAL            Detector : Peak            Project : 881329-01</p>	<p>Site : 03CH11-HY            Condition : PEAK(UNIT) 3m HORN 9120D-HF VERTICAL            Detector : Peak            Project : 881329-01</p>
Avg.	<p>Site : 03CH11-HY            Condition : AVG_BE(UNIT)_B3 3m HORN 9120D-HF VERTICAL            Detector : Peak            Project : 881329-01</p>	Left blank



WIFI	Band 3 5470~5725MHz Band Edge @ 3m	
ANT	802.11ac VHT80 CH122 5610MHz - R	
1	Vertical	Fundamental
Peak	<p>Site : DCCH11-4-F Condition : PEAK_BE([UNIT]),_B3 3m HORN 91200-HF VERTICAL Detector : Peak Project : 881329-01</p>	Left blank



**Band 3 - 5470~5725MHz**  
**WIFI 802.11a (Harmonic @ 3m)**

<b>WIFI</b>	<b>Band 3 5470~5725MHz Harmonic @ 3m</b>	
<b>ANT</b>	<b>802.11a CH100 5500MHz</b>	
<b>1</b>	<b>Horizontal</b>	<b>Vertical</b>
<b>Peak</b> <b>Avg.</b>	<p>Site : 03CH11-HY          Condition : PEAK(LINE1) 3m HORN 9120D-HF HORIZONTAL          Detector : Peak          Project : 881329-01          Setting : 12</p>	<p>Site : 03CH11-HY          Condition : PEAK(LINE1) 3m HORN 9120D-HF VERTICAL          Detector : Peak          Project : 881329-01          Setting : 12</p>



WIFI	Band 3 5470~5725MHz Harmonic @ 3m	
ANT	802.11a CH116 5580MHz	
1	Horizontal	Vertical
Peak Avg.	<p>Site : 03CH11-14Y Condition : PEAK(LINEI) 3m HORN 9120D-HF HORIZONTAL Detector : Peak Project : 881329-01</p>	<p>Site : 03CH11-14Y Condition : PEAK(LINEI) 3m HORN 9120D-HF VERTICAL Detector : Peak Project : 881329-01</p>



WIFI	Band 3 5470~5725MHz Harmonic @ 3m	
ANT	802.11a CH140 5700MHz	
1	Horizontal	Vertical
<b>Peak</b> <b>Avg.</b>	<p>Site : 03CH11-14Y Condition : PEAK(LINEI) 3m HORN 9120D-HF HORIZONTAL Detector : Peak Project : 881329-01</p>	<p>Site : 03CH11-14Y Condition : PEAK(LINEI) 3m HORN 9120D-HF VERTICAL Detector : Peak Project : 881329-01</p>

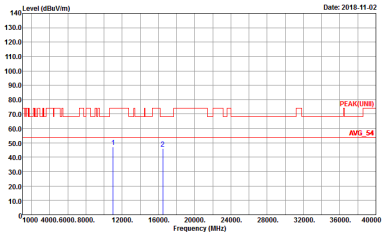
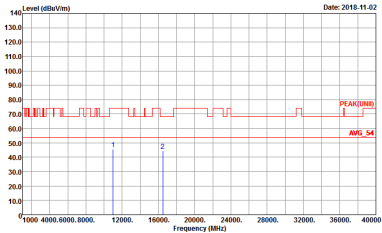

**Band 3 5470~5725MHz  
WIFI 802.11n HT20 (Harmonic @ 3m)**

WIFI	Band 3 5470~5725MHz Harmonic @ 3m	
ANT	802.11n HT20 CH100 5500MHz	
1	Horizontal	Vertical
<p><b>Peak</b> <b>Avg.</b></p>	 <p>Site : 03CHI1-HY Condition : PEAK(UNII) 3m HORN 9120D-HF HORIZONTAL Detector : Peak Project : 881329-01</p>	 <p>Site : 03CHI1-HY Condition : PEAK(UNII) 3m HORN 9120D-HF VERTICAL Detector : Peak Project : 881329-01</p>





WIFI	<b>Band 3 5470~5725MHz Harmonic @ 3m</b>	
ANT	<b>802.11n HT20 CH116 5580MHz</b>	
1	<b>Horizontal</b>	<b>Vertical</b>
<p><b>Peak</b></p> <p><b>Avg.</b></p>	<p>Site : 03CH11-14Y          Condition : PEAK(LINEI) 3m HORN 9120D-HF HORIZONTAL          Detector : Peak          Project : 881329-01</p>	<p>Site : 03CH11-14Y          Condition : PEAK(LINEI) 3m HORN 9120D-HF VERTICAL          Detector : Peak          Project : 881329-01</p>



WIFI	Band 3 5470~5725MHz Harmonic @ 3m	
ANT	802.11n HT20 CH140 5700MHz	
1	Horizontal	Vertical
<b>Peak</b> <b>Avg.</b>	<p>Site : 03CH11-14Y Condition : PEAK(LINE) 3m HORN 9120D-HF HORIZONTAL Detector : Peak Project : 881329-01</p>	<p>Site : 03CH11-14Y Condition : PEAK(LINE) 3m HORN 9120D-HF VERTICAL Detector : Peak Project : 881329-01</p>

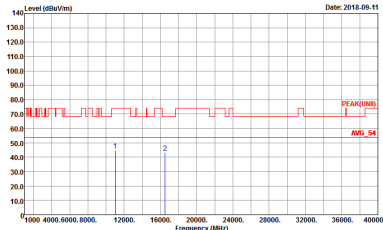
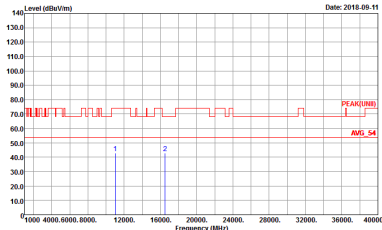

**Band 3 5470~5725MHz  
WIFI 802.11ac VHT40 (Harmonic @ 3m)**

WIFI	Band 3 5470~5725MHz Harmonic @ 3m	
ANT	802.11ac VHT40 CH102 5510MHz	
1	Horizontal	Vertical
<p><b>Peak</b> <b>Avg.</b></p>	 <p>Site : 03CHI1-HY Condition : PEAK(UNII) 3m HORN 9120D-HF HORIZONTAL Detector : Peak Project : 881329-01</p>	 <p>Site : 03CHI1-HY Condition : PEAK(UNII) 3m HORN 9120D-HF VERTICAL Detector : Peak Project : 881329-01</p>



WIFI	Band 3 5470~5725MHz Harmonic @ 3m	
ANT	802.11ac VHT40 CH110 5550MHz	
1	Horizontal	Vertical
Peak Avg.	<p>Site : 03CH11-14Y Condition : PEAK(LINEI) 3m HORN 9120D-HF HORIZONTAL Detector : Peak Project : 881329-01</p>	<p>Site : 03CH11-14Y Condition : PEAK(LINEI) 3m HORN 9120D-HF VERTICAL Detector : Peak Project : 881329-01</p>

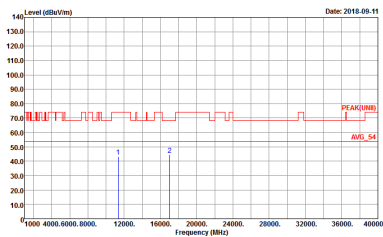
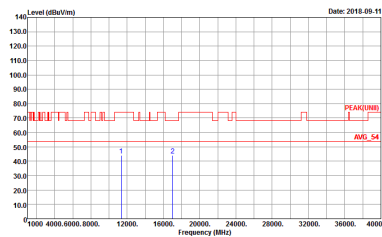

<b>WIFI</b>	<b>Band 3 5470~5725MHz Harmonic @ 3m</b>	
<b>ANT</b>	<b>802.11ac VHT40 CH134 5670MHz</b>	
<b>1</b>	<b>Horizontal</b>	<b>Vertical</b>
<p><b>Peak</b></p> <p><b>Avg.</b></p>	 <p>Site : 03CH11-14Y          Condition : PEAK(LINE) 3m HORN 9120D-HF HORIZONTAL          Detector : Peak          Project : 881329-01</p>	 <p>Site : 03CH11-14Y          Condition : PEAK(LINE) 3m HORN 9120D-HF VERTICAL          Detector : Peak          Project : 881329-01</p>



Band 3 5470~5725MHz
WIFI 802.11ac VHT80 (Harmonic @ 3m)

Table with 2 columns: Horizontal and Vertical. Each column contains a spectral plot showing Level (dBm/100MHz) vs Frequency (MHz) with peak and average markers. Includes site information like 03CHI1-HY and 881329-01.

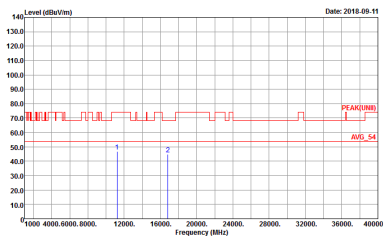
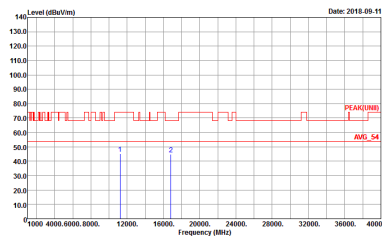

WIFI	Band 3 5470~5725MHz Harmonic @ 3m	
ANT	802.11ac VHT80 CH122 5610MHz	
1	Horizontal	Vertical
<p><b>Peak</b></p> <p><b>Avg.</b></p>	 <p>Site : 03CH11-14Y          Condition : PEAK(LINEI) 3m HORN 9120D-HF HORIZONTAL          Detector : Peak          Project : 881329-01</p>	 <p>Site : 03CH11-14Y          Condition : PEAK(LINEI) 3m HORN 9120D-HF VERTICAL          Detector : Peak          Project : 881329-01</p>



**Band 3 - Straddle Channel**  
**WIFI 802.11a (Fundamental @ 3m)**

WIFI	Band 3 Straddle Channel Fundamental @ 3m	
ANT	802.11a CH144 5720MHz	
1	Horizontal	Vertical
<p><b>Peak</b></p> <p><b>Avg.</b></p>	<p>Site : 03CH11-HY Condition : PEAK(LINE) 3m HORN 9120D-HF HORIZONTAL RBW:1000.000KHz VBW:3000.000KHz SWT:Auto Detector : Peak Project : 881329-01</p>	<p>Site : 03CH11-HY Condition : PEAK(LINE) 3m HORN 9120D-HF VERTICAL RBW:1000.000KHz VBW:3000.000KHz SWT:Auto Detector : Peak Project : 881329-01</p>





Band 3 – Straddle Channel
WIFI 802.11n HT20 (Fundamental @ 3m)

Table with 2 columns: WIFI, ANT. Row 1: Band 3 Straddle Channel Fundamental @ 3m. Row 2: 802.11n HT20 CH144 5720MHz. Row 3: 1, Horizontal, Vertical. Row 4: Peak Avg. (text), [Horizontal Graph], [Vertical Graph].



**Band 3 – Straddle Channel  
WIFI 802.11ac VHT40 (Fundamental @ 3m)**

WIFI	Band 3 Straddle Channel Fundamental @ 3m	
ANT	802.11ac VHT40 CH142 5710MHz	
1	Horizontal	Vertical
<b>Peak Avg.</b>	<p>Site : 03CHI1-HY Condition : PEAK(UNIT) 3m HORN 91200-HF HORIZONTAL RBW:1000.000KHz VBW:3000.000KHz SWT:Auto Detector : Peak Project : 881329-01</p>	<p>Site : 03CHI1-HY Condition : PEAK(UNIT) 3m HORN 91200-HF VERTICAL RBW:1000.000KHz VBW:3000.000KHz SWT:Auto Detector : Peak Project : 881329-01</p>



**Band 3 – Straddle Channel  
WIFI 802.11ac VHT80 (Fundamental @ 3m)**

WIFI	Band 3 Straddle Channel Fundamental @ 3m	
ANT	802.11ac VHT80 CH138 5690MHz	
1	Horizontal	Vertical
<b>Peak Avg.</b>	<p>Site : 03CHI1-HY Condition : PEAK(UNIT) 3m HORN 91200-HF HORIZONTAL RBW:1000.000KHz VBW:3000.000KHz SWT:Auto Detector : Peak Project : 881329-01</p>	<p>Site : 03CHI1-HY Condition : PEAK(UNIT) 3m HORN 91200-HF VERTICAL RBW:1000.000KHz VBW:3000.000KHz SWT:Auto Detector : Peak Project : 881329-01</p>



**Band 3 - Straddle Channel**  
**WIFI 802.11a (Harmonic @ 3m)**

WIFI	Band 3 Straddle Channel Harmonic @ 3m	
ANT	802.11a CH144 5720MHz	
1	Horizontal	Vertical
<p><b>Peak</b></p> <p><b>Avg.</b></p>	<p>Site : 03CH11-HY            Condition : PEAK(UMB) 3m HORN 9120D-HF HORIZONTAL            Detector : Peak            Project : 881329-01</p>	<p>Site : 03CH11-HY            Condition : PEAK(UMB) 3m HORN 9120D-HF VERTICAL            Detector : Peak            Project : 881329-01</p>



Band 3 – Straddle Channel
WIFI 802.11n HT20 (Harmonic @ 3m)

Table with 3 columns: WIFI, ANT, and test results for Horizontal and Vertical orientations. Includes spectral plots and metadata like Site, Condition, Detector, and Project.

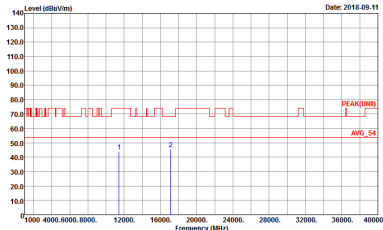
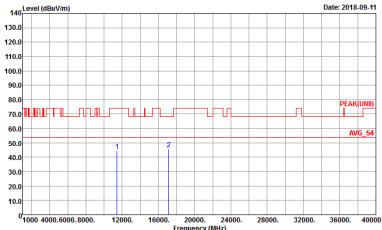

**Band 3 – Straddle Channel  
WIFI 802.11ac VHT40 (Harmonic @ 3m)**

WIFI	Band 3 Straddle Channel Harmonic @ 3m	
ANT	802.11ac VHT40 CH142 5710MHz	
1	Horizontal	Vertical
<p><b>Peak</b></p> <p><b>Avg.</b></p>	 <p>Site : 03CHI1-HY Condition : PEAK(UNII) 3m HORN 9120D-HF HORIZONTAL Detector : Peak Project : 881329-01</p>	 <p>Site : 03CHI1-HY Condition : PEAK(UNII) 3m HORN 9120D-HF VERTICAL Detector : Peak Project : 881329-01</p>



**Band 3 – Straddle Channel**  
**WIFI 802.11ac VHT80 (Harmonic @ 3m)**

WIFI	Band 3 Straddle Channel Harmonic @ 3m	
ANT	802.11ac VHT80 CH138 5690MHz	
1	Horizontal	Vertical
<p><b>Peak</b></p> <p><b>Avg.</b></p>	<p>Site : 03CHI1-HY            Condition : PEAK(UNII) 3m HORN 9120D-HF HORIZONTAL            Detector : Peak            Project : 881329-01</p>	<p>Site : 03CHI1-HY            Condition : PEAK(UNII) 3m HORN 9120D-HF VERTICAL            Detector : Peak            Project : 881329-01</p>



Emission below 1GHz  
5GHz WIFI 802.11a (LF)

WIFI	5GHz WIFI	
ANT	802.11a LF	
1	Horizontal	Vertical
QP / Peak	<p>Site : 03CH11-HY Condition : QP 3m 8E-LOG 6111D-LF_ETC HORIZONTAL Detector : Peak Project : 881329-01</p>	<p>Site : 03CH11-HY Condition : QP 3m 8E-LOG 6111D-LF_ETC VERTICAL Detector : Peak Project : 881329-01</p>





## Appendix E. Duty Cycle Plots

Band	Duty Cycle(%)	T(us)	1/T(kHz)	VBW Setting	Duty Factor(dB)
802.11a	97.12	2020	0.50	1kHz	0.13
5GHz 802.11n HT20	96.89	1870	0.53	1kHz	0.14
5GHz 802.11n HT40	95.88	930	1.08	3kHz	0.18
5GHz 802.11ac VHT20	96.94	1900	0.53	1kHz	0.13
5GHz 802.11ac VHT40	95.88	930	1.08	3kHz	0.18
5GHz 802.11ac VHT80	91.46	450	2.22	3kHz	0.39



802.11a

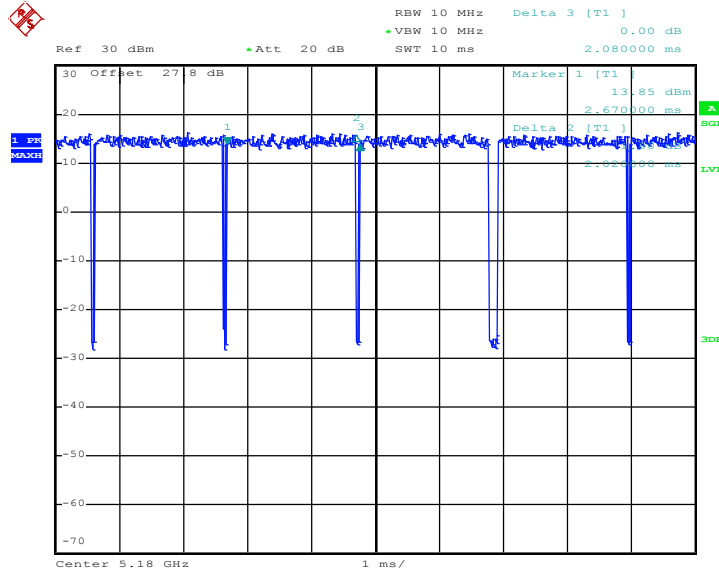

Date: 7.SEP.2018 17:58:46

802.11n HT20

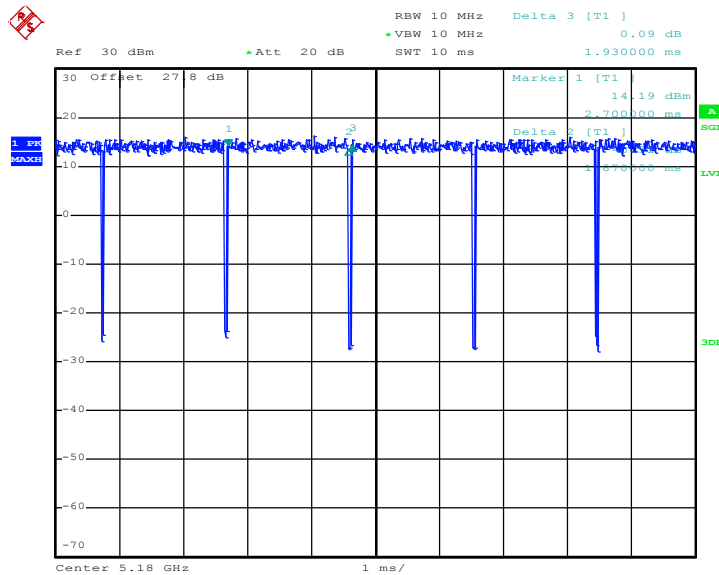

Date: 7.SEP.2018 18:00:42



802.11n HT40

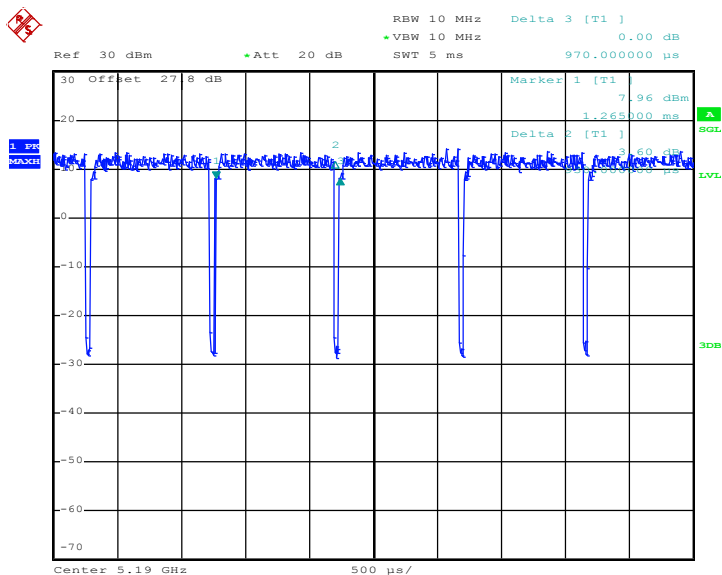

Date: 7.SEP.2018 18:02:17

802.11ac VHT20

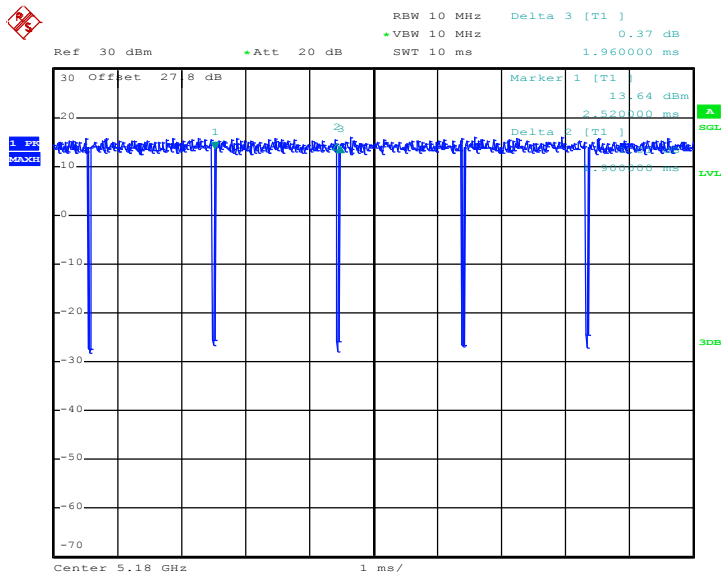

Date: 7.SEP.2018 18:03:55



802.11ac VHT40

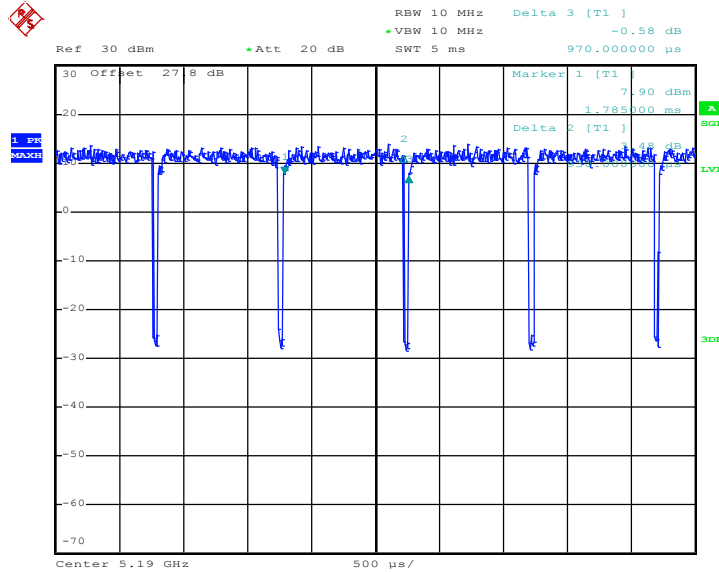

Date: 7.SEP.2018 18:05:38

802.11ac VHT80

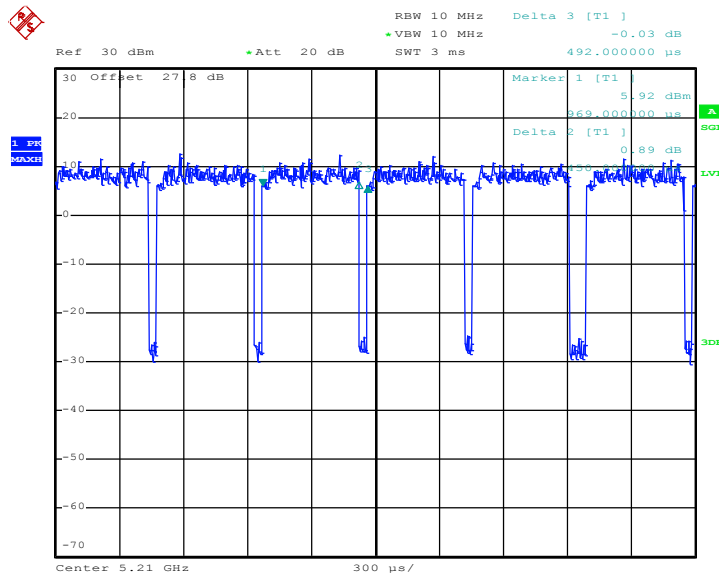

Date: 7.SEP.2018 18:07:51

————THE END————