



FCC RADIO TEST REPORT

FCC ID : PY7-61352Q
Equipment : Observer
Brand Name : Sony Mobile
Applicant : Sony Mobile Communications Inc.
4-12-3 Higashi-shinagawa, Shinagawa-ku,
Tokyo, 140-0002, Japan
Manufacturer : Sony Mobile Communications Inc.
4-12-3 Higashi-shinagawa, Shinagawa-ku,
Tokyo, 140-0002, Japan
Standard : FCC Part 15 Subpart C §15.247

The product was received on Jan. 08, 2018 and testing was started from Jan. 17, 2018 and completed on Jun. 01, 2018. We, SPORTON INTERNATIONAL INC., would like to declare that the tested sample has been evaluated in accordance with the test procedures and has been in compliance with the applicable technical standards.

The report must not be used by the client to claim product certification, approval, or endorsement by TAF or any agency of government.

The test results in this report apply exclusively to the tested model / sample. Without written approval of SPORTON INTERNATIONAL INC. EMC & Wireless Communications Laboratory, the test report shall not be reproduced except in full.

Approved by: Jones Tsai

SPORTON INTERNATIONAL INC. EMC & Wireless Communications Laboratory

No. 52, Huaya 1st Rd., Guishan Dist., Taoyuan City, Taiwan (R.O.C.)



Table of Contents

History of this test report.....	3
Summary of Test Result.....	4
1 General Description.....	5
1.1 Product Feature of Equipment Under Test.....	5
1.2 Modification of EUT	5
1.3 Testing Location	6
1.4 Applicable Standards.....	6
2 Test Configuration of Equipment Under Test.....	7
2.1 Carrier Frequency Channel	7
2.2 Test Mode.....	8
2.3 Connection Diagram of Test System.....	9
2.4 Support Unit used in test configuration and system	9
2.5 EUT Operation Test Setup	10
2.6 Measurement Results Explanation Example.....	10
3 Test Result.....	11
3.1 6dB and 99% Bandwidth Measurement	11
3.2 Output Power Measurement.....	16
3.3 Power Spectral Density Measurement	17
3.4 Conducted Band Edges and Spurious Emission Measurement	22
3.5 Radiated Band Edges and Spurious Emission Measurement	27
3.6 AC Conducted Emission Measurement.....	31
3.7 Antenna Requirements.....	33
4 List of Measuring Equipment	34
5 Uncertainty of Evaluation	36
Appendix A. Conducted Test Results	
Appendix B. AC Conducted Emission Test Result	
Appendix C. Radiated Spurious Emission	
Appendix D. Radiated Spurious Emission Plots	
Appendix E. Duty Cycle Plots	



History of this test report

Report No.	Version	Description	Issued Date
FR6D2013-01A	01	Initial issue of report	Jun. 21, 2018
FR6D2013-01A	02	1. Revising the description in section 2.2. 2. Revising the connection diagram in 2.3. 3. Revising the measuring equipment in section 4.	Aug. 03, 2018
FR6D2013-01A	03	1. Revising test data in this report. 2. Revising the connection diagram in 2.3.	Aug. 08, 2018



Summary of Test Result

Report Clause	Ref Std. Clause	Test Items	Result (PASS/FAIL)	Remark
3.1	15.247(a)(2)	6dB Bandwidth	Pass	-
3.1	2.1049	99% Occupied Bandwidth	Reporting only	-
3.2	15.247(b)(3)	Peak Output Power	Pass	-
3.3	15.247(e)	Power Spectral Density	Pass	-
3.4	15.247(d)	Conducted Band Edges and Spurious Emission	Pass	-
3.5	15.247(d)	Radiated Band Edges and Spurious Emission	Pass	Under limit 3.38 dB at 45.660 MHz
3.6	15.207	AC Conducted Emission	Pass	Under limit 18.30 dB at 0.150 MHz
3.7	15.203 & 15.247(b)	Antenna Requirement	Pass	-

Reviewed by: Joseph Lin

Report Producer: Nancy Yang



1 General Description

1.1 Product Feature of Equipment Under Test

Bluetooth, and DTS/UNII b/g/n

Standards-related Product Specification	
Antenna Type / Gain	Chip Antenna type with gain 2.5 dBi

EUT Information List		
HW Version	SW Version	Performed Test Item
A	1.0	RF conducted measurement
		Radiated Spurious Emission
		Conducted Emission

Accessory Information List			
	Model No.	S/N	Performed Test Item
AC adapter	UH20	3515W34406073	Radiated Spurious Emission
			Conducted Emission

Note:

1. Above EUT list used are electrically identical per declared by manufacturer.
2. Above the accessories list are used to exercise the EUT during test, and the serial number of each type of accessories is listed in each section of this report.
3. For other wireless features of this EUT, test report will be issued separately.

1.2 Modification of EUT

No modifications are made to the EUT during all test items.



1.3 Testing Location

Sporton Lab is accredited to ISO 17025 by Taiwan Accreditation Foundation (TAF code : 1190) and the FCC designation No. TW1190 and TW0007 under the FCC 2.948(e) by Mutual Recognition Agreement (MRA) in FCC Test.

Test Site	SPORTON INTERNATIONAL INC.	
Test Site Location	No.52, Huaya 1st Rd., Guishan Dist., Taoyuan City, Taiwan (R.O.C.) TEL: +886-3-327-3456 FAX: +886-3-328-4978	
Test Site No.	Sporton Site No.	
	TH05-HY	CO05-HY

Note: The test site complies with ANSI C63.4 2014 requirement.

Test Site	SPORTON INTERNATIONAL INC.	
Test Site Location	No.58, Aly. 75, Ln. 564, Wenhua 3rd, Rd., Guishan Dist., Taoyuan City, Taiwan (R.O.C.) TEL: +886-3-327-0868 FAX: +886-3-327-0855	
Test Site No.	Sporton Site No.	
	03CH11-HY	

Note: The test site complies with ANSI C63.4 2014 requirement.

1.4 Applicable Standards

According to the specifications of the manufacturer, the EUT must comply with the requirements of the following standards:

- ♦ FCC Part 15 Subpart C §15.247
- ♦ FCC KDB Publication No. 558074 D01 DTS Meas. Guidance v04
- ♦ ANSI C63.10-2013

Remark:

1. All test items were verified and recorded according to the standards and without any deviation during the test.
2. This EUT has also been tested and complied with the requirements of FCC Part 15, Subpart B, recorded in a separate test report.



2 Test Configuration of Equipment Under Test

2.1 Carrier Frequency Channel

Frequency Band	Channel	Freq. (MHz)	Channel	Freq. (MHz)
2400-2483.5 MHz	0	2402	21	2444
	1	2404	22	2446
	2	2406	23	2448
	3	2408	24	2450
	4	2410	25	2452
	5	2412	26	2454
	6	2414	27	2456
	7	2416	28	2458
	8	2418	29	2460
	9	2420	30	2462
	10	2422	31	2464
	11	2424	32	2466
	12	2426	33	2468
	13	2428	34	2470
	14	2430	35	2472
	15	2432	36	2474
	16	2434	37	2476
	17	2436	38	2478
	18	2438	39	2480
	19	2440	-	-
20	2442	-	-	



2.2 Test Mode

- a. The EUT has been associated with peripherals and configuration operated in a manner tended to maximize its emission characteristics in a typical application. Frequency range investigated: conduction emission (150 kHz to 30 MHz), radiation emission (9 kHz to the 10th harmonic of the highest fundamental frequency or to 40 GHz, whichever is lower). For radiated measurement, pre-scanned in three orthogonal panels, X, Y, Z. The worst cases (X plane) were recorded in this report.

- b. AC power line Conducted Emission was tested under maximum output power.

The following summary table is showing all test modes to demonstrate in compliance with the standard.

Summary table of Test Cases	
Test Item	Data Rate / Modulation
	Bluetooth – LE / GFSK
Conducted Test Cases	Mode 1: Bluetooth Tx CH00_2402 MHz_1Mbps Mode 2: Bluetooth Tx CH19_2440 MHz_1Mbps Mode 3: Bluetooth Tx CH39_2480 MHz_1Mbps
Radiated Test Cases	Mode 1: Bluetooth Tx CH00_2402 MHz_1Mbps Mode 2: Bluetooth Tx CH19_2440 MHz_1Mbps Mode 3: Bluetooth Tx CH39_2480 MHz_1Mbps
AC Conducted Emission	Mode 1: EUT Charging + WLAN Idle + Bluetooth On

2.3 Connection Diagram of Test System

< Bluetooth - LE Tx Mode >

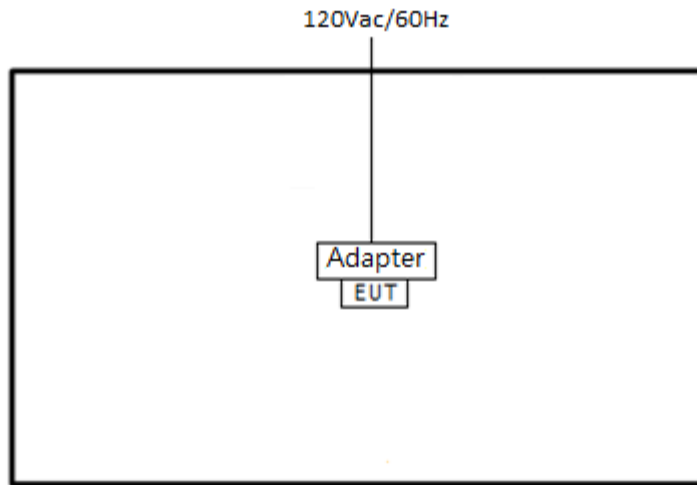

<AC Conducted Emissions Mode >



2.4 Support Unit used in test configuration and system

Item	Equipment	Trade Name	Model Name	FCC ID	Data Cable	Power Cord
1.	WLAN AP	ASUS	RT-AC66U	MSQ-RTAC66U	N/A	Unshielded, 1.8m
2.	Bluetooth Tag	Sony	D52.1	PY7-32042C	N/A	N/A



2.5 EUT Operation Test Setup

The RF test items, utility “Putty” was installed in Notebook which was programmed in order to make the EUT get into the engineering modes to provide channel selection, power level, data rate and the application type and for continuous transmitting signals.

2.6 Measurement Results Explanation Example

For all conducted test items:

The offset level is set in the spectrum analyzer to compensate the RF cable loss and attenuator factor between EUT conducted output port and spectrum analyzer. With the offset compensation, the spectrum analyzer reading level is exactly the EUT RF output level.

Example :

The spectrum analyzer offset is derived from RF cable loss and attenuator factor.

Offset = RF cable loss + attenuator factor.

Following shows an offset computation example with cable loss 4.2 dB and 10dB attenuator.

$$\begin{aligned} \text{Offset(dB)} &= \text{RF cable loss(dB)} + \text{attenuator factor(dB)}. \\ &= 4.2 + 10 = 14.2 \text{ (dB)} \end{aligned}$$

3 Test Result

3.1 6dB and 99% Bandwidth Measurement

3.1.1 Limit of 6dB and 99% Bandwidth

The minimum 6 dB bandwidth shall be at least 500 kHz.

3.1.2 Measuring Instruments

See list of measuring equipment of this test report.

3.1.3 Test Procedures

1. The testing follows FCC KDB Publication No. 558074 D01 DTS Meas. Guidance v04.
2. The RF output of EUT was connected to the spectrum analyzer by RF cable and attenuator. The path loss was compensated to the results for each measurement.
3. Set to the maximum power setting and enable the EUT transmit continuously.
4. Make the measurement with the spectrum analyzer's resolution bandwidth (RBW) = 100 kHz. Set the Video bandwidth (VBW) = 300 kHz. In order to make an accurate measurement. The 6 dB bandwidth must be greater than 500 kHz.
5. For 99% Bandwidth Measurement, the spectrum analyzer's resolution bandwidth (RBW) is set 30kHz and set the Video bandwidth (VBW) = 100kHz.
6. Measure and record the results in the test report.

3.1.4 Test Setup





3.1.5 Test Result of 6dB Bandwidth

Please refer to Appendix A.

6 dB Bandwidth Plot on Channel 00

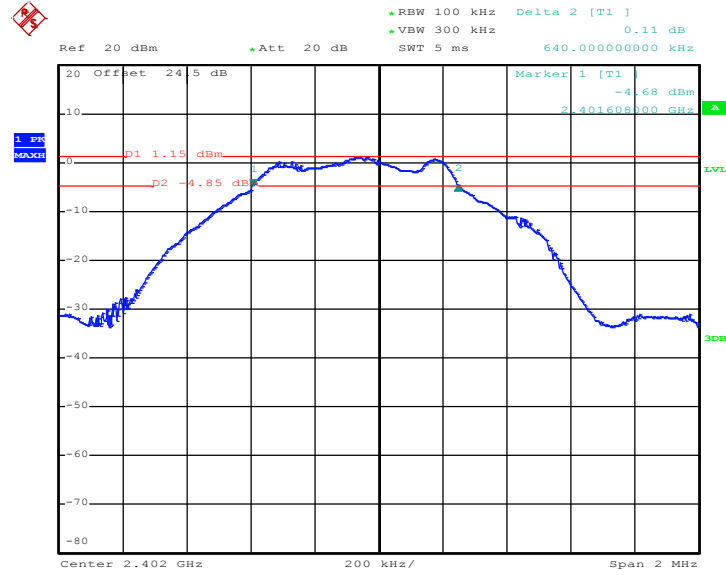

Date: 7.JUN.2018 00:45:25

6 dB Bandwidth Plot on Channel 19

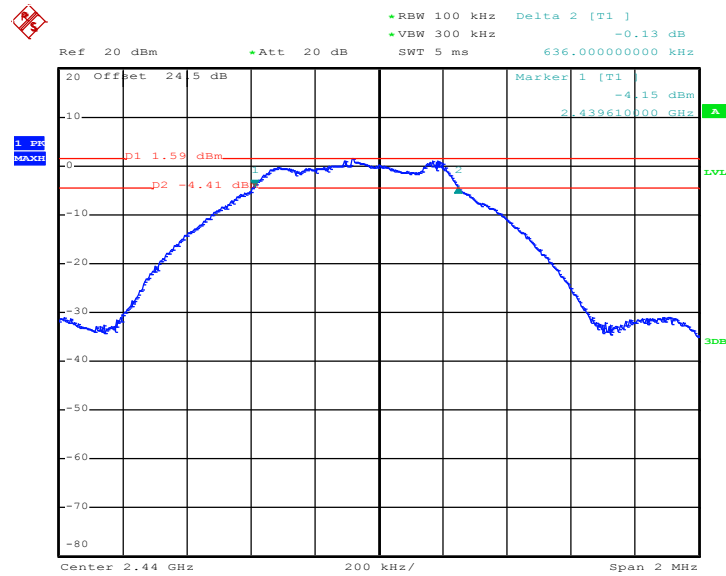

Date: 7.JUN.2018 01:07:22



6 dB Bandwidth Plot on Channel 39

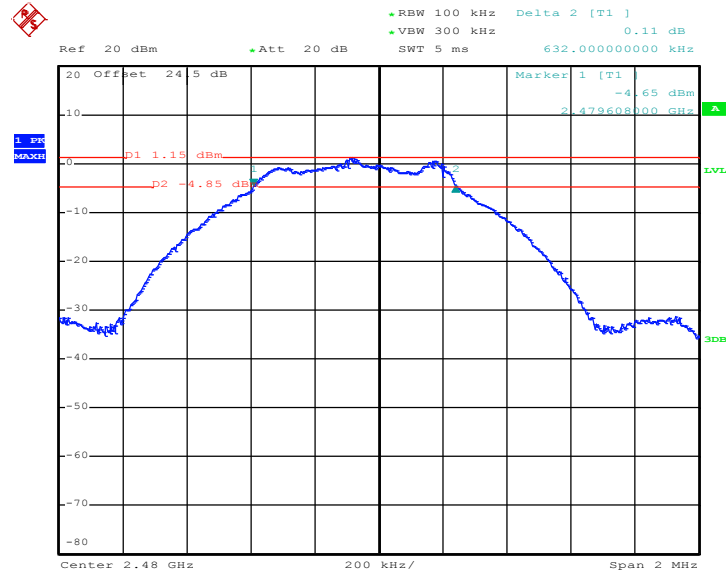

Date: 7.JUN.2018 01:13:21



3.1.6 Test Result of 99% Occupied Bandwidth

Please refer to Appendix A.

99% Bandwidth Plot on Channel 00

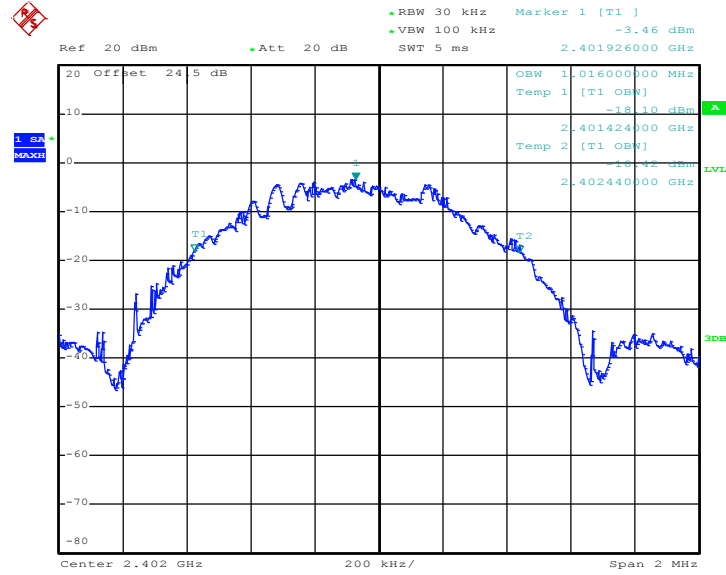

Date: 7. JUN.2018 01:05:40

99% Occupied Bandwidth Plot on Channel 19

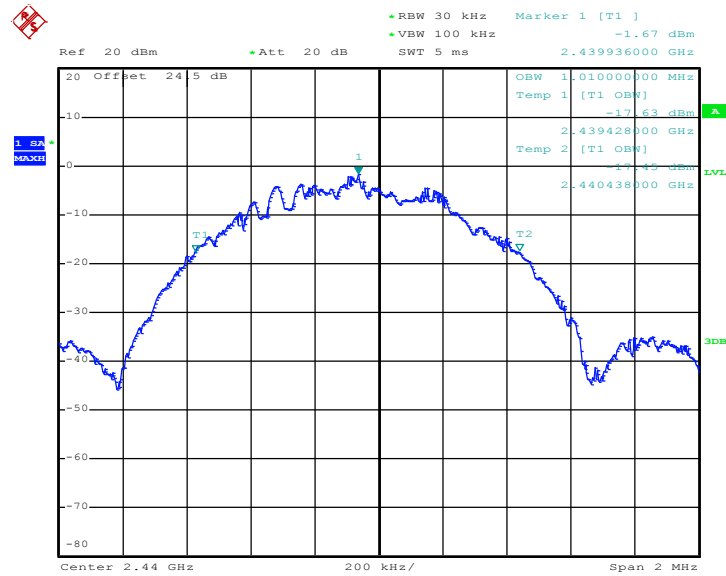

Date: 7. JUN.2018 01:11:48



99% Occupied Bandwidth Plot on Channel 39

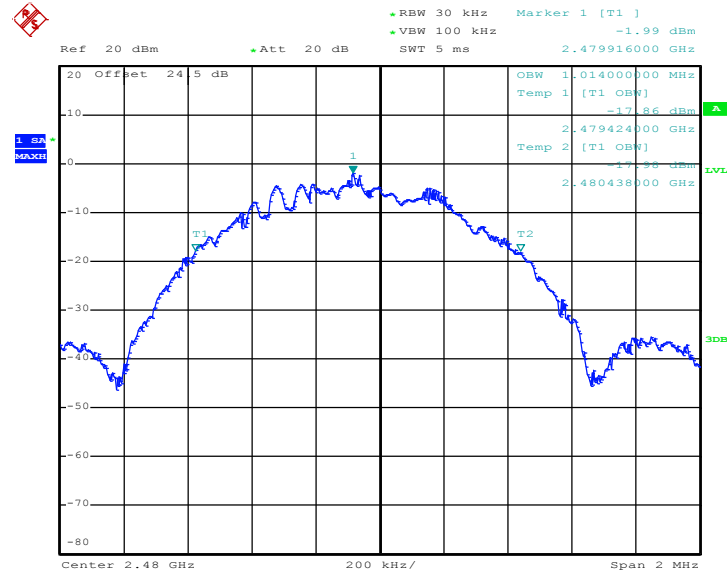

Date : 7.JUN.2018 01:15:28

Note : The occupied channel bandwidth is maintained within the band of operation for all of the modulations.

3.2 Output Power Measurement

3.2.1 Limit of Output Power

For systems using digital modulation in the 2400-2483.5MHz, the limit for peak output power is 30dBm. If transmitting antenna of directional gain greater than 6dBi is used, the peak output power from the intentional radiator shall be reduced below the above stated value by the amount in dB that the directional gain of the antenna exceeds 6 dBi. In case of point-to-point operation, the limit has to be reduced by 1dB for every 3dB that the directional gain of the antenna exceeds 6dBi.

3.2.2 Measuring Instruments

See list of measuring equipment of this test report.

3.2.3 Test Procedures

1. For Peak Power, the testing follows the Measurement Procedure of FCC KDB No. 558074 DTS D01 Meas. Guidance v04 section 9.1.3 PKPM1 Peak power meter method.
2. For Average Power, the testing follows the Measurement Procedure of FCC KDB No. 558074 DTS D01 Meas. Guidance v04 section 9.2.3.2 Method AVGPM-G.
3. The RF output of EUT was connected to the power meter by RF cable and attenuator. The path loss was compensated to the results for each measurement.
4. Set to the maximum power setting and enable the EUT transmit continuously.
5. Measure the conducted output power and record the results in the test report.

3.2.4 Test Setup

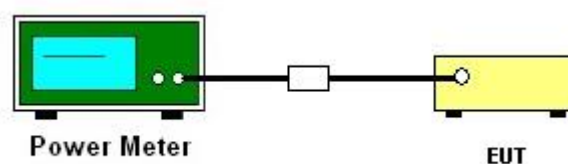

3.2.5 Test Result of Peak Output Power

Please refer to Appendix A.

3.2.6 Test Result of Average Output Power (Reporting Only)

Please refer to Appendix A.

3.3 Power Spectral Density Measurement

3.3.1 Limit of Power Spectral Density

The peak power spectral density shall not be greater than 8dBm in any 3kHz band at any time interval of continuous transmission.

3.3.2 Measuring Instruments

See list of measuring equipment of this test report.

3.3.3 Test Procedures

1. The testing follows Measurement Procedure 10.2 Method PKPSD of FCC KDB Publication No. 558074 D01 DTS Meas. Guidance v04
2. The RF output of EUT was connected to the spectrum analyzer by RF cable and attenuator. The path loss was compensated to the results for each measurement.
3. Set to the maximum power setting and enable the EUT transmit continuously.
4. Make the measurement with the spectrum analyzer's resolution bandwidth (RBW) = 3 kHz. Video bandwidth VBW = 10 kHz In order to make an accurate measurement, set the span to 1.5 times DTS Channel Bandwidth. (6dB BW)
5. Detector = peak, Sweep time = auto couple, Trace mode = max hold, Allow trace to fully stabilize. Use the peak marker function to determine the maximum power level.
6. Measure and record the results in the test report.
7. The Measured power density (dBm)/ 100kHz is a reference level and used as 20dBc down limit line for Conducted Band Edges and Conducted Spurious Emission.

3.3.4 Test Setup

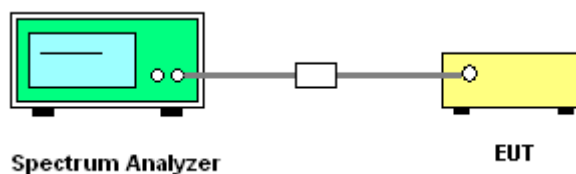

3.3.5 Test Result of Power Spectral Density

Please refer to Appendix A.



3.3.6 Test Result of Power Spectral Density Plots (100kHz)

PSD 100kHz Plot on Channel 00

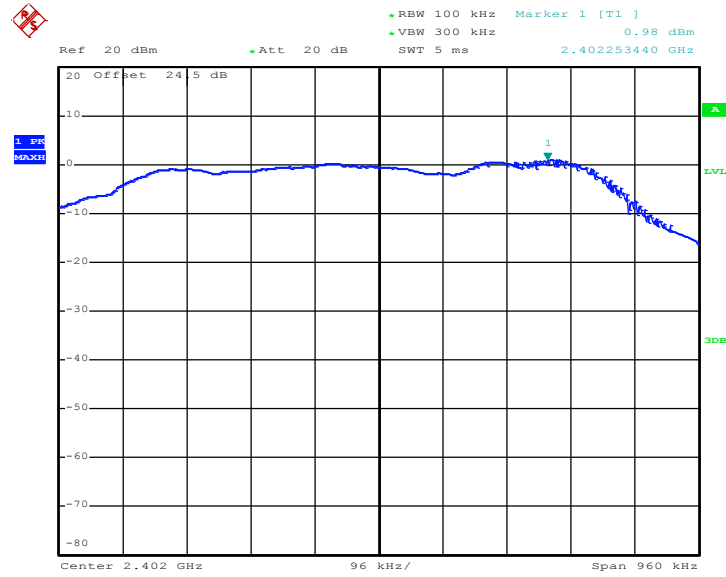

Date: 7.JUN.2018 00:55:33

PSD 100kHz Plot on Channel 19

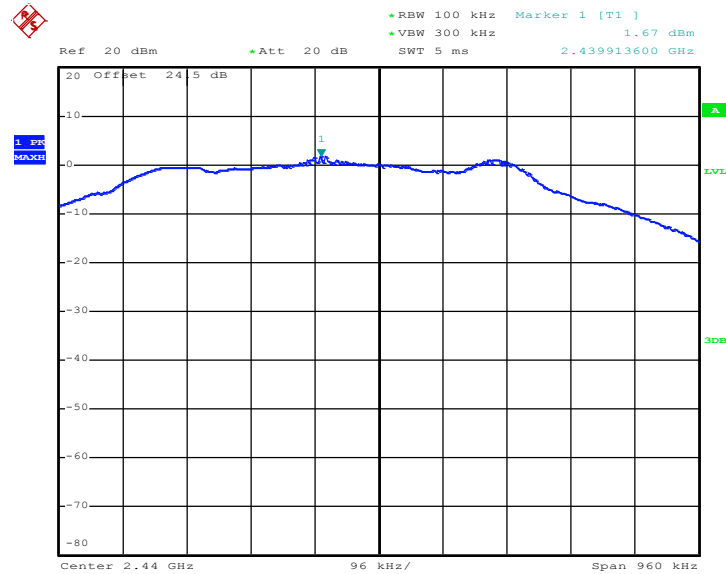

Date: 7.JUN.2018 01:08:07



PSD 100kHz Plot on Channel 39

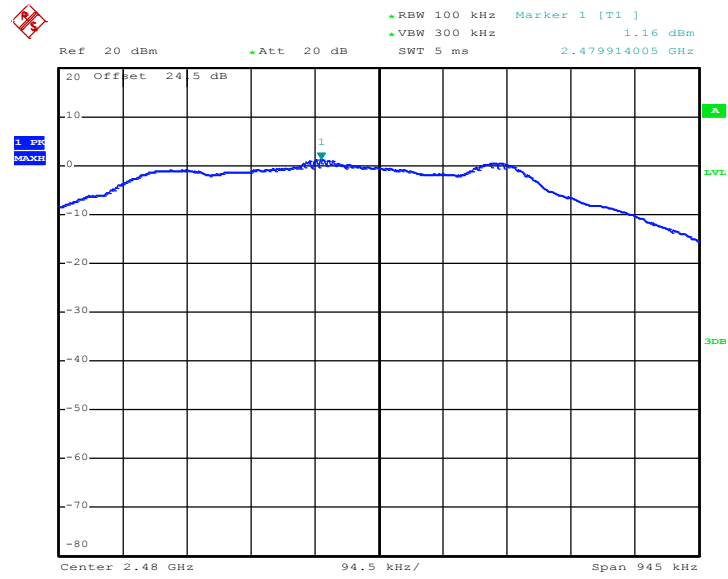

Date: 7.JUN.2018 01:14:17



3.3.7 Test Result of Power Spectral Density Plots (3kHz)

PSD 3kHz Plot on Channel 00

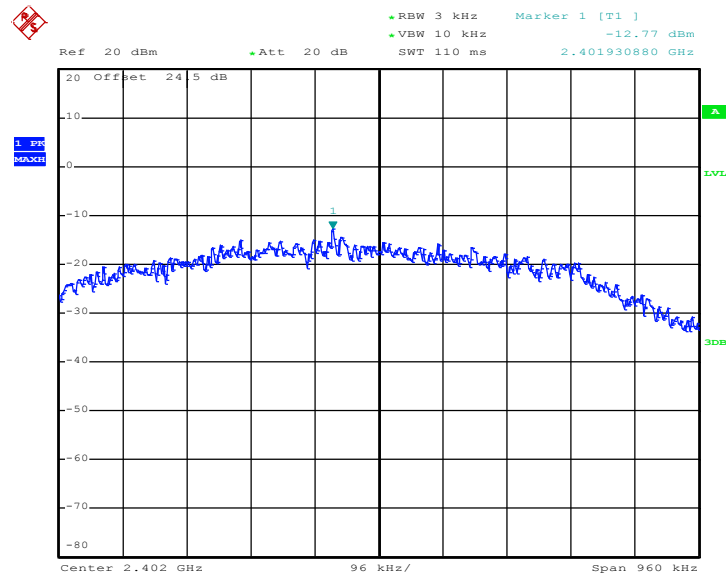

Date: 7.JUN.2018 00:54:52

PSD 3kHz Plot on Channel 19

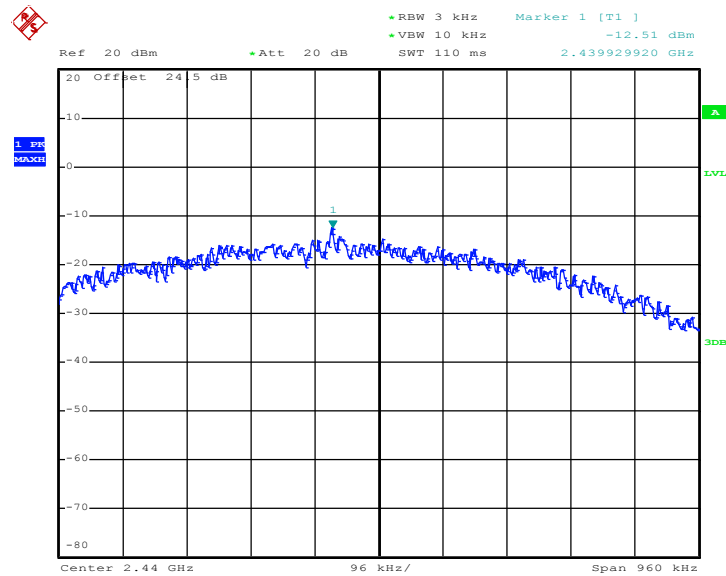

Date: 7.JUN.2018 01:07:53



PSD 3kHz Plot on Channel 39

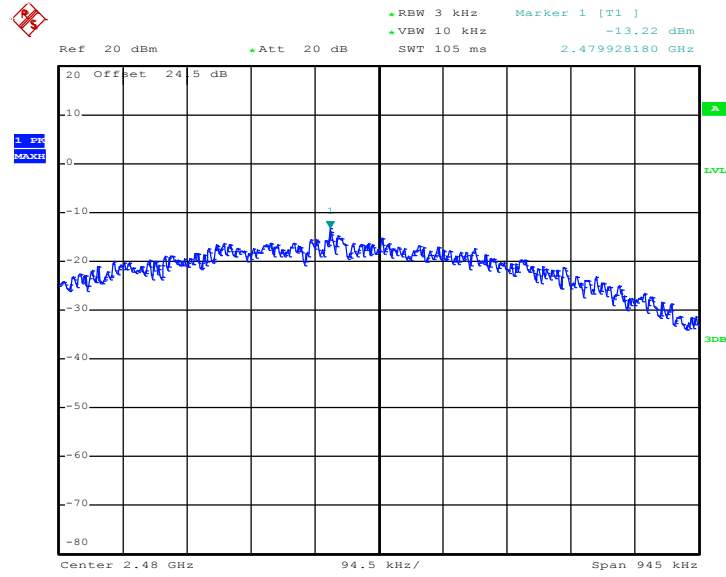

Date: 7.JUN.2018 01:14:00

3.4 Conducted Band Edges and Spurious Emission Measurement

3.4.1 Limit of Conducted Band Edges and Spurious Emission

All harmonics/spurious must be at least 20 dB down from the highest emission level within the authorized band.

3.4.2 Measuring Instruments

See list of measuring equipment of this test report.

3.4.3 Test Procedure

1. The testing follows FCC KDB Publication No. 558074 D01 DTS Meas. Guidance v04
2. The RF output of EUT was connected to the spectrum analyzer by RF cable and attenuator. The path loss was compensated to the results for each measurement.
3. Set to the maximum power setting and enable the EUT transmit continuously.
4. Set RBW = 100 kHz, VBW=300 kHz, Peak Detector. Unwanted Emissions measured in any 100 kHz bandwidth outside of the authorized frequency band shall be attenuated by at least 20 dB relative to the maximum in-band peak PSD level in 100 kHz when maximum peak conducted output power procedure is used. If the transmitter complies with the conducted power limits based on the use of RMS averaging over a time interval, the attenuation required under this paragraph shall be 30 dB instead of 20 dB.
5. Measure and record the results in the test report.
6. The RF fundamental frequency should be excluded against the limit line in the operating frequency band.

3.4.4 Test Setup





3.4.5 Test Result of Conducted Band Edges Plots

Low Band Edge Plot on Channel 00

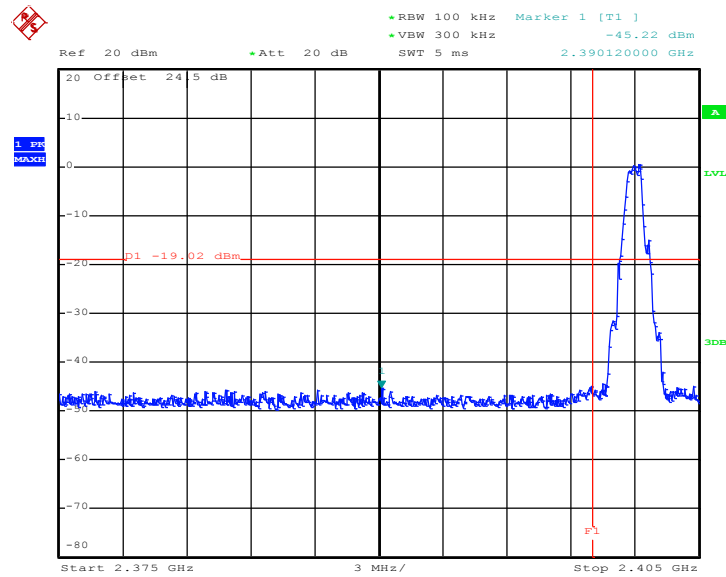

Date: 7.JUN.2018 00:55:59

High Band Edge Plot on Channel 39

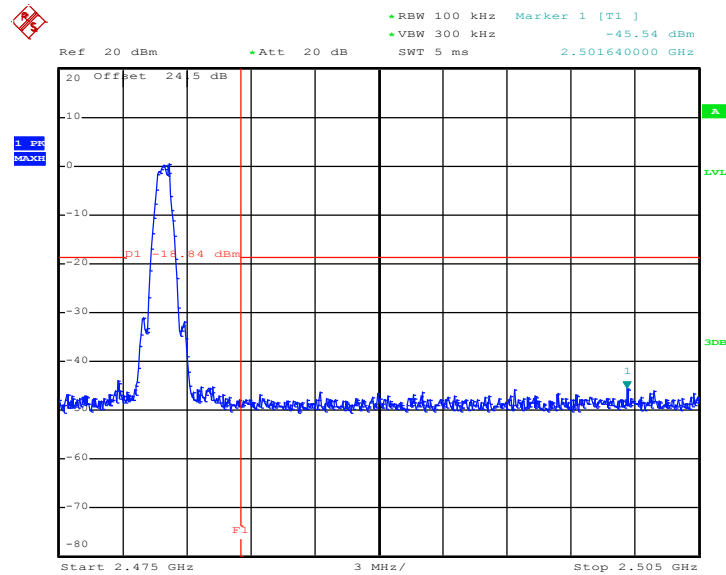

Date: 7.JUN.2018 01:14:43



3.4.6 Test Result of Conducted Spurious Emission Plots

Conducted Spurious Emission Plot on Bluetooth LE 1Mbps GFSK Channel 00

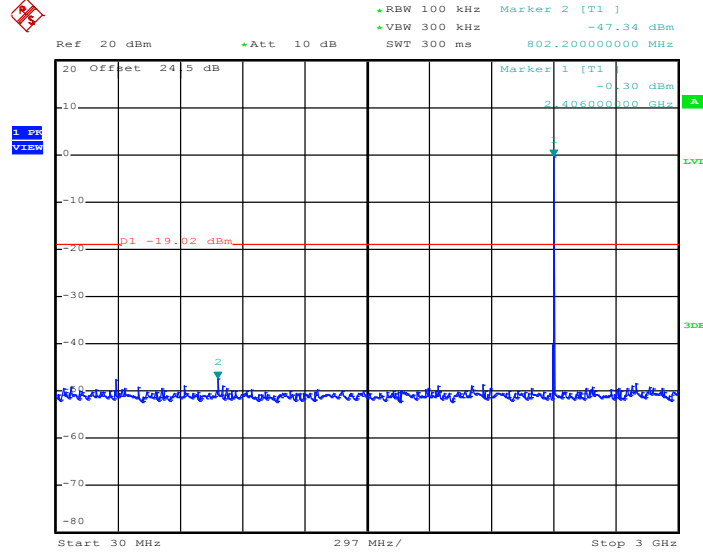

Date: 7.JUN.2018 00:56:37

Conducted Spurious Emission Plot on Bluetooth LE 1Mbps GFSK Channel 00

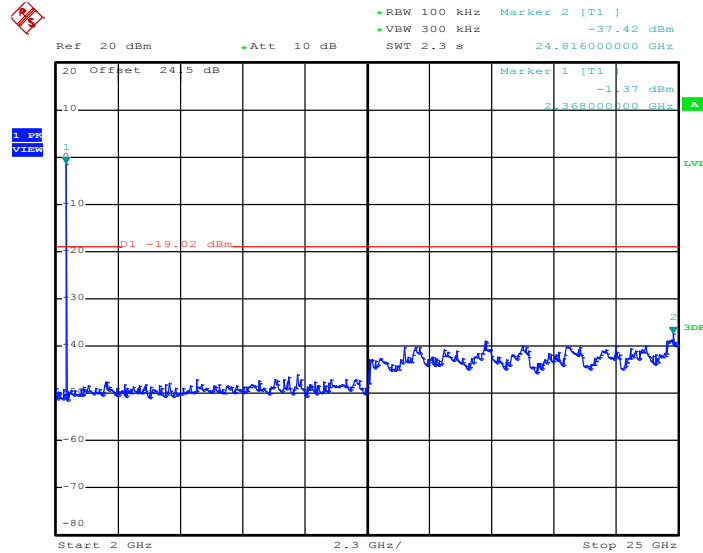

Date: 7.JUN.2018 00:56:54



Conducted Spurious Emission Plot on Bluetooth LE 1Mbps GFSK Channel 19

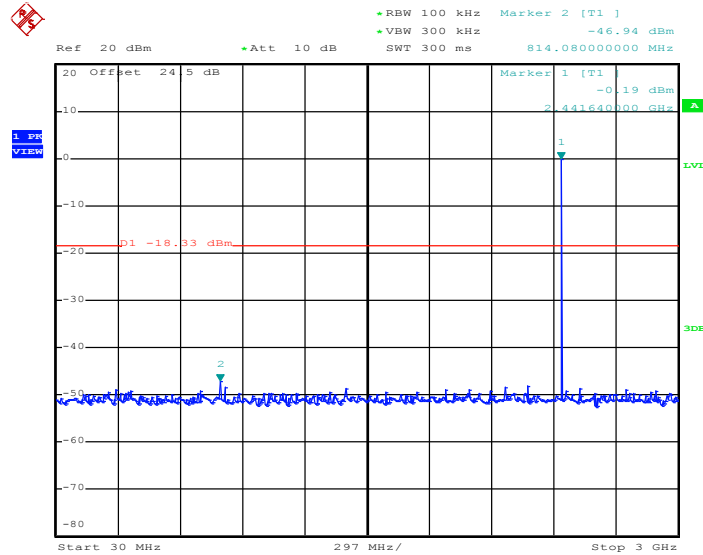

Date: 7.JUN.2018 01:08:31

Conducted Spurious Emission Plot on Bluetooth LE 1Mbps GFSK Channel 19

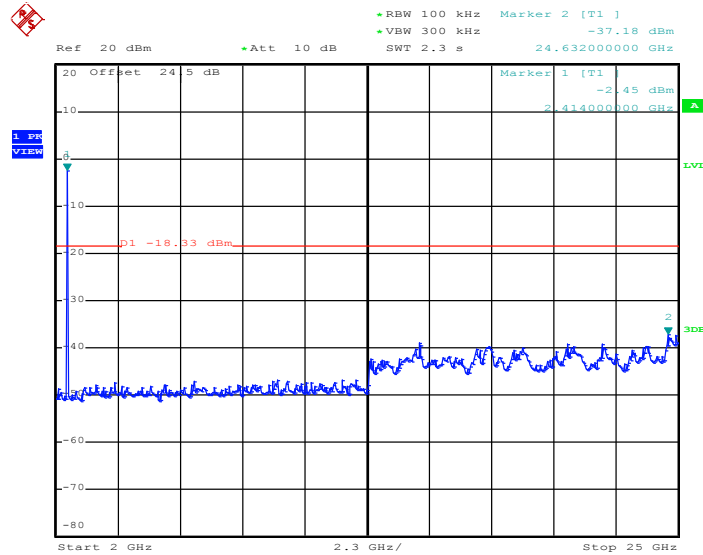

Date: 7.JUN.2018 01:11:34



Conducted Spurious Emission Plot on Bluetooth LE 1Mbps GFSK Channel 39

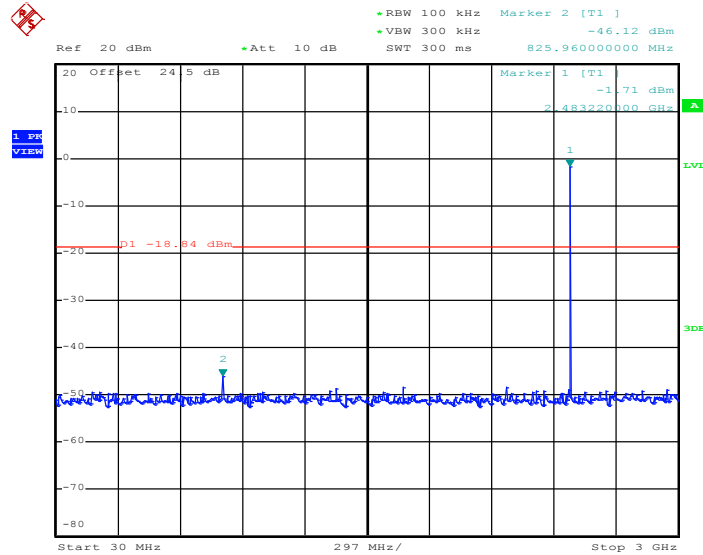

Date: 7.JUN.2018 01:14:59

Conducted Spurious Emission Plot on Bluetooth LE 1Mbps GFSK Channel 39

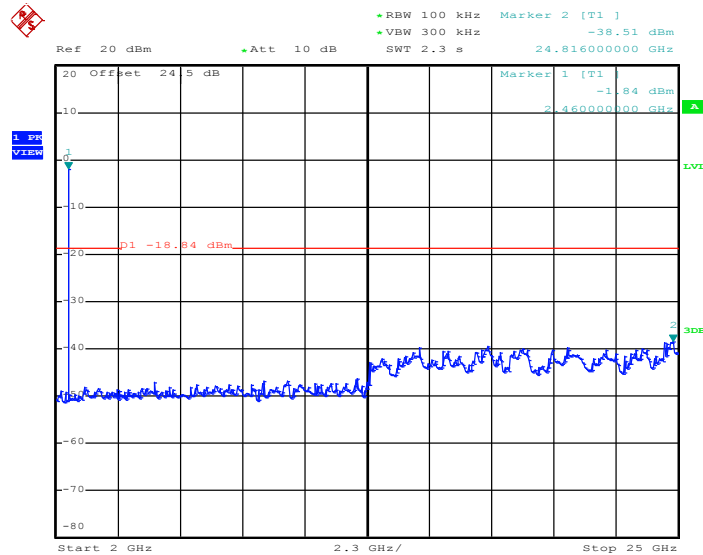

Date: 7.JUN.2018 01:15:14



3.5 Radiated Band Edges and Spurious Emission Measurement

3.5.1 Limit of Radiated Band Edges and Spurious Emission

In any 100 kHz bandwidth outside the intentional radiator frequency band, all harmonics/spurious must be at least 20 dB below the highest emission level within the authorized band. If the output power of this device was measured by spectrum analyzer, the attenuation under this paragraph shall be 30 dB instead of 20 dB. In addition, radiated emissions which fall in the restricted bands must also comply with the limits as below.

Frequency (MHz)	Field Strength (microvolts/meter)	Measurement Distance (meters)
0.009 – 0.490	2400/F(kHz)	300
0.490 – 1.705	24000/F(kHz)	30
1.705 – 30.0	30	30
30 – 88	100	3
88 – 216	150	3
216 - 960	200	3
Above 960	500	3

3.5.2 Measuring Instruments

See list of measuring equipment of this test report.

**3.5.3 Test Procedures**

1. The testing follows FCC KDB Publication No. 558074 D01 DTS Meas. Guidance v04
2. The EUT was arranged to its worst case and then tune the antenna tower (from 1 m to 4 m) and turntable (from 0 degree to 360 degrees) to find the maximum reading. A pre-amp and a high pass filter are used for the test in order to get better signal level.
3. The EUT was placed on a turntable with 0.8 meter for frequency below 1GHz and 1.5 meter for frequency above 1GHz respectively above ground.
4. The EUT was set 3 meters from the interference receiving antenna, which was mounted on the top of a variable height antenna tower.
5. Corrected Reading: Antenna Factor + Cable Loss + Read Level - Preamp Factor = Level
6. For testing below 1GHz, if the emission level of the EUT in peak mode was 3 dB lower than the limit specified, then peak values of EUT will be reported, otherwise, the emissions will be repeated one by one using the CISPR quasi-peak method and reported.
7. For testing above 1GHz, the emission level of the EUT in peak mode was 20dB lower than average limit (that means the emission level in average mode also complies with the limit in average mode), then peak values of EUT will be reported, otherwise, the emissions will be measured in average mode again and reported.
8. Use the following spectrum analyzer settings:
 - (1) Span shall wide enough to fully capture the emission being measured;
 - (2) Set RBW=100 kHz for $f < 1$ GHz; $VBW \geq RBW$; Sweep = auto; Detector function = peak; Trace = max hold;
 - (3) Set RBW = 1 MHz, VBW= 3MHz for $f \geq 1$ GHz for peak measurement.
For average measurement:
 - $VBW = 10$ Hz, when duty cycle is no less than 98 percent.
 - $VBW \geq 1/T$, when duty cycle is less than 98 percent where T is the minimum transmission duration over which the transmitter is on and is transmitting at its maximum power control level for the tested mode of operation.

3.5.4 Test Setup

For radiated emissions below 30MHz

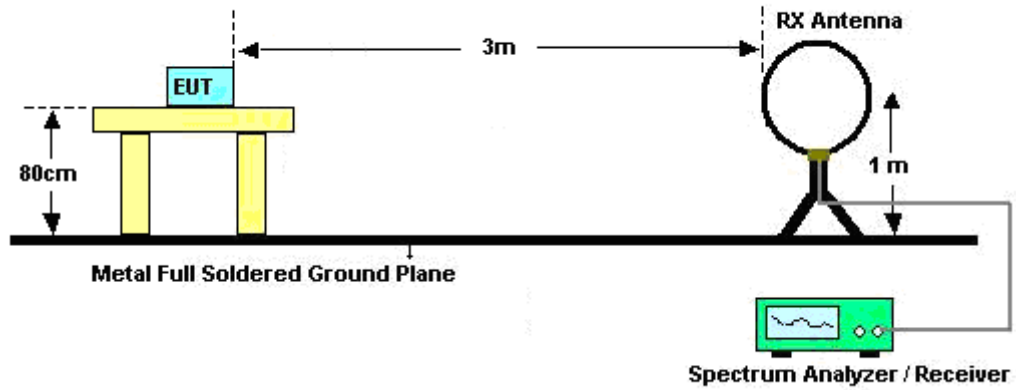

For radiated emissions from 30MHz to 1GHz

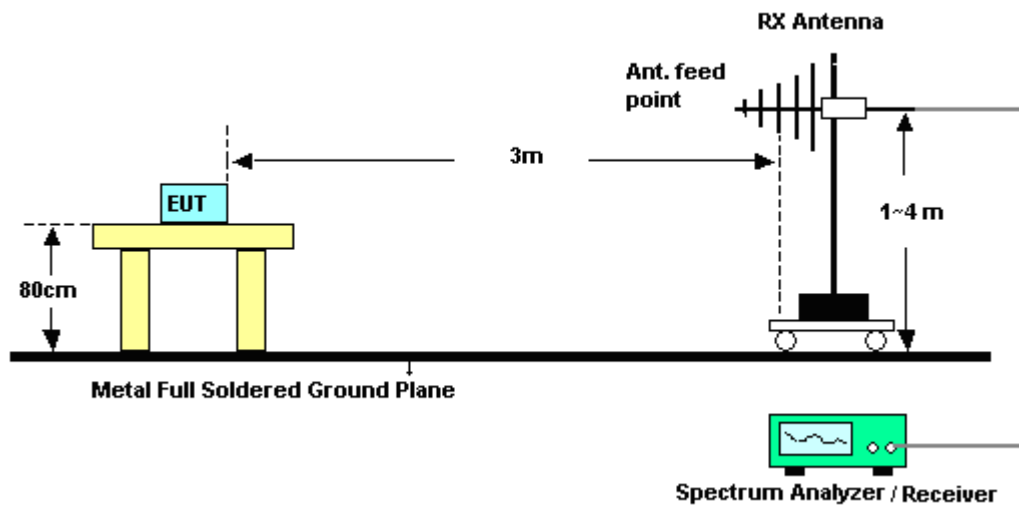

For radiated emissions above 1GHz

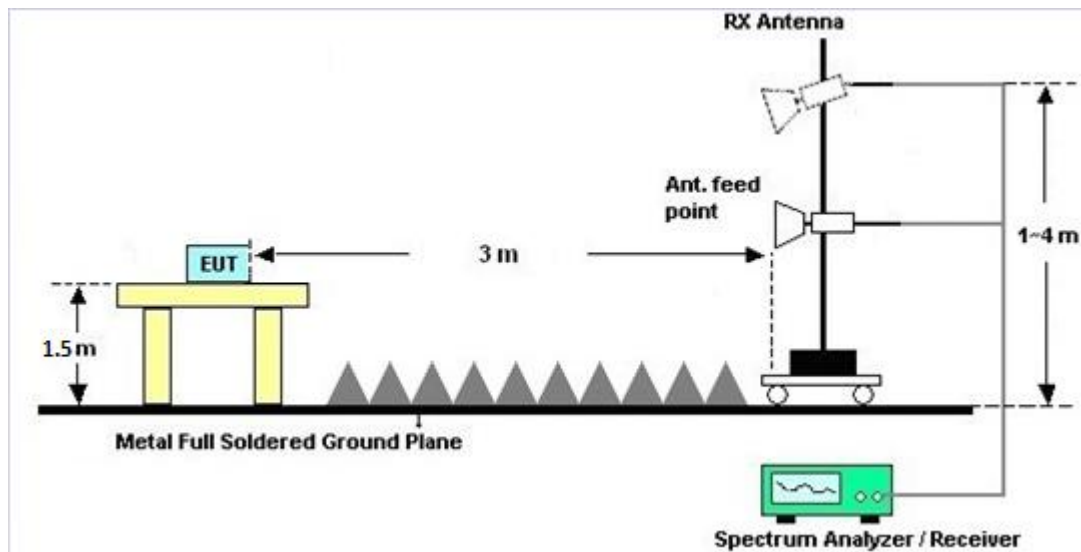

3.5.5 Test Results of Radiated Spurious Emissions (9 kHz ~ 30 MHz)

The low frequency, which started from 9 kHz to 30MHz, was pre-scanned and the result which was 20dB lower than the limit line was not reported.

There is a comparison data of both open-field test site and semi-Anechoic chamber, and the result came out very similar.

3.5.6 Test Result of Radiated Spurious at Band Edges

Please refer to Appendix C and D.

3.5.7 Duty Cycle

Please refer to Appendix E.

3.5.8 Test Result of Radiated Spurious Emission (30MHz ~ 10th Harmonic)

Please refer to Appendix C and D.



3.6 AC Conducted Emission Measurement

3.6.1 Limit of AC Conducted Emission

For equipment that is designed to be connected to the public utility (AC) power line, the radio frequency voltage that is conducted back onto the AC power line on any frequency or frequencies within the band 150 kHz to 30 MHz shall not exceed the limits in the following table.

Frequency of emission (MHz)	Conducted limit (dB μ V)	
	Quasi-peak	Average
0.15-0.5	66 to 56*	56 to 46*
0.5-5	56	46
5-30	60	50

*Decreases with the logarithm of the frequency.

3.6.2 Measuring Instruments

See list of measuring equipment of this test report.

3.6.3 Test Procedures

1. The EUT was placed 0.4 meter from the conducting wall of the shielding room was kept at least 80 centimeters from any other grounded conducting surface.
2. Connect EUT to the power mains through a line impedance stabilization network (LISN).
3. All the support units are connecting to the other LISN.
4. The LISN provides 50 ohm coupling impedance for the measuring instrument.
5. The FCC states that a 50 ohm, 50 microhenry LISN should be used.
6. Both sides of AC line were checked for maximum conducted interference.
7. The frequency range from 150 kHz to 30 MHz was searched.
8. Set the test-receiver system to Peak Detect Function and specified bandwidth (IF Bandwidth = 9kHz) with Maximum Hold Mode. Then measurement is also conducted by Average Detector and Quasi-Peak Detector Function respectively.

3.6.4 Test Setup

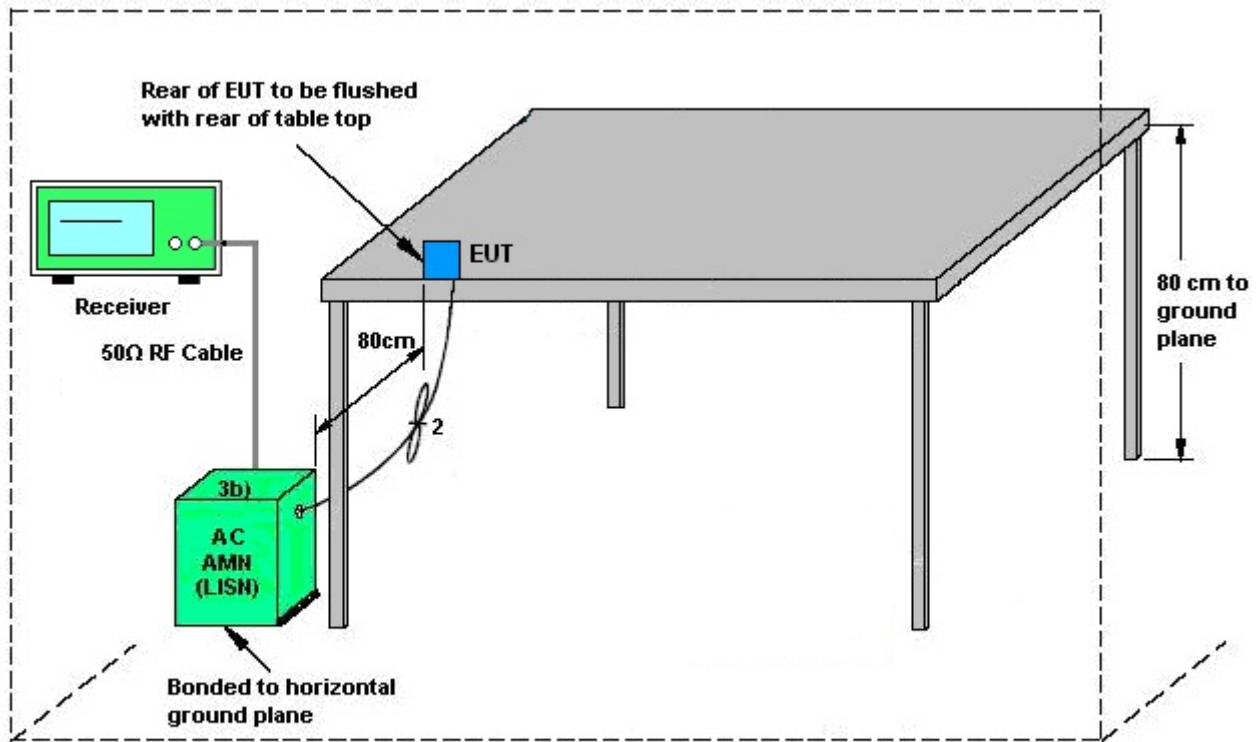

AMN = Artificial mains network (LISH)
 AE = Associated equipment
 EUT = Equipment under test
 ISN = Impedance stabilization network

3.6.5 Test Result of AC Conducted Emission

Please refer to Appendix B.



3.7 Antenna Requirements

3.7.1 Standard Applicable

If directional gain of transmitting antennas is greater than 6dBi, the power shall be reduced by the same level in dB comparing to gain minus 6dBi. The use of a permanently attached antenna or of an antenna that uses a unique coupling to the intentional radiator shall be considered sufficient to comply with the rule.

3.7.2 Antenna Anti-Replacement Construction

An embedded-in antenna design is used.

3.7.3 Antenna Gain

The antenna peak gain of EUT is less than 6 dBi. Therefore, it is not necessary to reduce maximum peak output power limit.



4 List of Measuring Equipment

Instrument	Manufacturer	Model No.	Serial No.	Characteristics	Calibration Date	Test Date	Due Date	Remark
Power Meter	Agilent	E4416A	GB412923 44	N/A	Dec. 20, 2017	Mar. 01, 2018~ May 24, 2018	Dec. 19, 2018	Conducted (TH05-HY)
Power Sensor	Agilent	E9327A	US404415 48	50MHz~18GHz	Dec. 20, 2017	Mar. 01, 2018~ May 24, 2018	Dec. 19, 2018	Conducted (TH05-HY)
Spectrum Analyzer	Rohde & Schwarz	FSP40	100055	9kHz~40GHz	Jun. 20, 2017	Mar. 01, 2018~ May 24, 2018	Jun. 19, 2018	Conducted (TH05-HY)
Switch Box & RF Cable	Burgeon	ETF-058	EC130048 4	N/A	Mar. 01, 2018	Mar. 01, 2018~ May 24, 2018	Feb. 28, 2019	Conducted (TH05-HY)
Hygrometer	TECPEL	DTM-303B	TP157151	N/A	Mar. 20, 2017	Mar. 01, 2018~ Mar. 18, 2018	Mar. 19, 2018	Conducted (TH05-HY)
Hygrometer	Testo	DTM-303A	TP157075	N/A	Mar. 06, 2018	Mar. 19, 2018~ May 24, 2018	Mar. 05, 2019	Conducted (TH05-HY)
RF Cable	HUBER + SUHNER	SUCOFLEX 104	MY842095 21	1GHz~26GHz	Dec. 01, 2017	Mar. 01, 2018~ May 24, 2018	Nov. 30, 2018	Conducted (TH05-HY)
AC Power Source	ChainTek	APC-1000W	N/A	N/A	N/A	Jan. 19, 2018	N/A	Conduction (CO05-HY)
EMI Test Receiver	Rohde & Schwarz	ESCI 7	100724	9kHz~7GHz	Sep. 20, 2017	Jan. 19, 2018	Sep. 19, 2018	Conduction (CO05-HY)
Hygrometer	Testo	608-H1	34913912	N/A	Mar. 20, 2017	Jan. 19, 2018	Mar. 19, 2018	Conduction (CO05-HY)
LISN	Rohde & Schwarz	ENV216	100080	9kHz~30MHz	Nov. 30, 2017	Jan. 19, 2018	Nov. 29, 2018	Conduction (CO05-HY)
LF Cable	HUBER + SUHNER	RG-214/U	LF01	N/A	Jan. 05, 2018	Jan. 19, 2018	Jan. 04, 2019	Conduction (CO05-HY)
Pulse Limiter	Rohde & Schwarz	ESH3-Z2	100851	N/A	Jan. 05, 2018	Jan. 19, 2018	Jan. 04, 2019	Conduction (CO05-HY)
Test Software	Rohde & Schwarz	EMC32 V10.30	N/A	N/A	N/A	Jan. 19, 2018	N/A	Conduction (CO05-HY)
Loop Antenna	Rohde & Schwarz	HFH2-Z2	100488	9 kHz~30 MHz	Nov. 23, 2017	Jan. 17, 2018~ Jun. 01, 2018	Nov. 22, 2019	Radiation (03CH11-HY)
Bilog Antenna	TESEQ	CBL 6111D&N-6-0 6	35414&AT- N0602	30MHz~1GHz	Oct. 14, 2017	Jan. 17, 2018~ Jun. 01, 2018	Oct. 13, 2018	Radiation (03CH11-HY)
Horn Antenna	SCHWARZBE CK	BBHA 9120 D	9120D-132 6	1GHz ~ 18GHz	Oct. 16, 2017	Jan. 17, 2018~ Jun. 01, 2018	Oct. 15, 2018	Radiation (03CH11-HY)
SHF-EHF Horn Antenna	SCHWARZBE CK	BBHA 9170	BBHA9170 584	18GHz- 40GHz	Nov. 27, 2017	Jan. 17, 2018~ Jun. 01, 2018	Nov. 26, 2018	Radiation (03CH11-HY)
Spectrum Analyzer	Keysight	N9010A	MY542004 86	10Hz ~ 44GHz	Oct. 19, 2017	Jan. 17, 2018~ Jun. 01, 2018	Oct. 18, 2018	Radiation (03CH11-HY)
Amplifier	SONOMA	310N	187312	9kHz~1GHz	Jan. 16, 2018	Jan. 17, 2018~ Jun. 01, 2018	Jan. 15, 2019	Radiation (03CH11-HY)
Preamplifier	MITEQ	AMF-7D-0010 1800-30-10P	1590074	1GHz~18GHz	May 22, 2017	Jan. 17, 2018~ May 20, 2018	May 21, 2018	Radiation (03CH11-HY)
Preamplifier	Jet-Power	JPA0118-55-3 03K	171000180 0054002	1GHz~18GHz	Apr. 17, 2018	May 21, 2018~ Jun. 01, 2018	Apr. 16, 2019	Radiation (03CH11-HY)
Preamplifier	Keysight	83017A	MY532700 80	1GHz~26.5GHz	Nov. 10, 2017	Jan. 17, 2018 ~ Jun. 01, 2018	Nov. 09, 2018	Radiation (03CH11-HY)



Instrument	Manufacturer	Model No.	Serial No.	Characteristics	Calibration Date	Test Date	Due Date	Remark
Amplifier	MITEQ	TTA1840-35-HG	1871923	18GHz~40GHz, VSWR : 2.5:1 max	Jul. 18, 2017	Jan. 17, 2018~ Jun. 01, 2018	Jul. 17, 2018	Radiation (03CH11-HY)
Hygrometer	TECPEL	DTN-303B	TP140325	N/A	Oct. 12, 2017	Jan. 17, 2018 ~ Jun. 01, 2018	Oct. 11, 2018	Radiation (03CH11-HY)
RF Cable	HUBER + SUHNER	SUCOFLEX 104	MY335041 /4MY9840/ 4 MY9838/4	9k~30MHz	Jan. 27, 2017	Jan. 17, 2018 ~ Jan. 23, 2018	Jan. 26, 2018	Radiation (03CH11-HY)
RF Cable	HUBER + SUHNER	SUCOFLEX 104	MY9837/4	9K-30M	Mar. 20, 2018	Mar. 20, 2018~ Jun. 01, 2018	Mar. 19, 2019	Radiation (03CH11-HY)
RF Cable	HUBER + SUHNER	SUCOFLEX 104	MY15539/ 4	30M-18G	Mar. 17, 2017	Jan. 17, 2018 ~ Jan. 23, 2018	Mar. 16, 2018	Radiation (03CH11-HY)
RF Cable	HUBER + SUHNER	SUCOFLEX 104	MY9837/4	30M-18G	Mar. 15, 2018	May 31, 2018 ~ Jun. 01, 2018	Mar. 14, 2019	Radiation (03CH11-HY)
RF Cable	HUBER + SUHNER	SUCOFLEX 102	MY2589/2	30M-18G	Mar. 15, 2018	May 31, 2018 ~ Jun. 01, 2018	Mar. 14, 2019	Radiation (03CH11-HY)
RF Cable	HUBER + SUHNER	SUCOFLEX 102	505134/2	30M~40GHz	Oct. 17, 2017	Jan. 17, 2018 ~ Jun. 01, 2018	Oct. 16, 2018	Radiation (03CH11-HY)
RF Cable	HUBER + SUHNER	SUCOFLEX 102	800740/2	30M~40GHz	Oct. 17, 2017	Jan. 17, 2018 ~ Jun. 01, 2018	Oct. 16, 2018	Radiation (03CH11-HY)
Filter	Wainwright	WLKS1200-1 2SS	SN2	1.2G Low Pass	Jul. 17, 2017	Jan. 17, 2018 ~ Jun. 01, 2018	Jul. 16, 2018	Radiation (03CH11-HY)
Filter	Wainwright	WHKX12-270 0-3000-18000 -60SS	SN3	2.7G High Pass	Sep. 18, 2017	Jan. 17, 2018 ~ Jun. 01, 2018	Sep. 17, 2018	Radiation (03CH11-HY)
Antenna Mast	EMEC	AM-BS-4500- B	N/A	1~4m	N/A	Jan. 17, 2018 ~ Jun. 01, 2018	N/A	Radiation (03CH11-HY)
Turn Table	EMEC	TT 2000	N/A	0~360 Degree	N/A	Jan. 17, 2018 ~ Jun. 01, 2018	N/A	Radiation (03CH11-HY)
Test Software	Audix	E3 6.2009-8-24	RK-00104 2	N/A	N/A	Jan. 17, 2018 ~ Jun. 01, 2018	N/A	Radiation (03CH11-HY)



5 Uncertainty of Evaluation

Uncertainty of Conducted Emission Measurement (150 kHz ~ 30 MHz)

Measuring Uncertainty for a Level of Confidence of 95% ($U = 2Uc(y)$)	2.70
---	------

Uncertainty of Radiated Emission Measurement (30 MHz ~ 1000 MHz)

Measuring Uncertainty for a Level of Confidence of 95% ($U = 2Uc(y)$)	5.20
---	------

Uncertainty of Radiated Emission Measurement (1000 MHz ~ 18000 MHz)

Measuring Uncertainty for a Level of Confidence of 95% ($U = 2Uc(y)$)	5.50
---	------

Uncertainty of Radiated Emission Measurement (18000 MHz ~ 40000 MHz)

Measuring Uncertainty for a Level of Confidence of 95% ($U = 2Uc(y)$)	5.20
---	------

Appendix A. Test Result of Conducted Test Items

Test Engineer:	Lena Lo/Shiang Wang	Temperature:	21~25	°C
Test Date:	2018/3/1~2018/06/07	Relative Humidity:	51~54	%

TEST RESULTS DATA
6dB and 99% Occupied Bandwidth

Mod.	Data Rate	N _{TX}	CH.	Freq. (MHz)	99% Occupied BW (MHz)	6dB BW (MHz)	6dB BW Limit (MHz)	Pass/Fail
BLE	1Mbps	1	0	2402	1.016	0.640	0.50	Pass
BLE	1Mbps	1	19	2440	1.010	0.636	0.50	Pass
BLE	1Mbps	1	39	2480	1.014	0.632	0.50	Pass

TEST RESULTS DATA
Peak Power Table

Mod.	Data Rate	N _{TX}	CH.	Freq. (MHz)	Peak Conducted Power (dBm)	Conducted Power Limit (dBm)	DG (dBi)	EIRP Power (dBm)	EIRP Power Limit (dBm)	Pass /Fail
BLE	1Mbps	1	0	2402	1.32	30.00	2.50	3.82	36.00	Pass
BLE	1Mbps	1	19	2440	1.86	30.00	2.50	4.36	36.00	Pass
BLE	1Mbps	1	39	2480	1.41	30.00	2.50	3.91	36.00	Pass

TEST RESULTS DATA
Average Power Table
(Reporting Only)

Mod.	Data Rate	N _{TX}	CH.	Freq. (MHz)	Duty Factor (dB)	Average Conducted Power (dBm)
BLE	1Mbps	1	0	2402	0.80	0.01
BLE	1Mbps	1	19	2440	0.80	0.46
BLE	1Mbps	1	39	2480	0.80	0.03

TEST RESULTS DATA
Peak Power Density

Mod.	Data Rate	N _{TX}	CH.	Freq. (MHz)	Peak PSD (dBm /100kHz)	Peak PSD (dBm /3kHz)	DG (dBi)	Peak PSD Limit (dBm /3kHz)	Pass/Fail
BLE	1Mbps	1	0	2402	0.98	-12.77	2.50	8.00	Pass
BLE	1Mbps	1	19	2440	1.67	-12.51	2.50	8.00	Pass
BLE	1Mbps	1	39	2480	1.16	-13.22	2.50	8.00	Pass

Note: PSD (dBm/ 100kHz) is a reference level used for Conducted Band Edges and Conducted Spurious Emission 20dBc limit.



Appendix B. AC Conducted Emission Test Results

Test Engineer :	Blue Lan	Temperature :	25~26°C
		Relative Humidity :	51~53%

EUT Information

Report NO : 6d2013-01
 Test Mode : Mode 1
 Test Voltage : 120Vac/60Hz
 Phase : Line

ENV216 Auto Test FCC Power Bar - L

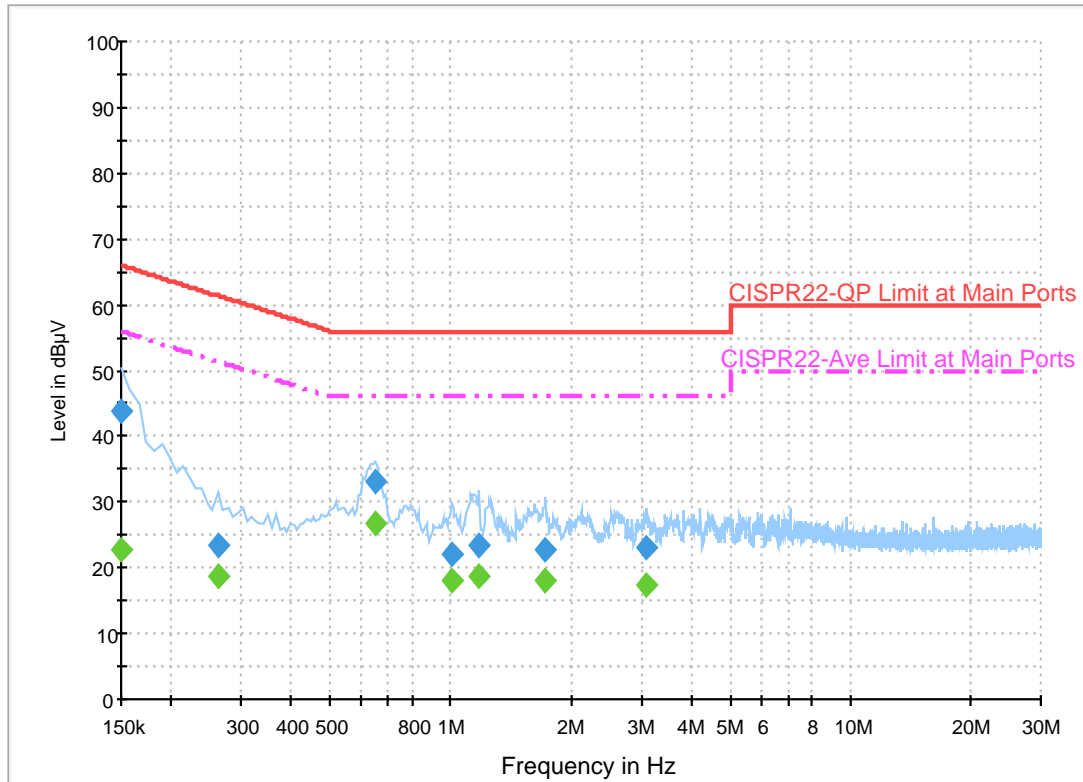

Final Result 1

Frequency (MHz)	QuasiPeak (dBµV)	Filter	Line	Corr. (dB)	Margin (dB)	Limit (dBµV)
0.150000	43.7	Off	L1	19.5	22.3	66.0
0.262000	23.5	Off	L1	19.5	37.9	61.4
0.646000	32.9	Off	L1	19.5	23.1	56.0
1.006000	22.2	Off	L1	19.5	33.8	56.0
1.182000	23.4	Off	L1	19.6	32.6	56.0
1.726000	22.9	Off	L1	19.6	33.1	56.0
3.094000	23.0	Off	L1	19.6	33.0	56.0

Final Result 2

Frequency (MHz)	Average (dBµV)	Filter	Line	Corr. (dB)	Margin (dB)	Limit (dBµV)
0.150000	22.9	Off	L1	19.5	33.1	56.0
0.262000	18.8	Off	L1	19.5	32.6	51.4
0.646000	26.7	Off	L1	19.5	19.3	46.0
1.006000	18.1	Off	L1	19.5	27.9	46.0
1.182000	18.6	Off	L1	19.6	27.4	46.0
1.726000	18.2	Off	L1	19.6	27.8	46.0
3.094000	17.5	Off	L1	19.6	28.5	46.0

EUT Information

Report NO : 6d2013-01
 Test Mode : Mode 1
 Test Voltage : 120Vac/60Hz
 Phase : Neutral

ENV216 Auto Test FCC Power Bar - N

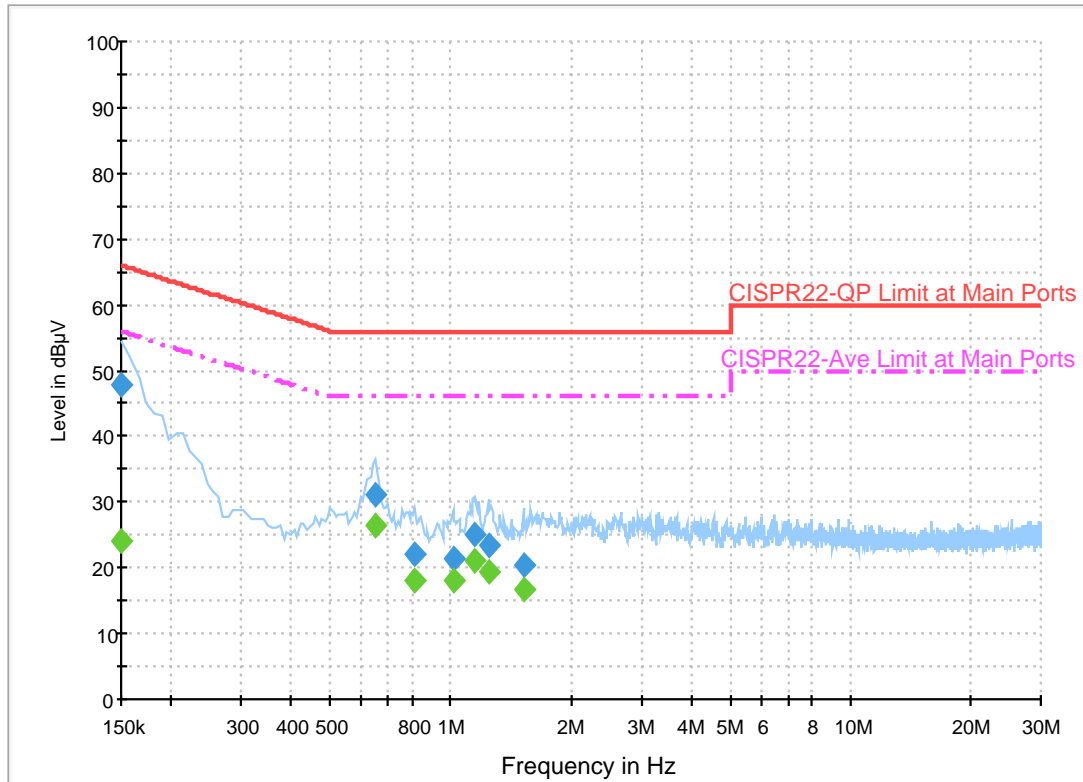

Final Result 1

Frequency (MHz)	QuasiPeak (dBµV)	Filter	Line	Corr. (dB)	Margin (dB)	Limit (dBµV)
0.150000	47.7	Off	N	19.5	18.3	66.0
0.646000	31.1	Off	N	19.5	24.9	56.0
0.814000	22.2	Off	N	19.5	33.8	56.0
1.014000	21.4	Off	N	19.5	34.6	56.0
1.150000	25.2	Off	N	19.5	30.8	56.0
1.246000	23.5	Off	N	19.5	32.5	56.0
1.526000	20.2	Off	N	19.6	35.8	56.0

Final Result 2

Frequency (MHz)	Average (dBµV)	Filter	Line	Corr. (dB)	Margin (dB)	Limit (dBµV)
0.150000	24.2	Off	N	19.5	31.8	56.0
0.646000	26.4	Off	N	19.5	19.6	46.0
0.814000	18.2	Off	N	19.5	27.8	46.0
1.014000	18.0	Off	N	19.5	28.0	46.0
1.150000	21.0	Off	N	19.5	25.0	46.0
1.246000	19.4	Off	N	19.5	26.6	46.0
1.526000	16.9	Off	N	19.6	29.1	46.0



Appendix C. Radiated Spurious Emission

Test Engineer :	Hao Hsu, Jacky Hung, and Ken Wu	Temperature :	23~25°C
		Relative Humidity :	54~59%

2.4GHz 2400~2483.5MHz

BLE (Band Edge @ 3m)

BLE	Note	Frequency	Level	Over	Limit	Read	Antenna	Path	Preamp	Ant	Table	Peak	Pol.	
		(MHz)	(dBμV/m)	(dB)	Limit Line	(dBμV)	(dB/m)	(dB)	(dB)	(cm)	(deg)	(P/A)	(H/V)	
BLE CH 00 2402MHz		2363.13	51.74	-22.26	74	42.08	27.04	6.29	33.6	288	75	P	H	
		2380.98	41.98	-12.02	54	32.2	27.09	6.36	33.6	288	75	A	H	
	*	2402	95.04	-	-	85.21	27.13	6.36	33.59	288	75	P	H	
	*	2402	94.4	-	-	84.57	27.13	6.36	33.59	288	75	A	H	
													H	
			2373.735	51.52	-22.48	74	41.81	27.09	6.29	33.6	400	99	P	V
			2386.23	41.79	-12.21	54	31.97	27.13	6.36	33.6	400	99	A	V
	*		2402	91.71	-	-	81.88	27.13	6.36	33.59	400	99	P	V
	*		2402	90.82	-	-	80.99	27.13	6.36	33.59	400	99	A	V
														V
BLE CH 19 2440MHz		2380.4	51.85	-22.15	74	42.07	27.09	6.36	33.6	305	113	P	H	
		2381.36	41.77	-12.23	54	31.99	27.09	6.36	33.6	305	113	A	H	
	*	2440	92.76	-	-	82.77	27.27	6.38	33.59	305	113	P	H	
	*	2440	92.13	-	-	82.14	27.27	6.38	33.59	305	113	A	H	
			2484.32	51.67	-22.33	74	41.57	27.36	6.39	33.58	305	113	P	H
			2488.8	42.08	-11.92	54	31.94	27.4	6.39	33.58	305	113	A	H
			2355.6	51.88	-22.12	74	42.22	27.04	6.29	33.6	394	103	P	V
			2378.16	41.71	-12.29	54	32	27.09	6.29	33.6	394	103	A	V
	*		2440	91.38	-	-	81.39	27.27	6.38	33.59	394	103	P	V
	*		2440	90.78	-	-	80.79	27.27	6.38	33.59	394	103	A	V
			2487.44	51.3	-22.7	74	41.2	27.36	6.39	33.58	394	103	P	V
			2498.4	42.13	-11.87	54	31.98	27.4	6.39	33.57	394	103	A	V



BLE CH 39 2480MHz	*	2480	91.41	-	-	81.32	27.36	6.38	33.58	299	149	P	H
	*	2480	90.75	-	-	80.66	27.36	6.38	33.58	299	149	A	H
		2498.76	51.9	-22.1	74	41.75	27.4	6.39	33.57	299	149	P	H
		2483.52	42.5	-11.5	54	32.41	27.36	6.38	33.58	299	149	P	H
													H
													H
	*	2480	88.55	-	-	78.46	27.36	6.38	33.58	379	102	P	V
	*	2480	87.91	-	-	77.82	27.36	6.38	33.58	379	102	A	V
		2494	52.66	-21.34	74	42.51	27.4	6.39	33.57	379	102	P	V
		2483.64	42.37	-11.63	54	32.28	27.36	6.38	33.58	379	102	A	V
													V
													V
Remark	1. No other spurious found. 2. All results are PASS against Peak and Average limit line.												



2.4GHz 2400~2483.5MHz
BLE (Harmonic @ 3m)

BLE	Note	Frequency	Level	Over	Limit	Read	Antenna	Path	Preamp	Ant	Table	Peak	Pol.	
		(MHz)	(dBµV/m)	(dB)	Line	Level	Factor	Loss	Factor	Pos	Pos	Avg.		
					(dBµV/m)	(dBµV)	(dB/m)	(dB)	(dB)	(cm)	(deg)	(P/A)	(H/V)	
BLE CH 00 2402MHz		4804	43.2	-30.8	74	58.49	31.26	9.6	56.58	100	0	P	H	
													H	
													H	
													H	
		4804	42.35	-31.65	74	57.64	31.26	9.6	56.58	100	0	P	V	
														V
														V
BLE CH 19 2440MHz		4880	43.91	-30.09	74	59.09	31.38	9.56	56.55	100	0	P	H	
		7320	42.85	-31.15	74	50.97	36.32	11.31	56.21	100	0	P	H	
													H	
													H	
		4880	43.36	-30.64	74	58.54	31.38	9.56	56.55	100	0	P	V	
		7320	42.58	-31.42	74	50.7	36.32	11.31	56.21	100	0	P	V	
														V
BLE CH 39 2480MHz		4960	49.73	-24.27	74	64.73	31.54	9.53	56.51	100	0	P	H	
		7440	48.49	-25.51	74	56.24	36.59	11.34	56.06	100	0	P	H	
													H	
													H	
		4960	46.63	-27.37	74	61.63	31.54	9.53	56.51	100	0	P	V	
		7440	44.53	-29.47	74	52.28	36.59	11.34	56.06	100	0	P	V	
														V
Remark	1. No other spurious found. 2. All results are PASS against Peak and Average limit line.													



Emission below 1GHz

2.4GHz BLE (LF)

BLE	Note	Frequency	Level	Over	Limit	Read	Antenna	Path	Preamp	Ant	Table	Peak	Pol.	
		(MHz)	(dBμV/m)	(dB)	(dBμV/m)	(dBμV)	(dB/m)	(dB)	(dB)	(cm)	(deg)	(P/A)	(H/V)	
2.4GHz BLE LF		93.45	29.49	-14.01	43.5	45.8	14.93	1.22	32.48	-	-	P	H	
		153.12	27.74	-15.76	43.5	41.83	16.64	1.61	32.43	-	-	P	H	
		200.37	22.98	-20.52	43.5	38.71	14.88	1.72	32.39	-	-	P	H	
		479.9	28.8	-17.2	46	34.9	23.45	2.77	32.37	-	-	P	H	
		640.2	32.78	-13.22	46	35.65	26.34	3.15	32.46	100	0	P	H	
		880.3	32.76	-13.24	46	31.53	29.1	3.73	31.76	-	-	P	H	
														H
														H
														H
														H
														H
														H
			45.66	36.62	-3.38	40	51.95	16.14	1.02	32.49	100	0	P	V
			54.84	35.05	-4.95	40	54.26	12.25	1.02	32.49	-	-	P	V
			58.62	28.61	-11.39	40	48.41	11.65	1.02	32.49	-	-	P	V
			479.9	27.21	-18.79	46	33.31	23.45	2.77	32.37	-	-	P	V
			640.2	32.39	-13.61	46	35.26	26.34	3.15	32.46	-	-	P	V
			938.4	32.54	-13.46	46	29.88	29.98	3.82	31.31	-	-	P	V
													V	
													V	
													V	
													V	
													V	
													V	
Remark	1. No other spurious found. 2. All results are PASS against limit line.													



Note symbol

*	Fundamental Frequency which can be ignored. However, the level of any unwanted emissions shall not exceed the level of the fundamental frequency.
!	Test result is over limit line.
P/A	Peak or Average
H/V	Horizontal or Vertical



A calculation example for radiated spurious emission is shown as below:

BLE	Note	Frequency (MHz)	Level (dBμV/m)	Over Limit (dB)	Limit Line (dBμV/m)	Read Level (dBμV)	Antenna Factor (dB/m)	Path Loss (dB)	Preamp Factor (dB)	Ant Pos (cm)	Table Pos (deg)	Peak Avg. (P/A)	Pol. (H/V)
BLE CH 00 2402MHz		2390	55.45	-18.55	74	54.51	32.22	4.58	35.86	103	308	P	H
		2390	43.54	-10.46	54	42.6	32.22	4.58	35.86	103	308	A	H

1. Path Loss(dB) = Cable loss(dB) + Filter loss(dB) + Attenuator loss(dB)
2. Level(dBμV/m) =
Antenna Factor(dB/m) + Path Loss(dB) + Read Level(dBμV) - Preamp Factor(dB)
3. Over Limit(dB) = Level(dBμV/m) – Limit Line(dBμV/m)

For Peak Limit @ 2390MHz:

1. Level(dBμV/m)
= Antenna Factor(dB/m) + Path Loss(dB) + Read Level(dBμV) - Preamp Factor(dB)
= 32.22(dB/m) + 4.58(dB) + 54.51(dBμV) – 35.86 (dB)
= 55.45 (dBμV/m)
2. Over Limit(dB)
= Level(dBμV/m) – Limit Line(dBμV/m)
= 55.45(dBμV/m) – 74(dBμV/m)
= -18.55(dB)

For Average Limit @ 2390MHz:

1. Level(dBμV/m)
= Antenna Factor(dB/m) + Path Loss(dB) + Read Level(dBμV) - Preamp Factor(dB)
= 32.22(dB/m) + 4.58(dB) + 42.6(dBμV) – 35.86 (dB)
= 43.54 (dBμV/m)
2. Over Limit(dB)
= Level(dBμV/m) – Limit Line(dBμV/m)
= 43.54(dBμV/m) – 54(dBμV/m)
= -10.46(dB)

Both peak and average measured complies with the limit line, so test result is “PASS”.



Appendix D. Radiated Spurious Emission Plots

Test Engineer :	Hao Hsu, Jacky Hung, and Ken Wu	Temperature :	23~25°C
		Relative Humidity :	54~59%

Note symbol

-L	Low channel location
-R	High channel location



2.4GHz 2400~2483.5MHz

BLE (Band Edge @ 3m)

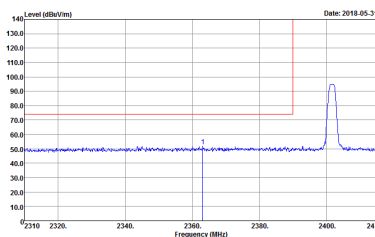
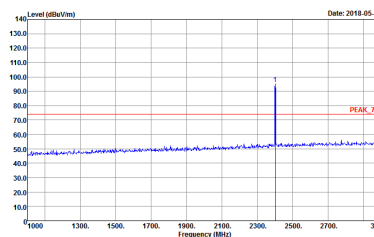
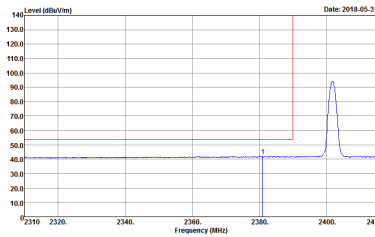
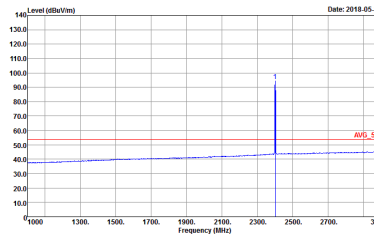
BLE	2.4GHz 2400~2483.5MHz Band Edge @ 3m	
BLE CH00 2402MHz		
	Horizontal	Fundamental
Peak	 <p>Site : 03CH11-HY Condition : PEAK_BE_74 3m HORN 91200-HF HORIZONTAL Detector : Peak Project : 6D2013-01</p>	 <p>Site : 03CH11-HY Condition : PEAK_74 3m HORN 91200-HF HORIZONTAL Detector : Peak Project : 6D2013-01</p>
Avg.	 <p>Site : 03CH11-HY Condition : AVG_BE_54 3m HORN 91200-HF HORIZONTAL Detector : Peak Project : 6D2013-01</p>	 <p>Site : 03CH11-HY Condition : AVG_54 3m HORN 91200-HF HORIZONTAL Detector : Peak Project : 6D2013-01</p>

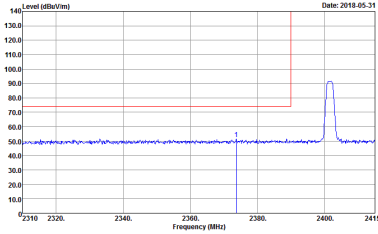
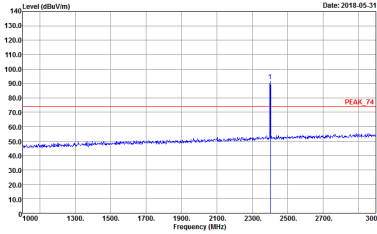
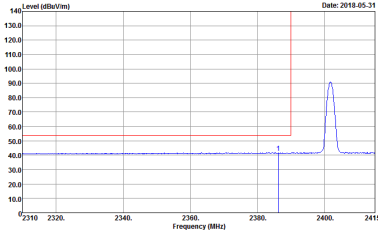
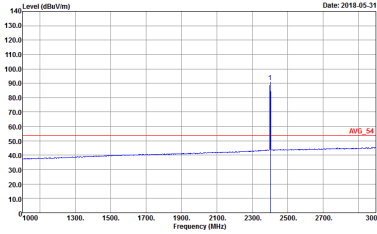

BLE	2.4GHz 2400~2483.5MHz Band Edge @ 3m	
BLE CH00 2402MHz		
	Vertical	Fundamental
Peak	 <p>Site : 03CH11-HY Condition : PEAK_BE_74 3m HORN 91200-HF VERTICAL : RBW:1000.000KHz VBW:3000.000KHz SWT:Auto Detector : Peak Project : 6D2013-01</p>	 <p>Site : 03CH11-HY Condition : PEAK_74 3m HORN 91200-HF VERTICAL : RBW:1000.000KHz VBW:3000.000KHz SWT:Auto Detector : Peak Project : 6D2013-01</p>
Avg	 <p>Site : 03CH11-HY Condition : AVG_BE_54 3m HORN 91200-HF VERTICAL : RBW:1000.000KHz VBW:1000KHz SWT:Auto Detector : Peak Project : 6D2013-01</p>	 <p>Site : 03CH11-HY Condition : AVG_54 3m HORN 91200-HF VERTICAL : RBW:1000.000KHz VBW:1000KHz SWT:Auto Detector : Peak Project : 6D2013-01</p>

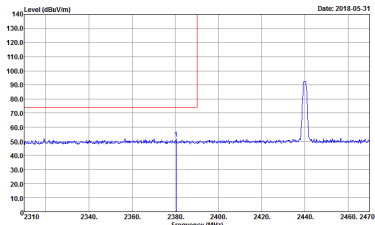
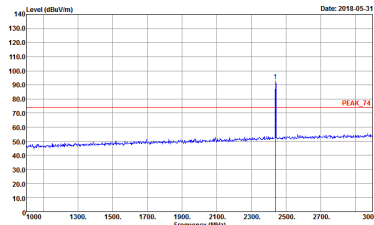
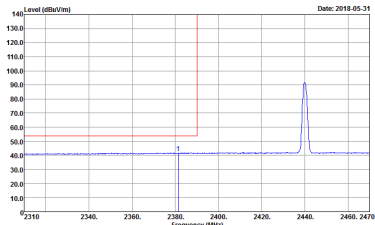
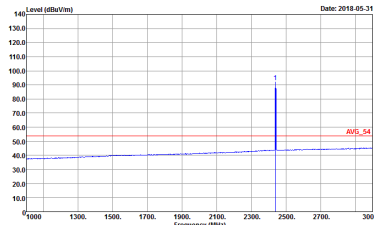

BLE	2.4GHz 2400~2483.5MHz Band Edge @ 3m	
BLE CH19 2440MHz - L		
	Horizontal	Fundamental
<p>Peak</p>	 <p>Date: 2018-05-31</p> <p>Site : 03CH11-HY Condition : PEAK_BE_74 3m HORN 9120D-HF HORIZONTAL RBW:1000.000KHz VBW:3000.000KHz SWT:Auto Detector : Peak Project : 6D2013-01</p>	 <p>Date: 2018-05-31</p> <p>Site : 03CH11-HY Condition : PEAK_74 3m HORN 9120D-HF HORIZONTAL RBW:1000.000KHz VBW:3000.000KHz SWT:Auto Detector : Peak Project : 6D2013-01</p>
<p>Avg.</p>	 <p>Date: 2018-05-31</p> <p>Site : 03CH11-HY Condition : AVG_BE_54 3m HORN 9120D-HF HORIZONTAL RBW:1000.000KHz VBW:1000KHz SWT:Auto Detector : Peak Project : 6D2013-01</p>	 <p>Date: 2018-05-31</p> <p>Site : 03CH11-HY Condition : AVG_54 3m HORN 9120D-HF HORIZONTAL RBW:1000.000KHz VBW:1000KHz SWT:Auto Detector : Peak Project : 6D2013-01</p>



BLE	2.4GHz 2400~2483.5MHz Band Edge @ 3m	
	BLE CH19 2440MHz - R	
	Horizontal	Fundamental
Peak	<p>Site : 03CH11-HY Condition : PEAK_BE_74 3m HORN 91200-HF HORIZONTAL RBW:1000.000kHz VBW:3000.000kHz SWF:Auto Detector : Peak Project : 6D2013-01</p>	Left blank
Avg.	<p>Site : 03CH11-HY Condition : AVG_BE_54 3m HORN 91200-HF HORIZONTAL RBW:1000.000kHz VBW:1000kHz SWF:Auto Detector : Peak Project : 6D2013-01</p>	Left blank



BLE	2.4GHz 2400~2483.5MHz Band Edge @ 3m	
BLE CH19 2440MHz - L		
	Vertical	Fundamental
Peak	<p>Date: 2018-05-31</p> <p>Site : 03CH11-HY Condition : PEAK_BE_74 3m HORN 91200-HF VERTICAL : RBW:1000.000KHz VBW:3000.000KHz SWT:Auto Detector : Peak Project : 6D2013-01</p>	<p>Date: 2018-05-31</p> <p>Site : 03CH11-HY Condition : PEAK_74 3m HORN 91200-HF VERTICAL : RBW:1000.000KHz VBW:3000.000KHz SWT:Auto Detector : Peak Project : 6D2013-01</p>
Avg.	<p>Date: 2018-05-31</p> <p>Site : 03CH11-HY Condition : AVG_BE_54 3m HORN 91200-HF VERTICAL : RBW:1000.000KHz VBW:1000KHz SWT:Auto Detector : Peak Project : 6D2013-01</p>	<p>Date: 2018-05-31</p> <p>Site : 03CH11-HY Condition : AVG_54 3m HORN 91200-HF VERTICAL : RBW:1000.000KHz VBW:1000KHz SWT:Auto Detector : Peak Project : 6D2013-01</p>

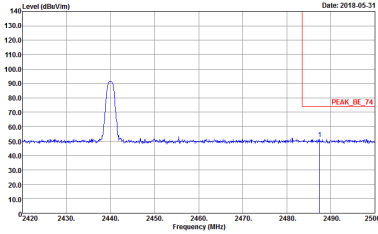
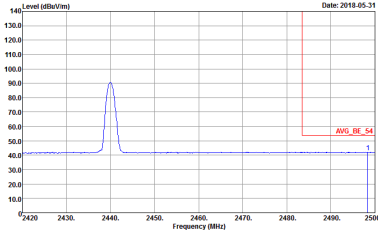

BLE	2.4GHz 2400~2483.5MHz Band Edge @ 3m	
BLE CH19 2440MHz - R		
	Vertical	Fundamental
<p>Peak</p>	 <p>Site : 03CH11-HY Condition : PEAK_BE_74 3m HORN 91200-HF VERTICAL RBW:1000.000kHz VBW:3000.000kHz SWF:Auto Detector : Peak Project : 6D2013-01</p>	<p>Left blank</p>
<p>Avg.</p>	 <p>Site : 03CH11-HY Condition : AVG_BE_54 3m HORN 91200-HF VERTICAL RBW:1000.000kHz VBW:1000kHz SWF:Auto Detector : Peak Project : 6D2013-01</p>	<p>Left blank</p>

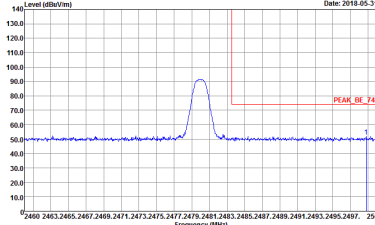
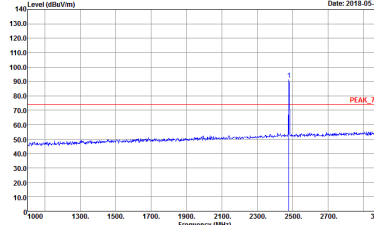
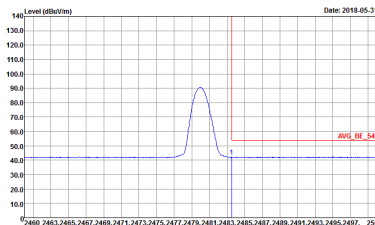
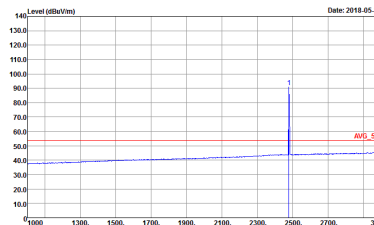

BLE	2.4GHz 2400~2483.5MHz Band Edge @ 3m	
BLE CH39 2480MHz		
	Horizontal	Fundamental
<p>Peak</p>	 <p>Site : 03CH11-HY Condition : PEAK_BE_74 3m HORN 91200-HF HORIZONTAL RBW:1000.000KHz VBW:3000.000KHz SWT:Auto Detector : Peak Project : 6D2013-01</p>	 <p>Site : 03CH11-HY Condition : PEAK_74 3m HORN 91200-HF HORIZONTAL RBW:1000.000KHz VBW:3000.000KHz SWT:Auto Detector : Peak Project : 6D2013-01</p>
<p>Avg.</p>	 <p>Site : 03CH11-HY Condition : AVG_BE_54 3m HORN 91200-HF HORIZONTAL RBW:1000.000KHz VBW:1000KHz SWT:Auto Detector : Peak Project : 6D2013-01</p>	 <p>Site : 03CH11-HY Condition : AVG_54 3m HORN 91200-HF HORIZONTAL RBW:1000.000KHz VBW:1000KHz SWT:Auto Detector : Peak Project : 6D2013-01</p>

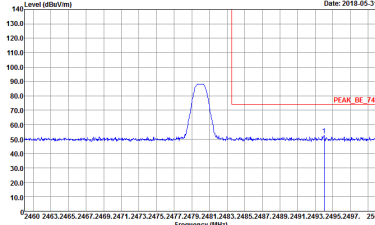
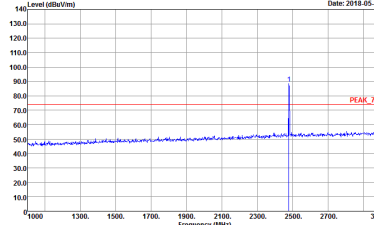
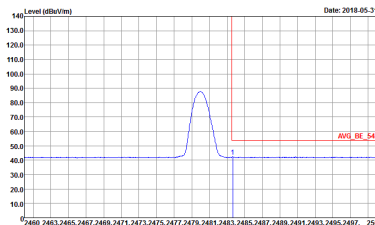
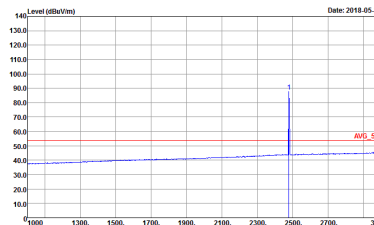

BLE	2.4GHz 2400~2483.5MHz Band Edge @ 3m	
BLE CH39 2480MHz		
	Vertical	Fundamental
Peak	 <p>Site : 03CH11-HY Condition : PEAK_BE_74 3m HORN 91200-HF VERTICAL RBW:1000.000KHz VBW:3000.000KHz SWT:Auto Detector : Peak Project : 6D2013-01</p>	 <p>Site : 03CH11-HY Condition : PEAK_74 3m HORN 91200-HF VERTICAL RBW:1000.000KHz VBW:3000.000KHz SWT:Auto Detector : Peak Project : 6D2013-01</p>
Avg.	 <p>Site : 03CH11-HY Condition : AVG_BE_54 3m HORN 91200-HF VERTICAL RBW:1000.000KHz VBW:1000KHz SWT:Auto Detector : Peak Project : 6D2013-01</p>	 <p>Site : 03CH11-HY Condition : AVG_54 3m HORN 91200-HF VERTICAL RBW:1000.000KHz VBW:1000KHz SWT:Auto Detector : Peak Project : 6D2013-01</p>



2.4GHz 2400~2483.5MHz

BLE (Harmonic @ 3m)

BLE	2.4GHz 2400~2483.5MHz Harmonic @ 3m	
	BLE CH00 2402MHz	
	Horizontal	Vertical
Peak Avg.	<p>Site : 03CH11-1FY Condition : PEAK_74 3m HORN 91200-1HF HORIZONTAL Detector : Peak Project : 6D2013-01</p>	<p>Site : 03CH11-1FY Condition : PEAK_74 3m HORN 91200-1HF VERTICAL Detector : Peak Project : 6D2013-01</p>

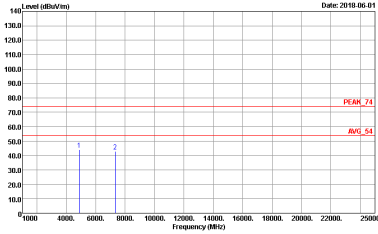
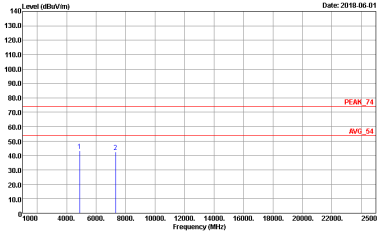

BLE	2.4GHz 2400~2483.5MHz Harmonic @ 3m	
BLE CH19 2440MHz		
Horizontal		Vertical
<p>Peak</p> <p>Avg.</p>	 <p>Site : 03CH11-HY Condition : PEAK_74 3m HORN 91200-HF HORIZONTAL Detector : Peak Project : 6D2013-01</p>	 <p>Site : 03CH11-HY Condition : PEAK_74 3m HORN 91200-HF VERTICAL Detector : Peak Project : 6D2013-01</p>



BLE	2.4GHz 2400~2483.5MHz Harmonic @ 3m	
	BLE CH39 2480MHz	
	Horizontal	Vertical
Peak	<p>Site : 03CH11-HY Condition : PEAK_74 3m HORN 91200-HF HORIZONTAL Detector : Peak Project : 6D2013-01</p>	<p>Site : 03CH11-HY Condition : PEAK_74 3m HORN 91200-HF VERTICAL Detector : Peak Project : 6D2013-01</p>



Emission below 1GHz
2.4GHz BLE (LF)

BLE	2.4GHz 2400~2483.5MHz	
	BLE LF	
	Horizontal	Vertical
QP / Peak	<p>Site : 03CH11-4FY Condition : QP 3m BT-LOG 6111D-LF_ETC HORIZONTAL Detector : Peak Project : 6D2013-01</p>	<p>Site : 03CH11-4FY Condition : QP 3m BT-LOG 6111D-LF_ETC VERTICAL Detector : Peak Project : 6D2013-01</p>



Appendix E. Duty Cycle Plots

Band	Duty Cycle(%)	T(us)	1/T(kHz)	VBW Setting	Duty Factor(dB)
Bluetooth – LE	83.20	2080	0.48	1kHz	0.80

Bluetooth – LE

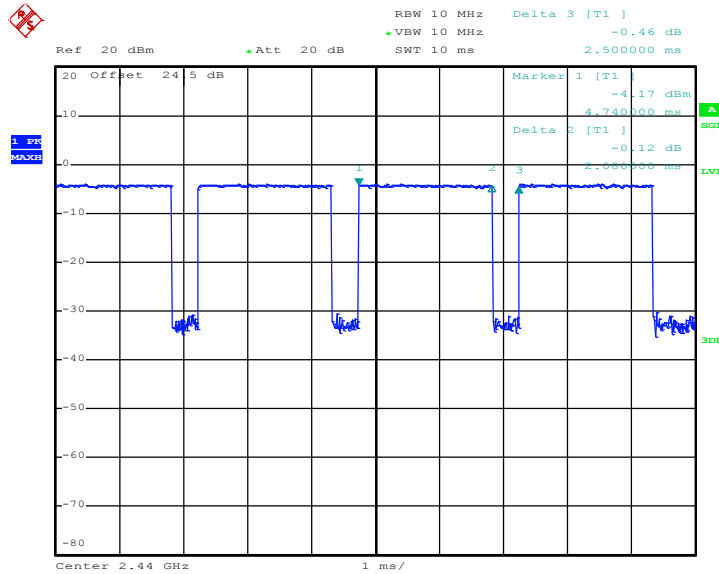

Date: 30.MAY.2018 04:45:52

————THE END————