



# FCC RADIO TEST REPORT

**FCC ID** : PY7-58241M  
**Equipment** : GSM/WCDMA/LTE Phone+Bluetooth,  
DTS/UNII a/b/g/n/ac and NFC  
**Brand Name** : Sony  
**Applicant** : Sony Mobile Communications Inc.  
4-12-3 Higashi-Shinagawa, Shinagawa-ku,  
Tokyo, 140-0002, Japan  
**Manufacturer** : Sony Mobile Communications Inc.  
4-12-3 Higashi-Shinagawa, Shinagawa-ku,  
Tokyo, 140-0002, Japan  
**Standard** : FCC Part 15 Subpart C §15.247

The product was received on Aug. 14, 2018 and testing was started from Aug. 27, 2018 and completed on Nov. 15, 2018. We, SPORTON INTERNATIONAL INC., would like to declare that the tested sample has been evaluated in accordance with the test procedures and has been in compliance with the applicable technical standards.

The report must not be used by the client to claim product certification, approval, or endorsement by TAF or any agency of government.

The test results in this report apply exclusively to the tested model / sample. Without written approval of SPORTON INTERNATIONAL INC. EMC & Wireless Communications Laboratory, the test report shall not be reproduced except in full.

Approved by: Joseph Lin

**SPORTON INTERNATIONAL INC. EMC & Wireless Communications Laboratory**

No. 52, Huaya 1st Rd., Guishan Dist., Taoyuan City, Taiwan (R.O.C.)



## Table of Contents

<b>History of this test report .....</b>	<b>3</b>
<b>Summary of Test Result .....</b>	<b>4</b>
<b>1 General Description.....</b>	<b>5</b>
1.1 Product Feature of Equipment Under Test .....	5
1.2 Modification of EUT .....	5
1.3 Testing Location .....	6
1.4 Applicable Standards .....	6
<b>2 Test Configuration of Equipment Under Test .....</b>	<b>7</b>
2.1 Carrier Frequency and Channel .....	7
2.2 Test Mode.....	7
2.3 Connection Diagram of Test System.....	8
2.4 Support Unit used in test configuration and system .....	9
2.5 EUT Operation Test Setup .....	9
2.6 Measurement Results Explanation Example .....	9
<b>3 Test Result.....</b>	<b>10</b>
3.1 6dB and 99% Bandwidth Measurement .....	10
3.2 Output Power Measurement.....	12
3.3 Power Spectral Density Measurement .....	13
3.4 Conducted Band Edges and Spurious Emission Measurement .....	15
3.5 Radiated Band Edges and Spurious Emission Measurement .....	31
3.6 AC Conducted Emission Measurement .....	35
3.7 Antenna Requirements .....	37
<b>4 List of Measuring Equipment .....</b>	<b>38</b>
<b>5 Uncertainty of Evaluation .....</b>	<b>40</b>
<b>Appendix A. Conducted Test Results</b>	
<b>Appendix B. AC Conducted Emission Test Result</b>	
<b>Appendix C. Radiated Spurious Emission</b>	
<b>Appendix D. Radiated Spurious Emission Plots</b>	
<b>Appendix E. Duty Cycle Plots</b>	





### Summary of Test Result

Report Clause	Ref Std. Clause	Test Items	Result (PASS/FAIL)	Remark
3.1	15.247(a)(2)	6dB Bandwidth	Pass	-
3.1	2.1049	99% Occupied Bandwidth	Reporting only	-
3.2	15.247(b)	Power Output Measurement	Pass	-
3.3	15.247(e)	Power Spectral Density	Pass	-
3.4	15.247(d)	Conducted Band Edges	Pass	-
		Conducted Spurious Emission	Pass	-
3.5	15.247(d)	Radiated Band Edges and Radiated Spurious Emission	Pass	Under limit 3.29 dB at 2390.000 MHz
3.6	15.207	AC Conducted Emission	Pass	Under limit 7.66 dB at 1.066 MHz
3.7	15.203 & 15.247(b)	Antenna Requirement	Pass	-

Reviewed by: Wii Chang

Report Producer: Natasha Hsieh



# 1 General Description

## 1.1 Product Feature of Equipment Under Test

GSM/WCDMA/LTE, Bluetooth, DTS/UNII a/b/g/n/ac, FM Receiver, NFC, and GNSS.

Standards-related Product Specification	
Antenna Type / Gain	Coupling Antenna with gain -1.9 dBi

EUT Information List			
HW Version	SW Version	S/N	Performed Test Item
A	1.27	CQ30013BRU	RF conducted measurement
		CQ300199ZW	Radiated Spurious Emission
		CQ30013CF3	AC Conducted Emission

Accessory List	
AC Adapter	Model Name: UCH32
	S/N: 6218W30200215 (for radiated emission) 6218W30200140 (for conducted emission)
	Model Name: MH410c
Earphone	S/N: N/A
	Model Name: UCB24
USB Cable	S/N: N/A

**Note:**

1. Above EUT list used are electrically identical per declared by manufacturer.
2. Above the accessories list are used to exercise the EUT during test, and the serial number of each type of accessories is listed in each section of this report. .
3. For other wireless features of this EUT, test report will be issued separately.

## 1.2 Modification of EUT

No modifications are made to the EUT during all test items.



### 1.3 Testing Location

Sporton Lab is accredited to ISO 17025 by Taiwan Accreditation Foundation (TAF code : 1190) and the FCC designation No. TW1190 and TW0007 under the FCC 2.948(e) by Mutual Recognition Agreement (MRA) in FCC Test.

<b>Test Site</b>	SPORTON INTERNATIONAL INC.	
<b>Test Site Location</b>	No.52, Huaya 1st Rd., Guishan Dist., Taoyuan City, Taiwan (R.O.C.) TEL: +886-3-327-3456 FAX: +886-3-328-4978	
<b>Test Site No.</b>	<b>Sporton Site No.</b>	
	TH05-HY	CO05-HY

**Note:** The test site complies with ANSI C63.4 2014 requirement.

<b>Test Site</b>	SPORTON INTERNATIONAL INC.	
<b>Test Site Location</b>	No.58, Aly. 75, Ln. 564, Wenhua 3rd, Rd., Guishan Dist., Taoyuan City, Taiwan (R.O.C.) TEL: +886-3-327-0868 FAX: +886-3-327-0855	
<b>Test Site No.</b>	<b>Sporton Site No.</b>	
	03CH12-HY	

**Note:** The test site complies with ANSI C63.4 2014 requirement.

### 1.4 Applicable Standards

According to the specifications of the manufacturer, the EUT must comply with the requirements of the following standards:

- ♦ FCC Part 15 Subpart C §15.247
- ♦ FCC KDB Publication No. 558074 D01 DTS Meas. Guidance v05
- ♦ FCC KDB 414788 D01 Radiated Test Site v01r01.
- ♦ ANSI C63.10-2013

**Remark:**

1. All test items were verified and recorded according to the standards and without any deviation during the test.
2. This EUT has also been tested and complied with the requirements of FCC Part 15, Subpart B, recorded in a separate test report.



## 2 Test Configuration of Equipment Under Test

- a. The EUT has been associated with peripherals and configuration operated in a manner tended to maximize its emission characteristics in a typical application. Frequency range investigated: conduction emission (150 kHz to 30 MHz), radiation emission (9 kHz to the 10th harmonic of the highest fundamental frequency or to 40 GHz, whichever is lower). For radiated measurement, pre-scanned in three orthogonal panels, X, Y, Z. The worst cases (X plane) were recorded in this report.
- b. AC power line Conducted Emission was tested under maximum output power.

### 2.1 Carrier Frequency and Channel

Frequency Band	Channel	Freq. (MHz)	Channel	Freq. (MHz)
2400-2483.5 MHz	1	2412	8	2447
	2	2417	9	2452
	3	2422	10	2457
	4	2427	11	2462
	5	2432	12	2467
	6	2437	13	2472
	7	2442		

### 2.2 Test Mode

Final test modes are considering the modulation and worse data rates as below table.

Modulation	Data Rate
802.11b	1 Mbps
802.11g	6 Mbps
802.11n HT20	MCS0

Test Cases	
AC Conducted Emission	Mode 1 :Bluetooth Link + WLAN (2.4GHz) Link + Earphone + Battery + USB Cable (Charging from Adapter)

## 2.3 Connection Diagram of Test System

<WLAN Tx Mode>

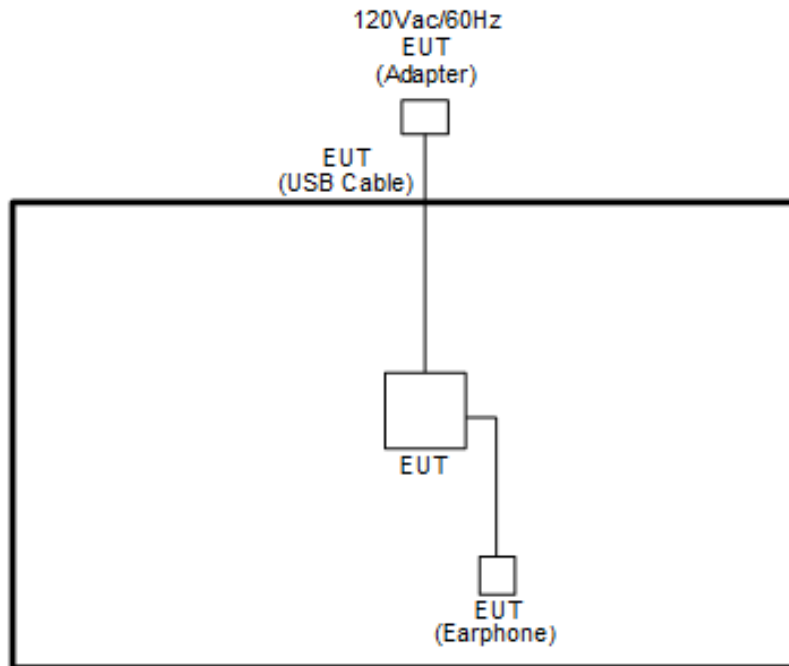

<AC Conducted Emissions>

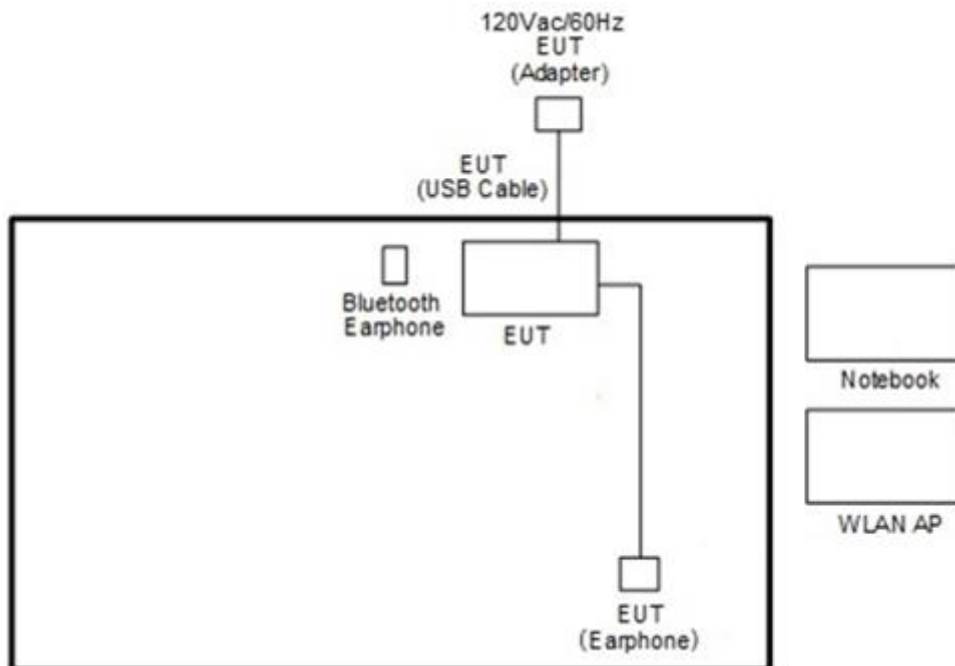



## 2.4 Support Unit used in test configuration and system

Item	Equipment	Trade Name	Model Name	FCC ID	Data Cable	Power Cord
1.	WLAN AP	ASUS	RT-AC66U	MSQ-RTAC66U	N/A	Unshielded, 1.8 m
2.	Bluetooth Earphone	Sony	SBH20	PY7-RD0010	N/A	N/A
3.	Notebook	DELL	P20G	FCC DoC/ Contains FCC ID: QDS-BRCM1051	N/A	AC I/P: Unshielded, 1.2 m DC O/P: Shielded, 1.8 m
4.	SD Card	SanDisk	MicroSD HC	FCC DoC	N/A	N/A

## 2.5 EUT Operation Test Setup

The RF test items, utility “QRCT” was installed in Notebook which was programmed in order to make the EUT get into the engineering modes to provide channel selection, power level, data rate and the application type and for continuous transmitting signals.

## 2.6 Measurement Results Explanation Example

**For all conducted test items:**

The offset level is set in the spectrum analyzer to compensate the RF cable loss and attenuator factor between EUT conducted output port and spectrum analyzer. With the offset compensation, the spectrum analyzer reading level is exactly the EUT RF output level.

Example:

The spectrum analyzer offset is derived from RF cable loss and attenuator factor.

*Offset = RF cable loss + attenuator factor.*

Following shows an offset computation example with cable loss 4.2 dB and 10dB attenuator.

$$\begin{aligned} \text{Offset(dB)} &= \text{RF cable loss(dB)} + \text{attenuator factor(dB)}. \\ &= 4.2 + 10 = 14.2 \text{ (dB)} \end{aligned}$$

### 3 Test Result

#### 3.1 6dB and 99% Bandwidth Measurement

##### 3.1.1 Limit of 6dB and 99% Bandwidth

The minimum 6 dB bandwidth shall be at least 500 kHz.

##### 3.1.2 Measuring Instruments

See list of measuring equipment of this test report.

##### 3.1.3 Test Procedures

1. The testing follows FCC KDB Publication No. 558074 DTS D01 Meas. Guidance v05.
2. The RF output of EUT was connected to the spectrum analyzer by RF cable and attenuator. The path loss was compensated to the results for each measurement.
3. Set to the maximum power setting and enable the EUT transmit continuously.
4. Make the measurement with the spectrum analyzer's resolution bandwidth (RBW) = 100 kHz. Set the Video bandwidth (VBW) = 300 kHz. In order to make an accurate measurement. The 6 dB bandwidth must be greater than 500 kHz.
5. For 99% Bandwidth Measurement, the spectrum analyzer's resolution bandwidth (RBW) is set 1-5% of the emission bandwidth and set the Video bandwidth (VBW)  $\geq 3 * RBW$ .
6. Measure and record the results in the test report.

##### 3.1.4 Test Setup

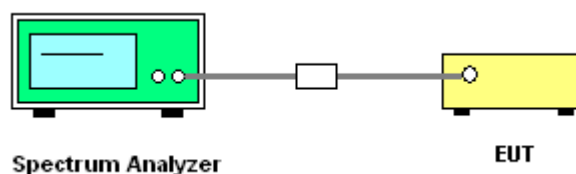



### 3.1.5 Test Result of 6dB and 99% Occupied Bandwidth

Please refer to Appendix A.

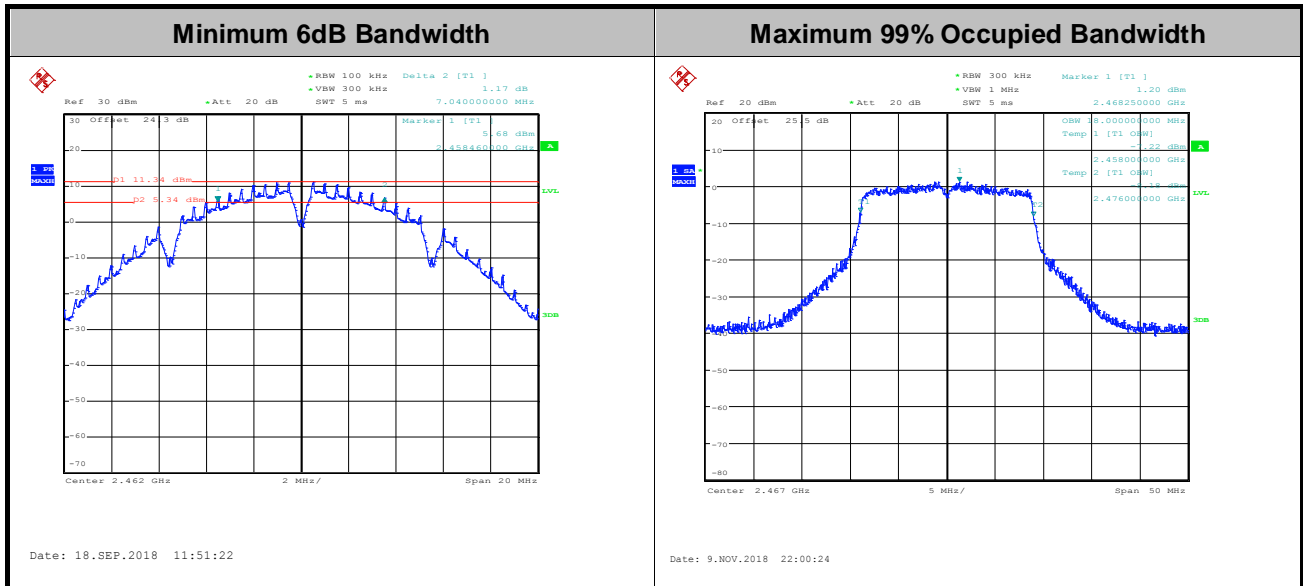

Note: The occupied channel bandwidth is maintained within the band of operation for all of the modulations.

## 3.2 Output Power Measurement

### 3.2.1 Limit of Output Power

For systems using digital modulation in the 2400-2483.5MHz, the limit for peak output power is 30dBm. If transmitting antenna with directional gain greater than 6dBi is used, the peak output power from the intentional radiator shall be reduced below the above stated value by the amount in dB that the directional gain of the antenna exceeds 6 dBi. In case of point-to-point operation, the limit has to be reduced by 1dB for every 3dB that the directional gain of the antenna exceeds 6dBi.

### 3.2.2 Measuring Instruments

See list of measuring equipment of this test report.

### 3.2.3 Test Procedures

1. For Peak Power, the testing follows the Measurement Procedure of FCC KDB No. 558074 DTS D01 Meas. Guidance v05 section 9.1.3 PKPM1 Peak power meter method.
2. For Average Power, the testing follows the Measurement Procedure of FCC KDB No. 558074 DTS D01 Meas. Guidance v05 section 9.2.3.1 Method AVGPM.
3. The RF output of EUT was connected to the power meter by RF cable and attenuator. The path loss was compensated to the results for each measurement.
4. Set to the maximum power setting and enable the EUT transmit continuously.
5. Measure the conducted output power and record the results in the test report.

### 3.2.4 Test Setup

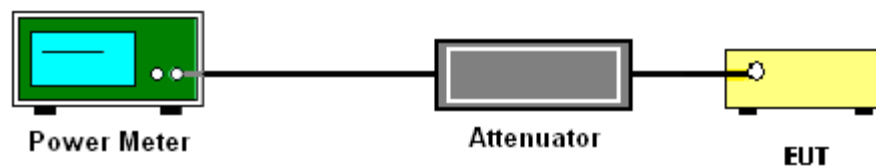

### 3.2.5 Test Result of Peak Output Power

Please refer to Appendix A.

### 3.2.6 Test Result of Average output Power (Reporting Only)

Please refer to Appendix A.

### 3.3 Power Spectral Density Measurement

#### 3.3.1 Limit of Power Spectral Density

The peak power spectral density shall not be greater than 8dBm in any 3kHz band at any time interval of continuous transmission.

#### 3.3.2 Measuring Instruments

See list of measuring equipment of this test report.

#### 3.3.3 Test Procedures

1. The testing follows Measurement Procedure 10.2 Method PKPSD of FCC KDB Publication No. 558074 D01 DTS Meas. Guidance v05
2. The RF output of EUT was connected to the spectrum analyzer by RF cable and attenuator. The path loss was compensated to the results for each measurement.
3. Set to the maximum power setting and enable the EUT transmit continuously.
4. Make the measurement with the spectrum analyzer's resolution bandwidth (RBW) = 3 kHz. Video bandwidth VBW = 10 kHz In order to make an accurate measurement, set the span to 1.5 times DTS Channel Bandwidth. (6dB BW)
5. Detector = peak, Sweep time = auto couple, Trace mode = max hold, Allow trace to fully stabilize. Use the peak marker function to determine the maximum power level.
6. Measure and record the results in the test report.

#### 3.3.4 Test Setup

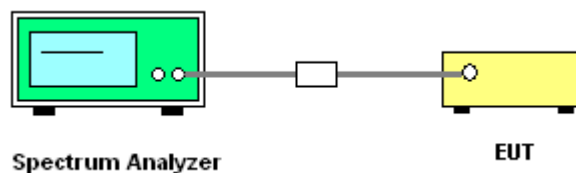



### 3.3.5 Test Result of Power Spectral Density

Please refer to Appendix A.

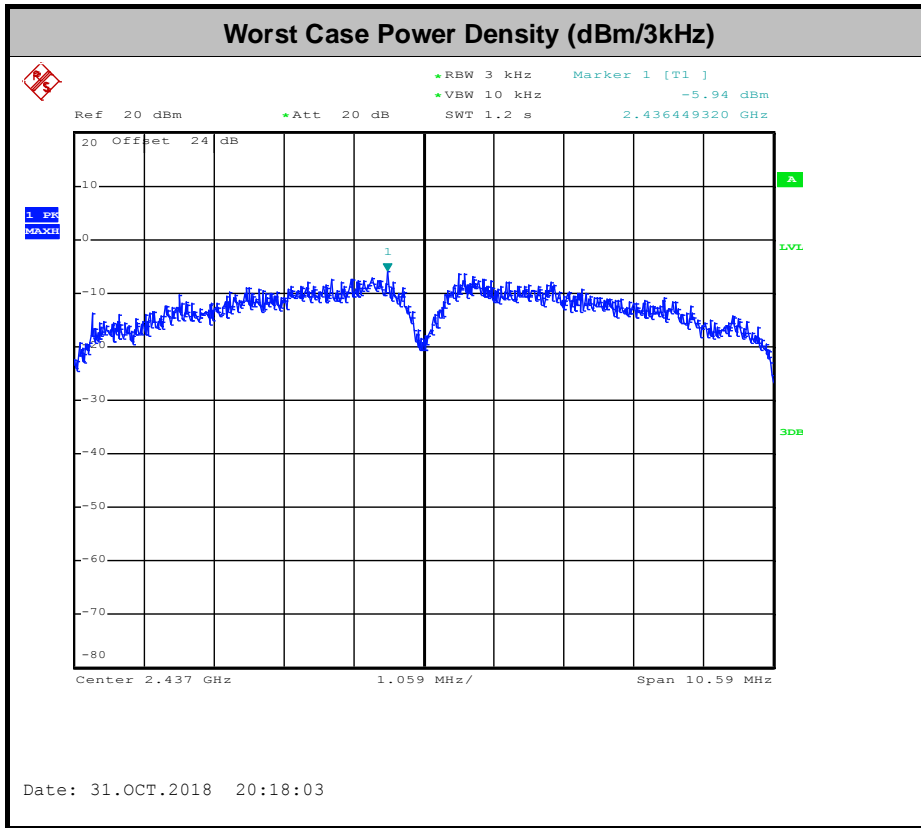

## 3.4 Conducted Band Edges and Spurious Emission Measurement

### 3.4.1 Limit of Conducted Band Edges and Spurious Emission Measurement

In any 100 kHz bandwidth outside of the authorized frequency band, the emissions which fall in the non-restricted bands shall be attenuated at least 20 dB / 30dB relative to the maximum PSD level in 100 kHz by RF conducted measurement.

### 3.4.2 Measuring Instruments

See list of measuring equipment of this test report.

### 3.4.3 Test Procedures

1. The testing follows FCC KDB Publication No. 558074 D01 DTS Meas. Guidance v05.
2. The RF output of EUT was connected to the spectrum analyzer by RF cable and attenuator. The path loss was compensated to the results for each measurement.
3. Set to the maximum power setting and enable the EUT transmit continuously.
4. Set RBW = 100 kHz, VBW=300 kHz, Peak Detector. Unwanted Emissions measured in any 100 kHz bandwidth outside of the authorized frequency band shall be attenuated by at least 20 dB relative to the maximum in-band peak PSD level in 100 kHz when maximum peak conducted output power procedure is used. If the transmitter complies with the conducted power limits based on the use of RMS averaging over a time interval, the attenuation required under this paragraph shall be 30 dB instead of 20 dB per 15.247(d).
5. Measure and record the results in the test report.
6. The RF fundamental frequency should be excluded against the limit line in the operating frequency band.

### 3.4.4 Test Setup

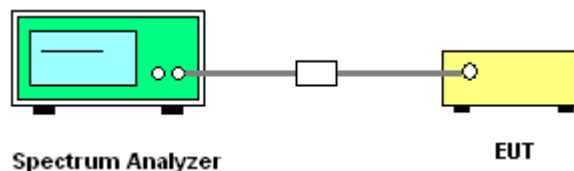



3.4.5 Test Result of Conducted Band Edges and Spurious Emission

Test Engineer : Luffy Lin and Allen Lin	Temperature :	21~25°C
	Relative Humidity :	51~54%

Number of TX = 1, Ant. 1 (Measured)

Test Mode :	802.11b	Test Channel :	01
-------------	---------	----------------	----

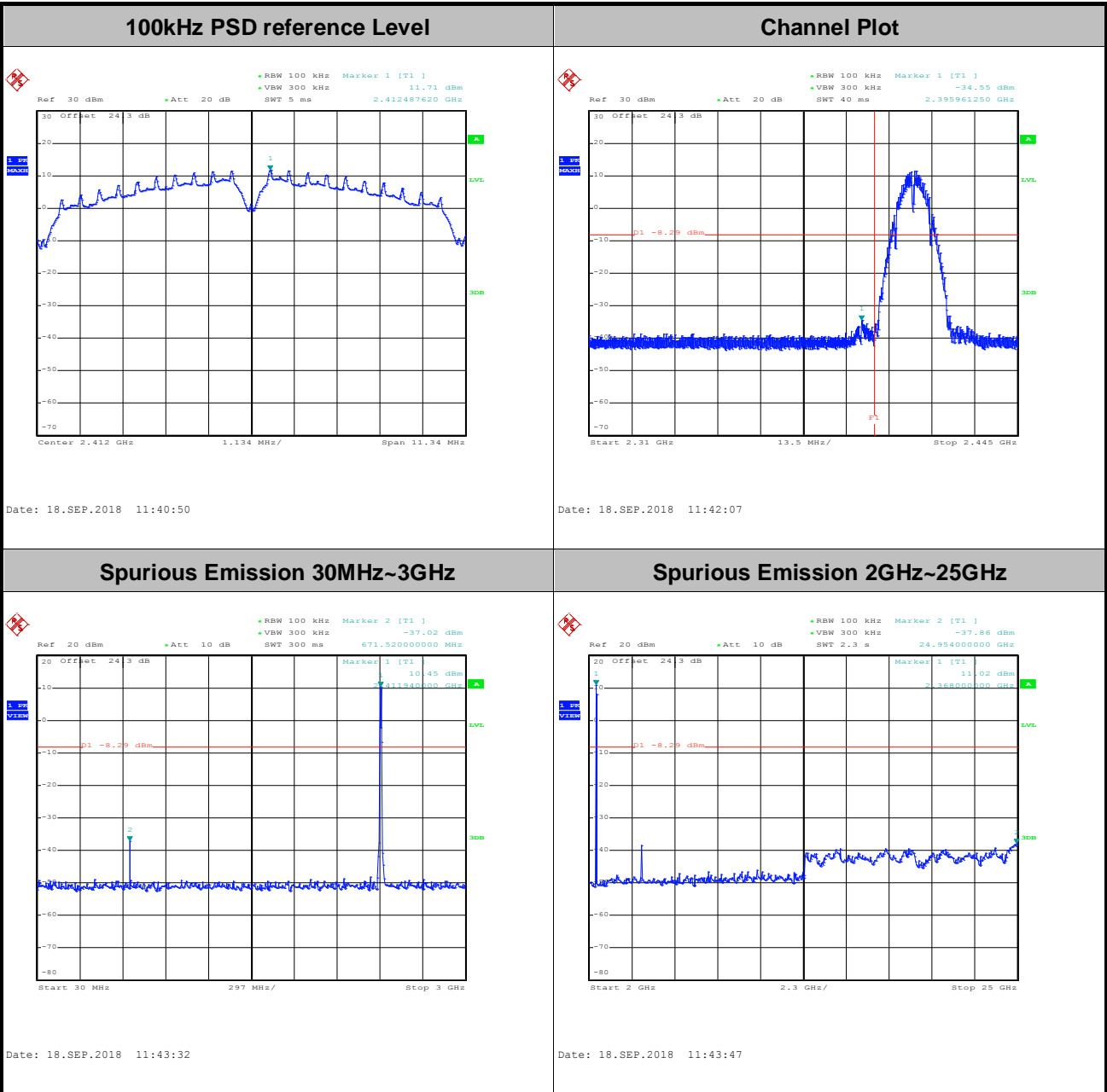





Test Mode :	802.11b	Test Channel :	06
-------------	---------	----------------	----

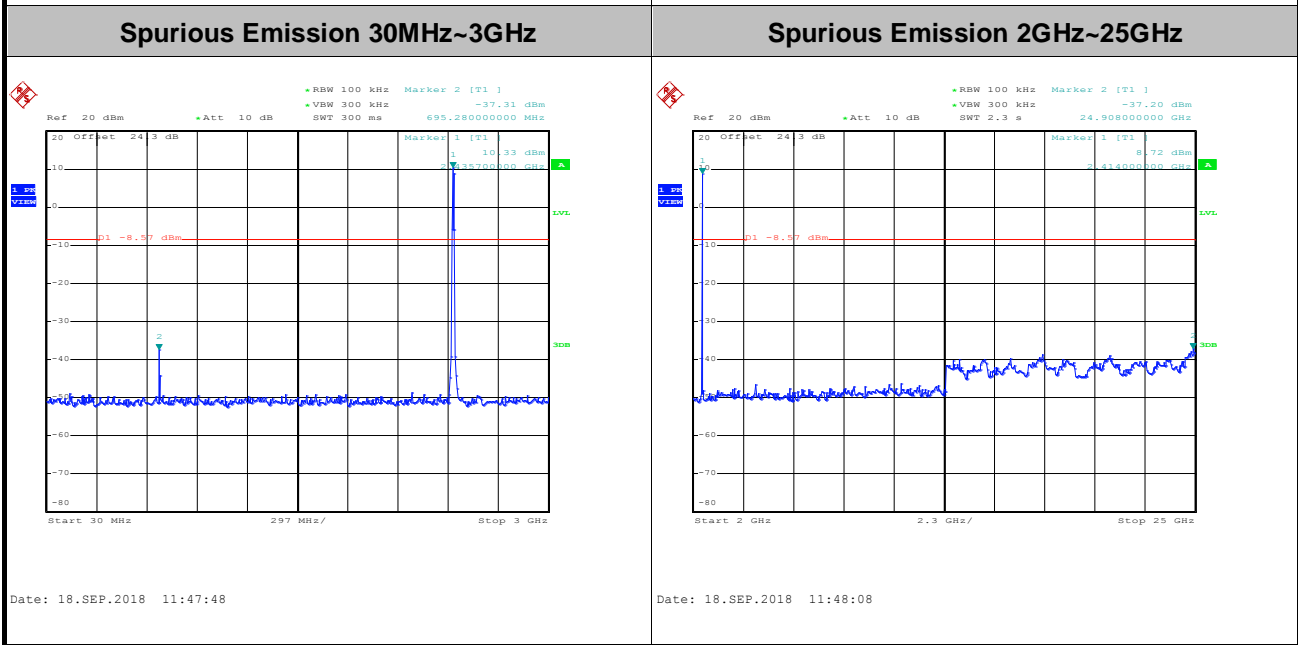
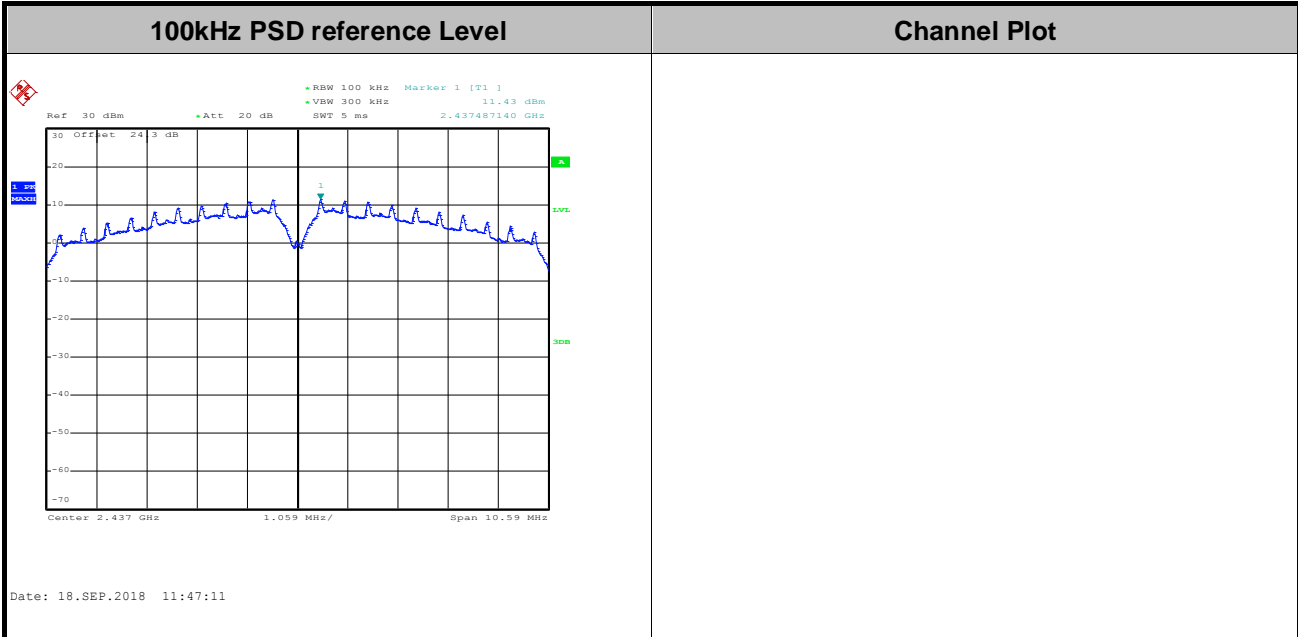



Test Mode :	802.11b	Test Channel :	11
-------------	---------	----------------	----

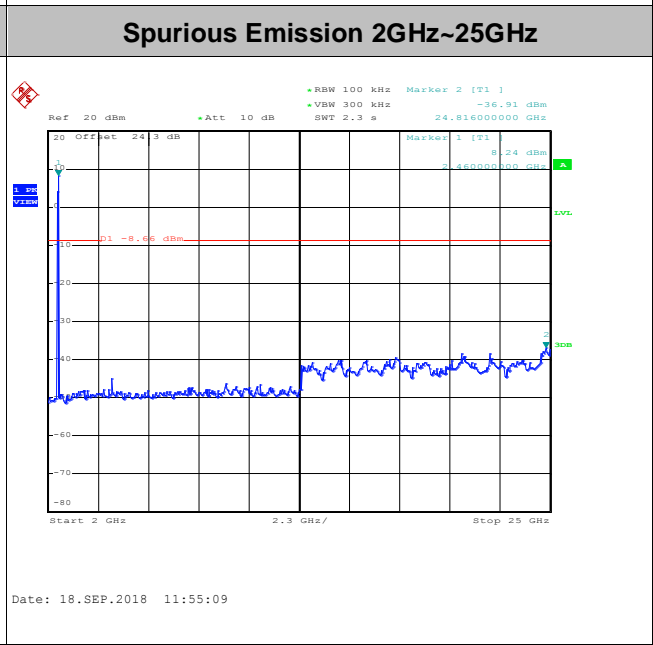
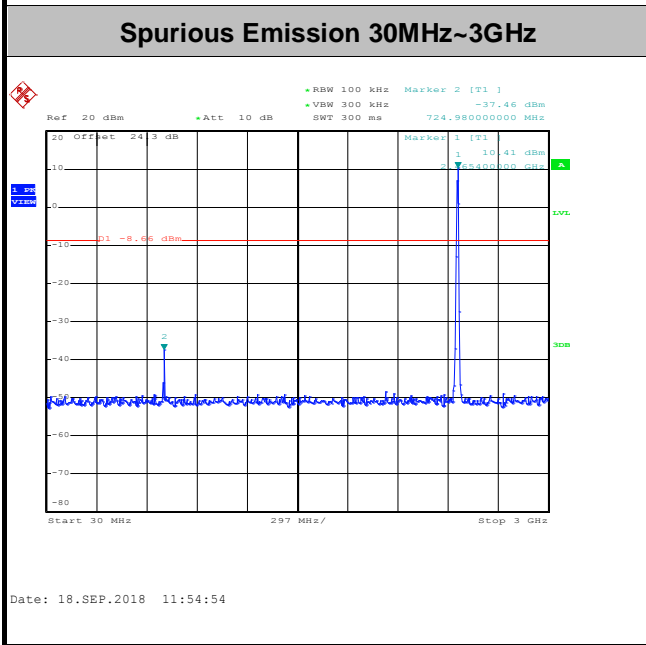
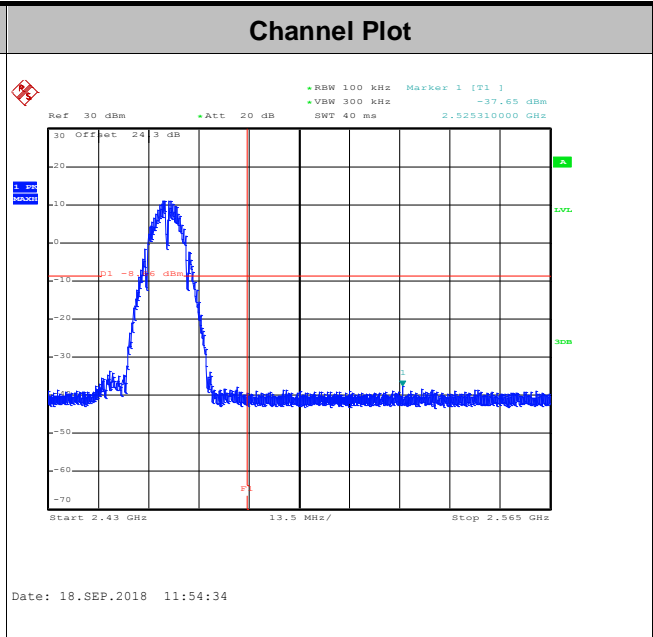
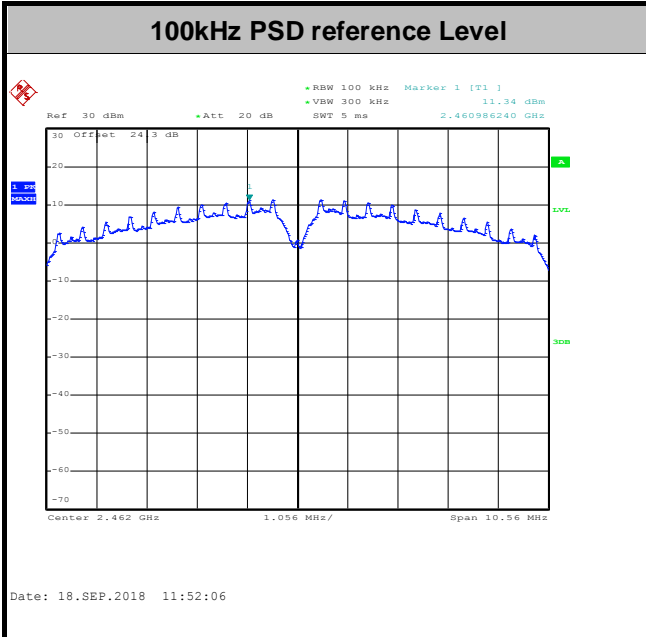



Test Mode :	802.11b	Test Channel :	12
-------------	---------	----------------	----

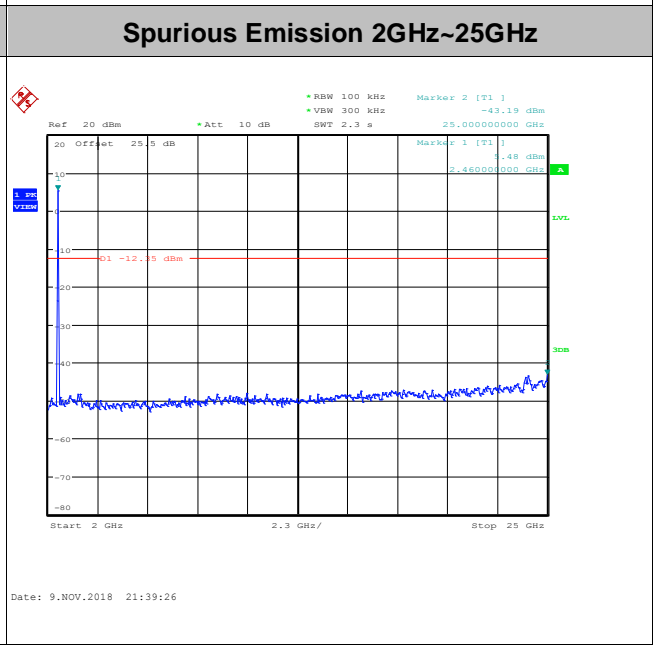
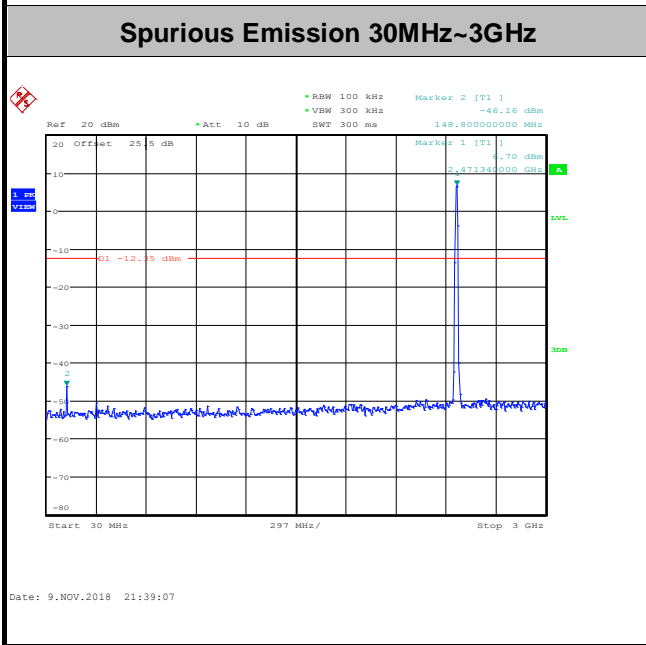
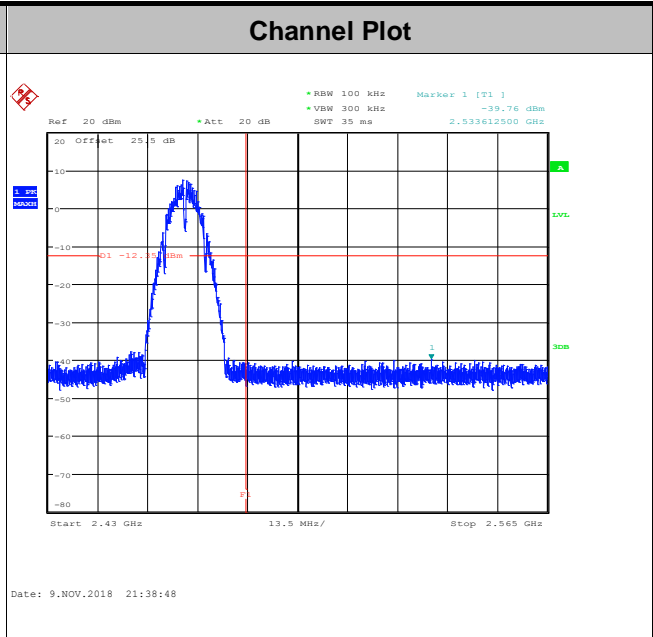
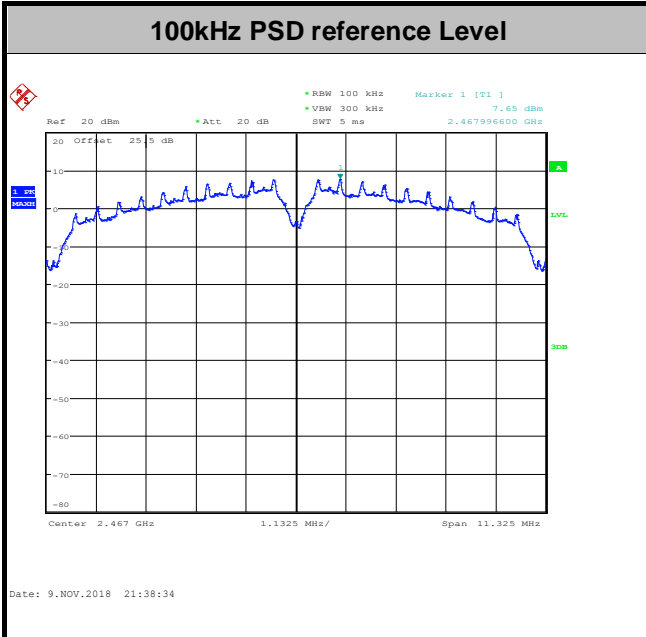



Test Mode :	802.11b	Test Channel :	13
-------------	---------	----------------	----

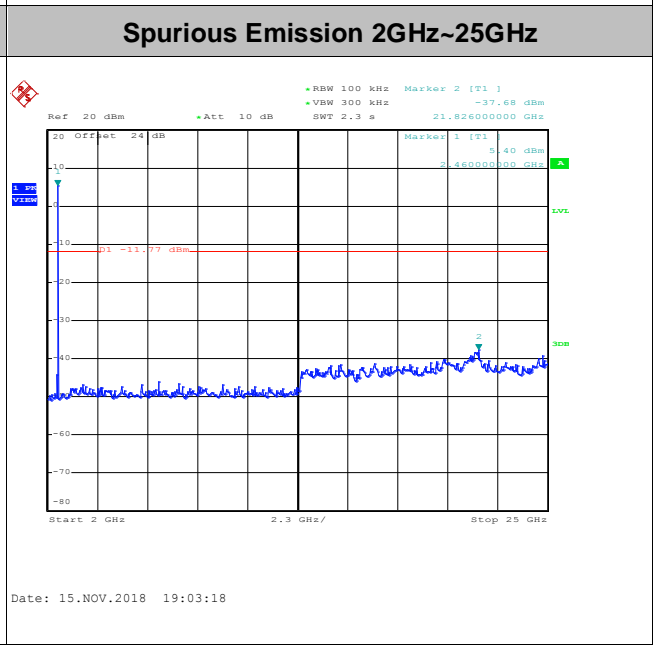
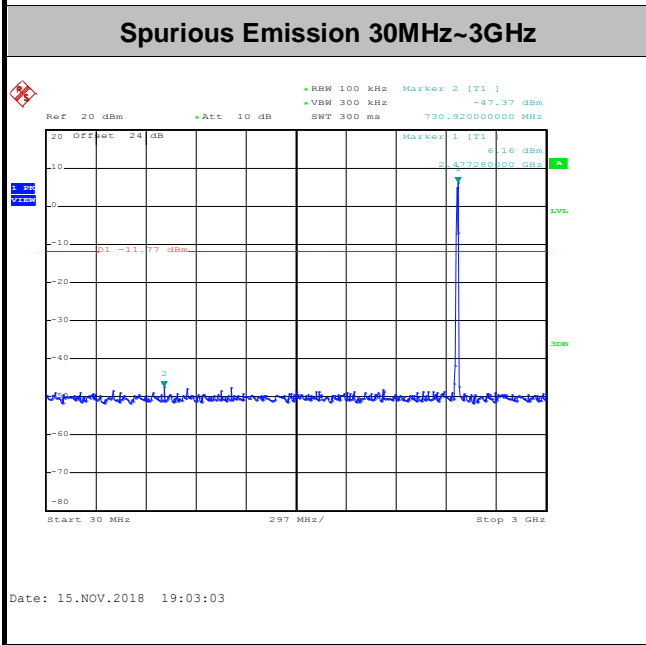
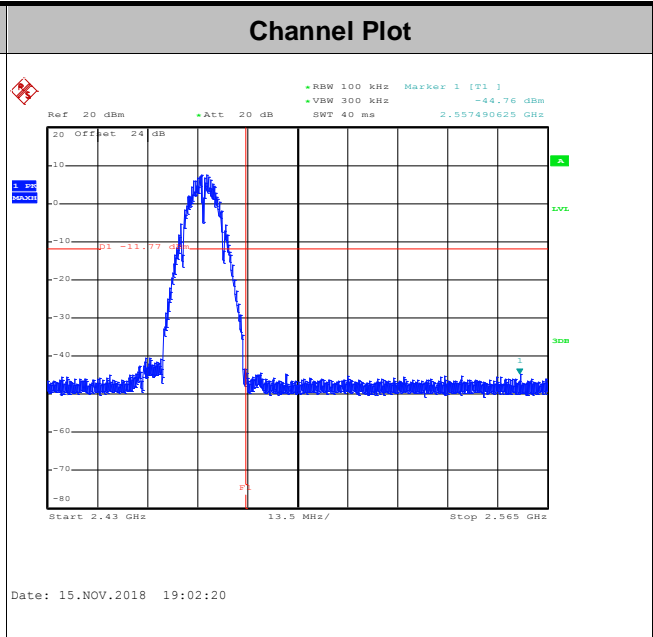
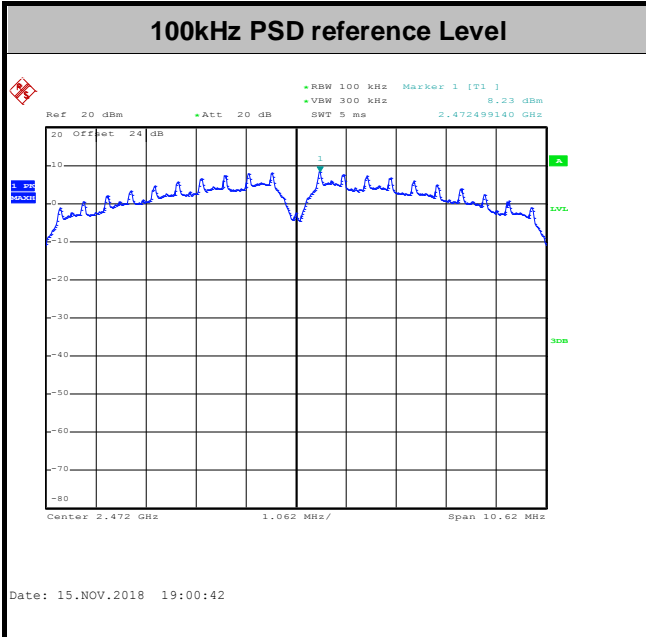



Test Mode :	802.11g	Test Channel :	01
-------------	---------	----------------	----

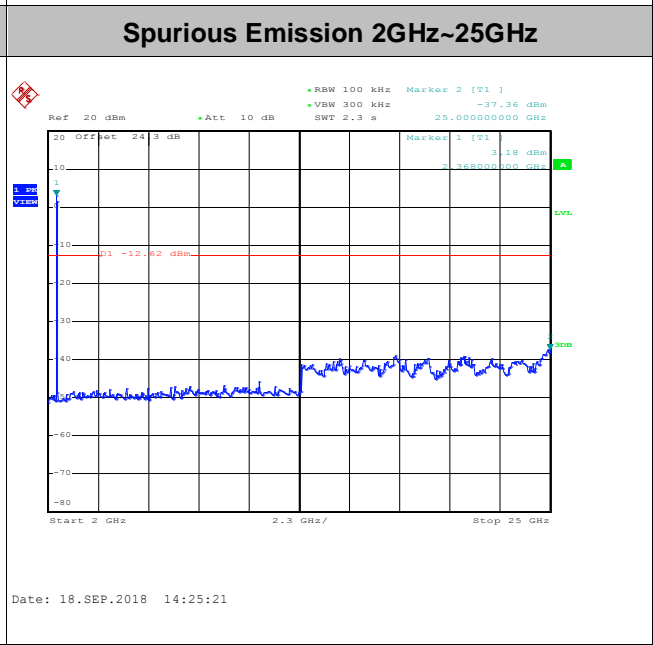
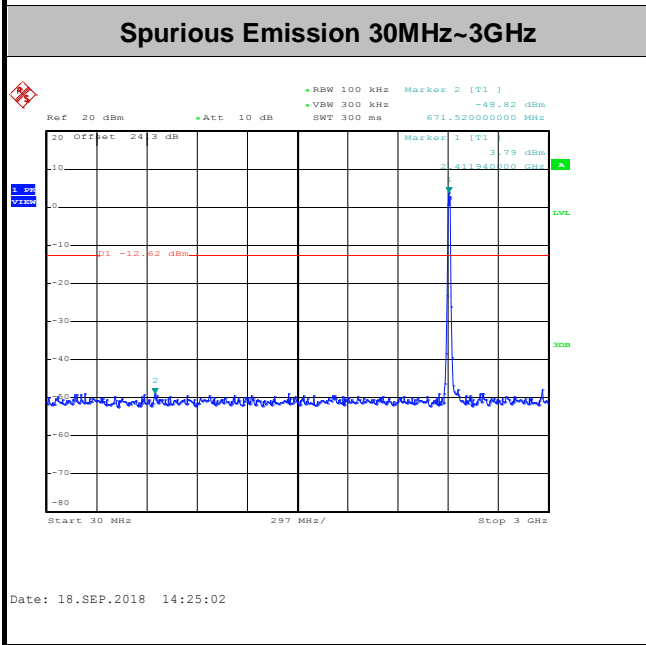
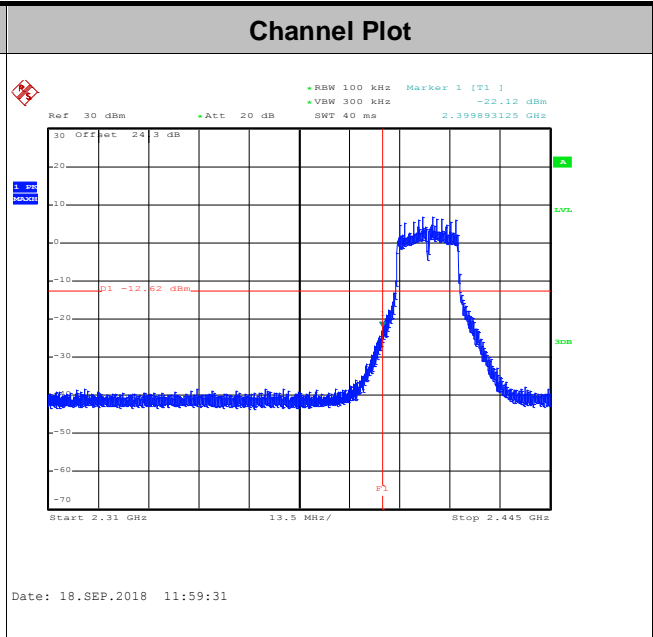
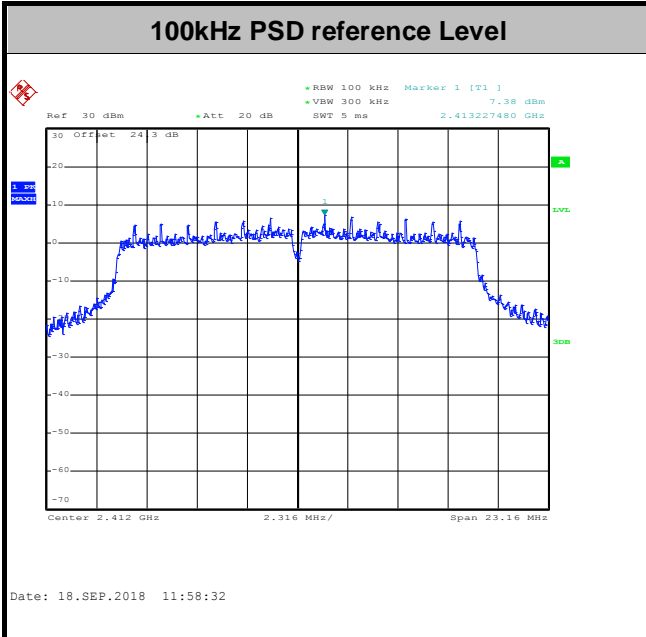



Test Mode :	802.11g	Test Channel :	06
-------------	---------	----------------	----

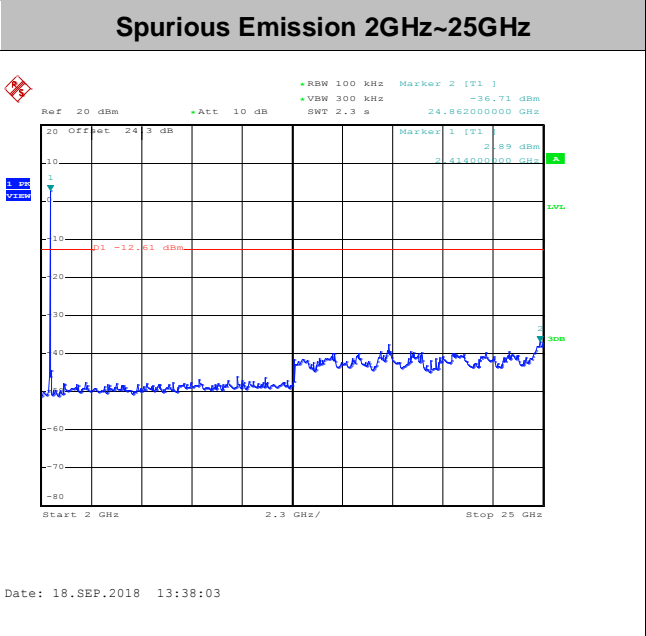
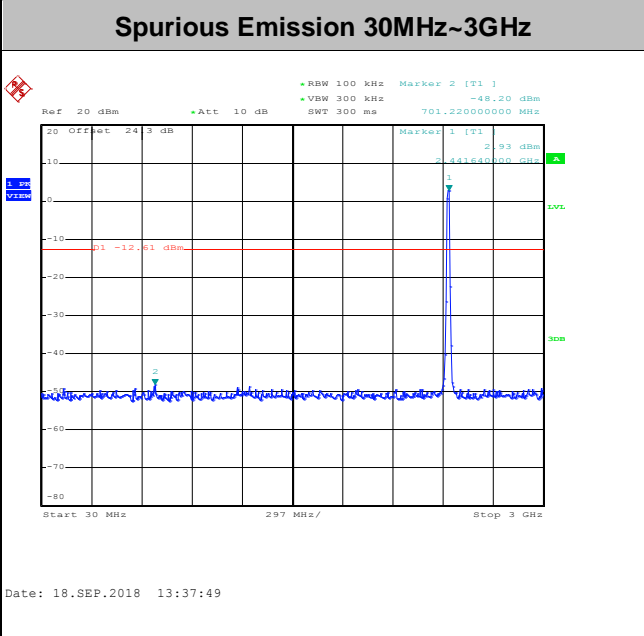
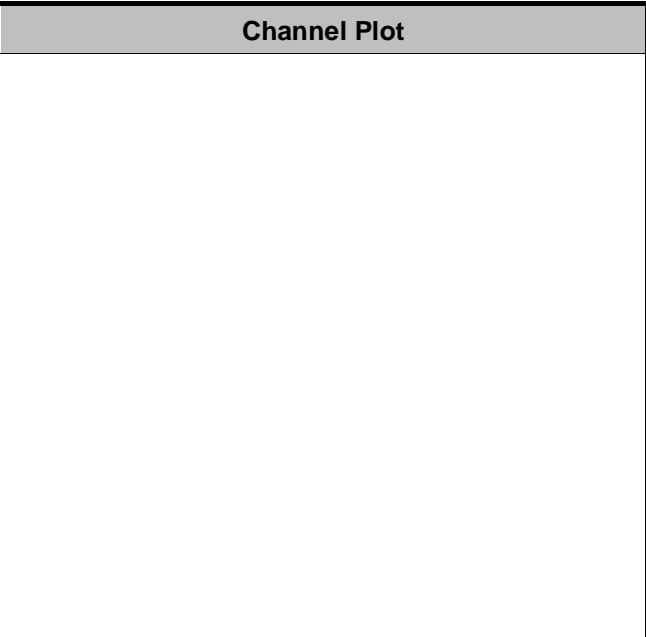
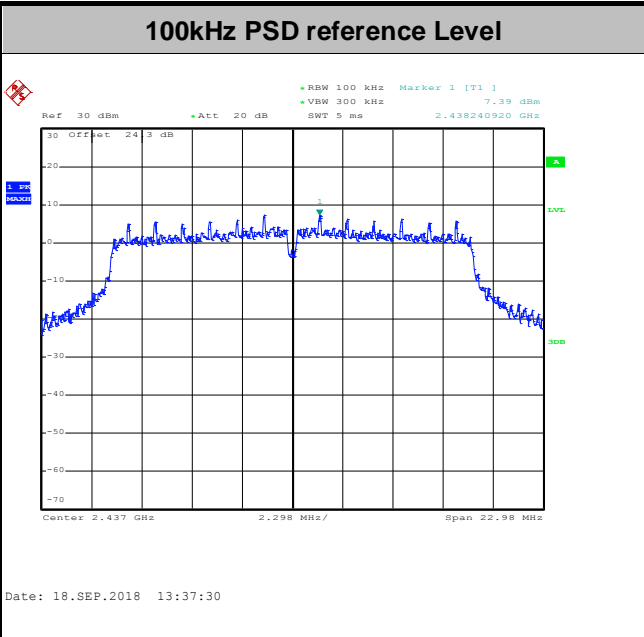



Test Mode :	802.11g	Test Channel :	11
-------------	---------	----------------	----

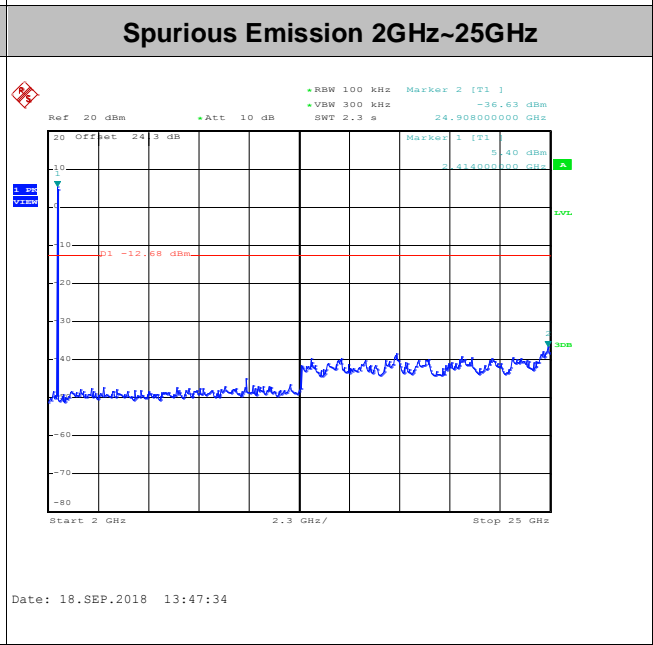
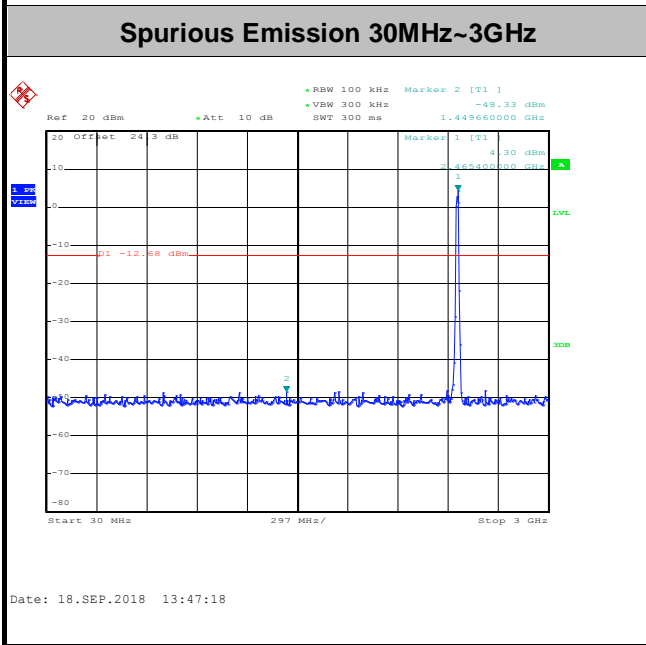
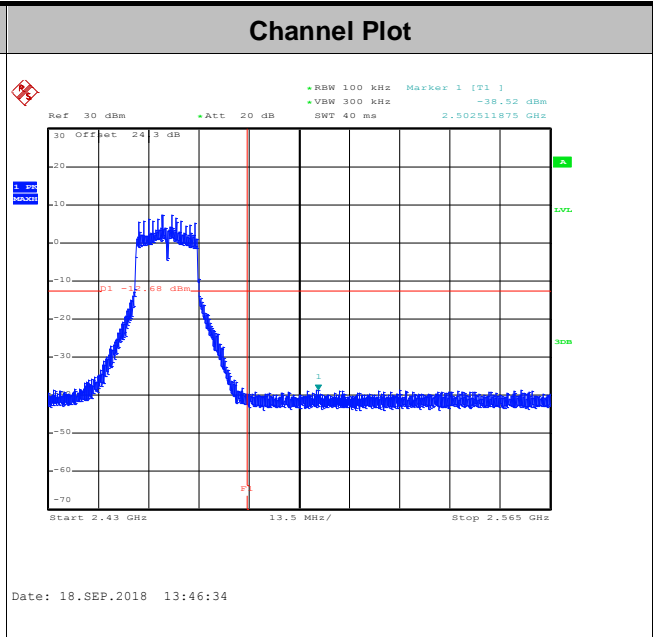
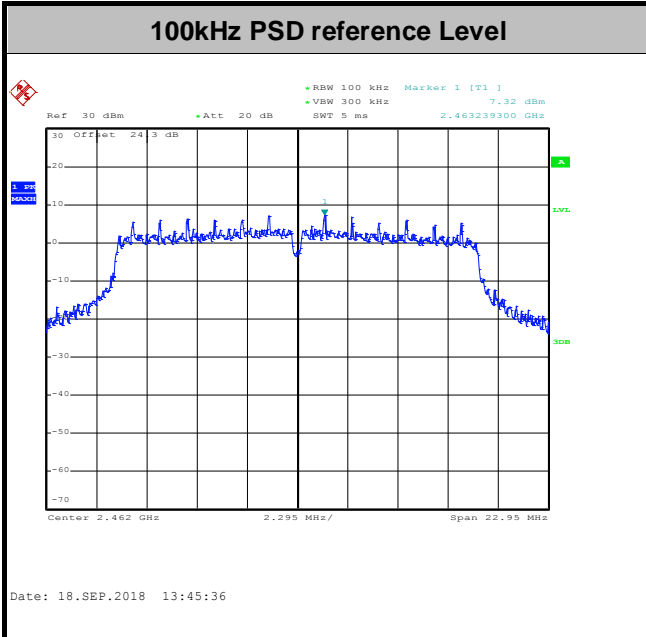



Test Mode :	802.11g	Test Channel :	12
-------------	---------	----------------	----

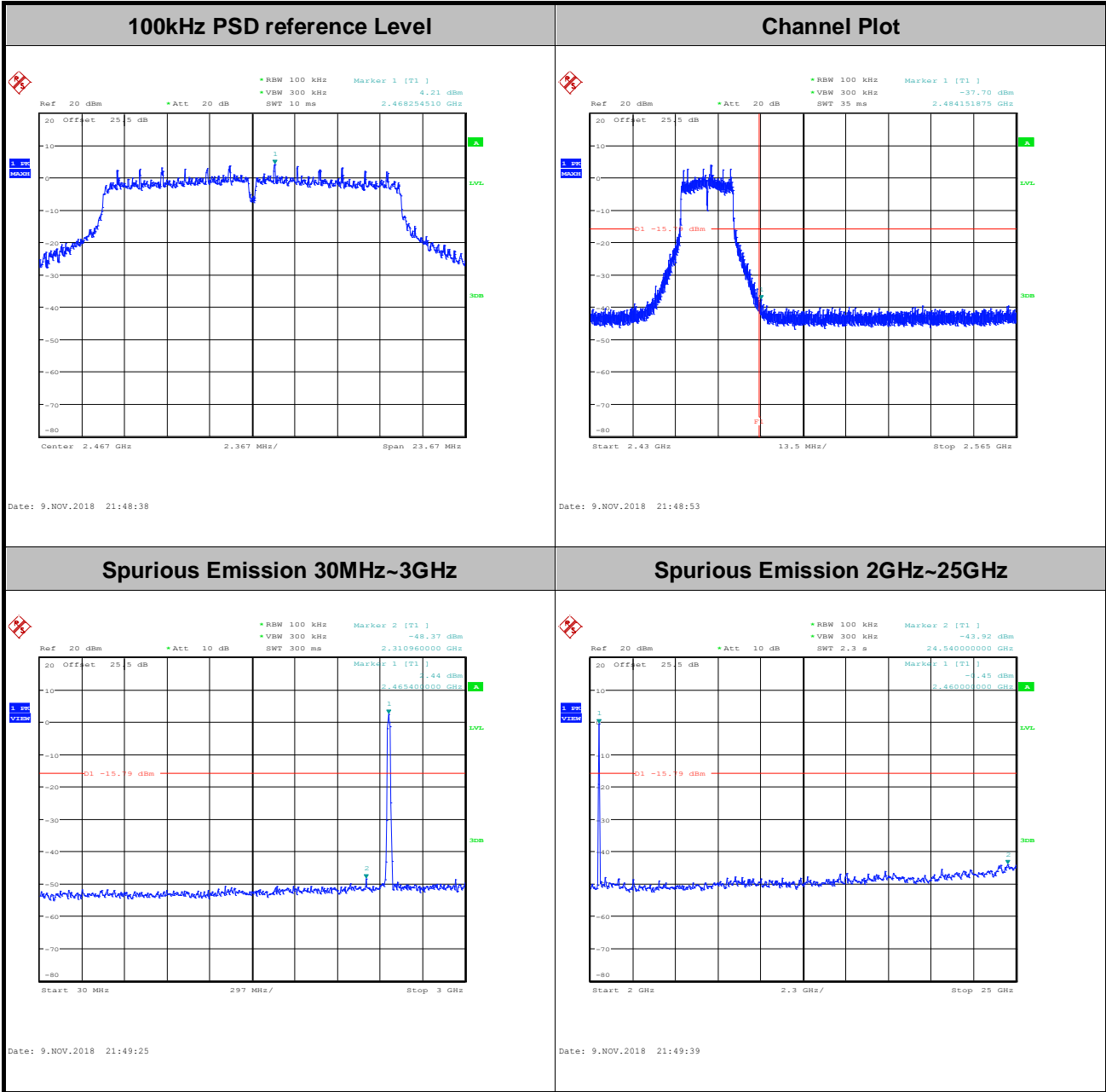





Test Mode :	802.11g	Test Channel :	13
-------------	---------	----------------	----

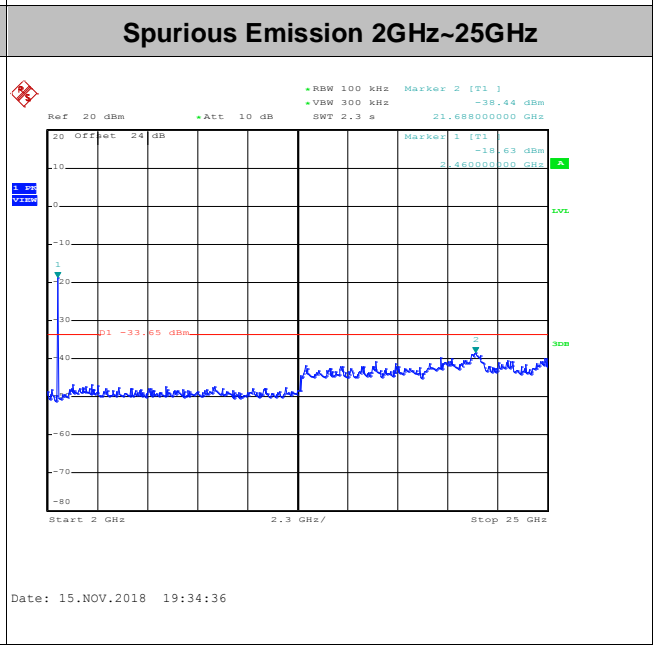
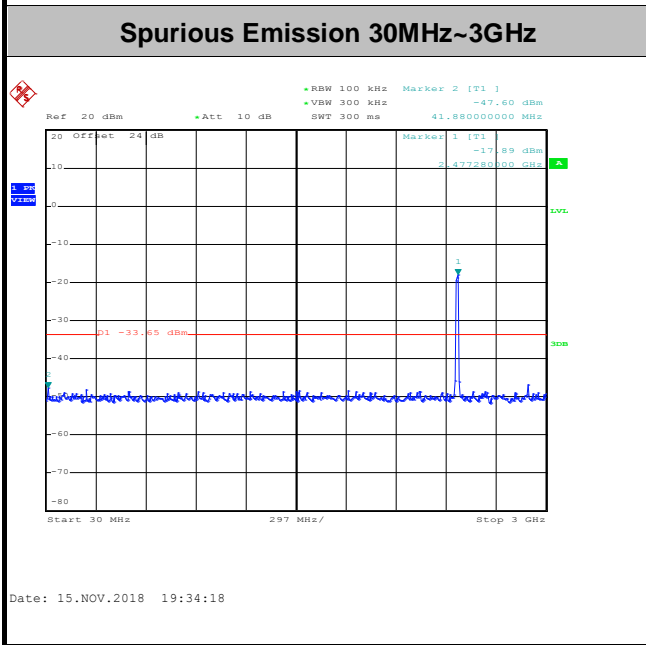
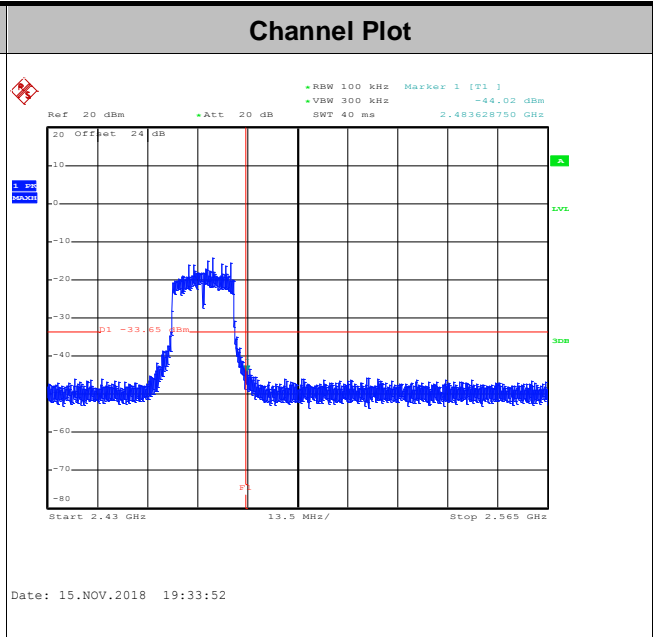
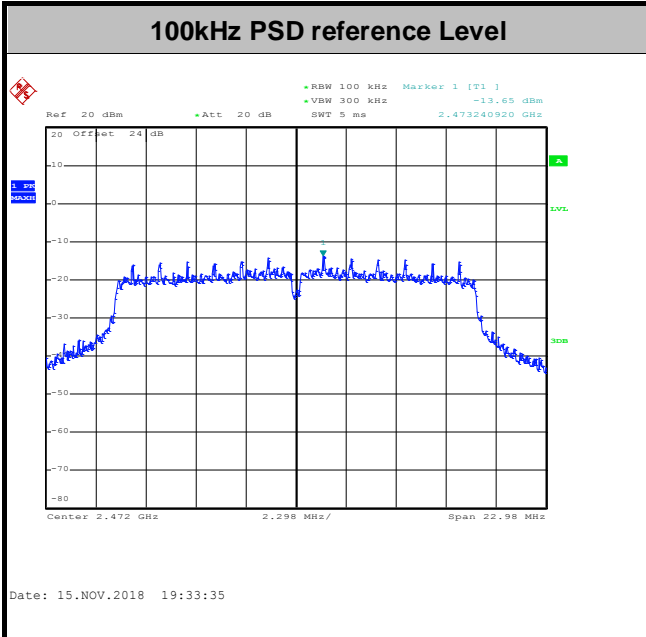



Test Mode : 802.11n HT20 Test Channel : 01

100kHz PSD reference Level

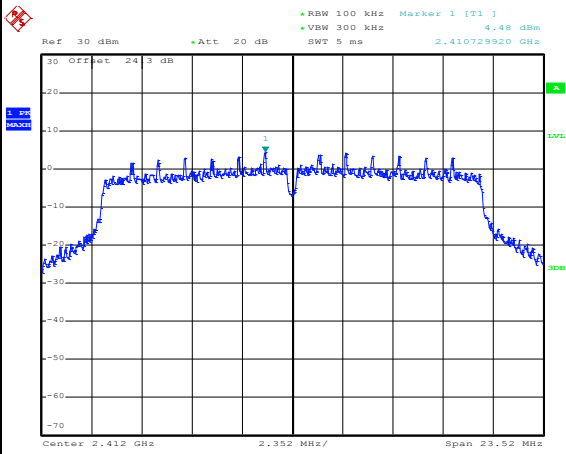

Date: 18.SEP.2018 13:51:13

Channel Plot

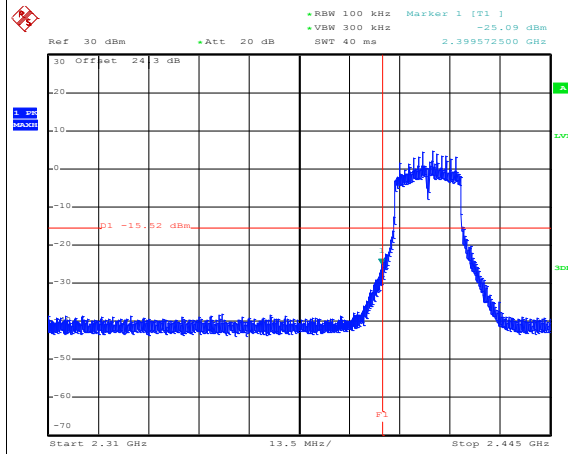

Date: 18.SEP.2018 13:52:08

Spurious Emission 30MHz~3GHz

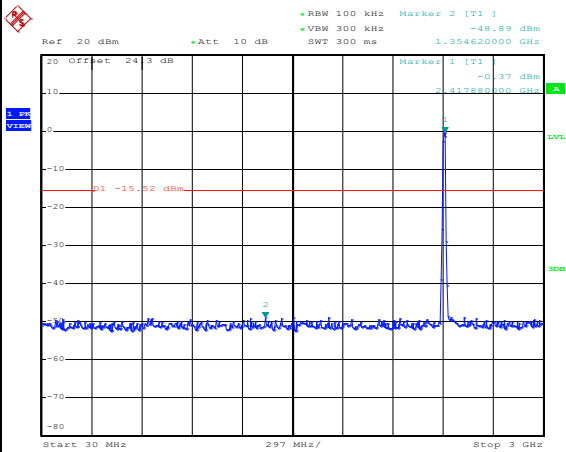

Date: 18.SEP.2018 13:52:42

Spurious Emission 2GHz~25GHz

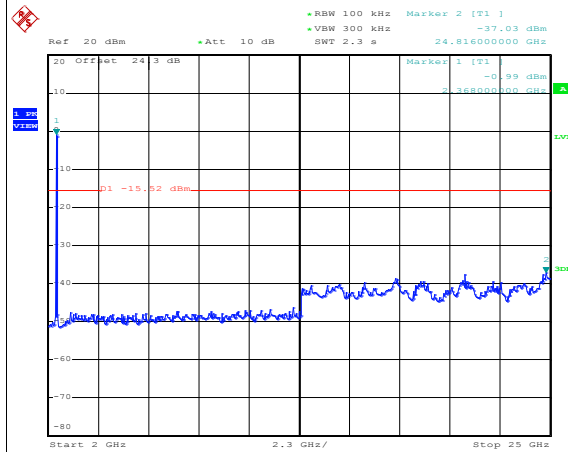

Date: 18.SEP.2018 13:52:57



Test Mode :	802.11n HT20	Test Channel :	06
-------------	--------------	----------------	----

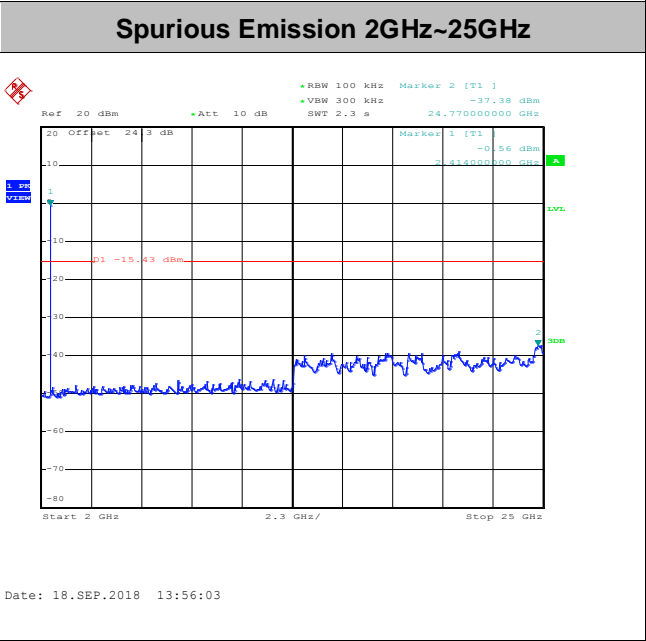
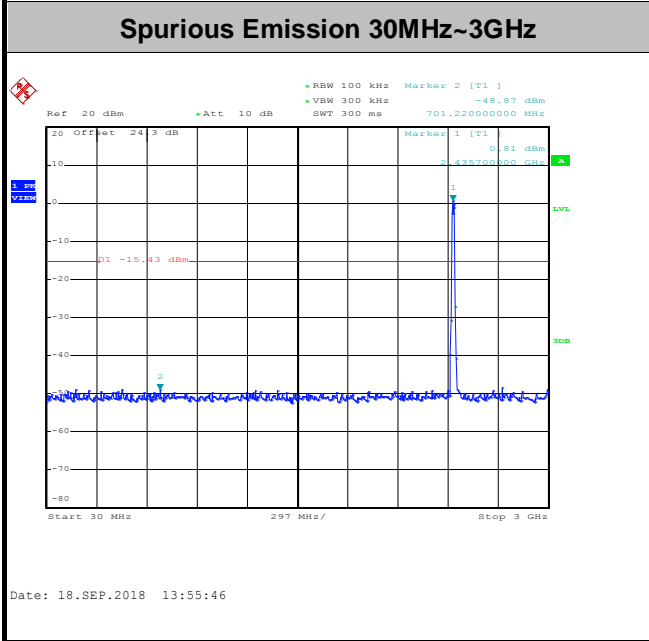
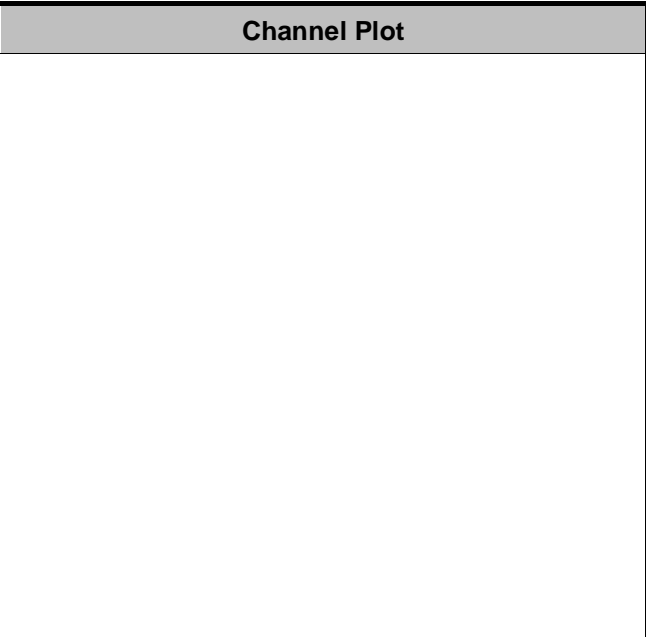
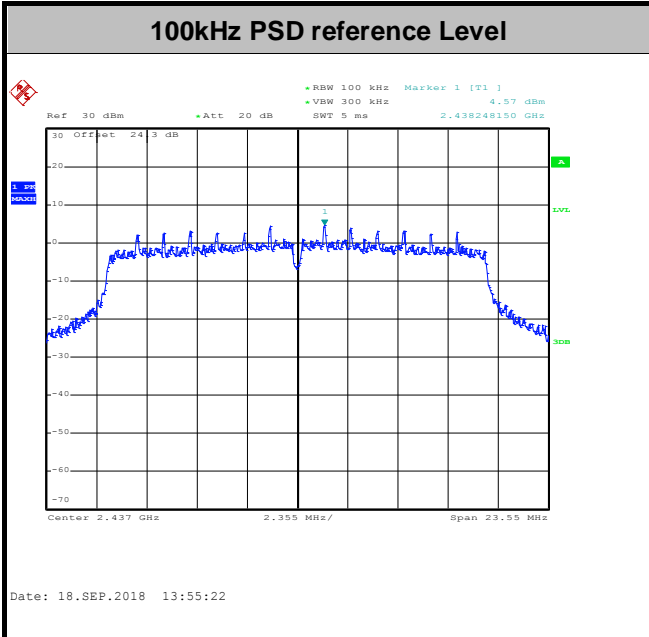



Test Mode :	802.11n HT20	Test Channel :	11
-------------	--------------	----------------	----

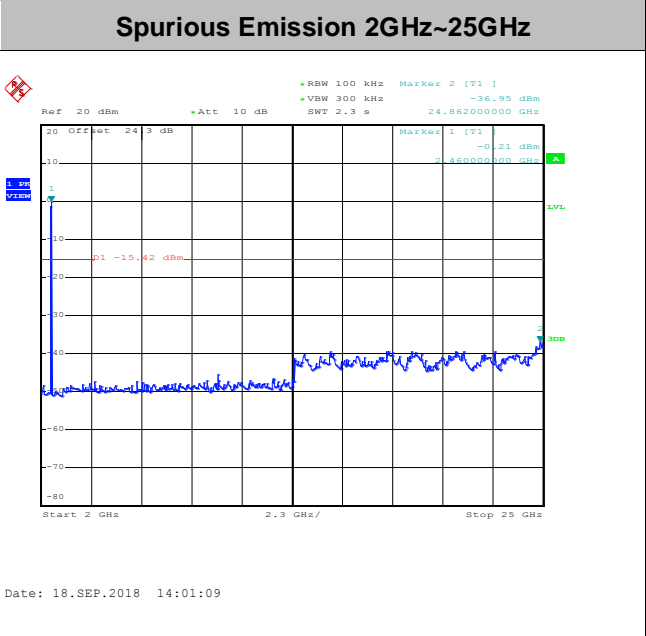
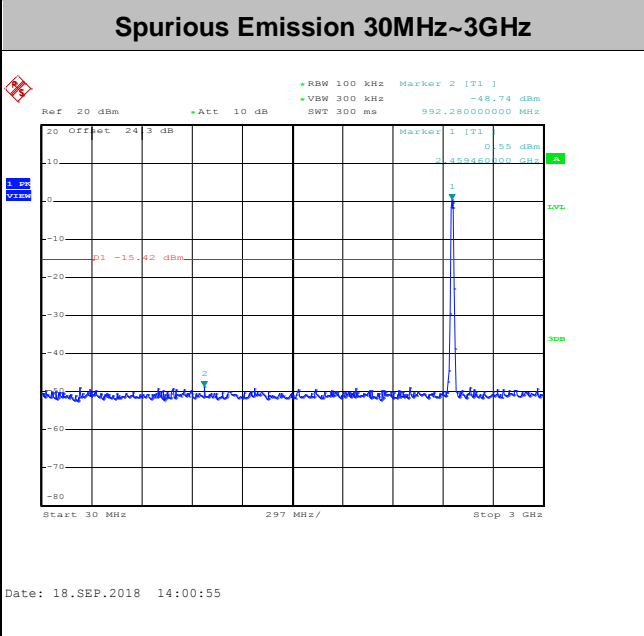
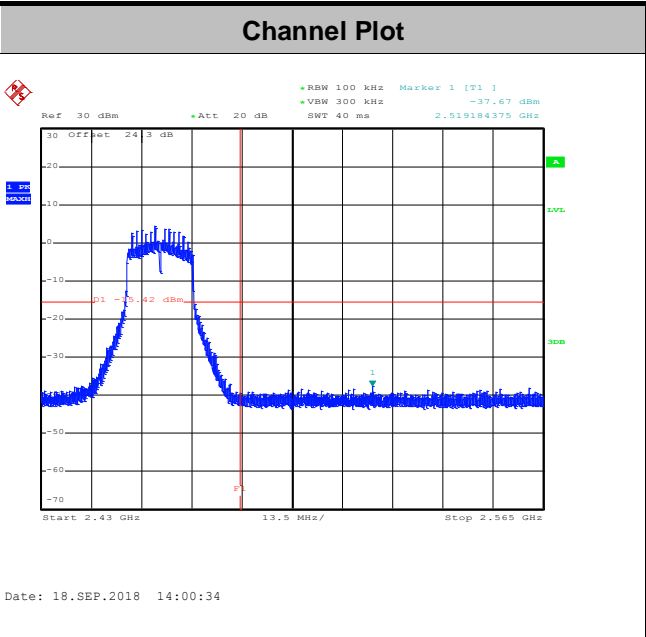
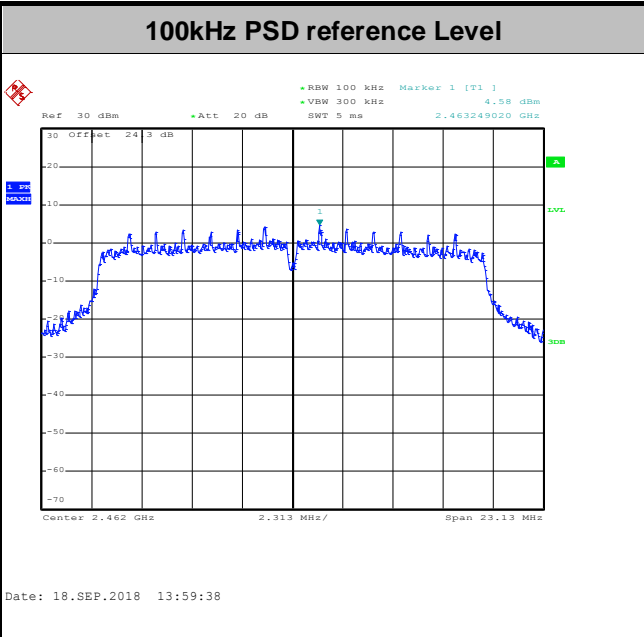



Test Mode :	802.11n HT20	Test Channel :	12
-------------	--------------	----------------	----

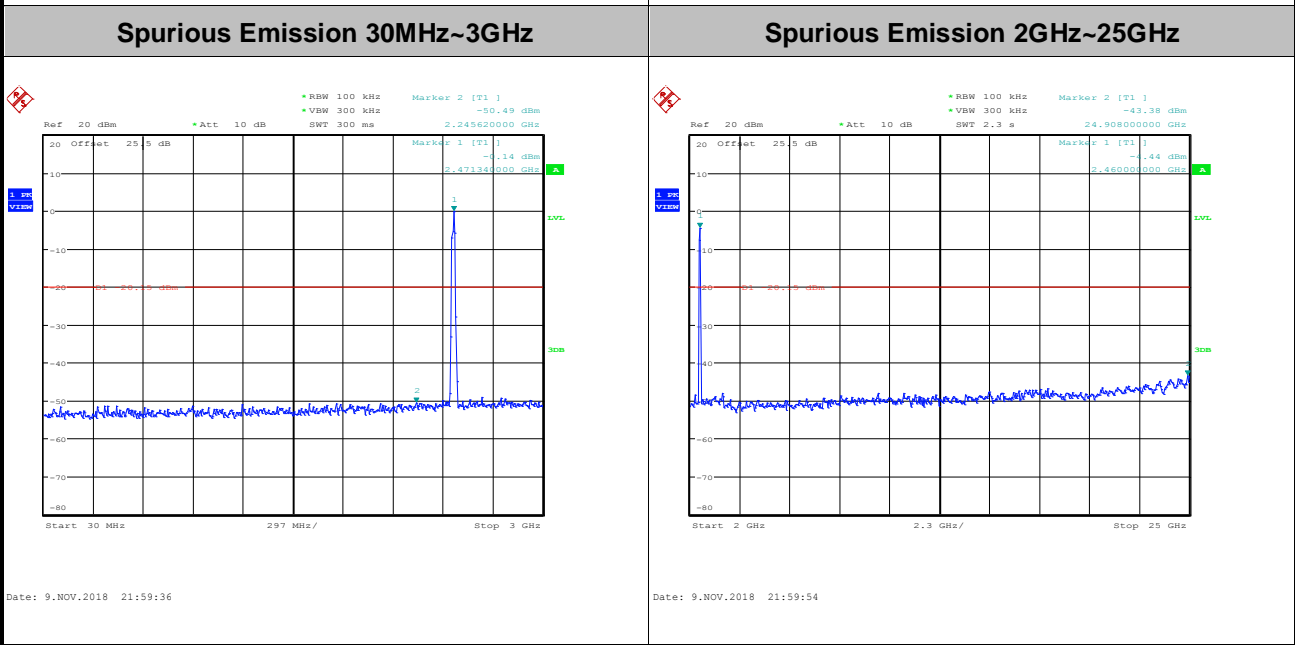
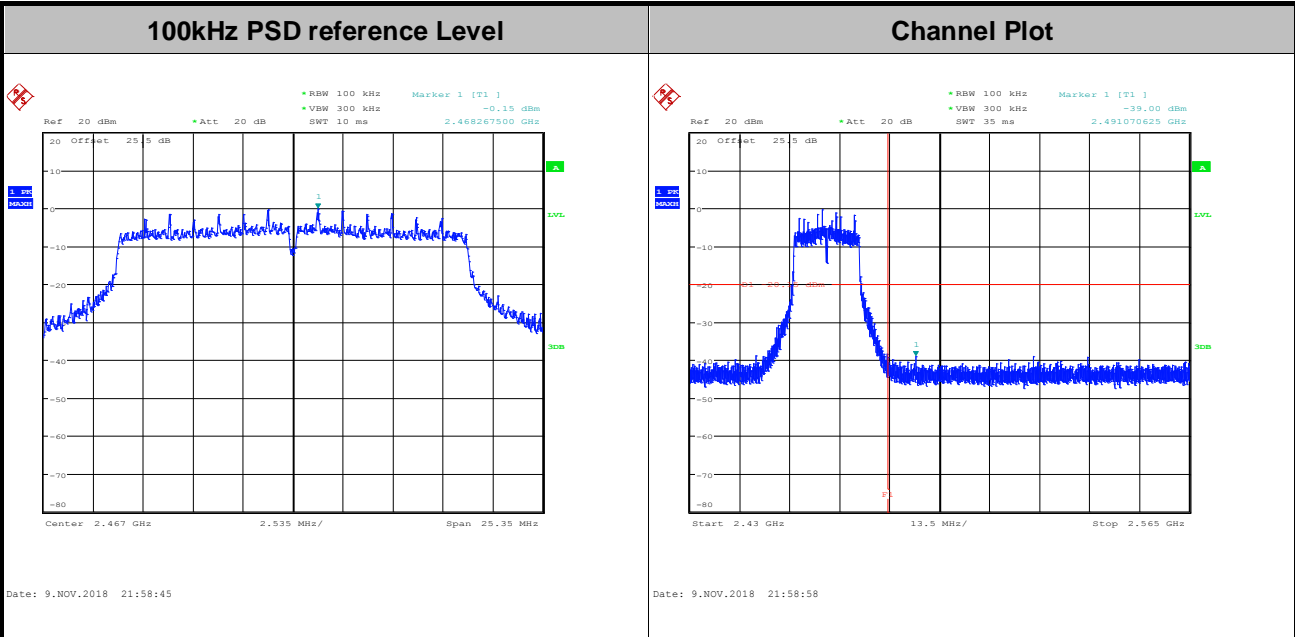



Test Mode :	802.11n HT20	Test Channel :	13
-------------	--------------	----------------	----

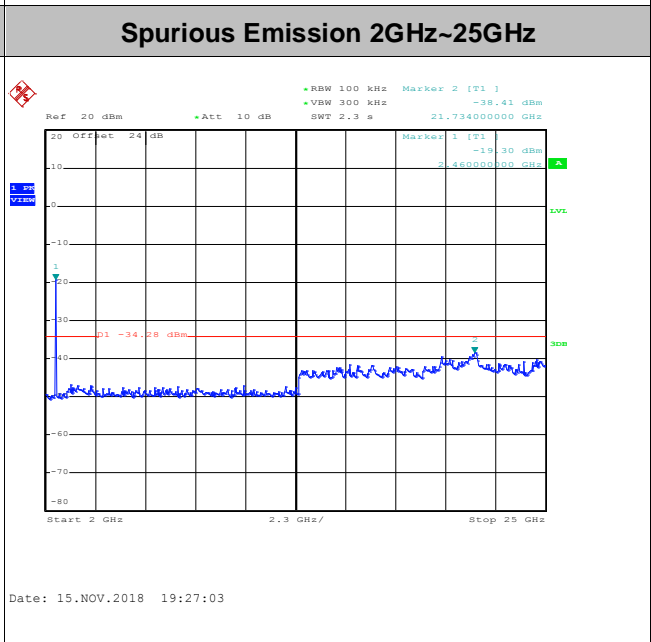
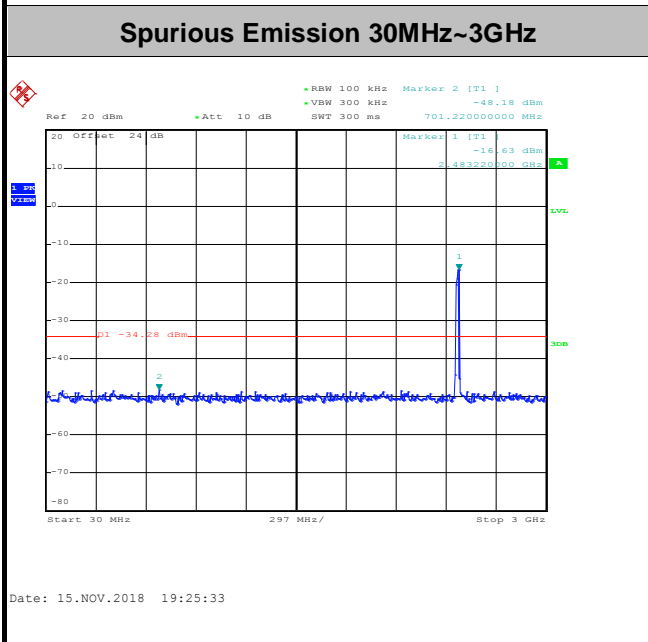
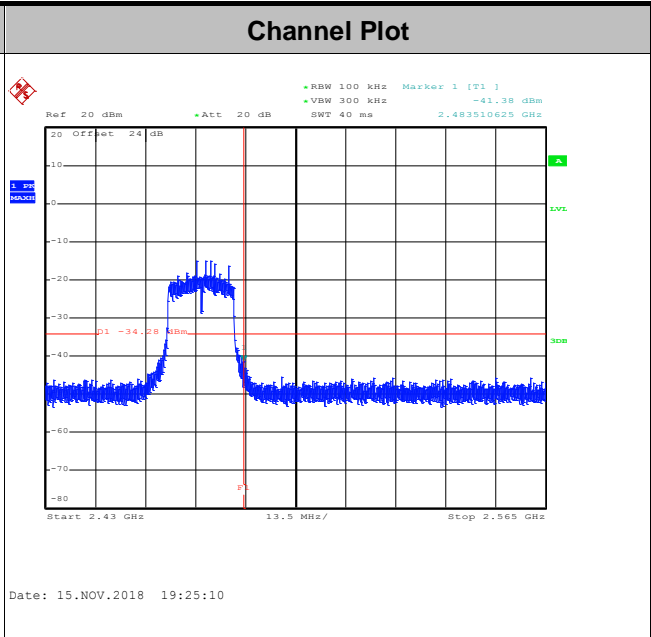
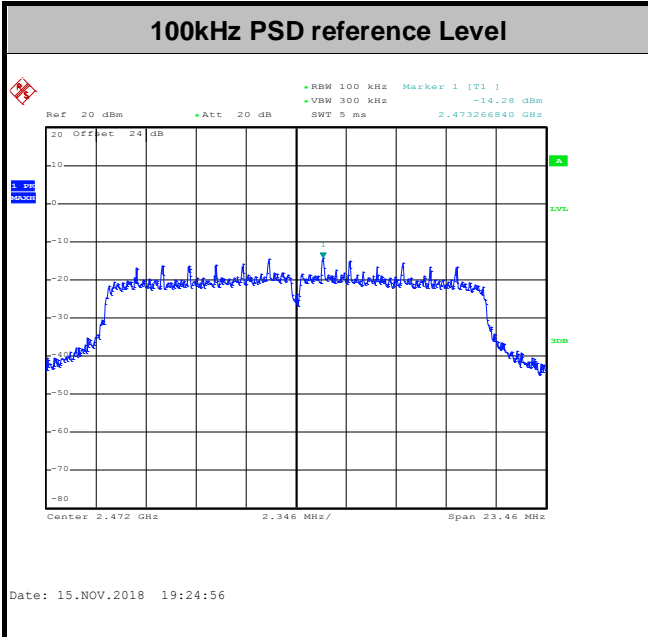



### 3.5 Radiated Band Edges and Spurious Emission Measurement

#### 3.5.1 Limit of Radiated band edge and Spurious Emission Measurement

In any 100 kHz bandwidth outside the intentional radiator frequency band, all harmonics/spurious must be at least 20 dB below the highest emission level within the authorized band. If the output power of this device was measured by spectrum analyzer, the attenuation under this paragraph shall be 30 dB instead of 20 dB. In addition, radiated emissions which fall in the restricted bands must also comply with the limits as below.

Frequency (MHz)	Field Strength (microvolts/meter)	Measurement Distance (meters)
0.009 – 0.490	2400/F(kHz)	300
0.490 – 1.705	24000/F(kHz)	30
1.705 – 30.0	30	30
30 – 88	100	3
88 – 216	150	3
216 - 960	200	3
Above 960	500	3

#### 3.5.2 Measuring Instruments

See list of measuring equipment of this test report.



### 3.5.3 Test Procedures

1. The testing follows FCC KDB Publication No. 558074 D01 DTS Meas. Guidance v05.
2. The EUT was arranged to its worst case and then tune the antenna tower (from 1 m to 4 m) and turntable (from 0 degree to 360 degrees) to find the maximum reading. A pre-amp and a high pass filter are used for the test in order to get better signal level.
3. The EUT was placed on a turntable with 0.8 meter for frequency below 1GHz and 1.5 meter for frequency above 1GHz respectively above ground.
4. The EUT was set 3 meters from the interference receiving antenna, which was mounted on the top of a variable height antenna tower.
5. Corrected Reading: Antenna Factor + Cable Loss + Read Level - Preamp Factor = Level
6. For testing below 1GHz, if the emission level of the EUT in peak mode was 3 dB lower than the limit specified, then peak values of EUT will be reported, otherwise, the emissions will be repeated one by one using the CISPR quasi-peak method and reported.
7. For testing above 1GHz, the emission level of the EUT in peak mode was 20dB lower than average limit (that means the emission level in average mode also complies with the limit in average mode), then peak values of EUT will be reported, otherwise, the emissions will be measured in average mode again and reported.
8. Use the following spectrum analyzer settings:
  - (1) Span shall wide enough to fully capture the emission being measured;
  - (2) Set RBW=100 kHz for  $f < 1$  GHz; VBW  $\geq$  RBW; Sweep = auto; Detector function = peak; Trace = max hold;
  - (3) Set RBW = 1 MHz, VBW= 3MHz for  $f \geq 1$  GHz for peak measurement.

For average measurement:

    - VBW = 10 Hz, when duty cycle is no less than 98 percent.
    - VBW  $\geq 1/T$ , when duty cycle is less than 98 percent where T is the minimum transmission duration over which the transmitter is on and is transmitting at its maximum power control level for the tested mode of operation.



### 3.5.4 Test Setup

For radiated emissions below 30MHz

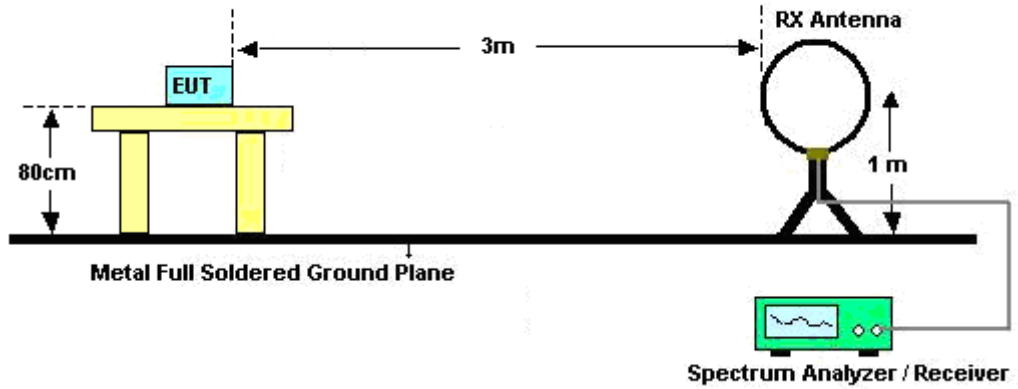

For radiated emissions from 30MHz to 1GHz

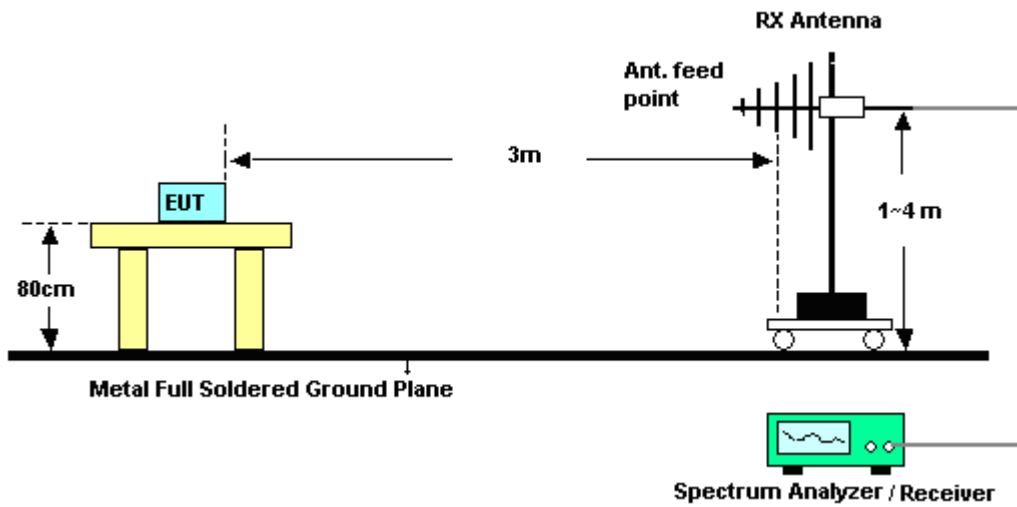

For radiated emissions above 1GHz

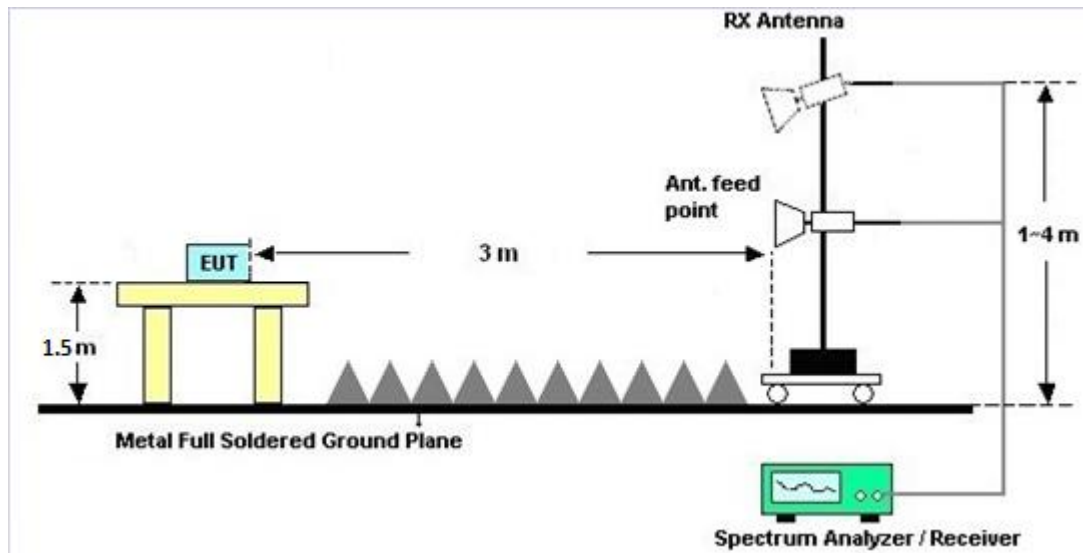

### 3.5.5 Test Results of Radiated Spurious Emissions (9kHz ~ 30MHz)

The low frequency, which started from 9 kHz to 30MHz, was pre-scanned and the result which was 20dB lower than the limit line was not reported.

There is a comparison data of both open-field test site and alternative test site - semi-Anechoic chamber according to 414788 D01 Radiated Test Site v01r01, and the result came out very similar.

### 3.5.6 Test Result of Radiated Spurious at Band Edges

Please refer to Appendix C and D.

### 3.5.7 Duty Cycle

Please refer to Appendix E.

### 3.5.8 Test Result of Radiated Spurious Emission (30MHz ~ 10<sup>th</sup> Harmonic)

Please refer to Appendix C and D.

## 3.6 AC Conducted Emission Measurement

### 3.6.1 Limit of AC Conducted Emission

For equipment that is designed to be connected to the public utility (AC) power line, the radio frequency voltage that is conducted back onto the AC power line on any frequency or frequencies within the band 150 kHz to 30 MHz shall not exceed the limits in the following table.

Frequency of Emission (MHz)	Conducted Limit (dB $\mu$ V)	
	Quasi-Peak	Average
0.15-0.5	66 to 56*	56 to 46*
0.5-5	56	46
5-30	60	50

\*Decreases with the logarithm of the frequency.

### 3.6.2 Measuring Instruments

See list of measuring equipment of this test report.

### 3.6.3 Test Procedures

1. The EUT was placed 0.4 meter from the conducting wall of the shielding room, and it was kept at least 80 centimeters from any other grounded conducting surface.
2. Connect EUT to the power mains through a line impedance stabilization network (LISN).
3. All the support units are connecting to the other LISN.
4. The LISN provides 50 ohm coupling impedance for the measuring instrument.
5. The FCC states that a 50 ohm, 50 microhenry LISN should be used.
6. Both sides of AC line were checked for maximum conducted interference.
7. The frequency range from 150 kHz to 30 MHz was searched.
8. Set the test-receiver system to Peak Detect Function and specified bandwidth (IF bandwidth = 9kHz) with Maximum Hold Mode.

### 3.6.4 Test Setup

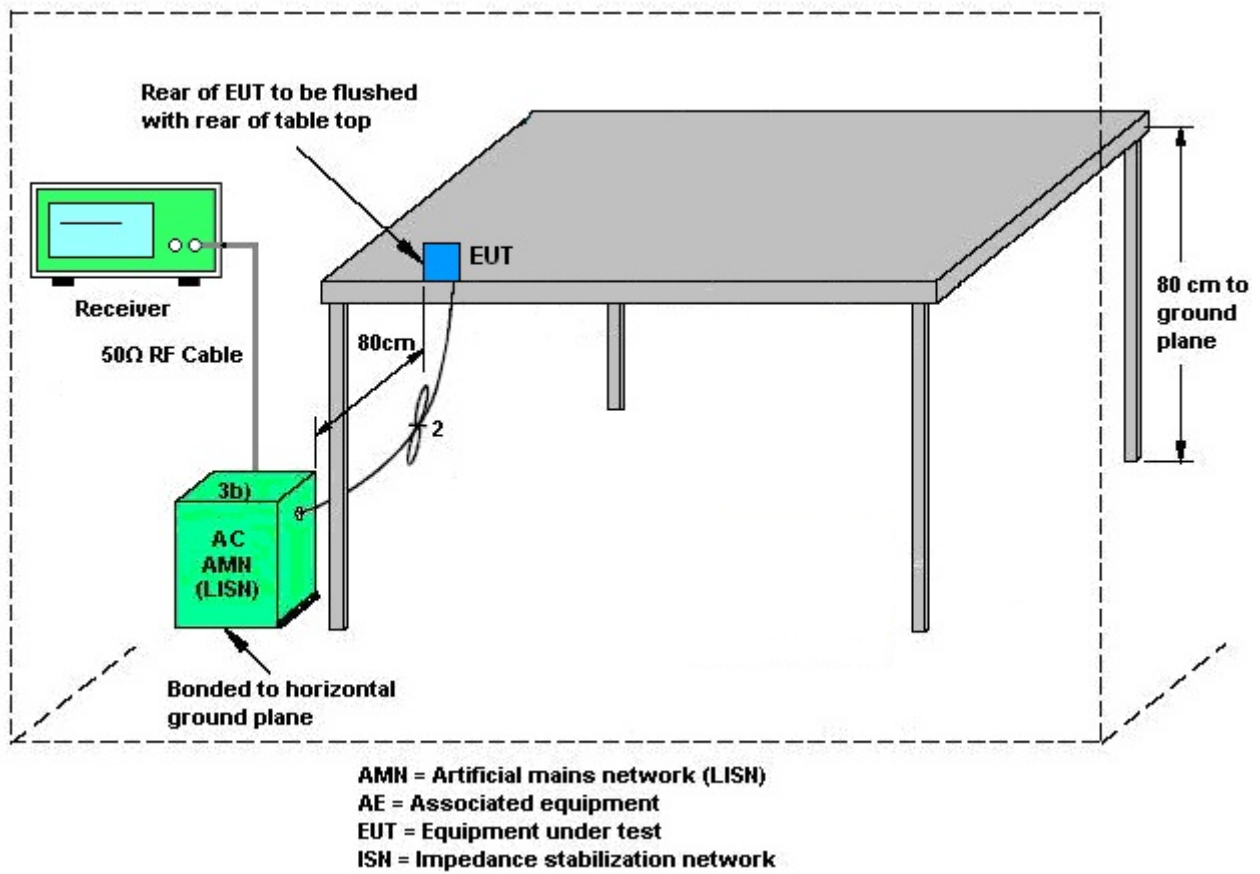

### 3.6.5 Test Result of AC Conducted Emission

Please refer to Appendix B.



## **3.7 Antenna Requirements**

### **3.7.1 Standard Applicable**

If directional gain of transmitting Antennas is greater than 6dBi, the power shall be reduced by the same level in dB comparing to gain minus 6dBi. The use of a permanently attached Antenna or of an Antenna that uses a unique coupling to the intentional radiator shall be considered sufficient to comply with the rule.

### **3.7.2 Antenna Anti-Replacement Construction**

An embedded-in antenna design is used.

### **3.7.3 Antenna Gain**

The antenna peak gain of EUT is less than 6 dBi. Therefore, it is not necessary to reduce maximum peak output power limit.



## 4 List of Measuring Equipment

Instrument	Manufacturer	Model No.	Serial No.	Characteristics	Calibration Date	Test Date	Due Date	Remark
Hygrometer	Testo	DTM-303A	TP157075	N/A	Mar. 06, 2018	Aug. 27, 2018~ Nov. 15, 2018	Mar. 05, 2019	Conducted (TH05-HY)
Power Meter	Anritsu	ML2495A	1132003	N/A	Aug. 16, 2018	Aug. 27, 2018~ Nov. 15, 2018	Aug. 15, 2019	Conducted (TH05-HY)
Power Sensor	Anritsu	MA2411B	1126017	300MHz~40GHz	Aug. 16, 2018	Aug. 27, 2018~ Nov. 15, 2018	Aug. 15, 2019	Conducted (TH05-HY)
Spectrum Analyzer	Rohde & Schwarz	FSP40	100057	9kHz-40GHz	Nov. 21, 2017	Aug. 27, 2018~ Nov. 15, 2018	Nov. 20, 2018	Conducted (TH05-HY)
Spectrum Analyzer	Rohde & Schwarz	FSV30	100895	9kHz-30GHz	Apr. 20, 2018	Aug. 27, 2018~ Nov. 15, 2018	Apr. 19, 2019	Conducted (TH05-HY)
Switch Box & RF Cable	Burgeon	ETF-058	EC130048 4	N/A	Mar. 01, 2018	Aug. 27, 2018~ Nov. 15, 2018	Feb. 28, 2019	Conducted (TH05-HY)
AC Power Source	ChainTek	APC-1000W	N/A	N/A	N/A	Sep. 10, 2018	N/A	Conduction (CO05-HY)
EMI Test Receiver	Rohde & Schwarz	ESR3	102388	9KHz~3.6GHz	Dec. 08, 2017	Sep. 10, 2018	Dec. 07, 2018	Conduction (CO05-HY)
Hygrometer	Testo	608-H1	34913912	N/A	Mar. 06, 2018	Sep. 10, 2018	Mar. 05, 2019	Conduction (CO05-HY)
LISN	Rohde & Schwarz	ENV216	100080	9kHz~30MHz	Nov. 30, 2017	Sep. 10, 2018	Nov. 29, 2018	Conduction (CO05-HY)
Software	Rohde & Schwarz	EMC32 V10.30	N/A	N/A	N/A	Sep. 10, 2018	N/A	Conduction (CO05-HY)
LF Cable	HUBER + SUHNER	RG-214/U	LF01	N/A	Jan. 03, 2018	Sep. 10, 2018	Jan. 02, 2019	Conduction (CO05-HY)
Pulse Limiter	Rohde & Schwarz	ESH3-Z2	100851	N/A	Jan. 03, 2018	Sep. 10, 2018	Jan. 02, 2019	Conduction (CO05-HY)
Amplifier	MITEQ	TTA1840-35- HG	1871923	18GHz~40GHz, VSWR : 2.5:1 max	Jul. 16, 2018	Sep. 02, 2018~ Nov. 15, 2018	Jul. 15, 2019	Radiation (03CH11-HY)
Amplifier	SONOMA	310N	187312	9kHz~1GHz	Jan. 16, 2018	Sep. 02, 2018~ Nov. 15, 2018	Jan. 15, 2019	Radiation (03CH11-HY)
Bilog Antenna	TESEQ	CBL 6111D&N-6- 06	35414&AT- N0602	30MHz~1GHz	Oct. 14, 2017	Sep. 02, 2018~ Sep. 03, 2018	Oct. 13, 2018	Radiation (03CH11-HY)
Bilog Antenna	TESEQ	CBL 6111D&N-6- 06	35414&AT- N0602	30MHz~1GHz	Oct. 13, 2018	Oct. 29, 2018~ Nov. 15, 2018	Oct. 12, 2019	Radiation (03CH11-HY)
Horn Antenna	SCHWARZBE CK	BBHA 9120 D	9120D-132 6	1GHz ~ 18GHz	Oct. 16, 2017	Sep. 02, 2018~ Sep. 03, 2018	Oct. 15, 2018	Radiation (03CH11-HY)
Horn Antenna	SCHWARZBE CK	BBHA 9120 D	BBHA 9120 D 1212	1GHz ~ 18GHz	May 10, 2018	Oct. 29, 2018~ Nov. 15, 2018	May 09, 2019	Radiation (03CH11-HY)
Hygrometer	TECPEL	DTN-303B	TP140325	N/A	Oct. 12, 2017	Sep. 02, 2018~ Sep. 03, 2018	Oct. 11, 2018	Radiation (03CH11-HY)
Hygrometer	TECPEL	DTN-303B	TP140325	N/A	Oct. 11, 2018	Oct. 29, 2018~ Nov. 15, 2018	Oct. 10, 2019	Radiation (03CH11-HY)
Loop Antenna	Rohde & Schwarz	HFH2-Z2	100488	9 kHz~30 MHz	Nov. 23, 2017	Sep. 02, 2018~ Nov. 15, 2018	Nov. 22, 2018	Radiation (03CH11-HY)



Instrument	Manufacturer	Model No.	Serial No.	Characteristics	Calibration Date	Test Date	Due Date	Remark
Preamplifier	Keysight	83017A	MY532700 80	1GHz~26.5GHz	Jan. 16, 2018	Sep. 02, 2018~ Nov. 15, 2018	Jan. 15, 2020	Radiation (03CH11-HY)
Spectrum Analyzer	Keysight	N9010A	MY542004 86	10Hz ~ 44GHz	Oct. 19, 2017	Sep. 02, 2018~ Oct. 17, 2018	Oct. 18, 2018	Radiation (03CH11-HY)
Spectrum Analyzer	Keysight	N9010A	MY542004 86	10Hz ~ 44GHz	Oct. 19, 2018	Oct. 29, 2018~ Nov. 15, 2018	Oct. 18, 2019	Radiation (03CH11-HY)
Controller	EMEC	EM 1000	N/A	Control Turn table & Ant Mast	N/A	Sep. 02, 2018~ Nov. 15, 2018	N/A	Radiation (03CH11-HY)
Antenna Mast	EMEC	AM-BS-4500 -B	N/A	1~4m	N/A	Sep. 02, 2018~ Nov. 15, 2018	N/A	Radiation (03CH11-HY)
Turn Table	EMEC	TT 2000	N/A	0~360 Degree	N/A	Sep. 02, 2018~ Nov. 15, 2018	N/A	Radiation (03CH11-HY)
Preamplifier	Jet-Power	JPA0118-55- 303K	17100018 00054001	1GHz~18GHz	Apr. 16, 2018	Sep. 02, 2018~ Nov. 15, 2018	Apr. 15, 2019	Radiation (03CH11-HY)
SHF-EHF Horn Antenna	SCHWARZBE CK	BBHA 9170	BBHA9170 584	18GHz- 40GHz	Nov. 27, 2017	Sep. 02, 2018~ Nov. 15, 2018	Nov. 26, 2018	Radiation (03CH11-HY)
Software	Audix	E3 6.2009-8-24	RK-00104 2	N/A	N/A	Sep. 02, 2018~ Nov. 15, 2018	N/A	Radiation (03CH11-HY)
RF Cable	HUBER + SUHNER	SUCOFLEX 104	MY9837/4 PE	9kHz-30MHz	Mar. 14, 2018	Sep. 02, 2018~ Nov. 15, 2018	Mar. 13, 2019	Radiation (03CH11-HY)
RF Cable	HUBER + SUHNER	SUCOFLEX 102	MY2859/2	30MHz-40GHz	Mar. 14, 2018	Sep. 02, 2018~ Nov. 15, 2018	Mar. 13, 2019	Radiation (03CH11-HY)
RF Cable	HUBER + SUHNER	SUCOFLEX 104	MY9837/4 PE	30M-18G	Mar. 14, 2018	Sep. 02, 2018~ Nov. 15, 2018	Mar. 13, 2019	Radiation (03CH11-HY)
RF Cable	HUBER + SUHNER	SUCOFLEX 102	MY4274/2	30MHz-40GHz	Mar. 14, 2018	Sep. 02, 2018~ Nov. 15, 2018	Mar. 13, 2019	Radiation (03CH11-HY)
Filter	Wainwright	WLKS1200- 12SS	SN2	1.2G Low Pass	Mar. 23, 2018	Sep. 02, 2018~ Nov. 15, 2018	Mar. 22, 2019	Radiation (03CH11-HY)
Filter	Microwave	H3G018G1	SN477220	3.0G High Pass	Aug. 23, 2018	Sep. 02, 2018~ Nov. 15, 2018	Aug. 22, 2019	Radiation (03CH11-HY)



## 5 Uncertainty of Evaluation

### Uncertainty of Conducted Emission Measurement (150kHz ~ 30MHz)

Measuring Uncertainty for a Level of Confidence of 95% ( $U = 2Uc(y)$ )	2.20
---	------

### Uncertainty of Radiated Emission Measurement (30 MHz ~ 1000 MHz)

Measuring Uncertainty for a Level of Confidence of 95% ( $U = 2Uc(y)$ )	5.20
---	------

### Uncertainty of Radiated Emission Measurement (1000 MHz ~ 18000 MHz)

Measuring Uncertainty for a Level of Confidence of 95% ( $U = 2Uc(y)$ )	5.50
---	------

### Uncertainty of Radiated Emission Measurement (18000 MHz ~ 40000 MHz)

Measuring Uncertainty for a Level of Confidence of 95% ( $U = 2Uc(y)$ )	5.20
---	------



## Appendix A. Test Result of Conducted Test Items

Test Engineer:	Luffy Lin / Allen Lin	Temperature:	21~25	°C
Test Date:	2018/8/29~2018/11/15	Relative Humidity:	51~54	%

**TEST RESULTS DATA**  
**6dB and 99% Occupied Bandwidth**

2.4GHz Band										
Mod.	Data Rate	NTX	CH.	Freq. (MHz)	99% Occupied BW (MHz)		6dB BW (MHz)		6dB BW Limit (MHz)	Pass/Fail
					Ant 1	Ant 2	Ant 1	Ant 2		
11b	1Mbps	1	1	2412	12.85	-	7.56	-	0.50	Pass
11b	1Mbps	1	6	2437	12.80	-	7.06	-	0.50	Pass
11b	1Mbps	1	11	2462	12.75	-	7.04	-	0.50	Pass
11b	1Mbps	1	12	2467	12.80	-	7.55	-	0.50	Pass
11b	1Mbps	1	13	2472	12.65	-	7.08	-	0.50	Pass
11g	6Mbps	1	1	2412	16.85	-	15.44	-	0.50	Pass
11g	6Mbps	1	6	2437	16.75	-	15.32	-	0.50	Pass
11g	6Mbps	1	11	2462	16.85	-	15.30	-	0.50	Pass
11g	6Mbps	1	12	2467	16.85	-	15.78	-	0.50	Pass
11g	6Mbps	1	13	2472	16.80	-	15.32	-	0.50	Pass
HT20	MCS0	1	1	2412	17.95	-	15.68	-	0.50	Pass
HT20	MCS0	1	6	2437	17.95	-	15.70	-	0.50	Pass
HT20	MCS0	1	11	2462	17.95	-	15.42	-	0.50	Pass
HT20	MCS0	1	12	2467	18.00	-	16.90	-	0.50	Pass
HT20	MCS0	1	13	2472	18.00	-	15.64	-	0.50	Pass

**TEST RESULTS DATA**  
**Peak Output Power**

2.4GHz Band																
Mod.	Data Rate	NTX	CH.	Freq. (MHz)	Peak Conducted Power (dBm)			Conducted Power Limit (dBm)		DG (dBi)		EIRP Power (dBm)		EIRP Power Limit (dBm)		Pass /Fail
					Ant 1	Ant 2	SUM	Ant 1	Ant 2	Ant 1	Ant 2	Ant 1	Ant 2	Ant 1	Ant 2	
11b	1Mbps	1	1	2412	18.78	-	-	30.00	-	-1.90	-	16.88	-	36.00	-	Pass
11b	1Mbps	1	6	2437	18.96	-	-	30.00	-	-1.90	-	17.06	-	36.00	-	Pass
11b	1Mbps	1	11	2462	18.54	-	-	30.00	-	-1.90	-	16.64	-	36.00	-	Pass
11b	1Mbps	1	12	2467	18.61	-	-	30.00	-	-1.90	-	16.71	-	36.00	-	Pass
11b	1Mbps	1	13	2472	17.92	-	-	30.00	-	-1.90	-	16.02	-	36.00	-	Pass
11g	6Mbps	1	1	2412	20.45	-	-	30.00	-	-1.90	-	18.55	-	36.00	-	Pass
11g	6Mbps	1	6	2437	20.96	-	-	30.00	-	-1.90	-	19.06	-	36.00	-	Pass
11g	6Mbps	1	11	2462	20.07	-	-	30.00	-	-1.90	-	18.17	-	36.00	-	Pass
11g	6Mbps	1	12	2467	18.87	-	-	30.00	-	-1.90	-	16.97	-	36.00	-	Pass
11g	6Mbps	1	13	2472	4.89	-	-	30.00	-	-1.90	-	2.99	-	36.00	-	Pass
HT20	MCS0	1	1	2412	18.70	-	-	30.00	-	-1.90	-	16.80	-	36.00	-	Pass
HT20	MCS0	1	6	2437	18.76	-	-	30.00	-	-1.90	-	16.86	-	36.00	-	Pass
HT20	MCS0	1	11	2462	19.01	-	-	30.00	-	-1.90	-	17.11	-	36.00	-	Pass
HT20	MCS0	1	12	2467	14.56	-	-	30.00	-	-1.90	-	12.66	-	36.00	-	Pass
HT20	MCS0	1	13	2472	5.01	-	-	30.00	-	-1.90	-	3.11	-	36.00	-	Pass

Note: Measured power (dBm) has offset with cable loss.

**TEST RESULTS DATA**  
**Average Output Power**

2.4GHz Band									
Mod.	Data Rate	N <sub>TX</sub>	CH.	Freq. (MHz)	Duty Factor (dB)		Average Conducted Power (dBm)		
					Ant 1	Ant 2	Ant 1	Ant 2	SUM
11b	1Mbps	1	1	2412	0.05	-	15.84	-	-
11b	1Mbps	1	6	2437	0.05	-	15.98	-	
11b	1Mbps	1	11	2462	0.05	-	15.68	-	
11b	1Mbps	1	12	2467	0.05	-	15.86	-	
11b	1Mbps	1	13	2472	0.05	-	15.51	-	
11g	6Mbps	1	1	2412	0.22	-	15.73	-	
11g	6Mbps	1	6	2437	0.22	-	15.98	-	
11g	6Mbps	1	11	2462	0.22	-	15.32	-	
11g	6Mbps	1	12	2467	0.22	-	14.22	-	
11g	6Mbps	1	13	2472	0.22	-	-1.73	-	
HT20	MCS0	1	1	2412	0.24	-	13.90	-	
HT20	MCS0	1	6	2437	0.24	-	13.92	-	
HT20	MCS0	1	11	2462	0.24	-	13.97	-	
HT20	MCS0	1	12	2467	0.24	-	9.85	-	
HT20	MCS0	1	13	2472	0.24	-	-1.97	-	

Note: Measured power (dBm) has offset with cable loss.

**TEST RESULTS DATA**  
**Peak Power Spectral Density**

2.4GHz Band												
Mod.	Data Rate	NTX	CH.	Freq. (MHz)	Peak PSD (dBm/3kHz)			DG (dBi)		Peak PSD Limit (dBm/3kHz)		Pass/Fail
					Ant 1	Ant 2	Worse + 3.01	Ant 1	Ant 2	Ant 1	Ant 2	
11b	1Mbps	1	1	2412	-7.24	-	-	-1.90	-	8.00	-	Pass
11b	1Mbps	1	6	2437	-5.94	-	-	-1.90	-	8.00	-	Pass
11b	1Mbps	1	11	2462	-6.86	-	-	-1.90	-	8.00	-	Pass
11b	1Mbps	1	12	2467	-6.37	-	-	-1.90	-	8.00	-	Pass
11b	1Mbps	1	13	2472	-6.20	-	-	-1.90	-	8.00	-	Pass
11g	6Mbps	1	1	2412	-7.69	-	-	-1.90	-	8.00	-	Pass
11g	6Mbps	1	6	2437	-8.65	-	-	-1.90	-	8.00	-	Pass
11g	6Mbps	1	11	2462	-8.10	-	-	-1.90	-	8.00	-	Pass
11g	6Mbps	1	12	2467	-10.64	-	-	-1.90	-	8.00	-	Pass
11g	6Mbps	1	13	2472	-29.80	-	-	-1.90	-	8.00	-	Pass
HT20	MCS0	1	1	2412	-11.05	-	-	-1.90	-	8.00	-	Pass
HT20	MCS0	1	6	2437	-11.73	-	-	-1.90	-	8.00	-	Pass
HT20	MCS0	1	11	2462	-10.43	-	-	-1.90	-	8.00	-	Pass
HT20	MCS0	1	12	2467	-15.59	-	-	-1.90	-	8.00	-	Pass
HT20	MCS0	1	13	2472	-29.93	-	-	-1.90	-	8.00	-	Pass

Measured power density (dBm) has offset with cable loss.



## Appendix B. AC Conducted Emission Test Results

Test Engineer :	Rick Lin	Temperature :	22~23°C
		Relative Humidity :	58~60%

# EUT Information

Report NO : 881329-01  
 Test Mode : Mode 1  
 Test Voltage : 120Vac/60Hz  
 Phase : Line

Full Spectrum

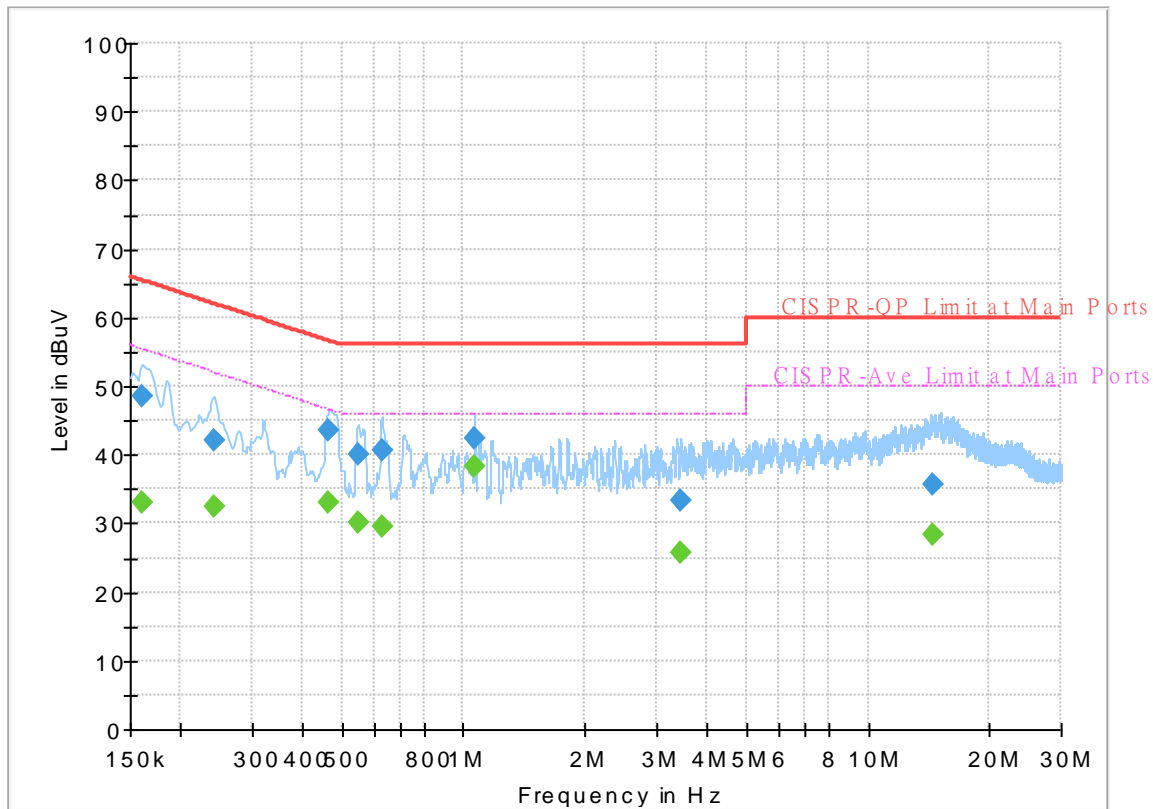

## Final\_Result

Frequency (MHz)	QuasiPeak (dBuV)	CAverage (dBuV)	Limit (dBuV)	Margin (dB)	Line	Filter	Corr. (dB)
0.161250	---	33.17	55.40	22.23	L1	OFF	19.5
0.161250	48.41	---	65.40	16.99	L1	OFF	19.5
0.242250	---	32.41	52.02	19.61	L1	OFF	19.5
0.242250	41.96	---	62.02	20.06	L1	OFF	19.5
0.465000	---	33.10	46.60	13.50	L1	OFF	19.5
0.465000	43.58	---	56.60	13.02	L1	OFF	19.5
0.548250	---	30.20	46.00	15.80	L1	OFF	19.5
0.548250	40.15	---	56.00	15.85	L1	OFF	19.5
0.627000	---	29.45	46.00	16.55	L1	OFF	19.6
0.627000	40.75	---	56.00	15.25	L1	OFF	19.6
1.065750	---	38.34	46.00	7.66	L1	OFF	19.6
1.065750	42.46	---	56.00	13.54	L1	OFF	19.6
3.453000	---	25.80	46.00	20.20	L1	OFF	19.7
3.453000	33.19	---	56.00	22.81	L1	OFF	19.7
14.489250	---	28.45	50.00	21.55	L1	OFF	20.1
14.489250	35.74	---	60.00	24.26	L1	OFF	20.1

# EUT Information

Report NO : 881329-01  
 Test Mode : Mode 1  
 Test Voltage : 120Vac/60Hz  
 Phase : Neutral

Full Spectrum

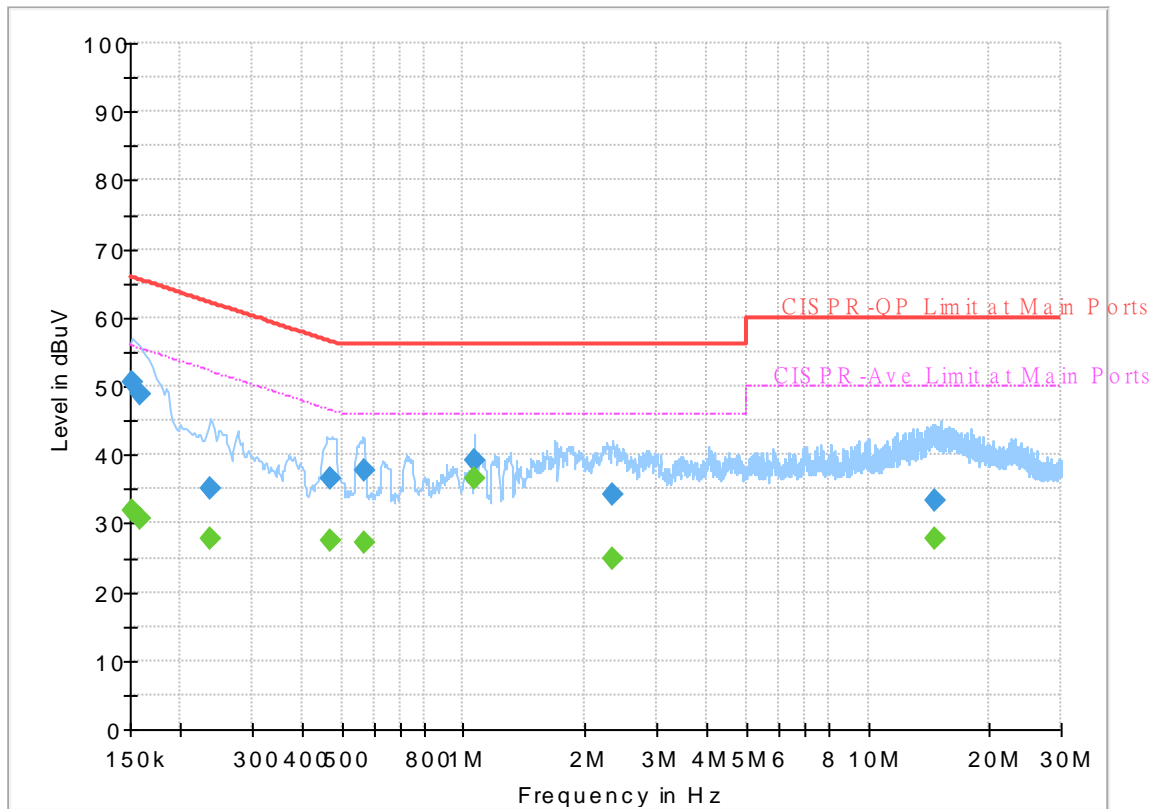

## Final\_Result

Frequency (MHz)	QuasiPeak (dBuV)	CAverage (dBuV)	Limit (dBuV)	Margin (dB)	Line	Filter	Corr. (dB)
0.152250	---	31.78	55.88	24.10	N	OFF	19.5
0.152250	50.56	---	65.88	15.32	N	OFF	19.5
0.159000	---	30.56	55.52	24.96	N	OFF	19.5
0.159000	48.81	---	65.52	16.71	N	OFF	19.5
0.237750	---	27.75	52.17	24.42	N	OFF	19.5
0.237750	35.02	---	62.17	27.15	N	OFF	19.5
0.467250	---	27.59	46.56	18.97	N	OFF	19.5
0.467250	36.55	---	56.56	20.01	N	OFF	19.5
0.566250	---	27.31	46.00	18.69	N	OFF	19.5
0.566250	37.66	---	56.00	18.34	N	OFF	19.5
1.065750	---	36.69	46.00	9.31	N	OFF	19.6
1.065750	39.05	---	56.00	16.95	N	OFF	19.6
2.337000	---	24.80	46.00	21.20	N	OFF	19.5
2.337000	34.25	---	56.00	21.75	N	OFF	19.5
14.581500	---	27.78	50.00	22.22	N	OFF	20.1
14.581500	33.26	---	60.00	26.74	N	OFF	20.1





### Appendix C. Radiated Spurious Emission

Test Engineer :	Hao Hsu, Ken Wu, and Chuan Zhu	Temperature :	21~26°C
		Relative Humidity :	51~56%

2.4GHz 2400~2483.5MHz

WIFI 802.11b (Band Edge @ 3m)

WIFI	Note	Frequency	Level	Over	Limit	Read	Antenna	Path	Preamp	Ant	Table	Peak	Pol.	
Ant.				Limit	Line	Level	Factor	Loss	Factor	Pos	Pos	Avg.		
1		( MHz )	( dBµV/m )	( dB )	( dBµV/m )	( dBµV )	( dB/m )	( dB )	( dB )	( cm )	( deg )	( P/A )	( H/V )	
802.11b CH 01 2412MHz		2370.48	52.39	-21.61	74	42.42	27.09	16.48	33.6	129	32	P	H	
		2390	41.52	-12.48	54	31.46	27.14	16.51	33.59	129	32	A	H	
	*	2412	107.34	-	-	97.21	27.19	16.53	33.59	129	32	P	H	
	*	2412	104.25	-	-	94.12	27.19	16.53	33.59	129	32	A	H	
													H	
														H
			2362.92	52.51	-21.49	74	42.58	27.07	16.46	33.6	303	69	P	V
			2389.8	41.17	-12.83	54	31.12	27.14	16.5	33.59	303	69	A	V
	*		2412	102.23	-	-	92.1	27.19	16.53	33.59	303	69	P	V
	*		2412	99.06	-	-	88.93	27.19	16.53	33.59	303	69	A	V
														V
														V
802.11b CH 06 2437MHz		2353.52	52.05	-21.95	74	42.15	27.05	16.45	33.6	175	24	P	H	
		2390	41.34	-12.66	54	31.28	27.14	16.51	33.59	175	24	A	H	
	*	2437	106.84	-	-	96.63	27.25	16.55	33.59	175	24	P	H	
	*	2437	103.62	-	-	93.41	27.25	16.55	33.59	175	24	A	H	
			2495.92	53.03	-20.97	74	42.61	27.39	16.6	33.57	175	24	P	H
			2483.6	42.02	-11.98	54	31.65	27.36	16.59	33.58	175	24	A	H
			2353.68	51.53	-22.47	74	41.63	27.05	16.45	33.6	342	97	P	V
			2390	41.14	-12.86	54	31.08	27.14	16.51	33.59	342	97	A	V
	*		2437	101.6	-	-	91.39	27.25	16.55	33.59	342	97	P	V
	*		2437	98.42	-	-	88.21	27.25	16.55	33.59	342	97	A	V
			2486.72	52.78	-21.22	74	42.4	27.37	16.59	33.58	342	97	P	V
			2484.16	41.54	-12.46	54	31.17	27.36	16.59	33.58	342	97	A	V



<b>802.11b CH 11 2462MHz</b>	*	2462	108.16	-	-	97.86	27.31	16.57	33.58	198	21	P	H
	*	2462	104.98	-	-	94.68	27.31	16.57	33.58	198	21	A	H
		2484	53.35	-20.65	74	42.98	27.36	16.59	33.58	198	21	P	H
		2484.92	44.04	-9.96	54	33.67	27.36	16.59	33.58	198	21	A	H
													H
													H
	*	2462	102.96	-	-	92.66	27.31	16.57	33.58	300	80	P	V
	*	2462	99.79	-	-	89.49	27.31	16.57	33.58	300	80	A	V
		2493.68	52.95	-21.05	74	42.55	27.38	16.59	33.57	300	80	P	V
		2484.64	42.44	-11.56	54	32.07	27.36	16.59	33.58	300	80	A	V
													V
													V
<b>Remark</b>	1. No other spurious found. 2. All results are PASS against Peak and Average limit line.												



WIFI	Note	Frequency	Level	Over	Limit	Read	Antenna	Path	Preamp	Ant	Table	Peak	Pol.	
Ant. 1		( MHz )	( dBμV/m )	( dB )	Line ( dBμV/m )	Level ( dBμV )	Factor ( dB/m )	Loss ( dB )	Factor ( dB )	Pos ( cm )	Pos ( deg )	Avg. (P/A)	(H/V)	
802.11b CH 12 2467MHz	*	2467	105.6	-	-	95.31	27.3	16.57	33.58	195	21	P	H	
	*	2467	102.46	-	-	92.17	27.3	16.57	33.58	195	21	A	H	
		2488.38	52.3	-21.7	74	41.99	27.3	16.59	33.58	195	21	P	H	
		2484.18	42.65	-11.35	54	32.34	27.3	16.59	33.58	195	21	A	H	
													H	
														H
	*	2467	102.31	-	-	92.02	27.3	16.57	33.58	292	80	P	V	
	*	2467	99.14	-	-	88.85	27.3	16.57	33.58	292	80	A	V	
		2496.5	51.81	-22.19	74	41.48	27.3	16.6	33.57	292	80	P	V	
		2484.11	42.21	-11.79	54	31.9	27.3	16.59	33.58	292	80	A	V	
														V
														V
802.11b CH 13 2472MHz	*	2472	104.3	-	-	93.68	27.3	16.58	33.26	169	16	P	H	
	*	2472	101.16	-	-	90.54	27.3	16.58	33.26	169	16	A	H	
		2483.6	56.46	-17.54	74	45.84	27.3	16.59	33.27	169	16	P	H	
		2483.52	48.84	-5.16	54	38.22	27.3	16.59	33.27	169	16	A	H	
													H	
														H
	*	2472	100.07	-	-	89.45	27.3	16.58	33.26	291	106	P	V	
	*	2472	96.85	-	-	86.23	27.3	16.58	33.26	291	106	A	V	
		2486.2	55.18	-18.82	74	44.56	27.3	16.59	33.27	291	106	P	V	
		2483.52	45.76	-8.24	54	35.14	27.3	16.59	33.27	291	106	A	V	
														V
														V
Remark	1. No other spurious found.													
	2. All results are PASS against Peak and Average limit line.													



2.4GHz 2400~2483.5MHz  
WIFI 802.11b (Harmonic @ 3m)

WIFI Ant.	Note	Frequency	Level	Over Limit	Limit Line	Read Level	Antenna Factor	Path Loss	Preamp Factor	Ant Pos	Table Pos	Peak Avg.	Pol.
1		( MHz )	( dBμV/m )	( dB )	( dBμV/m )	( dBμV )	( dB/m )	( dB )	( dB )	( cm )	( deg )	( P/A )	( H/V )
802.11b CH 01 2412MHz		4824	52.76	-21.24	74	68.06	31.18	10.09	56.57	107	170	P	H
		4824	50.62	-3.38	54	65.92	31.18	10.09	56.57	107	170	A	H
													H
													H
		4824	48.74	-25.26	74	64.04	31.18	10.09	56.57	100	0	P	V
													V
													V
802.11b CH 06 2437MHz		4874	46.18	-27.82	74	61.32	31.27	10.14	56.55	100	0	P	H
		7311	42.74	-31.26	74	50.33	36.11	12.53	56.23	100	0	P	H
													H
													H
		4874	43.24	-30.76	74	58.38	31.27	10.14	56.55	100	0	P	V
		7311	46.27	-27.73	74	53.86	36.11	12.53	56.23	100	0	P	V
													V
802.11b CH 11 2462MHz		4924	48.03	-25.97	74	62.99	31.36	10.21	56.53	100	0	P	H
		7386	43.33	-30.67	74	50.71	36.3	12.44	56.12	100	0	P	H
													H
													H
		4924	46.06	-27.94	74	61.02	31.36	10.21	56.53	100	0	P	V
		7386	43.57	-30.43	74	50.95	36.3	12.44	56.12	100	0	P	V
													V
Remark	1. No other spurious found.												
	2. All results are PASS against Peak and Average limit line.												



WIFI	Note	Frequency	Level	Over	Limit	Read	Antenna	Path	Preamp	Ant	Table	Peak	Pol.
Ant. 1		( MHz )	( dBμV/m )	( dB )	( dBμV/m )	( dBμV )	( dB/m )	( dB )	( dB )	( cm )	( deg )	( P/A )	( H/V )
802.11b CH 12 2467MHz		4934	38.44	-35.56	74	53.55	31.2	10.22	56.53	100	0	P	H
		7401	42.17	-31.83	74	49.44	36.4	12.43	56.1	100	0	P	H
													H
													H
		4934	38.65	-35.35	74	53.76	31.2	10.22	56.53	100	0	P	V
		7401	41.7	-32.3	74	48.97	36.4	12.43	56.1	100	0	P	V
													V
													V
802.11b CH 13 2472MHz		4944	44.8	-29.2	74	59.83	31.26	10.23	56.52	100	0	P	H
		7416	42.15	-31.85	74	49.38	36.43	12.44	56.1	100	0	P	H
													H
													H
		4944	42.22	-31.78	74	57.25	31.26	10.23	56.52	100	0	P	V
		7416	41.37	-32.63	74	48.6	36.43	12.44	56.1	100	0	P	V
													V
													V
<b>Remark</b>	1. No other spurious found. 2. All results are PASS against Peak and Average limit line.												



2.4GHz 2400~2483.5MHz  
WIFI 802.11g (Band Edge @ 3m)

WIFI Ant. 1	Note	Frequency ( MHz )	Level ( dBμV/m )	Over Limit ( dB )	Limit Line ( dBμV/m )	Read Level ( dBμV )	Antenna Factor ( dB/m )	Path Loss ( dB )	Preamp Factor ( dB )	Ant Pos ( cm )	Table Pos ( deg )	Peak Avg. ( P/A )	Pol. ( H/V )	
802.11g CH 01 2412MHz		2389.8	59.61	-14.39	74	49.56	27.14	16.5	33.59	153	31	P	H	
		2390	50.71	-3.29	54	40.65	27.14	16.51	33.59	153	31	A	H	
	*	2412	108.77	-	-	98.64	27.19	16.53	33.59	153	31	P	H	
	*	2412	100.77	-	-	90.64	27.19	16.53	33.59	153	31	A	H	
													H	
													H	
			2390	55.54	-18.46	74	45.48	27.14	16.51	33.59	300	69	P	V
			2390	45.45	-8.55	54	35.39	27.14	16.51	33.59	300	69	A	V
	*		2412	103.09	-	-	92.96	27.19	16.53	33.59	300	69	P	V
	*		2412	95.63	-	-	85.5	27.19	16.53	33.59	300	69	A	V
													V	
													V	
802.11g CH 06 2437MHz		2388.4	52.8	-21.2	74	42.77	27.13	16.5	33.6	199	20	P	H	
		2389.84	42.94	-11.06	54	32.89	27.14	16.5	33.59	199	20	A	H	
	*	2437	109.16	-	-	98.95	27.25	16.55	33.59	199	20	P	H	
	*	2437	101.24	-	-	91.03	27.25	16.55	33.59	199	20	A	H	
			2486.16	54.35	-19.65	74	43.97	27.37	16.59	33.58	199	20	P	H
			2484.64	44.12	-9.88	54	33.75	27.36	16.59	33.58	199	20	A	H
			2376.24	52.82	-21.18	74	42.84	27.1	16.48	33.6	300	78	P	V
			2382.8	42.48	-11.52	54	32.47	27.12	16.49	33.6	300	78	A	V
	*		2437	104.37	-	-	94.16	27.25	16.55	33.59	300	78	P	V
	*		2437	96.46	-	-	86.25	27.25	16.55	33.59	300	78	A	V
			2485.76	53	-21	74	42.62	27.37	16.59	33.58	300	78	P	V
			2483.6	43.18	-10.82	54	32.81	27.36	16.59	33.58	300	78	A	V



<b>802.11g</b>  <b>CH 11</b>  <b>2462MHz</b>	*	2462	109.54	-	-	99.24	27.31	16.57	33.58	194	19	P	H
	*	2462	101.72	-	-	91.42	27.31	16.57	33.58	194	19	A	H
		2483.84	61.41	-12.59	74	51.04	27.36	16.59	33.58	194	19	P	H
		2483.64	49.57	-4.43	54	39.2	27.36	16.59	33.58	194	19	A	H
													H
													H
	*	2462	104.69	-	-	94.39	27.31	16.57	33.58	300	77	P	V
	*	2462	96.79	-	-	86.49	27.31	16.57	33.58	300	77	A	V
		2483.88	56.51	-17.49	74	46.14	27.36	16.59	33.58	300	77	P	V
		2483.52	46.37	-7.63	54	36	27.36	16.59	33.58	300	77	A	V
													V
													V
<b>Remark</b>	1. No other spurious found. 2. All results are PASS against Peak and Average limit line.												



WIFI	Note	Frequency	Level	Over	Limit	Read	Antenna	Path	Preamp	Ant	Table	Peak	Pol.
Ant. 1		( MHz )	( dBμV/m )	( dB )	Line ( dBμV/m )	Level ( dBμV )	Factor ( dB/m )	Loss ( dB )	Factor ( dB )	Pos ( cm )	Pos ( deg )	Avg. (P/A)	(H/V)
802.11g CH 12 2467MHz	*	2467	104.74	-	-	94.45	27.3	16.57	33.58	386	8	P	H
	*	2467	97.1	-	-	86.81	27.3	16.57	33.58	386	8	A	H
		2483.5	61.17	-12.83	74	50.86	27.3	16.59	33.58	386	8	P	H
		2483.5	50.41	-3.59	54	40.1	27.3	16.59	33.58	386	8	A	H
													H
													H
	*	2467	101.74	-	-	91.45	27.3	16.57	33.58	291	80	P	V
	*	2467	93.88	-	-	83.59	27.3	16.57	33.58	291	80	A	V
		2483.5	59.59	-14.41	74	49.28	27.3	16.59	33.58	291	80	P	V
		2483.55	49.05	-4.95	54	38.74	27.3	16.59	33.58	291	80	A	V
													V
													V
802.11g CH 13 2472MHz	*	2472	86.37	-	-	76.07	27.3	16.58	33.58	169	34	P	H
	*	2472	78.77	-	-	68.47	27.3	16.58	33.58	169	34	A	H
		2483.6	60.68	-13.32	74	50.37	27.3	16.59	33.58	169	34	P	H
		2483.52	50.61	-3.39	54	40.3	27.3	16.59	33.58	169	34	A	H
													H
													H
	*	2472	81.7	-	-	71.4	27.3	16.58	33.58	281	74	P	V
	*	2472	74.19	-	-	63.89	27.3	16.58	33.58	281	74	A	V
		2483.56	57.39	-16.61	74	47.08	27.3	16.59	33.58	281	74	P	V
		2483.52	46.41	-7.59	54	36.1	27.3	16.59	33.58	281	74	A	V
													V
													V
Remark	1. No other spurious found.												
	2. All results are PASS against Peak and Average limit line.												





2.4GHz 2400~2483.5MHz  
WIFI 802.11g (Harmonic @ 3m)

WIFI Ant.	Note	Frequency	Level	Over Limit	Limit Line	Read Level	Antenna Factor	Path Loss	Preamp Factor	Ant Pos	Table Pos	Peak Avg.	Pol.
1		( MHz )	( dBμV/m )	( dB )	( dBμV/m )	( dBμV )	( dB/m )	( dB )	( dB )	( cm )	( deg )	( P/A )	( H/V )
802.11g CH 01 2412MHz		4824	49.01	-24.99	74	64.31	31.18	10.09	56.57	100	0	P	H
													H
													H
													H
		4824	46.1	-27.9	74	61.4	31.18	10.09	56.57	100	0	P	V
													V
													V
802.11g CH 06 2437MHz		4874	42.65	-31.35	74	57.79	31.27	10.14	56.55	100	0	P	H
		7311	44.36	-29.64	74	51.95	36.11	12.53	56.23	100	0	P	H
													H
													H
		4874	42.74	-31.26	74	57.88	31.27	10.14	56.55	100	0	P	V
		7311	41.64	-32.36	74	49.23	36.11	12.53	56.23	100	0	P	V
													V
802.11g CH 11 2462MHz		4924	45.15	-28.85	74	60.11	31.36	10.21	56.53	100	0	P	H
		7386	41.95	-32.05	74	49.33	36.3	12.44	56.12	100	0	P	H
													H
													H
		4924	43.38	-30.62	74	58.34	31.36	10.21	56.53	100	0	P	V
		7386	42.16	-31.84	74	49.54	36.3	12.44	56.12	100	0	P	V
													V
Remark	1. No other spurious found.												
	2. All results are PASS against Peak and Average limit line.												



WIFI	Note	Frequency	Level	Over	Limit	Read	Antenna	Path	Preamp	Ant	Table	Peak	Pol.
Ant. 1		( MHz )	( dBμV/m )	( dB )	Line ( dBμV/m )	Level ( dBμV )	Factor ( dB/m )	Loss ( dB )	Factor ( dB )	Pos ( cm )	Pos ( deg )	Avg. (P/A)	(H/V)
802.11g CH 12 2467MHz		4934	40.61	-33.39	74	55.72	31.2	10.22	56.53	100	0	P	H
		7401	41.69	-32.31	74	48.96	36.4	12.43	56.1	100	0	P	H
													H
													H
		4934	39.66	-34.34	74	54.77	31.2	10.22	56.53	100	0	P	V
		7401	41.82	-32.18	74	49.09	36.4	12.43	56.1	100	0	P	V
													V
													V
802.11g CH 13 2472MHz		4944	38.54	-35.46	74	53.57	31.26	10.23	56.52	100	0	P	H
		7416	41.93	-32.07	74	49.16	36.43	12.44	56.1	100	0	P	H
													H
													H
		4944	39.24	-34.76	74	54.27	31.26	10.23	56.52	100	0	P	V
		7416	42.01	-31.99	74	49.24	36.43	12.44	56.1	100	0	P	V
													V
													V
<b>Remark</b>	1. No other spurious found. 2. All results are PASS against Peak and Average limit line.												



**2.4GHz 2400~2483.5MHz  
WIFI 802.11n HT20 (Band Edge @ 3m)**

WIFI Ant. 1	Note	Frequency ( MHz )	Level ( dBμV/m )	Over Limit ( dB )	Limit Line ( dBμV/m )	Read Level ( dBμV )	Antenna Factor ( dB/m )	Path Loss ( dB )	Preamp Factor ( dB )	Ant Pos ( cm )	Table Pos ( deg )	Peak Avg. ( P/A )	Pol. ( H/V )	
802.11n HT20 CH 01 2412MHz		2389.905	59.53	-14.47	74	49.48	27.14	16.5	33.59	130	31	P	H	
		2390	49.61	-4.39	54	39.55	27.14	16.51	33.59	130	31	A	H	
	*	2412	106.26	-	-	96.13	27.19	16.53	33.59	130	31	P	H	
	*	2412	98.33	-	-	88.2	27.19	16.53	33.59	130	31	A	H	
													H	
														H
			2389.275	54.01	-19.99	74	43.98	27.13	16.5	33.6	304	70	P	V
			2390	45.03	-8.97	54	34.97	27.14	16.51	33.59	304	70	A	V
		*	2412	101.14	-	-	91.01	27.19	16.53	33.59	304	70	P	V
		*	2412	93.2	-	-	83.07	27.19	16.53	33.59	304	70	A	V
													V	
													V	
802.11n HT20 CH 06 2437MHz		2318.16	51.39	-22.61	74	41.97	26.95	16.08	33.61	115	299	P	H	
		2390	42.56	-11.44	54	32.73	27.13	16.29	33.59	115	299	A	H	
		*	2437	104.74	-	-	94.75	27.27	16.31	33.59	115	299	P	H
		*	2437	96.62	-	-	86.63	27.27	16.31	33.59	115	299	A	H
			2483.52	52.82	-21.18	74	42.73	27.36	16.31	33.58	115	299	P	H
			2484.24	43.36	-10.64	54	33.26	27.36	16.32	33.58	115	299	A	H
			2343.76	51.82	-22.18	74	42.27	27	16.15	33.6	357	55	P	V
			2388.72	42.1	-11.9	54	32.28	27.13	16.29	33.6	357	55	A	V
		*	2437	100.06	-	-	90.07	27.27	16.31	33.59	357	55	P	V
		*	2437	92.3	-	-	82.31	27.27	16.31	33.59	357	55	A	V
		2495.52	52.01	-21.99	74	41.86	27.4	16.32	33.57	357	55	P	V	
		2483.84	42.59	-11.41	54	32.5	27.36	16.31	33.58	357	55	A	V	



<b>802.11n</b>  <b>HT20</b>  <b>CH 11</b>  <b>2462MHz</b>	*	2462	105.76	-	-	95.72	27.31	16.31	33.58	111	302	P	H
	*	2462	97.84	-	-	87.8	27.31	16.31	33.58	111	302	A	H
		2483.52	54.93	-19.07	74	44.84	27.36	16.31	33.58	111	302	P	H
		2483.6	44.7	-9.3	54	34.61	27.36	16.31	33.58	111	302	A	H
													H
													H
	*	2462	101.92	-	-	91.88	27.31	16.31	33.58	389	63	P	V
	*	2462	94.06	-	-	84.02	27.31	16.31	33.58	389	63	A	V
		2493.28	52.64	-21.36	74	42.49	27.4	16.32	33.57	389	63	P	V
		2483.96	42.95	-11.05	54	32.86	27.36	16.31	33.58	389	63	A	V
													V
													V
<b>Remark</b>	1. No other spurious found. 2. All results are PASS against Peak and Average limit line.												



WIFI	Note	Frequency	Level	Over	Limit	Read	Antenna	Path	Preamp	Ant	Table	Peak	Pol.
Ant. 1		( MHz )	( dBμV/m )	( dB )	Line ( dBμV/m )	Level ( dBμV )	Factor ( dB/m )	Loss ( dB )	Factor ( dB )	Pos ( cm )	Pos ( deg )	Avg. (P/A)	(H/V)
802.11n HT20 CH 12 2467MHz	*	2467	101.57	-	-	91.28	27.3	16.57	33.58	225	338	P	H
	*	2467	93.41	-	-	83.12	27.3	16.57	33.58	225	338	A	H
		2483.65	61.52	-12.48	74	51.21	27.3	16.59	33.58	225	338	P	H
		2483.55	50.66	-3.34	54	40.35	27.3	16.59	33.58	225	338	A	H
													H
													H
	*	2467	98.46	-	-	88.17	27.3	16.57	33.58	290	81	P	V
	*	2467	90.51	-	-	80.22	27.3	16.57	33.58	290	81	A	V
		2483.6	58.72	-15.28	74	48.41	27.3	16.59	33.58	290	81	P	V
		2483.5	47.96	-6.04	54	37.65	27.3	16.59	33.58	290	81	A	V
												V	
												V	
802.11n HT20 CH 13 2472MHz	*	2472	85.49	-	-	75.19	27.3	16.58	33.58	169	33	P	H
	*	2472	77.58	-	-	67.28	27.3	16.58	33.58	169	33	A	H
		2483.64	60.26	-13.74	74	49.95	27.3	16.59	33.58	169	33	P	H
		2483.52	50.52	-3.48	54	40.21	27.3	16.59	33.58	169	33	A	H
													H
													H
	*	2472	80.69	-	-	70.39	27.3	16.58	33.58	281	74	P	V
	*	2472	73.08	-	-	62.78	27.3	16.58	33.58	281	74	A	V
		2483.6	56.36	-17.64	74	46.05	27.3	16.59	33.58	281	74	P	V
		2483.52	46.4	-7.6	54	36.09	27.3	16.59	33.58	281	74	A	V
												V	
												V	
Remark	1. No other spurious found.												
	2. All results are PASS against Peak and Average limit line.												



2.4GHz 2400~2483.5MHz  
WIFI 802.11n HT20 (Harmonic @ 3m)

WIFI Ant.	Note	Frequency	Level	Over Limit	Limit Line	Read Level	Antenna Factor	Path Loss	Preamp Factor	Ant Pos	Table Pos	Peak Avg.	Pol.
1		( MHz )	( dBμV/m )	( dB )	( dBμV/m )	( dBμV )	( dB/m )	( dB )	( dB )	( cm )	( deg )	( P/A )	( H/V )
802.11n HT20 CH 01 2412MHz		4824	47.42	-26.58	74	62.72	31.18	10.09	56.57	100	0	P	H
													H
													H
													H
		4824	48.48	-25.52	74	63.78	31.18	10.09	56.57	100	0	P	V
													V
													V
802.11n HT20 CH 06 2437MHz		4874	41.33	-32.67	74	58.51	31.38	9.99	58.55	100	0	P	H
		7311	40.98	-33.02	74	51.76	36.28	11.77	58.83	100	0	P	H
													H
													H
		4874	37.87	-36.13	74	55.05	31.38	9.99	58.55	100	0	P	V
		7311	41.1	-32.9	74	51.88	36.28	11.77	58.83	100	0	P	V
													V
802.11n HT20 CH 11 2462MHz		4924	46.92	-27.08	74	63.98	31.48	9.99	58.53	100	0	P	H
		7386	43.05	-30.95	74	53.62	36.47	11.68	58.72	100	0	P	H
													H
													H
		4924	42.62	-31.38	74	59.68	31.48	9.99	58.53	100	0	P	V
		7386	42.26	-31.74	74	52.83	36.47	11.68	58.72	100	0	P	V
													V
Remark	1. No other spurious found.												
	2. All results are PASS against Peak and Average limit line.												



WIFI	Note	Frequency	Level	Over	Limit	Read	Antenna	Path	Preamp	Ant	Table	Peak	Pol.
Ant. 1		( MHz )	( dBμV/m )	( dB )	( dBμV/m )	( dBμV )	( dB/m )	( dB )	( dB )	( cm )	( deg )	( P/A )	( H/V )
802.11n HT20 CH 12 2467MHz		4934	39.38	-34.62	74	54.49	31.2	10.22	56.53	100	0	P	H
		7401	42.02	-31.98	74	49.29	36.4	12.43	56.1	100	0	P	H
													H
													H
		4934	39.11	-34.89	74	54.22	31.2	10.22	56.53	100	0	P	V
		7401	42.14	-31.86	74	49.41	36.4	12.43	56.1	100	0	P	V
802.11n HT20 CH 13 2472MHz		4944	38.88	-35.12	74	53.91	31.26	10.23	56.52	100	0	P	H
		7416	41.47	-32.53	74	48.7	36.43	12.44	56.1	100	0	P	H
													H
													H
		4944	39.27	-34.73	74	54.3	31.26	10.23	56.52	100	0	P	V
		7416	41.85	-32.15	74	49.08	36.43	12.44	56.1	100	0	P	V
Remark	1. No other spurious found.												
	2. All results are PASS against Peak and Average limit line.												











**Note symbol**

*	<b>Fundamental Frequency</b> which can be ignored. However, the level of any unwanted emissions shall not exceed the level of the fundamental frequency.
!	Test result is <b>over limit</b> line.
P/A	<b>Peak</b> or <b>Average</b>
H/V	<b>Horizontal</b> or <b>Vertical</b>



A calculation example for radiated spurious emission is shown as below:

WIFI	Note	Frequency	Level	Over	Limit	Read	Antenna	Path	Preamp	Ant	Table	Peak	Pol.
Ant.				Limit	Line	Level	Factor	Loss	Factor	Pos	Pos	Avg.	
1		( MHz )	( dBμV/m )	( dB )	( dBμV/m )	( dBμV )	( dB/m )	( dB )	( dB )	( cm )	( deg )	( P/A )	( H/V )
802.11b		2390	55.45	-18.55	74	54.51	32.22	4.58	35.86	103	308	P	H
CH 01													
2412MHz		2390	43.54	-10.46	54	42.6	32.22	4.58	35.86	103	308	A	H

1. Path Loss(dB) = Cable loss(dB) + Filter loss(dB) + Attenuator loss(dB)
2. Level(dBμV/m) =  
Antenna Factor(dB/m) + Path Loss(dB) + Read Level(dBμV) - Preamp Factor(dB)
3. Over Limit(dB) = Level(dBμV/m) – Limit Line(dBμV/m)

**For Peak Limit @ 2390MHz:**

1. Level(dBμV/m)  
= Antenna Factor(dB/m) + Path Loss(dB) + Read Level(dBμV) - Preamp Factor(dB)  
= 32.22(dB/m) + 4.58(dB) + 54.51(dBμV) – 35.86 (dB)  
= 55.45 (dBμV/m)
2. Over Limit(dB)  
= Level(dBμV/m) – Limit Line(dBμV/m)  
= 55.45(dBμV/m) – 74(dBμV/m)  
= -18.55(dB)

**For Average Limit @ 2390MHz:**

1. Level(dBμV/m)  
= Antenna Factor(dB/m) + Path Loss(dB) + Read Level(dBμV) - Preamp Factor(dB)  
= 32.22(dB/m) + 4.58(dB) + 42.6(dBμV) – 35.86 (dB)  
= 43.54 (dBμV/m)
2. Over Limit(dB)  
= Level(dBμV/m) – Limit Line(dBμV/m)  
= 43.54(dBμV/m) – 54(dBμV/m)  
= -10.46(dB)

Both peak and average measured complies with the limit line, so test result is “PASS”.



## Appendix D. Radiated Spurious Emission Plots

Test Engineer :	Hao Hsu, Ken Wu, and Chuan Zhu	Temperature :	21~26°C
		Relative Humidity :	51~56%

### Note symbol

-L	Low channel location
-R	High channel location

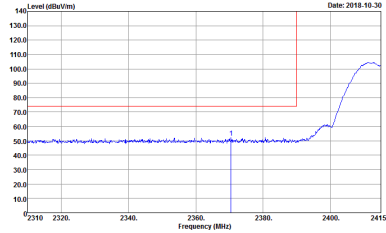
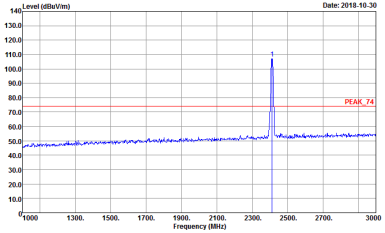
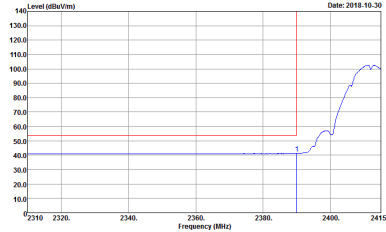
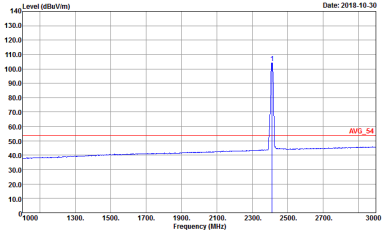

2.4GHz 2400~2483.5MHz  
WIFI 802.11b (Band Edge @ 3m)

WIFI	2.4GHz 2400~2483.5MHz Band Edge @ 3m	
ANT	802.11b CH01 2412MHz	
1	Horizontal	Fundamental
Peak	 <p>Site : 03CH11-HY Condition : PEAK_BE_74 3m HORN 91200-HF HORIZONTAL Detector : Peak Project : 881329-01</p>	 <p>Site : 03CH11-HY Condition : PEAK_74 3m HORN 91200-HF HORIZONTAL Detector : Peak Project : 881329-01</p>
Avg.	 <p>Site : 03CH11-HY Condition : AVG_BE_54 3m HORN 91200-HF HORIZONTAL Detector : Peak Project : 881329-01</p>	 <p>Site : 03CH11-HY Condition : AVG_54 3m HORN 91200-HF HORIZONTAL Detector : Peak Project : 881329-01</p>

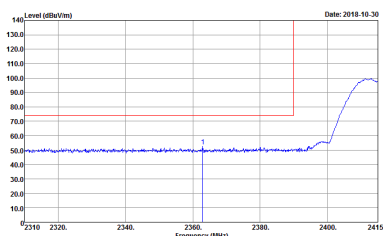
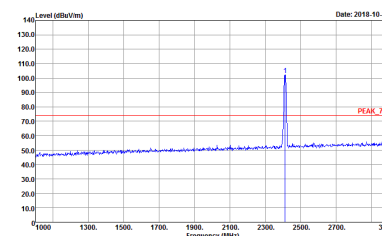
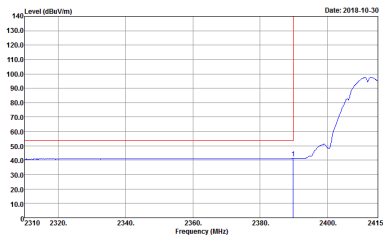
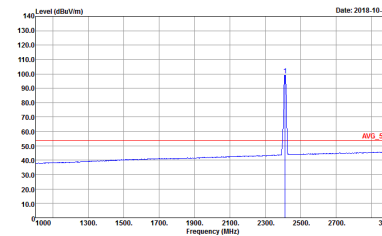

WIFI	2.4GHz 2400~2483.5MHz Band Edge @ 3m	
ANT	802.11b CH01 2412MHz	
1	Vertical	Fundamental
Peak	 <p>Site : 03CH11-HY            Condition : PEAK_BE_74 3m HORN 91200-HF VERTICAL            RBW:1000.000KHz VBW:3000.000KHz SWT:Auto            Detector : Peak            Project : 881329-01</p>	 <p>Site : 03CH11-HY            Condition : PEAK_74 3m HORN 91200-HF VERTICAL            RBW:1000.000KHz VBW:3000.000KHz SWT:Auto            Detector : Peak            Project : 881329-01</p>
Avg.	 <p>Site : 03CH11-HY            Condition : AVG_BE_54 3m HORN 91200-HF VERTICAL            RBW:1000.000KHz VBW:0.010KHz SWT:Auto            Detector : Peak            Project : 881329-01</p>	 <p>Site : 03CH11-HY            Condition : AVG_54 3m HORN 91200-HF VERTICAL            RBW:1000.000KHz VBW:0.010KHz SWT:Auto            Detector : Peak            Project : 881329-01</p>

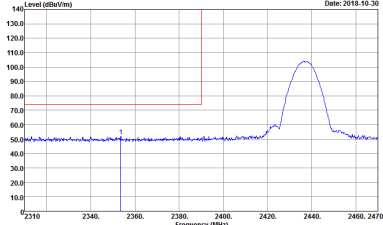
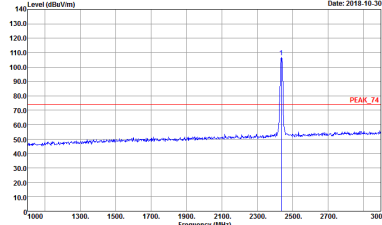
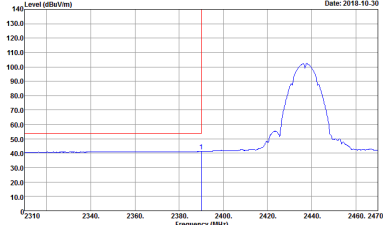
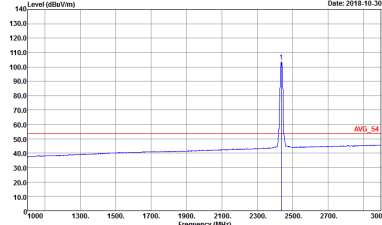

WIFI	2.4GHz 2400~2483.5MHz Band Edge @ 3m	
ANT	802.11b CH06 2437MHz - L	
1	Horizontal	Fundamental
Peak	 <p>Site : 03CH11-HY            Condition : PEAK_BE_74 3m HORN 91200-HF HORIZONTAL            RBW:1000.000KHz VBW:3000.000KHz SWT:Auto            Detector : Peak            Project : 881329-01</p>	 <p>Site : 03CH11-HY            Condition : PEAK_74 3m HORN 91200-HF HORIZONTAL            RBW:1000.000KHz VBW:3000.000KHz SWT:Auto            Detector : Peak            Project : 881329-01</p>
Avg.	 <p>Site : 03CH11-HY            Condition : AVG_BE_54 3m HORN 91200-HF HORIZONTAL            RBW:1000.000KHz VBW:0.010KHz SWT:Auto            Detector : Peak            Project : 881329-01</p>	 <p>Site : 03CH11-HY            Condition : AVG_54 3m HORN 91200-HF HORIZONTAL            RBW:1000.000KHz VBW:0.010KHz SWT:Auto            Detector : Peak            Project : 881329-01</p>



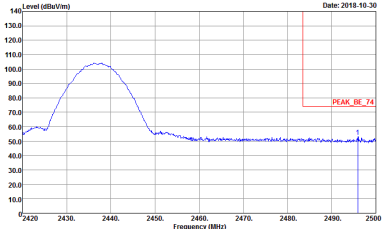
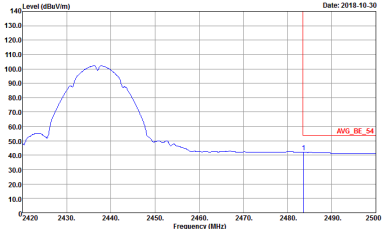

WIFI	2.4GHz 2400~2483.5MHz Band Edge @ 3m	
ANT	802.11b CH06 2437MHz - R	
1	Horizontal	Fundamental
<p><b>Peak</b></p>	 <p>Site : 03CH11-HY            Condition : PEAK_BE_74 3m HORN 91200-HF HORIZONTAL            RBW:1000.000kHz VBW:3000.000kHz SWF:Auto            Detector : Peak            Project : 881329-01</p>	<p>Left blank</p>
<p><b>Avg.</b></p>	 <p>Site : 03CH11-HY            Condition : AVG_BE_54 3m HORN 91200-HF HORIZONTAL            RBW:1000.000kHz VBW:0.010kHz SWF:Auto            Detector : Peak            Project : 881329-01</p>	<p>Left blank</p>

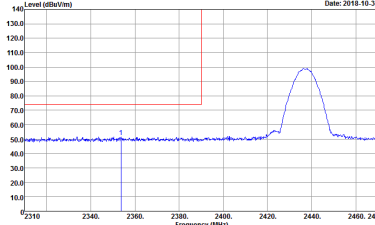
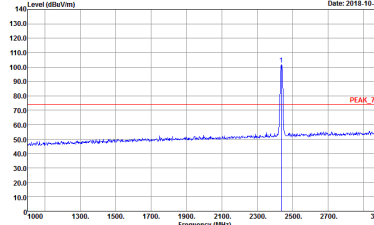
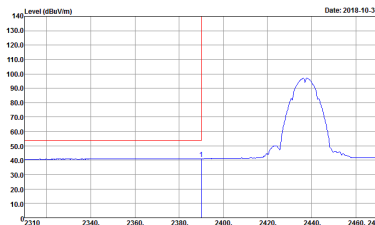
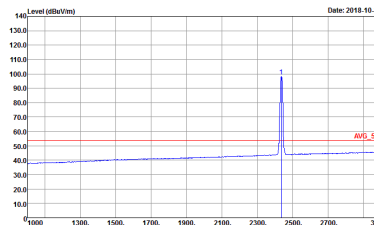

WIFI	2.4GHz 2400~2483.5MHz Band Edge @ 3m	
ANT	802.11b CH06 2437MHz - L	
1	Vertical	Fundamental
Peak	 <p>Site : 03CH11-HY            Condition : PEAK_BE_74 3m HORN 91200-HF VERTICAL            RBW:1000.000KHz VBW:3000.000KHz SWT:Auto            Detector : Peak            Project : 881329-01</p>	 <p>Site : 03CH11-HY            Condition : PEAK_74 3m HORN 91200-HF VERTICAL            RBW:1000.000KHz VBW:3000.000KHz SWT:Auto            Detector : Peak            Project : 881329-01</p>
Avg.	 <p>Site : 03CH11-HY            Condition : AVG_BE_54 3m HORN 91200-HF VERTICAL            RBW:1000.000KHz VBW:0.010KHz SWT:Auto            Detector : Peak            Project : 881329-01</p>	 <p>Site : 03CH11-HY            Condition : AVG_54 3m HORN 91200-HF VERTICAL            RBW:1000.000KHz VBW:0.010KHz SWT:Auto            Detector : Peak            Project : 881329-01</p>

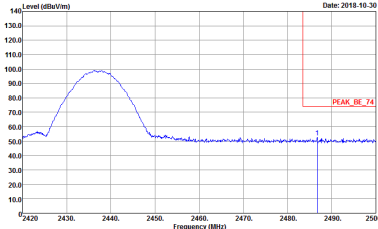
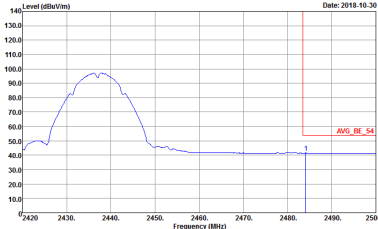

WIFI	2.4GHz 2400~2483.5MHz Band Edge @ 3m	
ANT	802.11b CH06 2437MHz - R	
1	Vertical	Fundamental
<p><b>Peak</b></p>	 <p>Site : 03CH11-HY            Condition : PEAK_BE_74 3m HORN 91200-HF VERTICAL            RBW:1000.000kHz VBW:3000.000kHz SWF:Auto            Detector : Peak            Project : 881329-01</p>	<p>Left blank</p>
<p><b>Avg.</b></p>	 <p>Site : 03CH11-HY            Condition : AVG_BE_54 3m HORN 91200-HF VERTICAL            RBW:1000.000kHz VBW:0.010kHz SWF:Auto            Detector : Peak            Project : 881329-01</p>	<p>Left blank</p>

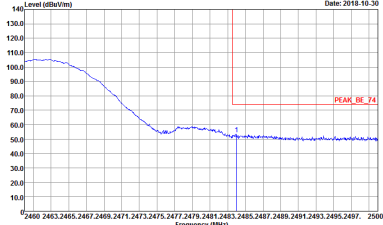
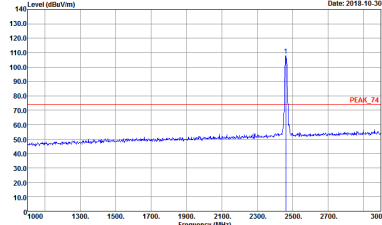
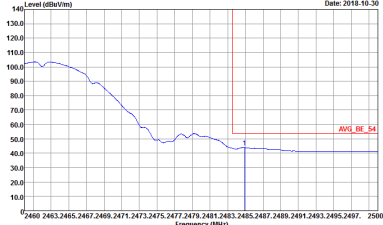
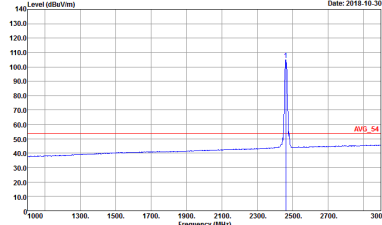

WIFI	2.4GHz 2400~2483.5MHz Band Edge @ 3m	
ANT	802.11b CH11 2462MHz	
1	Horizontal	Fundamental
Peak	 <p>Site : 03CH11-HY            Condition : PEAK_BE_74 3m HORN 91200-HF HORIZONTAL            RBW:1000.000KHz VBW:3000.000KHz SWT:Auto            Detector : Peak            Project : 881329-01</p>	 <p>Site : 03CH11-HY            Condition : PEAK_74 3m HORN 91200-HF HORIZONTAL            RBW:1000.000KHz VBW:3000.000KHz SWT:Auto            Detector : Peak            Project : 881329-01</p>
Avg.	 <p>Site : 03CH11-HY            Condition : AVG_BE_54 3m HORN 91200-HF HORIZONTAL            RBW:1000.000KHz VBW:0.010KHz SWT:Auto            Detector : Peak            Project : 881329-01</p>	 <p>Site : 03CH11-HY            Condition : AVG_54 3m HORN 91200-HF HORIZONTAL            RBW:1000.000KHz VBW:0.010KHz SWT:Auto            Detector : Peak            Project : 881329-01</p>

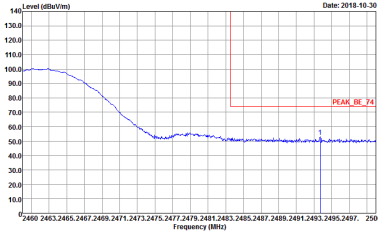
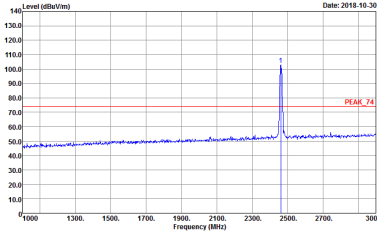
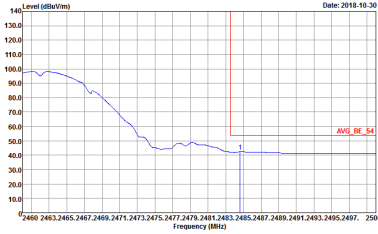
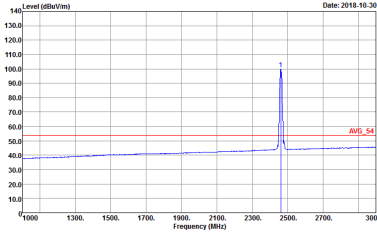

WIFI	2.4GHz 2400~2483.5MHz Band Edge @ 3m	
ANT	802.11b CH11 2462MHz	
1	Vertical	Fundamental
Peak	 <p>Site : 03CH11-HY            Condition : PEAK_BE_74 3m HORN 91200-HF VERTICAL            RBW:1000.000KHz VBW:3000.000KHz SWT:Auto            Detector : Peak            Project : 881329-01</p>	 <p>Site : 03CH11-HY            Condition : PEAK_74 3m HORN 91200-HF VERTICAL            RBW:1000.000KHz VBW:3000.000KHz SWT:Auto            Detector : Peak            Project : 881329-01</p>
Avg.	 <p>Site : 03CH11-HY            Condition : AVG_BE_54 3m HORN 91200-HF VERTICAL            RBW:1000.000KHz VBW:0.010KHz SWT:Auto            Detector : Peak            Project : 881329-01</p>	 <p>Site : 03CH11-HY            Condition : AVG_54 3m HORN 91200-HF VERTICAL            RBW:1000.000KHz VBW:0.010KHz SWT:Auto            Detector : Peak            Project : 881329-01</p>



WIFI	2.4GHz 2400~2483.5MHz Band Edge @ 3m	
ANT	802.11b CH12 2467MHz	
1	Horizontal	Fundamental
<p><b>Peak</b></p>	<p>Site : 03CH11-HY            Condition : PEAK_BE_74 3m HORN 91200-HF HORIZONTAL            Detector : Peak            Project : 881329-01            Setting : 15</p>	<p>Site : 03CH11-HY            Condition : PEAK_74 3m HORN 91200-HF HORIZONTAL            Detector : Peak            Project : 881329-01            Setting : 15</p>
<p><b>Avg.</b></p>	<p>Site : 03CH11-HY            Condition : AVG_BE_54 3m HORN 91200-HF HORIZONTAL            Detector : Peak            Project : 881329-01            Setting : 15</p>	<p>Site : 03CH11-HY            Condition : AVG_54 3m HORN 91200-HF HORIZONTAL            Detector : Peak            Project : 881329-01            Setting : 15</p>



WIFI	2.4GHz 2400~2483.5MHz Band Edge @ 3m	
ANT	802.11b CH12 2467MHz	
1	Vertical	Fundamental
<p><b>Peak</b></p>	<p>Site : 03CH11-HY            Condition : PEAK_BE_74 3m HORN 91200-HF VERTICAL            Detector : Peak            Project : 881329-01            Setting : 15</p>	<p>Site : 03CH11-HY            Condition : PEAK_74 3m HORN 91200-HF VERTICAL            Detector : Peak            Project : 881329-01            Setting : 15</p>
<p><b>Avg.</b></p>	<p>Site : 03CH11-HY            Condition : AVG_BE_54 3m HORN 91200-HF VERTICAL            Detector : Peak            Project : 881329-01            Setting : 15</p>	<p>Site : 03CH11-HY            Condition : AVG_54 3m HORN 91200-HF VERTICAL            Detector : Peak            Project : 881329-01            Setting : 15</p>

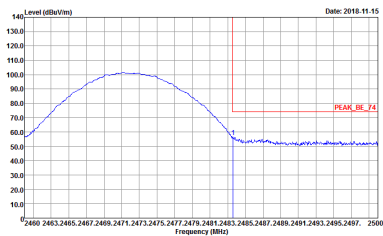
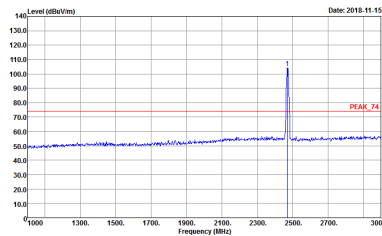
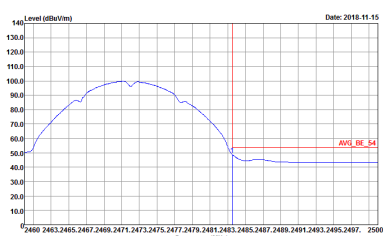
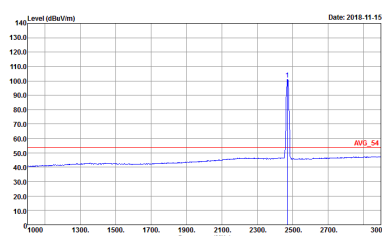

WIFI	2.4GHz 2400~2483.5MHz Band Edge @ 3m	
ANT	802.11b CH13 2472MHz	
1	Horizontal	Fundamental
Peak	 <p>Site : 03CH11-HY            Condition : PEAK_BE_74 3m HORN 91200-HF HORIZONTAL            : RBW:1000.000KHz VBW:3000.000KHz SWT:Auto            Detector : Peak            Project : 881329-01            Setting : 0</p>	 <p>Site : 03CH11-HY            Condition : PEAK_74 3m HORN 91200-HF HORIZONTAL            : RBW:1000.000KHz VBW:3000.000KHz SWT:Auto            Detector : Peak            Project : 881329-01            Setting : 0</p>
Avg.	 <p>Site : 03CH11-HY            Condition : AVG_BE_54 3m HORN 91200-HF HORIZONTAL            : RBW:1000.000KHz VBW:0.010KHz SWT:Auto            Detector : Peak            Project : 881329-01            Setting : 0</p>	 <p>Site : 03CH11-HY            Condition : AVG_54 3m HORN 91200-HF HORIZONTAL            : RBW:1000.000KHz VBW:0.010KHz SWT:Auto            Detector : Peak            Project : 881329-01            Setting : 0</p>





WIFI	2.4GHz 2400~2483.5MHz Band Edge @ 3m	
ANT	802.11b CH13 2472MHz	
1	Vertical	Fundamental
Peak	<p>Site : 03CH11-HY            Condition : PEAK_BE_74 3m HORN 9120D-HF VERTICAL            : RBW:1000.000KHz VBW:3000.000KHz SWT:Auto            Detector : Peak            Project : 881329-01            Setting : 0</p>	<p>Site : 03CH11-HY            Condition : PEAK_74 3m HORN 9120D-HF VERTICAL            : RBW:1000.000KHz VBW:3000.000KHz SWT:Auto            Detector : Peak            Project : 881329-01            Setting : 0</p>
Avg.	<p>Site : 03CH11-HY            Condition : AVG_BE_54 3m HORN 9120D-HF VERTICAL            : RBW:1000.000KHz VBW:0.010KHz SWT:Auto            Detector : Peak            Project : 881329-01            Setting : 0</p>	<p>Site : 03CH11-HY            Condition : AVG_54 3m HORN 9120D-HF VERTICAL            : RBW:1000.000KHz VBW:0.010KHz SWT:Auto            Detector : Peak            Project : 881329-01            Setting : 0</p>

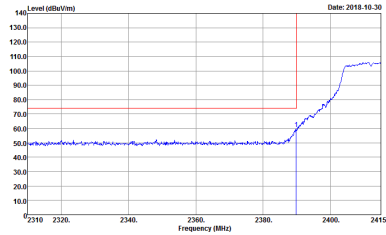
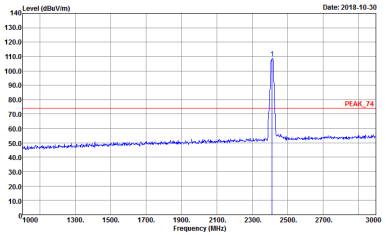
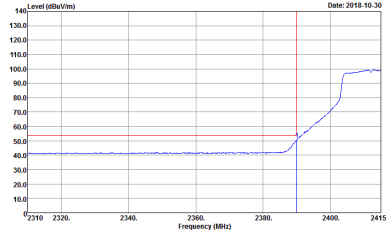
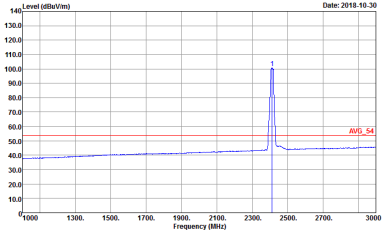

2.4GHz 2400~2483.5MHz  
WIFI 802.11g (Band Edge @ 3m)

WIFI	2.4GHz 2400~2483.5MHz Band Edge @ 3m	
ANT	802.11g CH01 2412MHz	
1	Horizontal	Fundamental
Peak	 <p>Site : 03CH11-HY Condition : PEAK_BE_74 3m HORN 91200-HF HORIZONTAL Detector : Peak Project : 881329-01 Setting : 16</p>	 <p>Site : 03CH11-HY Condition : PEAK_74 3m HORN 91200-HF HORIZONTAL Detector : Peak Project : 881329-01 Setting : 16</p>
Avg.	 <p>Site : 03CH11-HY Condition : AVG_BE_54 3m HORN 91200-HF HORIZONTAL Detector : Peak Project : 881329-01 Setting : 16</p>	 <p>Site : 03CH11-HY Condition : AVG_54 3m HORN 91200-HF HORIZONTAL Detector : Peak Project : 881329-01 Setting : 16</p>

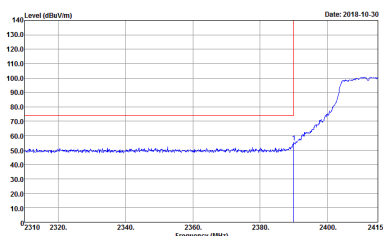
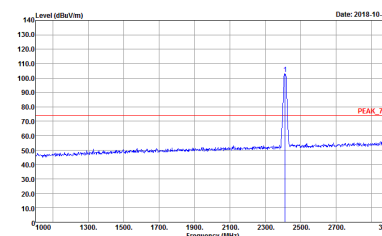
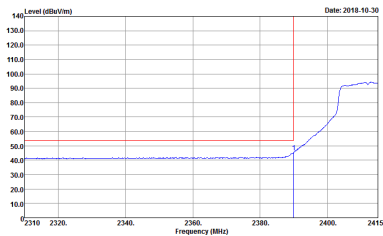
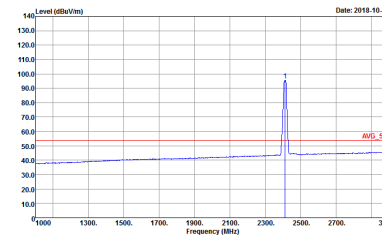

WIFI	2.4GHz 2400~2483.5MHz Band Edge @ 3m	
ANT	802.11g CH01 2412MHz	
1	Vertical	Fundamental
Peak	 <p>Site : 03CH11-HY            Condition : PEAK_BE_74 3m HORN 91200-HF VERTICAL            RBW:1000.000KHz VBW:3000.000KHz SWT:Auto            Detector : Peak            Project : 881329-01            Setting : 16</p>	 <p>Site : 03CH11-HY            Condition : PEAK_74 3m HORN 91200-HF VERTICAL            RBW:1000.000KHz VBW:3000.000KHz SWT:Auto            Detector : Peak            Project : 881329-01            Setting : 16</p>
Avg.	 <p>Site : 03CH11-HY            Condition : AVG_BE_54 3m HORN 91200-HF VERTICAL            RBW:1000.000KHz VBW:1000KHz SWT:Auto            Detector : Peak            Project : 881329-01            Setting : 16</p>	 <p>Site : 03CH11-HY            Condition : AVG_54 3m HORN 91200-HF VERTICAL            RBW:1000.000KHz VBW:1000KHz SWT:Auto            Detector : Peak            Project : 881329-01            Setting : 16</p>

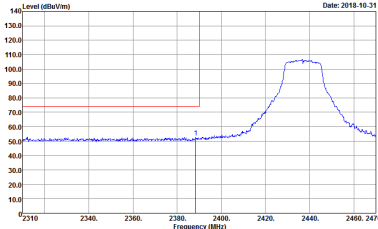
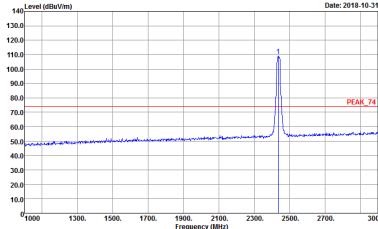
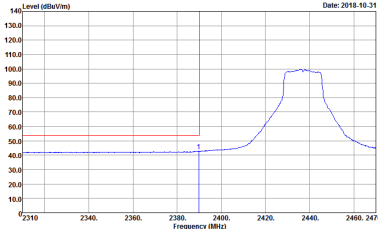
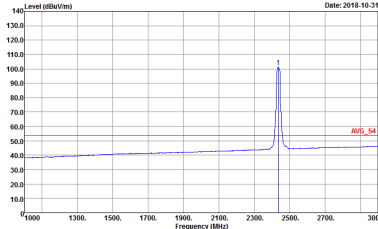

WIFI	2.4GHz 2400~2483.5MHz Band Edge @ 3m	
ANT	802.11g CH06 2437MHz - L	
1	Horizontal	Fundamental
Peak	 <p>Site : 03CH11-HY            Condition : PEAK_BE_74 3m HORN 91200-HF HORIZONTAL            RBW:1000.000KHz VBW:3000.000KHz SWT:Auto            Detector : Peak            Project : 881329-01            Setting : 16.5</p>	 <p>Site : 03CH11-HY            Condition : PEAK_74 3m HORN 91200-HF HORIZONTAL            RBW:1000.000KHz VBW:3000.000KHz SWT:Auto            Detector : Peak            Project : 881329-01            Setting : 16.5</p>
Avg.	 <p>Site : 03CH11-HY            Condition : AVG_BE_54 3m HORN 91200-HF HORIZONTAL            RBW:1000.000KHz VBW:1000KHz SWT:Auto            Detector : Peak            Project : 881329-01            Setting : 16.5</p>	 <p>Site : 03CH11-HY            Condition : AVG_54 3m HORN 91200-HF HORIZONTAL            RBW:1000.000KHz VBW:1000KHz SWT:Auto            Detector : Peak            Project : 881329-01            Setting : 16.5</p>



WIFI	2.4GHz 2400~2483.5MHz Band Edge @ 3m	
ANT	802.11g CH06 2437MHz - R	
1	Horizontal	Fundamental
Peak	<p>Site : 03CH11-HY Condition : PEAK_BE_74 3m HORN 91200-HF HORIZONTAL RBW:1000.000kHz VBW:3000.000kHz SWF:Auto Detector : Peak Project : 881329-01 Setting : 10.5</p>	Left blank
Avg.	<p>Site : 03CH11-HY Condition : AVG_BE_54 3m HORN 91200-HF HORIZONTAL RBW:1000.000kHz VBW:1.000kHz SWF:Auto Detector : Peak Project : 881329-01 Setting : 10.5</p>	Left blank

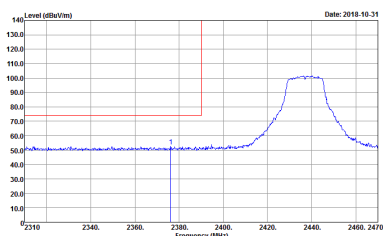
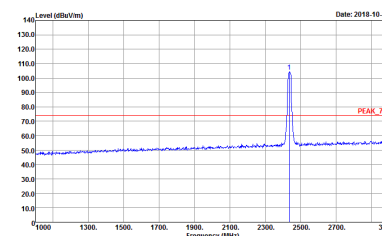
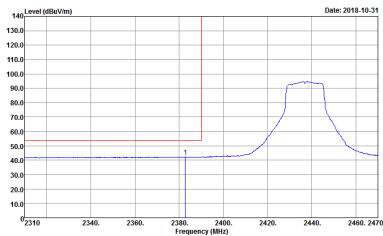
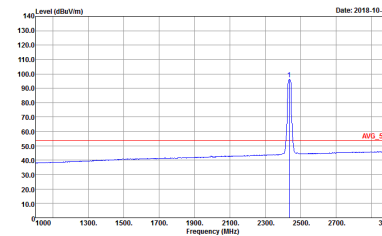

WIFI	2.4GHz 2400~2483.5MHz Band Edge @ 3m	
ANT	802.11g CH06 2437MHz - L	
1	Vertical	Fundamental
Peak	 <p>Site : 03CH11-HY            Condition : PEAK_BE_74 3m HORN 91200-HF VERTICAL            RBW:1000.000KHz VBW:3000.000KHz SWT:Auto            Detector : Peak            Project : 881329-01            Setting : 16.5</p>	 <p>Site : 03CH11-HY            Condition : PEAK_74 3m HORN 91200-HF VERTICAL            RBW:1000.000KHz VBW:3000.000KHz SWT:Auto            Detector : Peak            Project : 881329-01            Setting : 16.5</p>
Avg.	 <p>Site : 03CH11-HY            Condition : AVG_BE_54 3m HORN 91200-HF VERTICAL            RBW:1000.000KHz VBW:1000KHz SWT:Auto            Detector : Peak            Project : 881329-01            Setting : 16.5</p>	 <p>Site : 03CH11-HY            Condition : AVG_54 3m HORN 91200-HF VERTICAL            RBW:1000.000KHz VBW:1000KHz SWT:Auto            Detector : Peak            Project : 881329-01            Setting : 16.5</p>

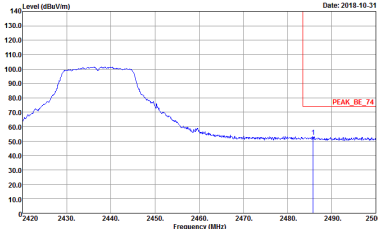
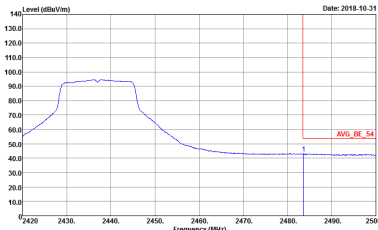

WIFI	2.4GHz 2400~2483.5MHz Band Edge @ 3m	
ANT	802.11g CH06 2437MHz - R	
1	Vertical	Fundamental
<p><b>Peak</b></p>	 <p>Site : 03CH11-HY            Condition : PEAK_BE_74 3m HORN 91200-HF VERTICAL            RBW:1000.000kHz VBW:3000.000kHz SWF:Auto            Detector : Peak            Project : 881329-01            Setting : 16.5</p>	<p>Left Blank</p>
<p><b>Avg.</b></p>	 <p>Site : 03CH11-HY            Condition : AVG_BE_54 3m HORN 91200-HF VERTICAL            RBW:1000.000kHz VBW:1000.000kHz SWF:Auto            Detector : Peak            Project : 881329-01            Setting : 16.5</p>	<p>Left Blank</p>

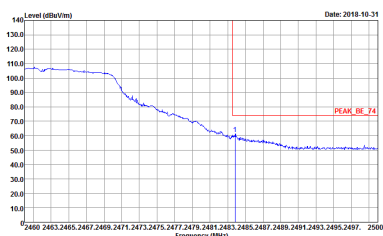
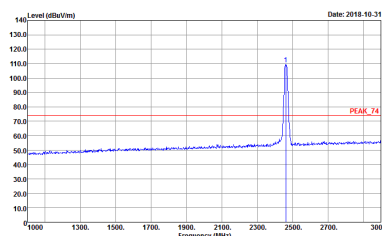
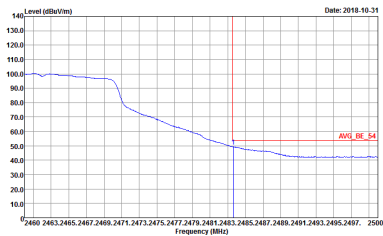
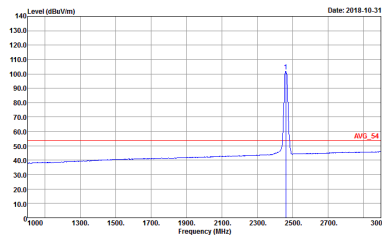

WIFI	2.4GHz 2400~2483.5MHz Band Edge @ 3m	
ANT	802.11g CH11 2462MHz	
1	Horizontal	Fundamental
<p><b>Peak</b></p>	 <p>Site : 03CH11-HY            Condition : PEAK_BE_74 3m HORN 91200-HF HORIZONTAL            Detector : Peak            Project : 881329-01            Setting : 15</p>	 <p>Site : 03CH11-HY            Condition : PEAK_74 3m HORN 91200-HF HORIZONTAL            Detector : Peak            Project : 881329-01            Setting : 15</p>
<p><b>Avg.</b></p>	 <p>Site : 03CH11-HY            Condition : AVG_BE_54 3m HORN 91200-HF HORIZONTAL            Detector : Peak            Project : 881329-01            Setting : 15</p>	 <p>Site : 03CH11-HY            Condition : AVG_54 3m HORN 91200-HF HORIZONTAL            Detector : Peak            Project : 881329-01            Setting : 15</p>



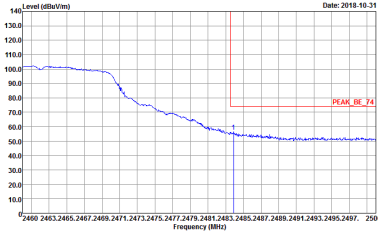
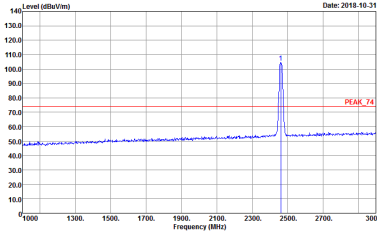
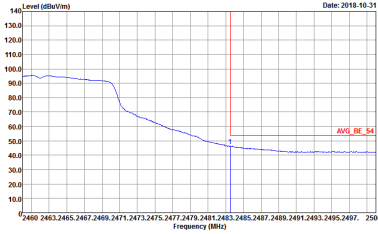
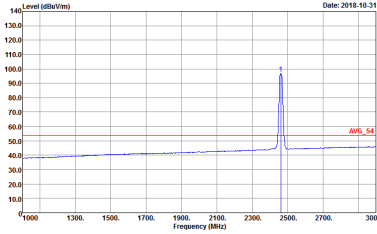

WIFI	2.4GHz 2400~2483.5MHz Band Edge @ 3m	
ANT	802.11g CH11 2462MHz	
1	Vertical	Fundamental
<p><b>Peak</b></p>	 <p>Site : 03CH11-HY            Condition : PEAK_BE_74 3m HORN 91200-HF VERTICAL            Detector : Peak            Project : 881329-01            Setting : 15</p>	 <p>Site : 03CH11-HY            Condition : PEAK_74 3m HORN 91200-HF VERTICAL            Detector : Peak            Project : 881329-01            Setting : 15</p>
<p><b>Avg.</b></p>	 <p>Site : 03CH11-HY            Condition : AVG_BE_54 3m HORN 91200-HF VERTICAL            Detector : Peak            Project : 881329-01            Setting : 15</p>	 <p>Site : 03CH11-HY            Condition : AVG_54 3m HORN 91200-HF VERTICAL            Detector : Peak            Project : 881329-01            Setting : 15</p>

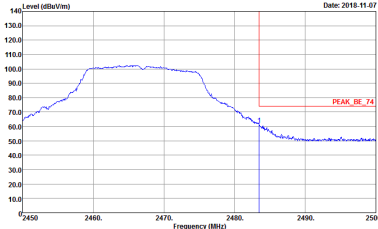
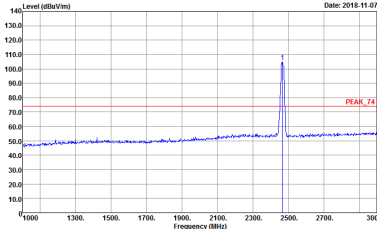
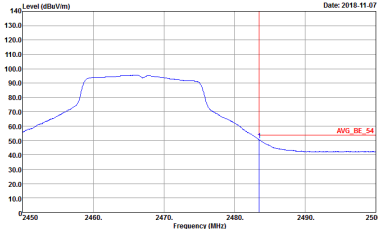
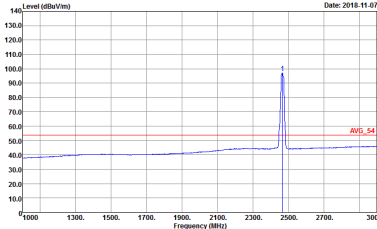

WIFI	2.4GHz 2400~2483.5MHz Band Edge @ 3m	
ANT	802.11g CH12 2467MHz	
1	Horizontal	Fundamental
Peak	 <p>Site : 03CH11-HY Condition : PEAK_BE_74 3m HORN 91200-HF HORIZONTAL Detector : Peak Project : 881329-01 Setting : 13.5</p>	 <p>Site : 03CH11-HY Condition : PEAK_74 3m HORN 91200-HF HORIZONTAL Detector : Peak Project : 881329-01 Setting : 13.5</p>
Avg.	 <p>Site : 03CH11-HY Condition : AVG_BE_54 3m HORN 91200-HF HORIZONTAL Detector : Peak Project : 881329-01 Setting : 13.5</p>	 <p>Site : 03CH11-HY Condition : AVG_54 3m HORN 91200-HF HORIZONTAL Detector : Peak Project : 881329-01 Setting : 13.5</p>



WIFI	2.4GHz 2400~2483.5MHz Band Edge @ 3m	
ANT	802.11g CH12 2467MHz	
1	Vertical	Fundamental
<p><b>Peak</b></p>	<p>Site : 03CH11-HY            Condition : PEAK_BE_74 3m HORN 91200-HF VERTICAL            Detector : Peak            Project : 881329-01            Setting : 13.5</p>	<p>Site : 03CH11-HY            Condition : PEAK_74 3m HORN 91200-HF VERTICAL            Detector : Peak            Project : 881329-01            Setting : 13.5</p>
<p><b>Avg.</b></p>	<p>Site : 03CH11-HY            Condition : AVG_BE_54 3m HORN 91200-HF VERTICAL            Detector : Peak            Project : 881329-01            Setting : 13.5</p>	<p>Site : 03CH11-HY            Condition : AVG_54 3m HORN 91200-HF VERTICAL            Detector : Peak            Project : 881329-01            Setting : 13.5</p>



WIFI	2.4GHz 2400~2483.5MHz Band Edge @ 3m	
ANT	802.11g CH13 2472MHz	
1	Horizontal	Fundamental
Peak	<p>Site : 03CH11-HY            Condition : PEAK_BE_74 3m HORN 91200-HF HORIZONTAL            : RBW:1000.000KHz VBW:3000.000KHz SWT:Auto            Detector : Peak            Project : 881329-01            Setting : 0</p>	<p>Site : 03CH11-HY            Condition : PEAK_74 3m HORN 91200-HF HORIZONTAL            : RBW:1000.000KHz VBW:3000.000KHz SWT:Auto            Detector : Peak            Project : 881329-01            Setting : 0</p>
Avg.	<p>Site : 03CH11-HY            Condition : AVG_BE_54 3m HORN 91200-HF HORIZONTAL            : RBW:1000.000KHz VBW:1.000KHz SWT:Auto            Detector : Peak            Project : 881329-01            Setting : 0</p>	<p>Site : 03CH11-HY            Condition : AVG_54 3m HORN 91200-HF HORIZONTAL            : RBW:1000.000KHz VBW:1.000KHz SWT:Auto            Detector : Peak            Project : 881329-01            Setting : 0</p>

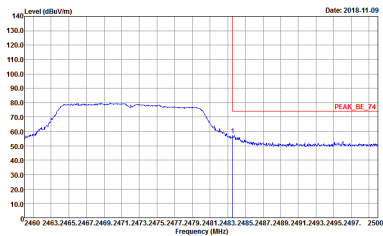
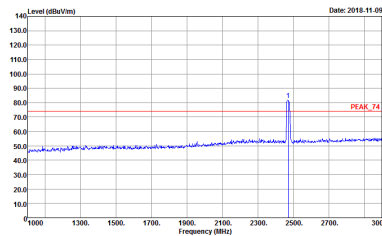
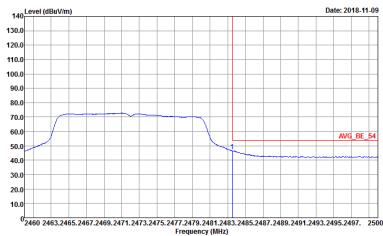
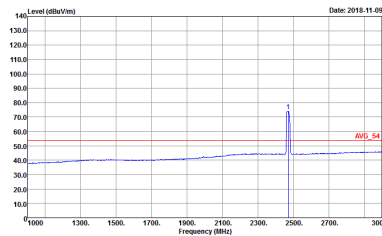

WIFI	2.4GHz 2400~2483.5MHz Band Edge @ 3m	
ANT	802.11g CH13 2472MHz	
1	Vertical	Fundamental
Peak	 <p>Site : 03CH11-HY            Condition : PEAK_BE_74 3m HORN 91200-HF VERTICAL            : RBW:1000.000KHz VBW:3000.000KHz SWT:Auto            Detector : Peak            Project : 881329-01            Setting : 0</p>	 <p>Site : 03CH11-HY            Condition : PEAK_74 3m HORN 91200-HF VERTICAL            : RBW:1000.000KHz VBW:3000.000KHz SWT:Auto            Detector : Peak            Project : 881329-01            Setting : 0</p>
Avg.	 <p>Site : 03CH11-HY            Condition : AVG_BE_54 3m HORN 91200-HF VERTICAL            : RBW:1000.000KHz VBW:1.000KHz SWT:Auto            Detector : Peak            Project : 881329-01            Setting : 0</p>	 <p>Site : 03CH11-HY            Condition : AVG_54 3m HORN 91200-HF VERTICAL            : RBW:1000.000KHz VBW:1.000KHz SWT:Auto            Detector : Peak            Project : 881329-01            Setting : 0</p>



2.4GHz 2400~2483.5MHz  
 WIFI 802.11n HT20 (Band Edge @ 3m)

WIFI	2.4GHz 2400~2483.5MHz Band Edge @ 3m	
ANT	802.11n HT20 CH01 2412MHz	
1	Horizontal	Fundamental
Peak	<p>Site : 03CH11-HY            Condition : PEAK_BE_74 3m HORN 91200-HF HORIZONTAL            RBW:1000.000KHz VBW:3000.000KHz SWT:Auto            Detector : Peak            Project : 881329-01</p>	<p>Site : 03CH11-HY            Condition : PEAK_74 3m HORN 91200-HF HORIZONTAL            RBW:1000.000KHz VBW:3000.000KHz SWT:Auto            Detector : Peak            Project : 881329-01</p>
Avg.	<p>Site : 03CH11-HY            Condition : AVG_BE_54 3m HORN 91200-HF HORIZONTAL            RBW:1000.000KHz VBW:1000KHz SWT:Auto            Detector : Peak            Project : 881329-01</p>	<p>Site : 03CH11-HY            Condition : AVG_54 3m HORN 91200-HF HORIZONTAL            RBW:1000.000KHz VBW:1000KHz SWT:Auto            Detector : Peak            Project : 881329-01</p>

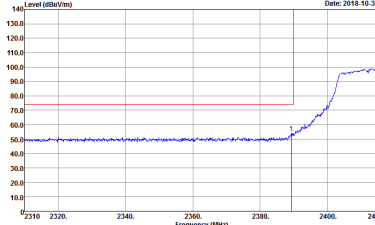
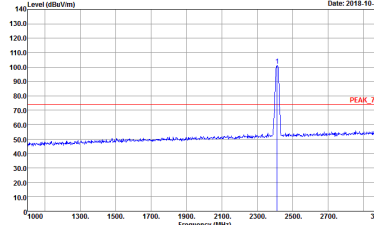
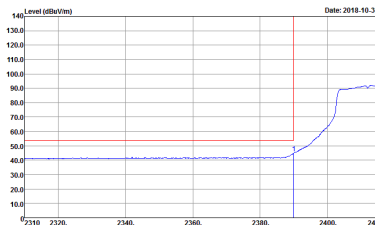
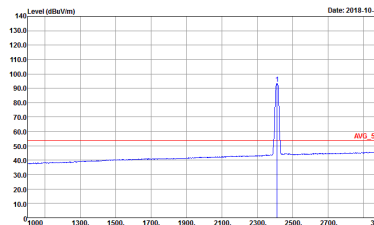

WIFI	2.4GHz 2400~2483.5MHz Band Edge @ 3m	
ANT	802.11n HT20 CH01 2412MHz	
1	Vertical	Fundamental
Peak	 <p>Site : 03CH11-HY            Condition : PEAK_BE_74 3m HORN 91200-HF VERTICAL            RBW:1000.000KHz VBW:3000.000KHz SWT:Auto            Detector : Peak            Project : 881329-01</p>	 <p>Site : 03CH11-HY            Condition : PEAK_74 3m HORN 91200-HF VERTICAL            RBW:1000.000KHz VBW:3000.000KHz SWT:Auto            Detector : Peak            Project : 881329-01</p>
Avg.	 <p>Site : 03CH11-HY            Condition : AVG_BE_54 3m HORN 91200-HF VERTICAL            RBW:1000.000KHz VBW:1000KHz SWT:Auto            Detector : Peak            Project : 881329-01</p>	 <p>Site : 03CH11-HY            Condition : AVG_54 3m HORN 91200-HF VERTICAL            RBW:1000.000KHz VBW:1000KHz SWT:Auto            Detector : Peak            Project : 881329-01</p>

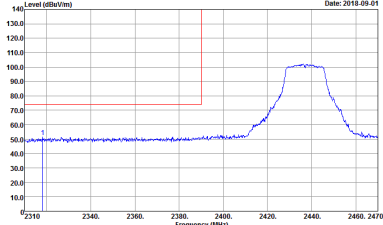
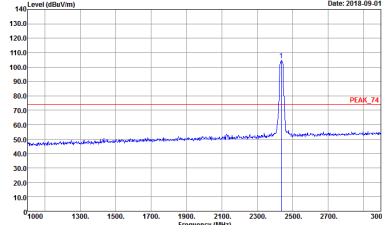
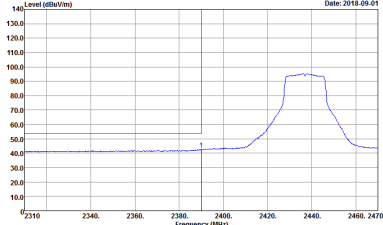
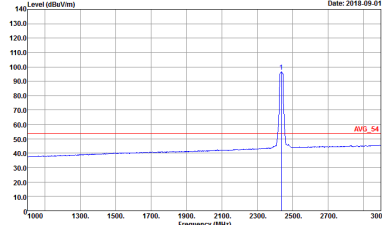

WIFI	2.4GHz 2400~2483.5MHz Band Edge @ 3m	
ANT	802.11n HT20 CH06 2437MHz - L	
1	Horizontal	Fundamental
Peak	 <p>Site : 03CH11-HY            Condition : PEAK_BE_74 3m HORN 91200-HF HORIZONTAL            RBW:1000.000KHz VBW:3000.000KHz SWT:Auto            Detector : Peak            Project : 881329-01</p>	 <p>Site : 03CH11-HY            Condition : PEAK_74 3m HORN 91200-HF HORIZONTAL            RBW:1000.000KHz VBW:3000.000KHz SWT:Auto            Detector : Peak            Project : 881329-01</p>
Avg.	 <p>Site : 03CH11-HY            Condition : AVG_BE_54 3m HORN 91200-HF HORIZONTAL            RBW:1000.000KHz VBW:1000KHz SWT:Auto            Detector : Peak            Project : 881329-01</p>	 <p>Site : 03CH11-HY            Condition : AVG_54 3m HORN 91200-HF HORIZONTAL            RBW:1000.000KHz VBW:1000KHz SWT:Auto            Detector : Peak            Project : 881329-01</p>



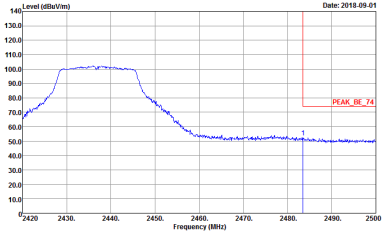
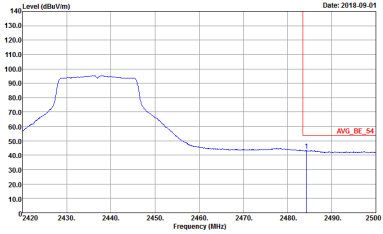

WIFI	2.4GHz 2400~2483.5MHz Band Edge @ 3m	
ANT	802.11n HT20 CH06 2437MHz - R	
1	Horizontal	Fundamental
<p><b>Peak</b></p>	 <p>Site : 03CH11-HY            Condition : PEAK_BE_74 3m HORN 91200-HF HORIZONTAL            RBW:1000.000kHz VBW:3000.000kHz SWF:Auto            Detector : Peak            Project : 881329-01</p>	<p>Left blank</p>
<p><b>Avg.</b></p>	 <p>Site : 03CH11-HY            Condition : AVG_BE_54 3m HORN 91200-HF HORIZONTAL            RBW:1000.000kHz VBW:1000kHz SWF:Auto            Detector : Peak            Project : 881329-01</p>	<p>Left blank</p>



WIFI	2.4GHz 2400~2483.5MHz Band Edge @ 3m	
ANT	802.11n HT20 CH06 2437MHz - L	
1	Vertical	Fundamental
Peak	<p>Site : 03CH11-HY            Condition : PEAK_BE_74 3m HORN 91200-HF VERTICAL            RBW:1000.000KHz VBW:3000.000KHz SWT:Auto            Detector : Peak            Project : 881329-01</p>	<p>Site : 03CH11-HY            Condition : PEAK_74 3m HORN 91200-HF VERTICAL            RBW:1000.000KHz VBW:3000.000KHz SWT:Auto            Detector : Peak            Project : 881329-01</p>
Avg.	<p>Site : 03CH11-HY            Condition : AVG_BE_54 3m HORN 91200-HF VERTICAL            RBW:1000.000KHz VBW:1000KHz SWT:Auto            Detector : Peak            Project : 881329-01</p>	<p>Site : 03CH11-HY            Condition : AVG_54 3m HORN 91200-HF VERTICAL            RBW:1000.000KHz VBW:1000KHz SWT:Auto            Detector : Peak            Project : 881329-01</p>

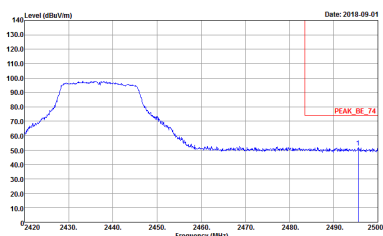
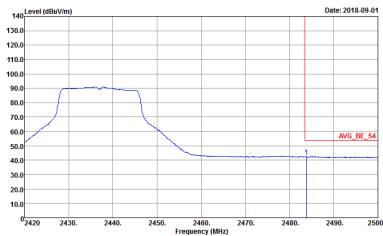

WIFI	2.4GHz 2400~2483.5MHz Band Edge @ 3m	
ANT	802.11n HT20 CH06 2437MHz - R	
1	Vertical	Fundamental
<p><b>Peak</b></p>	 <p>Date: 2018-09-01</p> <p>Site : 03CH11-HY            Condition : PEAK_BE_74 3m HORN 91200-HF VERTICAL            RBW:1000.000kHz VBW:3000.000kHz SWF:Auto            Detector : Peak            Project : 881329-01</p>	<p>Left Blank</p>
<p><b>Avg.</b></p>	 <p>Date: 2018-09-01</p> <p>Site : 03CH11-HY            Condition : AVG_BE_54 3m HORN 91200-HF VERTICAL            RBW:1000.000kHz VBW:1000.000kHz SWF:Auto            Detector : Peak            Project : 881329-01</p>	<p>Left Blank</p>

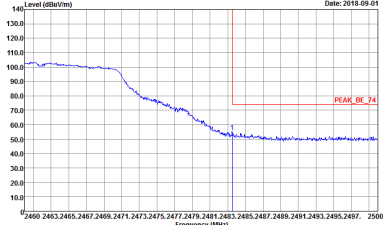
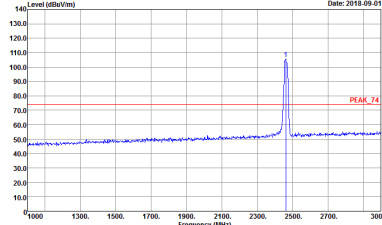
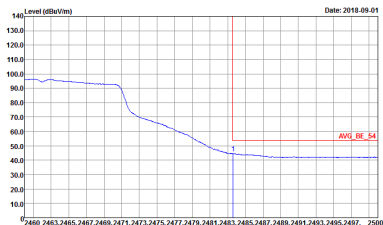
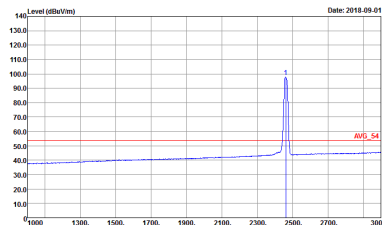

WIFI	2.4GHz 2400~2483.5MHz Band Edge @ 3m	
ANT	802.11n HT20 CH11 2462MHz	
1	Horizontal	Fundamental
Peak	 <p>Site : 03CH11-HY            Condition : PEAK_BE_74 3m HORN 91200-HF HORIZONTAL            RBW:1000.000KHz VBW:3000.000KHz SWT:Auto            Detector : Peak            Project : 881329-01</p>	 <p>Site : 03CH11-HY            Condition : PEAK_74 3m HORN 91200-HF HORIZONTAL            RBW:1000.000KHz VBW:3000.000KHz SWT:Auto            Detector : Peak            Project : 881329-01</p>
Avg.	 <p>Site : 03CH11-HY            Condition : AVG_BE_54 3m HORN 91200-HF HORIZONTAL            RBW:1000.000KHz VBW:1000KHz SWT:Auto            Detector : Peak            Project : 881329-01</p>	 <p>Site : 03CH11-HY            Condition : AVG_54 3m HORN 91200-HF HORIZONTAL            RBW:1000.000KHz VBW:1000KHz SWT:Auto            Detector : Peak            Project : 881329-01</p>

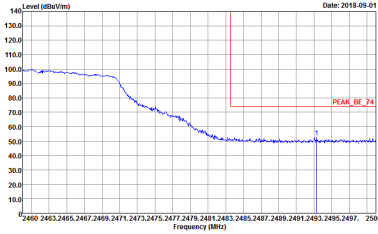
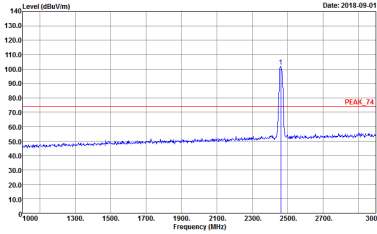
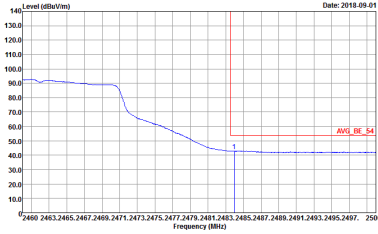
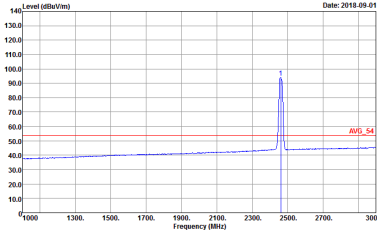

WIFI	2.4GHz 2400~2483.5MHz Fundamental @ 3m	
ANT	802.11n HT20 CH11 2462MHz	
1	Vertical	Fundamental
Peak	 <p>Site : 03CH11-HY            Condition : PEAK_BE_74 3m HORN 91200-HF VERTICAL            RBW:1000.000KHz VBW:3000.000KHz SWT:Auto            Detector : Peak            Project : 881329-01</p>	 <p>Site : 03CH11-HY            Condition : PEAK_74 3m HORN 91200-HF VERTICAL            RBW:1000.000KHz VBW:3000.000KHz SWT:Auto            Detector : Peak            Project : 881329-01</p>
Avg.	 <p>Site : 03CH11-HY            Condition : AVG_BE_54 3m HORN 91200-HF VERTICAL            RBW:1000.000KHz VBW:1000KHz SWT:Auto            Detector : Peak            Project : 881329-01</p>	 <p>Site : 03CH11-HY            Condition : AVG_54 3m HORN 91200-HF VERTICAL            RBW:1000.000KHz VBW:1000KHz SWT:Auto            Detector : Peak            Project : 881329-01</p>

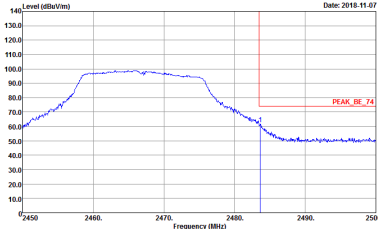
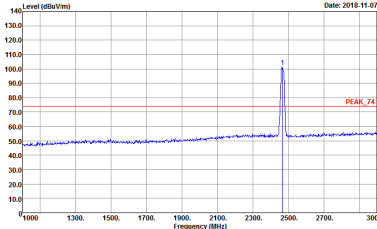
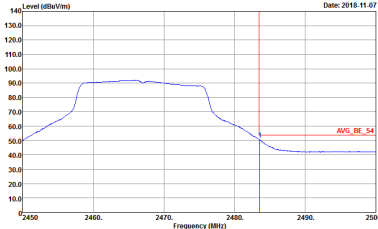
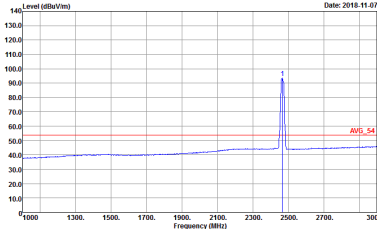

WIFI	2.4GHz 2400~2483.5MHz Band Edge @ 3m	
ANT	802.11n HT20 CH12 2467MHz	
1	Horizontal	Fundamental
Peak	 <p>Site : 03CH11-HY            Condition : PEAK_BE_74 3m HORN 91200-HF HORIZONTAL            Detector : Peak            Project : 881329-01            Setting : 9.5</p>	 <p>Site : 03CH11-HY            Condition : PEAK_74 3m HORN 91200-HF HORIZONTAL            Detector : Peak            Project : 881329-01            Setting : 9.5</p>
Avg.	 <p>Site : 03CH11-HY            Condition : AVG_BE_54 3m HORN 91200-HF HORIZONTAL            Detector : Peak            Project : 881329-01            Setting : 9.5</p>	 <p>Site : 03CH11-HY            Condition : AVG_54 3m HORN 91200-HF HORIZONTAL            Detector : Peak            Project : 881329-01            Setting : 9.5</p>

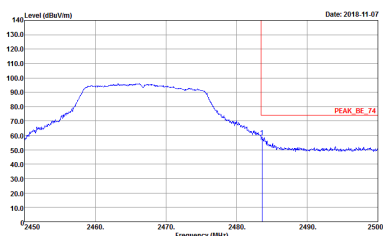
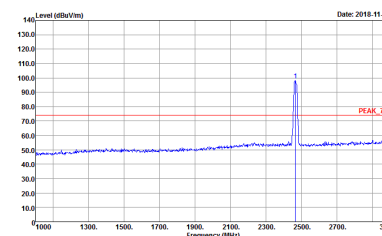
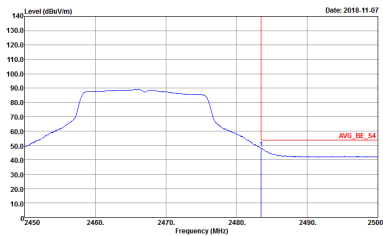
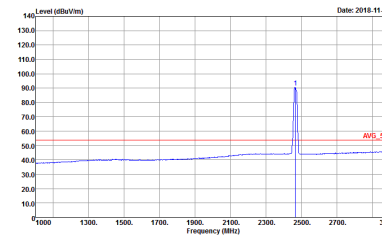

WIFI	2.4GHz 2400~2483.5MHz Band Edge @ 3m	
ANT	802.11n HT20 CH12 2467MHz	
1	Vertical	Fundamental
Peak	 <p>Site : 03CH11-HY            Condition : PEAK_BE_74 3m HORN 91200-HF VERTICAL            Detector : Peak            Project : 881329-01            Setting : 9.5</p>	 <p>Site : 03CH11-HY            Condition : PEAK_74 3m HORN 91200-HF VERTICAL            Detector : Peak            Project : 881329-01            Setting : 9.5</p>
Avg.	 <p>Site : 03CH11-HY            Condition : AVG_BE_54 3m HORN 91200-HF VERTICAL            Detector : Peak            Project : 881329-01            Setting : 9.5</p>	 <p>Site : 03CH11-HY            Condition : AVG_54 3m HORN 91200-HF VERTICAL            Detector : Peak            Project : 881329-01            Setting : 9.5</p>

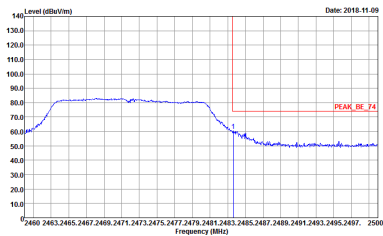
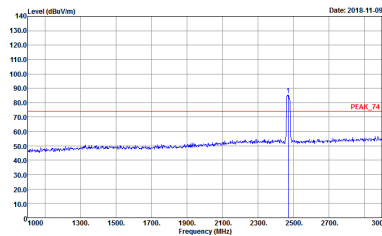
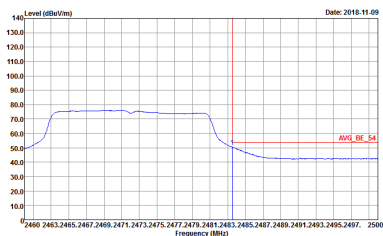
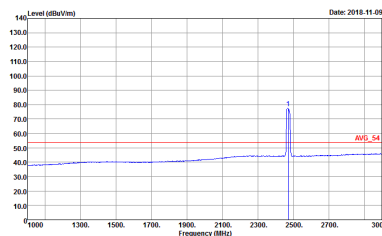

WIFI	2.4GHz 2400~2483.5MHz Band Edge @ 3m	
ANT	802.11n HT20 CH13 2472MHz	
1	Horizontal	Fundamental
Peak	 <p>Site : 03CH11-HY            Condition : PEAK_BE_74 3m HORN 91200-HF HORIZONTAL            : RBW:1000.000KHz VBW:3000.000KHz SWT:Auto            Detector : Peak            Project : 881329-01            Setting : 0</p>	 <p>Site : 03CH11-HY            Condition : PEAK_74 3m HORN 91200-HF HORIZONTAL            : RBW:1000.000KHz VBW:3000.000KHz SWT:Auto            Detector : Peak            Project : 881329-01            Setting : 0</p>
Avg.	 <p>Site : 03CH11-HY            Condition : AVG_BE_54 3m HORN 91200-HF HORIZONTAL            : RBW:1000.000KHz VBW:1.000KHz SWT:Auto            Detector : Peak            Project : 881329-01            Setting : 0</p>	 <p>Site : 03CH11-HY            Condition : AVG_54 3m HORN 91200-HF HORIZONTAL            : RBW:1000.000KHz VBW:1.000KHz SWT:Auto            Detector : Peak            Project : 881329-01            Setting : 0</p>



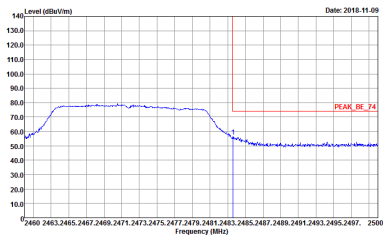
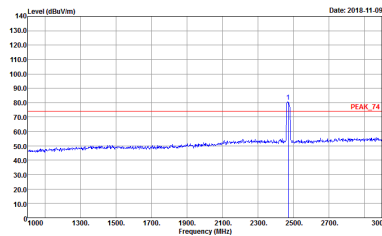
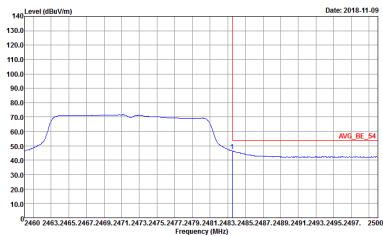
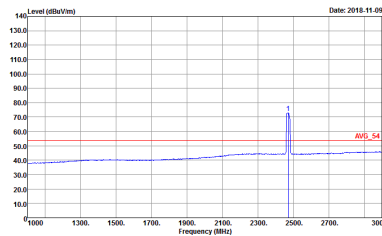

WIFI	2.4GHz 2400~2483.5MHz Band Edge @ 3m	
ANT	802.11n HT20 CH13 2472MHz	
1	Vertical	Fundamental
Peak	 <p>Site : 03CH11-HY            Condition : PEAK_BE_74 3m HORN 91200-HF VERTICAL            : RBW:1000.000KHz VBW:3000.000KHz SWT:Auto            Detector : Peak            Project : 881329-01            Setting : 0</p>	 <p>Site : 03CH11-HY            Condition : PEAK_74 3m HORN 91200-HF VERTICAL            : RBW:1000.000KHz VBW:3000.000KHz SWT:Auto            Detector : Peak            Project : 881329-01            Setting : 0</p>
Avg.	 <p>Site : 03CH11-HY            Condition : AVG_BE_54 3m HORN 91200-HF VERTICAL            : RBW:1000.000KHz VBW:1.000KHz SWT:Auto            Detector : Peak            Project : 881329-01            Setting : 0</p>	 <p>Site : 03CH11-HY            Condition : AVG_54 3m HORN 91200-HF VERTICAL            : RBW:1000.000KHz VBW:1.000KHz SWT:Auto            Detector : Peak            Project : 881329-01            Setting : 0</p>



2.4GHz 2400~2483.5MHz  
 WIFI 802.11b (Harmonic @ 3m)

WIFI	2.4GHz 2400~2483.5MHz Harmonic @ 3m	
ANT	802.11b CH01 2412MHz	
1	Horizontal	Vertical
<b>Peak</b>  <b>Avg.</b>	<p>Site : 03CH11-1FY          Condition : PEAK_74 3m HORN 91200-1HF HORIZONTAL          Detector : Peak          Project : 881329-01</p>	<p>Site : 03CH11-1FY          Condition : PEAK_74 3m HORN 91200-1HF VERTICAL          Detector : Peak          Project : 881329-01</p>

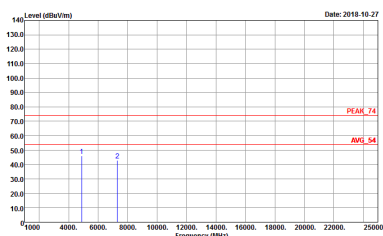
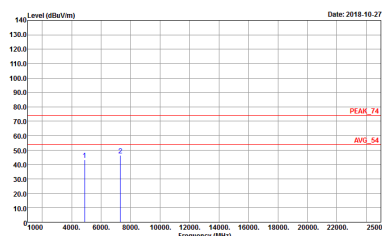

<b>WIFI</b>	<b>2.4GHz 2400~2483.5MHz Harmonic @ 3m</b>	
<b>ANT</b>	<b>802.11b CH06 2437MHz</b>	
<b>1</b>	<b>Horizontal</b>	<b>Vertical</b>
<p><b>Peak</b></p> <p><b>Avg.</b></p>	 <p>Site : 03CH11-HY          Condition : PEAK_74 3m HORN 91200-HF HORIZONTAL          Detector : Peak          Project : 881329-01</p>	 <p>Site : 03CH11-HY          Condition : PEAK_74 3m HORN 91200-HF VERTICAL          Detector : Peak          Project : 881329-01</p>



<b>WIFI</b>	<b>2.4GHz 2400~2483.5MHz Harmonic @ 3m</b>	
<b>ANT</b>	<b>802.11b CH11 2462MHz</b>	
<b>1</b>	<b>Horizontal</b>	<b>Vertical</b>
<b>Peak</b> <b>Avg.</b>	<p>Site : 03CH11-HY Condition : PEAK_74 3m HORN 91200-HF HORIZONTAL Detector : Peak Project : 881329-01</p>	<p>Site : 03CH11-HY Condition : PEAK_74 3m HORN 91200-HF VERTICAL Detector : Peak Project : 881329-01</p>



<b>WIFI</b>	<b>2.4GHz 2400~2483.5MHz Harmonic @ 3m</b>	
<b>ANT</b>	<b>802.11b CH12 2467MHz</b>	
<b>1</b>	<b>Horizontal</b>	<b>Vertical</b>
<b>Peak Avg.</b>	<p>Site : 03CH11-HY Condition : PEAK_74 3m HORN 91200-HF HORIZONTAL Detector : Peak Project : 881329-01 Setting : 15</p>	<p>Site : 03CH11-HY Condition : PEAK_74 3m HORN 91200-HF VERTICAL Detector : Peak Project : 881329-01 Setting : 15</p>



WIFI	2.4GHz 2400~2483.5MHz Harmonic @ 3m	
ANT	802.11b CH13 2472MHz	
1	Horizontal	Vertical
<b>Peak</b> <b>Avg.</b>	<p>Site : 03CH11-HY Condition : PEAK_74 3m HORN 91200-HF HORIZONTAL Detector : Peak Project : 881329-01</p>	<p>Site : 03CH11-HY Condition : PEAK_74 3m HORN 91200-HF VERTICAL Detector : Peak Project : 881329-01</p>

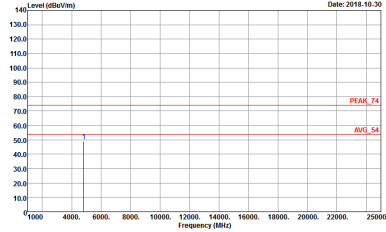
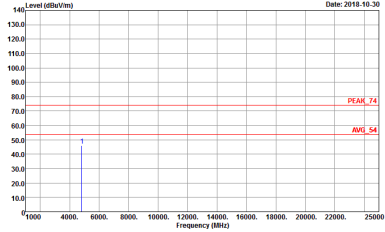

2.4GHz 2400~2483.5MHz  
 WIFI 802.11g (Harmonic @ 3m)

WIFI	2.4GHz 2400~2483.5MHz Harmonic @ 3m	
ANT	802.11g CH01 2412MHz	
1	Horizontal	Vertical
<p>Peak</p> <p>Avg.</p>	 <p>Site : 03CH11-1FY        Condition : PEAK_74 3m HORN 91200-1HF HORIZONTAL        Detector : Peak        Project : 881329-01        Setting : 16</p>	 <p>Site : 03CH11-1FY        Condition : PEAK_74 3m HORN 91200-1HF VERTICAL        Detector : Peak        Project : 881329-01        Setting : 16</p>

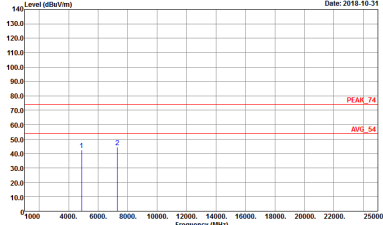
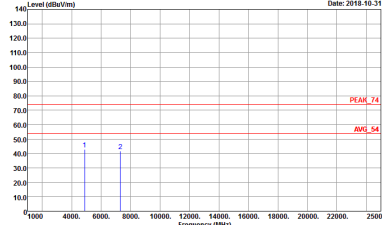

<b>WIFI</b>	<b>2.4GHz 2400~2483.5MHz Harmonic @ 3m</b>	
<b>ANT</b>	<b>802.11g CH06 2437MHz</b>	
<b>1</b>	<b>Horizontal</b>	<b>Vertical</b>
<p><b>Peak</b> <b>Avg.</b></p>	 <p>Site : 03CH11-HY Condition : PEAK_74 3m HORN 91200-HF HORIZONTAL Detector : Peak Project : 881329-01 Setting : 16.5</p>	 <p>Site : 03CH11-HY Condition : PEAK_74 3m HORN 91200-HF VERTICAL Detector : Peak Project : 881329-01 Setting : 16.5</p>





<b>WIFI</b>	<b>2.4GHz 2400~2483.5MHz Harmonic @ 3m</b>	
<b>ANT</b>	<b>802.11g CH11 2462MHz</b>	
<b>1</b>	<b>Horizontal</b>	<b>Vertical</b>
<b>Peak Avg.</b>	<p>Site : 03CH11-HY Condition : PEAK_74 3m HORN 91200-HF HORIZONTAL Detector : Peak Project : 881329-01 Setting : 15</p>	<p>Site : 03CH11-HY Condition : PEAK_74 3m HORN 91200-HF VERTICAL Detector : Peak Project : 881329-01 Setting : 15</p>



<b>WIFI</b>	<b>2.4GHz 2400~2483.5MHz Harmonic @ 3m</b>	
<b>ANT</b>	<b>802.11g CH12 2467MHz</b>	
<b>1</b>	<b>Horizontal</b>	<b>Vertical</b>
<b>Peak Avg.</b>	<p>Site : 03CH11-HY Condition : PEAK_74 3m HORN 91200-HF HORIZONTAL Detector : Peak Project : 881329-01 Setting : 13.5</p>	<p>Site : 03CH11-HY Condition : PEAK_74 3m HORN 91200-HF VERTICAL Detector : Peak Project : 881329-01 Setting : 13.5</p>



<b>WIFI</b>	<b>2.4GHz 2400~2483.5MHz Harmonic @ 3m</b>	
<b>ANT</b>	<b>802.11g CH13 2472MHz</b>	
<b>1</b>	<b>Horizontal</b>	<b>Vertical</b>
<b>Peak</b> <b>Avg.</b>	<p>Site : 03CH11-HY Condition : PEAK_74 3m HORN 91200-HF HORIZONTAL Detector : Peak Project : 881329-01</p>	<p>Site : 03CH11-HY Condition : PEAK_74 3m HORN 91200-HF VERTICAL Detector : Peak Project : 881329-01</p>



2.4GHz 2400~2483.5MHz
WIFI 802.11n HT20 (Harmonic @ 3m)

Table with 2 columns: Horizontal and Vertical. Each column contains a graph of Level (dBuV/m) vs Frequency (MHz) with Peak and Avg values. Includes site and condition details for both orientations.



<b>WIFI</b>	<b>2.4GHz 2400~2483.5MHz Harmonic @ 3m</b>	
<b>ANT</b>	<b>802.11n HT20 CH06 2437MHz</b>	
<b>1</b>	<b>Horizontal</b>	<b>Vertical</b>
<b>Peak Avg.</b>	<p>Site : 03CH11-HY Condition : PEAK_74 3m HORN 91200-HF HORIZONTAL Detector : Peak Project : 881329-01</p>	<p>Site : 03CH11-HY Condition : PEAK_74 3m HORN 91200-HF VERTICAL Detector : Peak Project : 881329-01</p>



<b>WIFI</b>	<b>2.4GHz 2400~2483.5MHz Harmonic @ 3m</b>	
<b>ANT</b>	<b>802.11n HT20 CH11 2462MHz</b>	
<b>1</b>	<b>Horizontal</b>	<b>Vertical</b>
<b>Peak</b> <b>Avg.</b>	<p>Site : 03CH11-HY Condition : PEAK_74 3m HORN 91200-HF HORIZONTAL Detector : Peak Project : 881329-01</p>	<p>Site : 03CH11-HY Condition : PEAK_74 3m HORN 91200-HF VERTICAL Detector : Peak Project : 881329-01</p>



<b>WIFI</b>	<b>2.4GHz 2400~2483.5MHz Harmonic @ 3m</b>	
<b>ANT</b>	<b>802.11n HT20 CH12 2462MHz</b>	
<b>1</b>	<b>Horizontal</b>	<b>Vertical</b>
<b>Peak</b> <b>Avg.</b>	<p>Site : 03CH11-HY Condition : PEAK_74 3m HORN 91200-HF HORIZONTAL RBW:1000.000KHz VBW:3000.000KHz SWT:Auto Detector : Peak Project : 881329-01 Setting : 9.5</p>	<p>Site : 03CH11-HY Condition : PEAK_74 3m HORN 91200-HF VERTICAL RBW:1000.000KHz VBW:3000.000KHz SWT:Auto Detector : Peak Project : 881329-01 Setting : 9.5</p>



<b>WIFI</b>	<b>2.4GHz 2400~2483.5MHz Harmonic @ 3m</b>	
<b>ANT</b>	<b>802.11n HT20 CH13 2472MHz</b>	
<b>1</b>	<b>Horizontal</b>	<b>Vertical</b>
<b>Peak</b> <b>Avg.</b>	<p>Site : 03CH11-HY Condition : PEAK_74 3m HORN 91200-HF HORIZONTAL Detector : Peak Project : 881329-01</p>	<p>Site : 03CH11-HY Condition : PEAK_74 3m HORN 91200-HF VERTICAL Detector : Peak Project : 881329-01</p>





Emission below 1GHz
2.4GHz WIFI 802.11b (LF)

Table with 2 columns: Horizontal and Vertical. Each column contains a spectral plot of Level (dBuV/m) vs Frequency (MHz) from 50 to 1000 MHz. The plots show emission levels with a red QP marker and a blue peak marker. Metadata includes Site: 03CH11-4FY, Condition: QP 3m BT-LOG 6111D-LF\_ETC, Detector: Peak, Project: 881329-01.

QP / Peak



Emission below 1GHz  
2.4GHz WIFI 802.11g (LF)

WIFI	2.4GHz 2400~2483.5MHz	
ANT	802.11g LF	
1	Horizontal	Vertical
QP / Peak	<p>Site : 03CH11-4FY Condition : QP 3m BT-LOG 6111D-LF_ETC HORIZONTAL Detector : Peak Project : 881329-01</p>	<p>Site : 03CH11-4FY Condition : QP 3m BT-LOG 6111D-LF_ETC VERTICAL Detector : Peak Project : 881329-01</p>



Emission below 1GHz
2.4GHz WIFI 802.11n HT20 (LF)

Table with 2 columns: Horizontal and Vertical. Contains two graphs showing Level (dBuV/m) vs Frequency (MHz) for QP/ Peak. Includes site and condition details for each graph.



## Appendix E. Duty Cycle Plots

Band	Duty Cycle(%)	T(us)	1/T(kHz)	VBW Setting	Duty Factor(dB)
802.11b	98.96	-	-	10Hz	0.05
802.11g	95.00	2065	0.48	1kHz	0.22
802.11n HT20	94.66	1928	0.52	1kHz	0.24



802.11b

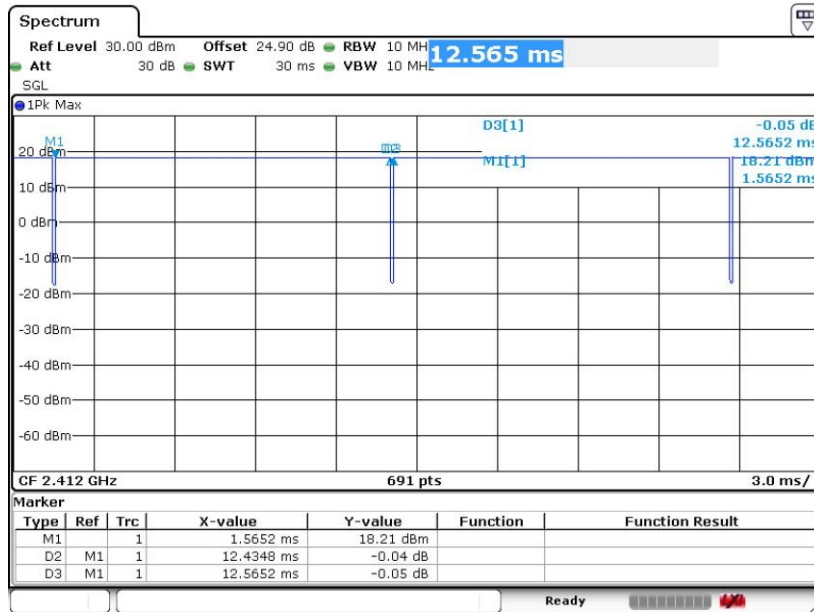

Date: 27.AUG.2018 15:21:38

802.11g

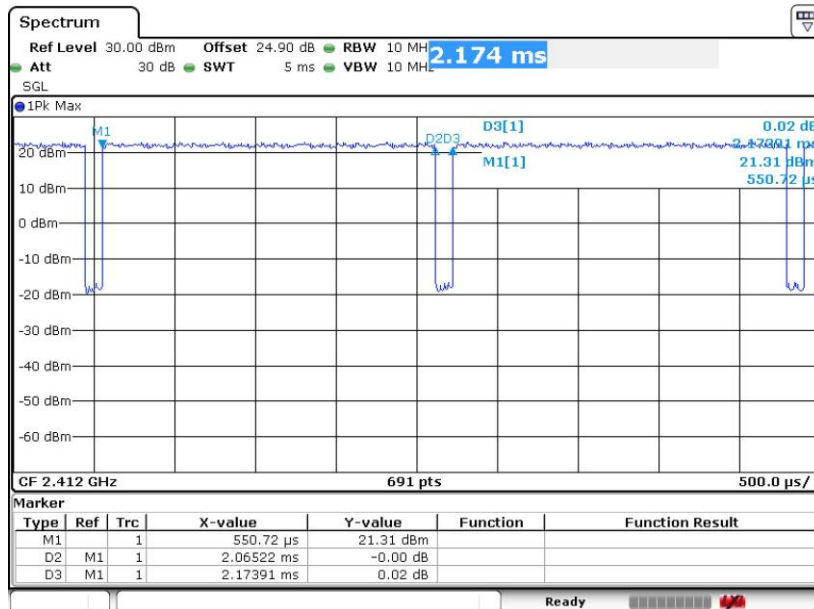

Date: 27.AUG.2018 15:52:42



**802.11n HT20**

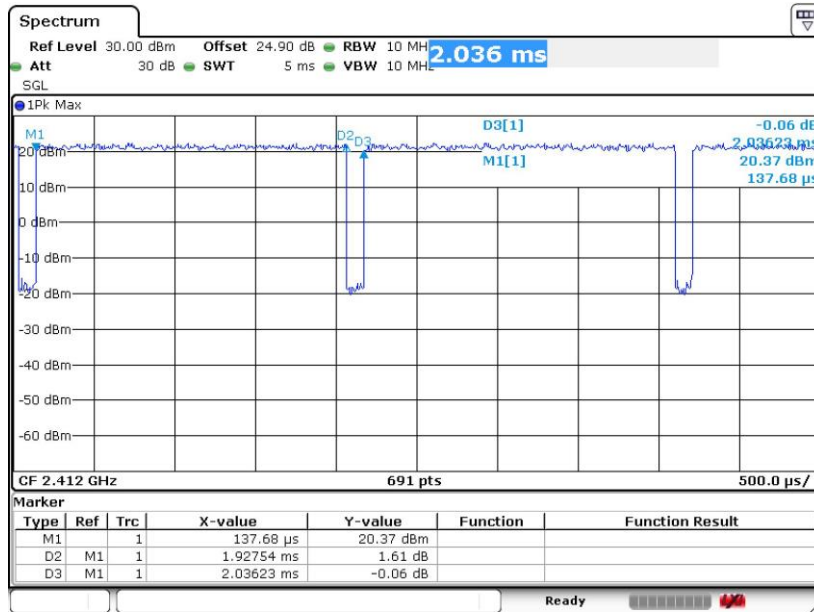

Date: 27.AUG.2018 16:01:11

—————THE END—————