



FCC RADIO TEST REPORT

FCC ID : PY7-58237R
Equipment : GSM/WCDMA/LTE Phone with BT, DTS/UNII
a/b/g/n/ac, NFC, FM receiver and GNSS
Brand Name : SONY
Applicant : Sony Corporation
1-7-1 Konan Minato-ku Tokyo, 108-0076 Japan
Manufacturer : Sony Corporation
1-7-1 Konan Minato-ku Tokyo, 108-0076 Japan
Standard : FCC 47 CFR Part 2, 22(H), 27
Test Date(s) : Dec. 17, 2021 ~ Jan. 04, 2022

We, Sporton International Inc. (Kunshan), would like to declare that the tested sample has been evaluated in accordance with the test procedures given in ANSI / TIA-603-E and has been in compliance with the applicable technical standards.

The test results in this report apply exclusively to the tested model / sample. Without written approval of Sporton International Inc. (Kunshan), the test report shall not be reproduced except in full.

Jason Jia

Reviewed by: Jason Jia / Supervisor

Alex Wang

Approved by: Alex Wang / Manager



Sporton International Inc. (Kunshan)

**No. 1098, Pengxi North Road, Kunshan Economic Development Zone Jiangsu Province 215300
People's Republic of China**



Table of Contents

History of this test report.....3

Summary of Test Result.....4

1 General Description5

 1.1 Product Feature of Equipment Under Test.....5

 1.2 Modification of EUT5

 1.3 Emission Designator.....6

 1.4 Testing Location6

 1.5 Applicable Standards.....7

2 Test Configuration of Equipment Under Test8

 2.1 Test Mode.....8

 2.2 Connection Diagram of Test System.....9

 2.3 Support Unit used in test configuration and system9

 2.4 Measurement Results Explanation Example.....9

 2.5 Frequency List of Low/Middle/High Channels10

3 Conducted Test Items.....11

 3.1 Measuring Instruments11

 3.2 Conducted Output Power and ERP/EIRP12

 3.3 Peak-to-Average Ratio13

 3.4 Occupied Bandwidth.....14

 3.5 Conducted Band Edge15

 3.6 Conducted Spurious Emission16

 3.7 Frequency Stability17

4 Radiated Test Items18

 4.1 Measuring Instruments18

 4.2 Radiated Spurious Emission Measurement20

5 List of Measuring Equipment.....21

6 Uncertainty of Evaluation.....22

Appendix A. Test Results of Conducted Test

Appendix B. Test Results of Radiated Test



History of this test report

Report No.	Version	Description	Issued Date
FG1D0404B	01	Initial issue of report	Mar. 02, 2022



Summary of Test Result

Report Clause	Ref Std. Clause	Test Items	Result (PASS/FAIL)	Remark
3.2	§2.1046	Conducted Output Power	Reporting only	-
	§27.50(c)(10)	Effective Radiated Power (Band 12)	Pass	
	§27.50(h)(2)	Equivalent Isotropic Radiated Power (Band 41)		
3.3	§27.50 (d)(5)	Peak-to-Average Ratio	Pass	-
3.4	§2.1049	Occupied Bandwidth	Reporting only	-
3.5	§2.1051 §27.53(g) §27.53(m)(4)	Conducted Band Edge Measurement (Band 12) (Band 41)	Pass	-
3.6	§2.1051 §27.53(g) §27.53(m)(4)	Conducted Spurious Emission (Band 12) (Band 41)	Pass	-
3.7	§2.1055 §27.54	Frequency Stability Temperature & Voltage	Pass	-
4.2	§2.1053 §27.53(g) §27.53(m)(4)	Radiated Spurious Emission (Band 12) (Band 41)	Pass	Under limit 7.64 dB at 5162.000 MHz

Declaration of Conformity:

The test results with all measurement uncertainty excluded are presented in accordance with the regulation limits or requirements declared by manufacturers.

Comments and Explanations:

The declared of product specification for EUT presented in the report are provided by the manufacturer, and the manufacturer takes all the responsibilities for the accuracy of product specification.



1 General Description

1.1 Product Feature of Equipment Under Test

GSM/WCDMA/LTE, Bluetooth, DTS/UNII a/b/g/n/ac, NFC, FM Receiver, and GNSS

Product Specification subjective to this standard	
Antenna Type	PIFA Antenna
Antenna Gain	LTE Band 12: -1.8dBi LTE Band 41: -1.0dBi

Remark: The above EUT's information was declared by manufacturer. Please refer to Comments and Explanations in report summary.

EUT Information List			
HW Version	SW Version	IMEI Code	Performed Test Item
A	0.166	004402543115707/ 004402543115701	Conducted Measurement
		004402543113645/ 004402543281004	Radiated Spurious Emission
		004402543113645/ 004402543281004	ERP/EIRP Test

Note: For other wireless features of this EUT, test report will be issued separately.

1.2 Modification of EUT

No modifications are made to the EUT during all test items.



1.3 Emission Designator

LTE Band 12		QPSK		16QAM/64QAM	
BW (MHz)	Frequency Range (MHz)	Maximum ERP(W)	Emission Designator (99%OBW)	Maximum ERP(W)	Emission Designator (99%OBW)
1.4	699.7 ~ 715.3	0.0855	1M10G7D	0.0711	1M10W7D
3	700.5 ~ 714.5	0.0863	2M72G7D	0.0718	2M72W7D
5	701.5 ~ 713.5	0.0861	4M51G7D	0.0721	4M49W7D
10	704.0 ~ 711.0	0.0867	9M09G7D	0.0726	9M07W7D
LTE Band 41		QPSK		16QAM/64QAM	
BW (MHz)	Frequency Range (MHz)	Maximum EIRP(W)	Emission Designator (99%OBW)	Maximum EIRP(W)	Emission Designator (99%OBW)
5	2498.5 ~ 2687.5	0.0931	4M52G7D	0.0773	4M53W7D
10	2501.0 ~ 2685.0	0.0925	9M09G7D	0.0767	9M05W7D
15	2503.5 ~ 2682.5	0.0927	13M5G7D	0.0766	13M5W7D
20	2506.0 ~ 2680.0	0.0933	17M9G7D	0.0774	18M1W7D

Note: All modulations have been tested, and only the worst test results of PSK & QAM are shown in the report.

1.4 Testing Location

Sporton International Inc. (Kunshan) is accredited to ISO/IEC 17025:2017 by American Association for Laboratory Accreditation with Certificate Number 5145.02.

Test Firm	Sporton International Inc. (Kunshan)		
Test Site Location	No. 1098, Pengxi North Road, Kunshan Economic Development Zone Jiangsu Province 215300 People's Republic of China TEL : +86-512-57900158 FAX : +86-512-57900958		
Test Site No.	Sporton Site No.	FCC Designation No.	FCC Test Firm Registration No.
	03CH04-KS TH01-KS	CN1257	314309



1.5 Applicable Standards

According to the specifications of the manufacturer, the EUT must comply with the requirements of the following standards:

- ♦ ANSI C63.26-2015
- ♦ ANSI / TIA-603-E
- ♦ FCC 47 CFR Part 2, 27
- ♦ FCC KDB 971168 D01 Power Meas. License Digital Systems v03r01
- ♦ FCC KDB 412172 D01 Determining ERP and EIRP v01r01
- ♦ FCC KDB 414788 D01 Radiated Test Site v01r01.

Remark:

1. All test items were verified and recorded according to the standards and without any deviation during the test.
2. This EUT has also been tested and complied with the requirements of FCC Part 15, Subpart B, recorded in a separate test report.



2 Test Configuration of Equipment Under Test

2.1 Test Mode

Antenna port conducted and radiated test items listed below are performed according to KDB 971168 D01 Power Meas. License Digital Systems v03r01 with maximum output power.

For radiated measurement, the measured emission level of the EUT was maximized by rotating the EUT on a turntable, adjusting the orientation of the EUT and EUT antenna in three orthogonal axis (X: flat, Y: portrait, Z: landscape), and adjusting the measurement antenna orientation, following C63.26 exploratory test procedures and find Y plane as worst plane.

Test Items	Band	Bandwidth (MHz)						Modulation			RB #			Test Channel		
		1.4	3	5	10	15	20	QPSK	16QAM	64QAM	1	Half	Full	L	M	H
Max. Output Power	12	v	v	v	v	-	-	v	v	v	v	v	v	v	v	v
	41	-	-	v	v	v	v	v	v	v	v	v	v	v	v	v
Peak-to-Average Ratio	12				v	-	-	v	v	v	v		v		v	
	41	-	-				v	v	v	v		v		v		
26dB and 99% Bandwidth	12	v	v	v	v	-	-	v	v	v			v	v	v	v
	41	-	-	v	v	v	v	v	v	v			v	v	v	v
Conducted Band Edge	12	v	v	v	v	-	-	v	v	v	v		v			v
	41	-	-	v	v	v	v	v	v	v	v		v			v
Conducted Spurious Emission	12	v	v	v	v	-	-	v	v	v	v			v	v	v
	41	-	-	v	v	v	v	v	v	v	v			v	v	v
Frequency Stability	12				v	-	-	v					v		v	
	41	-	-		v			v					v		v	
E.R.P / E.I.R.P	12	v	v	v	v	-	-	v	v	v	v	v	v	v	v	v
	41	-	-	v	v	v	v	v	v	v	v	v	v	v	v	v
Radiated Spurious Emission	12	Worst Case											v	v	v	
	41	Worst Case											v	v	v	
Remark	1. The mark "v" means that this configuration is chosen for testing 2. The mark "-" means that this bandwidth is not supported. 3. The device is investigated from 30MHz to 10 times of fundamental signal for radiated spurious emission test under different RB size/offset and modulations in exploratory test. Subsequently, only the worst case emissions are reported.															

2.2 Connection Diagram of Test System

<EUT With Accessory>

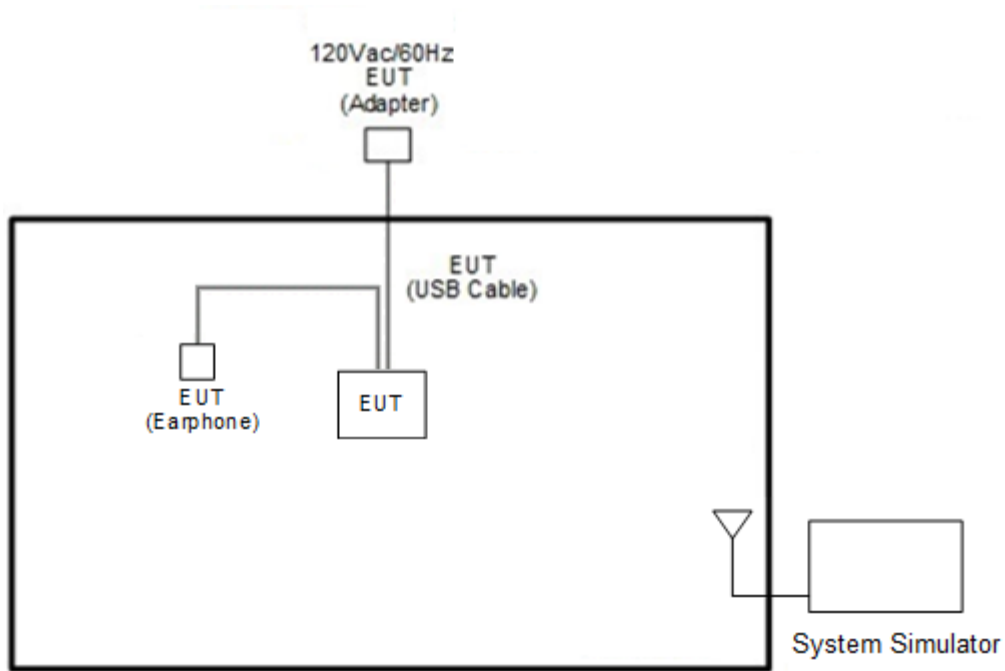

2.3 Support Unit used in test configuration and system

Item	Equipment	Brand Name	Model No.	FCC ID	Data Cable	Power Cord
1.	System Simulator	Anritsu	MT8820C	N/A	N/A	Unshielded, 1.8 m

2.4 Measurement Results Explanation Example

For all conducted test items:

The offset level is set in the spectrum analyzer to compensate the RF cable loss between EUT conducted output port and spectrum analyzer. With the offset compensation, the spectrum analyzer reading level is exactly the EUT RF output level.

The spectrum analyzer offset is derived from RF cable loss.

Offset = RF cable loss.

Following shows an offset computation example with cable loss 4.6 dB.

Example :

$$\begin{aligned} \text{Offset(dB)} &= \text{RF cable loss(dB)}. \\ &= 4.6 \text{ (dB)} \end{aligned}$$



2.5 Frequency List of Low/Middle/High Channels

LTE Band 12 Channel and Frequency List				
BW [MHz]	Channel/Frequency(MHz)	Lowest	Middle	Highest
10	Channel	23060	23095	23130
	Frequency	704	707.5	711
5	Channel	23035	23095	23155
	Frequency	701.5	707.5	713.5
3	Channel	23025	23095	23165
	Frequency	700.5	707.5	714.5
1.4	Channel	23017	23095	23173
	Frequency	699.7	707.5	715.3

LTE Band 41 Channel and Frequency List				
BW [MHz]	Channel/Frequency(MHz)	Lowest	Middle	Highest
20	Channel	39750	40620	41490
	Frequency	2506	2593	2680
15	Channel	39725	40620	41515
	Frequency	2503.5	2593	2682.5
10	Channel	39700	40620	41540
	Frequency	2501	2593	2685
5	Channel	39675	40620	41565
	Frequency	2498.5	2593	2687.5

3 Conducted Test Items

3.1 Measuring Instruments

See list of measuring instruments of this test report.

3.1.1 Test Setup

3.1.2 Conducted Output Power

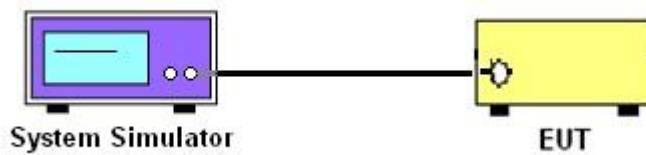

3.1.3 Peak-to-Average Ratio, Occupied Bandwidth, Conducted Band-Edge and Conducted Spurious Emission

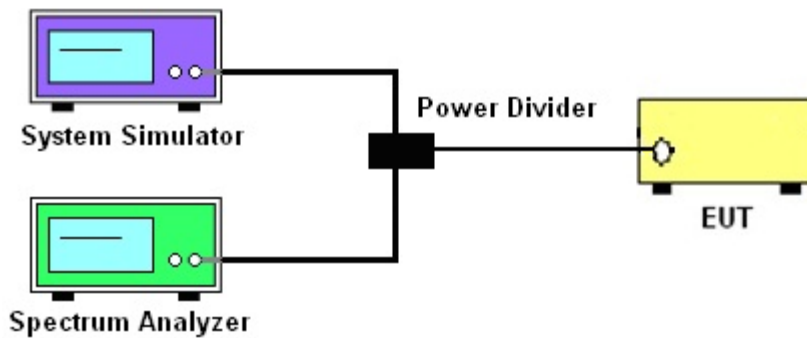

3.1.4 Frequency Stability

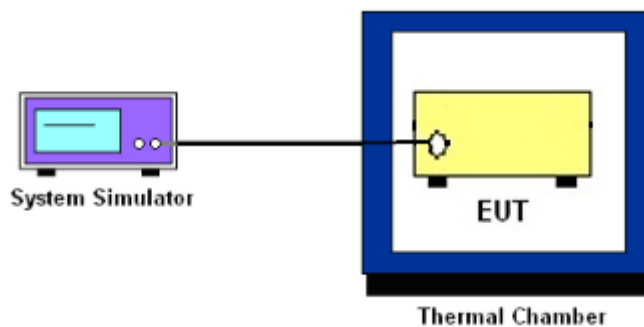

3.1.5 Test Result of Conducted Test

Please refer to Appendix A.



3.2 Conducted Output Power and ERP/EIRP

3.2.1 Description of the Conducted Output Power Measurement and ERP/EIRP Measurement

A system simulator was used to establish communication with the EUT. Its parameters were set to force the EUT transmitting at maximum output power. The measured power in the radio frequency on the transmitter output terminals shall be reported.

The ERP of mobile transmitters must not exceed 3 Watts for LTE Band 12.

The EIRP of mobile transmitters must not exceed 2 Watts for Band 41.

According to KDB 412172 D01 Power Approach,

$EIRP = P_T + G_T - L_C$, $ERP = EIRP - 2.15$, where

P_T = transmitter output power in dBm

G_T = gain of the transmitting antenna in dBi

L_C = signal attenuation in the connecting cable between the transmitter and antenna in dB

3.2.2 Test Procedures

1. The transmitter output port was connected to the system simulator.
2. Set EUT at maximum power through the system simulator.
3. Select lowest, middle, and highest channels for each band and different modulation.
4. Measure and record the power level from the system simulator.



3.3 Peak-to-Average Ratio

3.3.1 Description of the PAR Measurement

Power Complementary Cumulative Distribution Function (CCDF) curves provide a means for characterizing the power peaks of a digitally modulated signal on a statistical basis. A CCDF curve depicts the probability of the peak signal amplitude exceeding the average power level. Most contemporary measurement instrumentation include the capability to produce CCDF curves for an input signal provided that the instrument's resolution bandwidth can be set wide enough to accommodate the entire input signal bandwidth. In measuring transmissions in this band using an average power technique, the peak-to-average ratio (PAR) of the transmission may not exceed 13 dB.

3.3.2 Test Procedures

The testing follows ANSI C63.26-2015 Section 5.2.6

1. The EUT was connected to spectrum and system simulator via a power divider.
2. Set the CCDF (Complementary Cumulative Distribution Function) option in spectrum analyzer.
3. The highest RF powers were measured and recorded the maximum PAPR level associated with a probability of 0.1 %.
4. Record the deviation as Peak to Average Ratio.



3.4 Occupied Bandwidth

3.4.1 Description of Occupied Bandwidth Measurement

The occupied bandwidth is the width of a frequency band such that, below the lower and above the upper frequency limits, the mean powers emitted are each equal to a specified percentage 0.5% of the total mean transmitted power.

The 26 dB emission bandwidth is defined as the frequency range between two points, one above and one below the carrier frequency, at which the spectral density of the emission is attenuated 26 dB below the maximum in-band spectral density of the modulated signal.

3.4.2 Test Procedures

The testing follows ANSI C63.26-2015 Section 5.4.3 (26dB) and Section 5.4.4 (99OB)

1. The EUT was connected to spectrum analyzer and system simulator via a power divider.
2. The spectrum analyzer center frequency is set to the nominal EUT channel center frequency. The span range for the spectrum analyzer shall be between two and five times the anticipated OBW.
3. The nominal resolution bandwidth (RBW) shall be in the range of 1 to 5 % of the anticipated OBW, and the VBW shall be at least 3 times the RBW.
4. Set the detection mode to peak, and the trace mode to max hold.
5. Determine the reference value: Set the EUT to transmit a modulated signal. Allow the trace to stabilize. Set the spectrum analyzer marker to the highest level of the displayed trace.
(this is the reference value)
6. Determine the “-26 dB down amplitude” as equal to (Reference Value – X).
7. Place two markers, one at the lowest and the other at the highest frequency of the envelope of the spectral display such that each marker is at or slightly below the “-X dB down amplitude” determined in step 6. If a marker is below this “-X dB down amplitude” value it shall be placed as close as possible to this value. The OBW is the positive frequency difference between the two markers.
8. Use the 99 % power bandwidth function of the spectrum analyzer and report the measured bandwidth.



3.5 Conducted Band Edge

3.5.1 Description of Conducted Band Edge Measurement

27.53 (g)

For operations in the 600MHz band and 698 -746 MHz band, the FCC limit is $43 + 10\log_{10}(P[\text{Watts}])$ dB below the transmitter power $P(\text{Watts})$ in a 100 kHz bandwidth. However, in the 100 kilohertz bands immediately outside and adjacent to a licensee's frequency block, a resolution bandwidth of at least 30 kHz may be employed.

27.53(m)(4)

For mobile digital stations, the attenuation factor shall be not less than $40 + 10 \log (P)$ dB on all frequencies between the channel edge and 5 megahertz from the channel edge, $43 + 10 \log (P)$ dB on all frequencies between 5 megahertz and X megahertz from the channel edge, and $55 + 10 \log (P)$ dB on all frequencies more than X megahertz from the channel edge, where X is the greater of 6 megahertz or the actual emission bandwidth as defined in paragraph (m)(6) of this section. In addition, the attenuation factor shall not be less that $43 + 10 \log (P)$ dB on all frequencies between 2490.5 MHz and 2496 MHz and $55 + 10 \log (P)$ dB at or below 2490.5 MHz. Mobile Satellite Service licensees operating on frequencies below 2495 MHz may also submit a documented interference complaint against BRS licensees operating on channel BRS Channel 1 on the same terms and conditions as adjacent channel BRS or EBS licensees.

3.5.2 Test Procedures

1. The testing follows FCC KDB 971168 D01 v03r01 Section 6.1.
2. The EUT was connected to spectrum analyzer and system simulator via a power divider.
3. The band edges of low and high channels for the highest RF powers were measured.
4. Set RBW \geq 1% EBW in the 1MHz band immediately outside and adjacent to the band edge.
5. Beyond the 1 MHz band from the band edge, RBW=1MHz was used.
6. Set spectrum analyzer with RMS detector.
7. The RF fundamental frequency should be excluded against the limit line in the operating frequency band.
8. Checked that all the results comply with the emission limit line.
The limit line is derived from $43 + 10\log(P)$ dB below the transmitter power $P(\text{Watts})$
9. For LTE Band 41, the other 40 dB, and 55 dB have additionally applied same calculation above.



3.6 Conducted Spurious Emission

3.6.1 Description of Conducted Spurious Emission Measurement

The power of any emission outside of the authorized operating frequency ranges must be lower than the transmitter power (P) by a factor of at least $43 + 10 \log (P)$ dB.

For LTE Band 41

The power of any emission outside of the authorized operating frequency ranges must be lower than the transmitter power (P) by a factor of at least $55 + 10 \log (P)$ dB.

It is measured by means of a calibrated spectrum analyzer and scanned from 30 MHz up to a frequency including its 10th harmonic.

3.6.2 Test Procedures

1. The testing follows FCC KDB 971168 D01 v03r01 Section 6.1.
2. The EUT was connected to spectrum analyzer and system simulator via a power divider.
3. The RF output of EUT was connected to the spectrum analyzer by RF cable and attenuator. The path loss was compensated to the results for each measurement.
4. The middle channel for the highest RF power within the transmitting frequency was measured.
5. The conducted spurious emission for the whole frequency range was taken.
6. Make the measurement with the spectrum analyzer's RBW = 1MHz, VBW = 3MHz.
7. Set spectrum analyzer with RMS detector.
8. Taking the record of maximum spurious emission.
9. The RF fundamental frequency should be excluded against the limit line in the operating frequency band.
10. The limit line is derived from $43 + 10\log(P)$ dB below the transmitter power P(Watts)
11. For Band 41
The limit line is derived from $55 + 10\log(P)$ dB below the transmitter power P(Watts)



3.7 Frequency Stability

3.7.1 Description of Frequency Stability Measurement

27.54

The frequency stability shall be sufficient to ensure that the fundamental emission stays within the authorized frequency block.

3.7.2 Test Procedures for Temperature Variation

The testing follows FCC KDB 971168 D01 v03r01 Section 9.0.

1. The EUT was set up in the thermal chamber and connected with the system simulator.
2. With power OFF, the temperature was decreased to -30°C and the EUT was stabilized before testing. Power was applied and the maximum change in frequency was recorded within one minute.
3. With power OFF, the temperature was raised in 10°C step up to 50°C. The EUT was stabilized at each step for at least half an hour. Power was applied and the maximum frequency change was recorded within one minute.

3.7.3 Test Procedures for Voltage Variation

The testing follows FCC KDB 971168 D01 v03r01 Section 9.0.

1. The EUT was placed in a temperature chamber at 20±5° C and connected with the system simulator.
2. The power supply voltage to the EUT was varied from 85% to 115% of the nominal value measured at the input to the EUT.
3. The variation in frequency was measured for the worst case.

4 Radiated Test Items

4.1 Measuring Instruments

See list of measuring instruments of this test report.

4.1.1 Test Setup

For radiated test below 30MHz

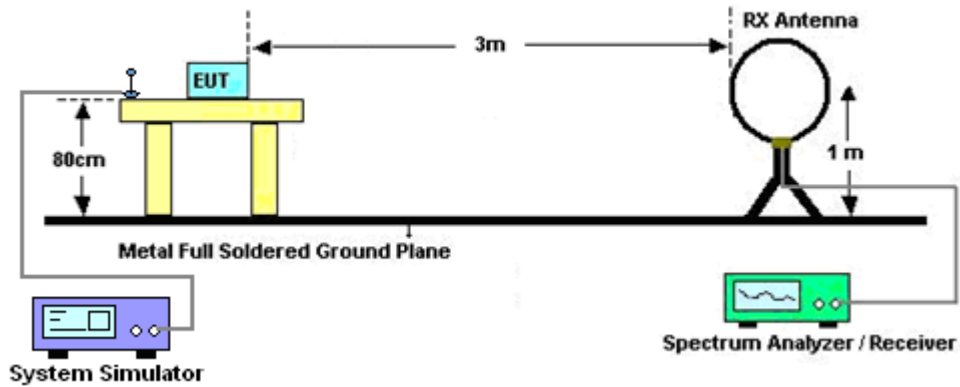

For radiated test from 30MHz to 1GHz

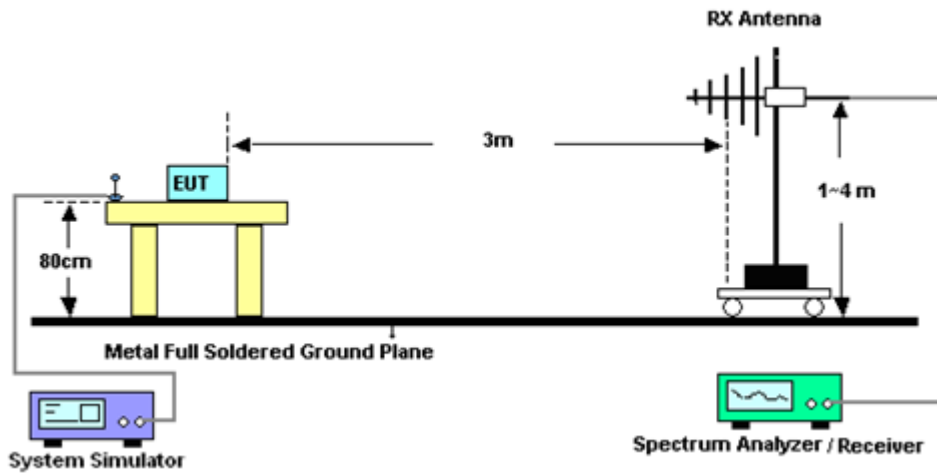

For radiated test above 1GHz

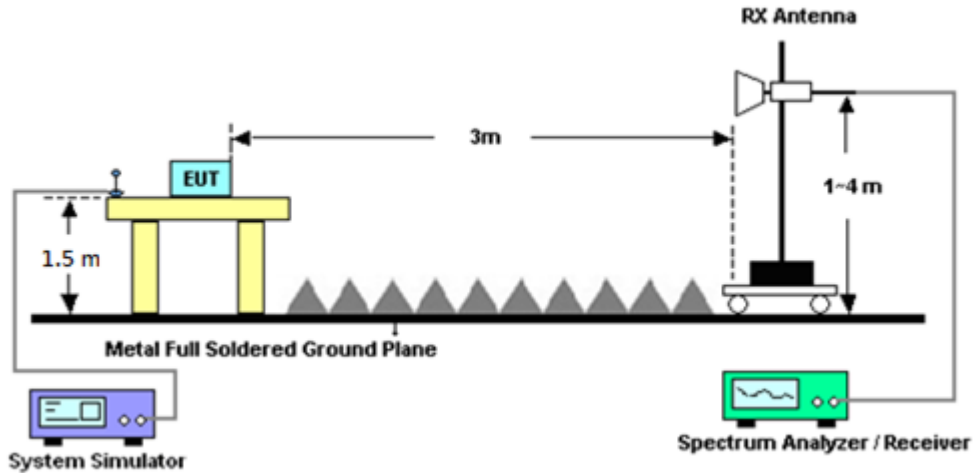

4.1.2 Test Result of Radiated Test

Please refer to Appendix B.

Note:

The low frequency, which started from 9 kHz to 30MHz, was pre-scanned and the result which was 20dB lower than the limit line was not reported.

There is adequate comparison measurement of both open-field test site and alternative test site - semi-Anechoic chamber according to 414788 D01 Radiated Test Site v01r01, and the result came out very similar.



4.2 Radiated Spurious Emission Measurement

4.2.1 Description of Radiated Spurious Emission Measurement

The radiated spurious emission was measured by substitution method according to ANSI / TIA-603-E. The power of any emission outside of the authorized operating frequency ranges must be attenuated below the transmitter power (P) by a factor of at least $43 + 10 \log (P)$ dB.

For Band 41

The power of any emission outside of the authorized operating frequency ranges must be attenuated below the transmitter power (P) by a factor of at least $55 + 10 \log (P)$ dB.

The spectrum is scanned from 30 MHz up to a frequency including its 10th harmonic.

4.2.2 Test Procedures

1. The testing follows FCC KDB 971168 D01 v03r01 Section 7 and ANSI / TIA-603-E Section 2.2.12.
2. The EUT was placed on a turntable with 0.8 meter for frequency below 1GHz and 1.5 meter for frequency above 1GHz respectively above ground.
3. The EUT was set 3 meters from the receiving antenna, which was mounted on the antenna tower.
4. The table was rotated 360 degrees to determine the position of the highest spurious emission.
5. The height of the receiving antenna is varied between one meter and four meters to search the maximum spurious emission for both horizontal and vertical polarizations.
6. Make the measurement with the spectrum analyzer's RBW = 1MHz, VBW = 3MHz, taking the record of maximum spurious emission.
7. A horn antenna was substituted in place of the EUT and was driven by a signal generator.
8. Tune the output power of signal generator to the same emission level with EUT maximum spurious emission.
9. Taking the record of output power at antenna port.
10. Repeat step 7 to step 8 for another polarization.
11. The RF fundamental frequency should be excluded against the limit line in the operating frequency band.

The limit line is derived from $43 + 10\log(P)$ dB below the transmitter power P(Watts)

$EIRP \text{ (dBm)} = S.G. \text{ Power} - Tx \text{ Cable Loss} + Tx \text{ Antenna Gain}$

$ERP \text{ (dBm)} = EIRP - 2.15$

12. For Band 41:

The limit line is derived from $55 + 10\log(P)$ dB below the transmitter power P(Watts)



5 List of Measuring Equipment

Instrument	Manufacturer	Model No.	Serial No.	Characteristics	Calibration Date	Test Date	Due Date	Remark
Spectrum Analyzer	R&S	FSV40	101040	10Hz~40GHz	Oct. 14, 2021	Dec. 17, 2021~ Dec. 28, 2021	Oct. 13, 2022	Conducted (TH01-KS)
Power divider	STI	STI08-0055	-	0.5~40GHz	Aug. 26, 2021	Dec. 17, 2021~ Dec. 28, 2021	Aug. 25, 2022	Conducted (TH01-KS)
Temperature & humidity chamber	Hongzhan	LP-150U	H2014011440	-40~+150°C 20%~95%RH	Jul. 12, 2021	Dec. 17, 2021~ Dec. 28, 2021	Jul. 11, 2022	Conducted (TH01-KS)
EXA Spectrum Analyzer	Keysight	N9010A	MY55150244	10Hz-44G,MAX 30dB	Apr. 13, 2021	Jan. 04, 2022	Apr. 12, 2022	Radiation (03CH04-KS)
Loop Antenna	R&S	HFH2-Z2	100321	9kHz~30MHz	Oct. 31, 2021	Jan. 04, 2022	Oct. 30, 2022	Radiation (03CH04-KS)
Bilog Antenna	TeseQ	CBL6111D	49922	30MHz-1GHz	May 30, 2021	Jan. 04, 2022	May 29, 2022	Radiation (03CH04-KS)
Horn Antenna	Schwarzbeck	BBHA9120D	1356	1GHz~18GHz	Apr. 18, 2021	Jan. 04, 2022	Apr. 17, 2022	Radiation (03CH04-KS)
SHF-EHF Horn	Com-power	AH-840	101070	18GHz~40GHz	Jan. 06, 2021	Jan. 04, 2022	Jan. 05, 2022	Radiation (03CH04-KS)
Amplifier	SONOMA	310N	187289	9KHz-1GHz	Jan. 06, 2021	Jan. 04, 2022	Jan. 05, 2022	Radiation (03CH04-KS)
Amplifier	MITEQ	EM18G40G GA	060728	18~40GHz	Jan. 07, 2021	Jan. 04, 2022	Jan. 06, 2022	Radiation (03CH04-KS)
high gain Amplifier	MITEQ	AMF-7D-00 101800-30-1 0P	2025788	1Ghz-18Ghz	Jan. 06, 2021	Jan. 04, 2022	Jan.05, 2022	Radiation (03CH04-KS)
Amplifier	Keysight	83017A	MY57280106	500MHz~26.5GHz	Oct. 13, 2021	Jan. 04, 2022	Oct. 12, 2022	Radiation (03CH04-KS)
AC Power Source	Chroma	61601	F104090004	N/A	NCR	Jan. 04, 2022	NCR	Radiation (03CH04-KS)
Turn Table	ChamPro	EM 1000-T	060762-T	0~360 degree	NCR	Jan. 04, 2022	NCR	Radiation (03CH04-KS)
Antenna Mast	ChamPro	EM 1000-A	060762-A	1 m~4 m	NCR	Jan. 04, 2022	NCR	Radiation (03CH04-KS)

NCR: No Calibration Required



6 Uncertainty of Evaluation

Uncertainty of Radiated Emission Measurement (30 MHz ~ 1000 MHz)

Measuring Uncertainty for a Level of Confidence of 95% ($U = 2Uc(y)$)	3.3dB
---	-------

Uncertainty of Radiated Emission Measurement (1 GHz ~ 40 GHz)

Measuring Uncertainty for a Level of Confidence of 95% ($U = 2Uc(y)$)	2.8dB
---	-------



Appendix A. Test Results of Conducted Test

Conducted Output Power(Average power) and ERP/EIRP

LTE Band 12:

BW [MHz]	Modulation	RB Size	RB Offset	Power Low	Power Middle	Power High	ERP (W)		
				Ch. / Freq.	Ch. / Freq.	Ch. / Freq.	L	M	H
Channel				23060	23095	23130	ERP (W)		
Frequency (MHz)				704	707.5	711	L	M	H
10	QPSK	1	0	23.26	23.33	23.30	0.0853	0.0867	0.0861
10	QPSK	1	25	23.29	23.24	23.32	0.0859	0.0849	0.0865
10	QPSK	1	49	23.10	23.13	23.12	0.0822	0.0828	0.0826
10	QPSK	25	0	22.32	22.43	22.39	0.0687	0.0705	0.0698
10	QPSK	25	12	22.39	22.30	22.24	0.0698	0.0684	0.0675
10	QPSK	25	25	22.31	22.39	22.28	0.0685	0.0698	0.0681
10	QPSK	50	0	22.28	22.37	22.33	0.0681	0.0695	0.0689
10	16QAM	1	0	22.41	22.44	22.50	0.0701	0.0706	0.0716
10	16QAM	1	25	22.56	22.48	22.54	0.0726	0.0713	0.0723
10	16QAM	1	49	22.30	22.37	22.37	0.0684	0.0695	0.0695
10	16QAM	25	0	21.31	21.35	21.39	0.0545	0.0550	0.0555
10	16QAM	25	12	21.33	21.29	21.19	0.0547	0.0542	0.0530
10	16QAM	25	25	21.42	21.35	21.27	0.0558	0.0550	0.0540
10	16QAM	50	0	21.32	21.31	21.30	0.0546	0.0545	0.0543
10	64QAM	1	0	21.31	21.43	21.38	0.0545	0.0560	0.0553
10	64QAM	1	25	21.48	21.51	21.53	0.0566	0.0570	0.0573
10	64QAM	1	49	21.36	21.34	21.26	0.0551	0.0548	0.0538
10	64QAM	25	0	20.41	20.39	20.41	0.0443	0.0441	0.0443
10	64QAM	25	12	20.27	20.32	20.25	0.0429	0.0434	0.0427
10	64QAM	25	25	20.38	20.37	20.38	0.0440	0.0439	0.0440
10	64QAM	50	0	20.18	20.26	20.07	0.0420	0.0428	0.0409
Channel				23035	23095	23155	ERP (W)		
Frequency (MHz)				701.5	707.5	713.5	L	M	H
5	QPSK	1	0	23.27	23.17	23.22	0.0855	0.0836	0.0845
5	QPSK	1	12	23.13	23.18	23.13	0.0828	0.0838	0.0828
5	QPSK	1	24	23.30	23.22	23.18	0.0861	0.0845	0.0838
5	QPSK	12	0	22.18	22.22	22.33	0.0665	0.0671	0.0689
5	QPSK	12	7	22.21	22.21	22.20	0.0670	0.0670	0.0668
5	QPSK	12	13	22.25	22.35	22.06	0.0676	0.0692	0.0647
5	QPSK	25	0	22.08	22.11	22.17	0.0650	0.0655	0.0664
5	16QAM	1	0	22.30	22.43	22.32	0.0684	0.0705	0.0687
5	16QAM	1	12	22.53	22.46	22.39	0.0721	0.0710	0.0698
5	16QAM	1	24	22.15	22.20	22.27	0.0661	0.0668	0.0679
5	16QAM	12	0	21.13	21.34	21.38	0.0522	0.0548	0.0553



5	16QAM	12	7	21.31	21.14	21.09	0.0545	0.0524	0.0518
5	16QAM	12	13	21.42	21.33	21.14	0.0558	0.0547	0.0524
5	16QAM	25	0	21.25	21.11	21.10	0.0537	0.0520	0.0519
5	64QAM	1	0	21.13	21.44	21.26	0.0522	0.0561	0.0538
5	64QAM	1	12	21.47	21.49	21.52	0.0565	0.0568	0.0571
5	64QAM	1	24	21.30	21.23	21.15	0.0543	0.0535	0.0525
5	64QAM	12	0	20.30	20.26	20.24	0.0432	0.0428	0.0426
5	64QAM	12	7	20.22	20.26	20.12	0.0424	0.0428	0.0414
5	64QAM	12	13	20.39	20.20	20.28	0.0441	0.0422	0.0430
5	64QAM	25	0	19.62	19.59	19.63	0.0369	0.0366	0.0370
Channel				23025	23095	23165	ERP (W)		
Frequency (MHz)				700.5	707.5	714.5	L	M	H
3	QPSK	1	0	23.06	23.30	23.11	0.0815	0.0861	0.0824
3	QPSK	1	8	23.22	23.17	23.31	0.0845	0.0836	0.0863
3	QPSK	1	14	22.95	23.10	23.12	0.0794	0.0822	0.0826
3	QPSK	8	0	22.18	22.22	22.39	0.0665	0.0671	0.0698
3	QPSK	8	4	22.33	22.14	22.10	0.0689	0.0659	0.0653
3	QPSK	8	7	22.24	22.38	22.29	0.0675	0.0697	0.0682
3	QPSK	15	0	22.20	22.15	22.28	0.0668	0.0661	0.0681
3	16QAM	1	0	22.21	22.35	22.38	0.0670	0.0692	0.0697
3	16QAM	1	8	22.40	22.45	22.51	0.0700	0.0708	0.0718
3	16QAM	1	14	22.16	22.31	22.34	0.0662	0.0685	0.0690
3	16QAM	8	0	21.18	21.13	21.38	0.0528	0.0522	0.0553
3	16QAM	8	4	21.20	21.12	20.98	0.0531	0.0521	0.0505
3	16QAM	8	7	21.22	21.17	21.17	0.0533	0.0527	0.0527
3	16QAM	15	0	21.31	21.09	21.13	0.0545	0.0518	0.0522
3	64QAM	1	0	21.10	21.29	21.34	0.0519	0.0542	0.0548
3	64QAM	1	8	21.42	21.48	21.44	0.0558	0.0566	0.0561
3	64QAM	1	14	21.22	21.29	21.07	0.0533	0.0542	0.0515
3	64QAM	8	0	20.33	20.41	20.20	0.0435	0.0443	0.0422
3	64QAM	8	4	20.10	20.17	20.05	0.0412	0.0419	0.0407
3	64QAM	8	7	20.26	20.28	20.38	0.0428	0.0430	0.0440
3	64QAM	15	0	20.32	20.27	20.56	0.0434	0.0429	0.0458
Channel				23017	23095	23173	ERP (W)		
Frequency (MHz)				699.7	707.5	715.3	L	M	H
1.4	QPSK	1	0	23.15	23.18	23.15	0.0832	0.0838	0.0832
1.4	QPSK	1	3	23.27	23.12	23.17	0.0855	0.0826	0.0836
1.4	QPSK	1	5	22.94	23.12	23.06	0.0793	0.0826	0.0815
1.4	QPSK	3	0	22.88	23.14	23.08	0.0782	0.0830	0.0818
1.4	QPSK	3	1	23.09	23.12	23.24	0.0820	0.0826	0.0849
1.4	QPSK	3	3	22.92	23.01	23.02	0.0789	0.0805	0.0807
1.4	QPSK	6	0	22.23	22.28	22.17	0.0673	0.0681	0.0664
1.4	16QAM	1	0	22.30	22.08	22.17	0.0684	0.0650	0.0664
1.4	16QAM	1	3	22.25	22.25	22.09	0.0676	0.0676	0.0652
1.4	16QAM	1	5	22.07	22.18	22.31	0.0649	0.0665	0.0685



1.4	16QAM	3	0	22.42	22.25	22.33	0.0703	0.0676	0.0689
1.4	16QAM	3	1	22.42	22.27	22.47	0.0703	0.0679	0.0711
1.4	16QAM	3	3	22.09	22.25	22.31	0.0652	0.0676	0.0685
1.4	16QAM	6	0	21.26	21.36	21.20	0.0538	0.0551	0.0531
1.4	64QAM	1	0	21.23	21.11	21.21	0.0535	0.0520	0.0532
1.4	64QAM	1	3	21.33	21.16	21.24	0.0547	0.0526	0.0536
1.4	64QAM	1	5	21.23	21.22	21.15	0.0535	0.0533	0.0525
1.4	64QAM	3	0	21.18	21.24	21.38	0.0528	0.0536	0.0553
1.4	64QAM	3	1	21.41	21.47	21.50	0.0557	0.0565	0.0569
1.4	64QAM	3	3	21.27	21.34	21.04	0.0540	0.0548	0.0512
1.4	64QAM	6	0	20.40	20.18	20.25	0.0442	0.0420	0.0427

LTE Band 41:

BW [MHz]	Modulation	RB Size	RB Offset	Power Low Ch. / Freq.	Power Middle Ch. / Freq.	Power High Ch. / Freq.	EIRP (W)		
							L	M	H
Channel				39750	40620	41490			
Frequency (MHz)				2506	2593	2680			
20	QPSK	1	0	20.54	20.70	20.61	0.0899	0.0933	0.0914
20	QPSK	1	49	20.62	20.56	20.43	0.0916	0.0904	0.0877
20	QPSK	1	99	20.59	20.65	20.56	0.0910	0.0923	0.0904
20	QPSK	50	0	19.77	19.80	19.68	0.0753	0.0759	0.0738
20	QPSK	50	24	19.65	19.65	19.57	0.0733	0.0733	0.0719
20	QPSK	50	50	19.64	19.69	19.67	0.0731	0.0740	0.0736
20	QPSK	100	0	19.59	19.78	19.68	0.0723	0.0755	0.0738
20	16QAM	1	0	19.88	19.85	19.89	0.0773	0.0767	0.0774
20	16QAM	1	49	19.78	19.76	19.72	0.0755	0.0752	0.0745
20	16QAM	1	99	19.83	19.80	19.87	0.0764	0.0759	0.0771
20	16QAM	50	0	18.84	18.83	18.86	0.0608	0.0607	0.0611
20	16QAM	50	24	18.84	18.71	18.59	0.0608	0.0590	0.0574
20	16QAM	50	50	18.87	18.73	18.78	0.0612	0.0593	0.0600
20	16QAM	100	0	18.65	18.69	18.55	0.0582	0.0587	0.0569
20	64QAM	1	0	18.56	18.51	18.46	0.0570	0.0564	0.0557
20	64QAM	1	49	18.57	18.61	18.51	0.0571	0.0577	0.0564
20	64QAM	1	99	18.39	18.42	18.36	0.0548	0.0552	0.0545
20	64QAM	50	0	17.78	17.78	17.80	0.0476	0.0476	0.0479
20	64QAM	50	24	17.84	17.71	17.56	0.0483	0.0469	0.0453
20	64QAM	50	50	17.54	17.68	17.77	0.0451	0.0466	0.0475
20	64QAM	100	0	17.78	17.64	17.59	0.0476	0.0461	0.0456
Channel				39725	40620	41515	EIRP (W)		
Frequency (MHz)				2503.5	2593	2682.5	L	M	H
15	QPSK	1	0	20.46	20.67	20.55	0.0883	0.0927	0.0902
15	QPSK	1	37	20.63	20.49	20.36	0.0918	0.0889	0.0863
15	QPSK	1	74	20.46	20.46	20.45	0.0883	0.0883	0.0881



15	QPSK	36	0	19.73	19.70	19.61	0.0746	0.0741	0.0726
15	QPSK	36	20	19.50	19.46	19.52	0.0708	0.0701	0.0711
15	QPSK	36	39	19.46	19.63	19.51	0.0701	0.0729	0.0710
15	QPSK	75	0	19.41	19.69	19.63	0.0693	0.0740	0.0729
15	16QAM	1	0	19.84	19.80	19.67	0.0766	0.0759	0.0736
15	16QAM	1	37	19.67	19.77	19.64	0.0736	0.0753	0.0731
15	16QAM	1	74	19.83	19.80	19.71	0.0764	0.0759	0.0743
15	16QAM	36	0	18.70	18.79	18.78	0.0589	0.0601	0.0600
15	16QAM	36	20	18.62	18.63	18.48	0.0578	0.0579	0.0560
15	16QAM	36	39	18.76	18.66	18.57	0.0597	0.0583	0.0571
15	16QAM	75	0	18.66	18.53	18.45	0.0583	0.0566	0.0556
15	64QAM	1	0	18.42	18.53	18.47	0.0552	0.0566	0.0558
15	64QAM	1	37	18.57	18.45	18.33	0.0571	0.0556	0.0541
15	64QAM	1	74	18.22	18.40	18.18	0.0527	0.0550	0.0522
15	64QAM	36	0	17.68	17.63	17.80	0.0466	0.0460	0.0479
15	64QAM	36	20	17.65	17.50	17.49	0.0462	0.0447	0.0446
15	64QAM	36	39	17.36	17.52	17.58	0.0433	0.0449	0.0455
15	64QAM	75	0	17.58	17.60	17.59	0.0455	0.0457	0.0456
Channel				39700	40620	41540	EIRP (W)		
Frequency (MHz)				2501	2593	2685	L	M	H
10	QPSK	1	0	20.56	20.66	20.55	0.0904	0.0925	0.0902
10	QPSK	1	25	20.54	20.45	20.30	0.0899	0.0881	0.0851
10	QPSK	1	49	20.40	20.44	20.47	0.0871	0.0879	0.0885
10	QPSK	25	0	19.69	19.59	19.56	0.0740	0.0723	0.0718
10	QPSK	25	12	19.59	19.58	19.58	0.0723	0.0721	0.0721
10	QPSK	25	25	19.61	19.48	19.63	0.0726	0.0705	0.0729
10	QPSK	50	0	19.44	19.63	19.65	0.0698	0.0729	0.0733
10	16QAM	1	0	19.85	19.85	19.74	0.0767	0.0767	0.0748
10	16QAM	1	25	19.65	19.70	19.54	0.0733	0.0741	0.0714
10	16QAM	1	49	19.64	19.68	19.75	0.0731	0.0738	0.0750
10	16QAM	25	0	18.65	18.72	18.71	0.0582	0.0592	0.0590
10	16QAM	25	12	18.64	18.55	18.41	0.0581	0.0569	0.0551
10	16QAM	25	25	18.86	18.57	18.62	0.0611	0.0571	0.0578
10	16QAM	50	0	18.62	18.59	18.48	0.0578	0.0574	0.0560
10	64QAM	1	0	18.52	18.33	18.45	0.0565	0.0541	0.0556
10	64QAM	1	25	18.53	18.49	18.30	0.0566	0.0561	0.0537
10	64QAM	1	49	18.40	18.30	18.17	0.0550	0.0537	0.0521
10	64QAM	25	0	17.74	17.75	17.82	0.0472	0.0473	0.0481
10	64QAM	25	12	17.76	17.69	17.44	0.0474	0.0467	0.0441
10	64QAM	25	25	17.46	17.67	17.56	0.0443	0.0465	0.0453
10	64QAM	50	0	17.58	17.66	17.59	0.0455	0.0463	0.0456
Channel				39675	40620	41565	EIRP (W)		
Frequency (MHz)				2498.5	2593	2687.5	L	M	H
5	QPSK	1	0	20.48	20.69	20.52	0.0887	0.0931	0.0895
5	QPSK	1	12	20.52	20.39	20.26	0.0895	0.0869	0.0843



5	QPSK	1	24	20.41	20.61	20.35	0.0873	0.0914	0.0861
5	QPSK	12	0	19.67	19.73	19.53	0.0736	0.0746	0.0713
5	QPSK	12	7	19.44	19.63	19.52	0.0698	0.0729	0.0711
5	QPSK	12	13	19.44	19.59	19.63	0.0698	0.0723	0.0729
5	QPSK	25	0	19.41	19.66	19.80	0.0693	0.0735	0.0759
5	16QAM	1	0	19.88	19.80	19.68	0.0773	0.0759	0.0738
5	16QAM	1	12	19.66	19.56	19.51	0.0735	0.0718	0.0710
5	16QAM	1	24	19.72	19.76	19.82	0.0745	0.0752	0.0762
5	16QAM	12	0	18.76	18.66	18.86	0.0597	0.0583	0.0611
5	16QAM	12	7	18.64	18.61	18.49	0.0581	0.0577	0.0561
5	16QAM	12	13	18.68	18.60	18.60	0.0586	0.0575	0.0575
5	16QAM	25	0	18.49	18.63	18.56	0.0561	0.0579	0.0570
5	64QAM	1	0	18.48	18.47	18.31	0.0560	0.0558	0.0538
5	64QAM	1	12	18.39	18.57	18.42	0.0548	0.0571	0.0552
5	64QAM	1	24	18.26	18.28	18.18	0.0532	0.0535	0.0522
5	64QAM	12	0	17.65	17.78	17.67	0.0462	0.0476	0.0465
5	64QAM	12	7	17.76	17.62	17.34	0.0474	0.0459	0.0431
5	64QAM	12	13	17.49	17.53	17.68	0.0446	0.0450	0.0466
5	64QAM	25	0	17.62	17.63	17.55	0.0459	0.0460	0.0452



LTE Band 12

Peak-to-Average Ratio

Mode	LTE Band 12 / 10MHz			
Mod.	QPSK	16QAM	64QAM	Limit: 13dB
RB Size	Full RB	Full RB	Full RB	Result
Middle CH	4.55	5.51	5.51	PASS

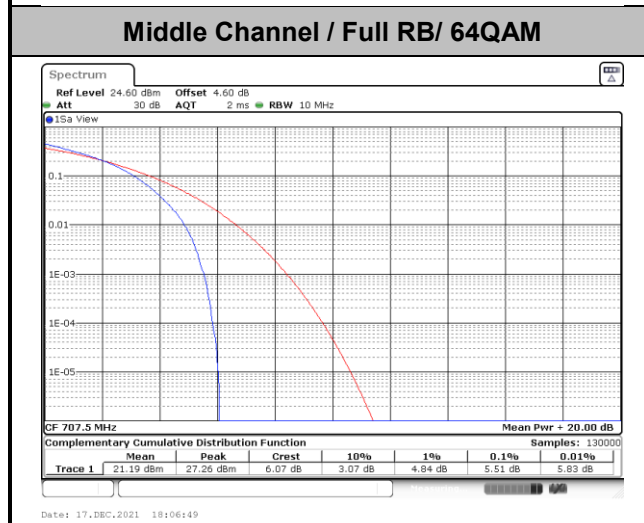
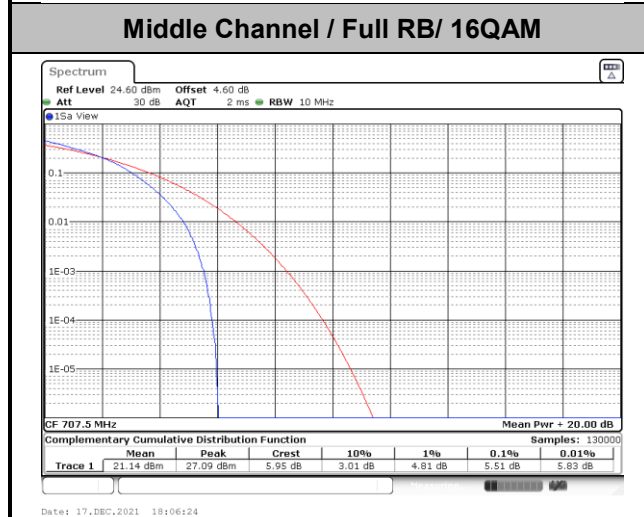
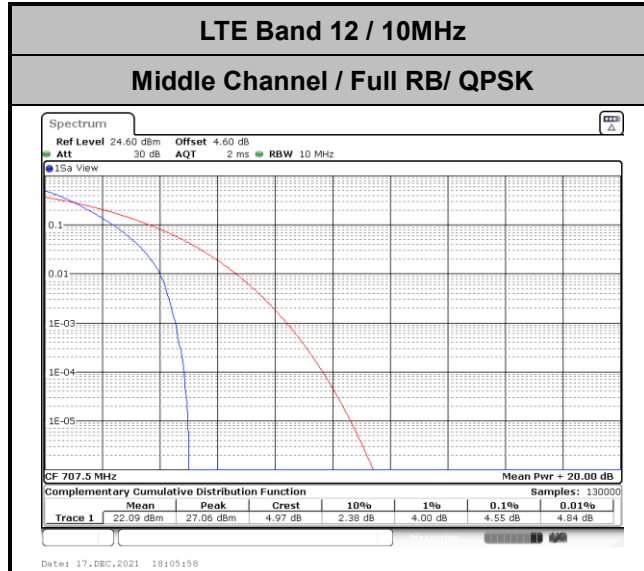



26dB Bandwidth

Mode	LTE Band 12 : 26dB BW(MHz)		
BW	1.4MHz		
Mod.	QPSK	16QAM	64QAM
Lowest CH	1.23	1.22	1.24
Middle CH	1.23	1.21	1.22
Highest CH	1.23	1.23	1.24

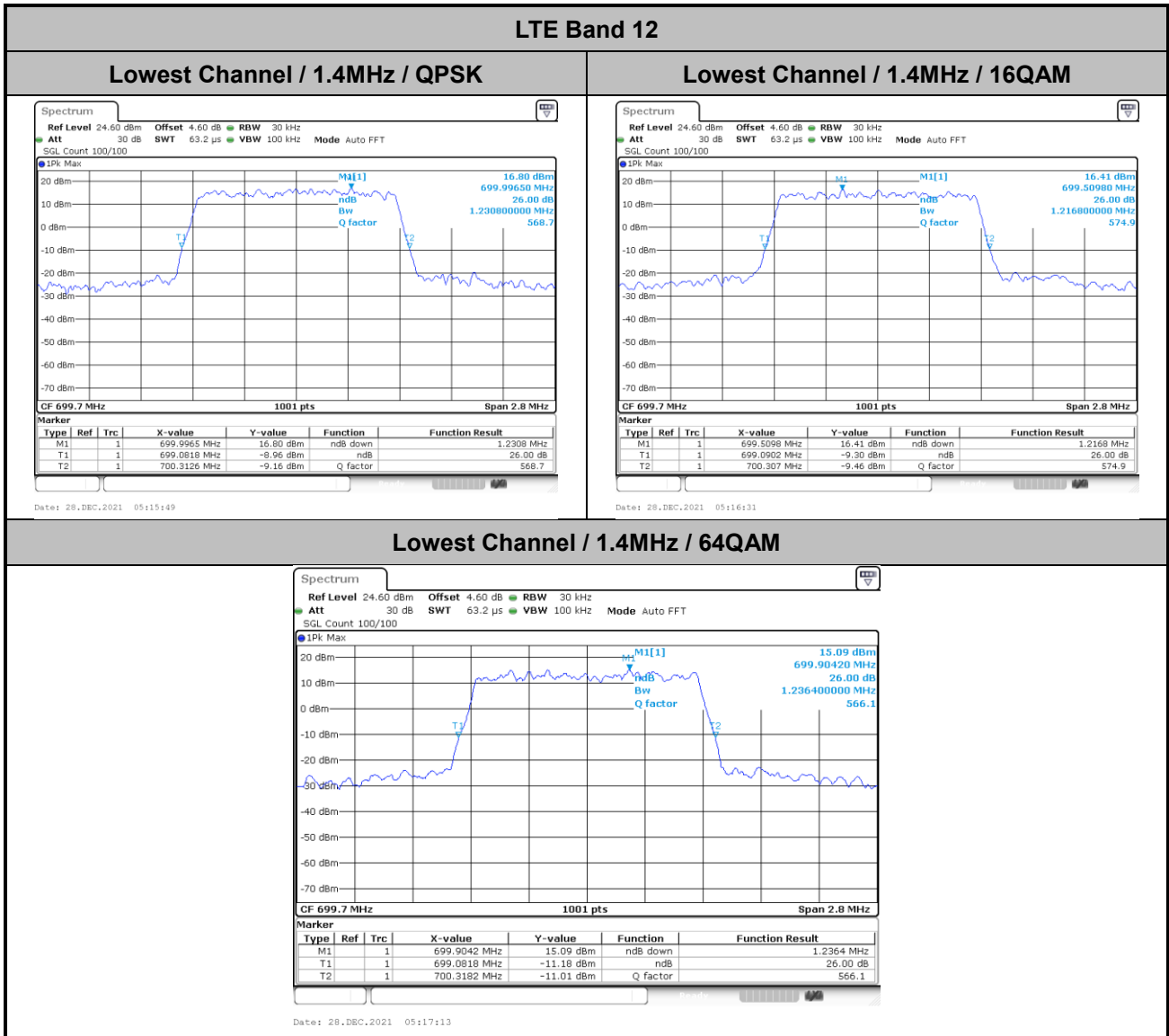



LTE Band 12

Middle Channel / 1.4MHz / QPSK

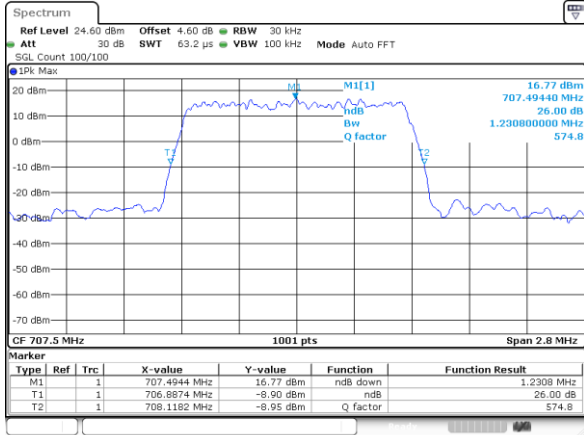

Date: 28.DEC.2021 05:17:55

Middle Channel / 1.4MHz / 16QAM

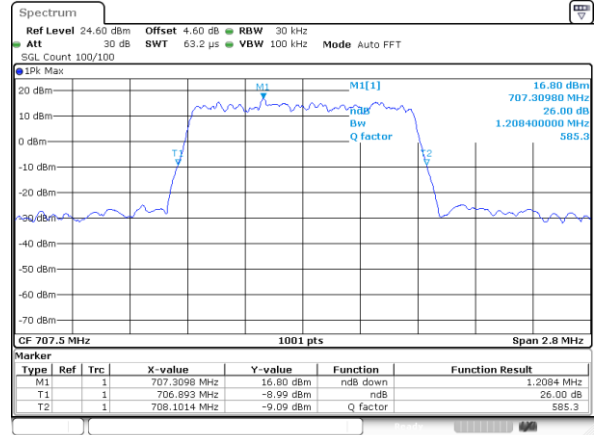

Date: 28.DEC.2021 05:18:37

Middle Channel / 1.4MHz / 64QAM

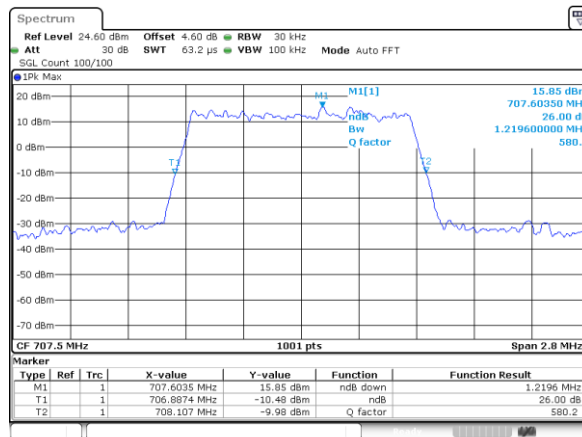

Date: 28.DEC.2021 05:19:19



LTE Band 12

Highest Channel / 1.4MHz / QPSK

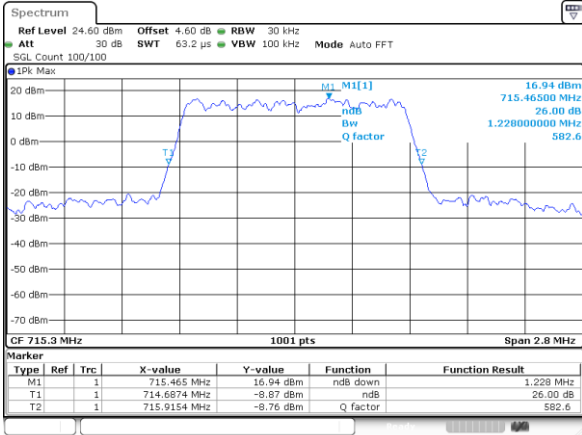

Date: 28, DEC, 2021 05:20:01

Highest Channel / 1.4MHz / 16QAM

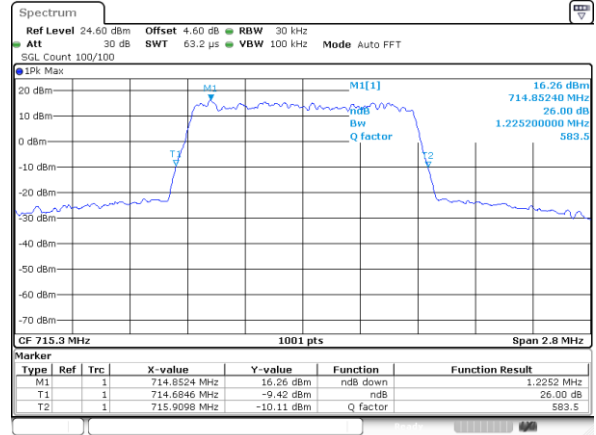

Date: 28, DEC, 2021 05:20:44

Highest Channel / 1.4MHz / 64QAM

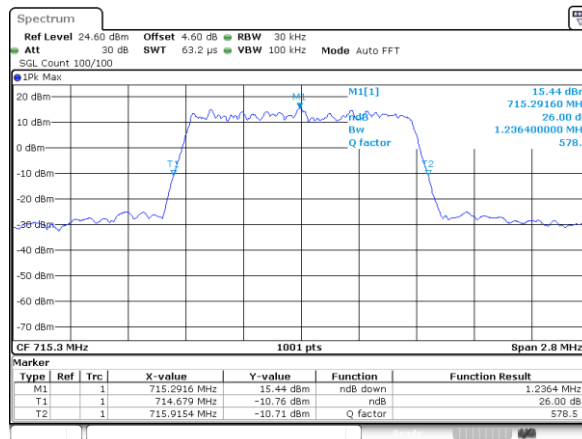

Date: 28, DEC, 2021 05:21:26



Mode	LTE Band 12 : 26dB BW(MHz)		
BW	3MHz		
Mod.	QPSK	16QAM	64QAM
Lowest CH	2.99	3.04	3.02
Middle CH	3.05	3.02	3.02
Highest CH	3.07	3.03	3.02

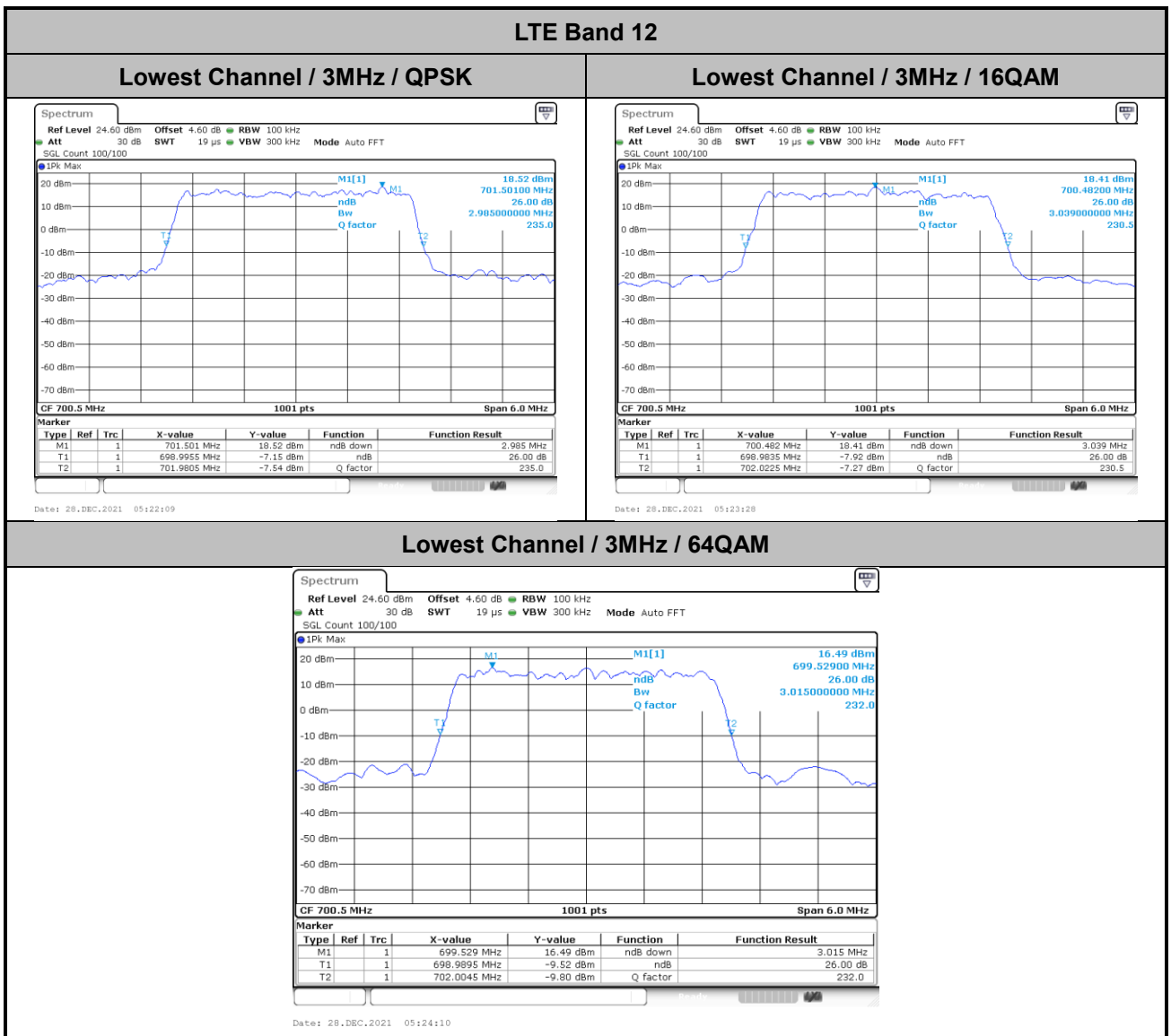



LTE Band 12

Middle Channel / 3MHz / QPSK

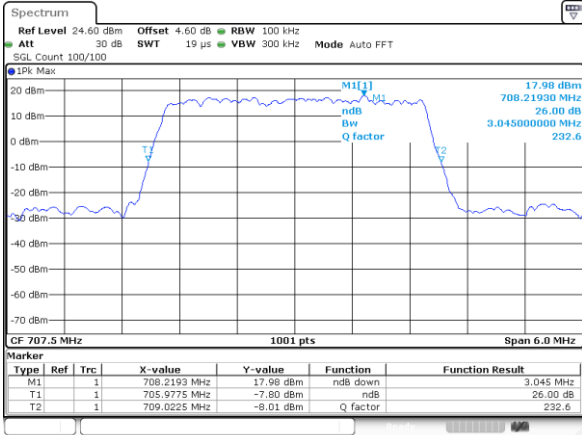

Date: 28.DEC.2021 05:24:52

Middle Channel / 3MHz / 16QAM

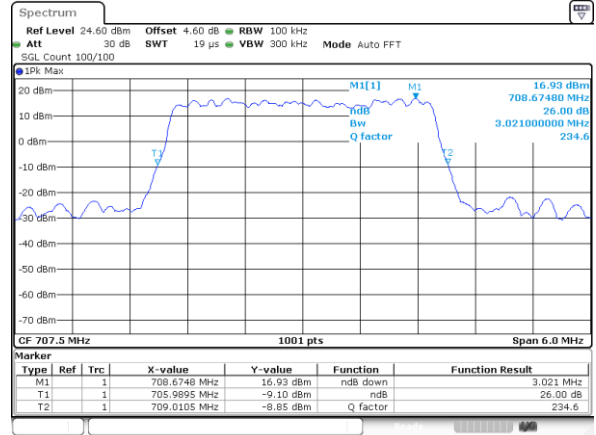

Date: 28.DEC.2021 05:25:34

Middle Channel / 3MHz / 64QAM

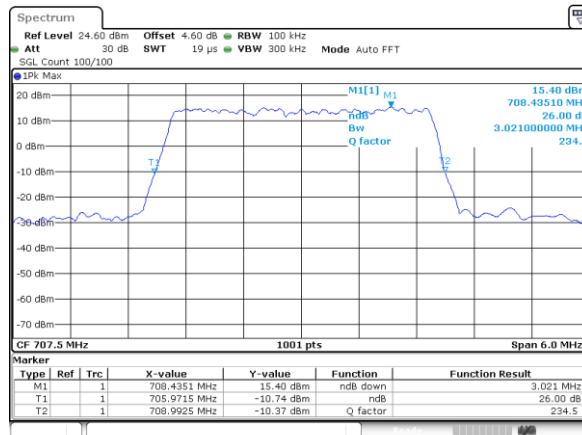

Date: 28.DEC.2021 05:26:15



LTE Band 12

Highest Channel / 3MHz / QPSK

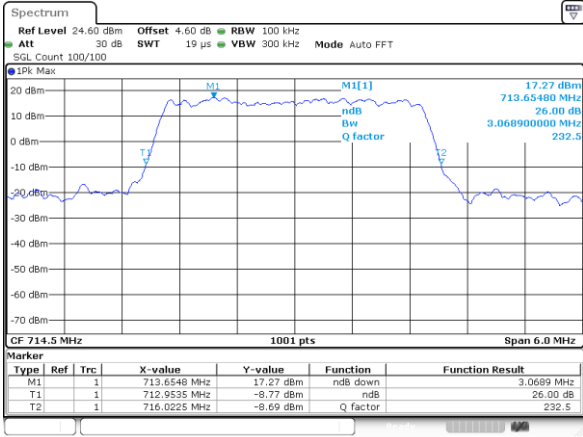

Date: 28, DEC, 2021 05:26:57

Highest Channel / 3MHz / 16QAM

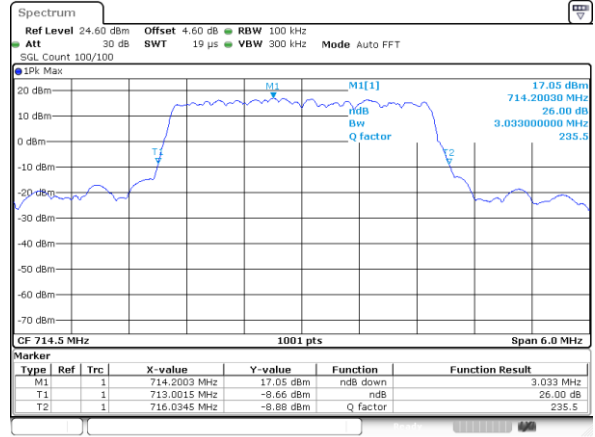

Date: 28, DEC, 2021 05:27:39

Highest Channel / 3MHz / 64QAM

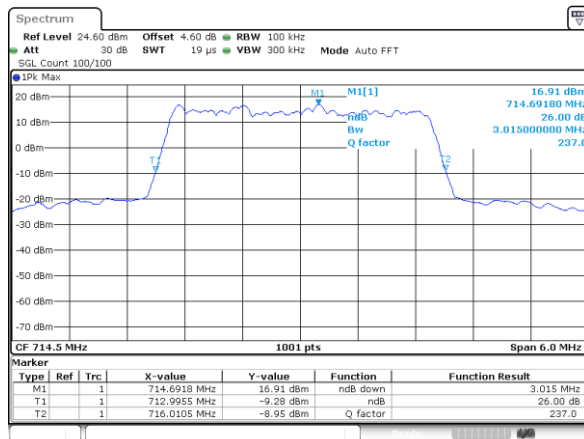

Date: 28, DEC, 2021 05:28:21



Mode	LTE Band 12 : 26dB BW(MHz)		
BW	5MHz		
Mod.	QPSK	16QAM	64QAM
Lowest CH	4.88	4.87	4.94
Middle CH	4.93	4.80	4.99
Highest CH	4.89	4.84	4.92

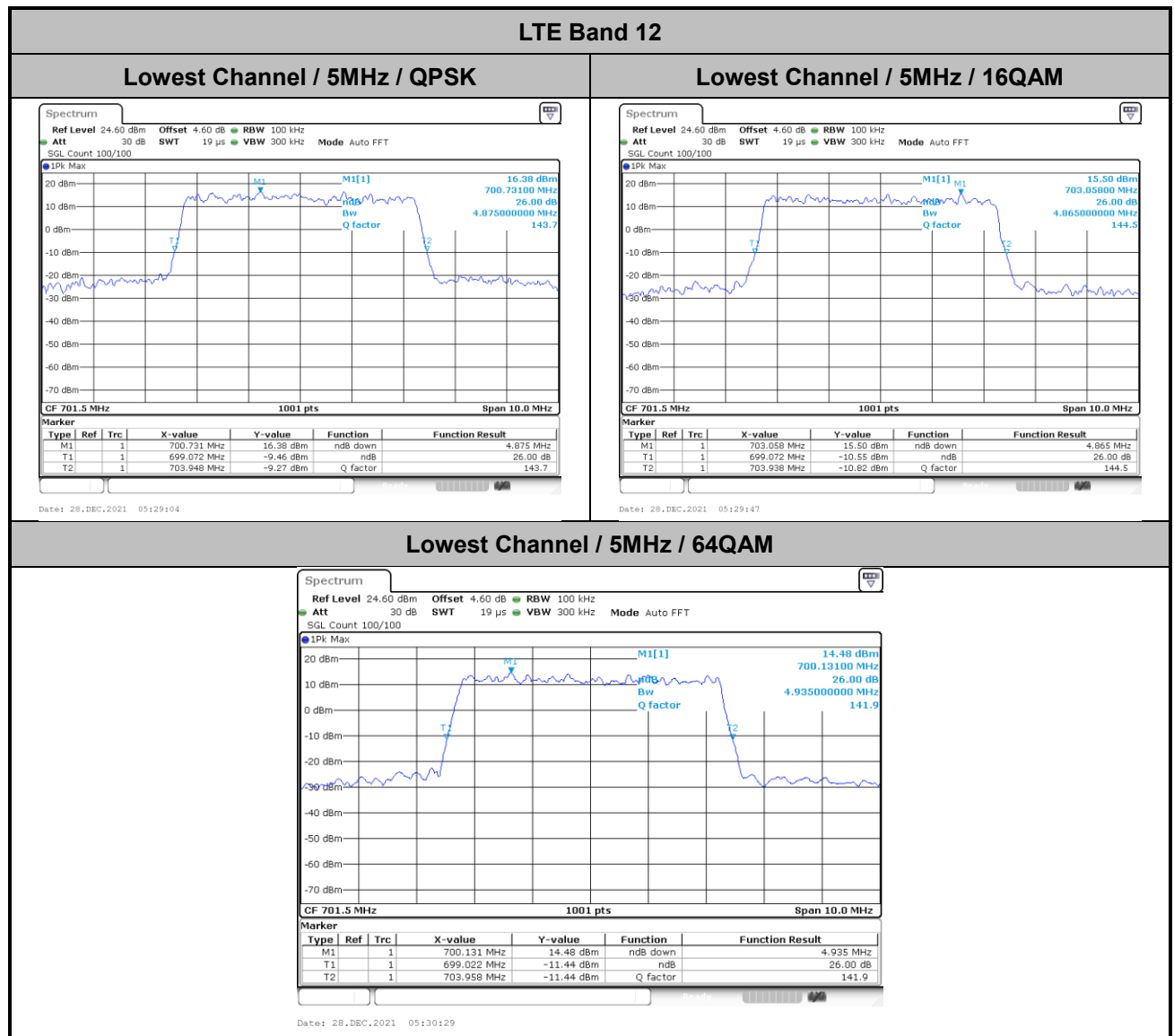



LTE Band 12

Middle Channel / 5MHz / QPSK

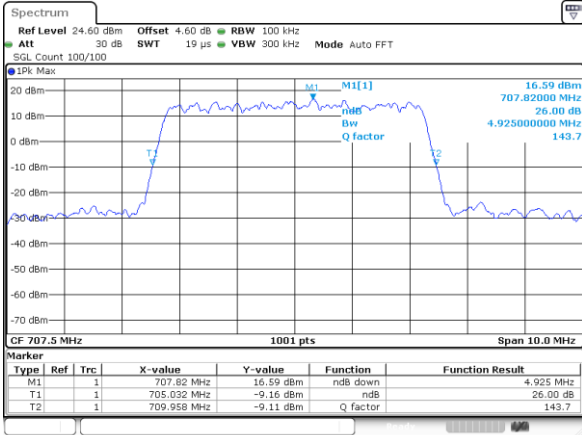

Date: 28. DEC. 2021 05:31:11

Middle Channel / 5MHz / 16QAM

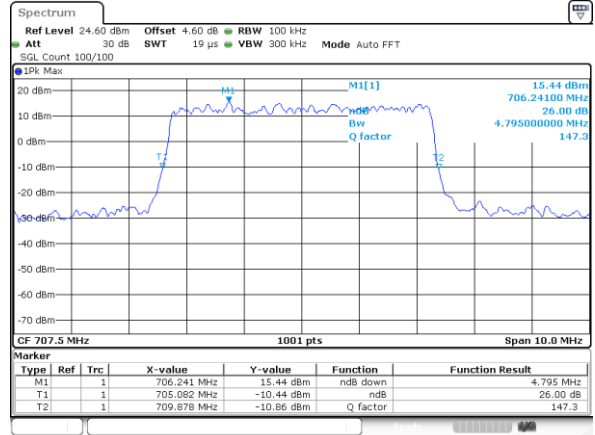

Date: 28. DEC. 2021 05:31:53

Middle Channel / 5MHz / 64QAM

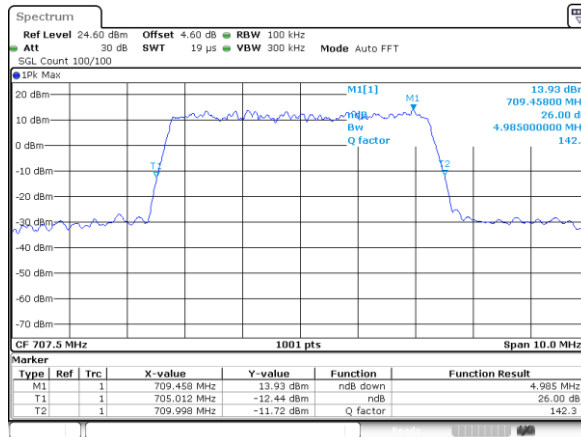

Date: 28. DEC. 2021 05:32:35



LTE Band 12

Highest Channel / 5MHz / QPSK

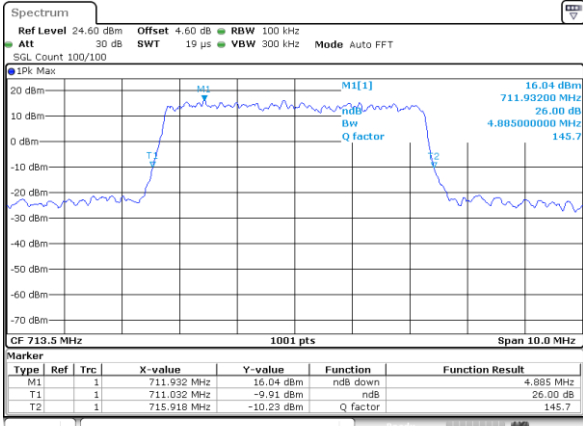

Date: 28,DEC,2021 05:33:17

Highest Channel / 5MHz / 16QAM

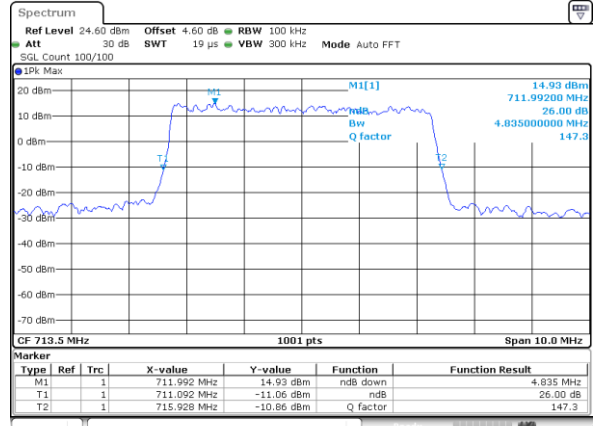

Date: 28,DEC,2021 05:34:00

Highest Channel / 5MHz / 64QAM

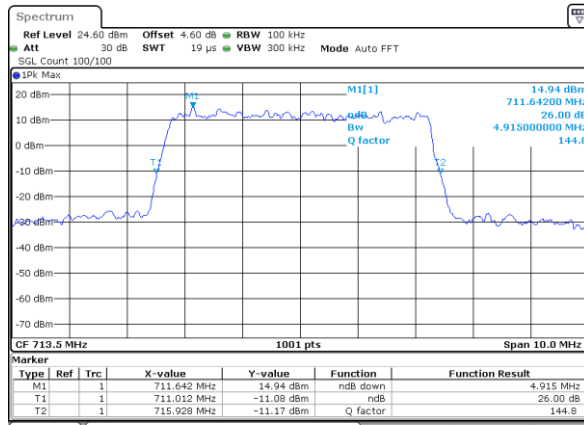

Date: 28,DEC,2021 05:34:42



Mode	LTE Band 12 : 26dB BW(MHz)		
BW	10MHz		
Mod.	QPSK	16QAM	64QAM
Lowest CH	9.73	9.77	9.71
Middle CH	9.83	9.67	9.83
Highest CH	9.63	9.81	9.89

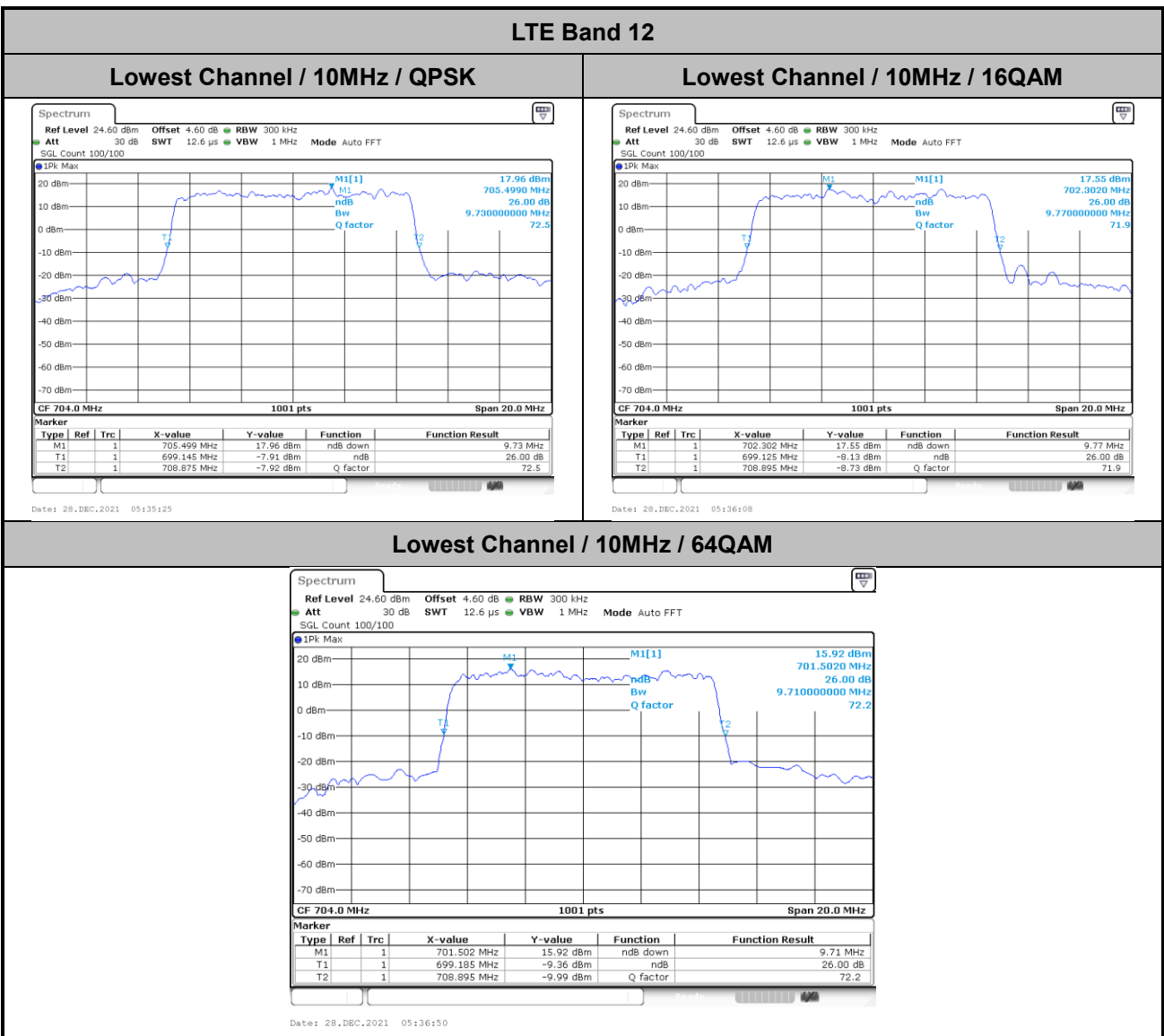



LTE Band 12

Middle Channel / 10MHz / QPSK

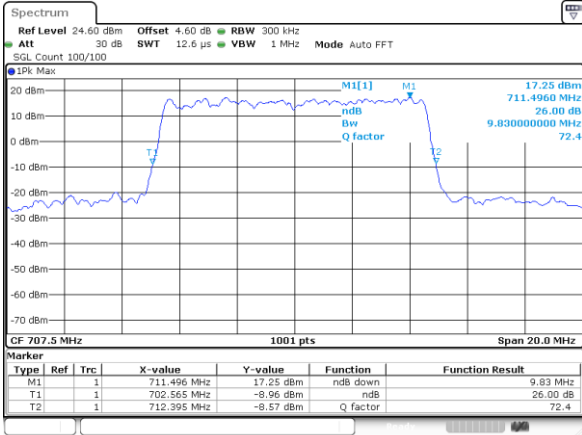

Date: 28.DEC.2021 05:37:32

Middle Channel / 10MHz / 16QAM

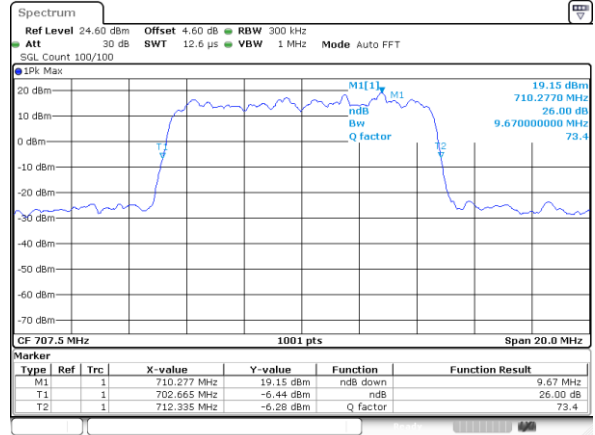

Date: 28.DEC.2021 05:38:14

Middle Channel / 10MHz / 64QAM

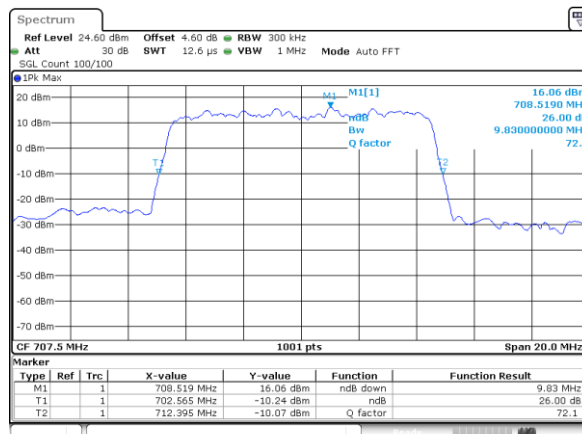

Date: 28.DEC.2021 05:38:55



LTE Band 12

Highest Channel / 10MHz / QPSK

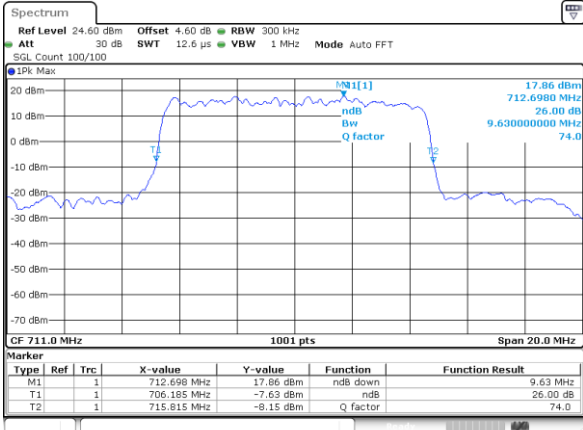

Date: 28.DEC.2021 05:39:37

Highest Channel / 10MHz / 16QAM

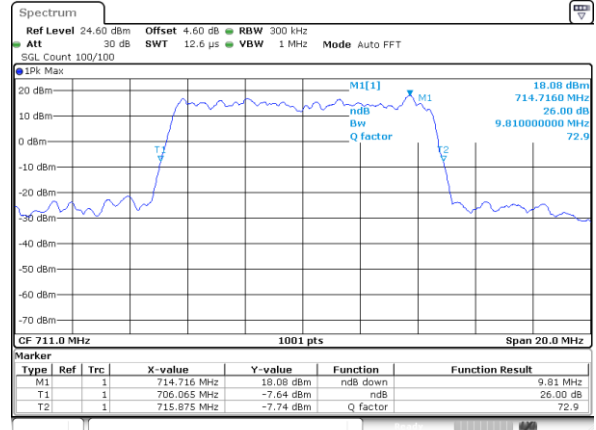

Date: 28.DEC.2021 05:40:19

Highest Channel / 10MHz / 64QAM

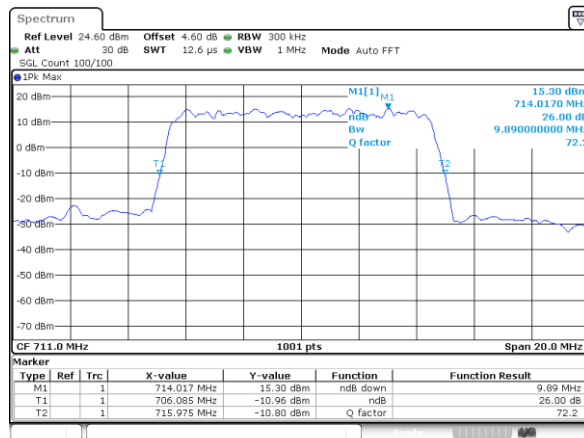

Date: 28.DEC.2021 05:41:02



Occupied Bandwidth

Mode	LTE Band 12 : 99%OBW(MHz)		
BW	1.4MHz		
Mod.	QPSK	16QAM	64QAM
Lowest CH	1.09	1.08	1.09
Middle CH	1.10	1.09	1.09
Highest CH	1.09	1.10	1.09

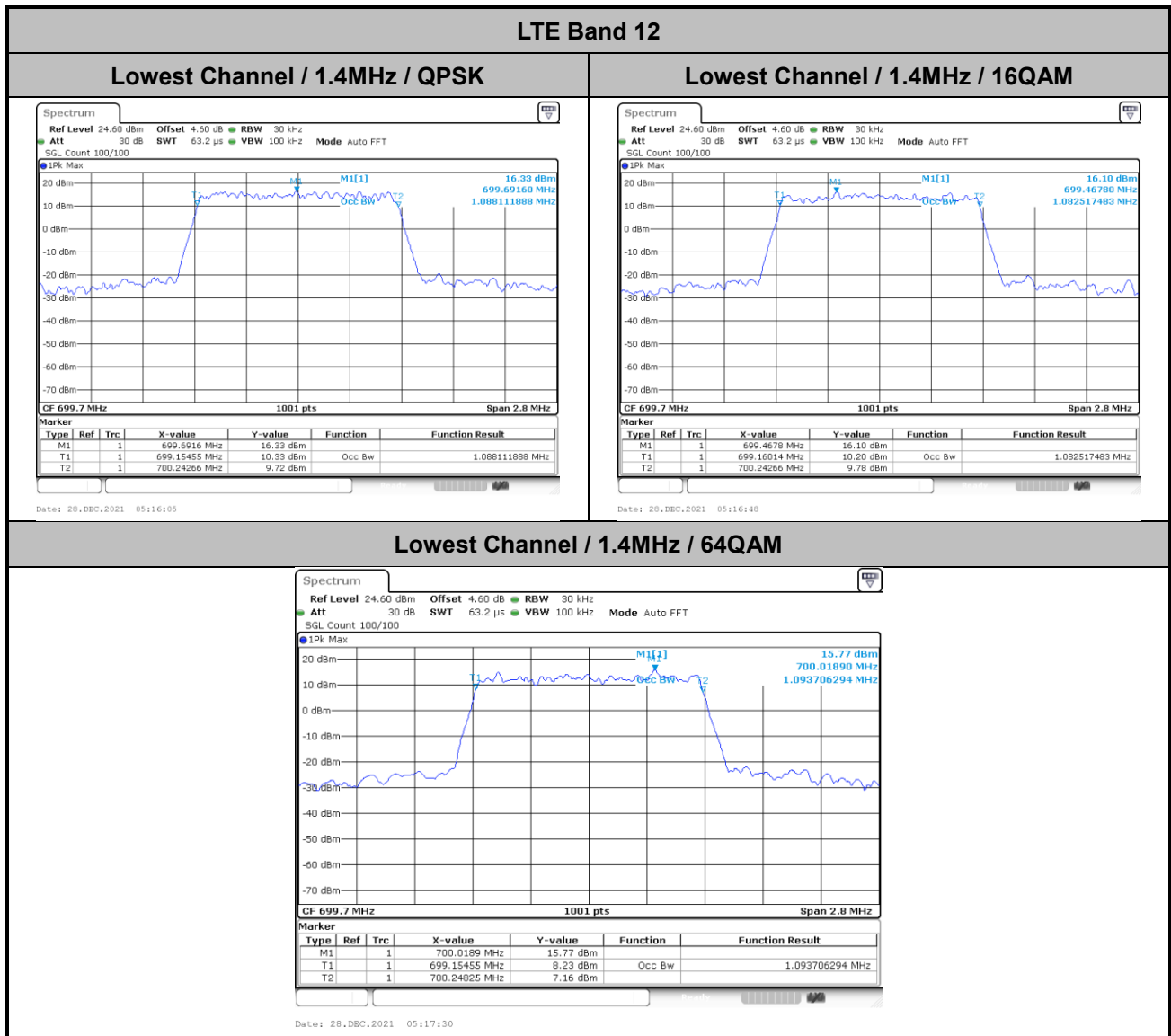



LTE Band 12

Middle Channel / 1.4MHz / QPSK

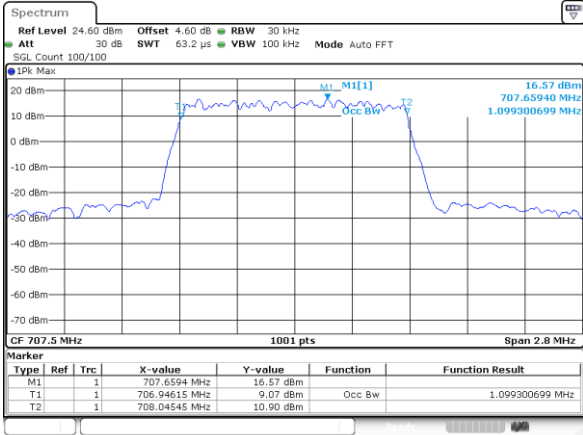

Date: 28,DEC,2021 05:18:12

Middle Channel / 1.4MHz / 16QAM

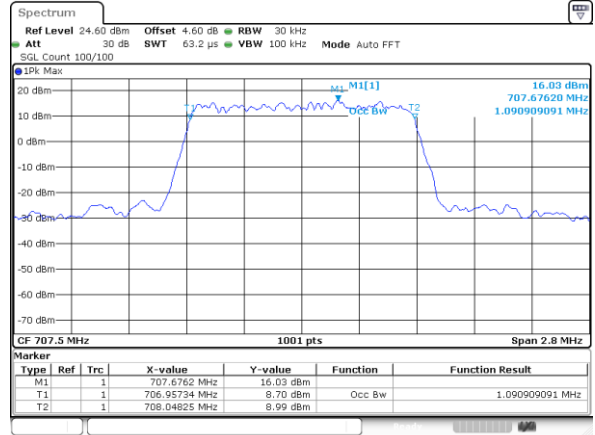

Date: 28,DEC,2021 05:18:54

Middle Channel / 1.4MHz / 64QAM

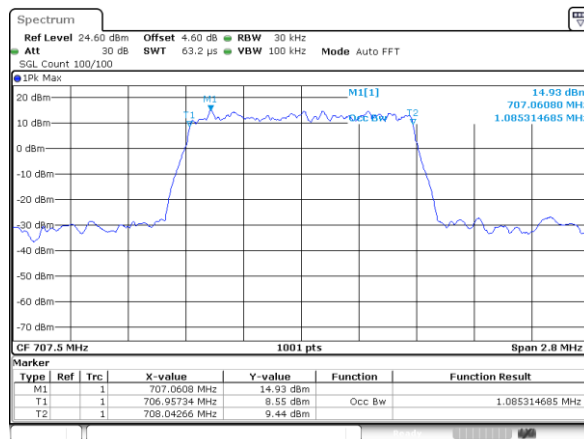

Date: 28,DEC,2021 05:19:35



LTE Band 12

Highest Channel / 1.4MHz / QPSK

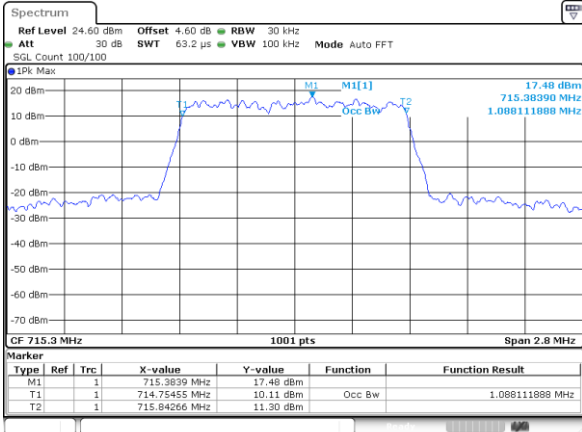

Date: 28, DEC, 2021 05:20:18

Highest Channel / 1.4MHz / 16QAM

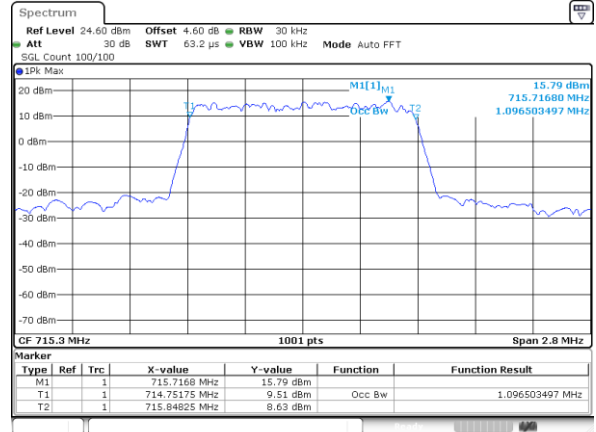

Date: 28, DEC, 2021 05:21:00

Highest Channel / 1.4MHz / 64QAM

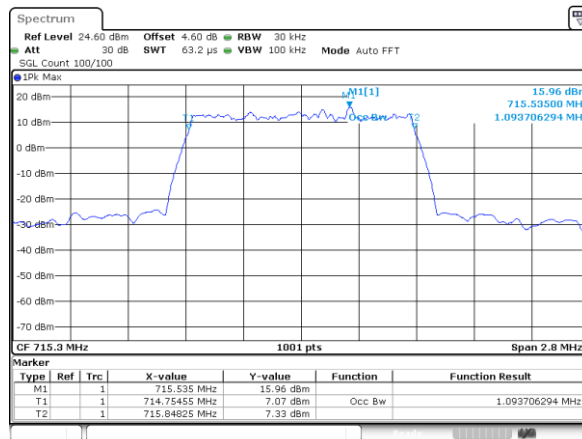

Date: 28, DEC, 2021 05:21:42



Mode	LTE Band 12 : 99%OBW(MHz)		
BW	3MHz		
Mod.	QPSK	16QAM	64QAM
Lowest CH	2.72	2.72	2.72
Middle CH	2.72	2.72	2.72
Highest CH	2.70	2.72	2.72

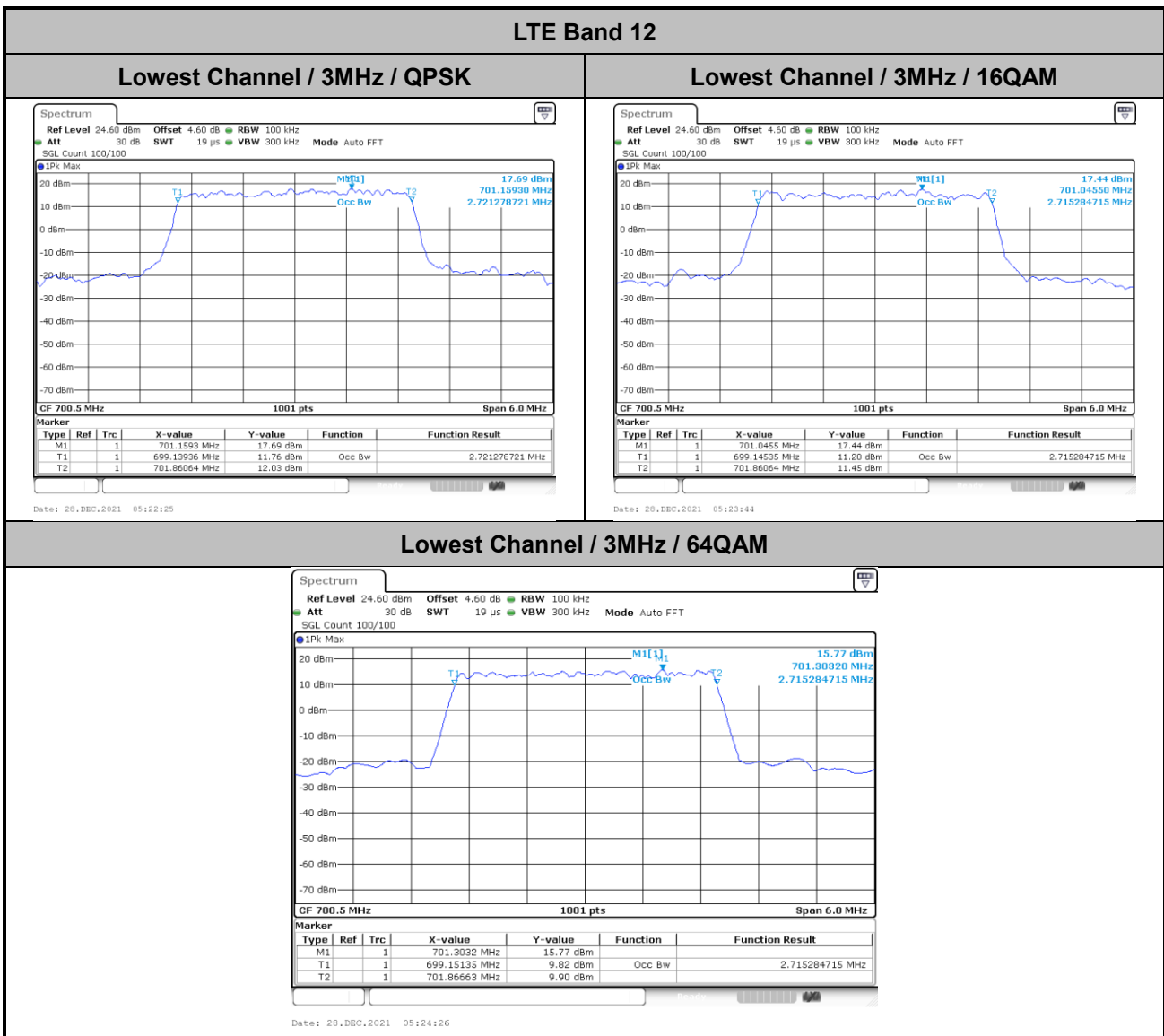



LTE Band 12

Middle Channel / 3MHz / QPSK

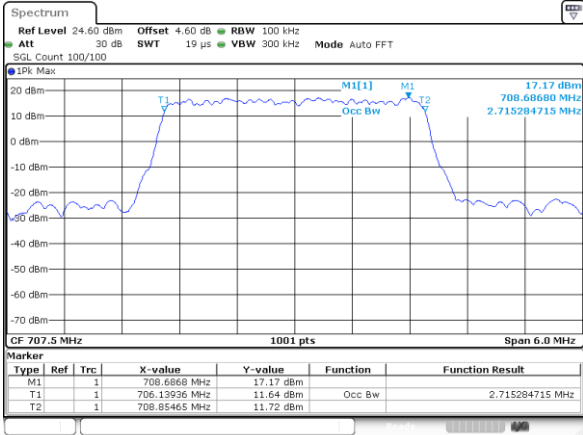

Middle Channel / 3MHz / 16QAM

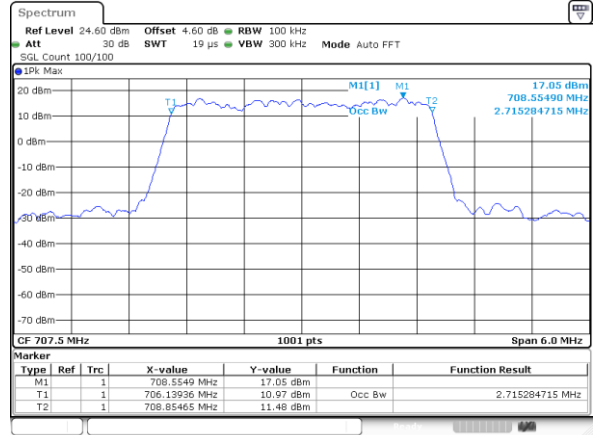

Middle Channel / 3MHz / 64QAM

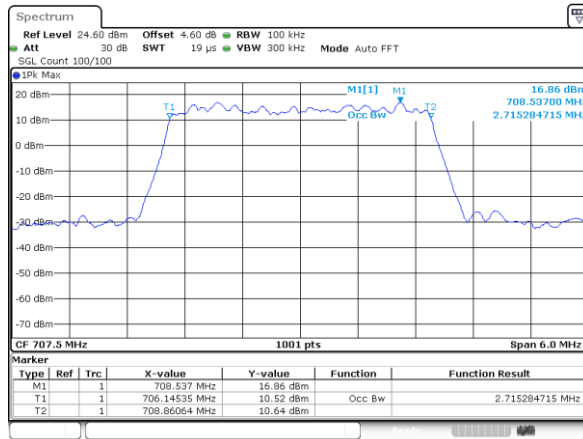



LTE Band 12

Highest Channel / 3MHz / QPSK

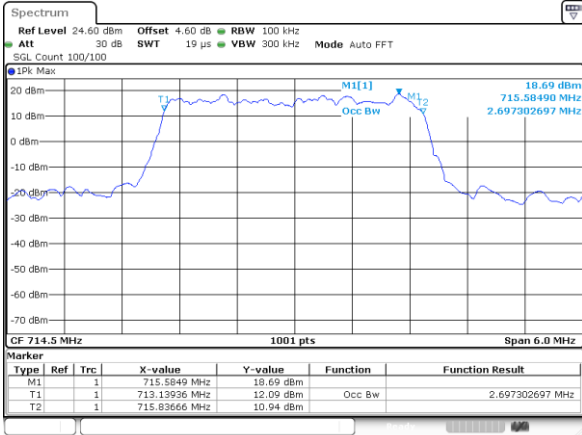

Date: 28. DEC. 2021 05:27:14

Highest Channel / 3MHz / 16QAM

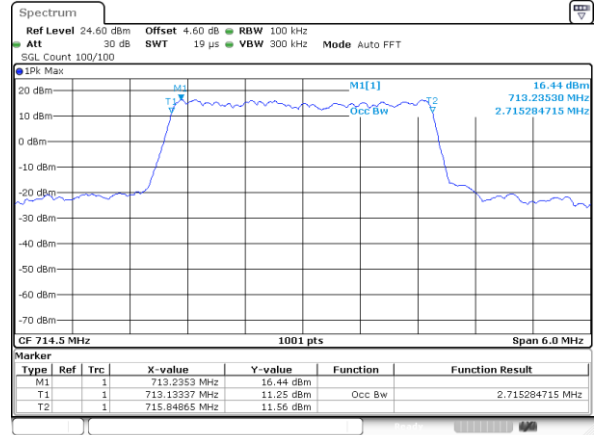

Date: 28. DEC. 2021 05:27:56

Highest Channel / 3MHz / 64QAM

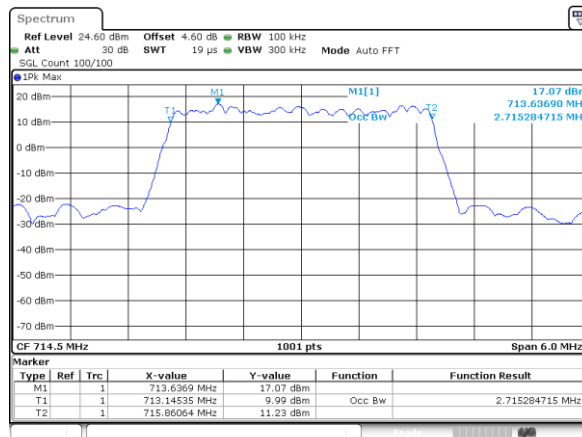

Date: 28. DEC. 2021 05:28:38



Mode	LTE Band 12 : 99%OBW(MHz)		
BW	5 MHz		
Mod.	QPSK	16QAM	64QAM
Lowest CH	4.49	4.48	4.48
Middle CH	4.49	4.49	4.49
Highest CH	4.51	4.48	4.49

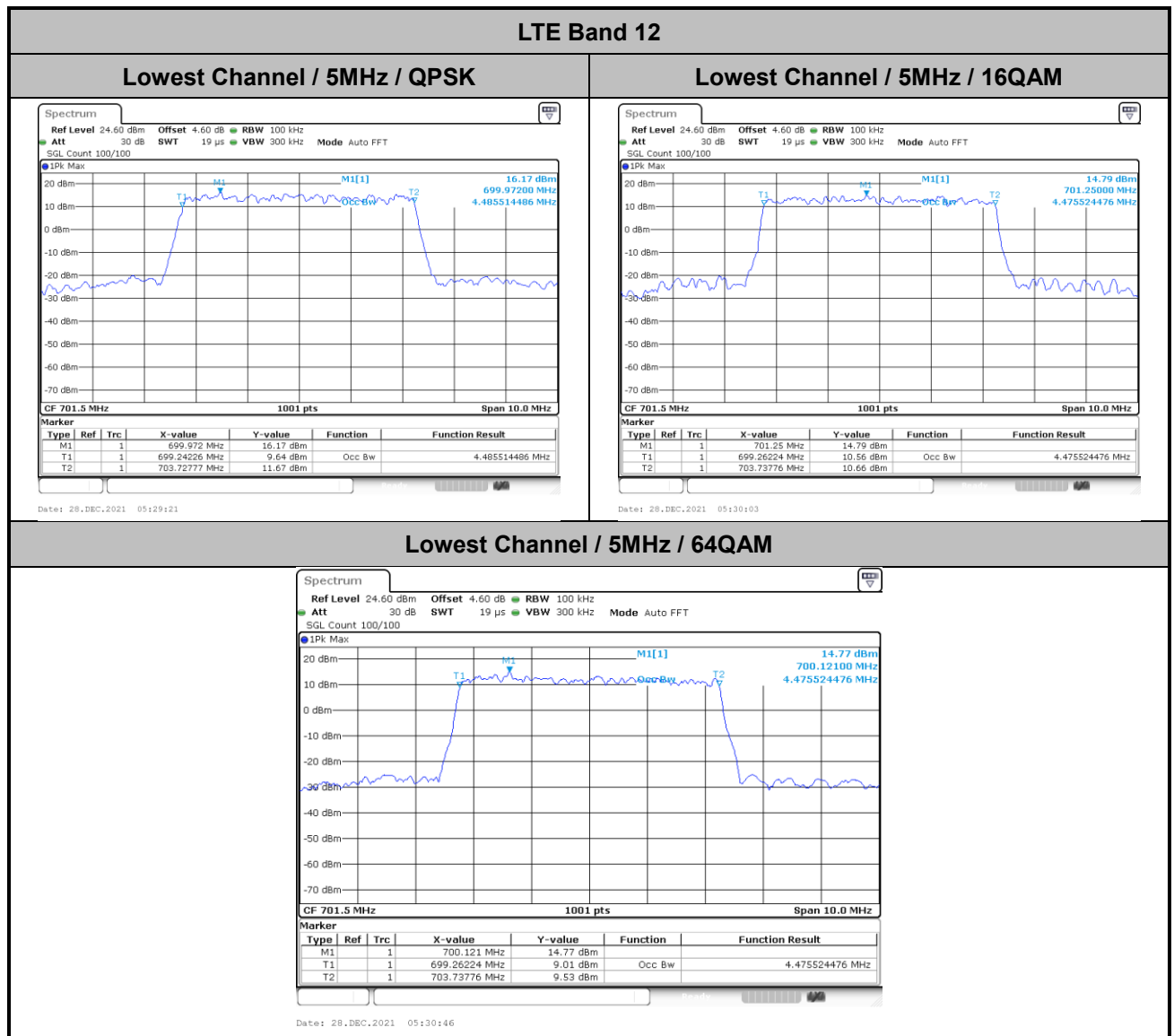



LTE Band 12

Middle Channel / 5MHz / QPSK

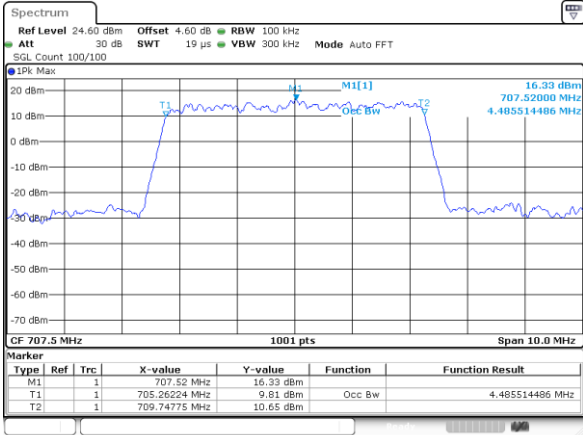

Date: 28, DEC, 2021 05:31:28

Middle Channel / 5MHz / 16QAM

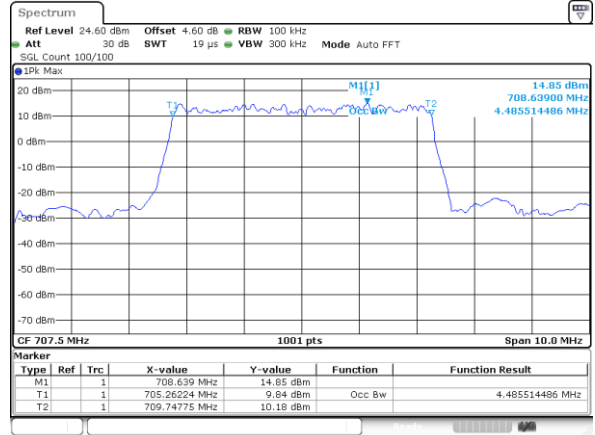

Date: 28, DEC, 2021 05:32:10

Middle Channel / 5MHz / 64QAM

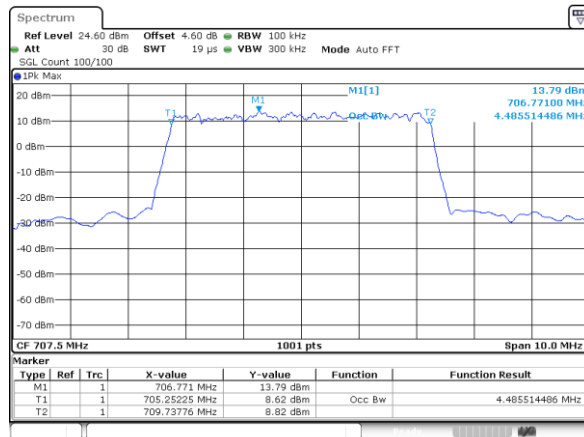

Date: 28, DEC, 2021 05:32:52



LTE Band 12

Highest Channel / 5MHz / QPSK

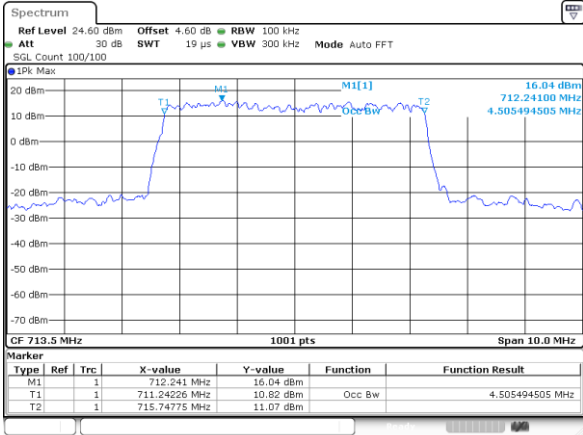

Date: 28. DEC. 2021 05:33:34

Highest Channel / 5MHz / 16QAM

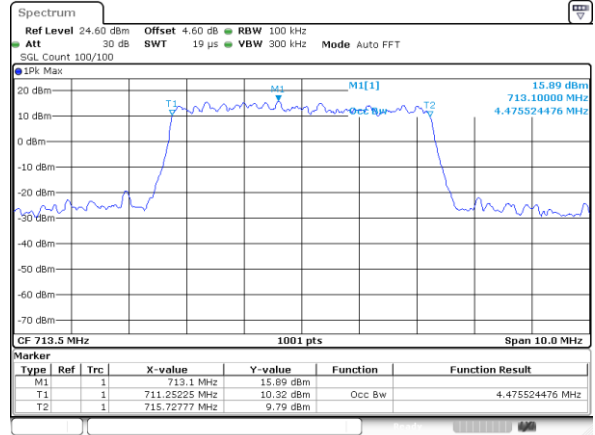

Date: 28. DEC. 2021 05:34:16

Highest Channel / 5MHz / 64QAM

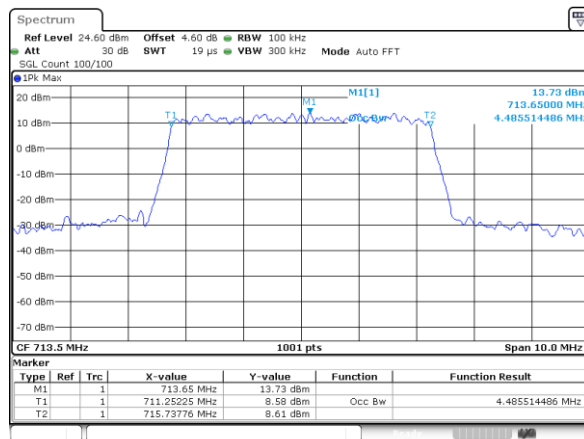

Date: 28. DEC. 2021 05:34:58



Mode	LTE Band 12 : 99%OBW(MHz)		
BW	10MHz		
Mod.	QPSK	16QAM	64QAM
Lowest CH	8.99	9.05	9.05
Middle CH	9.01	9.07	9.03
Highest CH	9.09	8.95	8.95

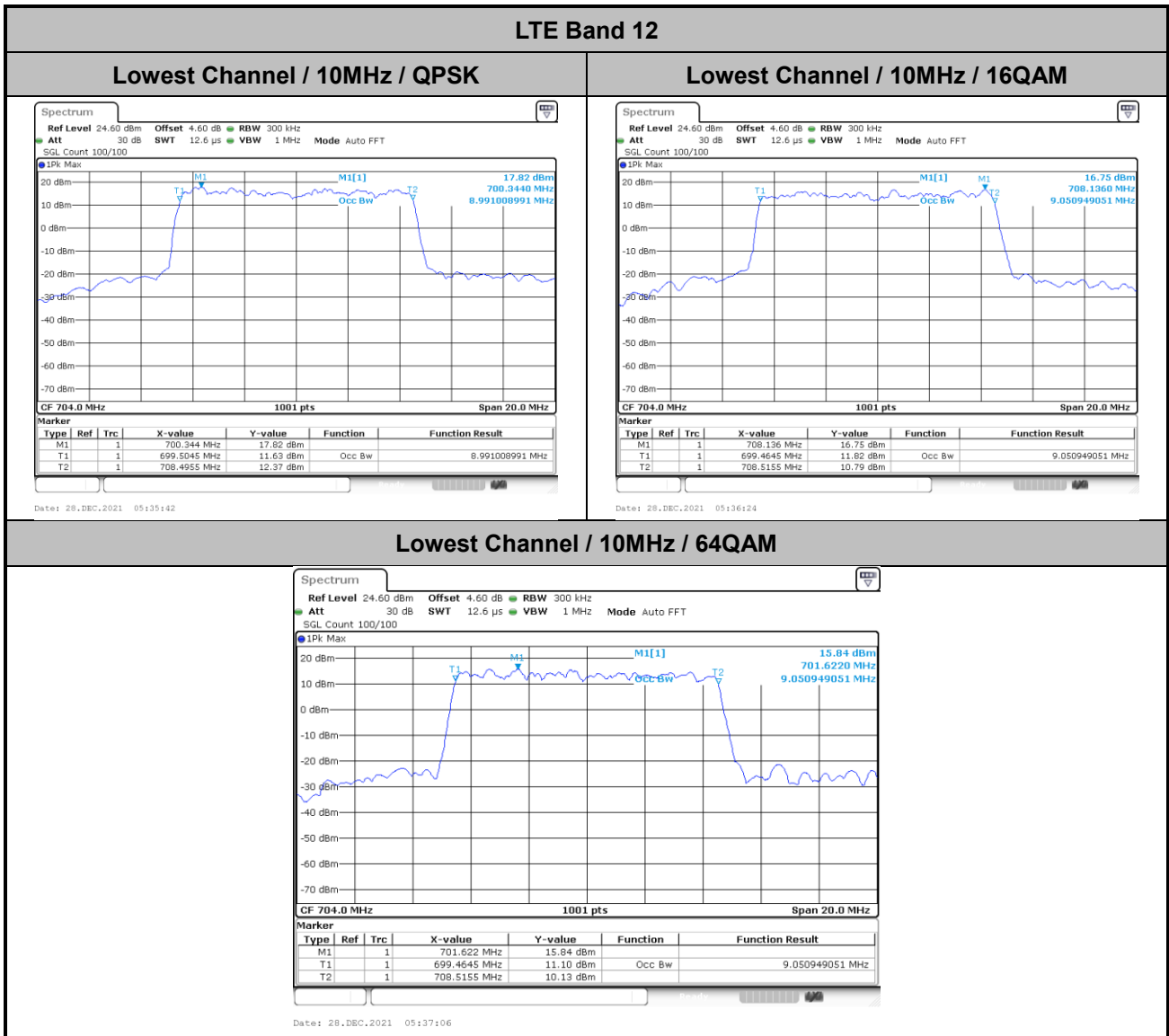



LTE Band 12

Middle Channel / 10MHz / QPSK

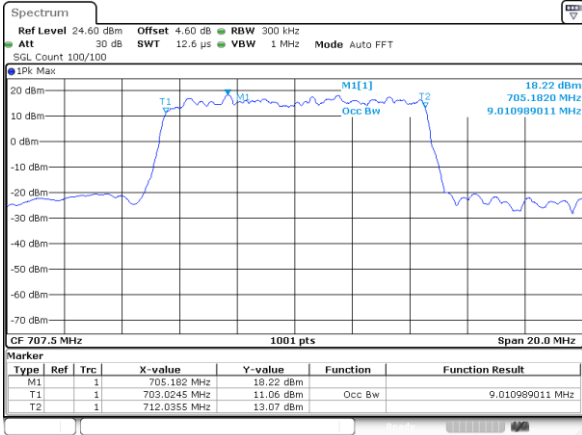

Date: 28. DEC. 2021 05:37:48

Middle Channel / 10MHz / 16QAM

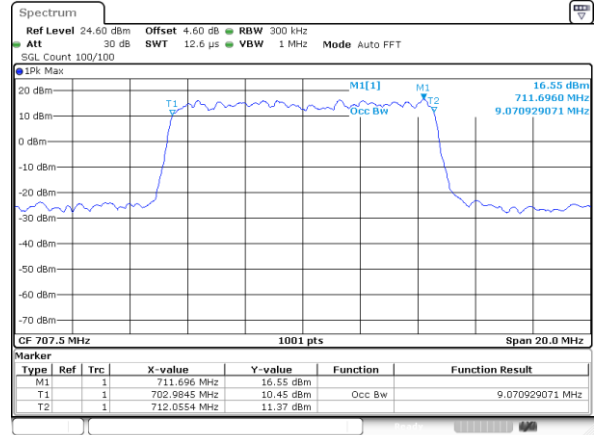

Date: 28. DEC. 2021 05:38:30

Middle Channel / 10MHz / 64QAM

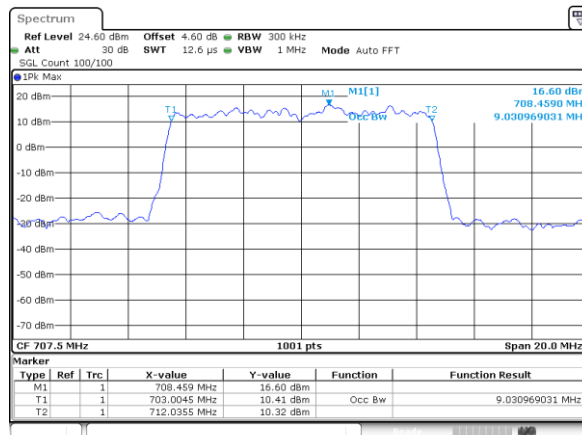

Date: 28. DEC. 2021 05:39:12



LTE Band 12

Highest Channel / 10MHz / QPSK

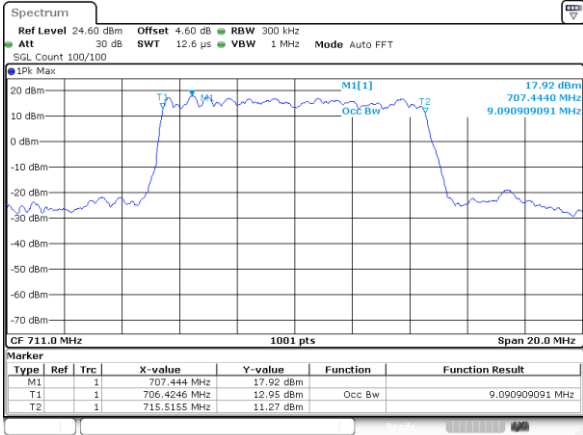

Date: 28. DEC. 2021 05:39:54

Highest Channel / 10MHz / 16QAM

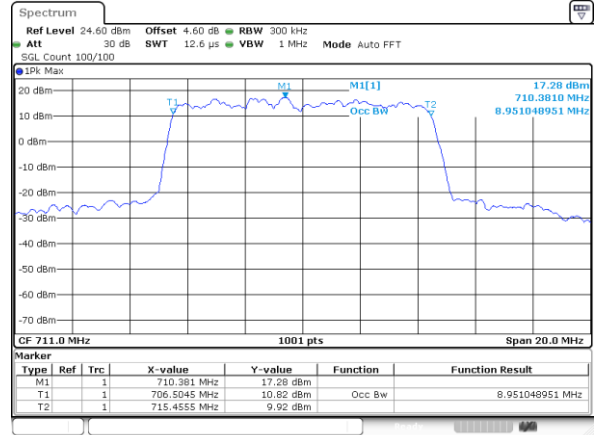

Date: 28. DEC. 2021 05:40:36

Highest Channel / 10MHz / 64QAM

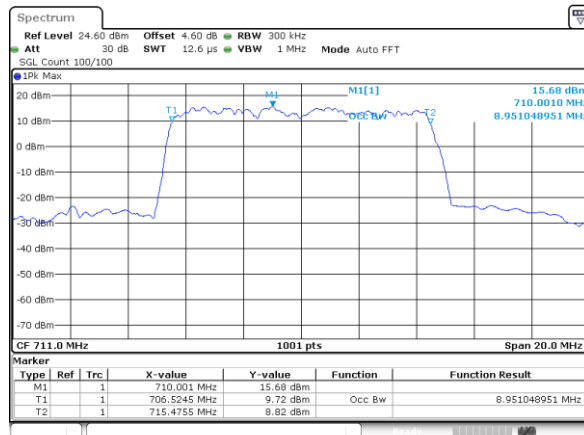

Date: 28. DEC. 2021 05:41:19



Conducted Band Edge

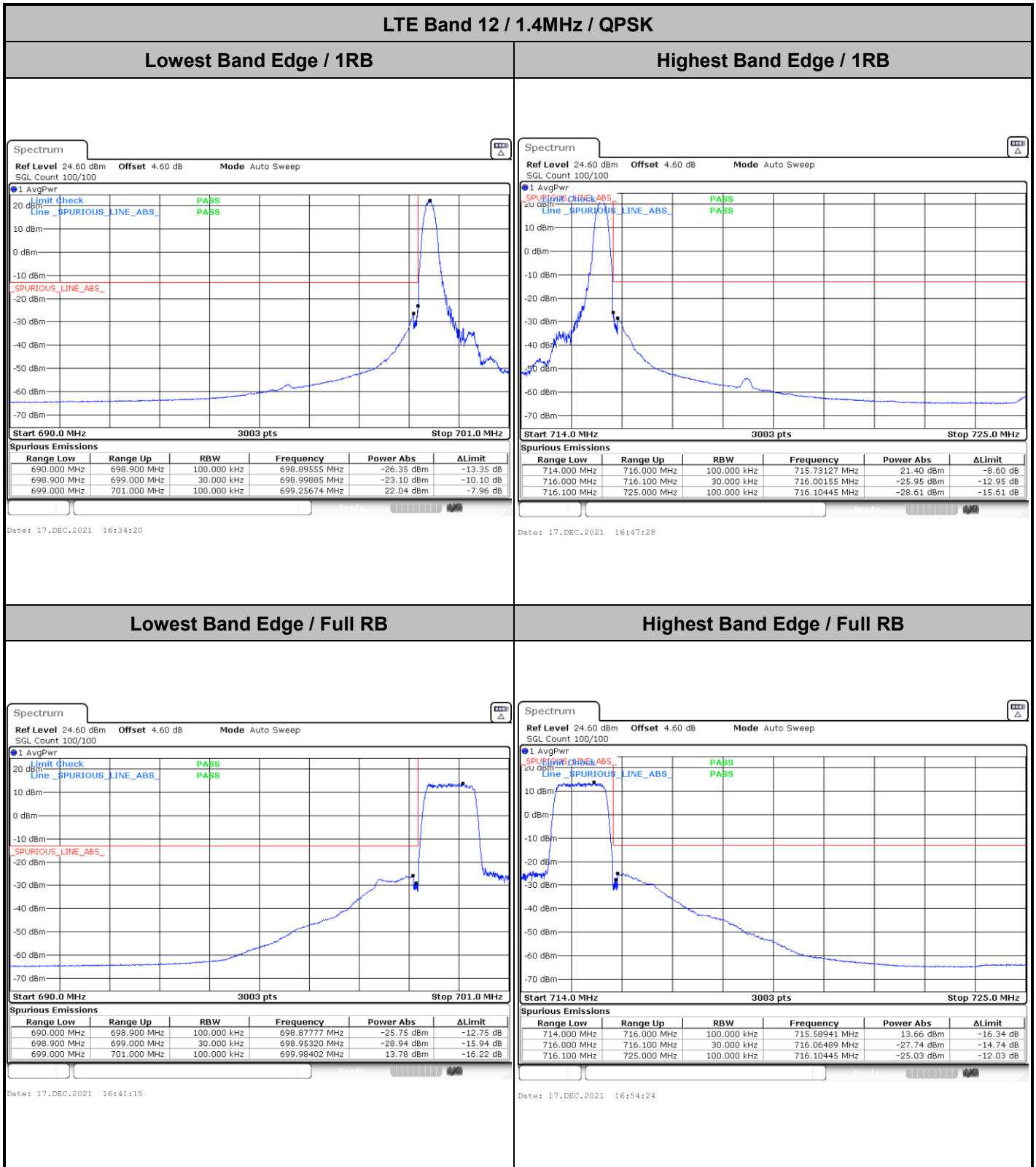



LTE Band 12 / 1.4MHz / 16QAM

Lowest Band Edge / 1 RB

Highest Band Edge / 1 RB

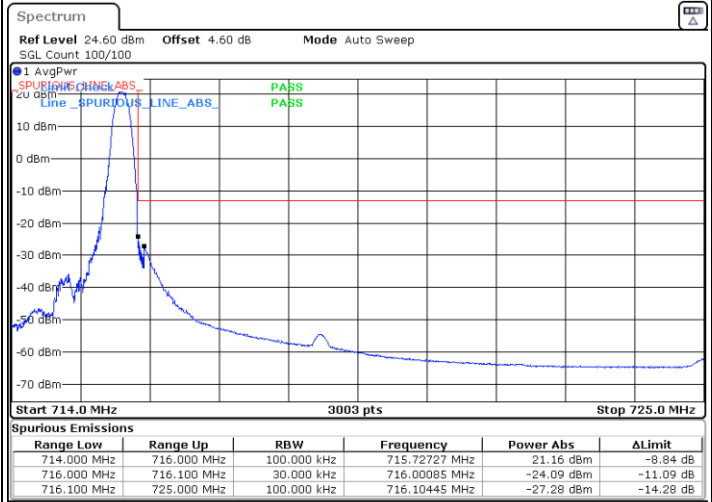
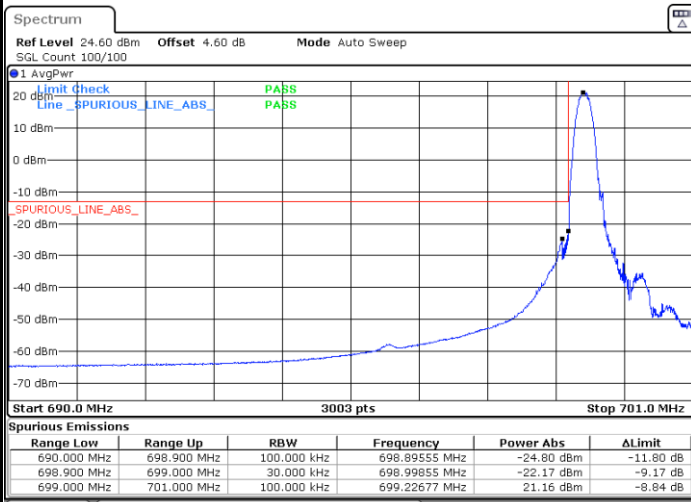

Date: 17.DEC.2021 16:35:43

Date: 17.DEC.2021 16:48:51

Lowest Band Edge / Full RB

Highest Band Edge / Full RB

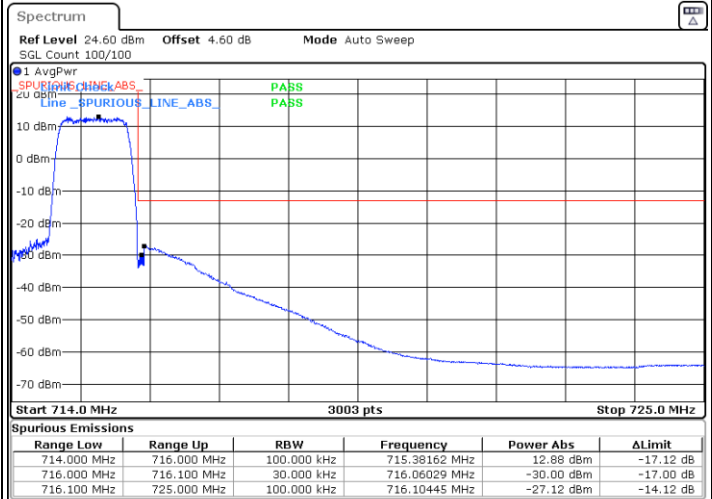
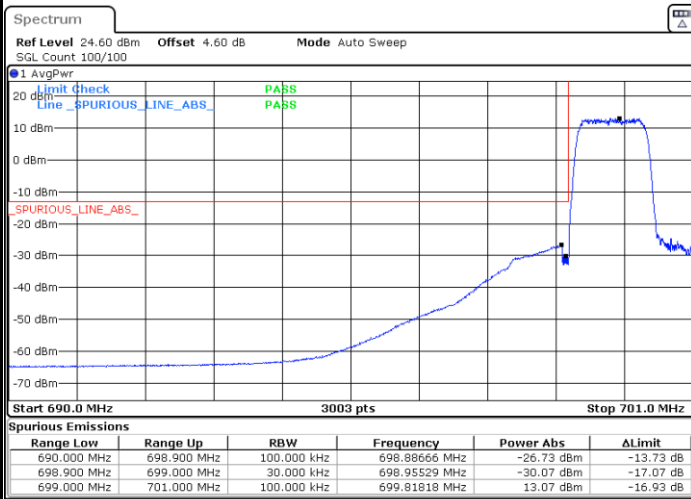

Date: 17.DEC.2021 16:39:52

Date: 17.DEC.2021 16:53:01



LTE Band 12 / 1.4MHz / 64QAM

Lowest Band Edge / 1 RB

Highest Band Edge / 1 RB

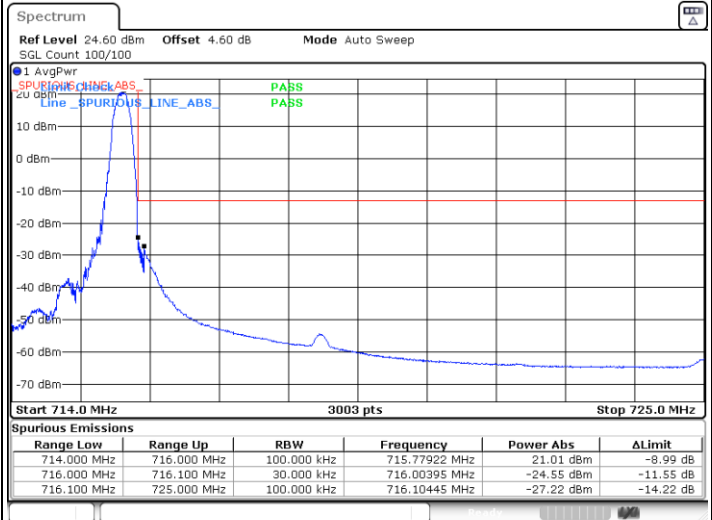
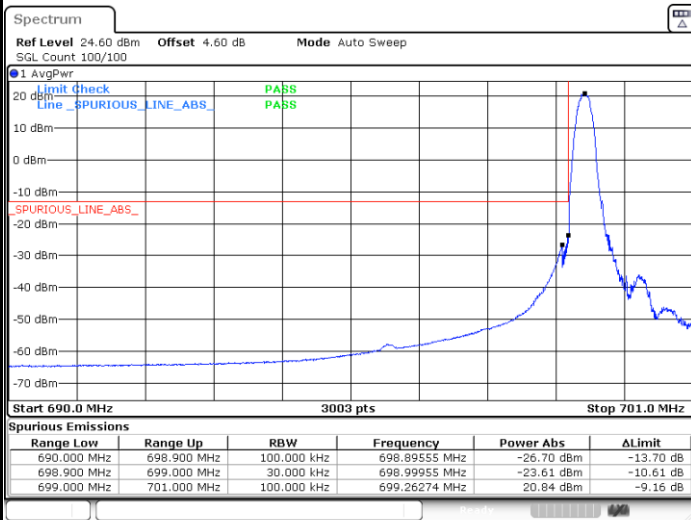

Date: 17.DEC.2021 16:37:06

Date: 17.DEC.2021 16:50:14

Lowest Band Edge / Full RB

Highest Band Edge / Full RB

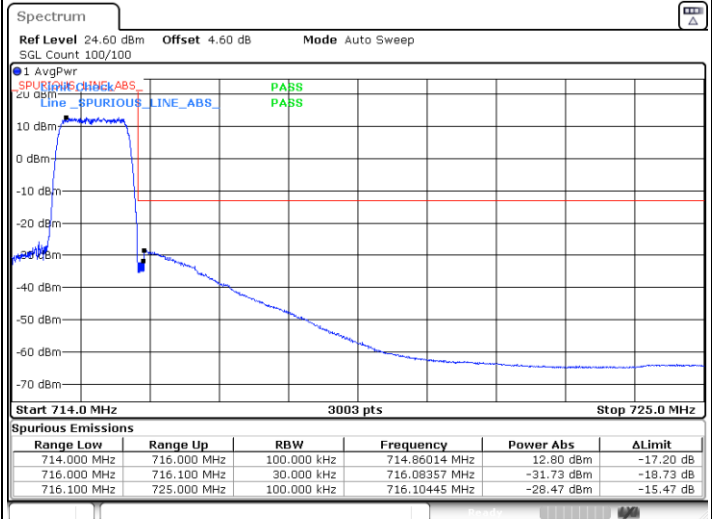
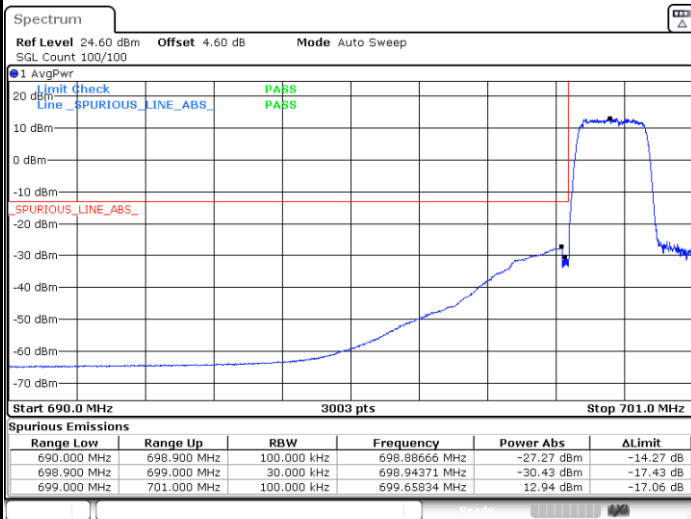

Date: 17.DEC.2021 16:38:29

Date: 17.DEC.2021 16:51:37



LTE Band 12 / 3MHz / QPSK

Lowest Band Edge / 1RB

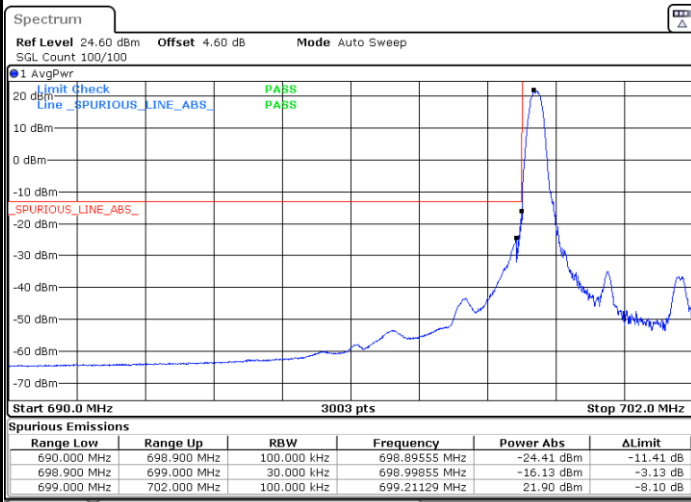

Date: 17.DEC.2021 16:58:04

Highest Band Edge / 1 RB

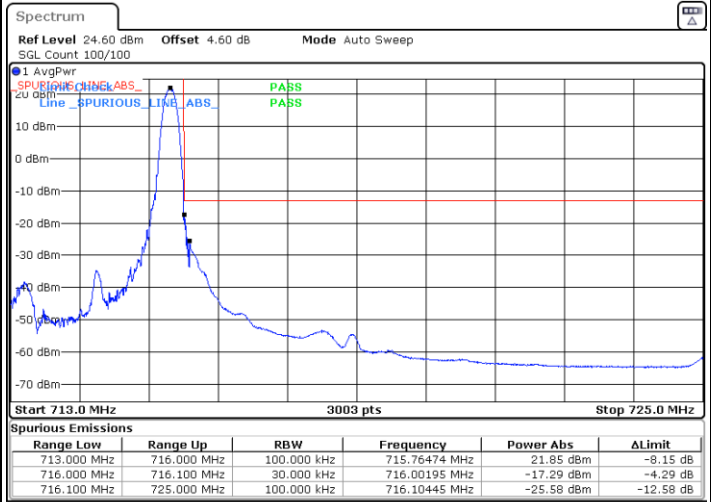

Date: 17.DEC.2021 17:11:11

Lowest Band Edge / Full RB

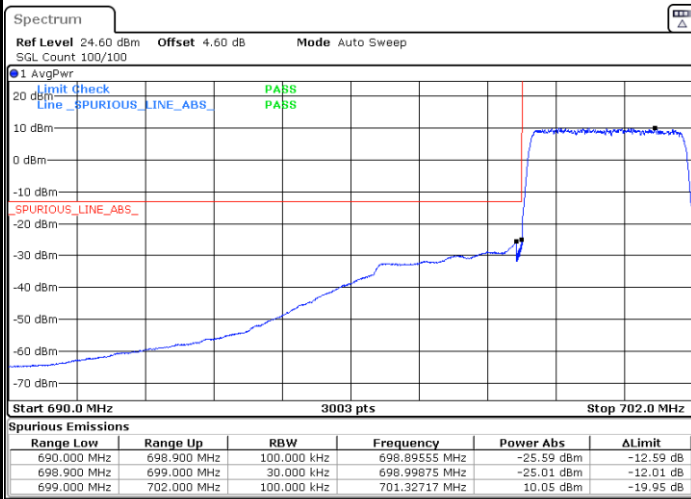

Date: 17.DEC.2021 17:04:59

Highest Band Edge / Full RB

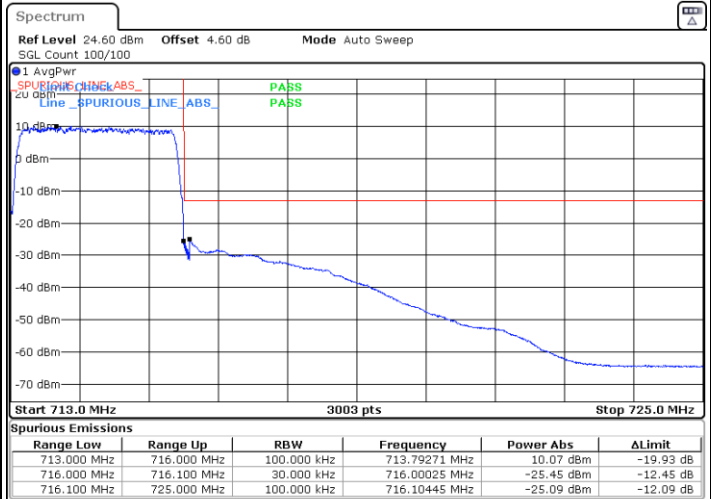

Date: 17.DEC.2021 17:18:07



LTE Band 12 / 3MHz / 16QAM

Lowest Band Edge / 1 RB

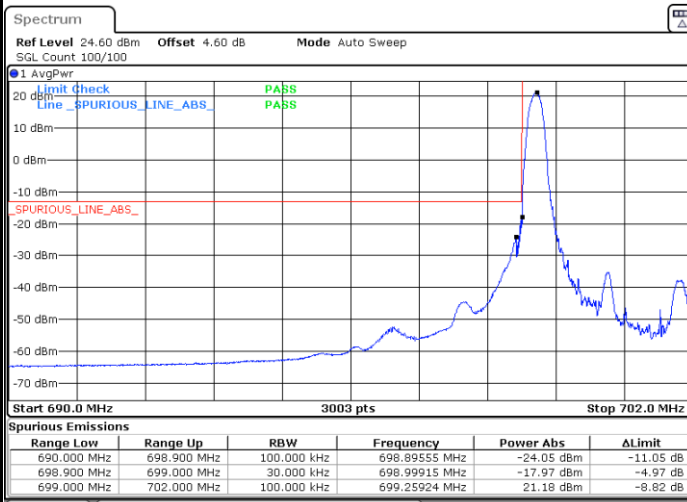

Date: 17.DEC.2021 16:59:26

Highest Band Edge / 1 RB

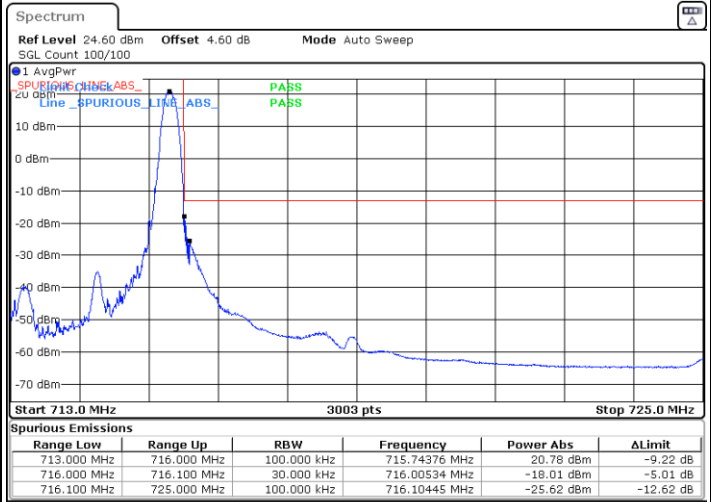

Date: 17.DEC.2021 17:12:35

Lowest Band Edge / Full RB

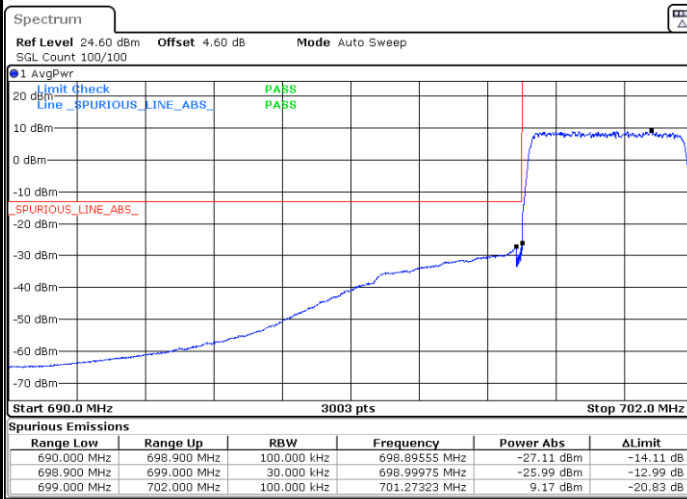

Date: 17.DEC.2021 17:03:36

Highest Band Edge / Full RB

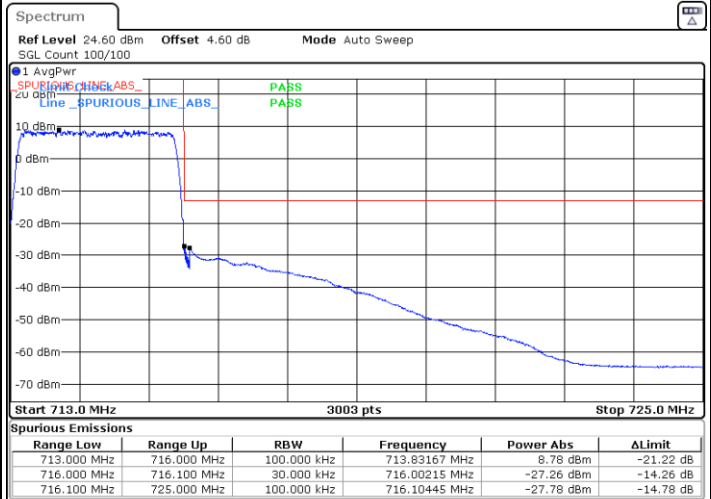

Date: 17.DEC.2021 17:16:44



LTE Band 12 / 3MHz / 64QAM

Lowest Band Edge / 1 RB

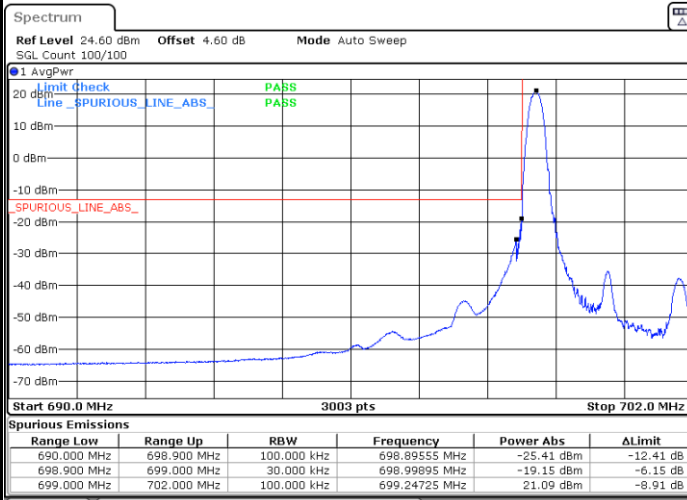

Date: 17.DEC.2021 17:00:49

Highest Band Edge / 1 RB

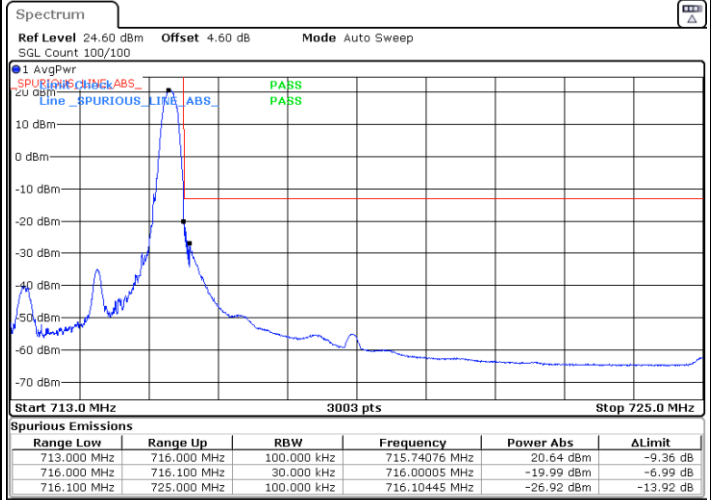

Date: 17.DEC.2021 17:13:58

Lowest Band Edge / Full RB

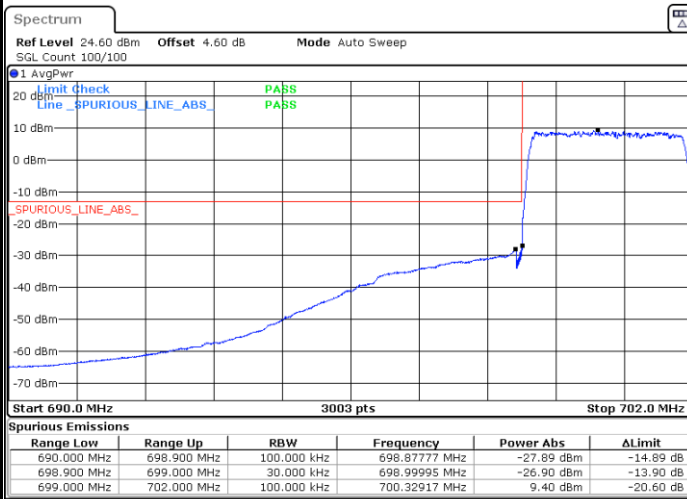

Date: 17.DEC.2021 17:02:13

Highest Band Edge / Full RB

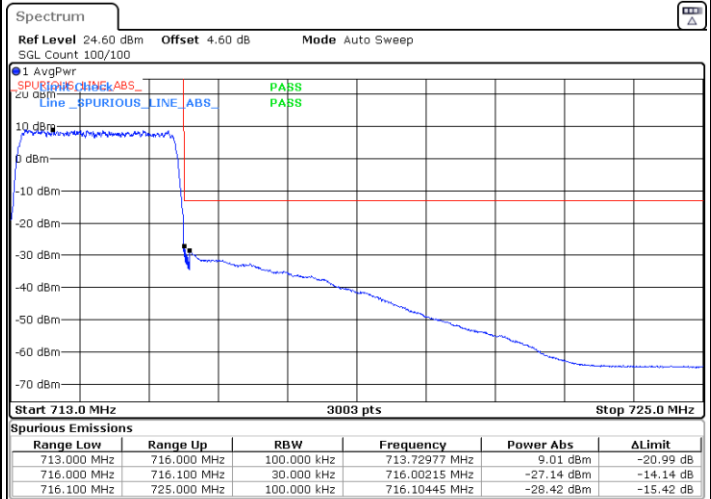

Date: 17.DEC.2021 17:15:21



LTE Band 12 / 5MHz / QPSK

Lowest Band Edge / 1 RB

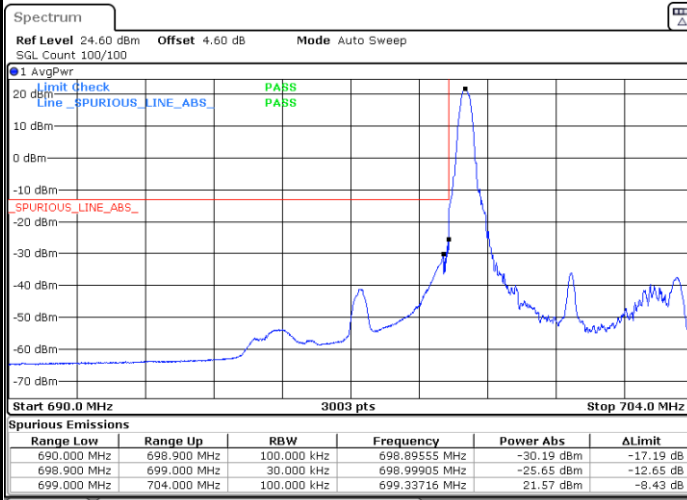

Date: 17.DEC.2021 17:21:46

Highest Band Edge / 1 RB

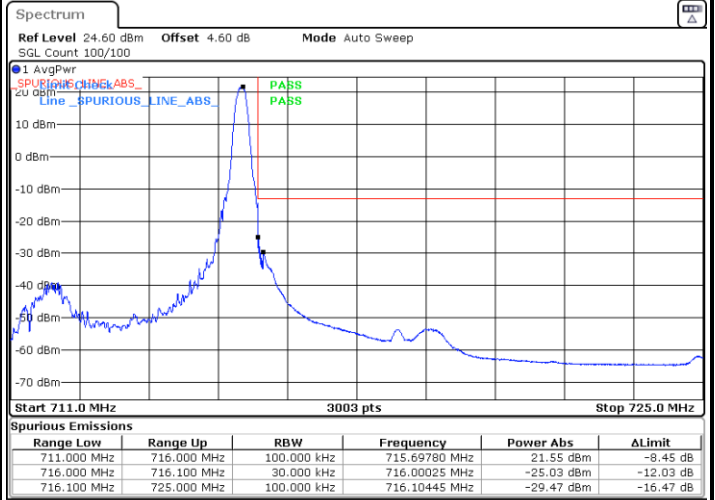

Date: 17.DEC.2021 17:34:54

Lowest Band Edge / Full RB

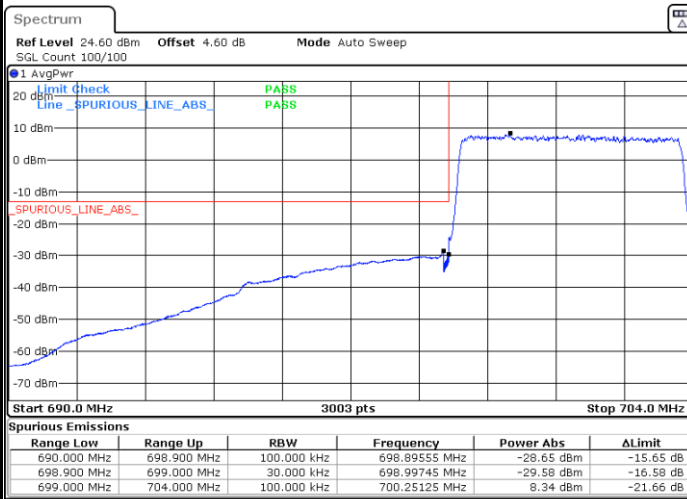

Date: 17.DEC.2021 17:28:41

Highest Band Edge / Full RB

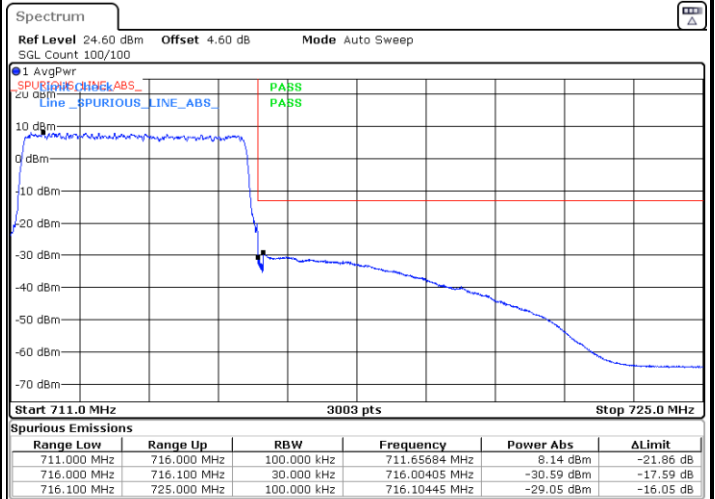

Date: 17.DEC.2021 17:41:49