



FCC RADIO TEST REPORT

FCC ID : PY7-58237R
Equipment : GSM/WCDMA/LTE Phone with BT, DTS/UNII
a/b/g/n/ac, NFC, FM receiver and GNSS
Brand Name : SONY
Applicant : Sony Corporation
1-7-1 Konan Minato-ku Tokyo, 108-0076 Japan
Manufacturer : Sony Corporation
1-7-1 Konan Minato-ku Tokyo, 108-0076 Japan
Standard : FCC 47 CFR Part 2, 22(H), 24(E), 27(L)
Test Date(s) : Dec. 18, 2021 ~ Jan. 04, 2022

We, Sporton International Inc. (Kunshan), would like to declare that the tested sample has been evaluated in accordance with the test procedures given in ANSI / TIA-603-E and has been in compliance with the applicable technical standards.

The test results in this report apply exclusively to the tested model / sample. Without written approval of Sporton International Inc. (Kunshan), the test report shall not be reproduced except in full.

Jason Jia

Reviewed by: Jason Jia / Supervisor

Alex Wang

Approved by: Alex Wang / Manager



Sporton International Inc. (Kunshan)

**No. 1098, Pengxi North Road, Kunshan Economic Development Zone Jiangsu Province 215300
People's Republic of China**



Table of Contents

History of this test report..... 3

Summary of Test Result..... 4

1 General Description 5

 1.1 Product Feature of Equipment Under Test 5

 1.2 Modification of EUT 5

 1.3 Maximum ERP/EIRP Power, Frequency Tolerance, and Emission Designator 5

 1.4 Testing Location 6

 1.5 Applicable Standards 6

2 Test Configuration of Equipment Under Test 7

 2.1 Test Mode..... 7

 2.2 Connection Diagram of Test System 8

 2.3 Support Unit used in test configuration 8

 2.4 Measurement Results Explanation Example 8

 2.5 Frequency List of Low/Middle/High Channels..... 9

3 Conducted Test Result 10

 3.1 Measuring Instruments..... 10

 3.2 Conducted Output Power and ERP/EIRP 11

 3.3 Peak-to-Average Ratio 12

 3.4 99% Occupied Bandwidth and 26dB Bandwidth Measurement..... 13

 3.5 Conducted Band Edge 14

 3.6 Conducted Spurious Emission 15

 3.7 Frequency Stability 16

4 Radiated Test Items 17

 4.1 Measuring Instruments..... 17

 4.2 Test Setup 17

 4.3 Test Result of Radiated Test..... 18

 4.4 Field Strength of Spurious Radiation Measurement 19

5 List of Measuring Equipment..... 20

6 Uncertainty of Evaluation 21

Appendix A. Test Results of Conducted and ERP/EIRP Test

Appendix B. Test Results of Radiated Test



History of this test report

Report No.	Version	Description	Issued Date
FG1D0404A	01	Initial issue of report	Mar. 02, 2022



Summary of Test Result

Report Clause	Ref Std. Clause	Test Items	Result (PASS/FAIL)	Remark
3.2	§2.1046	Conducted Output Power	Report only	-
	§22.913 (a)(2)	Effective Radiated Power (GSM850) (WCDMA Band V)	Pass	
	§24.232 (c)	Equivalent Isotropic Radiated Power (GSM1900)	Pass	
3.3	§24.232 (d)	Peak-to-Average Ratio	Pass	
3.4	§2.1049 §22.917 (b) §24.238 (b)	Occupied Bandwidth (GSM850) (WCDMA Band V) (GSM1900)	Pass	-
3.5	§2.1051 §22.917 (a) §24.238 (a)	Band Edge Measurement (GSM850) (WCDMA Band V) (GSM1900)	Pass	-
3.6	§2.1051 §22.917 (a) §24.238 (a)	Conducted Emission (GSM850) (WCDMA Band V) (GSM1900)	Pass	-
3.7	§2.1055 §22.355 §24.235	Frequency Stability Temperature & Voltage	Pass	-
4.4	§2.1053 §22.917 (a) §24.238 (a)	Field Strength of Spurious Radiation (GSM850) (WCDMA Band V) (GSM1900)	Pass	Under limit 30.27 dB at 2512.000 MHz

Declaration of Conformity:

The test results with all measurement uncertainty excluded are presented in accordance with the regulation limits or requirements declared by manufacturers.

Comments and Explanations:

The declared of product specification for EUT presented in the report are provided by the manufacturer, and the manufacturer takes all the responsibilities for the accuracy of product specification.



1 General Description

1.1 Product Feature of Equipment Under Test

GSM/WCDMA/LTE, Bluetooth, DTS/UNII a/b/g/n/ac, NFC, FM Receiver, and GNSS

Product Specification subjective to this standard	
Antenna Type	PIFA Antenna
Antenna Gain	Cellular Band: -1.3 dBi PCS Band: -1.3 dBi

Remark: The above EUT's information was declared by manufacturer. Please refer to Comments and Explanations in report summary.

EUT Information List			
HW Version	SW Version	IMEI Code	Performed Test Item
A	0.166	004402543115707/ 004402543115701	Conducted Measurement
	0.166	004402543113645/ 004402543281004	Radiated Spurious Emission
	0.166	004402543113645/ 004402543281004	ERP/EIRP Test

Note: For other wireless features of this EUT, test report will be issued separately.

1.2 Modification of EUT

No modifications are made to the EUT during all test items.

1.3 Maximum ERP/EIRP Power, Frequency Tolerance, and Emission Designator

FCC Rule	Frequency Range (MHz)	System	Type of Modulation	Maximum ERP/EIRP (W)	Frequency Tolerance (ppm)	Emission Designator
Part 22	824.2 ~848.8	GSM850 GSM	GMSK	0.7745	0.0625 ppm	242KGXW
Part 22	824.2 ~848.8	GSM850 EDGE	8PSK	0.1766	0.0669 ppm	244KG7W
Part 22	826.4 ~846.6	WCDMA Band V RMC 12.2Kbps	QPSK	0.1023	0.0411 ppm	4M14F9W
Part 24	1850.2 ~1909.8	GSM1900 GSM	GMSK	0.3236	0.0325 ppm	242KGXW
Part 24	1850.2 ~1909.8	GSM1900 EDGE	8PSK	0.1429	0.0167 ppm	246KG7W



1.4 Testing Location

Sporton International Inc. (Kunshan) is accredited to ISO/IEC 17025:2017 by American Association for Laboratory Accreditation with Certificate Number 5145.02.

Test Firm	Sporton International Inc. (Kunshan)		
Test Site Location	No. 1098, Pengxi North Road, Kunshan Economic Development Zone Jiangsu Province 215300 People's Republic of China TEL : +86-512-57900158 FAX : +86-512-57900958		
Test Site No.	Sporton Site No.	FCC Designation No.	FCC Test Firm Registration No.
	03CH04-KS TH01-KS	CN1257	314309

1.5 Applicable Standards

According to the specifications of the manufacturer, the EUT must comply with the requirements of the following standards:

- ♦ ANSI C63.26-2015
- ♦ ANSI / TIA-603-E
- ♦ FCC 47 CFR Part 2, 22(H), 24(E)
- ♦ FCC KDB 971168 D01 Power Meas. License Digital Systems v03r01
- ♦ FCC KDB 412172 D01 Determining ERP and EIRP v01r01
- ♦ FCC KDB 414788 D01 Radiated Test Site v01r01

Remark:

1. All test items were verified and recorded according to the standards and without any deviation during the test.
2. This EUT has also been tested and complied with the requirements of FCC Part 15, Subpart B, recorded in a separate test report.



2 Test Configuration of Equipment Under Test

2.1 Test Mode

Antenna port conducted and radiated test items were performed according to KDB 971168 D01 Power Meas. License Digital Systems v03r01 with maximum output power.

For radiated measurement, the measured emission level of the EUT was maximized by rotating the EUT on a turntable, adjusting the orientation of the EUT and EUT antenna in three orthogonal axis (X: flat, Y: portrait, Z: landscape), and adjusting the measurement antenna orientation, following C63.26 exploratory test procedures and find Y plane as worst plane.

Radiated emissions were investigated as following frequency range:

1. 30 MHz to 9000 MHz for GSM850 and WCDMA Band V
2. 30 MHz to 19100 MHz for GSM1900

All modes, data rates and positions were investigated.

Test modes are chosen to be reported as the worst case configuration below:

Test Modes		
Band	Radiated TCs	Conducted TCs
GSM850	<ul style="list-style-type: none"> ■ GSM Link ■ EDGE Link 	<ul style="list-style-type: none"> ■ GSM Link ■ EDGE Link
GSM1900	<ul style="list-style-type: none"> ■ GSM Link ■ EDGE Link 	<ul style="list-style-type: none"> ■ GSM Link ■ EDGE Link
WCDMA Band V	<ul style="list-style-type: none"> ■ RMC 12.2Kbps Link 	<ul style="list-style-type: none"> ■ RMC 12.2Kbps Link

Remark: We have evaluated simultaneous transmissions modes and determined no new significant emissions are observed.

2.2 Connection Diagram of Test System

<EUT With Accessory>

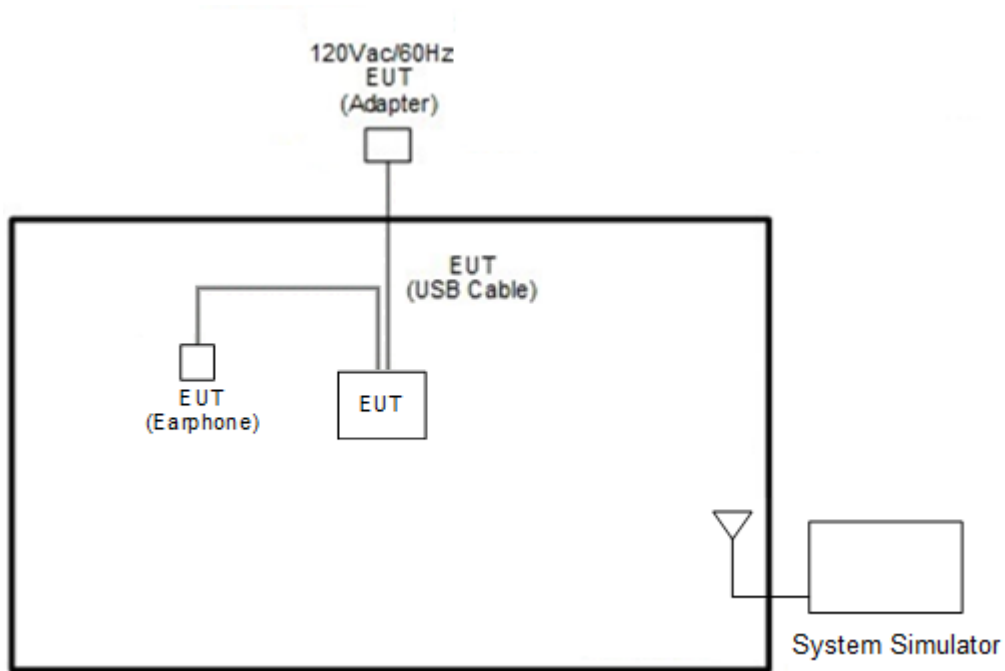

2.3 Support Unit used in test configuration

Item	Equipment	Brand Name	Model No.	FCC ID	Data Cable	Power Cord
1.	LTE Base Station	Anritsu	MT8821C/MT8000	N/A	N/A	Unshielded,1.8m

2.4 Measurement Results Explanation Example

For all conducted test items:

The offset level is set in the spectrum analyzer to compensate the RF cable loss and attenuator factor between RF conducted output port and spectrum analyzer. With the offset compensation, the spectrum analyzer reading level will be exactly the RF output level.

The spectrum analyzer offset is derived from RF cable loss and attenuator factor.

Offset = RF cable loss + attenuator factor.

The following shows an offset computation example with RF cable loss 4.8 dB and a 10 dB attenuator.

Example:

$$\begin{aligned} \text{Offset}(dB) &= \text{RF cable loss}(dB) + \text{attenuator factor}(dB) \\ &= 4.8 + 10 = 14.8 \text{ (dB)} \end{aligned}$$



2.5 Frequency List of Low/Middle/High Channels

Frequency List				
Band	Channel/Frequency(MHz)	Lowest	Middle	Highest
GSM850	Channel	128	189	251
	Frequency	824.2	836.4	848.8
WCDMA Band V	Channel	4132	4182	4233
	Frequency	826.4	836.4	846.6
GSM1900	Channel	512	661	810
	Frequency	1850.2	1880.0	1909.8

3 Conducted Test Result

3.1 Measuring Instruments

See list of measuring instruments of this test report.

3.1.1 Test Setup

3.1.2 Conducted Output Power

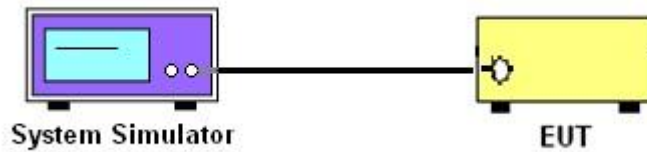

3.1.3 Peak-to-Average Ratio, Occupied Bandwidth, Conducted Band-Edge and Conducted Spurious Emission

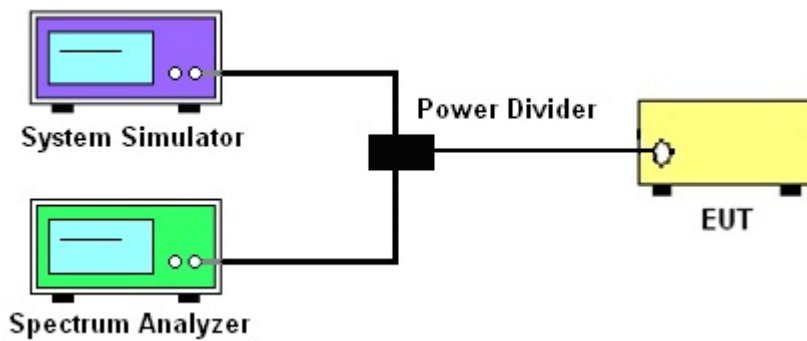

3.1.4 Frequency Stability

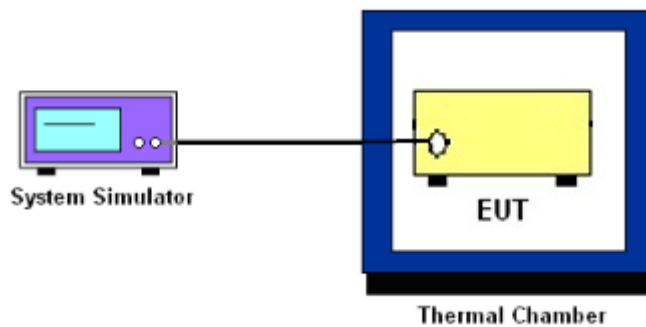

3.1.5 Test Result of Conducted Test

Please refer to Appendix A.



3.2 Conducted Output Power and ERP/EIRP

3.2.1 Description of the Conducted Output Power and ERP/EIRP

A system simulator was used to establish communication with the EUT. Its parameters were set to enforce EUT transmitting at the maximum power. The measured power in the radio frequency on the transmitter output terminals shall be reported.

The ERP of mobile transmitters must not exceed 7 Watts for GSM850 and WCDMA Band V

The EIRP of mobile transmitters must not exceed 2 Watts for GSM1900

According to KDB 412172 D01 Power Approach,

$EIRP = P_T + G_T - L_C$, $ERP = EIRP - 2.15$, where

P_T = transmitter output power in dBm

G_T = gain of the transmitting antenna in dBi

L_C = signal attenuation in the connecting cable between the transmitter and antenna in dB

3.2.2 Test Procedures

1. The transmitter output port was connected to the system simulator.
2. Set EUT at maximum power through system simulator.
3. Select the lowest, middle, and the highest channels for each band and different modulation.
4. Measure the maximum burst average power for GSM and maximum average power for other modulation signal.



3.3 Peak-to-Average Ratio

3.3.1 Description of the PAR Measurement

The peak-to-average ratio (PAR) of the transmission may not exceed 13 dB.

3.3.2 Test Procedures

The testing follows ANSI C63.26-2015 Section 5.2.6

1. The EUT was connected to spectrum analyzer and system simulator via a power divider.
2. Set EUT to transmit at maximum output power.
3. When the duty cycle is less than 98%, then signal gating will be implemented on the spectrum analyzer by triggering from the system simulator.
4. Set the CCDF (Complementary Cumulative Distribution Function) option of the spectrum analyzer.
5. Record the maximum PAPR level associated with a probability of 0.1%.



3.4 99% Occupied Bandwidth and 26dB Bandwidth Measurement

3.4.1 Description of 99% Occupied Bandwidth and 26dB Bandwidth Measurement

The occupied bandwidth is the width of a frequency band such that, below the lower and above the upper frequency limits, the mean powers emitted are each equal to a specified percentage 0.5% of the total mean transmitted power.

The 26 dB emission bandwidth is defined as the frequency range between two points, one above and one below the carrier frequency, at which the spectral density of the emission is attenuated 26 dB below the maximum in-band spectral density of the modulated signal.

3.4.2 Test Procedures

The testing follows ANSI C63.26-2015 Section 5.4.3 (26dB) and Section 5.4.4 (99OB)

1. The EUT was connected to spectrum analyzer and system simulator via a power divider.
2. The spectrum analyzer center frequency is set to the nominal EUT channel center frequency. The span range for the spectrum analyzer shall be between two and five times the anticipated OBW.
3. The nominal resolution bandwidth (RBW) shall be in the range of 1 to 5 % of the anticipated OBW, and the VBW shall be at least 3 times the RBW.
4. Set the detection mode to peak, and the trace mode to max hold.
5. Determine the reference value: Set the EUT to transmit a modulated signal. Allow the trace to stabilize. Set the spectrum analyzer marker to the highest level of the displayed trace. (This is the reference value)
6. Determine the “-26 dB down amplitude” as equal to (Reference Value – X).
7. Place two markers, one at the lowest and the other at the highest frequency of the envelope of the spectral display such that each marker is at or slightly below the “-X dB down amplitude” determined in step 6. If a marker is below this “-X dB down amplitude” value it shall be placed as close as possible to this value. The OBW is the positive frequency difference between the two markers.
8. Use the 99 % power bandwidth function of the spectrum analyzer and report the measured bandwidth.



3.5 Conducted Band Edge

3.5.1 Description of Conducted Band Edge Measurement

The power of any emission outside of the authorized operating frequency ranges must be lower than the transmitter power (P) by a factor of at least $43 + 10 \log (P)$ dB.

3.5.2 Test Procedures

The testing follows FCC KDB 971168 D01 v03r01 Section 6.1.

1. The EUT was connected to the spectrum analyzer and system simulator via a power divider.
2. The RF output of EUT was connected to the spectrum analyzer by an RF cable and attenuator. The path loss was compensated to the results for each measurement.
3. The band edges of low and high channels for the highest RF powers were measured.
4. The RF fundamental frequency should be excluded against the limit line in the operating frequency band.
5. The limit line is derived from $43 + 10\log(P)$ dB below the transmitter power P(Watts)



3.6 Conducted Spurious Emission

3.6.1 Description of Conducted Spurious Emission Measurement

The power of any emission outside of the authorized operating frequency ranges must be lower than the transmitter power (P) by a factor of at least $43 + 10 \log (P)$ dB.

It is measured by means of a calibrated spectrum analyzer and scanned from 30 MHz up to a frequency including its 10th harmonic.

3.6.2 Test Procedures

The testing follows FCC KDB 971168 D01 v03r01 Section 6.1.

1. The EUT was connected to the spectrum analyzer and system simulator via a power divider.
2. The RF output of EUT was connected to the spectrum analyzer by an RF cable and attenuator. The path loss was compensated to the results for each measurement.
3. The middle channel for the highest RF power within the transmitting frequency was measured.
4. The conducted spurious emission for the whole frequency range was taken.
5. The RF fundamental frequency should be excluded against the limit line in the operating frequency band.
6. The limit line is derived from $43 + 10\log(P)$ dB below the transmitter power P(Watts)



3.7 Frequency Stability

3.7.1 Description of Frequency Stability Measurement

22.355

The frequency stability shall be measured by variation of ambient temperature and variation of primary supply voltage to ensure that the fundamental emission stays within the authorized frequency block. The frequency stability of the transmitter shall be maintained within $\pm 0.00025\%$ ($\pm 2.5\text{ppm}$) of the center frequency.

24.235

The frequency stability shall be sufficient to ensure that the fundamental emissions stay within the authorized bands of operation.

3.7.2 Test Procedures for Temperature Variation

The testing follows FCC KDB 971168 D01 v03r01 Section 9.0.

1. The EUT was set up in the thermal chamber and connected with the system simulator.
2. With power OFF, the temperature was decreased to -30°C and the EUT was stabilized before testing. Power was applied and the maximum change in frequency was recorded within one minute.
3. With power OFF, the temperature was raised in 10°C steps up to 50°C . The EUT was stabilized at each step for at least half an hour. Power was applied and the maximum frequency change was recorded within one minute.

3.7.3 Test Procedures for Voltage Variation

The testing follows FCC KDB 971168 D01 v03r01 Section 9.0.

1. The EUT was placed in a temperature chamber at $20\pm 5^{\circ}\text{C}$ and connected with the system simulator.
2. The power supply voltage to the EUT was varied from 85% to 115% of the nominal value measured at the input to the EUT.
3. The variation in frequency was measured for the worst case.

4 Radiated Test Items

4.1 Measuring Instruments

See list of measuring instruments of this test report.

4.2 Test Setup

For radiated test below 30MHz

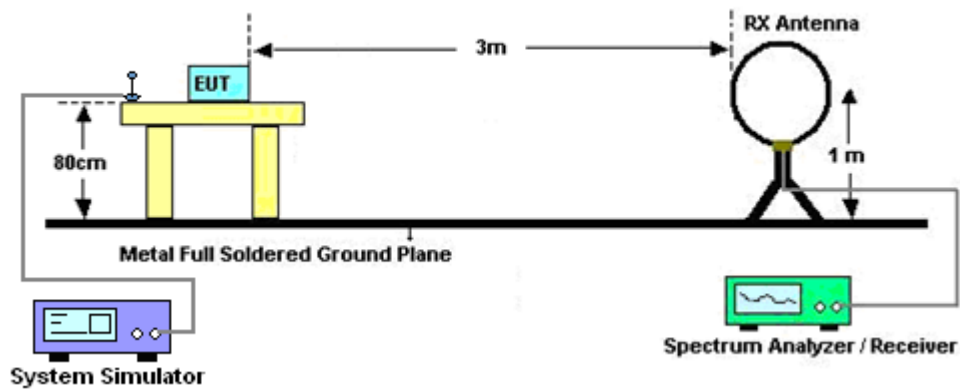

For radiated test from 30MHz to 1GHz

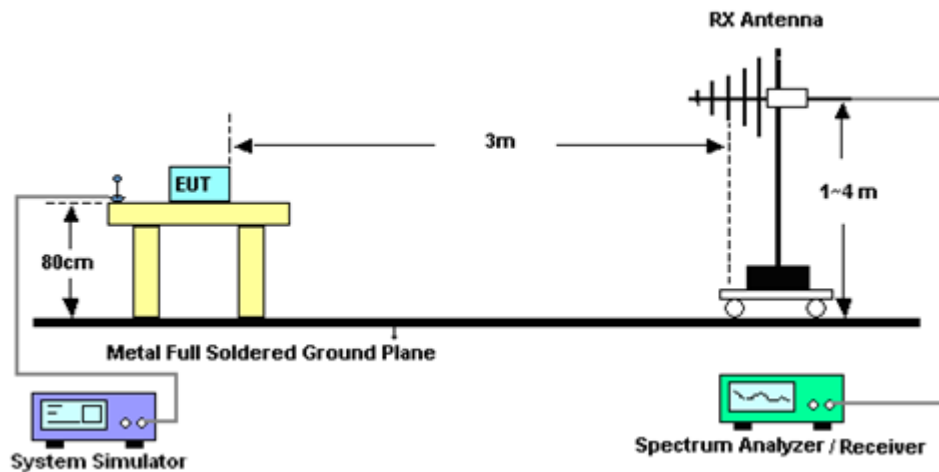

For radiated test above 1GHz

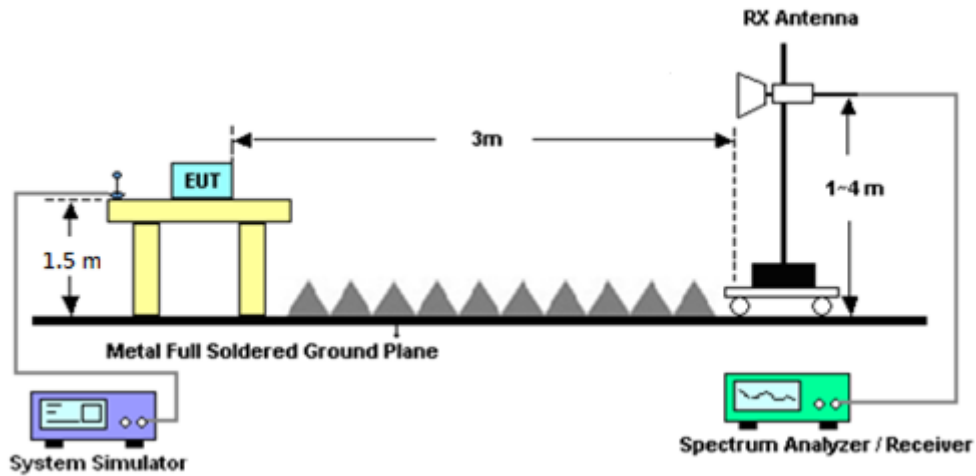

4.3 Test Result of Radiated Test

Please refer to Appendix B.

Note:

The low frequency, which started from 9 kHz to 30 MHz, was pre-scanned and the result which was 20 dB lower than the limit line was not reported.

There is adequate comparison measurement of both open-field test site and alternative test site - semi-Anechoic chamber according to 414788 D01 Radiated Test Site v01r01, and the result came out very similar.



4.4 Field Strength of Spurious Radiation Measurement

4.4.1 Description of Field Strength of Spurious Radiated Measurement

The power of any emission outside of the authorized operating frequency ranges must be attenuated below the transmitter power (P) by a factor of at least $43 + 10 \log (P)$ dB. The spectrum is scanned from 30 MHz up to a frequency including its 10th harmonic.

4.4.2 Test Procedures

The testing follows FCC KDB 971168 D01 v03r01 Section 7 and ANSI / TIA-603-E Section 2.2.12.

1. The EUT was placed on a rotatable wooden table 0.8 meters for frequency below 1 GHz and 1.5 meter for frequency above 1 GHz above the ground.
2. The EUT was set 3 meters from the receiving antenna, which was mounted on the antenna tower.
3. The table was rotated 360 degrees to determine the position of the highest spurious emission.
4. The height of the receiving antenna is varied between one meter and four meters to search for the maximum spurious emission for both horizontal and vertical polarizations.
5. Make the measurement with the spectrum analyzer's RBW = 1 MHz, VBW = 3 MHz, taking record of maximum spurious emission.
6. A horn antenna was substituted in place of the EUT and was driven by a signal generator.
7. Tune the output power of signal generator to the same emission level with EUT maximum spurious emission.
8. Take the record of output power at antenna port.
9. Repeat step 7 to step 8 for another polarization.
10. $EIRP \text{ (dBm)} = S.G. \text{ Power} - Tx \text{ Cable Loss} + Tx \text{ Antenna Gain}$
11. $ERP \text{ (dBm)} = EIRP - 2.15$
12. The RF fundamental frequency should be excluded against the limit line in the operating frequency band.
13. The limit line is derived from $43 + 10\log(P)$ dB below the transmitter power P(Watts)



5 List of Measuring Equipment

Instrument	Manufacturer	Model No.	Serial No.	Characteristics	Calibration Date	Test Date	Due Date	Remark
Spectrum Analyzer	R&S	FSV40	101040	10Hz~40GHz	Oct. 14, 2021	Dec. 18, 2021~ Dec. 25, 2021	Oct. 13, 2022	Conducted (TH01-KS)
Power divider	STI	STI08-0055	-	0.5~40GHz	Aug. 26, 2021	Dec. 18, 2021~ Dec. 25, 2021	Aug. 25, 2022	Conducted (TH01-KS)
Temperature & humidity chamber	Hongzhan	LP-150U	H2014011440	-40~+150°C 20%~95%RH	Jul. 12, 2021	Dec. 18, 2021~ Dec. 25, 2021	Jul. 11, 2022	Conducted (TH01-KS)
EXA Spectrum Analyzer	Keysight	N9010A	MY55150244	10Hz-44G,MAX 30dB	Apr. 13, 2021	Jan. 04, 2022	Apr. 12, 2022	Radiation (03CH04-KS)
Loop Antenna	R&S	HFH2-Z2	100321	9kHz~30MHz	Oct. 31, 2021	Jan. 04, 2022	Oct. 30, 2022	Radiation (03CH04-KS)
Bilog Antenna	TeseQ	CBL6111D	49922	30MHz-1GHz	May 30, 2021	Jan. 04, 2022	May 29, 2022	Radiation (03CH04-KS)
Horn Antenna	Schwarzbeck	BBHA9120D	1356	1GHz~18GHz	Apr. 18, 2021	Jan. 04, 2022	Apr. 17, 2022	Radiation (03CH04-KS)
SHF-EHF Horn	Com-power	AH-840	101070	18GHz~40GHz	Jan. 06, 2021	Jan. 04, 2022	Jan. 05, 2022	Radiation (03CH04-KS)
Amplifier	SONOMA	310N	187289	9KHz-1GHz	Jan. 06, 2021	Jan. 04, 2022	Jan. 05, 2022	Radiation (03CH04-KS)
Amplifier	MITEQ	EM18G40G GA	060728	18~40GHz	Jan. 07, 2021	Jan. 04, 2022	Jan. 06, 2022	Radiation (03CH04-KS)
high gain Amplifier	MITEQ	AMF-7D-00 101800-30-1 0P	2025788	1Ghz-18Ghz	Jan. 06, 2021	Jan. 04, 2022	Jan.05, 2022	Radiation (03CH04-KS)
Amplifier	Keysight	83017A	MY57280106	500MHz~26.5GHz	Oct. 13, 2021	Jan. 04, 2022	Oct. 12, 2022	Radiation (03CH04-KS)
AC Power Source	Chroma	61601	F104090004	N/A	NCR	Jan. 04, 2022	NCR	Radiation (03CH04-KS)
Turn Table	ChamPro	EM 1000-T	060762-T	0~360 degree	NCR	Jan. 04, 2022	NCR	Radiation (03CH04-KS)
Antenna Mast	ChamPro	EM 1000-A	060762-A	1 m~4 m	NCR	Jan. 04, 2022	NCR	Radiation (03CH04-KS)

NCR: No Calibration Required



6 Uncertainty of Evaluation

Uncertainty of Radiated Emission Measurement (30 MHz ~ 1000 MHz)

Measuring Uncertainty for a Level of Confidence of 95% (U = 2Uc(y))	3.3dB
---	-------

Uncertainty of Radiated Emission Measurement (1 GHz ~ 18 GHz)

Measuring Uncertainty for a Level of Confidence of 95% (U = 2Uc(y))	2.8dB
---	-------

Uncertainty of Radiated Emission Measurement (18 GHz ~ 40 GHz)

Measuring Uncertainty for a Level of Confidence of 95% (U = 2Uc(y))	2.8dB
---	-------



Appendix A. Test Results of Conducted and ERP/EIRP Test

Conducted Output Power(Average power) and ERP/EIRP

GSM850 TX Channel	Burst Average Power (dBm)			ERP(W)		
	128	189	251	L	M	H
Frequency (MHz)	824.2	836.4	848.8			
GSM 1 Tx slot	32.27	32.23	32.34	0.7621	0.7551	0.7745
GPRS 1 Tx slot	32.25	32.20	32.32	0.7586	0.7499	0.7709
GPRS 2 Tx slots	30.14	30.18	30.51	0.4667	0.4710	0.5082
GPRS 3 Tx slots	28.98	28.76	28.81	0.3573	0.3396	0.3436
GPRS 4 Tx slots	27.90	27.97	27.82	0.2786	0.2831	0.2735
EDGE 1 Tx slot	25.92	25.77	25.70	0.1766	0.1706	0.1679
EDGE 2 Tx slots	24.39	24.24	24.18	0.1242	0.1199	0.1183
EDGE 3 Tx slots	23.44	23.15	23.05	0.0998	0.0933	0.0912
EDGE 4 Tx slots	22.23	22.12	21.98	0.0755	0.0736	0.0713

GSM1900 TX Channel	Burst Average Power (dBm)			EIRP(W)		
	512	661	810	L	M	H
Frequency (MHz)	1850.2	1880	1909.8			
GSM 1 Tx slot	26.40	26.33	26.35	0.3236	0.3184	0.3199
GPRS 1 Tx slot	26.39	26.29	26.31	0.3228	0.3155	0.3170
GPRS 2 Tx slots	25.23	25.17	25.19	0.2472	0.2438	0.2449
GPRS 3 Tx slots	23.22	23.28	23.29	0.1556	0.1578	0.1581
GPRS 4 Tx slots	22.28	22.32	22.27	0.1253	0.1265	0.1250
EDGE 1 Tx slot	22.67	22.84	22.85	0.1371	0.1426	0.1429
EDGE 2 Tx slots	21.83	21.76	21.68	0.1130	0.1112	0.1091
EDGE 3 Tx slots	19.92	19.75	19.74	0.0728	0.0700	0.0698
EDGE 4 Tx slots	18.89	18.85	18.80	0.0574	0.0569	0.0562



Band		WCDMA V			ERP(W)		
TX Channel		4132	4182	4233			
Rx Channel		4357	4407	4458			
Frequency (MHz)		826.4	836.4	846.6	L	M	H
3GPP Rel 99	AMR 12.2Kbps	23.47	23.53	23.48	0.1005	0.1019	0.1007
3GPP Rel 99	RMC 12.2Kbps	23.48	23.55	23.51	0.1007	0.1023	0.1014
3GPP Rel 6	HSDPA Subtest-1	22.34	22.46	22.35	0.0774	0.0796	0.0776
3GPP Rel 6	HSDPA Subtest-2	22.39	22.39	22.18	0.0783	0.0783	0.0746
3GPP Rel 6	HSDPA Subtest-3	21.96	22.02	21.76	0.0710	0.0719	0.0678
3GPP Rel 6	HSDPA Subtest-4	21.97	21.88	21.82	0.0711	0.0697	0.0687
3GPP Rel 8	DC-HSDPA Subtest-1	22.42	22.33	22.26	0.0789	0.0773	0.0760
3GPP Rel 8	DC-HSDPA Subtest-2	22.33	22.30	22.21	0.0773	0.0767	0.0752
3GPP Rel 8	DC-HSDPA Subtest-3	21.77	21.84	21.82	0.0679	0.0690	0.0687
3GPP Rel 8	DC-HSDPA Subtest-4	21.85	21.83	21.91	0.0692	0.0689	0.0701
3GPP Rel 6	HSUPA Subtest-1	22.33	22.26	22.41	0.0773	0.0760	0.0787
3GPP Rel 6	HSUPA Subtest-2	20.37	20.38	20.53	0.0492	0.0493	0.0511
3GPP Rel 6	HSUPA Subtest-3	21.23	21.29	21.33	0.0600	0.0608	0.0614
3GPP Rel 6	HSUPA Subtest-4	20.20	20.27	20.45	0.0473	0.0481	0.0501
3GPP Rel 6	HSUPA Subtest-5	22.28	22.22	22.27	0.0764	0.0753	0.0762
3GPP Rel 7	HSPA+ (16QAM) Subtest-1	20.15	20.02	20.14	0.0468	0.0454	0.0467



A1. GSM

Peak-to-Average Ratio

Mode	GSM850		Limit: 13dB
Mod.	GSM	EDGE	Result
Lowest CH	0.20	3.19	PASS
Middle CH	0.12	3.33	
Highest CH	0.12	3.28	

Mode	GSM1900		Limit: 13dB
Mod.	GSM	EDGE	Result
Lowest CH	0.14	2.90	PASS
Middle CH	0.20	3.04	
Highest CH	0.17	2.81	

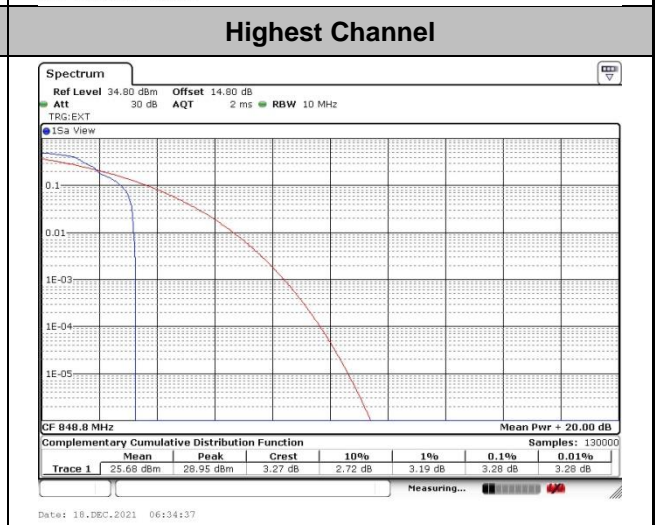
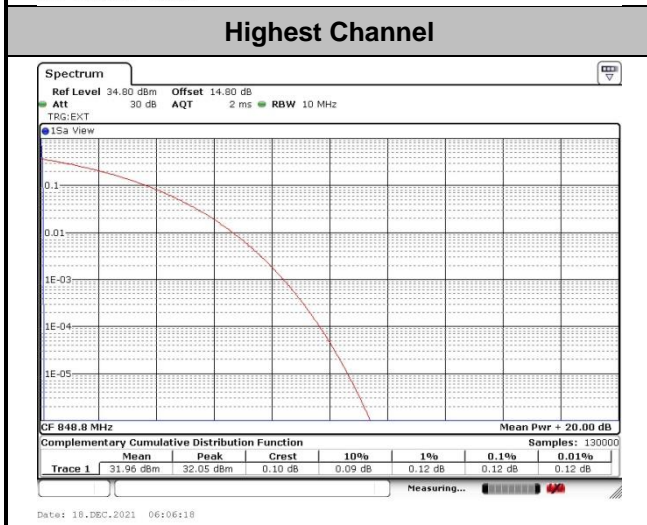
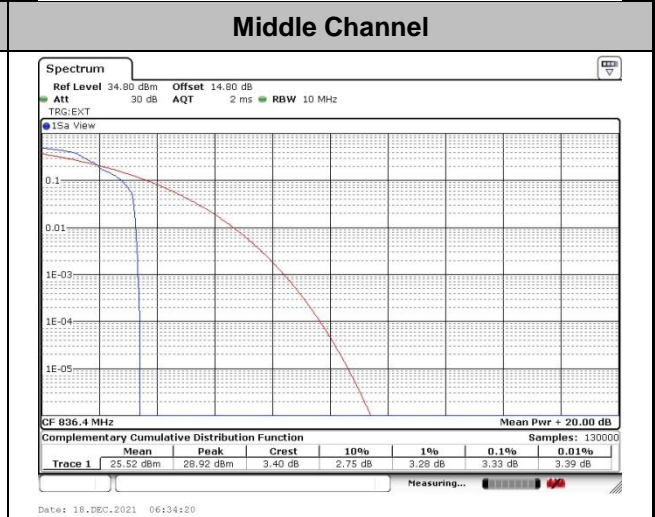
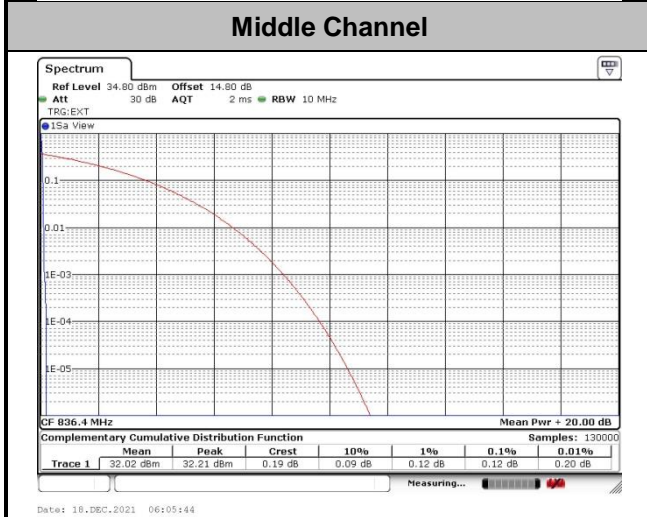
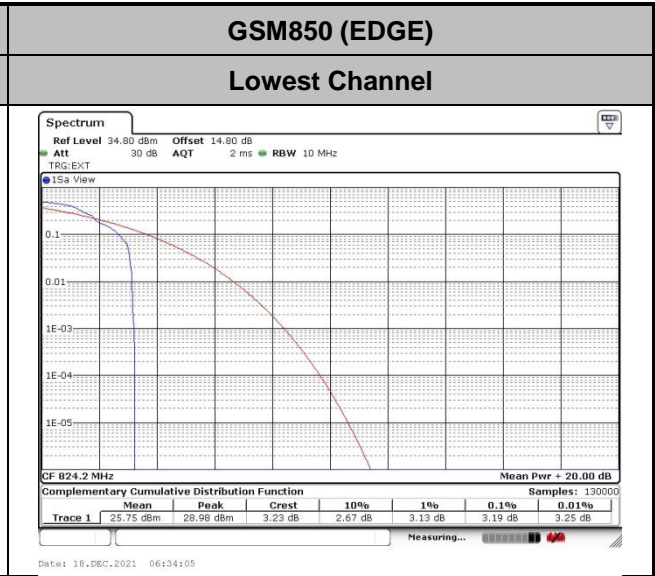
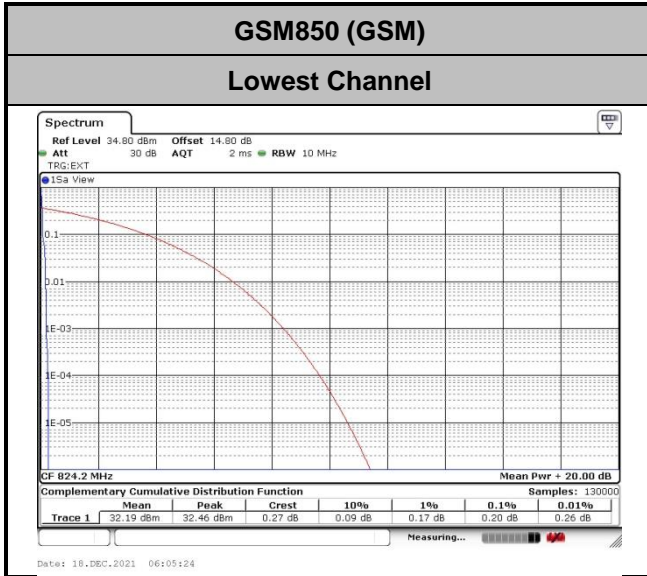

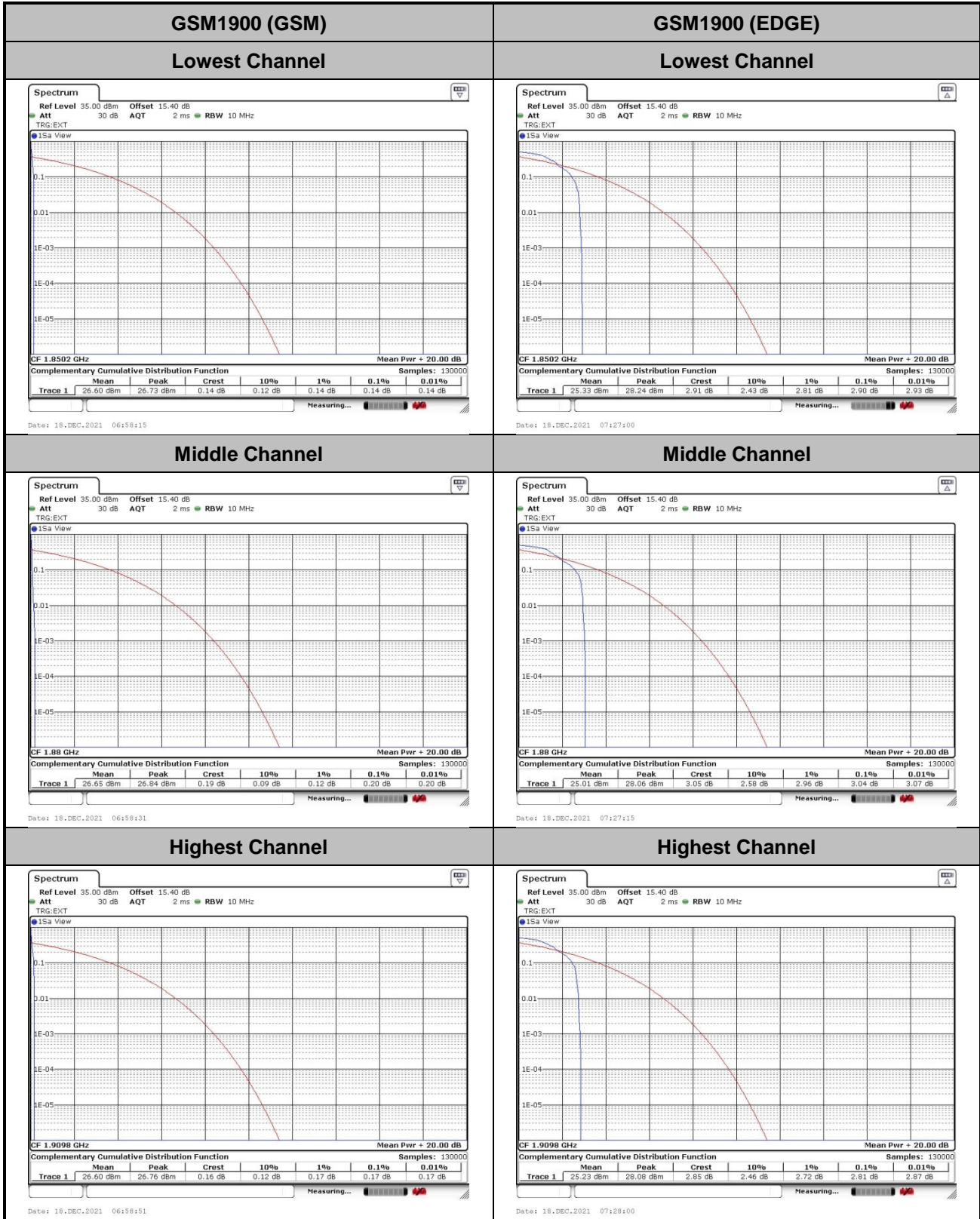



26dB Bandwidth

Mode	GSM850(MHz)	
Mod.	GSM	EDGE
Lowest CH	0.28	0.30
Middle CH	0.31	0.30
Highest CH	0.31	0.30

Mode	GSM1900(MHz)	
Mod.	GSM	EDGE
Lowest CH	0.31	0.31
Middle CH	0.30	0.31
Highest CH	0.30	0.30



GSM850 (GSM)

Lowest Channel

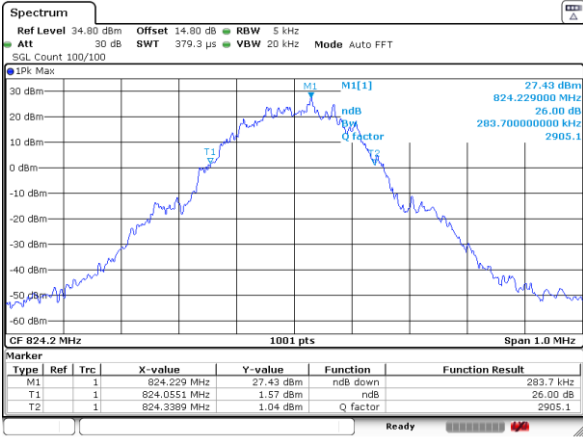

Date: 24 DEC 2021 22:38:01

GSM850 (EDGE)

Lowest Channel

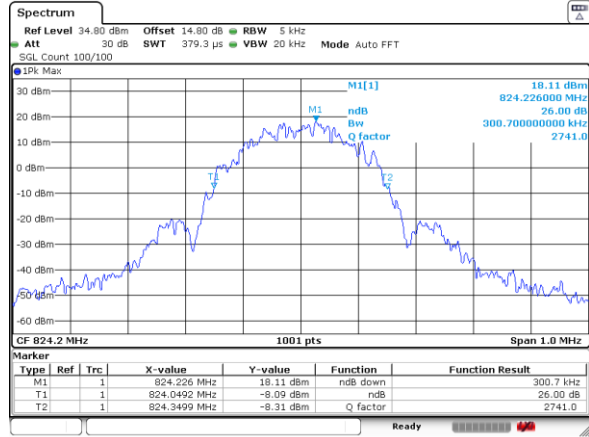

Date: 25 DEC 2021 00:03:08

Middle Channel

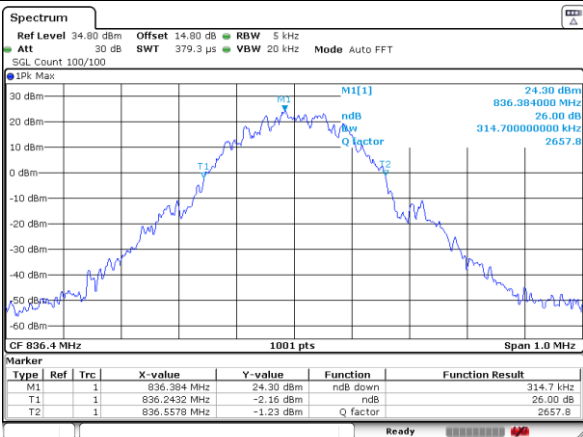

Date: 24 DEC 2021 22:39:10

Middle Channel

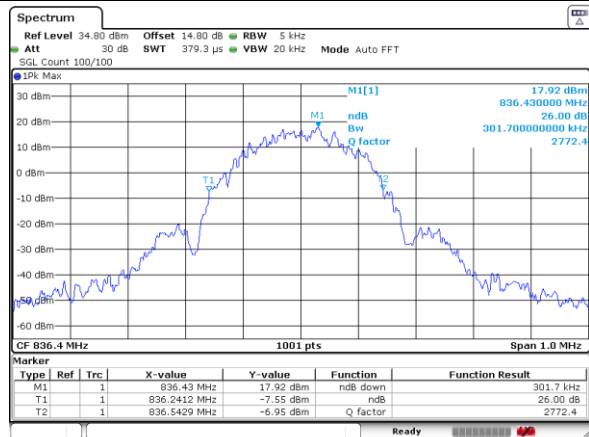

Date: 25 DEC 2021 00:04:07

Highest Channel

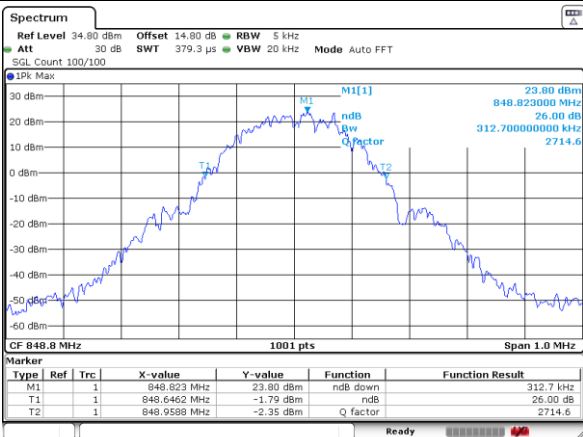

Date: 24 DEC 2021 22:40:00

Highest Channel

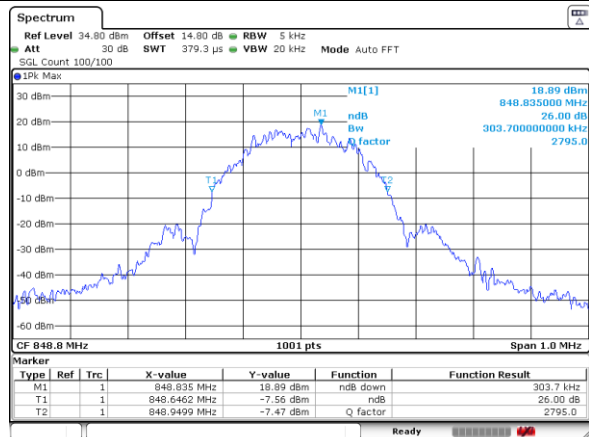

Date: 25 DEC 2021 00:04:55



GSM1900 (GSM)

Lowest Channel

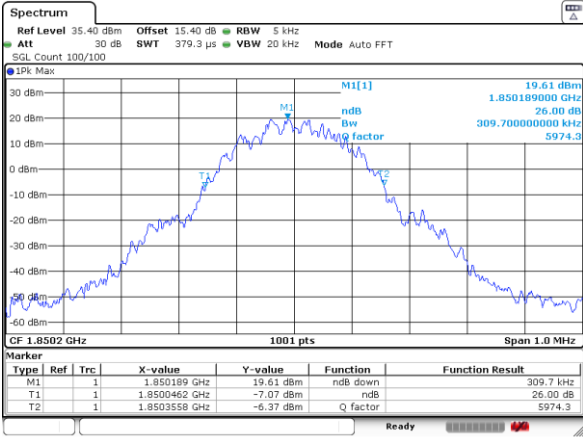

Date: 24 DEC 2021 23:36:36

GSM1900 (EDGE)

Lowest Channel

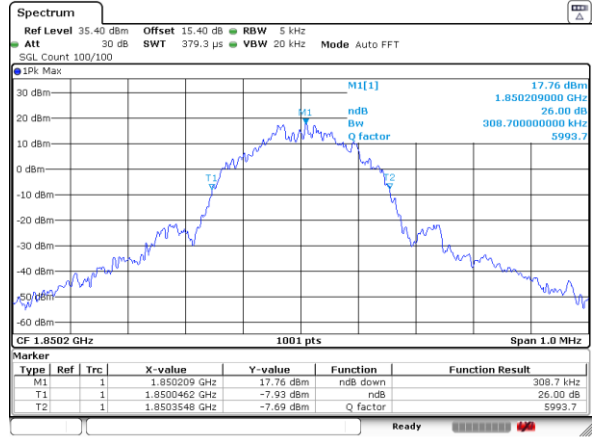

Date: 24 DEC 2021 23:42:34

Middle Channel

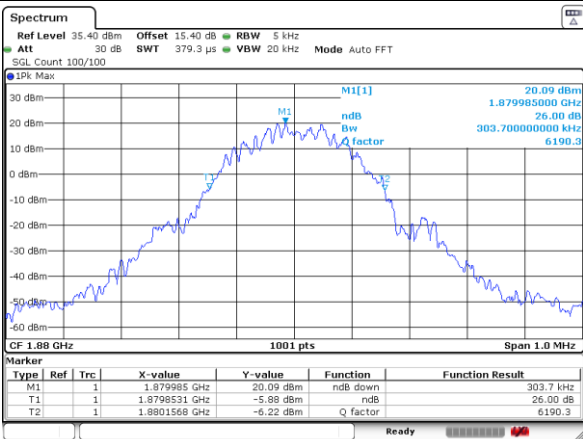

Date: 24 DEC 2021 23:37:39

Middle Channel

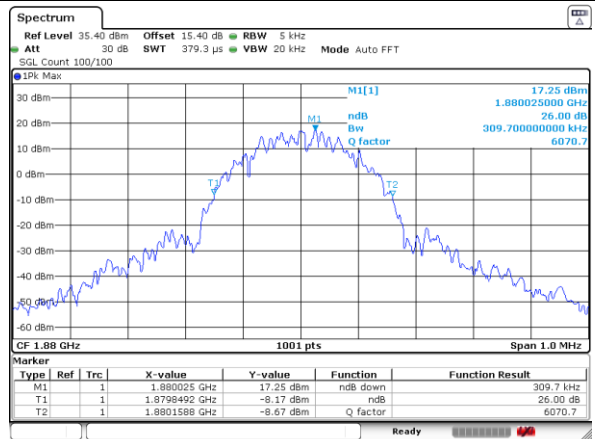

Date: 24 DEC 2021 23:43:32

Highest Channel

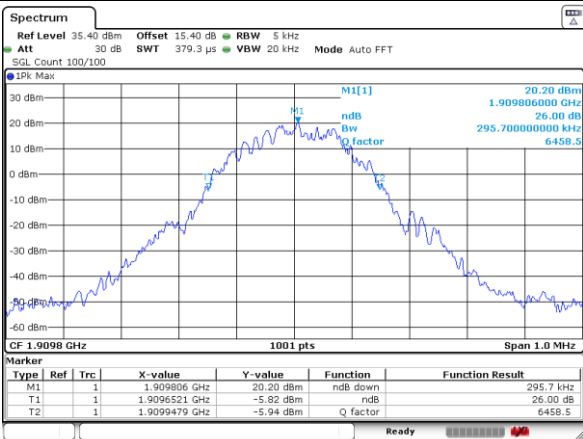

Date: 24 DEC 2021 23:38:28

Highest Channel



Date: 24 DEC 2021 23:44:15



Occupied Bandwidth

Mode	GSM850(MHz)	
Mod.	GSM	EDGE
Lowest CH	0.242	0.244
Middle CH	0.241	0.239
Highest CH	0.241	0.241

Mode	GSM1900(MHz)	
Mod.	GSM	EDGE
Lowest CH	0.242	0.244
Middle CH	0.241	0.246
Highest CH	0.242	0.244



GSM850 (GSM)

Lowest Channel

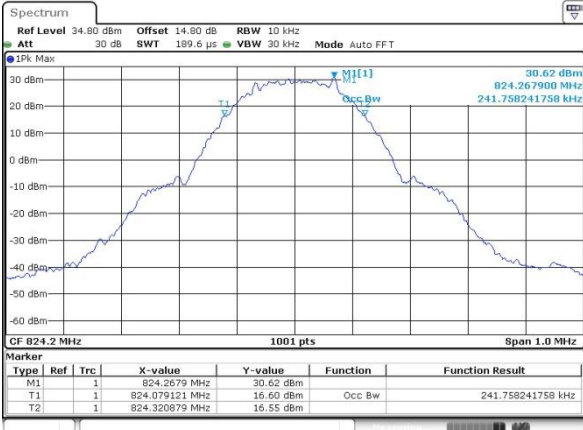

Date: 18_DEC.2021 05:44:46

GSM850 (EDGE)

Lowest Channel



Date: 18_DEC.2021 06:18:07

Middle Channel

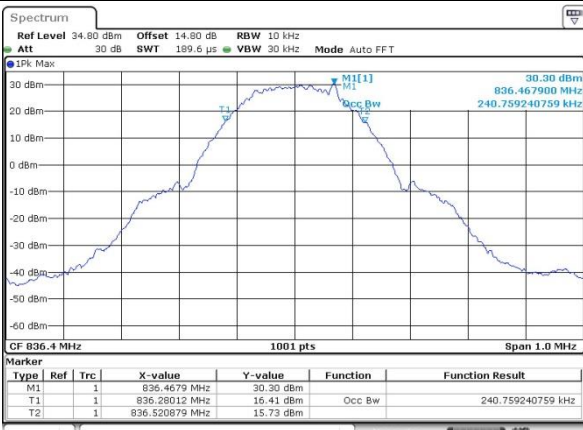

Date: 18_DEC.2021 05:45:09

Middle Channel

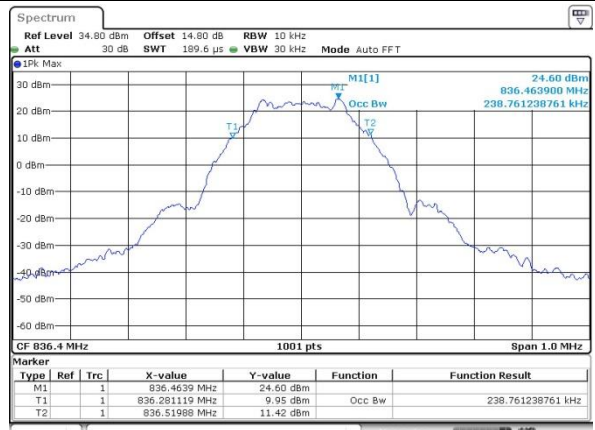

Date: 18_DEC.2021 06:18:29

Highest Channel

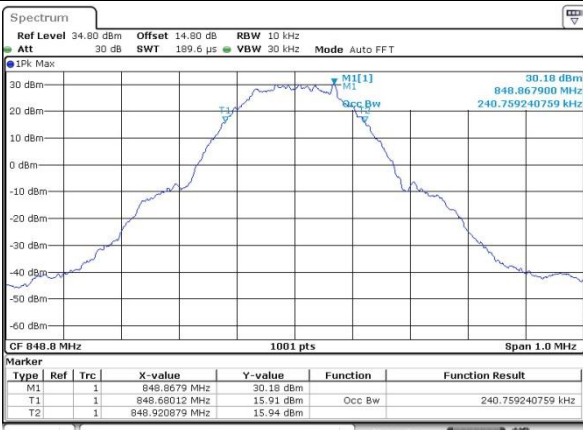

Date: 18_DEC.2021 05:45:31

Highest Channel

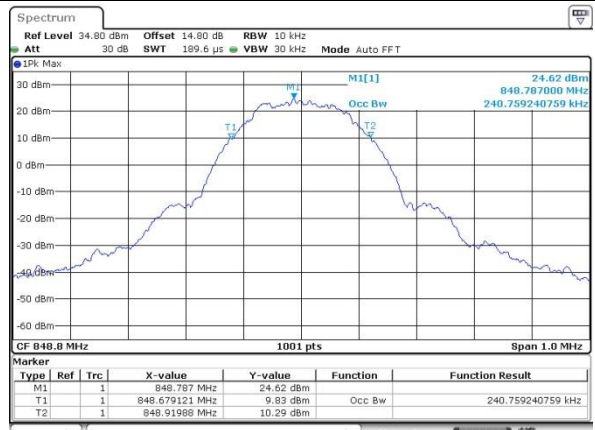

Date: 18_DEC.2021 06:18:50



GSM1900 (GSM)

Lowest Channel

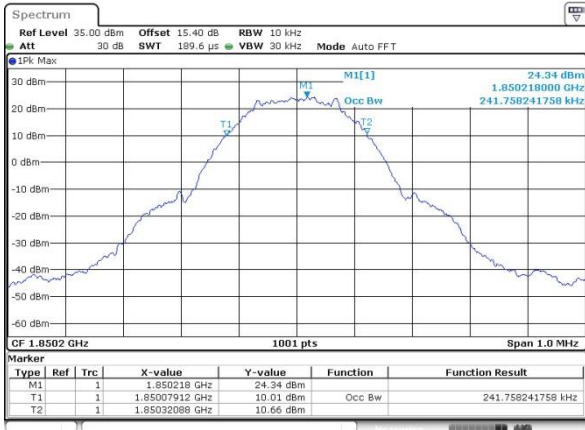

Date: 18_DEC.2021 06:38:44

GSM1900 (EDGE)

Lowest Channel

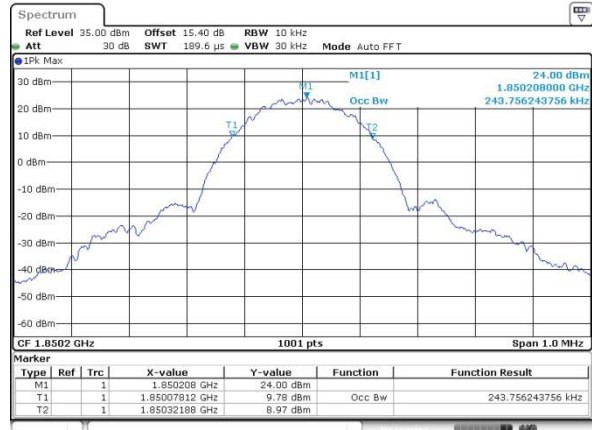

Date: 18_DEC.2021 07:02:15

Middle Channel

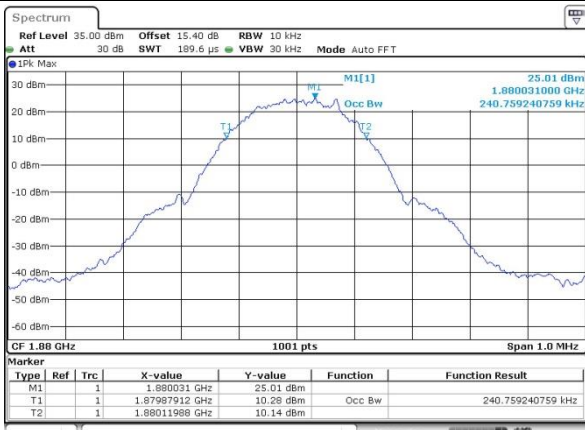

Date: 18_DEC.2021 06:39:11

Middle Channel

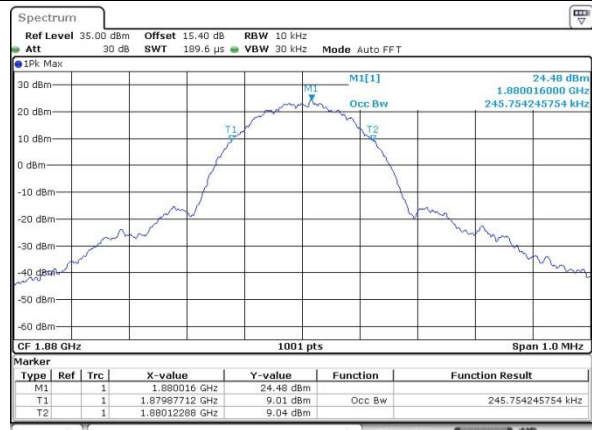

Date: 18_DEC.2021 07:02:37

Highest Channel

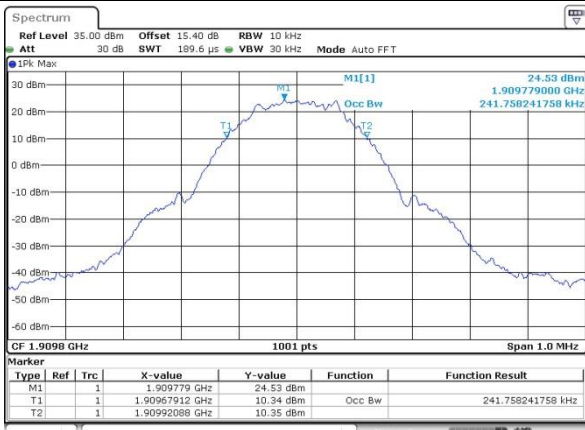

Date: 18_DEC.2021 06:39:47

Highest Channel

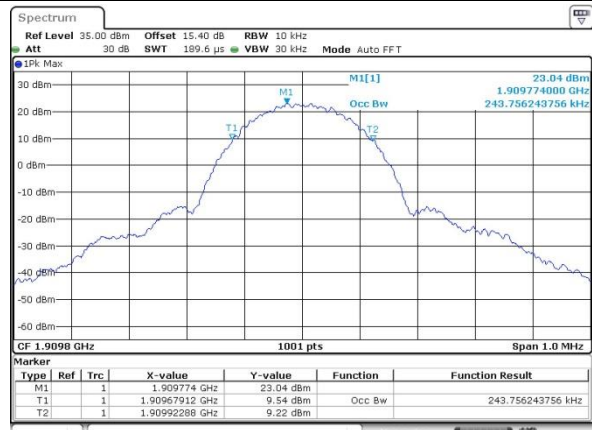

Date: 18_DEC.2021 07:03:04



Conducted Band Edge

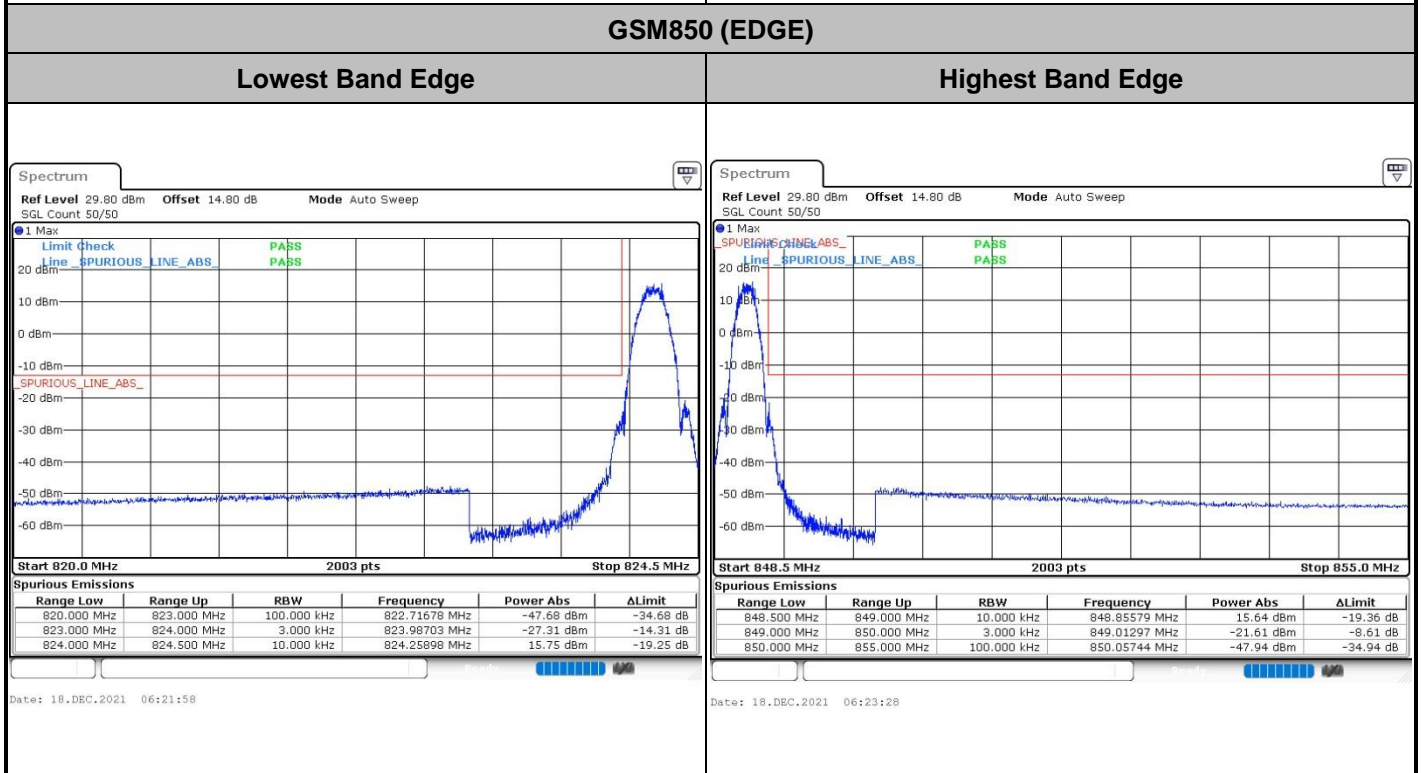
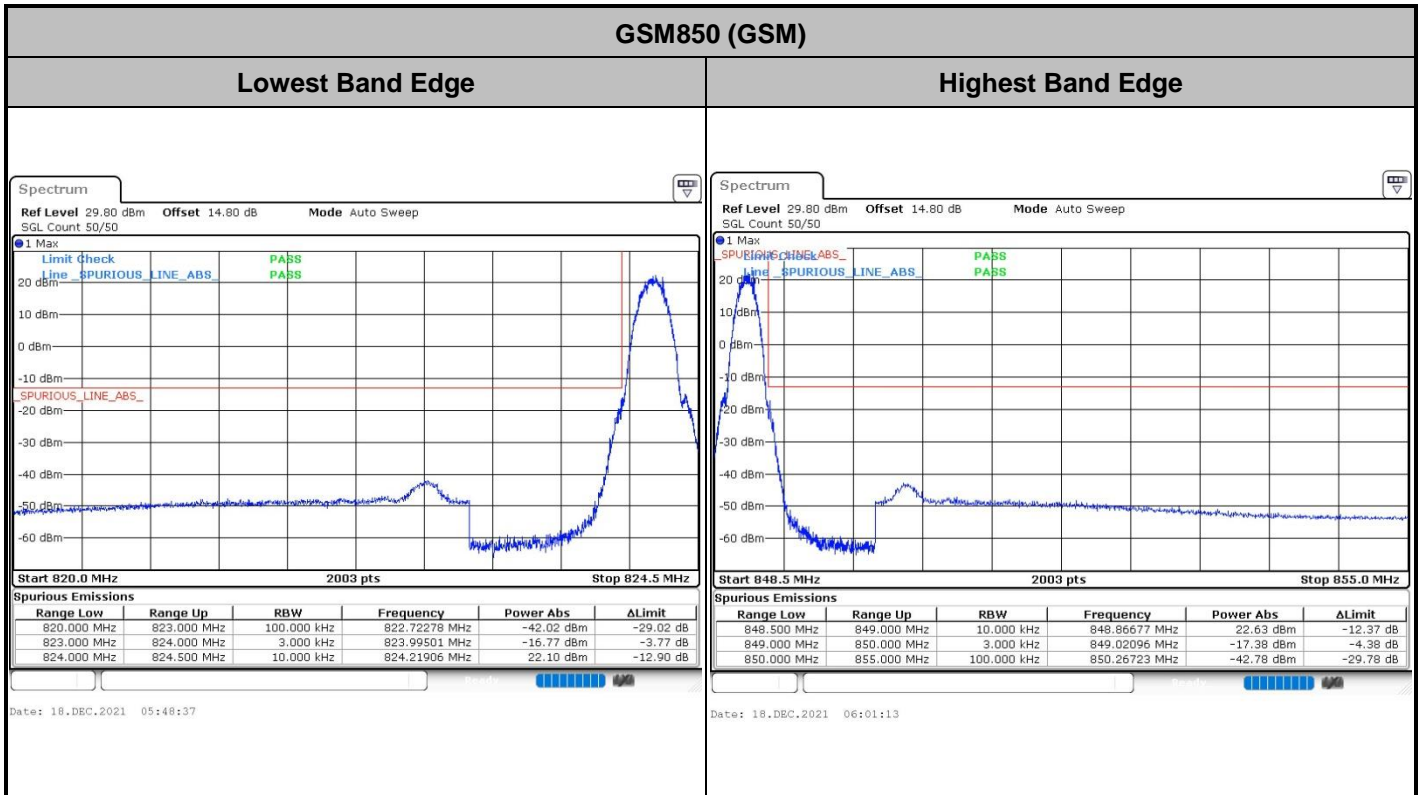



GSM1900 (GSM)

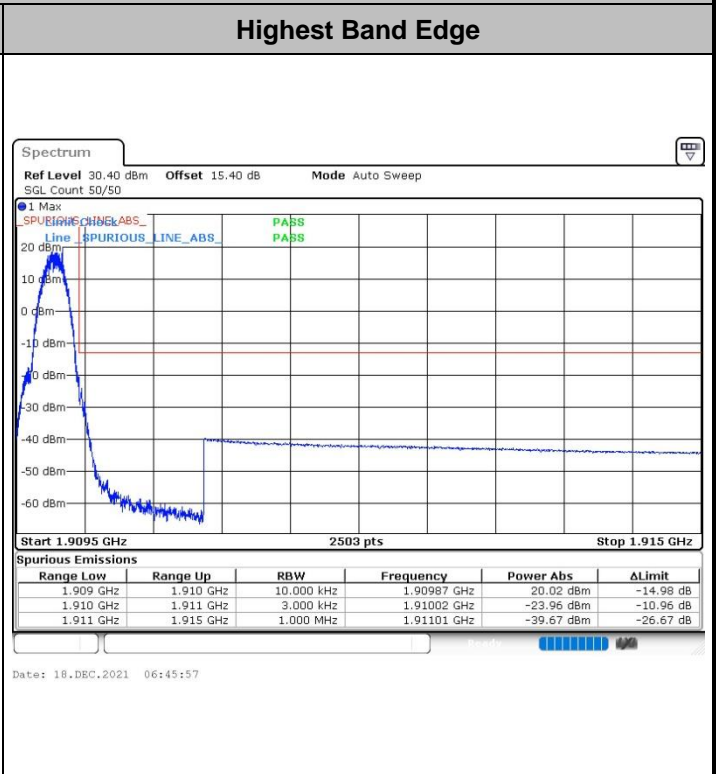
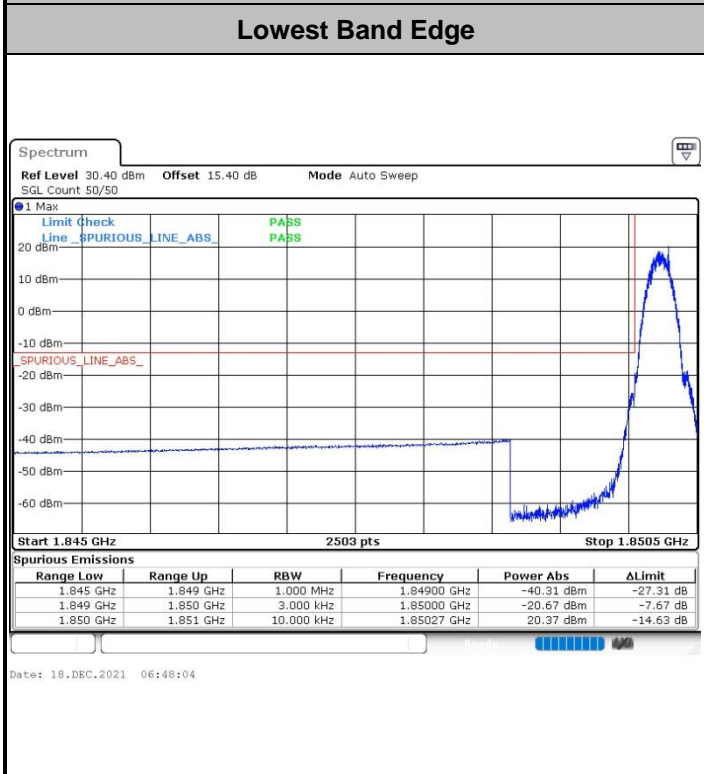

GSM1900 (EDGE)

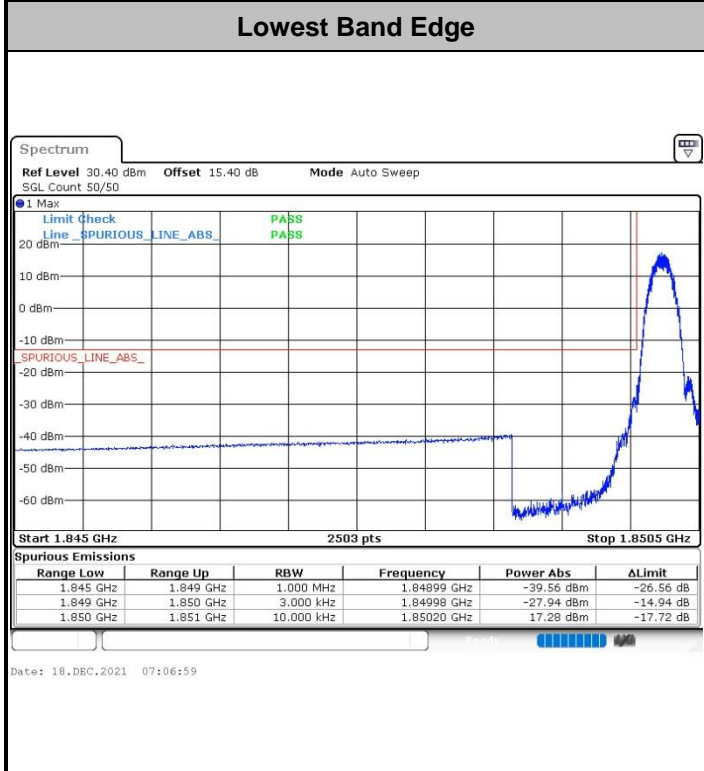



Conducted Spurious Emission

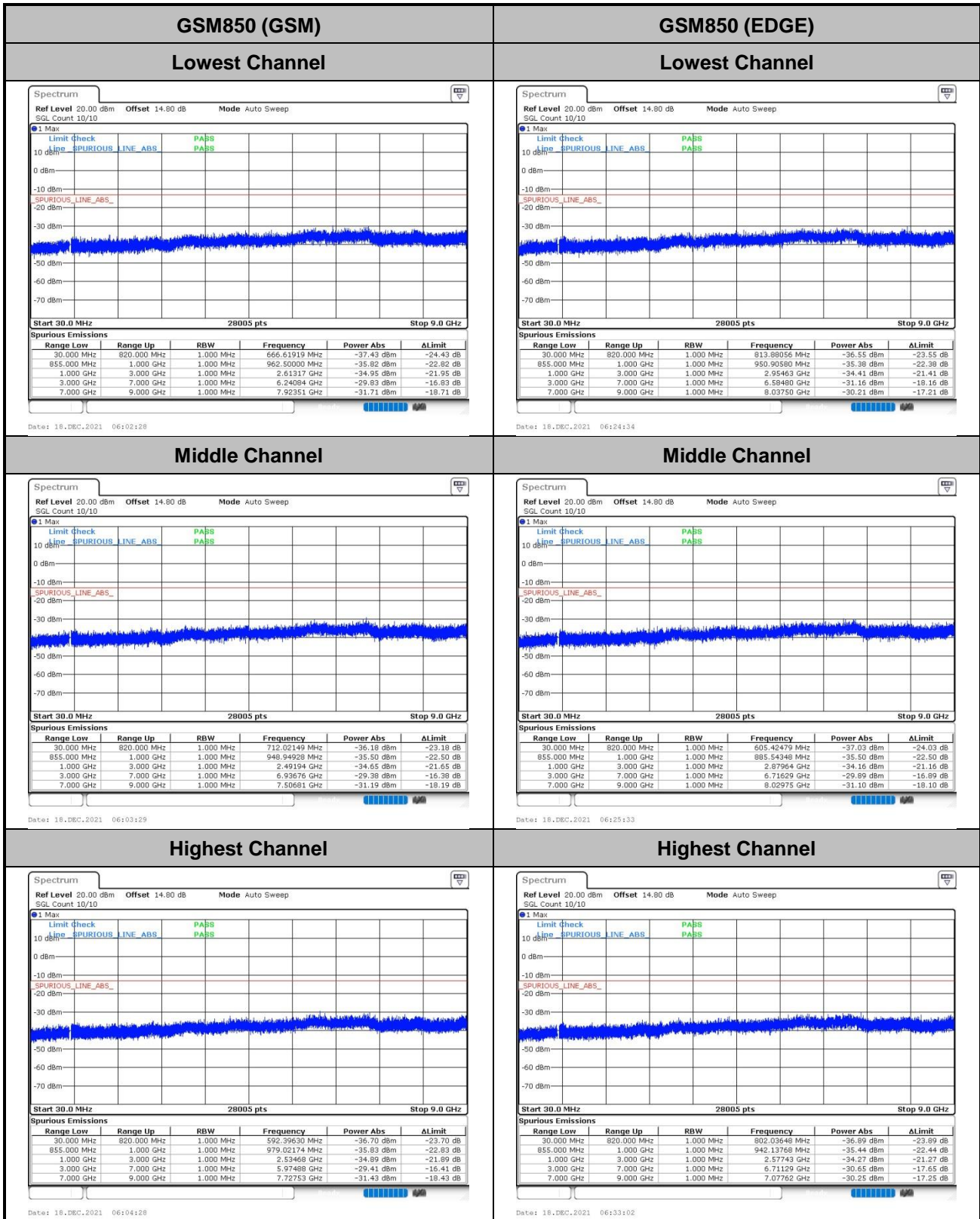



GSM1900 (GSM)

Lowest Channel

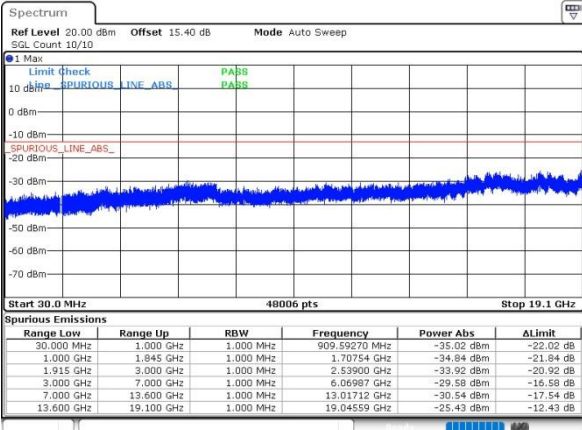

Date: 18. DEC. 2021 06:55:49

GSM1900 (EDGE)

Lowest Channel

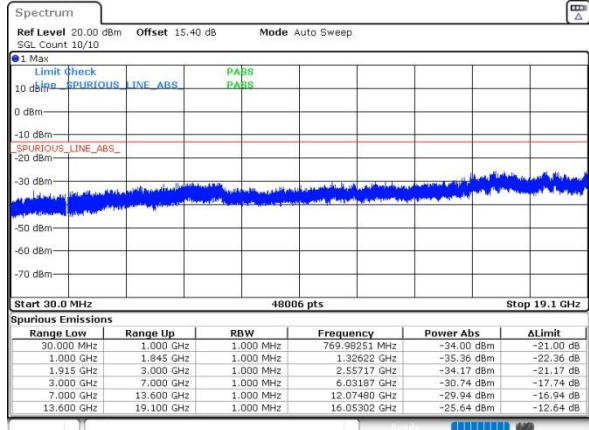

Date: 18. DEC. 2021 07:21:52

Middle Channel

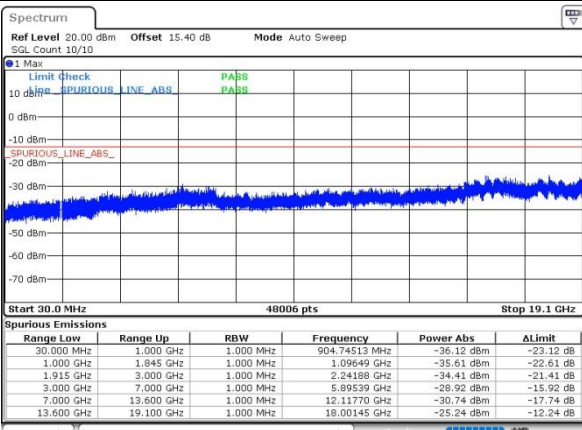

Date: 18. DEC. 2021 06:56:56

Middle Channel

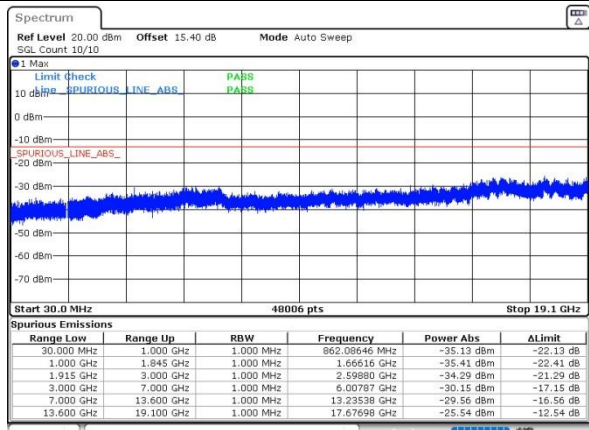

Date: 18. DEC. 2021 07:24:50

Highest Channel

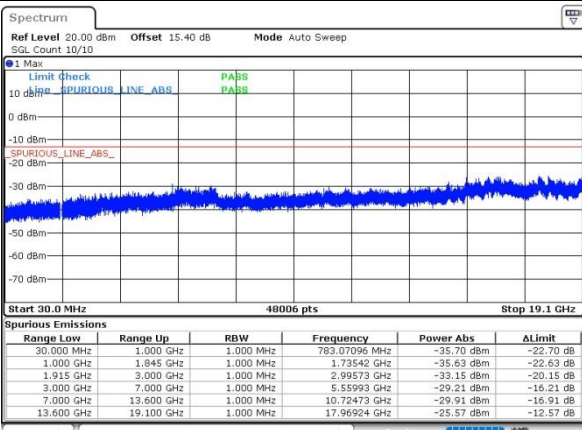

Date: 18. DEC. 2021 06:57:56

Highest Channel

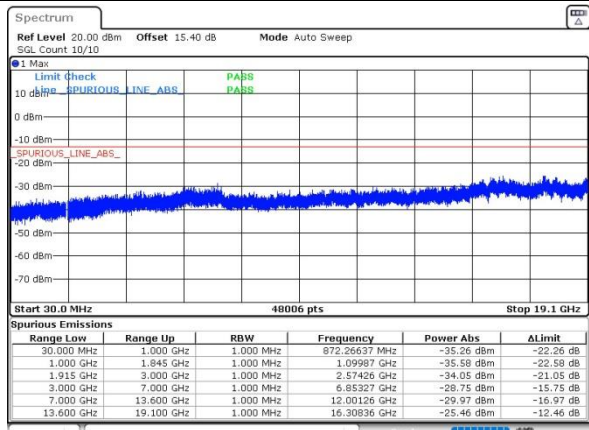

Date: 18. DEC. 2021 07:25:55



Frequency Stability

Test Conditions	Middle Channel	GSM850 (GSM)	GSM850 (EDGE)	Limit 2.5ppm
Temperature (°C)	Voltage (Volt)	Deviation (ppm)		Result
50	Normal Voltage	0.0122	0.0224	PASS
40	Normal Voltage	0.0032	0.0378	
30	Normal Voltage	0.0430	0.0144	
20(Ref.)	Normal Voltage	0.0000	0.0000	
10	Normal Voltage	0.0122	0.0125	
0	Normal Voltage	0.0068	0.0669	
-10	Normal Voltage	0.0252	0.0232	
-20	Normal Voltage	0.0625	0.0025	
-30	Normal Voltage	0.0165	0.0111	
20	Maximum Voltage	0.0121	0.0222	
20	Normal Voltage	0.0135	0.0323	
20	Battery End Point	0.0147	0.0021	

Note: Normal Voltage = 3.89V. ; Battery End Point (BEP) =3.4V. ; Maximum Voltage =4.48V



Test Conditions	Middle Channel	GSM1900 (GSM)	GSM1900 (EDGE)	Limit Note 2.
Temperature (°C)	Voltage (Volt)	Deviation (ppm)		Result
50	Normal Voltage	0.0022	0.0101	PASS
40	Normal Voltage	0.0014	0.0131	
30	Normal Voltage	0.0229	0.0112	
20(Ref.)	Normal Voltage	0.0000	0.0000	
10	Normal Voltage	0.0325	0.0102	
0	Normal Voltage	0.0126	0.0132	
-10	Normal Voltage	0.0188	0.0144	
-20	Normal Voltage	0.0031	0.0167	
-30	Normal Voltage	0.0111	0.0113	
20	Maximum Voltage	0.0165	0.0128	
20	Normal Voltage	0.0232	0.0122	
20	Battery End Point	0.0224	0.0007	

Note:

- 1. Normal Voltage = 3.89V. ; Battery End Point (BEP) =3.4V. ; Maximum Voltage =4.48V
- 2. The frequency fundamental emissions stay within the authorized frequency block based on the frequency deviation measured is small.



A2. WCDMA

Peak-to-Average Ratio

Mode	WCDMA Band V
Mod.	RMC 12.2Kbps
Lowest CH	3.36
Middle CH	3.16
Highest CH	3.19

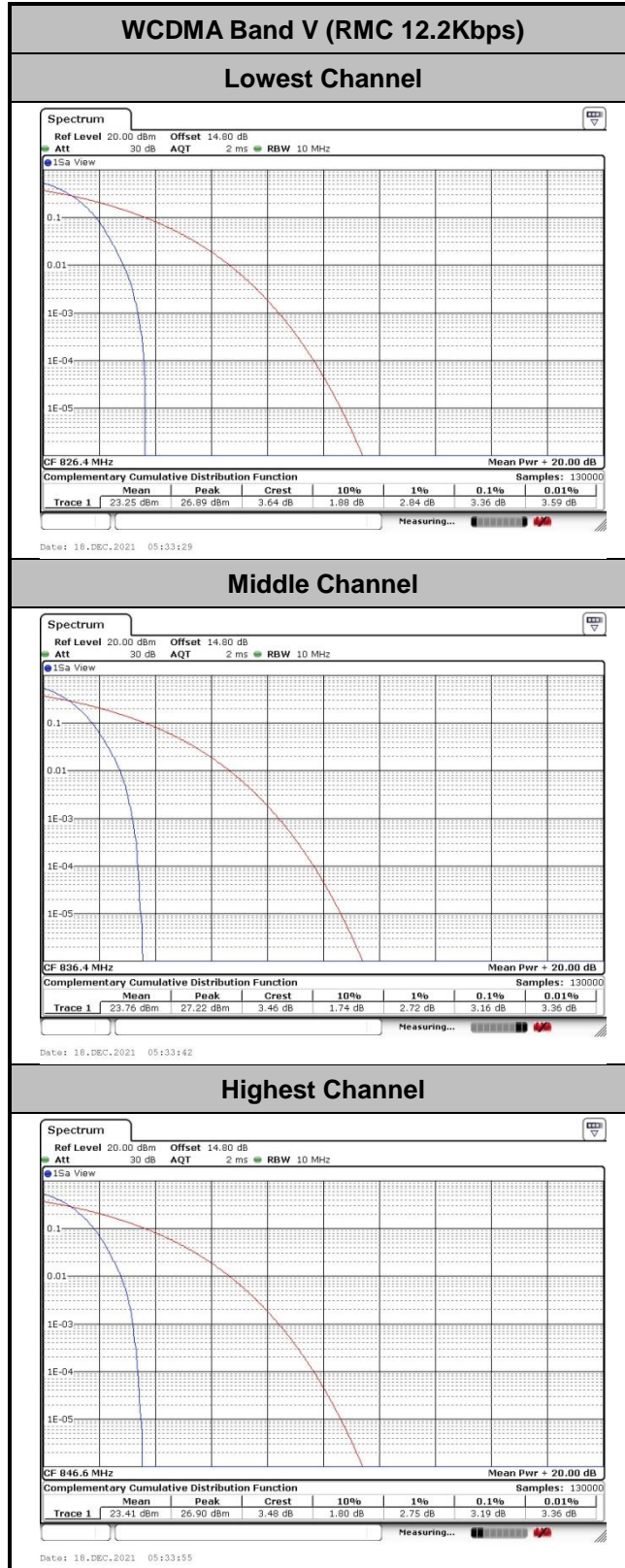



26dB Bandwidth

Mode	WCDMA Band V (MHz)
Mod.	RMC 12.2Kbps
Lowest CH	4.72
Middle CH	4.71
Highest CH	4.71

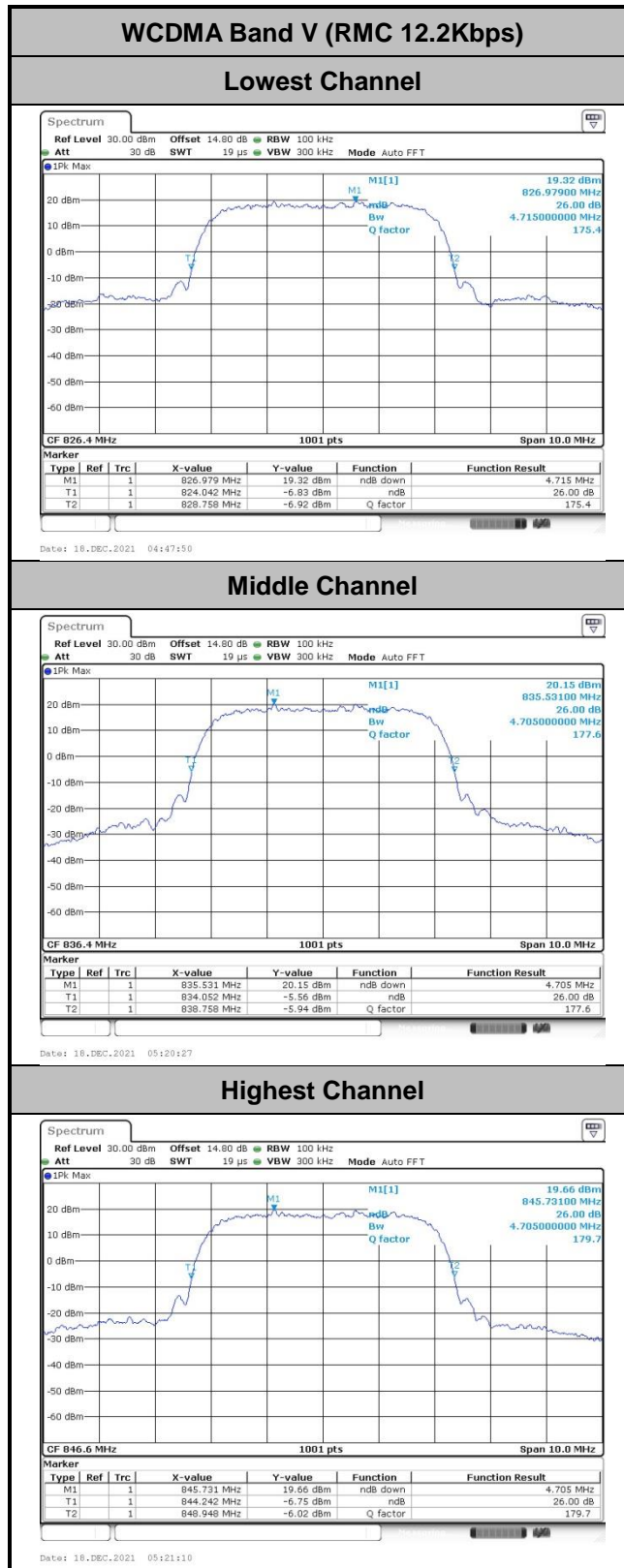



Occupied Bandwidth

Mode	WCDMA Band V (MHz)
Mod.	RMC 12.2Kbps
Lowest CH	4.14
Middle CH	4.13
Highest CH	4.13

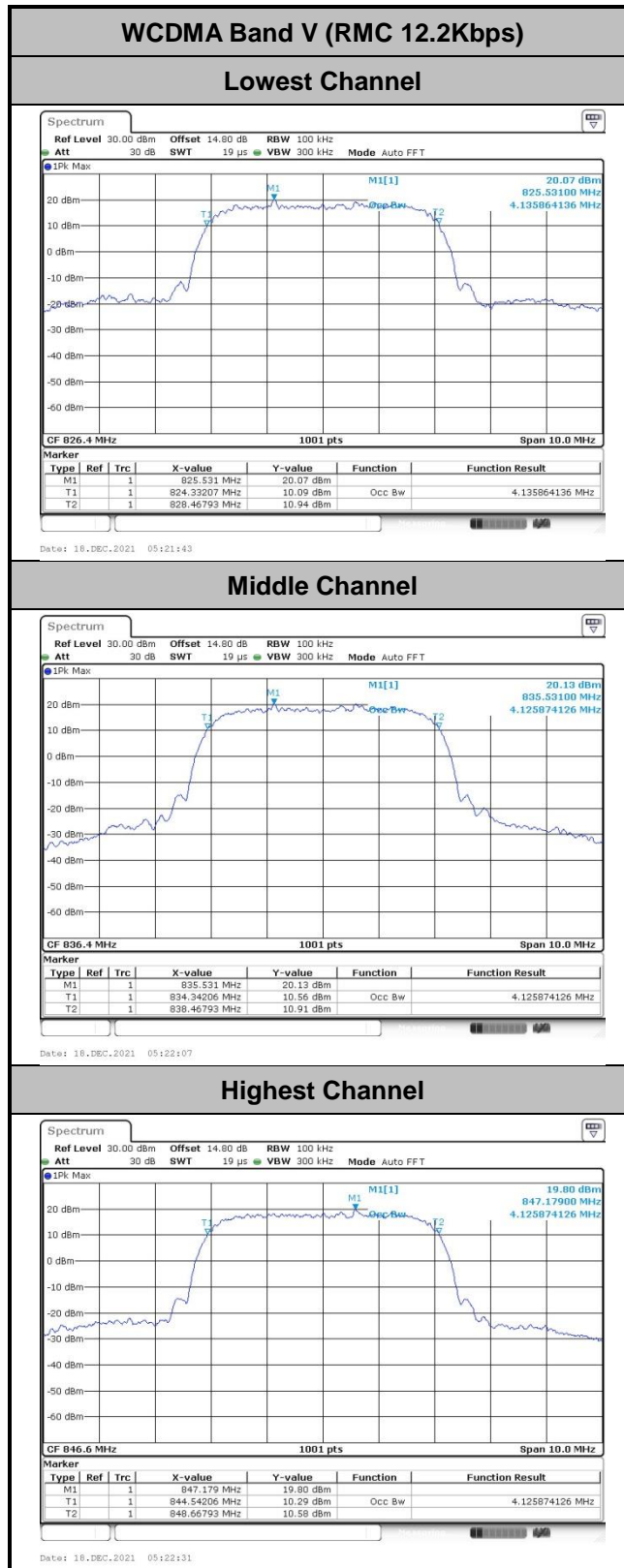



Conducted Band Edge

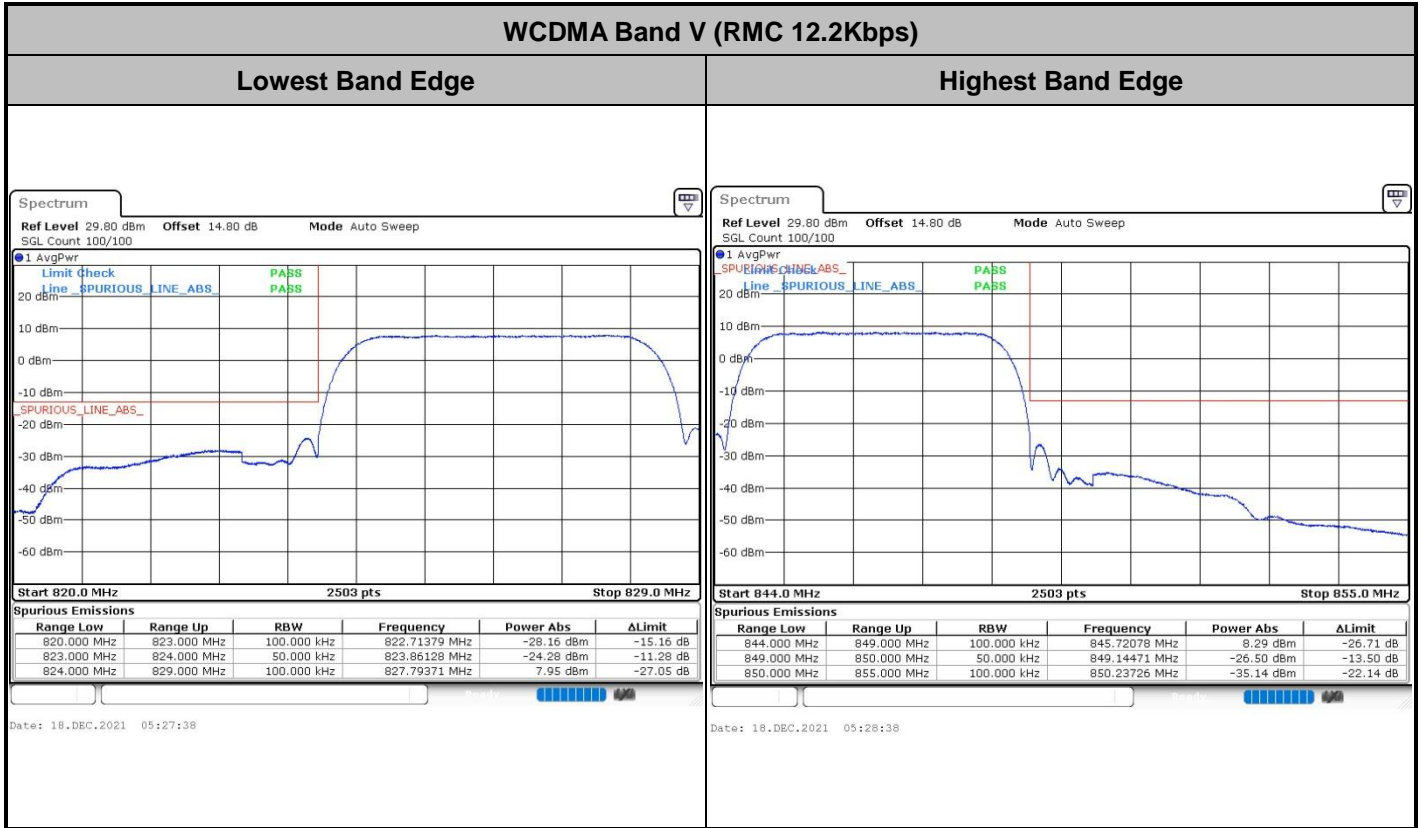



Conducted Spurious Emission

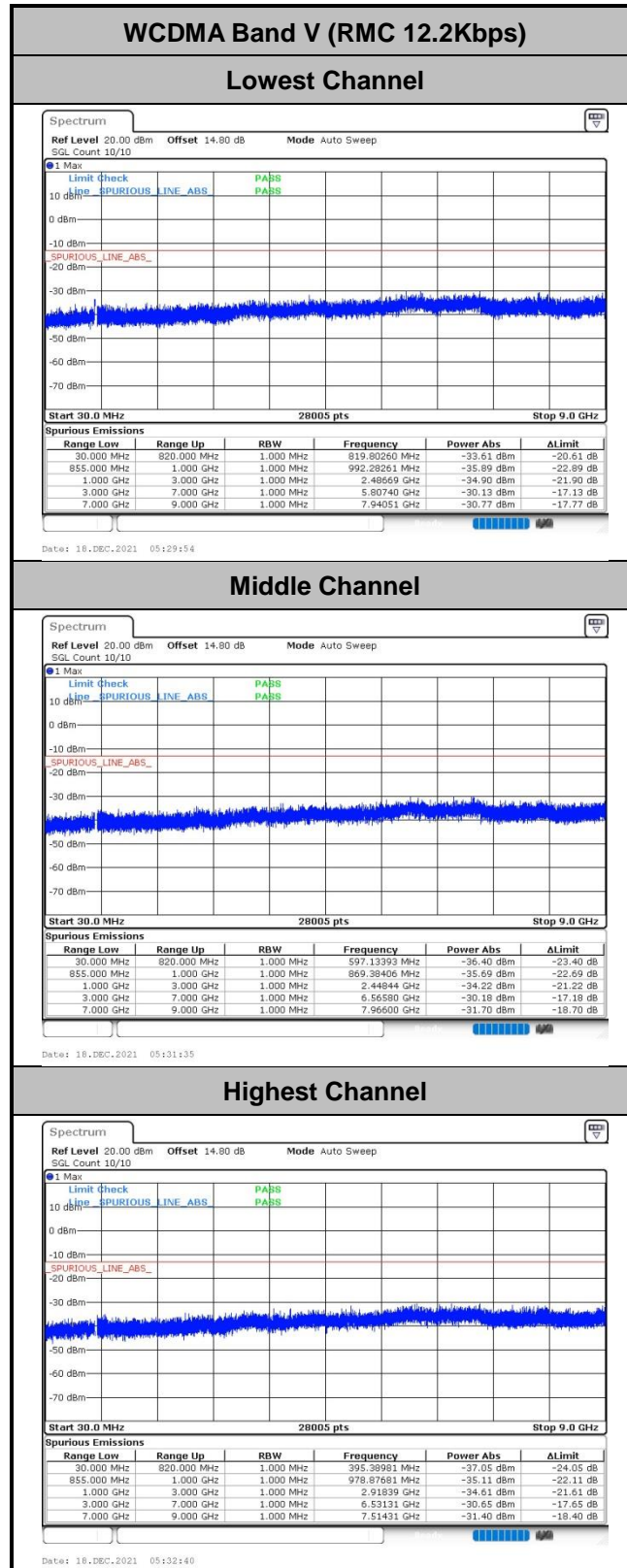



Frequency Stability

Test Conditions	Middle Channel	WCDMA Band V (RMC 12.2Kbps)	Limit
Temperature (°C)	Voltage (Volt)	Deviation (ppm)	2.5ppm Result
50	Normal Voltage	0.0021	PASS
40	Normal Voltage	0.0211	
30	Normal Voltage	0.0021	
20(Ref.)	Normal Voltage	0.0000	
10	Normal Voltage	0.0118	
0	Normal Voltage	0.0123	
-10	Normal Voltage	0.0035	
-20	Normal Voltage	0.0411	
-30	Normal Voltage	0.0118	
20	Maximum Voltage	0.0028	
20	Normal Voltage	0.0221	
20	Battery End Point	0.0123	

Note: Normal Voltage = 3.89V ; Battery End Point (BEP) =3.4V ; Maximum Voltage =4.48V



Appendix B. Test Results of Radiated Test

Radiated Spurious Emission

GSM850 (GSM)								
Channel	Frequency (MHz)	ERP (dBm)	Limit (dBm)	Over Limit (dB)	S.G. Power (dBm)	TX Cable loss (dB)	TX Antenna Gain (dBi)	Polarization (H/V)
Lowest	1648	-53.70	-13	-40.70	-60.67	1.58	10.70	H
	2472	-47.32	-13	-34.32	-55.57	2.102	12.50	H
	3296	-58.37	-13	-45.37	-67.26	2.856	13.90	H
	1648	-50.96	-13	-37.96	-57.93	1.58	10.70	V
	2472	-45.46	-13	-32.46	-53.71	2.10	12.50	V
	3296	-58.82	-13	-45.82	-67.71	2.86	13.90	V
Middle	1672	-51.66	-13	-38.66	-58.63	1.58	10.70	H
	2512	-43.27	-13	-30.27	-51.52	2.102	12.50	H
	3344	-59.15	-13	-46.15	-68.04	2.856	13.90	H
	1672	-49.87	-13	-36.87	-56.84	1.58	10.70	V
	2512	-45.88	-13	-32.88	-54.13	2.10	12.50	V
	3344	-59.22	-13	-46.22	-68.11	2.86	13.90	V
Highest	1696	-50.75	-13	-37.75	-57.72	1.58	10.70	H
	2544	-45.91	-13	-32.91	-54.16	2.102	12.50	H
	3392	-58.94	-13	-45.94	-67.83	2.856	13.90	H
	1696	-53.66	-13	-40.66	-60.63	1.58	10.70	V
	2544	-45.78	-13	-32.78	-54.03	2.10	12.50	V
	3392	-59.54	-13	-46.54	-68.43	2.86	13.90	V

Remark: Spurious emissions within 30-1000MHz were found more than 20dB below limit line.



GSM850 (EDGE)								
Channel	Frequency (MHz)	ERP (dBm)	Limit (dBm)	Over Limit (dB)	S.G. Power (dBm)	TX Cable loss (dB)	TX Antenna Gain (dBi)	Polarization (H/V)
Lowest	1648	-53.87	-13	-40.87	-60.84	1.58	10.70	H
	2472	-46.00	-13	-33.00	-54.25	2.102	12.50	H
	3296	-58.56	-13	-45.56	-67.45	2.856	13.90	H
	1648	-56.64	-13	-43.64	-63.61	1.58	10.70	V
	2472	-42.13	-13	-29.13	-50.38	2.10	12.50	V
	3296	-59.20	-13	-46.20	-68.09	2.86	13.90	V
Middle	1672	-50.76	-13	-37.76	-57.73	1.58	10.70	H
	2512	-45.67	-13	-32.67	-53.92	2.102	12.50	H
	3344	-59.16	-13	-46.16	-68.05	2.856	13.90	H
	1672	-52.43	-13	-39.43	-59.40	1.58	10.70	V
	2512	-48.07	-13	-35.07	-56.32	2.10	12.50	V
	3344	-59.49	-13	-46.49	-68.38	2.86	13.90	V
Highest	1696	-51.09	-13	-38.09	-58.06	1.58	10.70	H
	2544	-46.15	-13	-33.15	-54.40	2.102	12.50	H
	3392	-59.20	-13	-46.20	-68.09	2.856	13.90	H
	1696	-51.99	-13	-38.99	-58.96	1.58	10.70	V
	2544	-46.23	-13	-33.23	-54.48	2.10	12.50	V
	3392	-59.60	-13	-46.60	-68.49	2.86	13.90	V

Remark: Spurious emissions within 30-1000MHz were found more than 20dB below limit line.

WCDMA Band V(RMC 12.2Kbps)								
Channel	Frequency (MHz)	ERP (dBm)	Limit (dBm)	Over Limit (dB)	S.G. Power (dBm)	TX Cable loss (dB)	TX Antenna Gain (dBi)	Polarization (H/V)
Lowest	1656	-63.42	-13	-50.42	-70.39	1.58	10.70	H
	2480	-60.22	-13	-47.22	-68.47	2.102	12.50	H
	3304	-59.26	-13	-46.26	-68.15	2.856	13.90	H
	1656	-63.22	-13	-50.22	-70.19	1.58	10.70	V
	2480	-58.41	-13	-45.41	-66.66	2.10	12.50	V
	3304	-59.29	-13	-46.29	-68.18	2.86	13.90	V
Middle	1672	-62.79	-13	-49.79	-69.76	1.58	10.70	H
	2512	-59.29	-13	-46.29	-67.54	2.102	12.50	H
	3344	-59.50	-13	-46.50	-68.39	2.856	13.90	H
	1672	-62.96	-13	-49.96	-69.93	1.58	10.70	V
	2512	-58.84	-13	-45.84	-67.09	2.10	12.50	V
	3344	-59.75	-13	-46.75	-68.64	2.86	13.90	V
Highest	1696	-63.65	-13	-50.65	-70.62	1.58	10.70	H
	2544	-58.89	-13	-45.89	-67.14	2.102	12.50	H
	3384	-59.79	-13	-46.79	-68.68	2.856	13.90	H
	1696	-63.06	-13	-50.06	-70.03	1.58	10.70	V
	2544	-58.64	-13	-45.64	-66.89	2.10	12.50	V
	3384	-60.14	-13	-47.14	-69.03	2.86	13.90	V

Remark: Spurious emissions within 30-1000MHz were found more than 20dB below limit line.



GSM1900 (GSM)								
Channel	Frequency (MHz)	EIRP (dBm)	Limit (dBm)	Over Limit (dB)	S.G. Power (dBm)	TX Cable loss (dB)	TX Antenna Gain (dBi)	Polarization (H/V)
Lowest	3705	-49.92	-13	-36.92	-62.18	2.641	14.90	H
	5550	-50.64	-13	-37.64	-62.50	2.94	14.80	H
	7395	-50.95	-13	-37.95	-60.72	3.39	13.16	H
	3705	-54.13	-13	-41.13	-66.39	2.64	14.90	V
	5550	-51.23	-13	-38.23	-63.09	2.94	14.80	V
	7395	-51.34	-13	-38.34	-61.11	3.39	13.16	V
Middle	3765	-50.25	-13	-37.25	-62.51	2.641	14.90	H
	5640	-48.92	-13	-35.92	-60.78	2.94	14.80	H
	7515	-51.59	-13	-38.59	-61.36	3.39	13.16	H
	3765	-53.23	-13	-40.23	-65.49	2.64	14.90	V
	5640	-50.91	-13	-37.91	-62.77	2.94	14.80	V
	7515	-51.46	-13	-38.46	-61.23	3.39	13.16	V
Highest	3825	-46.04	-13	-33.04	-58.30	2.641	14.90	H
	5730	-46.65	-13	-33.65	-58.51	2.94	14.80	H
	7635	-50.74	-13	-37.74	-60.51	3.39	13.16	H
	3825	-52.36	-13	-39.36	-64.62	2.64	14.90	V
	5730	-46.55	-13	-33.55	-58.41	2.94	14.80	V
	7635	-51.05	-13	-38.05	-60.82	3.39	13.16	V

Remark: Spurious emissions within 30-1000MHz were found more than 20dB below limit line.

GSM1900 (EDGE)								
Channel	Frequency (MHz)	EIRP (dBm)	Limit (dBm)	Over Limit (dB)	S.G. Power (dBm)	TX Cable loss (dB)	TX Antenna Gain (dBi)	Polarization (H/V)
Lowest	3705	-56.68	-13	-43.68	-68.94	2.641	14.90	H
	5550	-52.76	-13	-39.76	-64.62	2.94	14.80	H
	7515	-53.35	-13	-40.35	-63.12	3.39	13.16	H
	3705	-49.47	-13	-36.47	-61.73	2.64	14.90	V
	5550	-49.56	-13	-36.56	-61.42	2.94	14.80	V
	7515	-52.92	-13	-39.92	-62.69	3.39	13.16	V
Middle	3765	-52.55	-13	-39.55	-64.81	2.641	14.90	H
	5640	-51.91	-13	-38.91	-63.77	2.94	14.80	H
	7515	-52.62	-13	-39.62	-62.39	3.39	13.16	H
	3765	-54.27	-13	-41.27	-66.53	2.64	14.90	V
	5640	-50.71	-13	-37.71	-62.57	2.94	14.80	V
	7515	-52.87	-13	-39.87	-62.64	3.39	13.16	V
Highest	3825	-54.88	-13	-41.88	-67.14	2.64	14.90	H
	5730	-46.79	-13	-33.79	-58.65	2.94	14.80	H
	7515	-53.17	-13	-40.17	-62.94	3.39	13.16	H
	3825	-57.47	-13	-44.47	-69.73	2.64	14.90	V
	5730	-55.74	-13	-42.74	-67.60	2.94	14.80	V
	7515	-53.29	-13	-40.29	-63.06	3.39	13.16	V

Remark: Spurious emissions within 30-1000MHz were found more than 20dB below limit line.

————THE END————