



# FCC RADIO TEST REPORT

FCC ID : PY7-34943G  
Equipment : GSM/WCDMA/LTE Phone with BT, DTS/UNII  
a/b/g/n/ac, NFC and GNSS  
Brand Name : SONY  
Applicant : Sony Corporation  
1-7-1 Konan Minato-ku Tokyo, 108-0076 Japan  
Manufacturer : Sony Corporation  
1-7-1 Konan Minato-ku Tokyo, 108-0076 Japan  
Standard : FCC Part 15 Subpart C §15.247  
Test Date(s) : Dec. 20, 2021 ~ Jan. 28, 2022

We, Sporton International Inc. (Kunshan), would like to declare that the tested sample has been evaluated in accordance with the test procedures and has been in compliance with the applicable technical standards.

The test results in this report apply exclusively to the tested model / sample. Without written approval of Sporton International Inc. (Kunshan), the test report shall not be reproduced except in full.

Jason Jia

Reviewed by: Jason Jia / Supervisor

Alex Wang

Approved by: Alex Wang / Manager



**Sporton International Inc. (Kunshan)**

No. 1098, Pengxi North Road, Kunshan Economic Development Zone Jiangsu Province 215300  
People's Republic of China



# Table of Contents

**History of this test report..... 3**

**Summary of Test Result..... 4**

**1 General Description..... 5**

    1.1 Product Feature of Equipment Under Test..... 5

    1.2 Modification of EUT ..... 5

    1.3 Testing Location ..... 5

    1.4 Applicable Standards..... 6

**2 Test Configuration of Equipment Under Test ..... 7**

    2.1 Carrier Frequency Channel ..... 7

    2.2 Test Mode..... 8

    2.3 Connection Diagram of Test System..... 9

    2.4 Support Unit used in test configuration and system ..... 10

    2.5 EUT Operation Test Setup ..... 10

    2.6 Measurement Results Explanation Example..... 10

**3 Test Result..... 11**

    3.1 6dB and 99% Bandwidth Measurement ..... 11

    3.2 Output Power Measurement..... 16

    3.3 Power Spectral Density Measurement ..... 17

    3.4 Conducted Band Edges and Spurious Emission Measurement ..... 22

    3.5 Radiated Band Edges and Spurious Emission Measurement ..... 27

    3.6 AC Conducted Emission Measurement..... 32

    3.7 Antenna Requirements..... 34

**4 List of Measuring Equipment ..... 35**

**5 Uncertainty of Evaluation ..... 36**

**Appendix A. Conducted Test Results**

**Appendix B. AC Conducted Emission Test Result**

**Appendix C. Radiated Spurious Emission**

**Appendix D. Radiated Spurious Emission Plots**

**Appendix E. Duty Cycle Plots**





### Summary of Test Result

Report Clause	Ref Std. Clause	Test Items	Result (PASS/FAIL)	Remark
3.1	15.247(a)(2)	6dB Bandwidth	Pass	-
3.1	2.1049	99% Occupied Bandwidth	Reporting only	-
3.2	15.247(b)(3)	Output Power	Pass	-
3.3	15.247(e)	Power Spectral Density	Pass	-
3.4	15.247(d)	Conducted Band Edges and Spurious Emission	Pass	-
3.5	15.247(d)	Radiated Band Edges and Spurious Emission	Pass	Under limit 6.01 dB at 2483.500 MHz
3.6	15.207	AC Conducted Emission	Pass	Under limit 13.53 dB at 0.209 MHz
3.7	15.203 & 15.247(b)	Antenna Requirement	Pass	-

**Declaration of Conformity:**

The test results with all measurement uncertainty excluded are presented in accordance with the regulation limits or requirements declared by manufacturers.

**Comments and Explanations:**

The declared of product specification for EUT presented in the report are provided by the manufacturer, and the manufacturer takes all the responsibilities for the accuracy of product specification.



# 1 General Description

## 1.1 Product Feature of Equipment Under Test

GSM/WCDMA/LTE, Bluetooth, DTS/UNII a/b/g/n/ac, NFC and GNSS.

Standards-related Product Specification	
Antenna Type / Gain	Ant. 6: PIFA Antenna with gain 2.3 dBi

Remark: The above EUT's information was declared by manufacturer. Please refer to Comments and Explanations in report summary.

EUT Information List			
HW Version	SW Version	IMEI Code	Performed Test Item
A	0.549	004402543254167/ 004402543254175	RF conducted measurement
		004402543253961	Radiated Spurious Emission
		004402543254142/ 004402543254159	AC Conducted Emission

Note: For other wireless features of this EUT, test report will be issued separately.

## 1.2 Modification of EUT

No modifications are made to the EUT during all test items.

## 1.3 Testing Location

Sporton International Inc. (Kunshan) is accredited to ISO/IEC 17025:2017 by American Association for Laboratory Accreditation with Certificate Number 5145.02.

Test Firm	Sporton International Inc. (Kunshan)		
Test Site Location	No. 1098, Pengxi North Road, Kunshan Economic Development Zone Jiangsu Province 215300 People's Republic of China TEL : +86-512-57900158 FAX : +86-512-57900958		
Test Site No.	Sporton Site No.	FCC Designation No.	FCC Test Firm Registration No.
	CO01-KS 03CH06-KS TH01-KS	CN1257	314309



## 1.4 Applicable Standards

According to the specifications of the manufacturer, the EUT must comply with the requirements of the following standards:

- ♦ FCC Part 15 Subpart C §15.247
- ♦ FCC KDB Publication No. 558074 D01 DTS Meas. Guidance v05r02
- ♦ FCC KDB 414788 D01 Radiated Test Site v01r01
- ♦ ANSI C63.10-2013

### **Remark:**

1. All test items were verified and recorded according to the standards and without any deviation during the test.
2. This EUT has also been tested and complied with the requirements of FCC Part 15, Subpart B, recorded in a separate test report.



## 2 Test Configuration of Equipment Under Test

### 2.1 Carrier Frequency Channel

Frequency Band	Channel	Freq. (MHz)	Channel	Freq. (MHz)
2400-2483.5 MHz	0	2402	21	2444
	1	2404	22	2446
	2	2406	23	2448
	3	2408	24	2450
	4	2410	25	2452
	5	2412	26	2454
	6	2414	27	2456
	7	2416	28	2458
	8	2418	29	2460
	9	2420	30	2462
	10	2422	31	2464
	11	2424	32	2466
	12	2426	33	2468
	13	2428	34	2470
	14	2430	35	2472
	15	2432	36	2474
	16	2434	37	2476
	17	2436	38	2478
	18	2438	39	2480
	19	2440	-	-
	20	2442	-	-



### 2.2 Test Mode

- a. The EUT has been associated with peripherals and configuration operated in a manner tended to maximize its emission characteristics in a typical application. Frequency range investigated: conduction emission (150 kHz to 30 MHz), radiation emission (9 kHz to the 10th harmonic of the highest fundamental frequency or to 40 GHz, whichever is lower). For radiated measurement, the measured emission level of the EUT was maximized by rotating the EUT on a turntable, adjusting the orientation of the EUT and EUT antenna in three orthogonal axis (X: flat, Y: portrait, Z: landscape), and adjusting the measurement antenna orientation, following C63.10 exploratory test procedures and find X plane as worst plane. The worst case position of the EUT was investigated under two configurations: EUT with AC adapter and earphone, EUT with standalone. The EUT with standalone configuration was determined to be worst-case configurations; therefore, all final tests were performed on the EUT with standalone.
- b. AC power line Conducted Emission was tested under maximum output power.

The following summary table is showing all test modes to demonstrate in compliance with the standard.

Summary table of Test Cases	
Test Item	Data Rate / Modulation
<b>Conducted Test Cases</b>	<b>Bluetooth LE / GFSK</b>
	Mode 1: Bluetooth Tx CH00_2402 MHz_1Mbps
	Mode 2: Bluetooth Tx CH19_2440 MHz_1Mbps
	Mode 3: Bluetooth Tx CH39_2480 MHz_1Mbps
	Mode 4: Bluetooth Tx CH00_2402 MHz_2Mbps
	Mode 5: Bluetooth Tx CH19_2440 MHz_2Mbps
	Mode 6: Bluetooth Tx CH39_2480 MHz_2Mbps
<b>Radiated Test Cases</b>	Mode 1: Bluetooth Tx CH00_2402 MHz_1Mbps
	Mode 2: Bluetooth Tx CH19_2440 MHz_1Mbps
	Mode 3: Bluetooth Tx CH39_2480 MHz_1Mbps
	Mode 4: Bluetooth Tx CH00_2402 MHz_2Mbps
	Mode 5: Bluetooth Tx CH19_2440 MHz_2Mbps
	Mode 6: Bluetooth Tx CH39_2480 MHz_2Mbps
<b>AC Conducted Emission</b>	Mode 1 : GSM850 Idle + Bluetooth Link + WLAN (2.4GHz) Link + Earphone + USB Cable 1(Charging from Adapter)



## 2.3 Connection Diagram of Test System

<AC Conducted Emission>

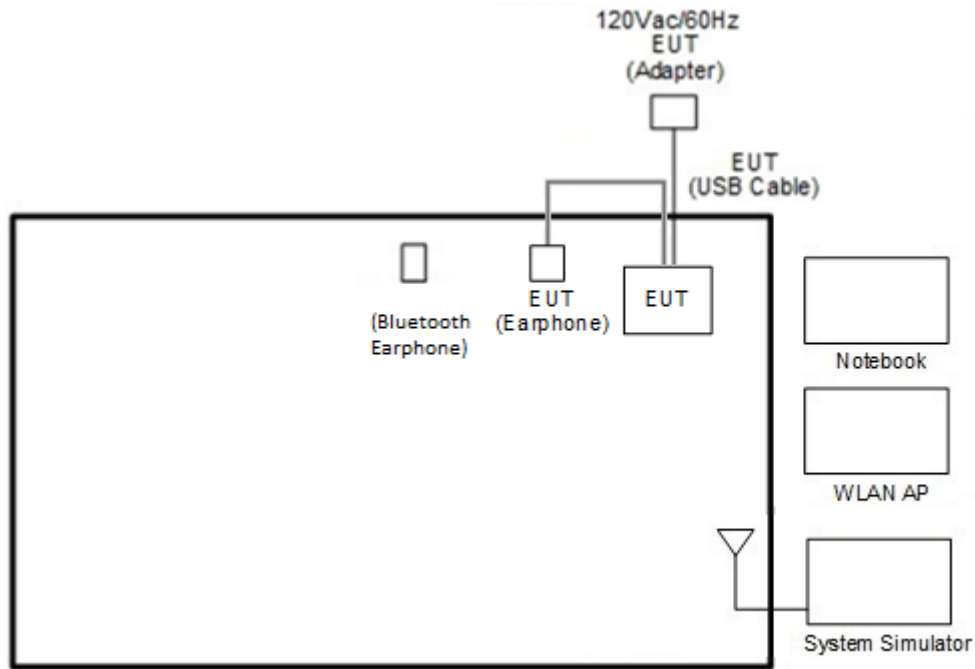

<Bluetooth LE Tx Mode>

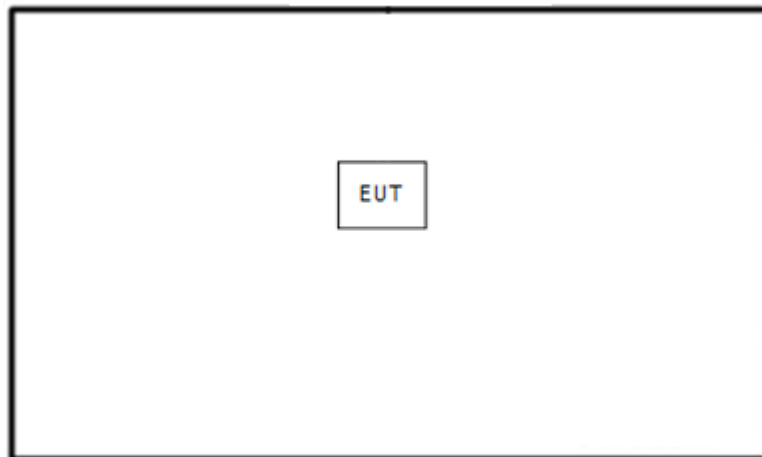

## 2.4 Support Unit used in test configuration and system

Item	Equipment	Brand Name	Model Name	FCC ID	Data Cable	Power Cord
1.	LTE Base Station	Anritus	MT8821C	N/A	N/A	Unshielded,1.8m
2.	Notebook	Lenovo	G480	QDS-BRCM1050I	N/A	shielded cable DC O/P 1.8m , Unshielded AC I/P cable 1.8m
3.	WLAN AP	D-link	DIR-655	KA21R655B1	N/A	Unshielded,1.8m
4.	Bluetooth Earphone	Sony	SBH82D	PY7-33726V	N/A	N/A

## 2.5 EUT Operation Test Setup

The RF test items, utility “FTM” was installed in Notebook which was programmed in order to make the EUT get into the engineering modes to provide channel selection, power level, data rate and the application type and for continuous transmitting signals.

For AC power line conducted emissions, the EUT was set to connect with the WLAN AP under large package sizes transmission.

## 2.6 Measurement Results Explanation Example

For all conducted test items:

The offset level is set in the spectrum analyzer to compensate the RF cable loss between EUT conducted output port and spectrum analyzer. With the offset compensation, the spectrum analyzer reading level is exactly the EUT RF output level.

Example :

The spectrum analyzer offset is derived from RF cable loss.

$Offset = RF\ cable\ loss.$

Following shows an offset computation example with cable loss 5.8 dB.

$$\begin{aligned} Offset(dB) &= RF\ cable\ loss(dB). \\ &= 5.8\ (dB) \end{aligned}$$

### 3 Test Result

#### 3.1 6dB and 99% Bandwidth Measurement

##### 3.1.1 Limit of 6dB and 99% Bandwidth

The minimum 6 dB bandwidth shall be at least 500 kHz.

##### 3.1.2 Measuring Instruments

See list of measuring equipment of this test report.

##### 3.1.3 Test Procedures

1. The testing follows the ANSI C63.10 Section 6.9.3 (OBW) and 11.8.1 (6dB BW).
2. The RF output of EUT was connected to the spectrum analyzer by RF cable and attenuator. The path loss was compensated to the results for each measurement.
3. Set the maximum power setting and enable the EUT to transmit continuously.
4. Make the measurement with the spectrum analyzer's resolution bandwidth (RBW) = 100 kHz. Set the Video bandwidth (VBW) = 300 kHz. In order to make an accurate measurement. The 6dB bandwidth must be greater than 500 kHz.
5. For 99% Bandwidth Measurement, the spectrum analyzer's resolution bandwidth (RBW) is set 1-5% of the emission bandwidth and set the Video bandwidth (VBW)  $\geq 3 * RBW$ .
6. Measure and record the results in the test report.

##### 3.1.4 Test Setup

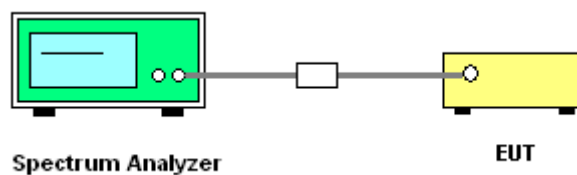



### 3.1.5 Test Result of 6dB Bandwidth

Please refer to Appendix A.

<1Mbps>

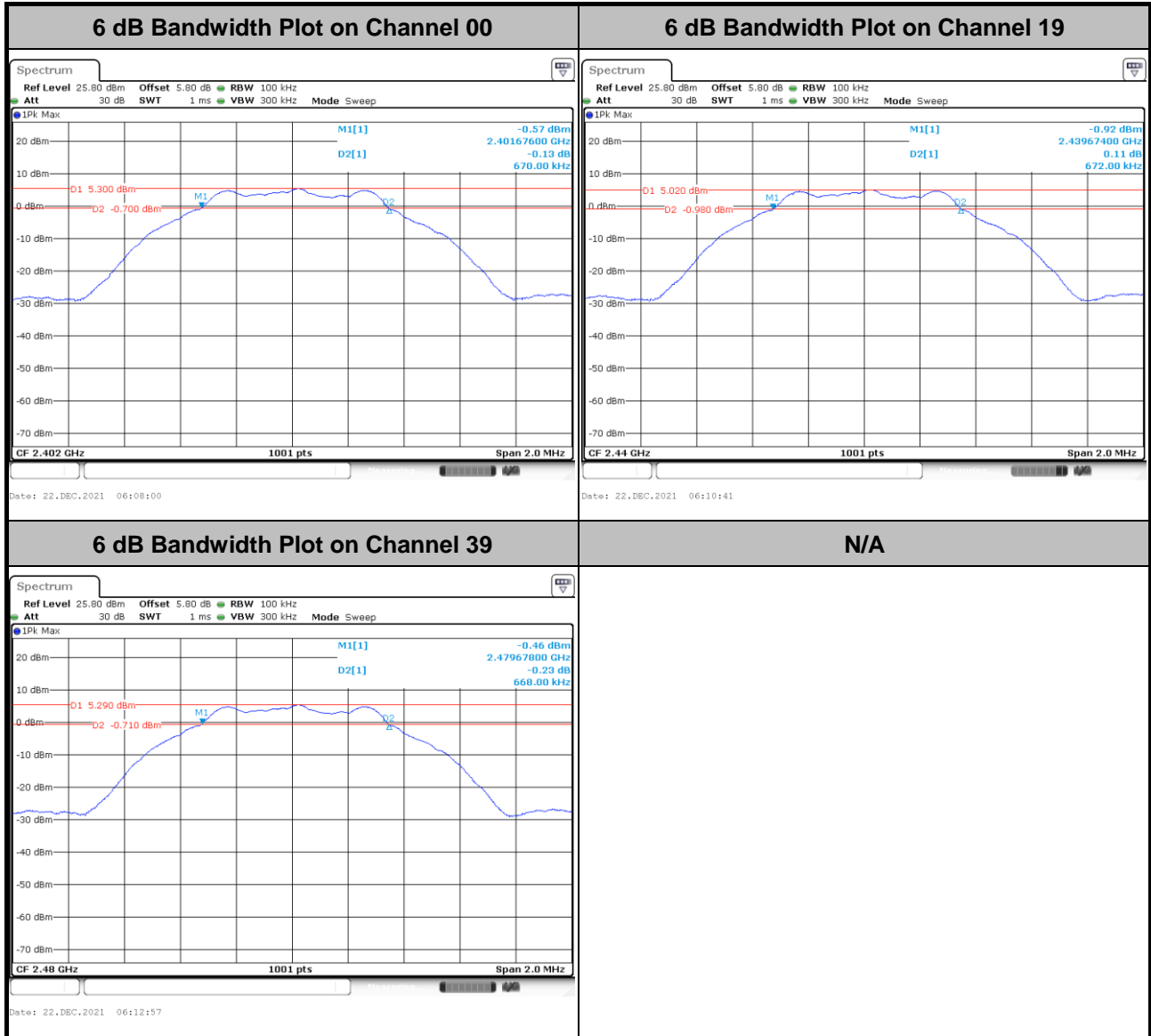



<2Mbps>

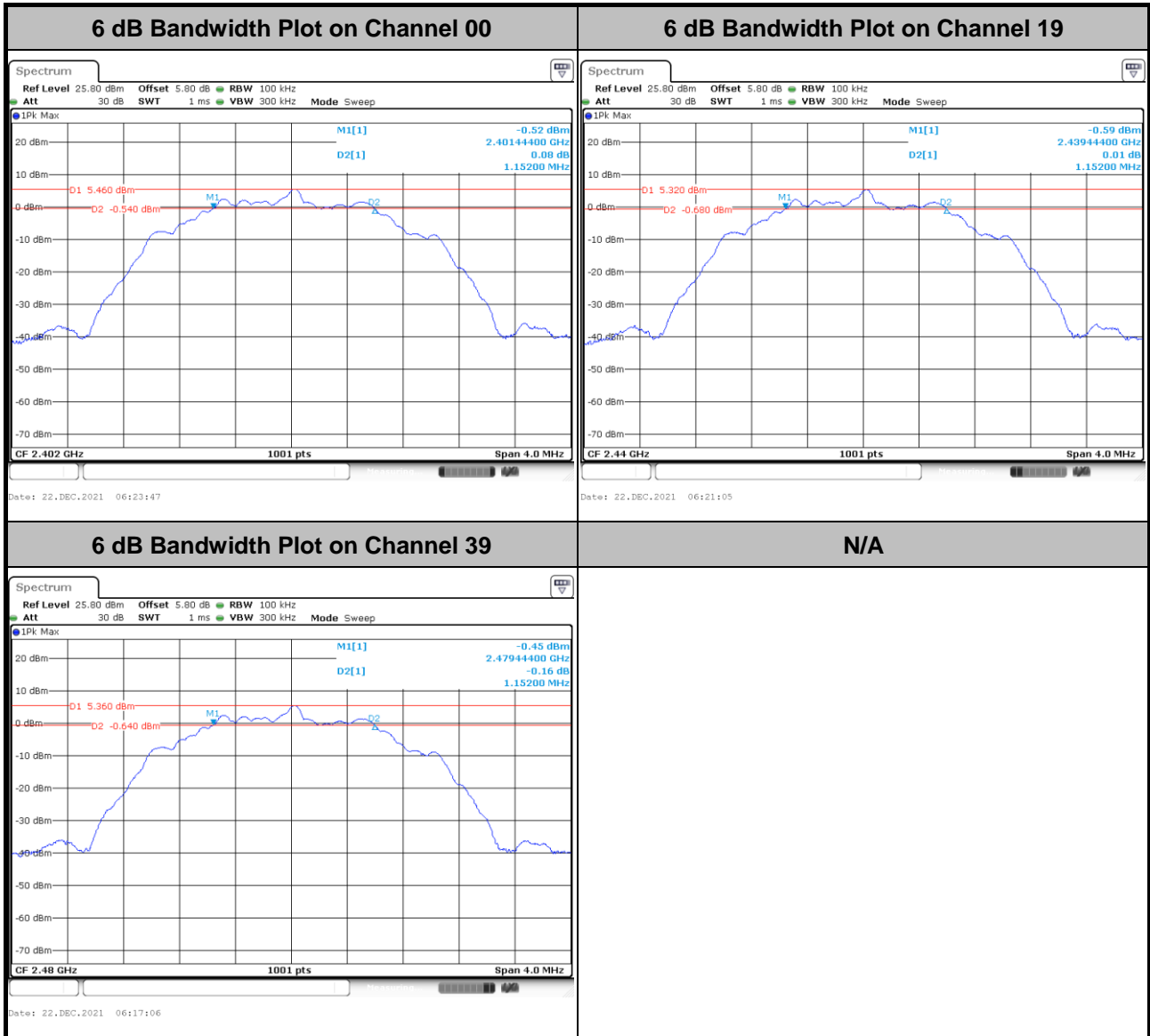



### 3.1.6 Test Result of 99% Occupied Bandwidth

Please refer to Appendix A.

<1Mbps>

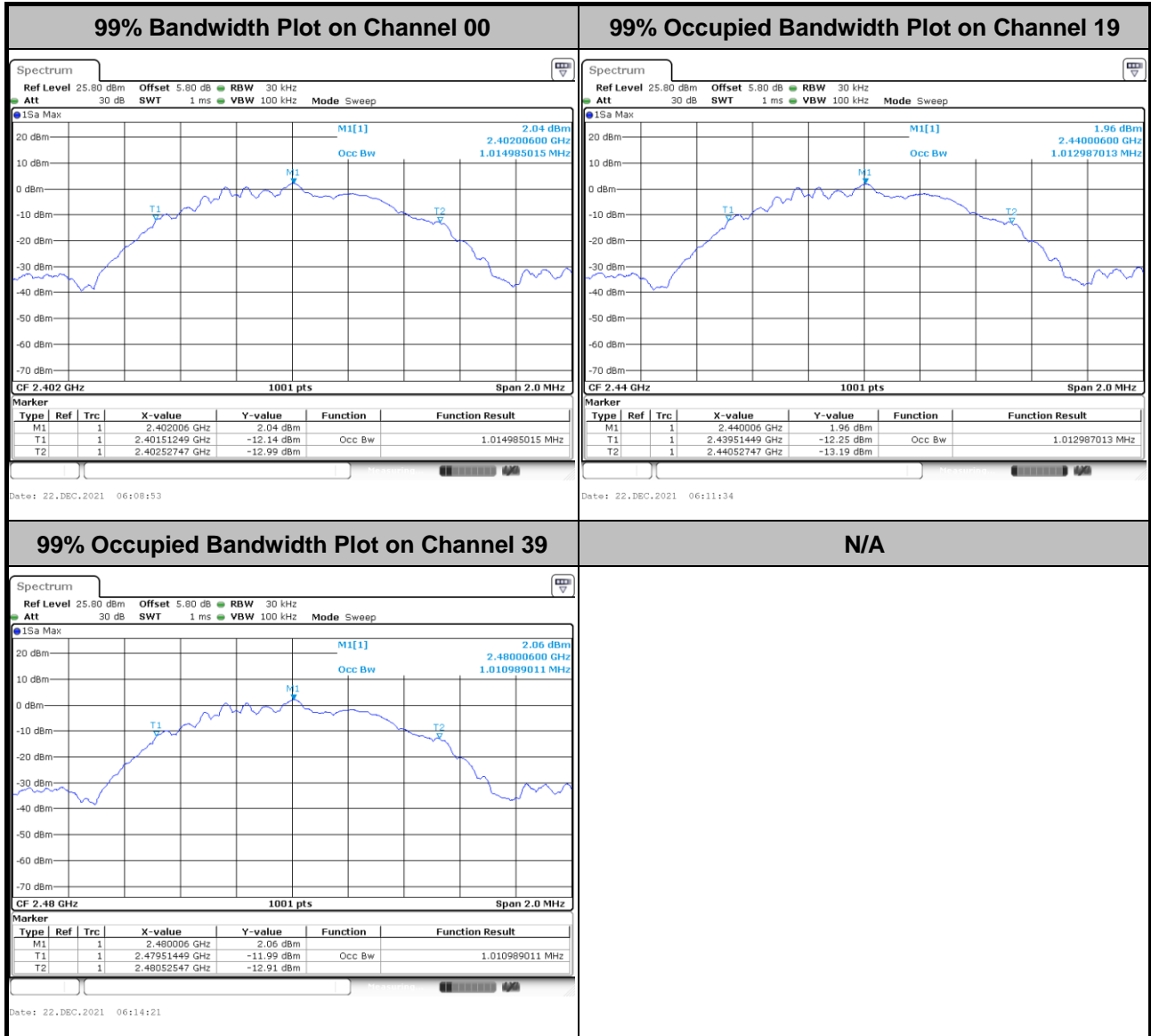

Note: The occupied channel bandwidth is maintained within the band of operation for all of the modulations.



<2Mbps>

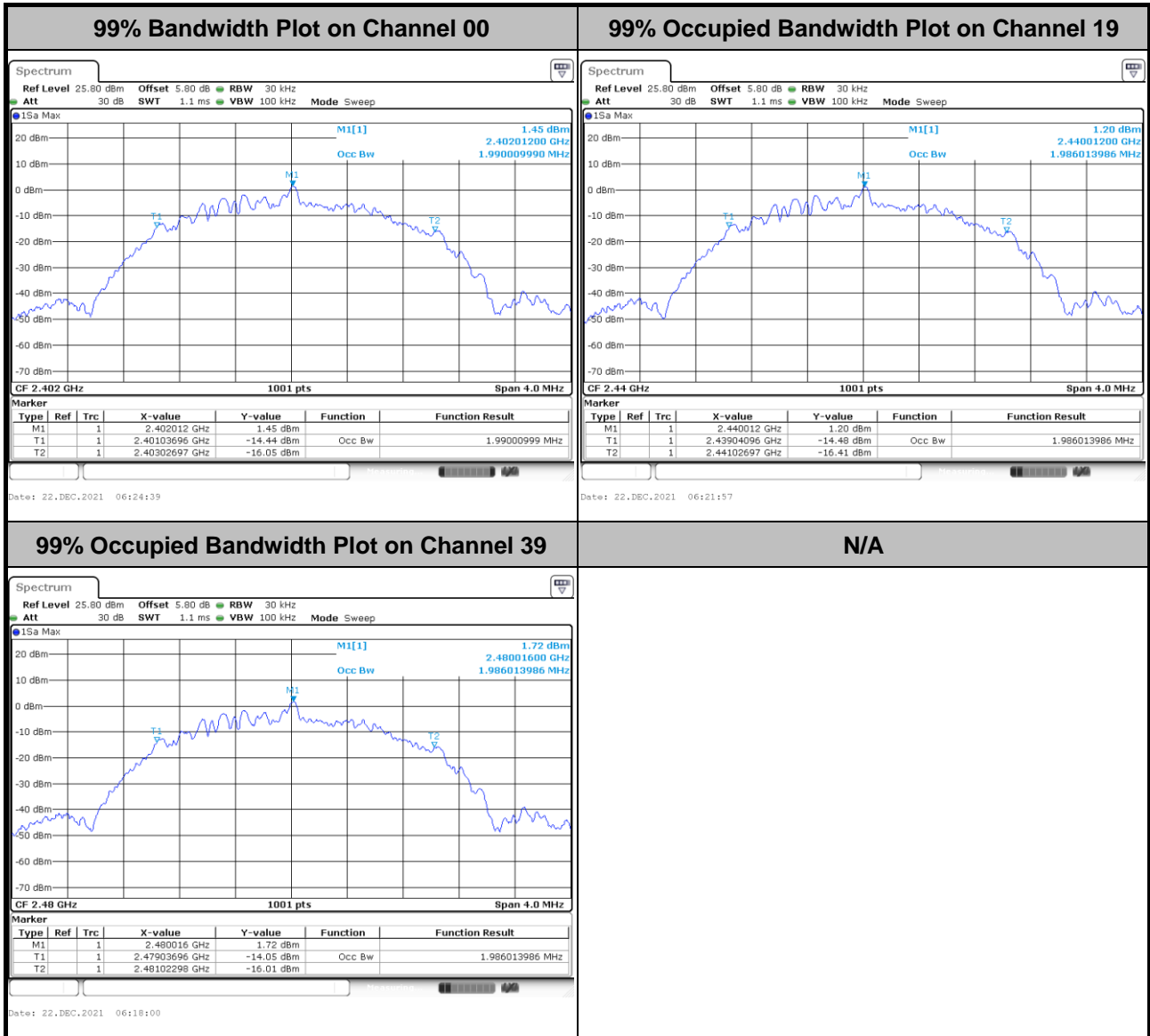

Note: The occupied channel bandwidth is maintained within the band of operation for all of the modulations.

## 3.2 Output Power Measurement

### 3.2.1 Limit of Output Power

For systems using digital modulation in the 2400-2483.5 MHz, the limit for output power is 30 dBm. If transmitting antenna of directional gain greater than 6 dBi is used, the peak output power from the intentional radiator shall be reduced below the above stated value by the amount in dB that the directional gain of the antenna exceeds 6 dBi. In case of point-to-point operation, the limit has to be reduced by 1 dB for every 3 dB that the directional gain of the antenna exceeds 6 dBi.

### 3.2.2 Measuring Instruments

See list of measuring equipment of this test report.

### 3.2.3 Test Procedures

1. The testing follows the Measurement Procedure of ANSI C63.10-2013 clause 11.9.1.3 PKPM1 Peak power meter or ANSI C63.10-2013 clause 11.9.2.3.1 Method AVGPM method.
2. The RF output of EUT was connected to the power meter by RF cable and attenuator.
3. The path loss was compensated to the results for each measurement.
4. Set the maximum power setting and enable the EUT to transmit continuously.
5. Measure the conducted output power and record the results in the test report.

### 3.2.4 Test Setup

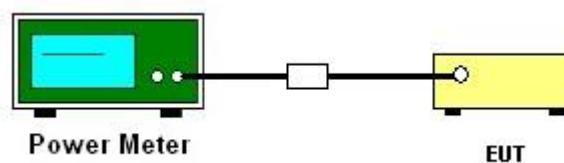

### 3.2.5 Test Result of Peak Output Power

Please refer to Appendix A.

### 3.2.6 Test Result of Average Output Power (Reporting Only)

Please refer to Appendix A.



### 3.3 Power Spectral Density Measurement

#### 3.3.1 Limit of Power Spectral Density

The peak power spectral density shall not be greater than 8 dBm in any 3 kHz band at any time interval of continuous transmission.

#### 3.3.2 Measuring Instruments

See list of measuring equipment of this test report.

#### 3.3.3 Test Procedures

1. The testing follows the ANSI C63.10 Section 11.10.2 Method PKPSD.
2. The RF output of EUT was connected to the spectrum analyzer by RF cable and attenuator. The path loss was compensated to the results for each measurement.
3. Set the maximum power setting and enable the EUT to transmit continuously.
4. Make the measurement with the spectrum analyzer's resolution bandwidth (RBW) = 3 kHz. Video bandwidth VBW = 10 kHz. In order to make an accurate measurement, set the span to 1.5 times DTS Channel Bandwidth. (6dB BW)
5. Detector = peak, Sweep time = auto couple, Trace mode = max hold, Allow trace to fully stabilize. Use the peak marker function to determine the maximum power level.
6. Measure and record the results in the test report.
7. The Measured power density (dBm)/ 100 kHz is a reference level and is used as 20 dBc down limit line for Conducted Band Edges and Conducted Spurious Emission.

#### 3.3.4 Test Setup

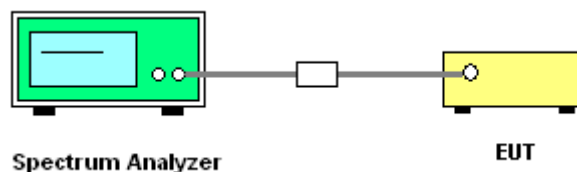

#### 3.3.5 Test Result of Power Spectral Density

Please refer to Appendix A.



### 3.3.6 Test Result of Power Spectral Density Plots (100kHz)

<1Mbps>

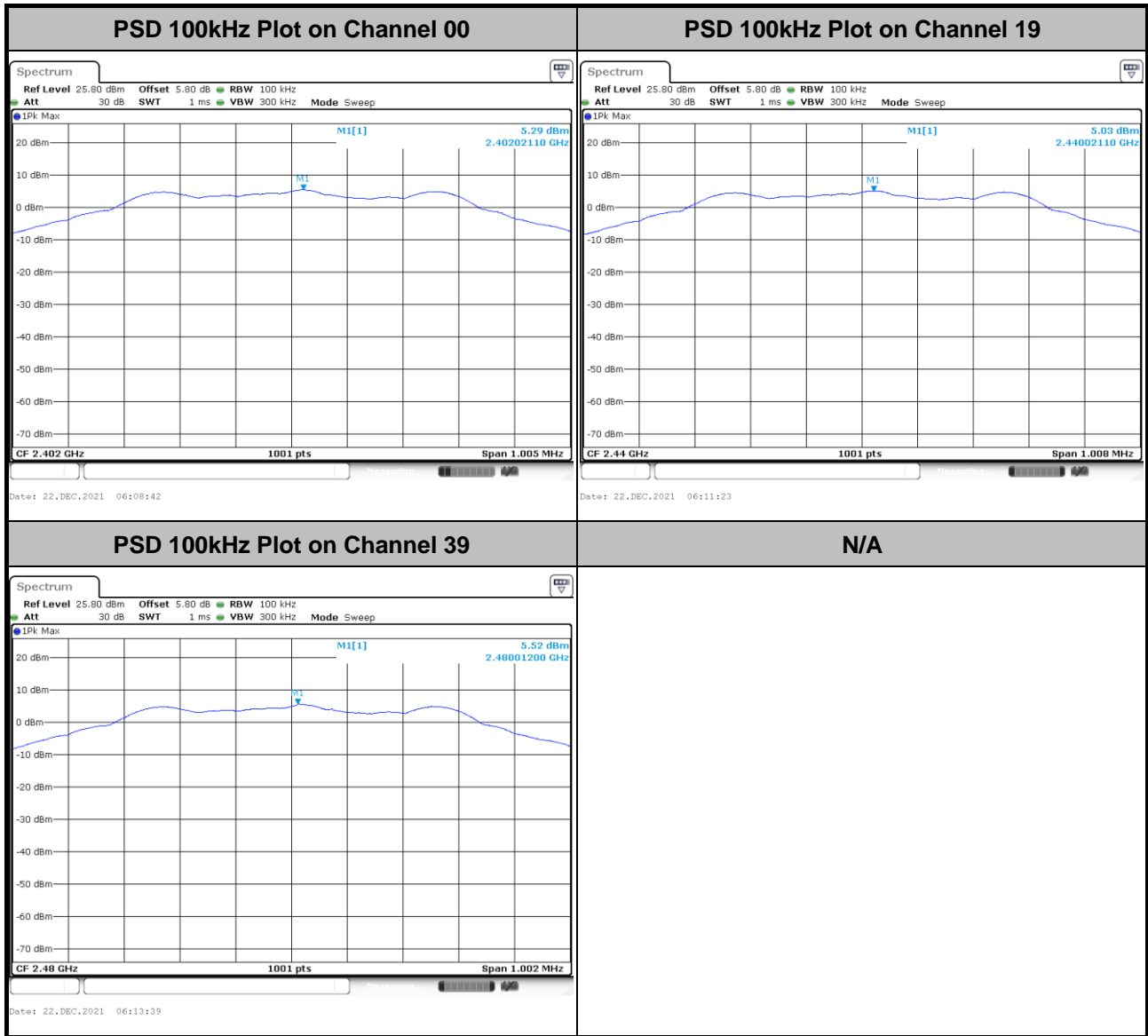



<2Mbps>

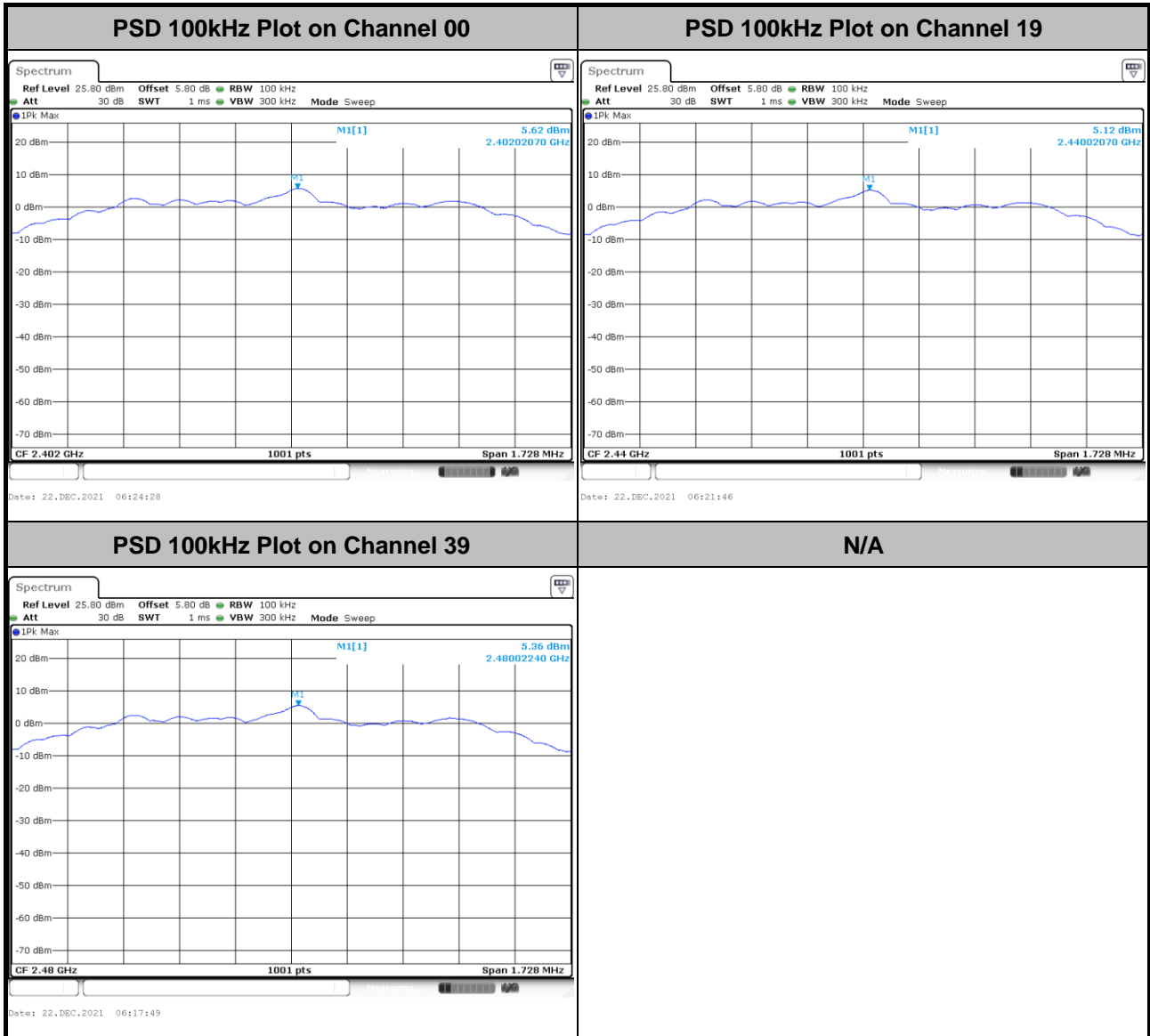



### 3.3.7 Test Result of Power Spectral Density Plots (3kHz)

<1Mbps>

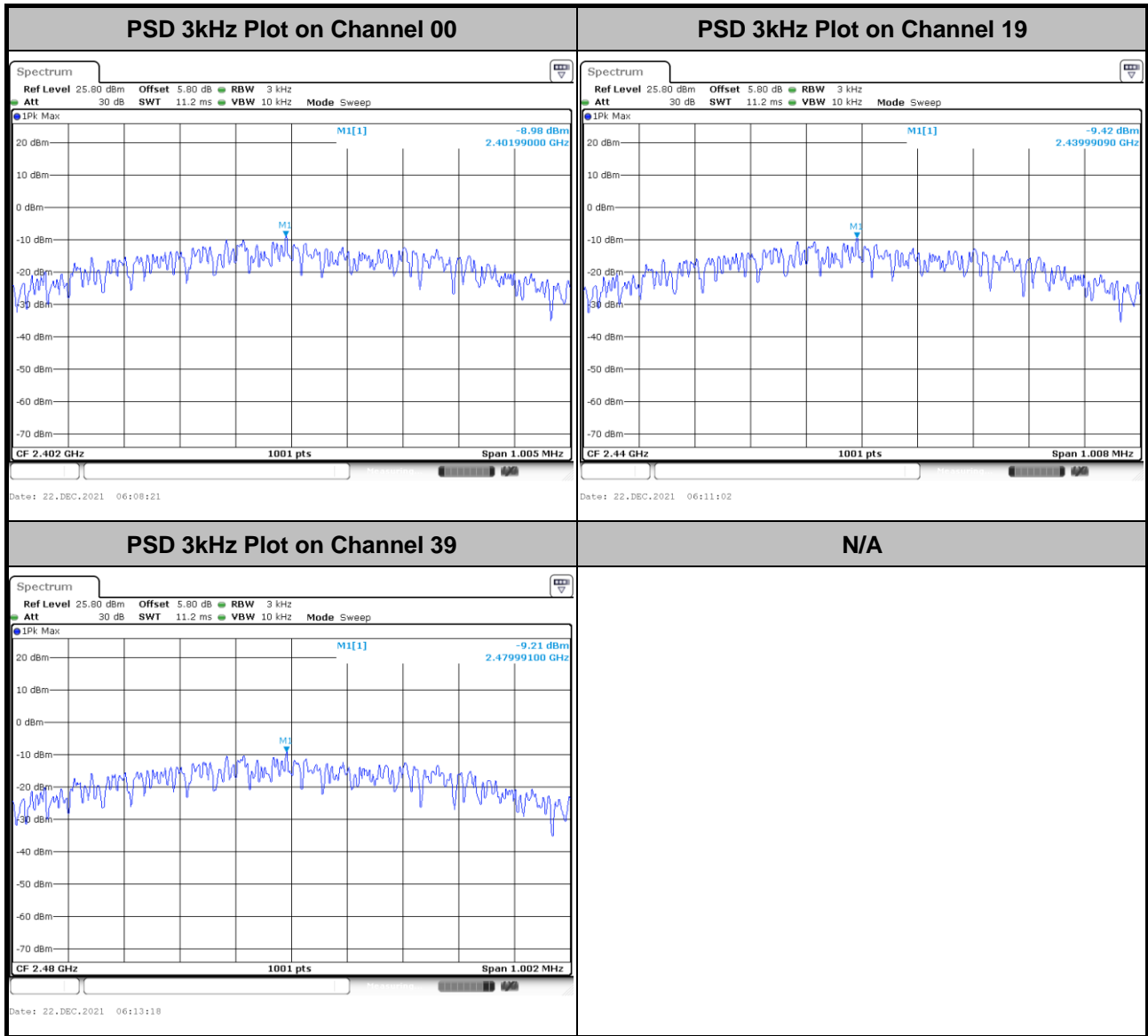



<2Mbps>

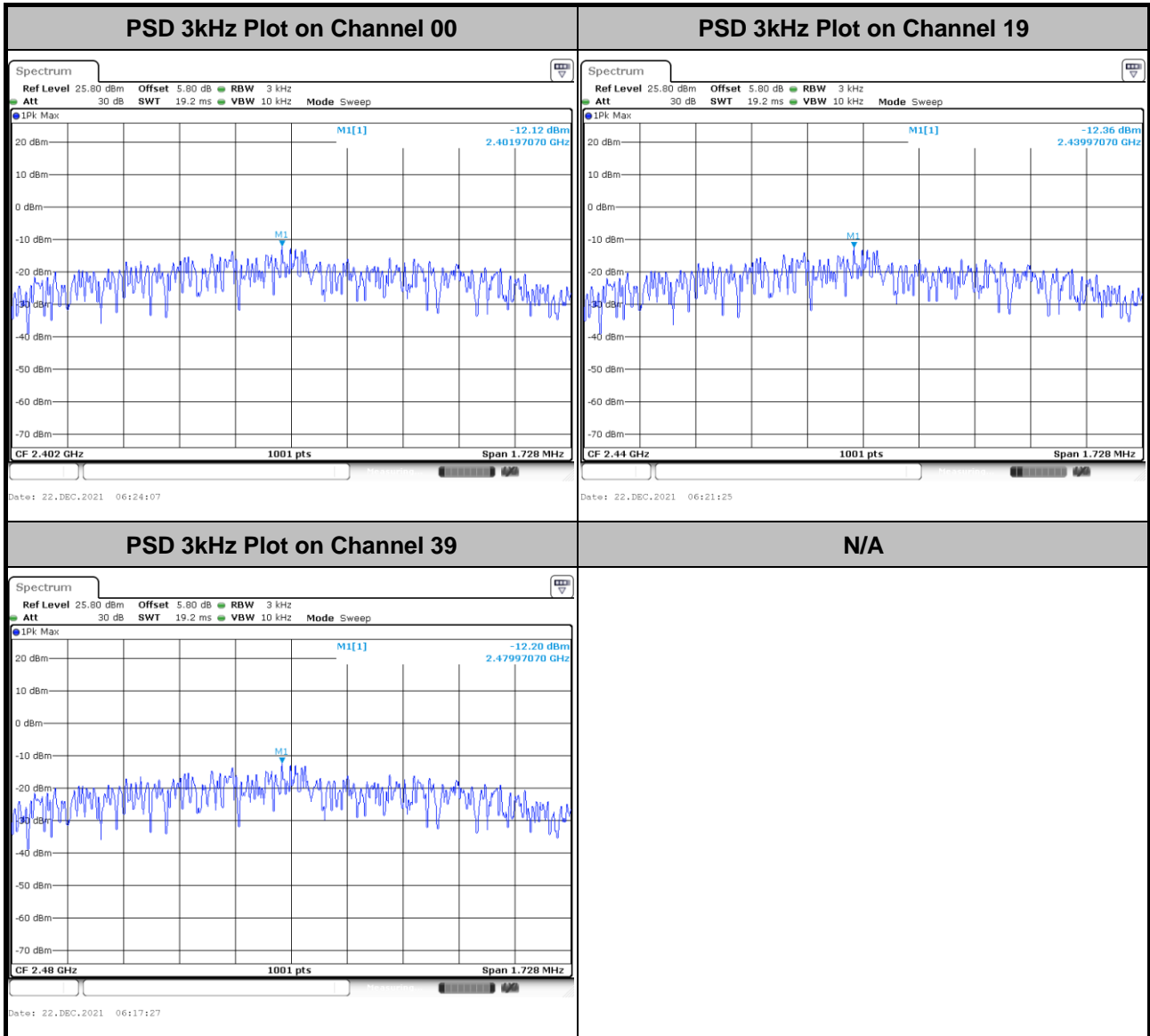

## 3.4 Conducted Band Edges and Spurious Emission Measurement

### 3.4.1 Limit of Conducted Band Edges and Spurious Emission

All harmonics/spurious must be at least 20 dB down from the highest emission level within the authorized band.

### 3.4.2 Measuring Instruments

See list of measuring equipment of this test report.

### 3.4.3 Test Procedure

1. The testing follows the ANSI C63.10 Section 11.11.3 Emission level measurement.
2. The RF output of EUT was connected to the spectrum analyzer by RF cable and attenuator. The path loss was compensated to the results for each measurement.
3. Set the maximum power setting and enable the EUT to transmit continuously.
4. Set RBW = 100 kHz, VBW = 300 kHz, Peak Detector. Unwanted Emissions measured in any 100 kHz bandwidth outside of the authorized frequency band shall be attenuated by at least 20 dB relative to the maximum in-band peak PSD level in 100 kHz when maximum peak conducted output power procedure is used. If the transmitter complies with the conducted power limits based on the use of RMS averaging over a time interval, the attenuation required under this paragraph shall be 30 dB instead of 20 dB.
5. Measure and record the results in the test report.
6. The RF fundamental frequency should be excluded against the limit line in the operating frequency band.

### 3.4.4 Test Setup

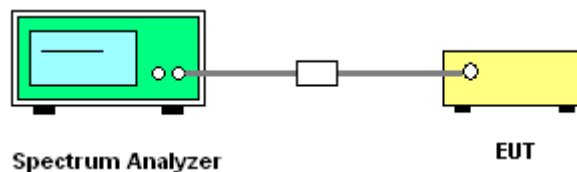



### 3.4.5 Test Result of Conducted Band Edges Plots

<1Mbps>

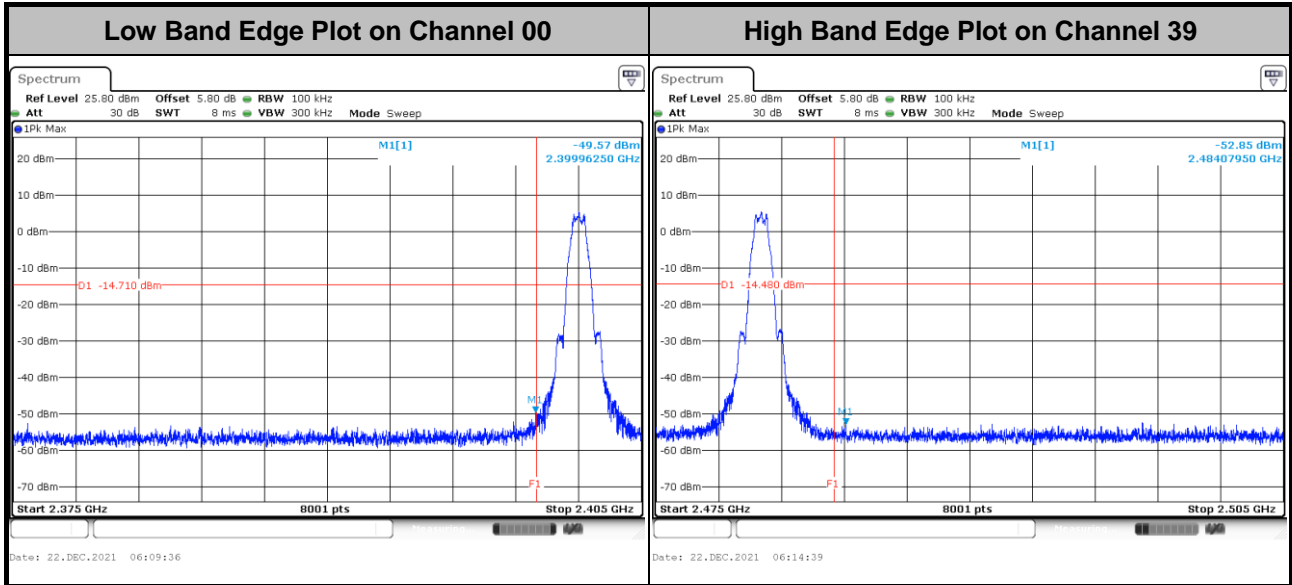

<2Mbps>

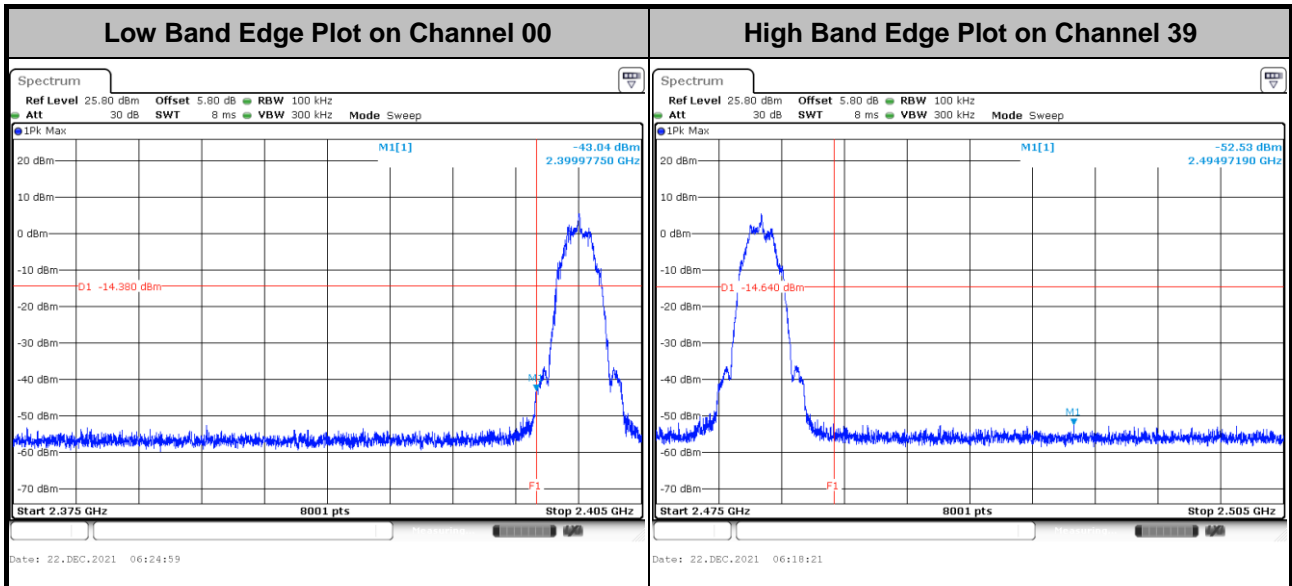



3.4.6 Test Result of Conducted Spurious Emission Plots

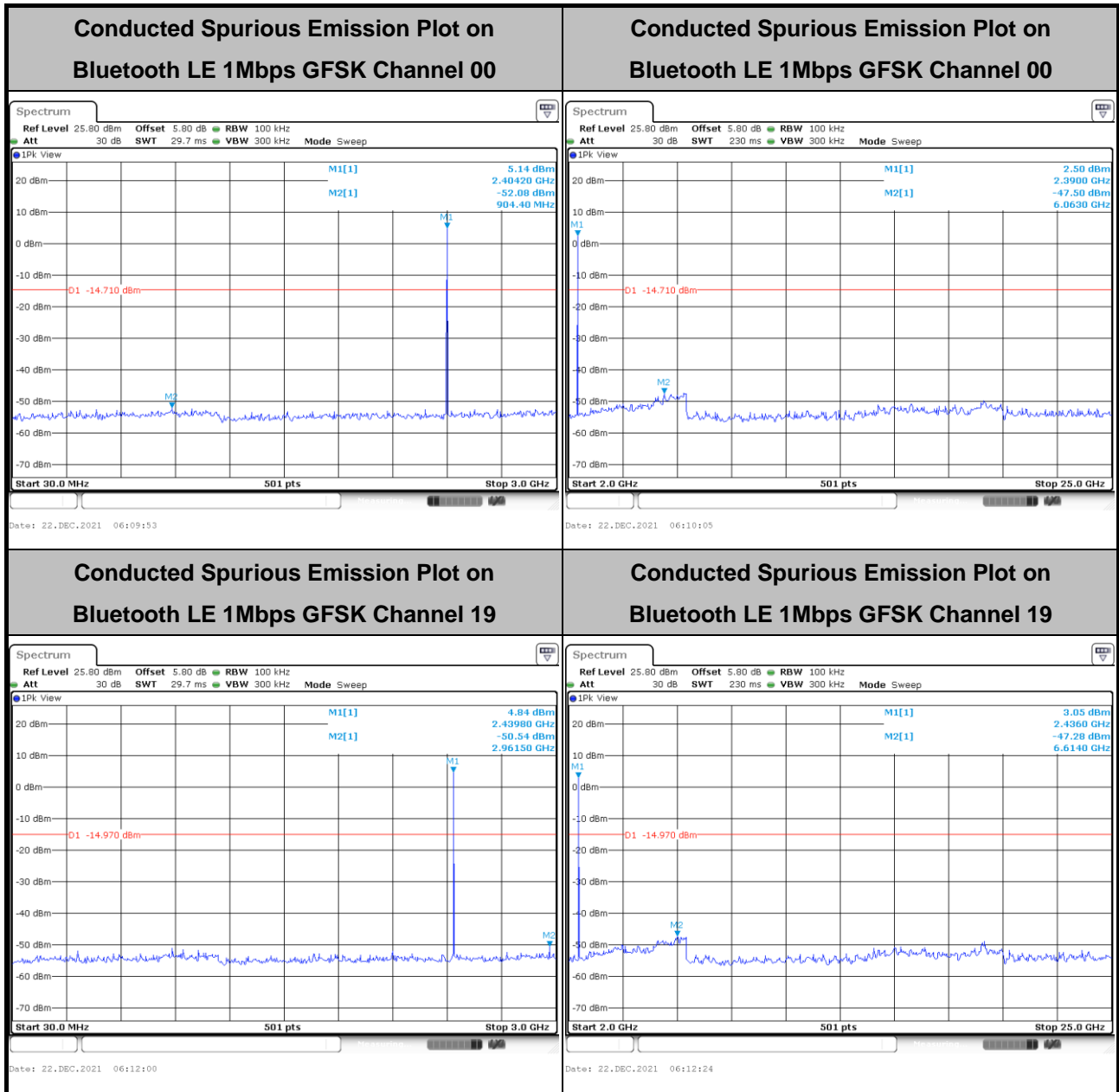



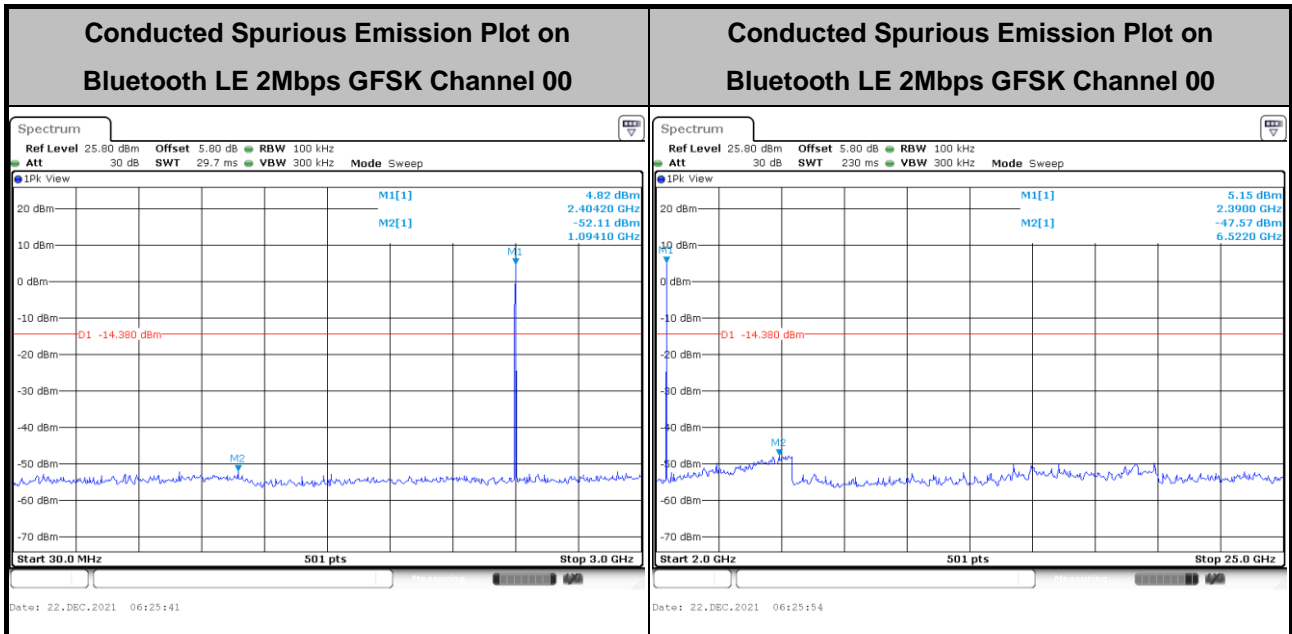
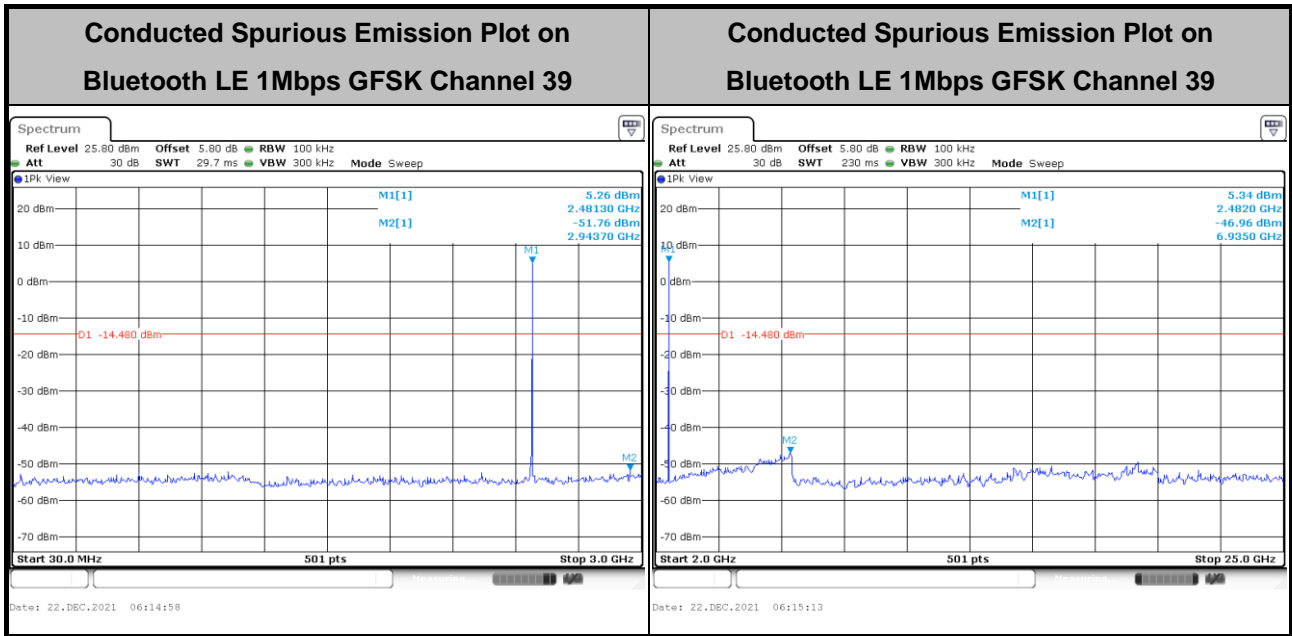



Conducted Spurious Emission Plot on Bluetooth LE 2Mbps GFSK Channel 19

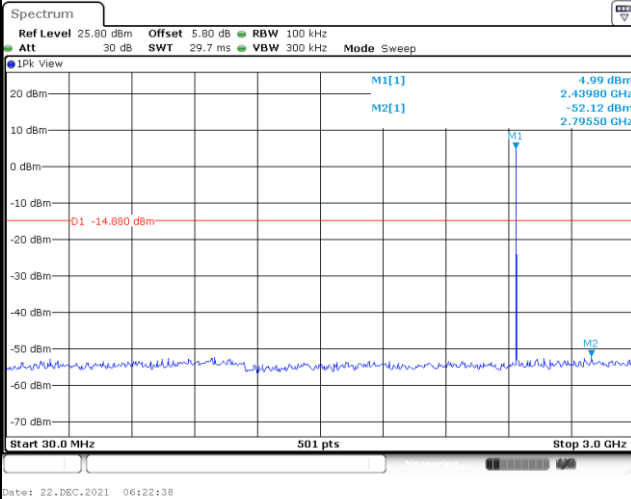

Date: 22.DEC.2021 06:22:38

Conducted Spurious Emission Plot on Bluetooth LE 2Mbps GFSK Channel 19

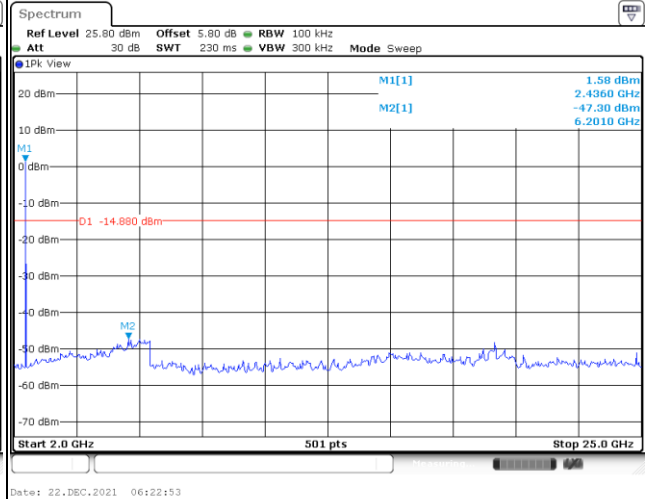

Date: 22.DEC.2021 06:22:53

Conducted Spurious Emission Plot on Bluetooth LE 2Mbps GFSK Channel 39

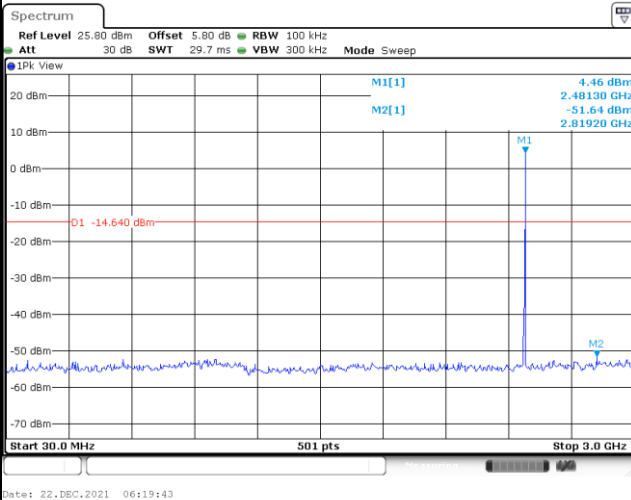

Date: 22.DEC.2021 06:19:43

Conducted Spurious Emission Plot on Bluetooth LE 2Mbps GFSK Channel 39

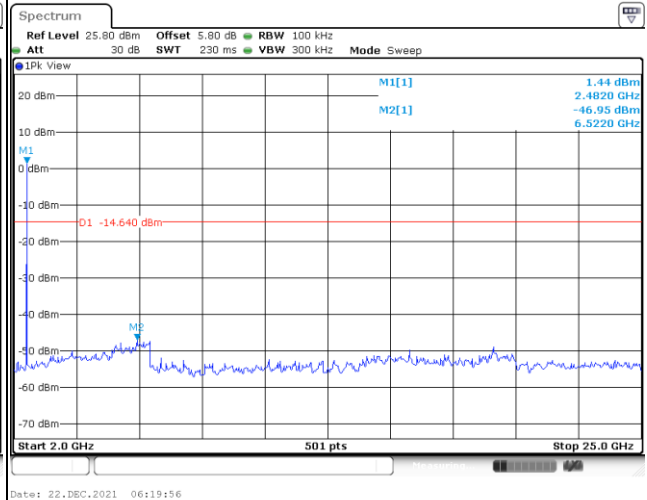

Date: 22.DEC.2021 06:19:56



### 3.5 Radiated Band Edges and Spurious Emission Measurement

#### 3.5.1 Limit of Radiated Band Edges and Spurious Emission

In any 100 kHz bandwidth outside the intentional radiator frequency band, all harmonics/spurious must be at least 20 dB below the highest emission level within the authorized band. If the output power of this device was measured by spectrum analyzer, the attenuation under this paragraph shall be 30 dB instead of 20 dB. In addition, radiated emissions which fall in the restricted bands must also comply with the limits as below.

Frequency (MHz)	Field Strength (microvolts/meter)	Measurement Distance (meters)
0.009 – 0.490	2400/F(kHz)	300
0.490 – 1.705	24000/F(kHz)	30
1.705 – 30.0	30	30
30 – 88	100	3
88 – 216	150	3
216 - 960	200	3
Above 960	500	3

#### 3.5.2 Measuring Instruments

See list of measuring equipment of this test report.



**3.5.3 Test Procedures**

1. The testing follows the ANSI C63.10 Section 11.12.1 Radiated emission measurements.
2. The EUT was arranged to its worst case and then tune the antenna tower (from 1 m to 4 m) and turntable (from 0 degree to 360 degrees) to find the maximum reading. A pre-amp and a high pass filter are used for the test in order to get better signal level.
3. The EUT was placed on a turntable with 0.8 meter for frequency below 1 GHz and 1.5 meter for frequency above 1 GHz respectively above ground.
4. The EUT was set 3 meters from the interference receiving antenna, which was mounted on the top of a variable height antenna tower.
5. Corrected Reading: Antenna Factor + Cable Loss + Read Level - Preamp Factor = Level
6. For testing below 1 GHz, if the emission level of the EUT in peak mode was 3 dB lower than the limit specified, then peak values of EUT will be reported, otherwise, the emissions will be repeated one by one using the CISPR quasi-peak method and be reported.
7. For testing above 1 GHz, the emission level of the EUT in peak mode was 20 dB lower than average limit (that means the emission level in average mode also complies with the limit in average mode), then peak values of EUT will be reported, otherwise, the emissions will be measured in average mode again and be reported.
8. Use the following spectrum analyzer settings:
  - (1) Span shall wide enough to fully capture the emission being measured;
  - (2) Set RBW = 100 kHz for  $f < 1$  GHz;  $VBW \geq RBW$ ; Sweep = auto; Detector function = peak; Trace = max hold;
  - (3) Set RBW = 1 MHz,  $VBW = 3$  MHz for  $f \geq 1$  GHz for peak measurement.  
For average measurement:
    - $VBW = 10$  Hz, when duty cycle is no less than 98 percent.
    - $VBW \geq 1/T$ , when duty cycle is less than 98 percent where T is the minimum transmission duration over which the transmitter is on and is transmitting at its maximum power control level for the tested mode of operation.

### 3.5.4 Test Setup

For radiated emissions below 30MHz

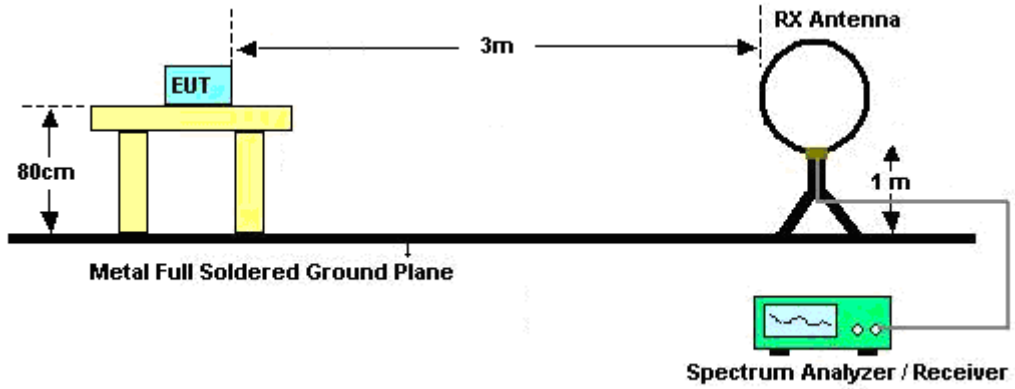

For radiated emissions from 30MHz to 1GHz

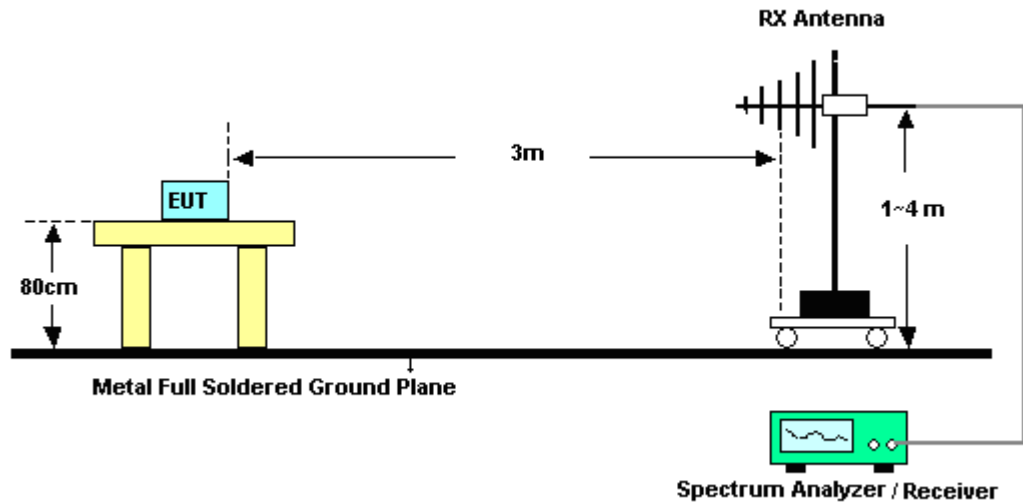

For radiated test from 1GHz to 18GHz

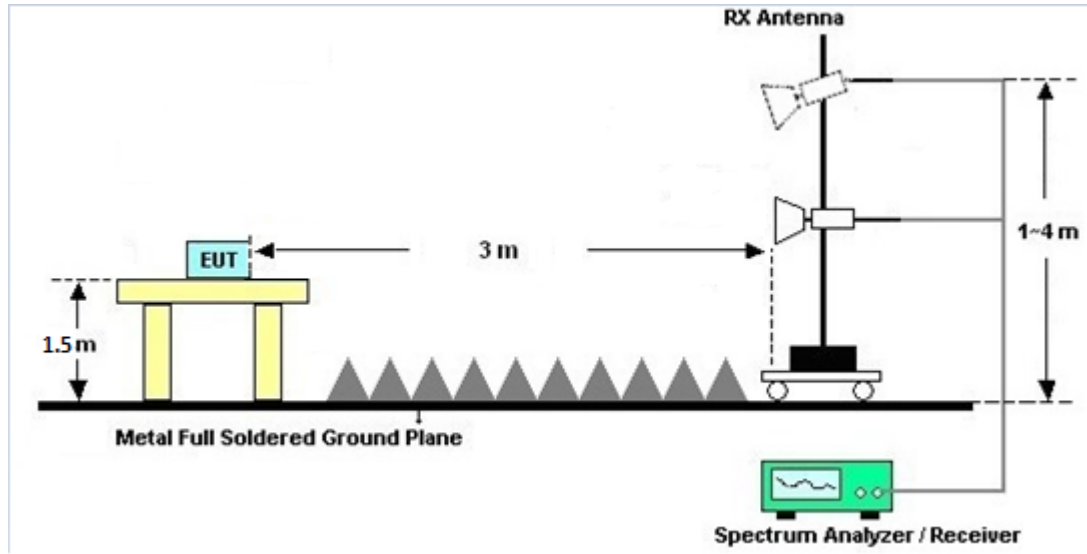

For radiated test above 18GHz

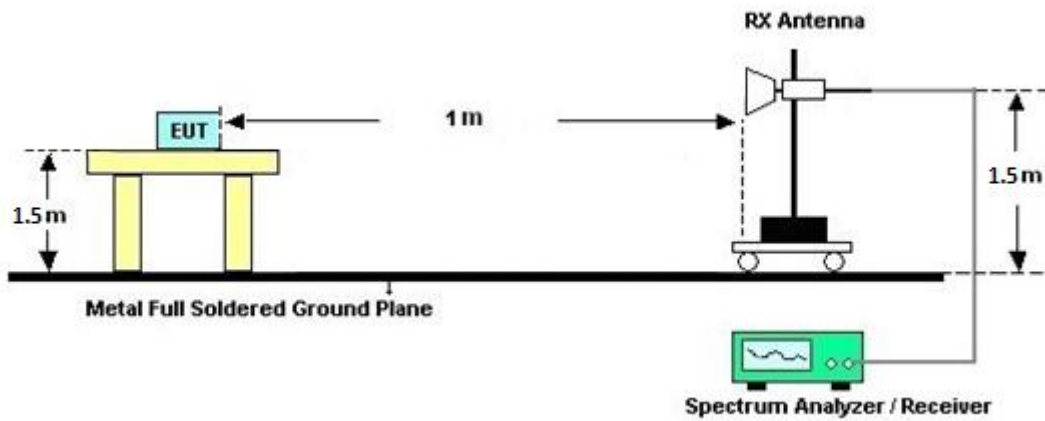



### **3.5.5 Test Results of Radiated Spurious Emissions (9 kHz ~ 30 MHz)**

The low frequency, which started from 9 kHz to 30MHz, was pre-scanned and the result which was 20dB lower than the limit line was not reported.

There is adequate comparison measurement of both open-field test site and alternative test site - semi-Anechoic chamber according to 414788 D01 Radiated Test Site v01r01, and the result came out very similar.

### **3.5.6 Test Result of Radiated Spurious at Band Edges**

Please refer to Appendix C and D.

### **3.5.7 Duty Cycle**

Please refer to Appendix E.

### **3.5.8 Test Result of Radiated Spurious Emission (30 MHz ~ 10th Harmonic)**

Please refer to Appendix C and D.



### 3.6 AC Conducted Emission Measurement

#### 3.6.1 Limit of AC Conducted Emission

For equipment that is designed to be connected to the public utility (AC) power line, the radio frequency voltage that is conducted back onto the AC power line on any frequency or frequencies within the band 150 kHz to 30 MHz shall not exceed the limits in the following table.

Frequency of emission (MHz)	Conducted limit (dBµV)	
	Quasi-peak	Average
0.15-0.5	66 to 56*	56 to 46*
0.5-5	56	46
5-30	60	50

\*Decreases with the logarithm of the frequency.

#### 3.6.2 Measuring Instruments

See list of measuring equipment of this test report.

#### 3.6.3 Test Procedures

1. The EUT was placed 0.4 meter from the conducting wall of the shielding room was kept at least 80 centimeters from any other grounded conducting surface.
2. Connect EUT to the power mains through a line impedance stabilization network (LISN).
3. All the support units are connecting to the other LISN.
4. The LISN provides 50 ohm coupling impedance for the measuring instrument.
5. The FCC states that a 50 ohm, 50 microhenry LISN shall be used.
6. Both sides of AC line were checked for maximum conducted interference.
7. The frequency range from 150 kHz to 30 MHz was searched.
8. Set the test-receiver system to Peak Detect Function and specified bandwidth (IF Bandwidth = 9kHz) with Maximum Hold Mode. Then measurement is also conducted by Average Detector and Quasi-Peak Detector Function respectively.



### 3.6.4 Test Setup

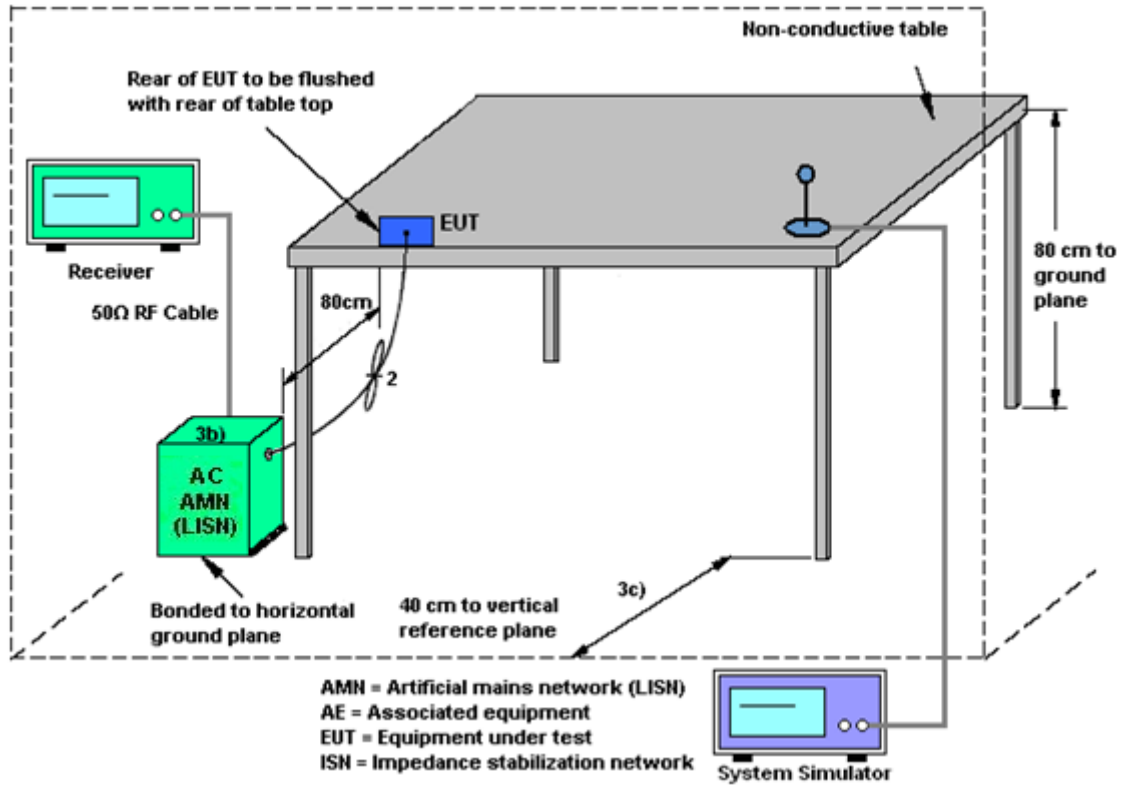

### 3.6.5 Test Result of AC Conducted Emission

Please refer to Appendix B.



## **3.7 Antenna Requirements**

### **3.7.1 Standard Applicable**

If directional gain of transmitting antennas is greater than 6 dBi, the power shall be reduced by the same level in dB comparing to gain minus 6 dBi. The use of a permanently attached antenna or of an antenna that uses a unique coupling to the intentional radiator shall be considered sufficient to comply with the rule.

### **3.7.2 Antenna Anti-Replacement Construction**

An embedded-in antenna design is used.

### **3.7.3 Antenna Gain**

The antenna peak gain of EUT is less than 6 dBi. Therefore, it is not necessary to reduce maximum peak output power limit.



## 4 List of Measuring Equipment

Instrument	Manufacturer	Model No.	Serial No.	Characteristics	Calibration Date	Test Date	Due Date	Remark
Spectrum Analyzer	R&S	FSV40	101040	10Hz~40GHz	Oct. 14, 2021	Dec. 22, 2021	Oct. 13, 2022	Conducted (TH01-KS)
Pulse Power Sensor	Anritsu	MA2411B	0917070	300MHz~40GHz	Jan. 07, 2021	Dec. 22, 2021	Jan. 06, 2022	Conducted (TH01-KS)
Power Meter	Anritsu	ML2495A	1005002	50MHz Bandwidth	Jan. 07, 2021	Dec. 22, 2021	Jan. 06, 2022	Conducted (TH01-KS)
EMI Test Receiver	Keysight	N9038A	MY56400004	3Hz~8.5GHz;Max 30dBm	Oct. 16, 2021	Jan. 28, 2022	Oct. 15, 2022	Radiation (03CH06-KS)
EXA Spectrum Analyzer	Keysight	N9010A	MY55150208	10Hz~44GHz	Apr. 12, 2021	Jan. 28, 2022	Apr. 11, 2022	Radiation (03CH06-KS)
Loop Antenna	R&S	HFH2-Z2	100321	9kHz~30MHz	Oct. 30, 2021	Jan. 28, 2022	Oct. 29, 2022	Radiation (03CH06-KS)
Bilog Antenna	TeseQ	CBL6111D	49921	30MHz~1GHz	May 27, 2021	Jan. 28, 2022	May 26, 2022	Radiation (03CH06-KS)
Double Ridge Horn Antenna	ETS-Lindgren	3117	00218652	1GHz~18GHz	Apr. 25, 2021	Jan. 28, 2022	Apr. 24, 2022	Radiation (03CH06-KS)
SHF-EHF Horn	Com-power	AH-840	101093	18GHz~40GHz	Jan. 05, 2022	Jan. 28, 2022	Jan. 04 2023	Radiation (03CH06-KS)
Amplifier	SONOMA	310N	187289	9KHz ~1GHZ	Apr. 12, 2021	Jan. 28, 2022	Apr. 11, 2022	Radiation (03CH06-KS)
Amplifier	MITEQ	EM18G40GGA	060728	18~40GHz	Jan. 05, 2022	Jan. 28, 2022	Jan. 04 2023	Radiation (03CH06-KS)
high gain Amplifier	MITEQ	AMF-7D-00101800-30-10P	2025788	1Ghz-18Ghz	Jul. 30, 2021	Jan. 28, 2022	Jul. 29, 2022	Radiation (03CH06-KS)
Amplifier	Keysight	83017A	MY53270203	500MHz~26.5GHz	Apr. 13, 2021	Jan. 28, 2022	Apr. 12, 2022	Radiation (03CH06-KS)
AC Power Source	Chroma	61601	F104090004	N/A	NCR	Jan. 28, 2022	NCR	Radiation (03CH06-KS)
Turn Table	ChamPro	EM 1000-T	060762-T	0~360 degree	NCR	Jan. 28, 2022	NCR	Radiation (03CH06-KS)
Antenna Mast	ChamPro	EM 1000-A	060762-A	1 m~4 m	NCR	Jan. 28, 2022	NCR	Radiation (03CH06-KS)
EMI Receiver	R&S	ESC17	100768	9kHz~7GHz;	Apr. 21, 2021	Dec. 20, 2021	Apr. 20, 2022	Conduction (CO01-KS)
AC LISN (for auxiliary equipment)	MessTec	AN3016	060103	9kHz~30MHz	Oct. 14, 2021	Dec. 20, 2021	Oct. 13, 2022	Conduction (CO01-KS)
AC LISN	MessTec	AN3016	060105	9kHz~30MHz	Apr. 13, 2021	Dec. 20, 2021	Apr. 12, 2022	Conduction (CO01-KS)
AC Power Source	Chroma	61602	ABP00000811	AC 0V~300V, 45Hz~1000Hz	Oct. 14, 2021	Dec. 20, 2021	Oct. 13, 2022	Conduction (CO01-KS)

NCR: No Calibration Required



## 5 Uncertainty of Evaluation

### Uncertainty of Conducted Emission Measurement (150 kHz ~ 30 MHz)

Measuring Uncertainty for a Level of Confidence of 95% ( $U = 2Uc(y)$ )	2.94dB
---	--------

### Uncertainty of Radiated Emission Measurement (30 MHz ~ 1000 MHz)

Measuring Uncertainty for a Level of Confidence of 95% ( $U = 2Uc(y)$ )	5.0dB
---	-------

### Uncertainty of Radiated Emission Measurement (1000 MHz ~ 18000 MHz)

Measuring Uncertainty for a Level of Confidence of 95% ( $U = 2Uc(y)$ )	5.0dB
---	-------

### Uncertainty of Radiated Emission Measurement (18000 MHz ~ 40000 MHz)

Measuring Uncertainty for a Level of Confidence of 95% ( $U = 2Uc(y)$ )	5.0dB
---	-------



## Appendix A. Conducted Test Results

**Bluetooth Low Energy**

Test Engineer:	Jack Fan	Temperature:	20~26	°C
Test Date:	2021/12/22	Relative Humidity:	40~51	%

**TEST RESULTS DATA**  
**6dB and 99% Occupied Bandwidth**

Mod.	Data Rate	NTX	CH.	Freq. (MHz)	99% Occupied BW (MHz)	6dB BW (MHz)	6dB BW Limit (MHz)	Pass/Fail
BLE	1Mbps	1	0	2402	1.01	0.67	0.50	Pass
BLE	1Mbps	1	19	2440	1.01	0.67	0.50	Pass
BLE	1Mbps	1	39	2480	1.01	0.67	0.50	Pass

**TEST RESULTS DATA**  
**Peak Power Table**

Mod.	Data Rate	NTX	CH.	Freq. (MHz)	Peak Conducted Power (dBm)	Conducted Power Limit (dBm)	DG (dBi)	EIRP Power (dBm)	EIRP Power Limit (dBm)	Pass /Fail
BLE	1Mbps	1	0	2402	5.53	30.00	2.30	7.83	36.00	Pass
BLE	1Mbps	1	19	2440	5.44	30.00	2.30	7.74	36.00	Pass
BLE	1Mbps	1	39	2480	6.02	30.00	2.30	8.32	36.00	Pass

**TEST RESULTS DATA**  
**Average Power Table**  
**(Reporting Only)**

Mod.	Data Rate	NTX	CH.	Freq. (MHz)	Duty Factor (dB)	Average Conducted Power (dBm)
BLE	1Mbps	1	0	2402	2.07	5.34
BLE	1Mbps	1	19	2440	2.07	5.08
BLE	1Mbps	1	39	2480	2.07	5.68

**TEST RESULTS DATA**  
**Peak Power Density**

Mod.	Data Rate	NTX	CH.	Freq. (MHz)	Peak PSD (dBm /100kHz)	Peak PSD (dBm /3kHz)	DG (dBi)	Peak PSD Limit (dBm /3kHz)	Pass/Fail
BLE	1Mbps	1	0	2402	5.29	-8.98	2.30	8.00	Pass
BLE	1Mbps	1	19	2440	5.03	-9.42	2.30	8.00	Pass
BLE	1Mbps	1	39	2480	5.52	-9.21	2.30	8.00	Pass

Note: PSD (dBm/ 100kHz) is a reference level used for Conducted Band Edges and Conducted Spurious Emission 20dBc limit.

**Bluetooth Low Energy**

Test Engineer:	Jack Fan	Temperature:	20~26	°C
Test Date:	2021/12/22	Relative Humidity:	40~51	%

**TEST RESULTS DATA**  
***6dB and 99% Occupied Bandwidth***

Mod.	Data Rate	NTX	CH.	Freq. (MHz)	99% Occupied BW (MHz)	6dB BW (MHz)	6dB BW Limit (MHz)	Pass/Fail
BLE	2Mbps	1	0	2402	1.99	1.15	0.50	Pass
BLE	2Mbps	1	19	2440	1.99	1.15	0.50	Pass
BLE	2Mbps	1	39	2480	1.99	1.15	0.50	Pass

**TEST RESULTS DATA**  
***Peak Power Table***

Mod.	Data Rate	NTX	CH.	Freq. (MHz)	Peak Conducted Power (dBm)	Conducted Power Limit (dBm)	DG (dBi)	EIRP Power (dBm)	EIRP Power Limit (dBm)	Pass /Fail
BLE	2Mbps	1	0	2402	5.98	30.00	2.30	8.28	36.00	Pass
BLE	2Mbps	1	19	2440	5.89	30.00	2.30	8.19	36.00	Pass
BLE	2Mbps	1	39	2480	6.19	30.00	2.30	8.49	36.00	Pass

**TEST RESULTS DATA**  
***Average Power Table***  
***(Reporting Only)***

Mod.	Data Rate	NTX	CH.	Freq. (MHz)	Duty Factor (dB)	Average Conducted Power (dBm)
BLE	2Mbps	1	0	2402	4.89	5.50
BLE	2Mbps	1	19	2440	4.89	5.38
BLE	2Mbps	1	39	2480	4.89	5.67

**TEST RESULTS DATA**  
***Peak Power Density***

Mod.	Data Rate	NTX	CH.	Freq. (MHz)	Peak PSD (dBm /100kHz)	Peak PSD (dBm /3kHz)	DG (dBi)	Peak PSD Limit (dBm /3kHz)	Pass/Fail
BLE	2Mbps	1	0	2402	5.62	-12.12	2.30	8.00	Pass
BLE	2Mbps	1	19	2440	5.12	-12.36	2.30	8.00	Pass
BLE	2Mbps	1	39	2480	5.36	-12.20	2.30	8.00	Pass

Note: PSD (dBm/ 100kHz) is a reference level used for Conducted Band Edges and Conducted Spurious Emission 20dBc limit.



## Appendix B. AC Conducted Emission Test Results

Test Engineer :	Amos Zhang	Temperature :	25.3~26.2°C
		Relative Humidity :	38~40%
Test Voltage :	120Vac / 60Hz	Phase :	Line
Remark :	All emissions not reported here are more than 10 dB below the prescribed limit.		

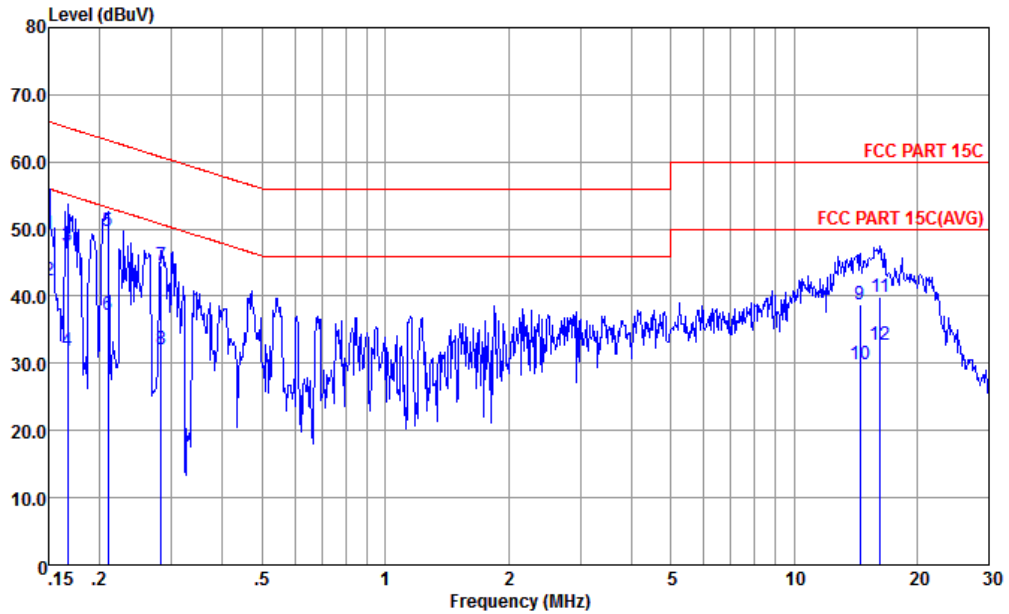

Site : CO01-KS  
 Condition : FCC PART 15C LISN-060105-L LINE

	Freq	Level	Over	Limit	Read	LISN	Cable	Remark
	MHz	dBuV	dB	dBuV	dBuV	dB	dB	
1	0.150	49.30	-16.70	66.00	38.80	0.02	10.48	QP
2	0.150	42.40	-13.60	56.00	31.90	0.02	10.48	Average
3	0.167	47.36	-17.76	65.12	36.89	0.03	10.44	QP
4	0.167	31.76	-23.36	55.12	21.29	0.03	10.44	Average
5 *	0.209	49.70	-13.53	63.23	39.30	0.04	10.36	QP
6	0.209	37.30	-15.93	53.23	26.90	0.04	10.36	Average
7	0.283	44.58	-16.14	60.72	34.19	0.07	10.32	QP
8	0.283	31.98	-18.74	50.72	21.59	0.07	10.32	Average
9	14.517	38.89	-21.11	60.00	28.21	0.29	10.39	QP
10	14.517	29.89	-20.11	50.00	19.21	0.29	10.39	Average
11	16.226	39.97	-20.03	60.00	29.20	0.35	10.42	QP
12	16.226	32.67	-17.33	50.00	21.90	0.35	10.42	Average





Test Engineer :	Amos Zhang	Temperature :	25.3~26.2°C
		Relative Humidity :	38~40%
Test Voltage :	120Vac / 60Hz	Phase :	Neutral
Remark :	All emissions not reported here are more than 10 dB below the prescribed limit.		

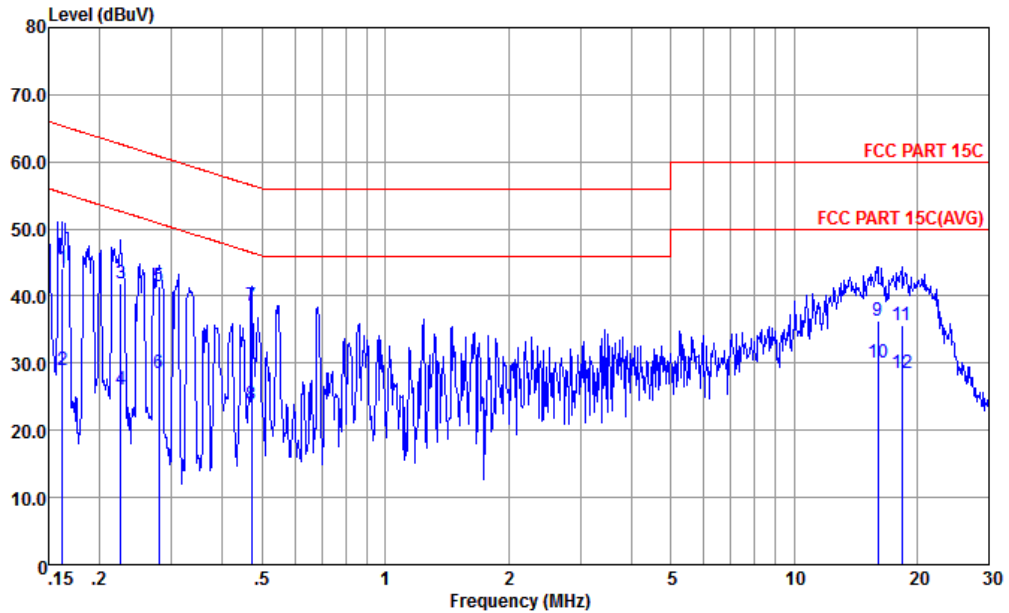

Site : CO01-KS  
Condition : FCC PART 15C LISN-060105-N NEUTRAL

	Freq	Level	Over	Limit	Read	LISN	Cable	Remark
	MHz	dBuV	dB	dBuV	dBuV	dB	dB	
1	0.162	44.15	-21.19	65.34	33.59	0.11	10.45	QP
2	0.162	29.05	-26.29	55.34	18.49	0.11	10.45	Average
3	0.226	41.95	-20.66	62.61	31.50	0.10	10.35	QP
4	0.226	26.05	-26.56	52.61	15.60	0.10	10.35	Average
5	0.279	41.52	-19.33	60.85	31.10	0.10	10.32	QP
6	0.279	28.62	-22.23	50.85	18.20	0.10	10.32	Average
7 *	0.471	38.55	-17.94	56.49	28.20	0.11	10.24	QP
8	0.471	23.95	-22.54	46.49	13.60	0.11	10.24	Average
9	16.055	36.38	-23.62	60.00	25.60	0.36	10.42	QP
10	16.055	29.98	-20.02	50.00	19.20	0.36	10.42	Average
11	18.328	35.72	-24.28	60.00	24.81	0.45	10.46	QP
12	18.328	28.52	-21.48	50.00	17.61	0.45	10.46	Average

Note:

- Level(dBμV) = Read Level(dBμV) + LISN Factor(dB) + Cable Loss(dB)
- Over Limit(dB) = Level(dBμV) – Limit Line(dBμV)



## Appendix C. Radiated Spurious Emission

Test Engineer :	Henry Li	Temperature :	22~23°C
		Relative Humidity :	41~42%

<1Mbps>

### 2.4GHz 2400~2483.5MHz

#### BLE (Band Edge @ 3m)

BLE	Note	Frequency	Level	Over	Limit	Read	Antenna	Path	Preamp	Ant	Table	Peak	Pol.
Ant				Limit	Line	Level	Factor	Loss	Factor	Pos	Pos	Avg.	
6		( MHz )	( dBμV/m )	( dB )	( dBμV/m )	( dBμV )	( dB/m )	( dB )	( dB )	( cm )	( deg )	( P/A )	( H/V )
BLE CH 00 2402MHz		2319.36	54.42	-19.58	74	49.63	30.71	7.04	32.96	183	68	P	H
		2389.82	44.19	-9.81	54	38.93	30.94	7.16	32.84	183	68	A	H
	*	2402	100.15	-	-	94.83	31	7.16	32.84	183	68	P	H
	*	2402	99.58	-	-	94.26	31	7.16	32.84	183	68	A	H
		2374.35	54.06	-19.94	74	48.93	30.88	7.13	32.88	391	97	P	V
		2382.8	44.2	-9.8	54	39.07	30.88	7.13	32.88	391	97	A	V
	*	2402	96.47	-	-	91.15	31	7.16	32.84	391	97	P	V
	*	2402	95.75	-	-	90.43	31	7.16	32.84	391	97	A	V
BLE CH 39 2480MHz		2483.8	55.13	-18.87	74	49.37	31.13	7.27	32.64	125	72	P	H
		2483.5	46.13	-7.87	54	40.37	31.13	7.27	32.64	125	72	A	H
	*	2480	99.91	-	-	94.15	31.13	7.27	32.64	125	72	P	H
	*	2480	99.12	-	-	93.36	31.13	7.27	32.64	125	72	A	H
		2496.52	54.57	-19.43	74	48.67	31.17	7.3	32.57	382	107	P	V
		2483.62	44.72	-9.28	54	38.96	31.13	7.27	32.64	382	107	A	V
	*	2480	94.66	-	-	88.9	31.13	7.27	32.64	382	107	P	V
	*	2480	94.18	-	-	88.42	31.13	7.27	32.64	382	107	A	V
Remark	1. No other spurious found.												
	2. All results are PASS against Peak and Average limit line.												



2.4GHz 2400~2483.5MHz
BLE (Harmonic @ 3m)

Table with 14 columns: BLE Ant 6, Note, Frequency (MHz), Level (dBµV/m), Over Limit (dB), Limit Line (dBµV/m), Read Level (dBµV), Antenna Factor (dB/m), Path Loss (dB), Preamp Factor (dB), Ant Pos (cm), Table Pos (deg), Peak Avg. (P/A), Pol. (H/V). Rows include data for BLE CH 00 (2402MHz), BLE CH 19 (2440MHz), and BLE CH 39 (2480MHz).



<2Mbps>

2.4GHz 2400~2483.5MHz

BLE (Band Edge @ 3m)

BLE Ant	Note	Frequency	Level	Over Limit	Limit Line	Read Level	Antenna Factor	Path Loss	Preamp Factor	Ant Pos	Table Pos	Peak Avg.	Pol.
6		( MHz )	( dBμV/m )	( dB )	( dBμV/m )	( dBμV )	( dB/m )	( dB )	( dB )	( cm )	( deg )	( P/A )	( H/V )
BLE CH 00 2402MHz		2345.36	53.8	-20.2	74	48.88	30.77	7.07	32.92	186	68	P	H
		2383.97	44.74	-9.26	54	39.55	30.94	7.13	32.88	186	68	A	H
	*	2402	100.63	-	-	95.31	31	7.16	32.84	186	68	P	H
	*	2402	99.3	-	-	93.98	31	7.16	32.84	186	68	A	H
		2345.88	54.71	-19.29	74	49.79	30.77	7.07	32.92	388	97	P	V
		2385.53	44.77	-9.23	54	39.55	30.94	7.16	32.88	388	97	A	V
	*	2402	96.74	-	-	91.42	31	7.16	32.84	388	97	P	V
	*	2402	95.38	-	-	90.06	31	7.16	32.84	388	97	A	V
BLE CH 39 2480MHz		2483.74	56.03	-17.97	74	50.27	31.13	7.27	32.64	124	72	P	H
		2483.5	47.99	-6.01	54	42.23	31.13	7.27	32.64	124	72	A	H
	*	2480	99.91	-	-	94.15	31.13	7.27	32.64	124	72	P	H
	*	2480	98.46	-	-	92.7	31.13	7.27	32.64	124	72	A	H
		2497.78	54.86	-19.14	74	48.96	31.17	7.3	32.57	371	96	P	V
		2483.5	46.12	-7.88	54	40.36	31.13	7.27	32.64	371	96	A	V
	*	2480	95.2	-	-	89.44	31.13	7.27	32.64	371	96	P	V
	*	2480	93.77	-	-	88.01	31.13	7.27	32.64	371	96	A	V
Remark	1. No other spurious found. 2. All results are PASS against Peak and Average limit line.												



2.4GHz 2400~2483.5MHz
BLE (Harmonic @ 3m)

Table with 14 columns: BLE Ant 6, Note, Frequency (MHz), Level (dBµV/m), Over Limit (dB), Limit Line (dBµV/m), Read Level (dBµV), Antenna Factor (dB/m), Path Loss (dB), Preamp Factor (dB), Ant Pos (cm), Table Pos (deg), Peak Avg. (P/A), Pol. (H/V). Rows include data for BLE CH 00 (2402MHz) and BLE CH 19 (2440MHz) and BLE CH 39 (2480MHz).

Remark

- 1. No other spurious found.
2. All results are PASS against Peak and Average limit line.



Emission below 1GHz

2.4GHz BLE (LF)

BLE	Note	Frequency	Level	Over	Limit	Read	Antenna	Path	Preamp	Ant	Table	Peak	Pol.
Ant				Limit	Line	Level	Factor	Loss	Factor	Pos	Pos	Avg.	
6		( MHz )	( dBμV/m )	( dB )	( dBμV/m )	( dBμV )	( dB/m )	( dB )	( dB )	( cm )	( deg )	( P/A )	( H/V )
2.4GHz BLE LF		30.97	21.64	-18.36	40	28.26	24.04	0.59	31.25	-	-	P	H
		155.13	17.93	-25.57	43.5	30.99	16.25	2.01	31.32	-	-	P	H
		186.17	21.36	-22.14	43.5	35.36	15.12	2.21	31.33	-	-	P	H
		289.96	25.2	-20.8	46	34.68	19.35	2.76	31.59	-	-	P	H
		762.35	28.39	-17.61	46	29.31	25.73	4.49	31.14	-	-	P	H
		899.12	28.73	-17.27	46	28.3	26.69	4.89	31.15	-	-	P	H
		30	27.7	-12.3	40	33.75	24.6	0.58	31.23	-	-	P	V
		53.28	20.82	-19.18	40	37.62	13.62	0.93	31.35	-	-	P	V
		281.23	20.49	-25.51	46	29.93	19.39	2.71	31.54	-	-	P	V
		485.9	24	-22	46	28.55	23.17	3.58	31.3	-	-	P	V
		765.26	29.14	-16.86	46	30.06	25.73	4.5	31.15	-	-	P	V
	953.44	30.53	-15.47	46	28.89	26.94	5.03	30.33	-	-	P	V	
Remark	1. No other spurious found. 2. All results are PASS against limit line.												



**Note symbol**

*	<b>Fundamental Frequency</b> which can be ignored. However, the level of any unwanted emissions shall not exceed the level of the fundamental frequency.
!	Test result is <b>over limit</b> line.
P/A	<b>Peak</b> or <b>Average</b>
H/V	<b>Horizontal</b> or <b>Vertical</b>



A calculation example for radiated spurious emission is shown as below:

BLE	Note	Frequency	Level	Over	Limit	Read	Antenna	Path	Preamp	Ant	Table	Peak	Pol.
		( MHz )	( dBμV/m )	( dB )	( dBμV/m )	( dBμV )	( dB/m )	( dB )	( dB )	( cm )	( deg )	( P/A )	( H/V )
BLE CH 00 2402MHz		2390	55.45	-18.55	74	54.51	32.22	4.58	35.86	103	308	P	H
		2390	43.54	-10.46	54	42.6	32.22	4.58	35.86	103	308	A	H

1. Path Loss(dB) = Cable loss(dB) + Filter loss(dB) + Attenuator loss(dB)
2. Level(dBμV/m) =  
Antenna Factor(dB/m) + Path Loss(dB) + Read Level(dBμV) - Preamp Factor(dB)
3. Over Limit(dB) = Level(dBμV/m) – Limit Line(dBμV/m)

**For Peak Limit @ 2390MHz:**

1. Level(dBμV/m)  
= Antenna Factor(dB/m) + Path Loss(dB) + Read Level(dBμV) - Preamp Factor(dB)  
= 32.22(dB/m) + 4.58(dB) + 54.51(dBμV) – 35.86 (dB)  
= 55.45 (dBμV/m)
2. Over Limit(dB)  
= Level(dBμV/m) – Limit Line(dBμV/m)  
= 55.45(dBμV/m) – 74(dBμV/m)  
= -18.55(dB)

**For Average Limit @ 2390MHz:**

1. Level(dBμV/m)  
= Antenna Factor(dB/m) + Path Loss(dB) + Read Level(dBμV) - Preamp Factor(dB)  
= 32.22(dB/m) + 4.58(dB) + 42.6(dBμV) – 35.86 (dB)  
= 43.54 (dBμV/m)
2. Over Limit(dB)  
= Level(dBμV/m) – Limit Line(dBμV/m)  
= 43.54(dBμV/m) – 54(dBμV/m)  
= -10.46(dB)

Both peak and average measured complies with the limit line, so test result is “PASS”.





## Appendix D. Radiated Spurious Emission Plots

Test Engineer :	Henry Li	Temperature :	22~23°C
		Relative Humidity :	41~42%

<1Mbps>

2.4GHz 2400~2483.5MHz

BLE (Band Edge @ 3m)

BLE	2.4GHz 2400~2483.5MHz Band Edge @ 3m	
ANT	BLE CH00 2402MHz	
6	Horizontal	Fundamental
Peak	<pre> Site      : 03CHMS-KS Condition : FCC PART 15C 3m 3117 SN 00218842 HORIZONTAL Project   : FR1D0310B Mode      : 4 Plane     : X           : Single-directivity IMEI      : #6    Freq  Level  Over  Limit  Read  CableAntenna  Preamp  A/Pos  T/Pos  Remark   MHz  dBV/m  dB  dBV/m  dBV  dB  dB/m  dB  cm  deg 1  2402.00  54.42 -19.58  74.00  49.63  7.04  30.71  32.96  183  68 Peak           </pre>	<pre> Site      : 03CHMS-KS Condition : FCC PART 15C 3m 3117 SN 00218842 HORIZONTAL Project   : FR1D0310B Mode      : 4 Plane     : X           : Single-directivity IMEI      : #6    Freq  Level  Over  Limit  Read  CableAntenna  Preamp  A/Pos  T/Pos  Remark   MHz  dBV/m  dB  dBV/m  dBV  dB  dB/m  dB  cm  deg 1 * 2402.00  26.15  74.00  94.83  7.16  31.00  32.84  183  68 Peak           </pre>





BLE	2.4GHz 2400~2483.5MHz Band Edge @ 3m																																																															
ANT	BLE CH00 2402MHz																																																															
6	Vertical	Fundamental																																																														
<b>Peak</b>	<p>Site : 83085-K5 Condition : FCC PART 15C 3e 3117 5M 80215841 VERTICAL Project : R8U 1000.000KHZ VSW:3000.000KHZ SMT:Auto Mode : 4 Plane : X Polar : Single-directivity IMEI : #0</p> <table border="1"> <thead> <tr> <th>Freq</th> <th>Level</th> <th>Over</th> <th>Limit</th> <th>Read</th> <th>Cable/Antenna</th> <th>Preamp</th> <th>A/Pos</th> <th>T/Pos</th> <th>Remark</th> </tr> <tr> <th>MHz</th> <th>dBuV/m</th> <th>dB</th> <th>dBuV/m</th> <th>dBuV</th> <th>dB</th> <th>dB/m</th> <th>dB</th> <th>cm</th> <th>deg</th> </tr> </thead> <tbody> <tr> <td>1</td> <td>2374.35</td> <td>54.06</td> <td>-19.34</td> <td>74.00</td> <td>48.93</td> <td>7.13</td> <td>38.88</td> <td>32.88</td> <td>391</td> <td>97 Peak</td> </tr> </tbody> </table>	Freq	Level	Over	Limit	Read	Cable/Antenna	Preamp	A/Pos	T/Pos	Remark	MHz	dBuV/m	dB	dBuV/m	dBuV	dB	dB/m	dB	cm	deg	1	2374.35	54.06	-19.34	74.00	48.93	7.13	38.88	32.88	391	97 Peak	<p>Site : 83085-K5 Condition : FCC PART 15C 3e 3117 5M 80215841 VERTICAL Project : R8U 1000.000KHZ VSW:3000.000KHZ SMT:Auto Mode : 4 Plane : X Polar : Single-directivity IMEI : #0</p> <table border="1"> <thead> <tr> <th>Freq</th> <th>Level</th> <th>Over</th> <th>Limit</th> <th>Read</th> <th>Cable/Antenna</th> <th>Preamp</th> <th>A/Pos</th> <th>T/Pos</th> <th>Remark</th> </tr> <tr> <th>MHz</th> <th>dBuV/m</th> <th>dB</th> <th>dBuV/m</th> <th>dBuV</th> <th>dB</th> <th>dB/m</th> <th>dB</th> <th>cm</th> <th>deg</th> </tr> </thead> <tbody> <tr> <td>1 *</td> <td>2402.00</td> <td>96.47</td> <td>22.47</td> <td>74.00</td> <td>91.15</td> <td>7.16</td> <td>31.00</td> <td>32.84</td> <td>391</td> <td>97 Peak</td> </tr> </tbody> </table>	Freq	Level	Over	Limit	Read	Cable/Antenna	Preamp	A/Pos	T/Pos	Remark	MHz	dBuV/m	dB	dBuV/m	dBuV	dB	dB/m	dB	cm	deg	1 *	2402.00	96.47	22.47	74.00	91.15	7.16	31.00	32.84	391	97 Peak
Freq	Level	Over	Limit	Read	Cable/Antenna	Preamp	A/Pos	T/Pos	Remark																																																							
MHz	dBuV/m	dB	dBuV/m	dBuV	dB	dB/m	dB	cm	deg																																																							
1	2374.35	54.06	-19.34	74.00	48.93	7.13	38.88	32.88	391	97 Peak																																																						
Freq	Level	Over	Limit	Read	Cable/Antenna	Preamp	A/Pos	T/Pos	Remark																																																							
MHz	dBuV/m	dB	dBuV/m	dBuV	dB	dB/m	dB	cm	deg																																																							
1 *	2402.00	96.47	22.47	74.00	91.15	7.16	31.00	32.84	391	97 Peak																																																						
<b>Avg</b>	<p>Site : 83085-K5 Condition : FCC PART 15C (AVG) 3e 3117 5M 80215841 VERTICAL Project : R8U 1000.000KHZ VSW:2.700KHZ SMT:Auto Mode : 4 Plane : X Polar : Single-directivity IMEI : #0</p> <table border="1"> <thead> <tr> <th>Freq</th> <th>Level</th> <th>Over</th> <th>Limit</th> <th>Read</th> <th>Cable/Antenna</th> <th>Preamp</th> <th>A/Pos</th> <th>T/Pos</th> <th>Remark</th> </tr> <tr> <th>MHz</th> <th>dBuV/m</th> <th>dB</th> <th>dBuV/m</th> <th>dBuV</th> <th>dB</th> <th>dB/m</th> <th>dB</th> <th>cm</th> <th>deg</th> </tr> </thead> <tbody> <tr> <td>1</td> <td>2382.09</td> <td>44.20</td> <td>-9.00</td> <td>54.00</td> <td>39.87</td> <td>7.13</td> <td>38.88</td> <td>32.88</td> <td>391</td> <td>97 Average</td> </tr> </tbody> </table>	Freq	Level	Over	Limit	Read	Cable/Antenna	Preamp	A/Pos	T/Pos	Remark	MHz	dBuV/m	dB	dBuV/m	dBuV	dB	dB/m	dB	cm	deg	1	2382.09	44.20	-9.00	54.00	39.87	7.13	38.88	32.88	391	97 Average	<p>Site : 83085-K5 Condition : FCC PART 15C (AVG) 3e 3117 5M 80215841 VERTICAL Project : R8U 1000.000KHZ VSW:2.700KHZ SMT:Auto Mode : 4 Plane : X Polar : Single-directivity IMEI : #0</p> <table border="1"> <thead> <tr> <th>Freq</th> <th>Level</th> <th>Over</th> <th>Limit</th> <th>Read</th> <th>Cable/Antenna</th> <th>Preamp</th> <th>A/Pos</th> <th>T/Pos</th> <th>Remark</th> </tr> <tr> <th>MHz</th> <th>dBuV/m</th> <th>dB</th> <th>dBuV/m</th> <th>dBuV</th> <th>dB</th> <th>dB/m</th> <th>dB</th> <th>cm</th> <th>deg</th> </tr> </thead> <tbody> <tr> <td>1 *</td> <td>2402.00</td> <td>95.75</td> <td>41.75</td> <td>54.00</td> <td>90.43</td> <td>7.16</td> <td>31.00</td> <td>32.84</td> <td>391</td> <td>97 Average</td> </tr> </tbody> </table>	Freq	Level	Over	Limit	Read	Cable/Antenna	Preamp	A/Pos	T/Pos	Remark	MHz	dBuV/m	dB	dBuV/m	dBuV	dB	dB/m	dB	cm	deg	1 *	2402.00	95.75	41.75	54.00	90.43	7.16	31.00	32.84	391	97 Average
Freq	Level	Over	Limit	Read	Cable/Antenna	Preamp	A/Pos	T/Pos	Remark																																																							
MHz	dBuV/m	dB	dBuV/m	dBuV	dB	dB/m	dB	cm	deg																																																							
1	2382.09	44.20	-9.00	54.00	39.87	7.13	38.88	32.88	391	97 Average																																																						
Freq	Level	Over	Limit	Read	Cable/Antenna	Preamp	A/Pos	T/Pos	Remark																																																							
MHz	dBuV/m	dB	dBuV/m	dBuV	dB	dB/m	dB	cm	deg																																																							
1 *	2402.00	95.75	41.75	54.00	90.43	7.16	31.00	32.84	391	97 Average																																																						

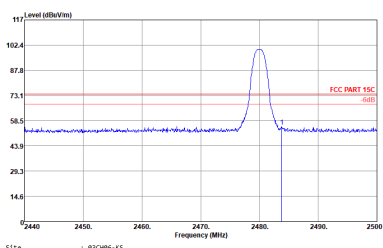
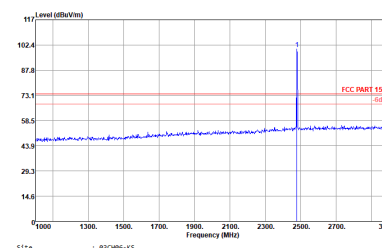
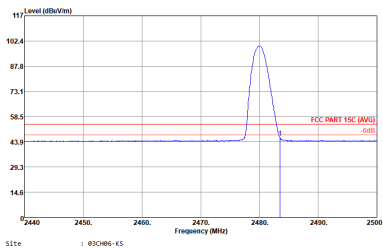
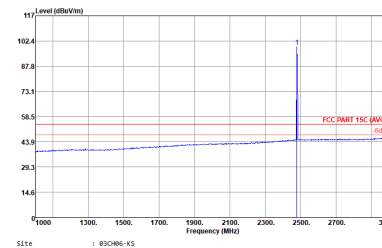

BLE	2.4GHz 2400~2483.5MHz Band Edge @ 3m																																																											
ANT	BLE CH39 2480MHz																																																											
6	Horizontal	Fundamental																																																										
<b>Peak</b>	 <p>Site : 83086-K5 Condition : FCC PART 15C 3m 3117 SN 00138642 HORIZONTAL Project : R01:1000.000000 V01:3000.000000 SMT:Auto Model : (FR)100310 Plane : X Single-directivity : Single-directivity IMEI : #5</p> <table border="1"> <thead> <tr> <th>IMEI</th> <th>Over</th> <th>Limit</th> <th>Read</th> <th>CableAntenna</th> <th>Preamp</th> <th>A/Pos</th> <th>T/Pos</th> <th>Remark</th> </tr> <tr> <th>Hz</th> <th>dBuV/m</th> <th>dB</th> <th>dBuV/m</th> <th>dBuV</th> <th>dB</th> <th>dB/m</th> <th>cm</th> <th>deg</th> </tr> </thead> <tbody> <tr> <td>1</td> <td>2483.00</td> <td>55.15</td> <td>-10.87</td> <td>74.00</td> <td>49.37</td> <td>7.27</td> <td>31.13</td> <td>32.64</td> <td>125</td> <td>72 Peak</td> </tr> </tbody> </table>	IMEI	Over	Limit	Read	CableAntenna	Preamp	A/Pos	T/Pos	Remark	Hz	dBuV/m	dB	dBuV/m	dBuV	dB	dB/m	cm	deg	1	2483.00	55.15	-10.87	74.00	49.37	7.27	31.13	32.64	125	72 Peak	 <p>Site : 83086-K5 Condition : FCC PART 15C 3m 3117 SN 00138642 HORIZONTAL Project : R01:1000.000000 V01:3000.000000 SMT:Auto Model : (FR)100310 Plane : X Single-directivity : Single-directivity IMEI : #5</p> <table border="1"> <thead> <tr> <th>IMEI</th> <th>Over</th> <th>Limit</th> <th>Read</th> <th>CableAntenna</th> <th>Preamp</th> <th>A/Pos</th> <th>T/Pos</th> <th>Remark</th> </tr> <tr> <th>Hz</th> <th>dBuV/m</th> <th>dB</th> <th>dBuV/m</th> <th>dBuV</th> <th>dB</th> <th>dB/m</th> <th>cm</th> <th>deg</th> </tr> </thead> <tbody> <tr> <td>1 *</td> <td>2480.00</td> <td>99.91</td> <td>25.91</td> <td>74.00</td> <td>94.15</td> <td>7.27</td> <td>31.13</td> <td>32.64</td> <td>125</td> <td>72 Peak</td> </tr> </tbody> </table>	IMEI	Over	Limit	Read	CableAntenna	Preamp	A/Pos	T/Pos	Remark	Hz	dBuV/m	dB	dBuV/m	dBuV	dB	dB/m	cm	deg	1 *	2480.00	99.91	25.91	74.00	94.15	7.27	31.13	32.64	125	72 Peak
IMEI	Over	Limit	Read	CableAntenna	Preamp	A/Pos	T/Pos	Remark																																																				
Hz	dBuV/m	dB	dBuV/m	dBuV	dB	dB/m	cm	deg																																																				
1	2483.00	55.15	-10.87	74.00	49.37	7.27	31.13	32.64	125	72 Peak																																																		
IMEI	Over	Limit	Read	CableAntenna	Preamp	A/Pos	T/Pos	Remark																																																				
Hz	dBuV/m	dB	dBuV/m	dBuV	dB	dB/m	cm	deg																																																				
1 *	2480.00	99.91	25.91	74.00	94.15	7.27	31.13	32.64	125	72 Peak																																																		
<b>Avg.</b>	 <p>Site : 83086-K5 Condition : FCC PART 15C (AVG) 3m 3117 SN 00138642 HORIZONTAL Project : R01:1000.000000 V01:3000.000000 SMT:Auto Model : (FR)100310 Plane : X Single-directivity : Single-directivity IMEI : #5</p> <table border="1"> <thead> <tr> <th>IMEI</th> <th>Over</th> <th>Limit</th> <th>Read</th> <th>CableAntenna</th> <th>Preamp</th> <th>A/Pos</th> <th>T/Pos</th> <th>Remark</th> </tr> <tr> <th>Hz</th> <th>dBuV/m</th> <th>dB</th> <th>dBuV/m</th> <th>dBuV</th> <th>dB</th> <th>dB/m</th> <th>cm</th> <th>deg</th> </tr> </thead> <tbody> <tr> <td>1</td> <td>2483.50</td> <td>46.15</td> <td>-7.87</td> <td>54.00</td> <td>40.37</td> <td>7.27</td> <td>31.13</td> <td>32.64</td> <td>125</td> <td>72 Average</td> </tr> </tbody> </table>	IMEI	Over	Limit	Read	CableAntenna	Preamp	A/Pos	T/Pos	Remark	Hz	dBuV/m	dB	dBuV/m	dBuV	dB	dB/m	cm	deg	1	2483.50	46.15	-7.87	54.00	40.37	7.27	31.13	32.64	125	72 Average	 <p>Site : 83086-K5 Condition : FCC PART 15C (AVG) 3m 3117 SN 00138642 HORIZONTAL Project : R01:1000.000000 V01:3000.000000 SMT:Auto Model : (FR)100310 Plane : X Single-directivity : Single-directivity IMEI : #5</p> <table border="1"> <thead> <tr> <th>IMEI</th> <th>Over</th> <th>Limit</th> <th>Read</th> <th>CableAntenna</th> <th>Preamp</th> <th>A/Pos</th> <th>T/Pos</th> <th>Remark</th> </tr> <tr> <th>Hz</th> <th>dBuV/m</th> <th>dB</th> <th>dBuV/m</th> <th>dBuV</th> <th>dB</th> <th>dB/m</th> <th>cm</th> <th>deg</th> </tr> </thead> <tbody> <tr> <td>1 *</td> <td>2480.00</td> <td>99.12</td> <td>45.12</td> <td>54.00</td> <td>93.36</td> <td>7.27</td> <td>31.13</td> <td>32.64</td> <td>125</td> <td>72 Average</td> </tr> </tbody> </table>	IMEI	Over	Limit	Read	CableAntenna	Preamp	A/Pos	T/Pos	Remark	Hz	dBuV/m	dB	dBuV/m	dBuV	dB	dB/m	cm	deg	1 *	2480.00	99.12	45.12	54.00	93.36	7.27	31.13	32.64	125	72 Average
IMEI	Over	Limit	Read	CableAntenna	Preamp	A/Pos	T/Pos	Remark																																																				
Hz	dBuV/m	dB	dBuV/m	dBuV	dB	dB/m	cm	deg																																																				
1	2483.50	46.15	-7.87	54.00	40.37	7.27	31.13	32.64	125	72 Average																																																		
IMEI	Over	Limit	Read	CableAntenna	Preamp	A/Pos	T/Pos	Remark																																																				
Hz	dBuV/m	dB	dBuV/m	dBuV	dB	dB/m	cm	deg																																																				
1 *	2480.00	99.12	45.12	54.00	93.36	7.27	31.13	32.64	125	72 Average																																																		



BLE	2.4GHz 2400~2483.5MHz Band Edge @ 3m																																																																															
ANT	BLE CH39 2480MHz																																																																															
6	Vertical	Fundamental																																																																														
<b>Peak</b>	<p>Site : 83086-K5            Condition : FCC PART 15C 3e 3117 5M 00218642 VERTICAL            Project : R061000.000000 VSW:1.700000 SMT:Auto            Model : (FR)1D0310B            Plane : X            Mode : S            Antenna : Single-directivity            IPE1 : #6</p> <table border="1"> <thead> <tr> <th>Over</th> <th>Limit</th> <th>Read</th> <th>Cable</th> <th>Antenna</th> <th>Preamp</th> <th>A/Pos</th> <th>T/Pos</th> <th>Remark</th> </tr> <tr> <th>Freq</th> <th>Level</th> <th>Limit</th> <th>Level</th> <th>Loss</th> <th>Factor</th> <th>Factor</th> <th>cm</th> <th>deg</th> </tr> <tr> <th>MHz</th> <th>dBuV/m</th> <th>dB</th> <th>dBuV/m</th> <th>dB</th> <th>dB/m</th> <th>dB</th> <th>cm</th> <th>deg</th> </tr> </thead> <tbody> <tr> <td>1</td> <td>2496.52</td> <td>54.57</td> <td>-19.43</td> <td>74.00</td> <td>48.67</td> <td>7.30</td> <td>31.17</td> <td>32.57</td> <td>382</td> <td>187</td> <td>Peak</td> </tr> </tbody> </table>	Over	Limit	Read	Cable	Antenna	Preamp	A/Pos	T/Pos	Remark	Freq	Level	Limit	Level	Loss	Factor	Factor	cm	deg	MHz	dBuV/m	dB	dBuV/m	dB	dB/m	dB	cm	deg	1	2496.52	54.57	-19.43	74.00	48.67	7.30	31.17	32.57	382	187	Peak	<p>Site : 83086-K5            Condition : FCC PART 15C 3e 3117 5M 00218642 VERTICAL            Project : R061000.000000 VSW:1.700000 SMT:Auto            Model : (FR)1D0310B            Plane : X            Mode : S            Antenna : Single-directivity            IPE1 : #6</p> <table border="1"> <thead> <tr> <th>Over</th> <th>Limit</th> <th>Read</th> <th>Cable</th> <th>Antenna</th> <th>Preamp</th> <th>A/Pos</th> <th>T/Pos</th> <th>Remark</th> </tr> <tr> <th>Freq</th> <th>Level</th> <th>Limit</th> <th>Level</th> <th>Loss</th> <th>Factor</th> <th>Factor</th> <th>cm</th> <th>deg</th> </tr> <tr> <th>MHz</th> <th>dBuV/m</th> <th>dB</th> <th>dBuV/m</th> <th>dB</th> <th>dB/m</th> <th>dB</th> <th>cm</th> <th>deg</th> </tr> </thead> <tbody> <tr> <td>1 *</td> <td>2480.00</td> <td>94.66</td> <td>20.66</td> <td>74.00</td> <td>68.90</td> <td>7.27</td> <td>31.13</td> <td>32.64</td> <td>382</td> <td>187</td> <td>Peak</td> </tr> </tbody> </table>	Over	Limit	Read	Cable	Antenna	Preamp	A/Pos	T/Pos	Remark	Freq	Level	Limit	Level	Loss	Factor	Factor	cm	deg	MHz	dBuV/m	dB	dBuV/m	dB	dB/m	dB	cm	deg	1 *	2480.00	94.66	20.66	74.00	68.90	7.27	31.13	32.64	382	187	Peak
Over	Limit	Read	Cable	Antenna	Preamp	A/Pos	T/Pos	Remark																																																																								
Freq	Level	Limit	Level	Loss	Factor	Factor	cm	deg																																																																								
MHz	dBuV/m	dB	dBuV/m	dB	dB/m	dB	cm	deg																																																																								
1	2496.52	54.57	-19.43	74.00	48.67	7.30	31.17	32.57	382	187	Peak																																																																					
Over	Limit	Read	Cable	Antenna	Preamp	A/Pos	T/Pos	Remark																																																																								
Freq	Level	Limit	Level	Loss	Factor	Factor	cm	deg																																																																								
MHz	dBuV/m	dB	dBuV/m	dB	dB/m	dB	cm	deg																																																																								
1 *	2480.00	94.66	20.66	74.00	68.90	7.27	31.13	32.64	382	187	Peak																																																																					
<b>Avg.</b>	<p>Site : 83086-K5            Condition : FCC PART 15C (AVG) 3e 3117 5M 00218642 VERTICAL            Project : R061000.000000 VSW:1.700000 SMT:Auto            Model : (FR)1D0310B            Plane : X            Mode : S            Antenna : Single-directivity            IPE1 : #6</p> <table border="1"> <thead> <tr> <th>Over</th> <th>Limit</th> <th>Read</th> <th>Cable</th> <th>Antenna</th> <th>Preamp</th> <th>A/Pos</th> <th>T/Pos</th> <th>Remark</th> </tr> <tr> <th>Freq</th> <th>Level</th> <th>Limit</th> <th>Level</th> <th>Loss</th> <th>Factor</th> <th>Factor</th> <th>cm</th> <th>deg</th> </tr> <tr> <th>MHz</th> <th>dBuV/m</th> <th>dB</th> <th>dBuV/m</th> <th>dB</th> <th>dB/m</th> <th>dB</th> <th>cm</th> <th>deg</th> </tr> </thead> <tbody> <tr> <td>1</td> <td>2483.62</td> <td>44.72</td> <td>-9.28</td> <td>54.00</td> <td>38.96</td> <td>7.27</td> <td>31.13</td> <td>32.64</td> <td>382</td> <td>187</td> <td>Average</td> </tr> </tbody> </table>	Over	Limit	Read	Cable	Antenna	Preamp	A/Pos	T/Pos	Remark	Freq	Level	Limit	Level	Loss	Factor	Factor	cm	deg	MHz	dBuV/m	dB	dBuV/m	dB	dB/m	dB	cm	deg	1	2483.62	44.72	-9.28	54.00	38.96	7.27	31.13	32.64	382	187	Average	<p>Site : 83086-K5            Condition : FCC PART 15C (AVG) 3e 3117 5M 00218642 VERTICAL            Project : R061000.000000 VSW:1.700000 SMT:Auto            Model : (FR)1D0310B            Plane : X            Mode : S            Antenna : Single-directivity            IPE1 : #6</p> <table border="1"> <thead> <tr> <th>Over</th> <th>Limit</th> <th>Read</th> <th>Cable</th> <th>Antenna</th> <th>Preamp</th> <th>A/Pos</th> <th>T/Pos</th> <th>Remark</th> </tr> <tr> <th>Freq</th> <th>Level</th> <th>Limit</th> <th>Level</th> <th>Loss</th> <th>Factor</th> <th>Factor</th> <th>cm</th> <th>deg</th> </tr> <tr> <th>MHz</th> <th>dBuV/m</th> <th>dB</th> <th>dBuV/m</th> <th>dB</th> <th>dB/m</th> <th>dB</th> <th>cm</th> <th>deg</th> </tr> </thead> <tbody> <tr> <td>1 *</td> <td>2480.00</td> <td>94.18</td> <td>40.18</td> <td>54.00</td> <td>66.42</td> <td>7.27</td> <td>31.13</td> <td>32.64</td> <td>382</td> <td>187</td> <td>Average</td> </tr> </tbody> </table>	Over	Limit	Read	Cable	Antenna	Preamp	A/Pos	T/Pos	Remark	Freq	Level	Limit	Level	Loss	Factor	Factor	cm	deg	MHz	dBuV/m	dB	dBuV/m	dB	dB/m	dB	cm	deg	1 *	2480.00	94.18	40.18	54.00	66.42	7.27	31.13	32.64	382	187	Average
Over	Limit	Read	Cable	Antenna	Preamp	A/Pos	T/Pos	Remark																																																																								
Freq	Level	Limit	Level	Loss	Factor	Factor	cm	deg																																																																								
MHz	dBuV/m	dB	dBuV/m	dB	dB/m	dB	cm	deg																																																																								
1	2483.62	44.72	-9.28	54.00	38.96	7.27	31.13	32.64	382	187	Average																																																																					
Over	Limit	Read	Cable	Antenna	Preamp	A/Pos	T/Pos	Remark																																																																								
Freq	Level	Limit	Level	Loss	Factor	Factor	cm	deg																																																																								
MHz	dBuV/m	dB	dBuV/m	dB	dB/m	dB	cm	deg																																																																								
1 *	2480.00	94.18	40.18	54.00	66.42	7.27	31.13	32.64	382	187	Average																																																																					







BLE	2.4GHz 2400~2483.5MHz Harmonic @ 3m																																																																													
ANT	BLE CH39 2480MHz																																																																													
6	Horizontal	Vertical																																																																												
Peak	<p>Site : 83C86-A5            Condition : FCC PART 15C 3m 2117 SM 00218641 HORIZONTAL            Project : RMU 1000.000KHZ VSW:3000.000KHZ SMT:Auto            Model : (FR)100310            Plane : X            Plane : Single-directivity            IMN1 : 90</p> <table border="1"> <thead> <tr> <th>Over</th> <th>Limit</th> <th>Read</th> <th>Cable</th> <th>Antenna</th> <th>Preamp</th> <th>A/Pos</th> <th>T/Pos</th> <th>Remark</th> </tr> <tr> <th>Freq</th> <th>Level</th> <th>Line</th> <th>Loss</th> <th>Factor</th> <th>Factor</th> <th>dB</th> <th>dB</th> <th></th> </tr> </thead> <tbody> <tr> <td>1</td> <td>4905.00</td> <td>42.03</td> <td>-31.37</td> <td>74.00</td> <td>57.46</td> <td>38.43</td> <td>36.83</td> <td>60.81</td> <td>0 Peak</td> </tr> <tr> <td>2</td> <td>7440.00</td> <td>44.04</td> <td>-29.96</td> <td>74.00</td> <td>55.11</td> <td>12.80</td> <td>36.59</td> <td>60.54</td> <td>0 Peak</td> </tr> </tbody> </table>	Over	Limit	Read	Cable	Antenna	Preamp	A/Pos	T/Pos	Remark	Freq	Level	Line	Loss	Factor	Factor	dB	dB		1	4905.00	42.03	-31.37	74.00	57.46	38.43	36.83	60.81	0 Peak	2	7440.00	44.04	-29.96	74.00	55.11	12.80	36.59	60.54	0 Peak	<p>Site : 83C86-A5            Condition : FCC PART 15C 3m 2117 SM 00218643 VERTICAL            Project : RMU 1000.000KHZ VSW:3000.000KHZ SMT:Auto            Model : (FR)100310            Plane : X            Plane : Single-directivity            IMN1 : 90</p> <table border="1"> <thead> <tr> <th>Over</th> <th>Limit</th> <th>Read</th> <th>Cable</th> <th>Antenna</th> <th>Preamp</th> <th>A/Pos</th> <th>T/Pos</th> <th>Remark</th> </tr> <tr> <th>Freq</th> <th>Level</th> <th>Line</th> <th>Loss</th> <th>Factor</th> <th>Factor</th> <th>dB</th> <th>dB</th> <th></th> </tr> </thead> <tbody> <tr> <td>1</td> <td>4905.00</td> <td>43.20</td> <td>-30.71</td> <td>74.00</td> <td>56.00</td> <td>38.43</td> <td>36.61</td> <td>60.81</td> <td>0 Peak</td> </tr> <tr> <td>2</td> <td>7440.00</td> <td>45.17</td> <td>-28.63</td> <td>74.00</td> <td>56.44</td> <td>12.80</td> <td>36.59</td> <td>60.54</td> <td>0 Peak</td> </tr> </tbody> </table>	Over	Limit	Read	Cable	Antenna	Preamp	A/Pos	T/Pos	Remark	Freq	Level	Line	Loss	Factor	Factor	dB	dB		1	4905.00	43.20	-30.71	74.00	56.00	38.43	36.61	60.81	0 Peak	2	7440.00	45.17	-28.63	74.00	56.44	12.80	36.59	60.54	0 Peak
	Over	Limit	Read	Cable	Antenna	Preamp	A/Pos	T/Pos	Remark																																																																					
Freq	Level	Line	Loss	Factor	Factor	dB	dB																																																																							
1	4905.00	42.03	-31.37	74.00	57.46	38.43	36.83	60.81	0 Peak																																																																					
2	7440.00	44.04	-29.96	74.00	55.11	12.80	36.59	60.54	0 Peak																																																																					
Over	Limit	Read	Cable	Antenna	Preamp	A/Pos	T/Pos	Remark																																																																						
Freq	Level	Line	Loss	Factor	Factor	dB	dB																																																																							
1	4905.00	43.20	-30.71	74.00	56.00	38.43	36.61	60.81	0 Peak																																																																					
2	7440.00	45.17	-28.63	74.00	56.44	12.80	36.59	60.54	0 Peak																																																																					





<2Mbps>

2.4GHz 2400~2483.5MHz  
BLE (Band Edge @ 3m)

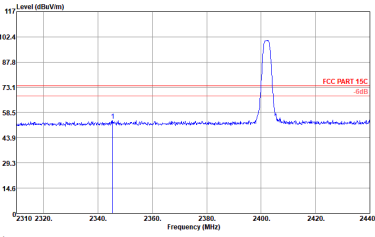
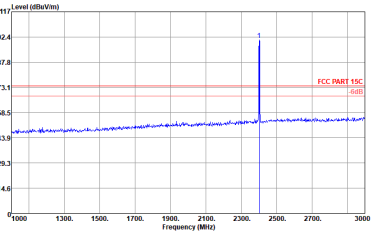
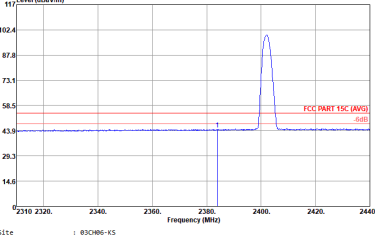
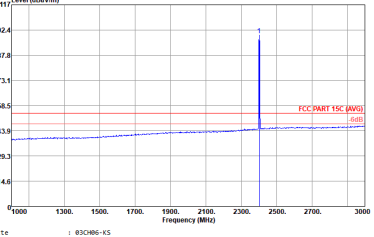
BLE	2.4GHz 2400~2483.5MHz Band Edge @ 3m																																																																			
ANT	BLE CH00 2402MHz																																																																			
6	Horizontal	Fundamental																																																																		
<b>Peak</b>	 <p>Site : 83086-K5 Condition : FCC PART 15C 3m 3117 SN 00218642 HORIZONTAL Project : FR1D0310B Mode : J Plane : X Single-directivity : X IMEI : 95</p> <table border="1"> <thead> <tr> <th>1</th> <th>Freq</th> <th>Level</th> <th>Over</th> <th>Limit</th> <th>Read</th> <th>CableAntenna</th> <th>Preamp</th> <th>A/Pos</th> <th>T/Pos</th> <th>Remark</th> </tr> <tr> <th></th> <th>MHz</th> <th>dBm</th> <th>dB</th> <th>dBm</th> <th>dBm</th> <th>dB</th> <th>dB</th> <th>cm</th> <th>deg</th> <th></th> </tr> </thead> <tbody> <tr> <td>1</td> <td>245.36</td> <td>53.00</td> <td>-20.20</td> <td>74.00</td> <td>48.08</td> <td>7.87</td> <td>30.77</td> <td>32.92</td> <td>180</td> <td>68 Peak</td> </tr> </tbody> </table>	1	Freq	Level	Over	Limit	Read	CableAntenna	Preamp	A/Pos	T/Pos	Remark		MHz	dBm	dB	dBm	dBm	dB	dB	cm	deg		1	245.36	53.00	-20.20	74.00	48.08	7.87	30.77	32.92	180	68 Peak	 <p>Site : 83086-K5 Condition : FCC PART 15C 3m 3117 SN 00218642 HORIZONTAL Project : FR1D0310B Mode : J Plane : X Single-directivity : X IMEI : 95</p> <table border="1"> <thead> <tr> <th>1</th> <th>Freq</th> <th>Level</th> <th>Over</th> <th>Limit</th> <th>Read</th> <th>CableAntenna</th> <th>Preamp</th> <th>A/Pos</th> <th>T/Pos</th> <th>Remark</th> </tr> <tr> <th></th> <th>MHz</th> <th>dBm</th> <th>dB</th> <th>dBm</th> <th>dBm</th> <th>dB</th> <th>dB</th> <th>cm</th> <th>deg</th> <th></th> </tr> </thead> <tbody> <tr> <td>1</td> <td>2402.00</td> <td>100.63</td> <td>26.63</td> <td>74.00</td> <td>95.31</td> <td>7.14</td> <td>31.00</td> <td>32.04</td> <td>180</td> <td>68 Peak</td> </tr> </tbody> </table>	1	Freq	Level	Over	Limit	Read	CableAntenna	Preamp	A/Pos	T/Pos	Remark		MHz	dBm	dB	dBm	dBm	dB	dB	cm	deg		1	2402.00	100.63	26.63	74.00	95.31	7.14	31.00	32.04	180	68 Peak
1	Freq	Level	Over	Limit	Read	CableAntenna	Preamp	A/Pos	T/Pos	Remark																																																										
	MHz	dBm	dB	dBm	dBm	dB	dB	cm	deg																																																											
1	245.36	53.00	-20.20	74.00	48.08	7.87	30.77	32.92	180	68 Peak																																																										
1	Freq	Level	Over	Limit	Read	CableAntenna	Preamp	A/Pos	T/Pos	Remark																																																										
	MHz	dBm	dB	dBm	dBm	dB	dB	cm	deg																																																											
1	2402.00	100.63	26.63	74.00	95.31	7.14	31.00	32.04	180	68 Peak																																																										
<b>Avg.</b>	 <p>Site : 83086-K5 Condition : FCC PART 15C (AVG) 3m 3117 SN 00218642 HORIZONTAL Project : FR1D0310B Mode : J Plane : X Single-directivity : X IMEI : 95</p> <table border="1"> <thead> <tr> <th>1</th> <th>Freq</th> <th>Level</th> <th>Over</th> <th>Limit</th> <th>Read</th> <th>CableAntenna</th> <th>Preamp</th> <th>A/Pos</th> <th>T/Pos</th> <th>Remark</th> </tr> <tr> <th></th> <th>MHz</th> <th>dBm</th> <th>dB</th> <th>dBm</th> <th>dBm</th> <th>dB</th> <th>dB</th> <th>cm</th> <th>deg</th> <th></th> </tr> </thead> <tbody> <tr> <td>1</td> <td>2383.97</td> <td>44.74</td> <td>-9.26</td> <td>54.00</td> <td>39.55</td> <td>7.13</td> <td>30.94</td> <td>32.88</td> <td>180</td> <td>68 Average</td> </tr> </tbody> </table>	1	Freq	Level	Over	Limit	Read	CableAntenna	Preamp	A/Pos	T/Pos	Remark		MHz	dBm	dB	dBm	dBm	dB	dB	cm	deg		1	2383.97	44.74	-9.26	54.00	39.55	7.13	30.94	32.88	180	68 Average	 <p>Site : 83086-K5 Condition : FCC PART 15C (AVG) 3m 3117 SN 00218642 HORIZONTAL Project : FR1D0310B Mode : J Plane : X Single-directivity : X IMEI : 95</p> <table border="1"> <thead> <tr> <th>1</th> <th>Freq</th> <th>Level</th> <th>Over</th> <th>Limit</th> <th>Read</th> <th>CableAntenna</th> <th>Preamp</th> <th>A/Pos</th> <th>T/Pos</th> <th>Remark</th> </tr> <tr> <th></th> <th>MHz</th> <th>dBm</th> <th>dB</th> <th>dBm</th> <th>dBm</th> <th>dB</th> <th>dB</th> <th>cm</th> <th>deg</th> <th></th> </tr> </thead> <tbody> <tr> <td>1</td> <td>2402.00</td> <td>99.30</td> <td>45.30</td> <td>54.00</td> <td>95.90</td> <td>7.14</td> <td>31.00</td> <td>32.04</td> <td>180</td> <td>68 Average</td> </tr> </tbody> </table>	1	Freq	Level	Over	Limit	Read	CableAntenna	Preamp	A/Pos	T/Pos	Remark		MHz	dBm	dB	dBm	dBm	dB	dB	cm	deg		1	2402.00	99.30	45.30	54.00	95.90	7.14	31.00	32.04	180	68 Average
1	Freq	Level	Over	Limit	Read	CableAntenna	Preamp	A/Pos	T/Pos	Remark																																																										
	MHz	dBm	dB	dBm	dBm	dB	dB	cm	deg																																																											
1	2383.97	44.74	-9.26	54.00	39.55	7.13	30.94	32.88	180	68 Average																																																										
1	Freq	Level	Over	Limit	Read	CableAntenna	Preamp	A/Pos	T/Pos	Remark																																																										
	MHz	dBm	dB	dBm	dBm	dB	dB	cm	deg																																																											
1	2402.00	99.30	45.30	54.00	95.90	7.14	31.00	32.04	180	68 Average																																																										

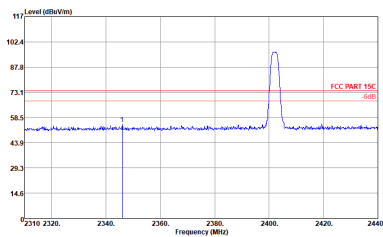
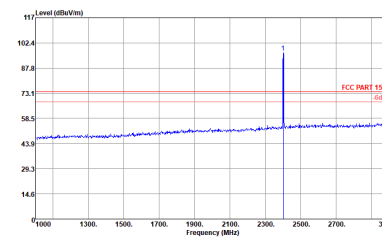
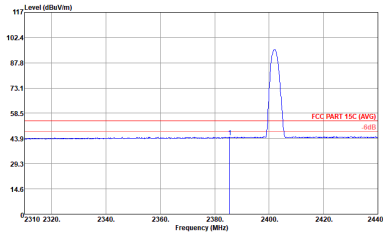
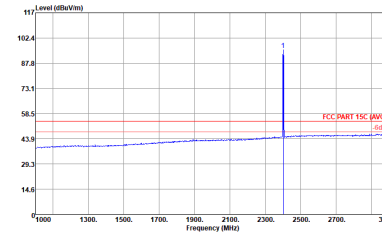

BLE	2.4GHz 2400~2483.5MHz Band Edge @ 3m																																																															
ANT	BLE CH00 2402MHz																																																															
6	Vertical	Fundamental																																																														
<b>Peak</b>	 <p>Site : 85C86-K5 Condition : FCC PART 15C 3m 3117 5M 00118642 VERTICAL Project : (FR)1D0310B Mode : 7 Plane : X Single-directivity : Single-directivity IMEI : #5</p> <table border="1"> <thead> <tr> <th>Freq</th> <th>Level</th> <th>Over</th> <th>Limit</th> <th>Read</th> <th>CableAntenna</th> <th>Preamp</th> <th>A/Pos</th> <th>T/Pos</th> <th>Remark</th> </tr> <tr> <th>MHz</th> <th>dBuV/m</th> <th>dB</th> <th>dBuV/m</th> <th>dBuV</th> <th>dB</th> <th>dB/m</th> <th>dB</th> <th>cm</th> <th>deg</th> </tr> </thead> <tbody> <tr> <td>1</td> <td>2345.88</td> <td>54.71</td> <td>-19.29</td> <td>74.00</td> <td>49.79</td> <td>7.87</td> <td>30.77</td> <td>32.92</td> <td>388</td> <td>97 Peak</td> </tr> </tbody> </table>	Freq	Level	Over	Limit	Read	CableAntenna	Preamp	A/Pos	T/Pos	Remark	MHz	dBuV/m	dB	dBuV/m	dBuV	dB	dB/m	dB	cm	deg	1	2345.88	54.71	-19.29	74.00	49.79	7.87	30.77	32.92	388	97 Peak	 <p>Site : 85C86-K5 Condition : FCC PART 15C 3m 3117 5M 00118642 VERTICAL Project : (FR)1D0310B Mode : 7 Plane : X Single-directivity : Single-directivity IMEI : #5</p> <table border="1"> <thead> <tr> <th>Freq</th> <th>Level</th> <th>Over</th> <th>Limit</th> <th>Read</th> <th>CableAntenna</th> <th>Preamp</th> <th>A/Pos</th> <th>T/Pos</th> <th>Remark</th> </tr> <tr> <th>MHz</th> <th>dBuV/m</th> <th>dB</th> <th>dBuV/m</th> <th>dBuV</th> <th>dB</th> <th>dB/m</th> <th>dB</th> <th>cm</th> <th>deg</th> </tr> </thead> <tbody> <tr> <td>1</td> <td>2402.00</td> <td>95.74</td> <td>22.74</td> <td>74.00</td> <td>51.42</td> <td>7.16</td> <td>31.00</td> <td>32.84</td> <td>388</td> <td>97 Peak</td> </tr> </tbody> </table>	Freq	Level	Over	Limit	Read	CableAntenna	Preamp	A/Pos	T/Pos	Remark	MHz	dBuV/m	dB	dBuV/m	dBuV	dB	dB/m	dB	cm	deg	1	2402.00	95.74	22.74	74.00	51.42	7.16	31.00	32.84	388	97 Peak
Freq	Level	Over	Limit	Read	CableAntenna	Preamp	A/Pos	T/Pos	Remark																																																							
MHz	dBuV/m	dB	dBuV/m	dBuV	dB	dB/m	dB	cm	deg																																																							
1	2345.88	54.71	-19.29	74.00	49.79	7.87	30.77	32.92	388	97 Peak																																																						
Freq	Level	Over	Limit	Read	CableAntenna	Preamp	A/Pos	T/Pos	Remark																																																							
MHz	dBuV/m	dB	dBuV/m	dBuV	dB	dB/m	dB	cm	deg																																																							
1	2402.00	95.74	22.74	74.00	51.42	7.16	31.00	32.84	388	97 Peak																																																						
<b>Avg</b>	 <p>Site : 85C86-K5 Condition : FCC PART 15C (AVG) 3m 3117 5M 00118642 VERTICAL Project : (FR)1D0310B Mode : 7 Plane : X Single-directivity : Single-directivity IMEI : #5</p> <table border="1"> <thead> <tr> <th>Freq</th> <th>Level</th> <th>Over</th> <th>Limit</th> <th>Read</th> <th>CableAntenna</th> <th>Preamp</th> <th>A/Pos</th> <th>T/Pos</th> <th>Remark</th> </tr> <tr> <th>MHz</th> <th>dBuV/m</th> <th>dB</th> <th>dBuV/m</th> <th>dBuV</th> <th>dB</th> <th>dB/m</th> <th>dB</th> <th>cm</th> <th>deg</th> </tr> </thead> <tbody> <tr> <td>1</td> <td>2385.53</td> <td>44.77</td> <td>-9.23</td> <td>54.00</td> <td>39.55</td> <td>7.16</td> <td>30.94</td> <td>32.88</td> <td>388</td> <td>97 Average</td> </tr> </tbody> </table>	Freq	Level	Over	Limit	Read	CableAntenna	Preamp	A/Pos	T/Pos	Remark	MHz	dBuV/m	dB	dBuV/m	dBuV	dB	dB/m	dB	cm	deg	1	2385.53	44.77	-9.23	54.00	39.55	7.16	30.94	32.88	388	97 Average	 <p>Site : 85C86-K5 Condition : FCC PART 15C (AVG) 3m 3117 5M 00118642 VERTICAL Project : (FR)1D0310B Mode : 7 Plane : X Single-directivity : Single-directivity IMEI : #5</p> <table border="1"> <thead> <tr> <th>Freq</th> <th>Level</th> <th>Over</th> <th>Limit</th> <th>Read</th> <th>CableAntenna</th> <th>Preamp</th> <th>A/Pos</th> <th>T/Pos</th> <th>Remark</th> </tr> <tr> <th>MHz</th> <th>dBuV/m</th> <th>dB</th> <th>dBuV/m</th> <th>dBuV</th> <th>dB</th> <th>dB/m</th> <th>dB</th> <th>cm</th> <th>deg</th> </tr> </thead> <tbody> <tr> <td>1</td> <td>2402.00</td> <td>95.38</td> <td>41.38</td> <td>54.00</td> <td>50.06</td> <td>7.16</td> <td>31.00</td> <td>32.84</td> <td>388</td> <td>97 Average</td> </tr> </tbody> </table>	Freq	Level	Over	Limit	Read	CableAntenna	Preamp	A/Pos	T/Pos	Remark	MHz	dBuV/m	dB	dBuV/m	dBuV	dB	dB/m	dB	cm	deg	1	2402.00	95.38	41.38	54.00	50.06	7.16	31.00	32.84	388	97 Average
Freq	Level	Over	Limit	Read	CableAntenna	Preamp	A/Pos	T/Pos	Remark																																																							
MHz	dBuV/m	dB	dBuV/m	dBuV	dB	dB/m	dB	cm	deg																																																							
1	2385.53	44.77	-9.23	54.00	39.55	7.16	30.94	32.88	388	97 Average																																																						
Freq	Level	Over	Limit	Read	CableAntenna	Preamp	A/Pos	T/Pos	Remark																																																							
MHz	dBuV/m	dB	dBuV/m	dBuV	dB	dB/m	dB	cm	deg																																																							
1	2402.00	95.38	41.38	54.00	50.06	7.16	31.00	32.84	388	97 Average																																																						

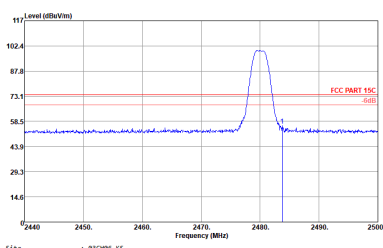
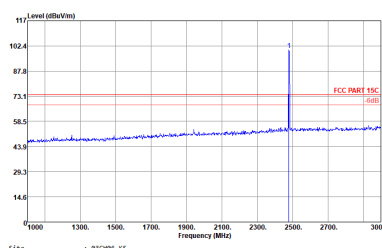
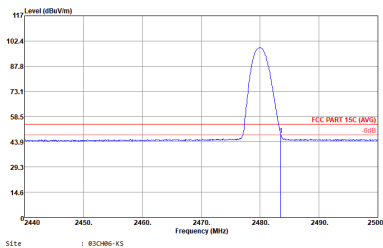
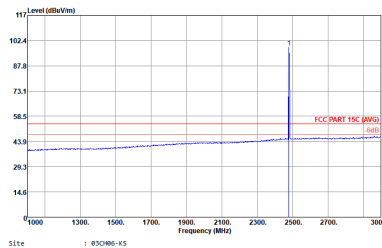

BLE	2.4GHz 2400~2483.5MHz Band Edge @ 3m																																																																													
ANT	BLE CH39 2480MHZ																																																																													
6	Horizontal	Fundamental																																																																												
<b>Peak</b>	 <p>Site : BSCM0-K5 Condition : FCC PART 15C 3m 3117 SN 00218642 HORIZONTAL Project : R04:1000.000KHz VSW:3.000KHz SMT:Auto Mode : (FR)1D0310B Plane : X Plane : X Single-directivity : X IME1 : #5</p> <table border="1"> <thead> <tr> <th>IME1</th> <th>Over</th> <th>Limit</th> <th>Read</th> <th>CableAntenna</th> <th>Preamp</th> <th>A/Pos</th> <th>T/Pos</th> <th>Remark</th> </tr> <tr> <th>IME1</th> <th>Freq</th> <th>Level</th> <th>Limit</th> <th>Line</th> <th>Level</th> <th>Loss</th> <th>Factor</th> <th>Factor</th> </tr> <tr> <th>IME1</th> <th>MHz</th> <th>dBuV/m</th> <th>dB</th> <th>dBuV/m</th> <th>dBuV</th> <th>dB</th> <th>dB/m</th> <th>dB</th> </tr> </thead> <tbody> <tr> <td>1</td> <td>2483.74</td> <td>56.83</td> <td>-17.97</td> <td>74.00</td> <td>58.27</td> <td>7.27</td> <td>31.13</td> <td>32.64</td> <td>124</td> <td>72 Peak</td> </tr> </tbody> </table>	IME1	Over	Limit	Read	CableAntenna	Preamp	A/Pos	T/Pos	Remark	IME1	Freq	Level	Limit	Line	Level	Loss	Factor	Factor	IME1	MHz	dBuV/m	dB	dBuV/m	dBuV	dB	dB/m	dB	1	2483.74	56.83	-17.97	74.00	58.27	7.27	31.13	32.64	124	72 Peak	 <p>Site : BSCM0-K5 Condition : FCC PART 15C 3m 3117 SN 00218642 HORIZONTAL Project : R04:1000.000KHz VSW:3.000KHz SMT:Auto Mode : (FR)1D0310B Plane : X Plane : X Single-directivity : X IME1 : #5</p> <table border="1"> <thead> <tr> <th>IME1</th> <th>Over</th> <th>Limit</th> <th>Read</th> <th>CableAntenna</th> <th>Preamp</th> <th>A/Pos</th> <th>T/Pos</th> <th>Remark</th> </tr> <tr> <th>IME1</th> <th>Freq</th> <th>Level</th> <th>Limit</th> <th>Line</th> <th>Level</th> <th>Loss</th> <th>Factor</th> <th>Factor</th> </tr> <tr> <th>IME1</th> <th>MHz</th> <th>dBuV/m</th> <th>dB</th> <th>dBuV/m</th> <th>dBuV</th> <th>dB</th> <th>dB/m</th> <th>dB</th> </tr> </thead> <tbody> <tr> <td>1 *</td> <td>2480.00</td> <td>99.91</td> <td>25.91</td> <td>74.00</td> <td>94.15</td> <td>7.27</td> <td>31.13</td> <td>32.64</td> <td>124</td> <td>72 Peak</td> </tr> </tbody> </table>	IME1	Over	Limit	Read	CableAntenna	Preamp	A/Pos	T/Pos	Remark	IME1	Freq	Level	Limit	Line	Level	Loss	Factor	Factor	IME1	MHz	dBuV/m	dB	dBuV/m	dBuV	dB	dB/m	dB	1 *	2480.00	99.91	25.91	74.00	94.15	7.27	31.13	32.64	124	72 Peak
IME1	Over	Limit	Read	CableAntenna	Preamp	A/Pos	T/Pos	Remark																																																																						
IME1	Freq	Level	Limit	Line	Level	Loss	Factor	Factor																																																																						
IME1	MHz	dBuV/m	dB	dBuV/m	dBuV	dB	dB/m	dB																																																																						
1	2483.74	56.83	-17.97	74.00	58.27	7.27	31.13	32.64	124	72 Peak																																																																				
IME1	Over	Limit	Read	CableAntenna	Preamp	A/Pos	T/Pos	Remark																																																																						
IME1	Freq	Level	Limit	Line	Level	Loss	Factor	Factor																																																																						
IME1	MHz	dBuV/m	dB	dBuV/m	dBuV	dB	dB/m	dB																																																																						
1 *	2480.00	99.91	25.91	74.00	94.15	7.27	31.13	32.64	124	72 Peak																																																																				
<b>Avg.</b>	 <p>Site : BSCM0-K5 Condition : FCC PART 15C (AVG) 3m 3117 SN 00218642 HORIZONTAL Project : R04:1000.000KHz VSW:3.100KHz SMT:Auto Mode : (FR)1D0310B Plane : X Plane : X Single-directivity : X IME1 : #5</p> <table border="1"> <thead> <tr> <th>IME1</th> <th>Over</th> <th>Limit</th> <th>Read</th> <th>CableAntenna</th> <th>Preamp</th> <th>A/Pos</th> <th>T/Pos</th> <th>Remark</th> </tr> <tr> <th>IME1</th> <th>Freq</th> <th>Level</th> <th>Limit</th> <th>Line</th> <th>Level</th> <th>Loss</th> <th>Factor</th> <th>Factor</th> </tr> <tr> <th>IME1</th> <th>MHz</th> <th>dBuV/m</th> <th>dB</th> <th>dBuV/m</th> <th>dBuV</th> <th>dB</th> <th>dB/m</th> <th>dB</th> </tr> </thead> <tbody> <tr> <td>1</td> <td>2483.58</td> <td>47.99</td> <td>-6.81</td> <td>54.00</td> <td>42.23</td> <td>7.27</td> <td>31.13</td> <td>32.64</td> <td>124</td> <td>72 Average</td> </tr> </tbody> </table>	IME1	Over	Limit	Read	CableAntenna	Preamp	A/Pos	T/Pos	Remark	IME1	Freq	Level	Limit	Line	Level	Loss	Factor	Factor	IME1	MHz	dBuV/m	dB	dBuV/m	dBuV	dB	dB/m	dB	1	2483.58	47.99	-6.81	54.00	42.23	7.27	31.13	32.64	124	72 Average	 <p>Site : BSCM0-K5 Condition : FCC PART 15C (AVG) 3m 3117 SN 00218642 HORIZONTAL Project : R04:1000.000KHz VSW:3.100KHz SMT:Auto Mode : (FR)1D0310B Plane : X Plane : X Single-directivity : X IME1 : #5</p> <table border="1"> <thead> <tr> <th>IME1</th> <th>Over</th> <th>Limit</th> <th>Read</th> <th>CableAntenna</th> <th>Preamp</th> <th>A/Pos</th> <th>T/Pos</th> <th>Remark</th> </tr> <tr> <th>IME1</th> <th>Freq</th> <th>Level</th> <th>Limit</th> <th>Line</th> <th>Level</th> <th>Loss</th> <th>Factor</th> <th>Factor</th> </tr> <tr> <th>IME1</th> <th>MHz</th> <th>dBuV/m</th> <th>dB</th> <th>dBuV/m</th> <th>dBuV</th> <th>dB</th> <th>dB/m</th> <th>dB</th> </tr> </thead> <tbody> <tr> <td>1 *</td> <td>2480.00</td> <td>98.46</td> <td>44.46</td> <td>54.00</td> <td>92.70</td> <td>7.27</td> <td>31.13</td> <td>32.64</td> <td>124</td> <td>72 Average</td> </tr> </tbody> </table>	IME1	Over	Limit	Read	CableAntenna	Preamp	A/Pos	T/Pos	Remark	IME1	Freq	Level	Limit	Line	Level	Loss	Factor	Factor	IME1	MHz	dBuV/m	dB	dBuV/m	dBuV	dB	dB/m	dB	1 *	2480.00	98.46	44.46	54.00	92.70	7.27	31.13	32.64	124	72 Average
IME1	Over	Limit	Read	CableAntenna	Preamp	A/Pos	T/Pos	Remark																																																																						
IME1	Freq	Level	Limit	Line	Level	Loss	Factor	Factor																																																																						
IME1	MHz	dBuV/m	dB	dBuV/m	dBuV	dB	dB/m	dB																																																																						
1	2483.58	47.99	-6.81	54.00	42.23	7.27	31.13	32.64	124	72 Average																																																																				
IME1	Over	Limit	Read	CableAntenna	Preamp	A/Pos	T/Pos	Remark																																																																						
IME1	Freq	Level	Limit	Line	Level	Loss	Factor	Factor																																																																						
IME1	MHz	dBuV/m	dB	dBuV/m	dBuV	dB	dB/m	dB																																																																						
1 *	2480.00	98.46	44.46	54.00	92.70	7.27	31.13	32.64	124	72 Average																																																																				



BLE	2.4GHz 2400~2483.5MHz Band Edge @ 3m																																																															
ANT	BLE CH39 2480MHz																																																															
6	Vertical	Fundamental																																																														
<b>Peak</b>	<p>Site : 83C86-K5            Condition : FCC PART 15C 3m 3117 SM 00218642 VERTICAL            Project : R01:1000.000MHz V01:3000.000MHz SMT:Auto            Model : (FR)1D0310B            Mode : 0            Plane : X            Single-directivity : Single-directivity            IMEI : #5</p> <table border="1"> <thead> <tr> <th>Freq</th> <th>Level</th> <th>Over</th> <th>Limit</th> <th>Read</th> <th>CableAntenna</th> <th>Preamp</th> <th>A/Pos</th> <th>T/Pos</th> <th>Remark</th> </tr> <tr> <th>MHz</th> <th>dBuV/m</th> <th>dB</th> <th>dBuV/m</th> <th>dBuV</th> <th>dB</th> <th>dB/m</th> <th>dB</th> <th>cm</th> <th>deg</th> </tr> </thead> <tbody> <tr> <td>1</td> <td>2497.78</td> <td>54.86</td> <td>-19.14</td> <td>74.00</td> <td>48.96</td> <td>7.30</td> <td>31.17</td> <td>32.57</td> <td>371</td> <td>96 Peak</td> </tr> </tbody> </table>	Freq	Level	Over	Limit	Read	CableAntenna	Preamp	A/Pos	T/Pos	Remark	MHz	dBuV/m	dB	dBuV/m	dBuV	dB	dB/m	dB	cm	deg	1	2497.78	54.86	-19.14	74.00	48.96	7.30	31.17	32.57	371	96 Peak	<p>Site : 83C86-K5            Condition : FCC PART 15C 3m 3117 SM 00218642 VERTICAL            Project : R01:1000.000MHz V01:3000.000MHz SMT:Auto            Model : (FR)1D0310B            Mode : 0            Plane : X            Single-directivity : Single-directivity            IMEI : #5</p> <table border="1"> <thead> <tr> <th>Freq</th> <th>Level</th> <th>Over</th> <th>Limit</th> <th>Read</th> <th>CableAntenna</th> <th>Preamp</th> <th>A/Pos</th> <th>T/Pos</th> <th>Remark</th> </tr> <tr> <th>MHz</th> <th>dBuV/m</th> <th>dB</th> <th>dBuV/m</th> <th>dBuV</th> <th>dB</th> <th>dB/m</th> <th>dB</th> <th>cm</th> <th>deg</th> </tr> </thead> <tbody> <tr> <td>1</td> <td>2480.00</td> <td>95.20</td> <td>22.20</td> <td>74.00</td> <td>49.44</td> <td>7.27</td> <td>31.13</td> <td>32.64</td> <td>371</td> <td>96 Peak</td> </tr> </tbody> </table>	Freq	Level	Over	Limit	Read	CableAntenna	Preamp	A/Pos	T/Pos	Remark	MHz	dBuV/m	dB	dBuV/m	dBuV	dB	dB/m	dB	cm	deg	1	2480.00	95.20	22.20	74.00	49.44	7.27	31.13	32.64	371	96 Peak
Freq	Level	Over	Limit	Read	CableAntenna	Preamp	A/Pos	T/Pos	Remark																																																							
MHz	dBuV/m	dB	dBuV/m	dBuV	dB	dB/m	dB	cm	deg																																																							
1	2497.78	54.86	-19.14	74.00	48.96	7.30	31.17	32.57	371	96 Peak																																																						
Freq	Level	Over	Limit	Read	CableAntenna	Preamp	A/Pos	T/Pos	Remark																																																							
MHz	dBuV/m	dB	dBuV/m	dBuV	dB	dB/m	dB	cm	deg																																																							
1	2480.00	95.20	22.20	74.00	49.44	7.27	31.13	32.64	371	96 Peak																																																						
<b>Avg.</b>	<p>Site : 83C86-K5            Condition : FCC PART 15C (AVG) 3m 3117 SM 00218642 VERTICAL            Project : R01:1000.000MHz V01:5.100MHz SMT:Auto            Model : (FR)1D0310B            Mode : 0            Plane : X            Single-directivity : Single-directivity            IMEI : #5</p> <table border="1"> <thead> <tr> <th>Freq</th> <th>Level</th> <th>Over</th> <th>Limit</th> <th>Read</th> <th>CableAntenna</th> <th>Preamp</th> <th>A/Pos</th> <th>T/Pos</th> <th>Remark</th> </tr> <tr> <th>MHz</th> <th>dBuV/m</th> <th>dB</th> <th>dBuV/m</th> <th>dBuV</th> <th>dB</th> <th>dB/m</th> <th>dB</th> <th>cm</th> <th>deg</th> </tr> </thead> <tbody> <tr> <td>1</td> <td>2483.50</td> <td>46.12</td> <td>-7.88</td> <td>54.00</td> <td>48.36</td> <td>7.27</td> <td>31.13</td> <td>32.64</td> <td>371</td> <td>96 Average</td> </tr> </tbody> </table>	Freq	Level	Over	Limit	Read	CableAntenna	Preamp	A/Pos	T/Pos	Remark	MHz	dBuV/m	dB	dBuV/m	dBuV	dB	dB/m	dB	cm	deg	1	2483.50	46.12	-7.88	54.00	48.36	7.27	31.13	32.64	371	96 Average	<p>Site : 83C86-K5            Condition : FCC PART 15C (AVG) 3m 3117 SM 00218642 VERTICAL            Project : R01:1000.000MHz V01:5.100MHz SMT:Auto            Model : (FR)1D0310B            Mode : 0            Plane : X            Single-directivity : Single-directivity            IMEI : #5</p> <table border="1"> <thead> <tr> <th>Freq</th> <th>Level</th> <th>Over</th> <th>Limit</th> <th>Read</th> <th>CableAntenna</th> <th>Preamp</th> <th>A/Pos</th> <th>T/Pos</th> <th>Remark</th> </tr> <tr> <th>MHz</th> <th>dBuV/m</th> <th>dB</th> <th>dBuV/m</th> <th>dBuV</th> <th>dB</th> <th>dB/m</th> <th>dB</th> <th>cm</th> <th>deg</th> </tr> </thead> <tbody> <tr> <td>1</td> <td>2480.00</td> <td>93.77</td> <td>39.77</td> <td>54.00</td> <td>48.01</td> <td>7.27</td> <td>31.13</td> <td>32.64</td> <td>371</td> <td>96 Average</td> </tr> </tbody> </table>	Freq	Level	Over	Limit	Read	CableAntenna	Preamp	A/Pos	T/Pos	Remark	MHz	dBuV/m	dB	dBuV/m	dBuV	dB	dB/m	dB	cm	deg	1	2480.00	93.77	39.77	54.00	48.01	7.27	31.13	32.64	371	96 Average
Freq	Level	Over	Limit	Read	CableAntenna	Preamp	A/Pos	T/Pos	Remark																																																							
MHz	dBuV/m	dB	dBuV/m	dBuV	dB	dB/m	dB	cm	deg																																																							
1	2483.50	46.12	-7.88	54.00	48.36	7.27	31.13	32.64	371	96 Average																																																						
Freq	Level	Over	Limit	Read	CableAntenna	Preamp	A/Pos	T/Pos	Remark																																																							
MHz	dBuV/m	dB	dBuV/m	dBuV	dB	dB/m	dB	cm	deg																																																							
1	2480.00	93.77	39.77	54.00	48.01	7.27	31.13	32.64	371	96 Average																																																						



2.4GHz 2400~2483.5MHz

BLE (Harmonic @ 3m)

BLE	2.4GHz 2400~2483.5MHz Harmonic @ 3m																																																									
ANT	BLE CH00 2402MHz																																																									
6	Horizontal	Vertical																																																								
Peak Avg.	<p>Site : 83086-K5            Condition : FCC PART 15C 3m 3117 5M 08218842 HORIZONTAL            Freq: 1000, 8000Hz VSW: 3000, 8000Hz SMT: Auto            Project : (FR)J00310            Mode : J            Plane : X            : Single-directivity            IMEI : 95</p> <table border="1"> <thead> <tr> <th>Over</th> <th>Limit</th> <th>Read</th> <th>Cable/Antenna</th> <th>Preamp</th> <th>A/Pos</th> <th>T/Pos</th> <th>Remark</th> </tr> <tr> <th>Freq</th> <th>Level</th> <th>Level</th> <th>Loss</th> <th>Factor</th> <th>Factor</th> <th>cm</th> <th>deg</th> </tr> </thead> <tbody> <tr> <td>1</td> <td>4000.00</td> <td>41.39</td> <td>-32.61</td> <td>74.00</td> <td>56.68</td> <td>10.24</td> <td>34.51</td> <td>60.04</td> <td>300</td> <td>0</td> <td>Peak</td> </tr> </tbody> </table>	Over	Limit	Read	Cable/Antenna	Preamp	A/Pos	T/Pos	Remark	Freq	Level	Level	Loss	Factor	Factor	cm	deg	1	4000.00	41.39	-32.61	74.00	56.68	10.24	34.51	60.04	300	0	Peak	<p>Site : 83086-K5            Condition : FCC PART 15C 3m 3117 5M 08218842 VERTICAL            Freq: 1000, 8000Hz VSW: 3000, 8000Hz SMT: Auto            Project : (FR)J00310            Mode : J            Plane : X            : Single-directivity            IMEI : 95</p> <table border="1"> <thead> <tr> <th>Over</th> <th>Limit</th> <th>Read</th> <th>Cable/Antenna</th> <th>Preamp</th> <th>A/Pos</th> <th>T/Pos</th> <th>Remark</th> </tr> <tr> <th>Freq</th> <th>Level</th> <th>Level</th> <th>Loss</th> <th>Factor</th> <th>Factor</th> <th>cm</th> <th>deg</th> </tr> </thead> <tbody> <tr> <td>1</td> <td>4000.00</td> <td>41.63</td> <td>-32.37</td> <td>74.00</td> <td>56.92</td> <td>10.24</td> <td>34.51</td> <td>60.04</td> <td>300</td> <td>0</td> <td>Peak</td> </tr> </tbody> </table>	Over	Limit	Read	Cable/Antenna	Preamp	A/Pos	T/Pos	Remark	Freq	Level	Level	Loss	Factor	Factor	cm	deg	1	4000.00	41.63	-32.37	74.00	56.92	10.24	34.51	60.04	300	0	Peak
Over	Limit	Read	Cable/Antenna	Preamp	A/Pos	T/Pos	Remark																																																			
Freq	Level	Level	Loss	Factor	Factor	cm	deg																																																			
1	4000.00	41.39	-32.61	74.00	56.68	10.24	34.51	60.04	300	0	Peak																																															
Over	Limit	Read	Cable/Antenna	Preamp	A/Pos	T/Pos	Remark																																																			
Freq	Level	Level	Loss	Factor	Factor	cm	deg																																																			
1	4000.00	41.63	-32.37	74.00	56.92	10.24	34.51	60.04	300	0	Peak																																															

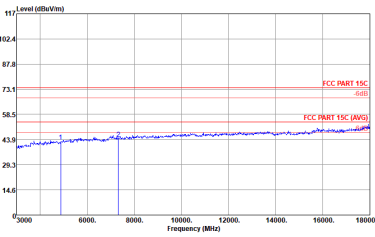
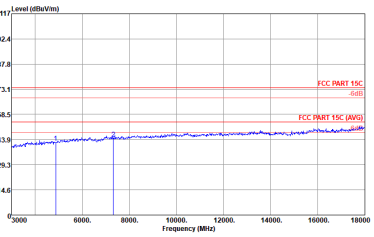
BLE	2.4GHz 2400~2483.5MHz Harmonic @ 3m																																																																																	
ANT	BLE CH19 2440MHz																																																																																	
6	Horizontal	Vertical																																																																																
Peak Avg.	<p data-bbox="391 537 502 560">Level (dBm/m)</p>  <p data-bbox="391 772 813 840">Site : 83C86-K5 Condition : FCC PART 15C 3m 3137 SM 80318643 HORIZONTAL Project : R94:1000.000KHz VSW:3000.000KHz SMT:Auto FR1D0310B Plane : X Polar : Single-directivity</p> <table border="1" data-bbox="438 840 774 907"><thead><tr><th>IME1</th><th>90</th><th>Over Limit</th><th>Read</th><th>Cable</th><th>Antenna</th><th>Preamp</th><th>A/Pos</th><th>T/Pos</th><th>Remark</th></tr><tr><th>Freq</th><th>Level</th><th>Limit</th><th>Line</th><th>Loss</th><th>Factor</th><th>dB</th><th>dB</th><th>dB</th><th>deg</th></tr></thead><tbody><tr><td>1</td><td>4875.00</td><td>42.02</td><td>-21.18</td><td>74.00</td><td>57.07</td><td>18.32</td><td>36.66</td><td>68.83</td><td>0 Peak</td></tr><tr><td>2</td><td>7320.00</td><td>44.17</td><td>-29.83</td><td>74.00</td><td>55.36</td><td>12.77</td><td>36.56</td><td>68.52</td><td>0 Peak</td></tr></tbody></table>	IME1	90	Over Limit	Read	Cable	Antenna	Preamp	A/Pos	T/Pos	Remark	Freq	Level	Limit	Line	Loss	Factor	dB	dB	dB	deg	1	4875.00	42.02	-21.18	74.00	57.07	18.32	36.66	68.83	0 Peak	2	7320.00	44.17	-29.83	74.00	55.36	12.77	36.56	68.52	0 Peak	<p data-bbox="869 537 981 560">Level (dBm/m)</p>  <p data-bbox="869 772 1292 840">Site : 83C86-K5 Condition : FCC PART 15C 3m 3137 SM 80318643 VERTICAL Project : R94:1000.000KHz VSW:3000.000KHz SMT:Auto FR1D0310B Plane : X Polar : Single-directivity</p> <table border="1" data-bbox="917 840 1252 907"><thead><tr><th>IME1</th><th>90</th><th>Over Limit</th><th>Read</th><th>Cable</th><th>Antenna</th><th>Preamp</th><th>A/Pos</th><th>T/Pos</th><th>Remark</th></tr><tr><th>Freq</th><th>Level</th><th>Limit</th><th>Line</th><th>Loss</th><th>Factor</th><th>dB</th><th>dB</th><th>dB</th><th>deg</th></tr></thead><tbody><tr><td>1</td><td>4875.00</td><td>41.90</td><td>-32.02</td><td>74.00</td><td>57.03</td><td>18.32</td><td>36.66</td><td>68.83</td><td>0 Peak</td></tr><tr><td>2</td><td>7320.00</td><td>44.47</td><td>-29.53</td><td>74.00</td><td>55.66</td><td>12.77</td><td>36.56</td><td>68.52</td><td>0 Peak</td></tr></tbody></table>	IME1	90	Over Limit	Read	Cable	Antenna	Preamp	A/Pos	T/Pos	Remark	Freq	Level	Limit	Line	Loss	Factor	dB	dB	dB	deg	1	4875.00	41.90	-32.02	74.00	57.03	18.32	36.66	68.83	0 Peak	2	7320.00	44.47	-29.53	74.00	55.66	12.77	36.56	68.52	0 Peak
	IME1	90	Over Limit	Read	Cable	Antenna	Preamp	A/Pos	T/Pos	Remark																																																																								
Freq	Level	Limit	Line	Loss	Factor	dB	dB	dB	deg																																																																									
1	4875.00	42.02	-21.18	74.00	57.07	18.32	36.66	68.83	0 Peak																																																																									
2	7320.00	44.17	-29.83	74.00	55.36	12.77	36.56	68.52	0 Peak																																																																									
IME1	90	Over Limit	Read	Cable	Antenna	Preamp	A/Pos	T/Pos	Remark																																																																									
Freq	Level	Limit	Line	Loss	Factor	dB	dB	dB	deg																																																																									
1	4875.00	41.90	-32.02	74.00	57.03	18.32	36.66	68.83	0 Peak																																																																									
2	7320.00	44.47	-29.53	74.00	55.66	12.77	36.56	68.52	0 Peak																																																																									



BLE	2.4GHz 2400~2483.5MHz Harmonic @ 3m	
ANT	BLE CH39 2480MHz	
6	Horizontal	Vertical
Peak	<pre> Site      : 83C986-K5 Condition : FCC PART 15C 3e 3117.5M 00118643 HORIZONTAL Project   : R90:1000.000KHz VSW:3000.000KHz SMT:Auto Model     : FR1D0310B Plane     : 0 Polar     : 0 Plane     : X Polar     : Single-directivity IMEI      : 95           Over Limit Read CableAntenna Preamp A/Pos T/Pos           Freq Level Line Level Loss Factor Factor           --- 1  4965.00 42.46 -31.54 74.00 53.23 10.43 34.81 60.81 100 0 Peak 2  7440.00 44.87 -29.93 74.00 55.14 12.88 36.59 60.54 100 0 Peak           </pre>	<pre> Site      : 83C986-K5 Condition : FCC PART 15C 3e 3117.5M 00118643 VERTICAL Project   : R90:1000.000KHz VSW:3000.000KHz SMT:Auto Model     : FR1D0310B Plane     : 0 Polar     : 0 Plane     : X Polar     : Single-directivity IMEI      : 95           Over Limit Read CableAntenna Preamp A/Pos T/Pos           Freq Level Line Level Loss Factor Factor           --- 1  4965.00 42.48 -31.60 74.00 53.17 10.43 34.81 60.81 100 0 Peak 2  7440.00 44.76 -29.24 74.00 55.83 12.88 36.59 60.54 100 0 Peak           </pre>



Emission below 1GHz  
2.4GHz BLE (LF)

BLE	2.4GHz 2400~2483.5MHz																																																																																																																																																																															
ANT	BLE LF																																																																																																																																																																															
6	Horizontal	Vertical																																																																																																																																																																														
QP / Peak	<p>Site : 83096-K5 Condition : FCC PART 15C 3m CE0111D 062182 HORIZONTAL R01:100.000KHz V01:300.000KHz S01:Auto Project : (F4)100518 Node : 9</p> <table border="1"> <thead> <tr> <th>Over</th> <th>Limit</th> <th>Band</th> <th>Cal</th> <th>Antenna</th> <th>Preamp</th> <th>A/Pos</th> <th>T/Pos</th> <th>Remark</th> </tr> <tr> <th>Freq</th> <th>Level</th> <th>Limit</th> <th>Level</th> <th>Loss</th> <th>Factor</th> <th>Factor</th> <th></th> <th></th> </tr> <tr> <th>MHz</th> <th>dBuV/m</th> <th>dB</th> <th>dBuV/m</th> <th>dB</th> <th>dB/m</th> <th>dB</th> <th>cm</th> <th>deg</th> </tr> </thead> <tbody> <tr> <td>1</td> <td>30.97</td> <td>21.64</td> <td>-18.36</td> <td>48.00</td> <td>28.26</td> <td>0.59</td> <td>24.04</td> <td>31.25</td> <td>--- Peak</td> </tr> <tr> <td>2</td> <td>155.13</td> <td>17.93</td> <td>-25.57</td> <td>43.50</td> <td>30.99</td> <td>2.81</td> <td>16.25</td> <td>31.32</td> <td>--- Peak</td> </tr> <tr> <td>3</td> <td>186.17</td> <td>21.56</td> <td>-22.14</td> <td>43.50</td> <td>35.36</td> <td>2.21</td> <td>15.12</td> <td>31.33</td> <td>--- Peak</td> </tr> <tr> <td>4</td> <td>209.96</td> <td>25.20</td> <td>-20.80</td> <td>46.00</td> <td>34.68</td> <td>2.76</td> <td>19.35</td> <td>31.59</td> <td>--- Peak</td> </tr> <tr> <td>5</td> <td>782.35</td> <td>28.39</td> <td>-17.65</td> <td>48.00</td> <td>29.31</td> <td>4.49</td> <td>25.73</td> <td>31.14</td> <td>--- Peak</td> </tr> <tr> <td>6</td> <td>899.12</td> <td>28.73</td> <td>-17.27</td> <td>46.00</td> <td>29.30</td> <td>4.89</td> <td>26.69</td> <td>31.15</td> <td>--- Peak</td> </tr> </tbody> </table>	Over	Limit	Band	Cal	Antenna	Preamp	A/Pos	T/Pos	Remark	Freq	Level	Limit	Level	Loss	Factor	Factor			MHz	dBuV/m	dB	dBuV/m	dB	dB/m	dB	cm	deg	1	30.97	21.64	-18.36	48.00	28.26	0.59	24.04	31.25	--- Peak	2	155.13	17.93	-25.57	43.50	30.99	2.81	16.25	31.32	--- Peak	3	186.17	21.56	-22.14	43.50	35.36	2.21	15.12	31.33	--- Peak	4	209.96	25.20	-20.80	46.00	34.68	2.76	19.35	31.59	--- Peak	5	782.35	28.39	-17.65	48.00	29.31	4.49	25.73	31.14	--- Peak	6	899.12	28.73	-17.27	46.00	29.30	4.89	26.69	31.15	--- Peak	<p>Site : 83096-K5 Condition : FCC PART 15C 3m CE0111D 062182 VERTICAL R01:100.000KHz V01:300.000KHz S01:Auto Project : (F4)100518 Node : 9</p> <table border="1"> <thead> <tr> <th>Over</th> <th>Limit</th> <th>Band</th> <th>Cal</th> <th>Antenna</th> <th>Preamp</th> <th>A/Pos</th> <th>T/Pos</th> <th>Remark</th> </tr> <tr> <th>Freq</th> <th>Level</th> <th>Limit</th> <th>Level</th> <th>Loss</th> <th>Factor</th> <th>Factor</th> <th></th> <th></th> </tr> <tr> <th>MHz</th> <th>dBuV/m</th> <th>dB</th> <th>dBuV/m</th> <th>dB</th> <th>dB/m</th> <th>dB</th> <th>cm</th> <th>deg</th> </tr> </thead> <tbody> <tr> <td>1</td> <td>30.00</td> <td>27.70</td> <td>-12.30</td> <td>40.00</td> <td>33.75</td> <td>0.58</td> <td>24.00</td> <td>31.23</td> <td>--- Peak</td> </tr> <tr> <td>2</td> <td>53.28</td> <td>20.82</td> <td>-19.18</td> <td>40.00</td> <td>37.62</td> <td>0.91</td> <td>11.62</td> <td>31.35</td> <td>--- Peak</td> </tr> <tr> <td>3</td> <td>281.23</td> <td>20.49</td> <td>-25.51</td> <td>46.00</td> <td>29.93</td> <td>2.73</td> <td>19.39</td> <td>31.54</td> <td>--- Peak</td> </tr> <tr> <td>4</td> <td>485.90</td> <td>24.80</td> <td>-22.00</td> <td>46.00</td> <td>28.55</td> <td>3.54</td> <td>23.17</td> <td>31.38</td> <td>--- Peak</td> </tr> <tr> <td>5</td> <td>790.16</td> <td>28.14</td> <td>-18.66</td> <td>46.00</td> <td>30.86</td> <td>4.98</td> <td>25.73</td> <td>31.15</td> <td>--- Peak</td> </tr> <tr> <td>6</td> <td>953.44</td> <td>30.53</td> <td>-15.47</td> <td>46.00</td> <td>28.89</td> <td>5.83</td> <td>26.94</td> <td>30.33</td> <td>--- Peak</td> </tr> </tbody> </table>	Over	Limit	Band	Cal	Antenna	Preamp	A/Pos	T/Pos	Remark	Freq	Level	Limit	Level	Loss	Factor	Factor			MHz	dBuV/m	dB	dBuV/m	dB	dB/m	dB	cm	deg	1	30.00	27.70	-12.30	40.00	33.75	0.58	24.00	31.23	--- Peak	2	53.28	20.82	-19.18	40.00	37.62	0.91	11.62	31.35	--- Peak	3	281.23	20.49	-25.51	46.00	29.93	2.73	19.39	31.54	--- Peak	4	485.90	24.80	-22.00	46.00	28.55	3.54	23.17	31.38	--- Peak	5	790.16	28.14	-18.66	46.00	30.86	4.98	25.73	31.15	--- Peak	6	953.44	30.53	-15.47	46.00	28.89	5.83	26.94	30.33	--- Peak
	Over	Limit	Band	Cal	Antenna	Preamp	A/Pos	T/Pos	Remark																																																																																																																																																																							
Freq	Level	Limit	Level	Loss	Factor	Factor																																																																																																																																																																										
MHz	dBuV/m	dB	dBuV/m	dB	dB/m	dB	cm	deg																																																																																																																																																																								
1	30.97	21.64	-18.36	48.00	28.26	0.59	24.04	31.25	--- Peak																																																																																																																																																																							
2	155.13	17.93	-25.57	43.50	30.99	2.81	16.25	31.32	--- Peak																																																																																																																																																																							
3	186.17	21.56	-22.14	43.50	35.36	2.21	15.12	31.33	--- Peak																																																																																																																																																																							
4	209.96	25.20	-20.80	46.00	34.68	2.76	19.35	31.59	--- Peak																																																																																																																																																																							
5	782.35	28.39	-17.65	48.00	29.31	4.49	25.73	31.14	--- Peak																																																																																																																																																																							
6	899.12	28.73	-17.27	46.00	29.30	4.89	26.69	31.15	--- Peak																																																																																																																																																																							
Over	Limit	Band	Cal	Antenna	Preamp	A/Pos	T/Pos	Remark																																																																																																																																																																								
Freq	Level	Limit	Level	Loss	Factor	Factor																																																																																																																																																																										
MHz	dBuV/m	dB	dBuV/m	dB	dB/m	dB	cm	deg																																																																																																																																																																								
1	30.00	27.70	-12.30	40.00	33.75	0.58	24.00	31.23	--- Peak																																																																																																																																																																							
2	53.28	20.82	-19.18	40.00	37.62	0.91	11.62	31.35	--- Peak																																																																																																																																																																							
3	281.23	20.49	-25.51	46.00	29.93	2.73	19.39	31.54	--- Peak																																																																																																																																																																							
4	485.90	24.80	-22.00	46.00	28.55	3.54	23.17	31.38	--- Peak																																																																																																																																																																							
5	790.16	28.14	-18.66	46.00	30.86	4.98	25.73	31.15	--- Peak																																																																																																																																																																							
6	953.44	30.53	-15.47	46.00	28.89	5.83	26.94	30.33	--- Peak																																																																																																																																																																							





### Appendix E. Duty Cycle Plots

Band	Duty Cycle(%)	T(ms)	1/T(kHz)	VBW Setting
Bluetooth LE for 1Mbps	62.04	0.388	2.575	2.7KHz
Bluetooth LE for 2Mbps	32.41	0.203	4.929	5.1kHz

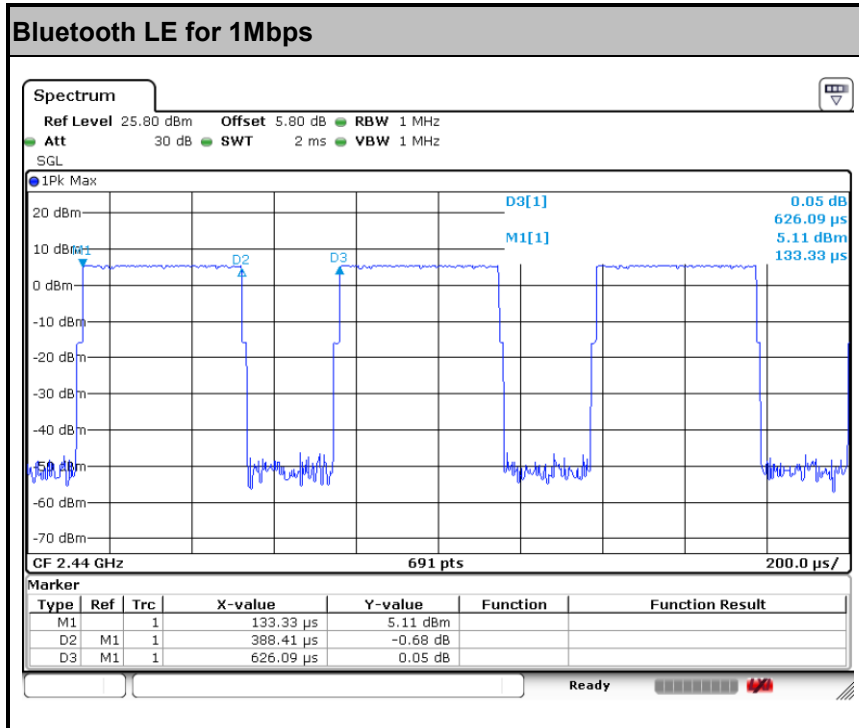

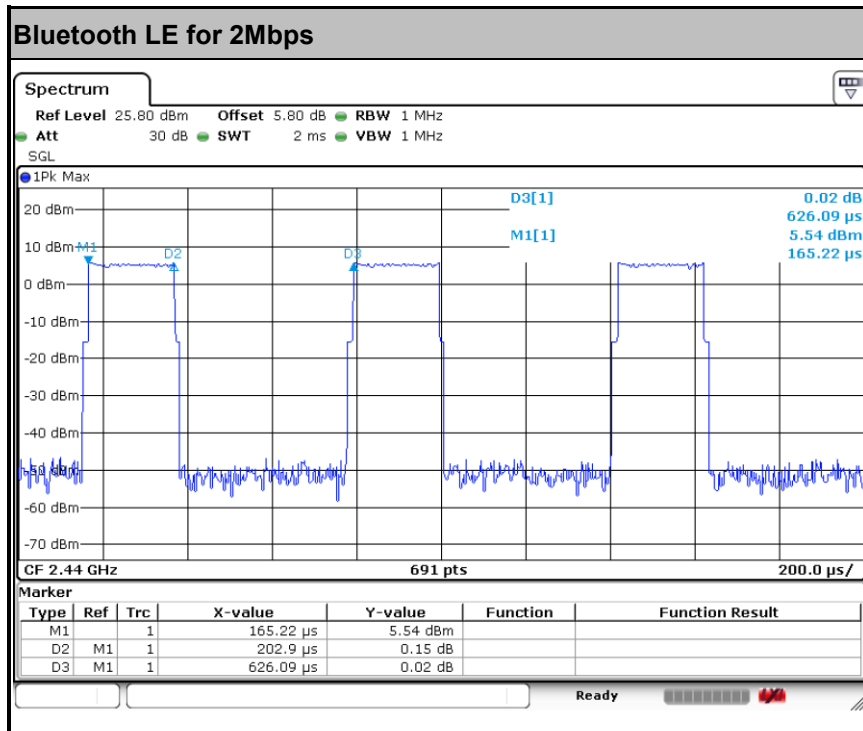

————THE END————