



FCC RF Test Report

APPLICANT : Sony Mobile Communications Inc.
EQUIPMENT : GSM/WCDMA/LTE Phone+Bluetooth,
DTS/UNII a/b/g/n/ac and NFC
BRAND NAME : Sony
FCC ID : PY7-57442Z
STANDARD : 47 CFR Part 2, 22(H), 24(E), 27
CLASSIFICATION : PCS Licensed Transmitter Held to Ear (PCE)

The product was received on Jun. 07, 2017 and completely tested on Oct. 26, 2017. We, SPORTON INTERNATIONAL INC., would like to declare that the tested sample has been evaluated in accordance with the test procedures given in ANSI / TIA-603-E-2016 and the testing has shown the tested sample to be in compliance with the applicable technical standards.

The test results in this report apply exclusively to the tested model / sample. Without written approval of SPORTON INTERNATIONAL INC., the test report shall not be reproduced except in full.

Reviewed by: Joseph Lin / Supervisor

Approved by: Jones Tsai / Manager



SPORTON INTERNATIONAL INC.

No. 52, Hwa Ya 1st Rd., Hwa Ya Technology Park, Kwei-Shan District, Tao Yuan City, Taiwan, R.O.C.



TABLE OF CONTENTS

REVISION HISTORY.....3
SUMMARY OF TEST RESULT4
1 GENERAL DESCRIPTION6
1.1 Applicant6
1.2 Manufacturer6
1.3 Product Feature of Equipment Under Test.....6
1.4 Modification of EUT6
1.5 Emission Designator7
1.6 Testing Location 10
1.7 Applicable Standards 10
2 TEST CONFIGURATION OF EQUIPMENT UNDER TEST 11
2.1 Test Mode 11
2.2 Connection Diagram of Test System 14
2.3 Support Unit used in test configuration and system 14
2.4 Measurement Results Explanation Example 14
2.5 Frequency List of Low/Middle/High Channels 15
3 CONDUCTED TEST ITEMS 19
3.1 Measuring Instruments 19
3.2 Test Setup 19
3.3 Test Result of Conducted Test 19
3.4 Conducted Output Power and ERP/EIRP 20
3.5 Peak-to-Average Ratio 21
3.6 Occupied Bandwidth 22
3.7 Conducted Band Edge 23
3.8 Conducted Spurious Emission 25
3.9 Frequency Stability 26
4 RADIATED TEST ITEMS 27
4.1 Measuring Instruments 27
4.2 Test Setup 27
4.3 Test Result of Radiated Test 27
4.4 Radiated Spurious Emission 28
5 LIST OF MEASURING EQUIPMENT 29
6 UNCERTAINTY OF EVALUATION 31
APPENDIX A. TEST RESULTS OF CONDUCTED TEST
APPENDIX B. TEST RESULTS OF RADIATED TEST



REVISION HISTORY

REPORT NO.	VERSION	DESCRIPTION	ISSUED DATE
FG760712-01B	Rev. 01	Initial issue of report	Nov. 13, 2017



SUMMARY OF TEST RESULT

Report Section	FCC Rule	Description	Limit	Result	Remark
3.4	§2.1046	Conducted Output Power	Reporting Only	PASS	-
	§22.913(a)(2)	Effective Radiated Power (Band 5)	ERP < 7 Watt		
	§27.50(b)(10) §27.50(c)(10)	Effective Radiated Power (Band 12) (Band 13) (Band 17)	ERP < 3 Watt		
	§24.232(c) §27.50(h)(2)	Equivalent Isotropic Radiated Power (Band 2) (Band 25) (Band 7)	EIRP < 2Watt		
	§27.50(d)(4)	Equivalent Isotropic Radiated Power (Band 4) (Band 66)	EIRP < 1Watt		
3.5	§24.232(d)	Peak-to-Average Ratio	<13 dB	PASS	-
3.6	§2.1049	Occupied Bandwidth	Reporting Only	PASS	-
3.7	§2.1051 §22.917(a) §24.238(a) §27.53(c)(2)(4) §27.53(g) §27.53(h)	Conducted Band Edge Measurement (Band 2) (Band 4) (Band 5) (Band 12) (Band 13) (Band 17) (Band 25) (Band 66)	< 43+10log ₁₀ (P[Watts])	PASS	-
	§27.53(m)(4)	Conducted Band Edge Measurement (Band 7)	§27.53(m)(4)		
3.8	§2.1051 §22.917(a) §24.238(a) §27.53(c)(2) §27.53(g) §27.53(h)	Conducted Spurious Emission (Band 2) (Band 4) (Band 5) (Band 12) (Band 13) (Band 17) (Band 25) (Band 66)	< 43+10log ₁₀ (P[Watts])	PASS	-
	§2.1051 §27.53(m)(4)	Conducted Spurious Emission (Band 7)	< 55+10log ₁₀ (P[Watts])		
3.9	§2.1055 §22.355	Frequency Stability Temperature & Voltage	< 2.5 ppm for Part 22	PASS	-
	§2.1055 §24.235 §27.54		Within Authorized Band		



Report Section	FCC Rule	Description	Limit	Result	Remark
4.4	§2.1053 §22.917(a) §24.238(a) §27.53(c)(2) §27.53(f) §27.53(g) §27.53(h)	Radiated Spurious Emission (Band 2) (Band 4) (Band 5) (Band 12) (Band 13) (Band 17) (Band 25) (Band 66)	$< 43+10\log_{10}(P[\text{Watts}])$	PASS	Under limit 9.65 dB at 7692.000 MHz
	§2.1053 §27.53(m)(4)	Radiated Spurious Emission (Band 7)	$< 55+10\log_{10}(P[\text{Watts}])$		



1 General Description

1.1 Applicant

Sony Mobile Communications Inc.

4-12-3 Higashi-Shinagawa, Shinagawa-ku, Tokyo, 140-0002, Japan

1.2 Manufacturer

Sony Mobile Communications Inc.

4-12-3 Higashi-Shinagawa, Shinagawa-ku, Tokyo, 140-0002, Japan

1.3 Product Feature of Equipment Under Test

GSM/WCDMA/LTE, Bluetooth, DTS/UNII a/b/g/n/ac, FM Receiver, NFC, and GPS.

Standards-related Product Specification	
Antenna Type	Main : PIFA Antenna Aux. : C-feed Antenna

EUT Information List			
HW Version	SW Version	S/N	Performed Test Item
A	1.14	RQ3005VAJU	Conducted Measurement ERP/EIRP Test
		CQ300004S3	Conducted Measurement for 64QAM Radiated Spurious Emission

Accessory List	
AC Adapter 1	Model Name: UCH12
	S/N: VB17W34100228
Earphone 1	Model Name: MH410c
	S/N: N/A
USB Cable	Model Name: UCB20
	S/N: N/A

Note:

1. Above EUT list and accessory list used are electrically identical per declared by manufacturer.
2. Above the accessories list are used to exercise the EUT during test.
3. For other wireless features of this EUT, test report will be issued separately.

1.4 Modification of EUT

No modifications are made to the EUT during all test items.



1.5 Emission Designator

LTE Band 2		QPSK			16QAM			64QAM		
BW (MHz)	Frequency Range (MHz)	Emission Designator (99%OBW)	Frequency Tolerance (ppm)	Maximum EIRP(W)	Emission Designator (99%OBW)	Frequency Tolerance (ppm)	Maximum EIRP(W)	Emission Designator (99%OBW)	Frequency Tolerance (ppm)	Maximum EIRP(W)
1.4	1850.7 ~ 1909.3	1M09G7D	-	0.2109	1M10W7D	-	0.1706	1M09W7D	-	0.1380
3	1851.5 ~ 1908.5	2M74G7D	-	0.2307	2M73W7D	-	0.1875	2M73W7D	-	0.1514
5	1852.5 ~ 1907.5	4M53G7D	-	0.2360	4M50W7D	-	0.1901	4M51W7D	-	0.1510
10	1855.0 ~ 1905.0	9M07G7D	0.0019	0.2360	9M03W7D	-	0.1905	9M05W7D	-	0.1514
15	1857.5 ~ 1902.5	13M4G7D	-	0.2301	13M5W7D	-	0.1905	13M5W7D	-	0.1514
20	1860.0 ~ 1900.0	18M5G7D	-	0.2061	18M4W7D	-	0.1726	18M3W7D	-	0.1374
LTE Band 4		QPSK			16QAM			64QAM		
BW (MHz)	Frequency Range (MHz)	Emission Designator (99%OBW)	Frequency Tolerance (ppm)	Maximum EIRP(W)	Emission Designator (99%OBW)	Frequency Tolerance (ppm)	Maximum EIRP(W)	Emission Designator (99%OBW)	Frequency Tolerance (ppm)	Maximum EIRP(W)
1.4	1710.7 ~ 1754.3	1M10G7D	-	0.3105	1M09W7D	-	0.2489	1M10W7D	-	0.1991
3	1711.5 ~ 1753.5	2M75G7D	-	0.3076	2M72W7D	-	0.2506	2M74W7D	-	0.1986
5	1712.5 ~ 1752.5	4M51G7D	-	0.3105	4M50W7D	-	0.2512	4M50W7D	-	0.1991
10	1715.0 ~ 1750.0	9M05G7D	0.0018	0.3105	9M05W7D	-	0.2512	9M07W7D	-	0.1995
15	1717.5 ~ 1747.5	13M5G7D	-	0.3041	13M6W7D	-	0.2500	13M5W7D	-	0.1995
20	1720.0 ~ 1745.0	18M5G7D	-	0.3119	18M4W7D	-	0.2472	18M5W7D	-	0.1986
LTE Band 5		QPSK			16QAM			64QAM		
BW (MHz)	Frequency Range (MHz)	Emission Designator (99%OBW)	Frequency Tolerance (ppm)	Maximum ERP(W)	Emission Designator (99%OBW)	Frequency Tolerance (ppm)	Maximum ERP(W)	Emission Designator (99%OBW)	Frequency Tolerance (ppm)	Maximum ERP(W)
1.4	824.7 ~ 848.3	1M10G7D	-	0.1007	1M09W7D	-	0.0834	1M09W7D	-	0.0658
3	825.5 ~ 847.5	2M74G7D	-	0.1030	2M75W7D	-	0.0839	2M72W7D	-	0.0661
5	826.5 ~ 846.5	4M51G7D	-	0.1028	4M51W7D	-	0.0841	4M57W7D	-	0.0664
10	829.0 ~ 844.0	9M07G7D	0.0085	0.1033	9M05W7D	-	0.0838	9M07W7D	-	0.0667



LTE Band 7		QPSK			16QAM			64QAM		
BW (MHz)	Frequency Range (MHz)	Emission Designator (99%OBW)	Frequency Tolerance (ppm)	Maximum EIRP(W)	Emission Designator (99%OBW)	Frequency Tolerance (ppm)	Maximum EIRP(W)	Emission Designator (99%OBW)	Frequency Tolerance (ppm)	Maximum EIRP(W)
5	2502.5 ~ 2567.5	4M51G7D	-	0.2500	4M52W7D	-	0.1995	4M51W7D	-	0.1570
10	2505.0 ~ 2565.0	9M03G7D	0.0031	0.2495	9M05W7D	-	0.1950	9M05W7D	-	0.1585
15	2507.5 ~ 2562.5	13M6G7D	-	0.2506	13M5W7D	-	0.1995	13M5W7D	-	0.1570
20	2510.0 ~ 2560.0	18M3G7D	-	0.2512	18M4W7D	-	0.1991	18M4W7D	-	0.1585
LTE Band 12		QPSK			16QAM			64QAM		
BW (MHz)	Frequency Range (MHz)	Emission Designator (99%OBW)	Frequency Tolerance (ppm)	Maximum ERP(W)	Emission Designator (99%OBW)	Frequency Tolerance (ppm)	Maximum ERP(W)	Emission Designator (99%OBW)	Frequency Tolerance (ppm)	Maximum ERP(W)
1.4	699.7 ~ 715.3	1M10G7D	-	0.0705	1M09W7D	-	0.0579	1M09W7D	-	0.0462
3	700.5 ~ 714.5	2M75G7D	-	0.0705	2M75W7D	-	0.0582	2M72W7D	-	0.0460
5	701.5 ~ 713.5	4M49G7D	-	0.0700	4M51W7D	-	0.0579	4M50W7D	-	0.0454
10	704.0 ~ 711.0	9M11G7D	0.0079	0.0706	9M03W7D	-	0.0579	9M07W7D	-	0.0457
LTE Band 13		QPSK			16QAM			64QAM		
BW (MHz)	Frequency Range (MHz)	Emission Designator (99%OBW)	Frequency Tolerance (ppm)	Maximum ERP(W)	Emission Designator (99%OBW)	Frequency Tolerance (ppm)	Maximum ERP(W)	Emission Designator (99%OBW)	Frequency Tolerance (ppm)	Maximum ERP(W)
5	779.5 ~ 784.5	4M52G7D	-	0.1472	4M52W7D	-	0.1202	4M51W7D	-	0.0940
10	782.0	9M03G7D	0.0054	0.1476	9M01W7D	-	0.1189	9M05W7D	-	0.0923
LTE Band 17		QPSK			16QAM			64QAM		
BW (MHz)	Frequency Range (MHz)	Emission Designator (99%OBW)	Frequency Tolerance (ppm)	Maximum ERP(W)	Emission Designator (99%OBW)	Frequency Tolerance (ppm)	Maximum ERP(W)	Emission Designator (99%OBW)	Frequency Tolerance (ppm)	Maximum ERP(W)
5	706.5 ~ 713.5	4M52G7D	-	0.1109	4M51W7D	-	0.0927	4M50W7D	-	0.0723
10	709.0 ~ 711.0	9M13G7D	0.0097	0.1112	9M03W7D	-	0.0944	9M09W7D	-	0.0736



LTE Band 25		QPSK			16QAM			64QAM		
BW (MHz)	Frequency Range (MHz)	Emission Designator (99%OBW)	Frequency Tolerance (ppm)	Maximum EIRP(W)	Emission Designator (99%OBW)	Frequency Tolerance (ppm)	Maximum EIRP(W)	Emission Designator (99%OBW)	Frequency Tolerance (ppm)	Maximum EIRP(W)
1.4	1850.7 ~ 1914.3	1M10G7D	-	0.1995	1M09W7D	-	0.1656	1M10W7D	-	0.1315
3	1851.5 ~ 1913.5	2M72G7D	-	0.1995	2M73W7D	-	0.1660	2M75W7D	-	0.1318
5	1852.5 ~ 1912.5	4M53G7D	-	0.2004	4M51W7D	-	0.1671	4M52W7D	-	0.1327
10	1855 ~ 1910	9M09G7D	0.0012	0.2075	9M09W7D	-	0.1698	9M05W7D	-	0.1349
15	1857.5 ~ 1907.5	13M4G7D	-	0.2018	13M5W7D	-	0.1698	13M4W7D	-	0.1349
20	1860 ~ 1905	18M4G7D	-	0.2061	18M4W7D	-	0.1698	18M4W7D	-	0.1349
LTE Band 66		QPSK			16QAM			64QAM		
BW (MHz)	Frequency Range (MHz)	Emission Designator (99%OBW)	Frequency Tolerance (ppm)	Maximum ERP(W)	Emission Designator (99%OBW)	Frequency Tolerance (ppm)	Maximum ERP(W)	Emission Designator (99%OBW)	Frequency Tolerance (ppm)	Maximum ERP(W)
1.4	1710.7 ~ 1779.3	1M10G7D	-	0.2761	1M09W7D	-	0.2198	1M09W7D	-	0.1778
3	1711.5 ~ 1778.5	2M72G7D	-	0.2704	2M75W7D	-	0.2213	2M73W7D	-	0.1754
5	1712.5 ~ 1777.5	4M49G7D	-	0.2735	4M51W7D	-	0.2208	4M51W7D	-	0.1758
10	1715 ~ 1775	9M11G7D	0.0050	0.2667	9M03W7D	-	0.2163	9M03W7D	-	0.1774
15	1717.5 ~ 1772.5	13M4G7D	-	0.2773	13M5W7D	-	0.2228	13M5W7D	-	0.1758
20	1720 ~ 1770	18M3G7D	-	0.2780	18M4W7D	-	0.2228	18M4W7D	-	0.1774



1.6 Testing Location

Sporton Lab is accredited to ISO 17025 by Taiwan Accreditation Foundation (TAF code : 1190) and the FCC designation No. TW1190 and TW0007 under the FCC 2.948(e) by Mutual Recognition Agreement (MRA) in FCC Test.

Test Site	SPORTON INTERNATIONAL INC.	
Test Site Location	No. 52, Hwa Ya 1 st Rd., Hwa Ya Technology Park, Kwei-Shan District, Tao Yuan City, Taiwan, R.O.C. TEL: +886-3-327-3456 FAX: +886-3-328-4978	
Test Site No.	Sporton Site No.	
	TH03-HY	TH05-HY

Test Site	SPORTON INTERNATIONAL INC.	
Test Site Location	No.58, Aly. 75, Ln. 564, Wenhua 3rd Rd. Guishan Dist, Taoyuan City, Taiwan (R.O.C.) TEL: +886-3-327-0868 FAX: +886-3-327-0855	
Test Site No.	Sporton Site No.	
	03CH13-HY	

1.7 Applicable Standards

According to the specifications of the manufacturer, the EUT must comply with the requirements of the following standards:

- ♦ 47 CFR Part 2, 22(H), 24(E), 27
- ♦ ANSI / TIA-603-E-2016
- ♦ FCC KDB 971168 D01 Power Meas. License Digital Systems v03
- ♦ FCC KDB 412172 D01 Determining ERP and EIRP v01r01

Remark:

1. All test items were verified and recorded according to the standards and without any deviation during the test.
2. This EUT has also been tested and complied with the requirements of FCC Part 15, Subpart B, recorded in a separate test report.



2 Test Configuration of Equipment Under Test

2.1 Test Mode

Antenna port conducted and radiated test items listed below are performed according to KDB 971168 D01 Power Meas. License Digital Systems v03 with maximum output power.

Radiated measurements are performed by rotating the EUT in three different orthogonal test planes to find the maximum emission.

Test Items	Band	Bandwidth (MHz)						Modulation			RB #			Test Channel		
		1.4	3	5	10	15	20	QPSK	16QAM	64QAM	1	Half	Full	L	M	H
Max. Output Power	2	Y	Y	Y	Y	Y	Y	Y	Y	Y	Y	Y	Y	Y	Y	Y
	4	Y	Y	Y	Y	Y	Y	Y	Y	Y	Y	Y	Y	Y	Y	Y
	5	Y	Y	Y	Y	-	-	Y	Y	Y	Y	Y	Y	Y	Y	Y
	7	-	-	Y	Y	Y	Y	Y	Y	Y	Y	Y	Y	Y	Y	Y
	12	Y	Y	Y	Y	-	-	Y	Y	Y	Y	Y	Y	Y	Y	Y
	13	-	-	Y	Y	-	-	Y	Y	Y	Y	Y	Y	Y	Y	Y
	17	-	-	Y	Y	-	-	Y	Y	Y	Y	Y	Y	Y	Y	Y
	25	Y	Y	Y	Y	Y	Y	Y	Y	Y	Y	Y	Y	Y	Y	Y
	66	Y	Y	Y	Y	Y	Y	Y	Y	Y	Y	Y	Y	Y	Y	Y
Peak-to-Average Ratio	2						Y	Y	Y	Y	Y		Y	Y	Y	Y
	4						Y	Y	Y	Y	Y		Y	Y	Y	Y
	5				Y	-	-	Y	Y	Y	Y		Y	Y	Y	Y
	7	-	-				Y	Y	Y	Y	Y		Y	Y	Y	Y
	12				Y	-	-	Y	Y	Y	Y		Y	Y	Y	Y
	13	-	-		Y	-	-	Y	Y	Y	Y		Y	Y	Y	Y
	17	-	-		Y	-	-	Y	Y	Y	Y		Y	Y	Y	Y
	25						Y	Y	Y	Y	Y		Y	Y	Y	Y
	66						Y	Y	Y	Y	Y		Y	Y	Y	Y



Test Items	Band	Bandwidth (MHz)						Modulation			RB #			Test Channel		
		1.4	3	5	10	15	20	QPSK	16QAM	64QAM	1	Half	Full	L	M	H
26dB and 99% Bandwidth	2	✓	✓	✓	✓	✓	✓	✓	✓	✓			✓	✓	✓	✓
	4	✓	✓	✓	✓	✓	✓	✓	✓	✓			✓	✓	✓	✓
	5	✓	✓	✓	✓	-	-	✓	✓	✓			✓	✓	✓	✓
	7	-	-	✓	✓	✓	✓	✓	✓	✓			✓	✓	✓	✓
	12	✓	✓	✓	✓	-	-	✓	✓	✓			✓	✓	✓	✓
	13	-	-	✓	✓	-	-	✓	✓	✓			✓	✓	✓	✓
	17	-	-	✓	✓	-	-	✓	✓	✓			✓	✓	✓	✓
	25	✓	✓	✓	✓	✓	✓	✓	✓	✓			✓	✓	✓	✓
66	✓	✓	✓	✓	✓	✓	✓	✓	✓			✓	✓	✓	✓	
Conducted Band Edge	2	✓	✓	✓	✓	✓	✓	✓	✓	✓	✓		✓	✓		✓
	4	✓	✓	✓	✓	✓	✓	✓	✓	✓	✓		✓	✓		✓
	5	✓	✓	✓	✓	-	-	✓	✓	✓	✓		✓	✓		✓
	7	-	-	✓	✓	✓	✓	✓	✓	✓	✓		✓	✓		✓
	12	✓	✓	✓	✓	-	-	✓	✓	✓	✓		✓	✓		✓
	13	-	-	✓	✓	-	-	✓	✓	✓	✓		✓	✓		✓
	17	-	-	✓	✓	-	-	✓	✓	✓	✓		✓	✓		✓
	25	✓	✓	✓	✓	✓	✓	✓	✓	✓	✓		✓	✓		✓
66	✓	✓	✓	✓	✓	✓	✓	✓	✓	✓		✓	✓		✓	
Conducted Spurious Emission	2	✓	✓	✓	✓	✓	✓	✓	✓		✓			✓	✓	✓
	4	✓	✓	✓	✓	✓	✓	✓	✓		✓			✓	✓	✓
	5	✓	✓	✓	✓	-	-	✓	✓		✓			✓	✓	✓
	7	-	-	✓	✓	✓	✓	✓	✓		✓			✓	✓	✓
	12	✓	✓	✓	✓	-	-	✓	✓		✓			✓	✓	✓
	13	-	-	✓	✓	-	-	✓	✓		✓			✓	✓	✓
	17	-	-	✓	✓	-	-	✓	✓		✓			✓	✓	✓
	25	✓	✓	✓	✓	✓	✓	✓	✓		✓			✓	✓	✓
66	✓	✓	✓	✓	✓	✓	✓	✓		✓			✓	✓	✓	



Test Items	Band	Bandwidth (MHz)						Modulation			RB #			Test Channel			
		1.4	3	5	10	15	20	QPSK	16QAM	64QAM	1	Half	Full	L	M	H	
Frequency Stability	2				v			v					v		v		
	4				v			v					v		v		
	5				v	-	-	v					v		v		
	7		-		v			v					v		v		
	12				v	-	-	v					v		v		
	13		-		v	-	-	v					v		v		
	17		-		v	-	-	v					v		v		
	25				v			v					v		v		
	66				v			v					v		v		
E.R.P./ E.I.R.P.	2	v	v	v	v	v	v	v	v			v	v		v	v	v
	4	v	v	v	v	v	v	v	v			v	v		v	v	v
	5	v	v	v	v	-	-	v	v			v			v	v	v
	7	-	-	v	v	v	v	v	v			v			v	v	v
	12	v	v	v	v	v	v	v	v			v	v		v	v	v
	13	-	-	v	v	v	v	v	v			v			v	v	v
	17	-	-	v	v	-	-	v	v			v			v	v	v
	25	v	v	v	v	v	v	v	v			v	v		v	v	v
	66	v	v	v	v	v	v	v	v			v	v		v	v	v
Radiated Spurious Emission	2	v	v	v	v	v	v	v				v			v	v	v
	4	v	v	v	v	v	v	v				v			v	v	v
	5	v	v	v	v	-	-	v				v			v	v	v
	7	-	-	v	v	v	v	v				v			v	v	v
	12	v	v	v	v	-	-	v				v			v	v	v
	13	-	-	v	v	-	-	v				v			v	v	v
	17	-	-	v	v	-	-	v				v			v	v	v
	25	v	v	v	v	v	v	v				v			v	v	v
	66	v	v	v	v	v	v	v				v			v	v	v
Note	<ol style="list-style-type: none"> The mark "v" means that this configuration is chosen for testing The mark "-" means that this bandwidth is not supported. The device is investigated from 30MHz to 10 times of fundamental signal for radiated spurious emission test under different RB size/offset and modulations in exploratory test. Subsequently, only the worst case emissions are reported. 																

2.2 Connection Diagram of Test System

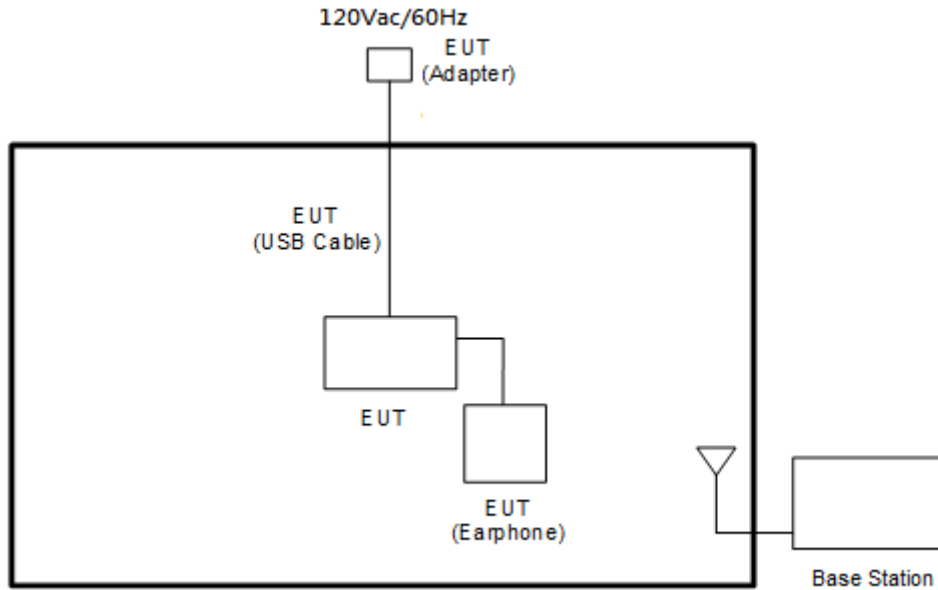

2.3 Support Unit used in test configuration and system

Item	Equipment	Trade Name	Model No.	FCC ID	Data Cable	Power Cord
1.	Base Station	Anritsu	8820C	N/A	N/A	Unshielded, 1.8 m

2.4 Measurement Results Explanation Example

For all conducted test items:

The offset level is set in the spectrum analyzer to compensate the RF cable loss and attenuator factor between EUT conducted output port and spectrum analyzer. With the offset compensation, the spectrum analyzer reading level is exactly the EUT RF output level.

The spectrum analyzer offset is derived from RF cable loss and attenuator factor.

Offset = RF cable loss + attenuator factor.

Following shows an offset computation example with cable loss 4.2 dB and 10dB attenuator.

Example :

$$\begin{aligned} \text{Offset(dB)} &= \text{RF cable loss(dB)} + \text{attenuator factor(dB)}. \\ &= 4.2 + 10 = 14.2 \text{ (dB)} \end{aligned}$$



2.5 Frequency List of Low/Middle/High Channels

LTE Band 2 Channel and Frequency List				
BW [MHz]	Channel/Frequency(MHz)	Lowest	Middle	Highest
20	Channel	18700	18900	19100
	Frequency	1860	1880	1900
15	Channel	18675	18900	19125
	Frequency	1857.5	1880	1902.5
10	Channel	18650	18900	19150
	Frequency	1855	1880	1905
5	Channel	18625	18900	19175
	Frequency	1852.5	1880	1907.5
3	Channel	18615	18900	19185
	Frequency	1851.5	1880	1908.5
1.4	Channel	18607	18900	19193
	Frequency	1850.7	1880	1909.3

LTE Band 4 Channel and Frequency List				
BW [MHz]	Channel/Frequency(MHz)	Lowest	Middle	Highest
20	Channel	20050	20175	20300
	Frequency	1720	1732.5	1745
15	Channel	20025	20175	20325
	Frequency	1717.5	1732.5	1747.5
10	Channel	20000	20175	20350
	Frequency	1715	1732.5	1750
5	Channel	19975	20175	20375
	Frequency	1712.5	1732.5	1752.5
3	Channel	19965	20175	20385
	Frequency	1711.5	1732.5	1753.5
1.4	Channel	19957	20175	20393
	Frequency	1710.7	1732.5	1754.3



LTE Band 5 Channel and Frequency List				
BW [MHz]	Channel/Frequency(MHz)	Lowest	Middle	Highest
10	Channel	20450	20525	20600
	Frequency	829	836.5	844
5	Channel	20425	20525	20625
	Frequency	826.5	836.5	846.5
3	Channel	20415	20525	20635
	Frequency	825.5	836.5	847.5
1.4	Channel	20407	20525	20643
	Frequency	824.7	836.5	848.3

LTE Band 7 Channel and Frequency List				
BW [MHz]	Channel/Frequency(MHz)	Lowest	Middle	Highest
20	Channel	20850	21100	21350
	Frequency	2510	2535	2560
15	Channel	20825	21100	21375
	Frequency	2507.5	2535	2562.5
10	Channel	20800	21100	21400
	Frequency	2505	2535	2565
5	Channel	20775	21100	21425
	Frequency	2502.5	2535	2567.5

LTE Band 12 Channel and Frequency List				
BW [MHz]	Channel/Frequency(MHz)	Lowest	Middle	Highest
10	Channel	23060	23095	23130
	Frequency	704	707.5	711
5	Channel	23035	23095	23155
	Frequency	701.5	707.5	713.5
3	Channel	23025	23095	23165
	Frequency	700.5	707.5	714.5
1.4	Channel	23017	23095	23173
	Frequency	699.7	707.5	715.3



LTE Band 13 Channel and Frequency List				
BW [MHz]	Channel/Frequency(MHz)	Lowest	Middle	Highest
10	Channel	-	23230	-
	Frequency	-	782	-
5	Channel	23205	23230	23255
	Frequency	779.5	782	784.5

LTE Band 17 Channel and Frequency List				
BW [MHz]	Channel/Frequency(MHz)	Lowest	Middle	Highest
10	Channel	23780	23790	23800
	Frequency	709	710	711
5	Channel	23755	23790	23825
	Frequency	706.5	710	713.5

LTE Band 25 Channel and Frequency List				
BW [MHz]	Channel/Frequency(MHz)	Lowest	Middle	Highest
20	Channel	26140	26340	26590
	Frequency	1860	1880	1905
15	Channel	26115	26340	26615
	Frequency	1857.5	1880	1907.5
10	Channel	26090	26340	26640
	Frequency	1855	1880	1910
5	Channel	26065	26340	26665
	Frequency	1852.5	1880	1912.5
3	Channel	26055	26340	26675
	Frequency	1851.5	1880	1913.5
1.4	Channel	26047	26340	26683
	Frequency	1850.7	1880	1914.3



LTE Band 66 Channel and Frequency List				
BW [MHz]	Channel/Frequency(MHz)	Lowest	Middle	Highest
20	Channel	132072	132322	132572
	Frequency	1720	1745	1770
15	Channel	132047	132322	132597
	Frequency	1717.5	1745	1772.5
10	Channel	132022	132322	132622
	Frequency	1715	1745	1775
5	Channel	131997	132322	132647
	Frequency	1712.5	1745	1777.5
3	Channel	131987	132322	132657
	Frequency	1711.5	1745	1778.5
1.4	Channel	131979	132322	132665
	Frequency	1710.7	1745	1779.3

3 Conducted Test Items

3.1 Measuring Instruments

See list of measuring instruments of this test report.

3.2 Test Setup

3.2.1 Conducted Output Power

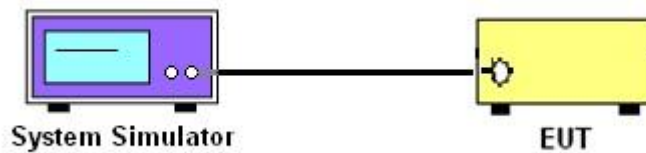

3.2.2 Peak-to-Average Ratio, Occupied Bandwidth ,Conducted Band-Edge and Conducted Spurious Emission

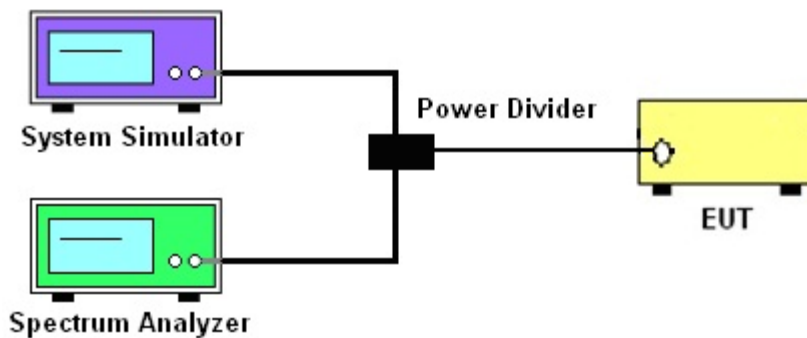

3.2.3 Frequency Stability

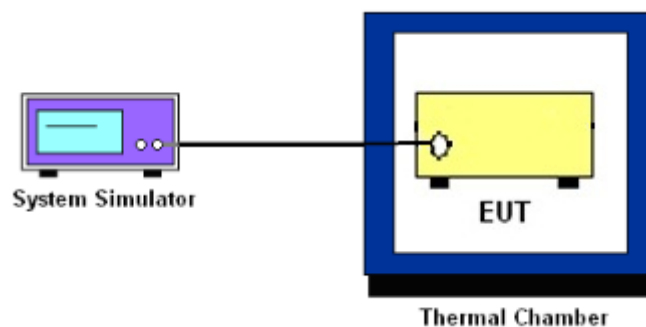

3.3 Test Result of Conducted Test

Please refer to Appendix A.



3.4 Conducted Output Power and ERP/EIRP

3.4.1 Description of the Conducted Output Power Measurement and ERP/EIRP Measurement

A system simulator was used to establish communication with the EUT. Its parameters were set to force the EUT transmitting at maximum output power. The measured power in the radio frequency on the transmitter output terminals shall be reported.

The ERP of mobile transmitters must not exceed 7 Watts for LTE Band 5.

The ERP of mobile transmitters must not exceed 3 Watts for LTE Band 12, Band 13 and Band 17.

The EIRP of mobile transmitters must not exceed 2 Watts for LTE Band 2, Band 7, and Band 25.

The EIRP of mobile transmitters must not exceed 1 Watts for LTE Band 4, Band 66.

According to KDB 412172 D01 Power Approach,

$EIRP = P_T + G_T - L_C$, $ERP = EIRP - 2.15$, where

P_T = transmitter output power in dBm

G_T = gain of the transmitting antenna in dBi

L_C = signal attenuation in the connecting cable between the transmitter and antenna in dB

3.4.2 Test Procedures

1. The transmitter output port was connected to the system simulator.
2. Set EUT at maximum power through the system simulator.
3. Select lowest, middle, and highest channels for each band and different modulation.
4. Measure and record the power level from the system simulator.



3.5 Peak-to-Average Ratio

3.5.1 Description of the PAR Measurement

Power Complementary Cumulative Distribution Function (CCDF) curves provide a means for characterizing the power peaks of a digitally modulated signal on a statistical basis. A CCDF curve depicts the probability of the peak signal amplitude exceeding the average power level. Most contemporary measurement instrumentation include the capability to produce CCDF curves for an input signal provided that the instrument's resolution bandwidth can be set wide enough to accommodate the entire input signal bandwidth. In measuring transmissions in this band using an average power technique, the peak-to-average ratio (PAR) of the transmission may not exceed 13 dB.

3.5.2 Test Procedures

1. The testing follows FCC KDB 971168 v03 Section 5.7.2.
2. The EUT was connected to spectrum and system simulator via a power divider.
3. Set the CCDF (Complementary Cumulative Distribution Function) option in spectrum analyzer.
4. The highest RF powers were measured and recorded the maximum PAPR level associated with a probability of 0.1 %.
5. Record the deviation as Peak to Average Ratio.



3.6 Occupied Bandwidth

3.6.1 Description of Occupied Bandwidth Measurement

The occupied bandwidth is the width of a frequency band such that, below the lower and above the upper frequency limits, the mean powers emitted are each equal to a specified percentage 0.5% of the total mean transmitted power.

The 26 dB emission bandwidth is defined as the frequency range between two points, one above and one below the carrier frequency, at which the spectral density of the emission is attenuated 26 dB below the maximum in-band spectral density of the modulated signal. Spectral density (power per unit bandwidth) is to be measured with a detector of resolution bandwidth equal to approximately 1.0% of the emission bandwidth.

3.6.2 Test Procedures

1. The testing follows FCC KDB 971168 v03 Section 4.2.
2. The EUT was connected to spectrum analyzer and system simulator via a power divider.
3. The spectrum analyzer center frequency is set to the nominal EUT channel center frequency. The span range for the spectrum analyzer shall be between two and five times the anticipated OBW.
4. The nominal resolution bandwidth (RBW) shall be in the range of 1 to 5 % of the anticipated OBW, and the VBW shall be at least 3 times the RBW.
5. Set the detection mode to peak, and the trace mode to max hold.
6. Determine the reference value: Set the EUT to transmit a modulated signal. Allow the trace to stabilize. Set the spectrum analyzer marker to the highest level of the displayed trace.
(this is the reference value)
7. Determine the “-26 dB down amplitude” as equal to (Reference Value – X).
8. Place two markers, one at the lowest and the other at the highest frequency of the envelope of the spectral display such that each marker is at or slightly below the “-X dB down amplitude” determined in step 6. If a marker is below this “-X dB down amplitude” value it shall be placed as close as possible to this value. The OBW is the positive frequency difference between the two markers.
9. Use the 99 % power bandwidth function of the spectrum analyzer and report the measured bandwidth.



3.7 Conducted Band Edge

3.7.1 Description of Conducted Band Edge Measurement

22.917(a)

For operations in the 824 – 849 MHz band, the FCC limit is $43 + 10\log_{10}(P[\text{Watts}])$ dB below the transmitter power $P(\text{Watts})$ in a 100kHz bandwidth. However, in the 1MHz bands immediately outside and adjacent to the licensee's frequency block, a resolution bandwidth of at least one percent of the emission bandwidth of the fundamental emission of the transmitter may be employed.

24.238 (a)

For operations in the 1850-1910 and 1930-1990 MHz band, the FCC limit is $43 + 10\log_{10}(P[\text{Watts}])$ dB below the transmitter power $P(\text{Watts})$ in a 1MHz bandwidth. However, in the 1 MHz bands immediately outside and adjacent to the frequency block a resolution bandwidth of at least one percent of the emission bandwidth of the fundamental emission of the transmitter may be employed.

27.53 (c)

For operations in the 776-788 MHz band, the FCC limit is $43 + 10\log_{10}(P[\text{Watts}])$ dB below the transmitter power $P(\text{Watts})$ in a 100 kHz bandwidth. However, in the 100 kHz bands immediately outside and adjacent to the frequency block, a resolution bandwidth of at least 30 kHz may be employed. In addition, the power of any unwanted emissions in any 6.25 kHz bandwidth for all frequencies between 763-775 MHz and 793-806 MHz shall be attenuated below the transmitter power, P (dBW), by at least $65 + 10 \log_{10} p(\text{watts})$, dB, for mobile and portable equipment.

27.53 (g)

For operations in the 698 -746 MHz band, the FCC limit is $43 + 10\log_{10}(P[\text{Watts}])$ dB below the transmitter power $P(\text{Watts})$ in a 100 kHz bandwidth. However, in the 100 kilohertz bands immediately outside and adjacent to a licensee's frequency block, a resolution bandwidth of at least 30 kHz may be employed.

27.53 (h)

For operations in the 1710 – 1755 MHz band, the FCC limit is $43 + 10\log_{10}(P[\text{Watts}])$ dB below the transmitter power $P(\text{Watts})$ in a 1 MHz bandwidth. However, in the 1MHz bands immediately outside and adjacent to the licensee's frequency block, a resolution bandwidth of at least one percent of the emission bandwidth of the fundamental emission of the transmitter may be employed.



27.53(m)(4)

For mobile digital stations, the attenuation factor shall be not less than $40 + 10 \log (P)$ dB on all frequencies between the channel edge and 5 megahertz from the channel edge, $43 + 10 \log (P)$ dB on all frequencies between 5 megahertz and X megahertz from the channel edge, and $55 + 10 \log (P)$ dB on all frequencies more than X megahertz from the channel edge, where X is the greater of 6 megahertz or the actual emission bandwidth as defined in paragraph (m)(6) of this section. In addition, the attenuation factor shall not be less that $43 + 10 \log (P)$ dB on all frequencies between 2490.5 MHz and 2496 MHz and $55 + 10 \log (P)$ dB at or below 2490.5 MHz. Mobile Satellite Service licensees operating on frequencies below 2495 MHz may also submit a documented interference complaint against BRS licensees operating on channel BRS Channel 1 on the same terms and conditions as adjacent channel BRS or EBS licensees.

3.7.2 Test Procedures

1. The testing follows FCC KDB 971168 v03 Section 6.0.
2. The EUT was connected to spectrum analyzer and system simulator via a power divider.
3. The band edges of low and high channels for the highest RF powers were measured.
4. Set RBW \geq 1% EBW in the 1MHz band immediately outside and adjacent to the band edge.
5. Beyond the 1 MHz band from the band edge, RBW=1MHz was used.
6. Set spectrum analyzer with RMS detector.
7. The RF fundamental frequency should be excluded against the limit line in the operating frequency band.
8. Checked that all the results comply with the emission limit line.
The limit line is derived from $43 + 10\log(P)$ dB below the transmitter power P(Watts)
9. For LTE Band 7, the other 40 dB, and 55 dB have additionally applied same calculation above.



3.8 Conducted Spurious Emission

3.8.1 Description of Conducted Spurious Emission Measurement

The power of any emission outside of the authorized operating frequency ranges must be lower than the transmitter power (P) by a factor of at least $43 + 10 \log (P)$ dB.

For Band 7

The power of any emission outside of the authorized operating frequency ranges must be lower than the transmitter power (P) by a factor of at least $55 + 10 \log (P)$ dB.

It is measured by means of a calibrated spectrum analyzer and scanned from 30 MHz up to a frequency including its 10th harmonic.

3.8.2 Test Procedures

1. The testing follows FCC KDB 971168 v03 Section 6.0.
2. The EUT was connected to spectrum analyzer and system simulator via a power divider.
3. The RF output of EUT was connected to the spectrum analyzer by RF cable and attenuator. The path loss was compensated to the results for each measurement.
4. The middle channel for the highest RF power within the transmitting frequency was measured.
5. The conducted spurious emission for the whole frequency range was taken.
6. Make the measurement with the spectrum analyzer's RBW = 1MHz, VBW = 3MHz.
7. Set spectrum analyzer with RMS detector.
8. Taking the record of maximum spurious emission.
9. The RF fundamental frequency should be excluded against the limit line in the operating frequency band.
10. The limit line is derived from $43 + 10\log(P)$ dB below the transmitter power P(Watts)
11. For Band 7
The limit line is derived from $55 + 10\log(P)$ dB below the transmitter power P(Watts)



3.9 Frequency Stability

3.9.1 Description of Frequency Stability Measurement

The frequency stability shall be measured by variation of ambient temperature and variation of primary supply voltage to ensure that the fundamental emission stays within the authorized frequency block. The frequency stability of the transmitter shall be maintained within $\pm 0.00025\%$ ($\pm 2.5\text{ppm}$) of the center frequency.

3.9.2 Test Procedures for Temperature Variation

1. The testing follows FCC KDB 971168 v03 Section 9.0.
2. The EUT was set up in the thermal chamber and connected with the system simulator.
3. With power OFF, the temperature was decreased to -30°C and the EUT was stabilized before testing. Power was applied and the maximum change in frequency was recorded within one minute.
4. With power OFF, the temperature was raised in 10°C step up to 50°C . The EUT was stabilized at each step for at least half an hour. Power was applied and the maximum frequency change was recorded within one minute.

3.9.3 Test Procedures for Voltage Variation

1. The testing follows FCC KDB 971168 v03 Section 9.0.
2. The EUT was placed in a temperature chamber at $20\pm 5^{\circ}\text{C}$ and connected with the system simulator.
3. The power supply voltage to the EUT was varied from 85% to 115% of the nominal value measured at the input to the EUT.
4. The variation in frequency was measured for the worst case.

4 Radiated Test Items

4.1 Measuring Instruments

See list of measuring instruments of this test report.

4.2 Test Setup

4.2.1 For radiated test from 30MHz to 1GHz

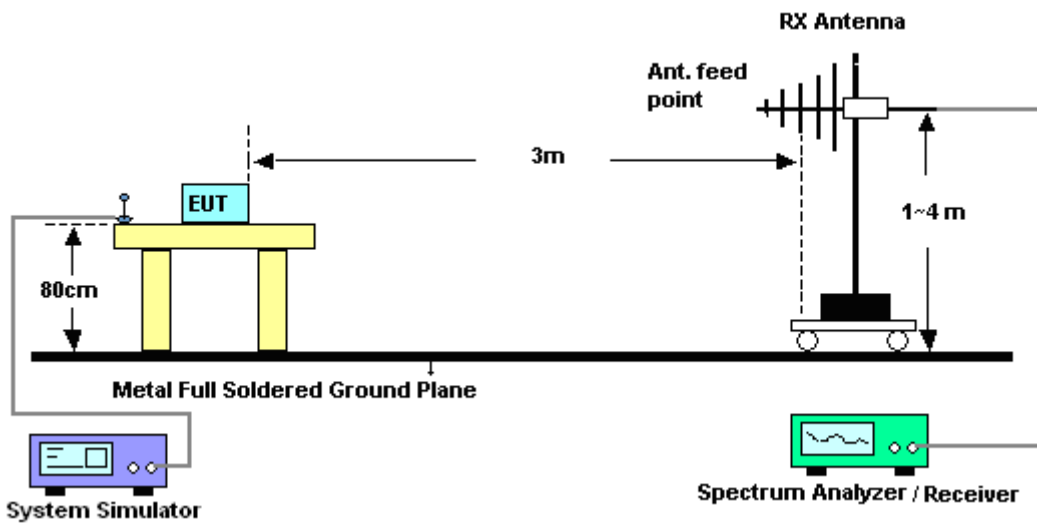

4.2.2 For radiated test above 1GHz

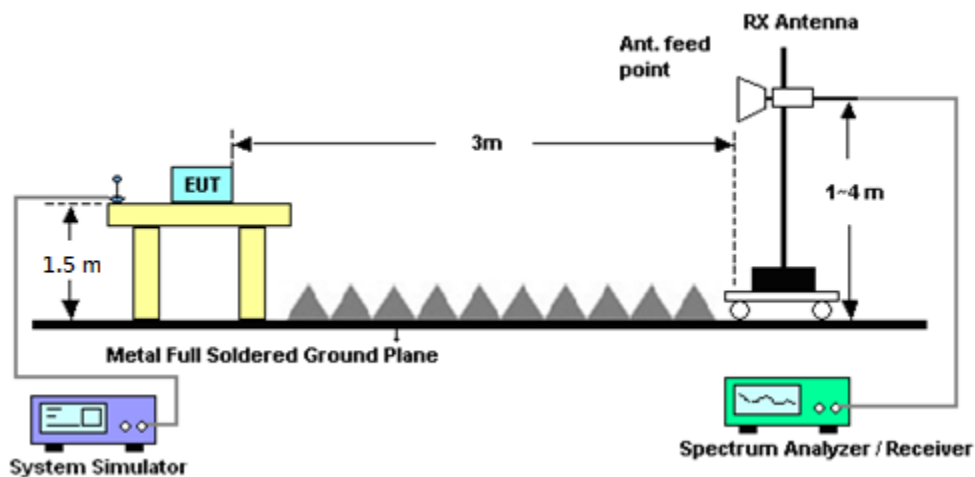

4.3 Test Result of Radiated Test

Please refer to Appendix B.



4.4 Radiated Spurious Emission

4.4.1 Description of Radiated Spurious Emission

The radiated spurious emission was measured by substitution method according to ANSI / TIA-603-E-2016. The power of any emission outside of the authorized operating frequency ranges must be attenuated below the transmitter power (P) by a factor of at least $43 + 10 \log (P)$ dB.

For Band 7

The power of any emission outside of the authorized operating frequency ranges must be attenuated below the transmitter power (P) by a factor of at least $55 + 10 \log (P)$ dB.

For LTE Band 12,13,17

For operations in the 746-758 MHz, 775-788 MHz, and 805-806 MHz bands, emissions in the band 1559-1610 MHz shall be limited to -70 dBW/MHz equivalent isotropically radiated power (EIRP) for wideband signals, and -80 dBW EIRP for discrete emissions of less than 700 Hz bandwidth.

The spectrum is scanned from 30 MHz up to a frequency including its 10th harmonic.

4.4.2 Test Procedures

1. The testing follows FCC KDB 971168 v03 Section 5.8 and ANSI / TIA-603-E-2016 Section 2.2.12.
2. The EUT was placed on a turntable with 0.8 meter for frequency below 1GHz and 1.5 meter for frequency above 1GHz respectively above ground.
3. The EUT was set 3 meters from the receiving antenna, which was mounted on the antenna tower.
4. The table was rotated 360 degrees to determine the position of the highest spurious emission.
5. The height of the receiving antenna is varied between one meter and four meters to search the maximum spurious emission for both horizontal and vertical polarizations.
6. Make the measurement with the spectrum analyzer's RBW = 1MHz, VBW = 3MHz, taking the record of maximum spurious emission.
7. A horn antenna was substituted in place of the EUT and was driven by a signal generator.
8. Tune the output power of signal generator to the same emission level with EUT maximum spurious emission.
9. Taking the record of output power at antenna port.
10. Repeat step 7 to step 8 for another polarization.
11. The RF fundamental frequency should be excluded against the limit line in the operating frequency band.
The limit line is derived from $43 + 10\log(P)$ dB below the transmitter power P(Watts)
12. For Band 7
The limit line is derived from $55 + 10\log(P)$ dB below the transmitter power P(Watts)
13. $EIRP \text{ (dBm)} = S.G. \text{ Power} - Tx \text{ Cable Loss} + Tx \text{ Antenna Gain}$
 $ERP \text{ (dBm)} = EIRP - 2.15$



5 List of Measuring Equipment

Instrument	Manufacturer	Model No.	Serial No.	Characteristics	Calibration Date	Test Date	Due Date	Remark
Hygrometer	TECEPEL	DTM-303B	TP150115	N/A	Mar. 28, 2017	Aug. 03, 2017~ Oct. 06, 2017	Mar. 27, 2018	Conducted (TH05-HY)
Spectrum Analyzer	Rohde & Schwarz	FSV40	101397	10Hz~40GHz	Nov. 04, 2016	Aug. 03, 2017~ Oct. 06, 2017	Nov. 03, 2017	Conducted (TH05-HY)
Temperature Chamber	ESPEC	SU-241	92003713	-30°C ~95°C	Jun. 05, 2017	Aug. 03, 2017~ Oct. 06, 2017	Jun. 04, 2018	Conducted (TH05-HY)
Programmable Power Supply	GW Instek	PSS-2005	EL890001	1V~20V 0.5A~5A	Oct. 03, 2016	Aug. 03, 2017~ Oct. 01, 2017	Oct. 02, 2017	Conducted (TH05-HY)
Programmable Power Supply	GW Instek	PSS-2005	EL890001	1V~20V 0.5A~5A	Oct. 06, 2017	Oct. 06, 2017	Oct. 05, 2018	Conducted (TH05-HY)
LTE Base Station	Anritsu	MT8820C	6201432821	GSM/GPRS /WCDMA/LTE	Oct. 11, 2016	Aug. 03, 2017~ Oct. 06, 2017	Oct. 10, 2017	Conducted (TH05-HY)
RF Cable	HUBER + SUHNER	SUCOFLEX 104	MY84209521	1GHz~26GHz	Dec. 02, 2016	Aug. 03, 2017~ Oct. 06, 2017	Dec. 01, 2017	Conducted (TH05-HY)
Bilog Antenna	TESEQ	CBL 6111D&008	40103&04	30MHz to 1GHz	Jan. 07, 2017	Oct. 14, 2017 ~ Oct. 26, 2017	Jan. 06, 2018	Radiation (03CH13-HY)
Horn Antenna	SCHWARZBECK	BBHA 9120 D	9120D-1241	1GHz ~ 18GHz	May 02, 2017	Oct. 14, 2017 ~ Oct. 26, 2017	May 01, 2018	Radiation (03CH13-HY)
Horn Antenna	SCHWARZBECK	BBHA 9120 D	9120D-1522	1G~18GHz	Mar. 17, 2017	Oct. 14, 2017 ~ Oct. 26, 2017	Mar. 16, 2018	Radiation (03CH13-HY)
SHF-EHF Horn Antenna	SCHWARZBECK	BBHA 9170	BBHA9170251	18GHz- 40GHz	Nov. 08, 2016	Oct. 14, 2017 ~ Oct. 26, 2017	Nov. 07, 2017	Radiation (03CH13-HY)
SHF-EHF Horn Antenna	SCHWARZBECK	BBHA 9170	BBHA9170584	18GHz- 40GHz	Nov. 08, 2016	Oct. 14, 2017 ~ Oct. 26, 2017	Nov. 07, 2017	Radiation (03CH13-HY)
Amplifier	Sonoma-Instrument	310 N	187282	9KHz~1GHz	Dec. 21, 2016	Oct. 14, 2017 ~ Oct. 26, 2017	Dec. 20, 2017	Radiation (03CH13-HY)
Preamplifier	MITEQ	TTA 1840-35-HG	1887435	18GHz ~ 40GHz	Oct. 11, 2017	Oct. 14, 2017 ~ Oct. 26, 2017	Oct. 12, 2018	Radiation (03CH13-HY)
Preamplifier	MITEQ	AMF-7D-00 101800-30-1	1590074	1GHz~18GHz	May 22, 2017	Oct. 14, 2017 ~ Oct. 26, 2017	May 21, 2018	Radiation (03CH13-HY)
Preamplifier	Keysight	83017A	MY53270147	1GHz~26.5GHz	Jan. 09, 2017	Oct. 14, 2017 ~ Oct. 26, 2017	Jan. 08, 2018	Radiation (03CH13-HY)
Spectrum Analyzer	Keysight	N9010A	MY55370526	N/A	Mar. 15, 2017	Oct. 14, 2017 ~ Oct. 26, 2017	Mar. 14, 2018	Radiation (03CH13-HY)



Instrument	Manufacturer	Model No.	Serial No.	Characteristics	Calibration Date	Test Date	Due Date	Remark
Controller	EMEC	EM1000	N/A	Control Turn table & Ant Mast	N/A	Oct. 14, 2017 ~ Oct. 26, 2017	N/A	Radiation (03CH13-HY)
Antenna Mast	EMEC	AM-BS-450 0-B	N/A	1m~4m	N/A	Oct. 14, 2017 ~ Oct. 26, 2017	N/A	Radiation (03CH13-HY)
Turn Table	EMEC	TT2000	N/A	0~360 Degree	N/A	Oct. 14, 2017 ~ Oct. 26, 2017	N/A	Radiation (03CH13-HY)
Hygrometer	TECPEL	DTM-303B	TP140320	N/A	Nov. 14, 2016	Oct. 14, 2017 ~ Oct. 26, 2017	Nov. 13, 2017	Radiation (03CH13-HY)
Signal Generator	Anritsu	MG3694C	163401	0.1Hz~40GHz	Jan. 04, 2017	Oct. 14, 2017 ~ Oct. 26, 2017	Jan. 03, 2018	Radiation (03CH13-HY)
RF Cable	HUBER + SUHNER	SUCOFLEX 104	MY249564 MY249524	25GHz~40GHz	Jan. 27, 2017	Oct. 14, 2017 ~ Oct. 26, 2017	Jan. 26, 2018	Radiation (03CH13-HY)
RF Cable	HUBER + SUHNER	SUCOFLEX 104	MY249564 MY249524	30MHz~1GHz	Jan. 27, 2017	Oct. 14, 2017 ~ Oct. 26, 2017	Jan. 26, 2018	Radiation (03CH13-HY)
RF Cable	HUBER + SUHNER	SUCOFLEX 104	MY249564 MY249524	1GHz~25GHz	Jan. 27, 2017	Oct. 14, 2017 ~ Oct. 26, 2017	Jan. 26, 2018	Radiation (03CH13-HY)
Filter	Wainwright	WHKX12-27 00-3000-180	SN2	3 GHz High Pass	Nov. 22, 2016	Oct. 14, 2017 ~ Oct. 26, 2017	Nov. 21, 2017	Radiation (03CH13-HY)
Filter	Wainwright	WHKX12-10 80-1200-150	SN1	1.2 GHz Highpas	Jul. 17, 2017	Oct. 14, 2017 ~ Oct. 26, 2017	Jul. 16, 2018	Radiation (03CH13-HY)
Filter	Wainwright	WLKS1200-12SS	SN2	1.2G Low Pass	Jul. 17, 2017	Oct. 14, 2017 ~ Oct. 26, 2017	Jul. 16, 2018	Radiation (03CH13-HY)
Notch Filter	Wainwright	WRCT/800/ 960-0.2/40-8	SN11	GSM850	Nov. 22, 2016	Oct. 14, 2017 ~ Oct. 26, 2017	Nov. 21, 2017	Radiation (03CH13-HY)
Notch Filter	Wainwright	WRCT1850/ 1910-40/8S	SN21	1900	Nov. 22, 2016	Oct. 14, 2017 ~ Oct. 26, 2017	Nov. 21, 2017	Radiation (03CH13-HY)
Notch Filter	Wainwright	WRCT2500/ 2570-10/40-	SN1 R	LTE Band7	Aug. 24, 2017	Oct. 14, 2017 ~ Oct. 26, 2017	Aug. 23, 2018	Radiation (03CH13-HY)
Test Software	N/A	E3	6.2009-8-24	N/A	N/A	Oct. 14, 2017 ~ Oct. 26, 2017	N/A	Radiation (03CH13-HY)



6 Uncertainty of Evaluation

Uncertainty of Radiated Emission Measurement (30 MHz ~ 1000 MHz)

Measuring Uncertainty for a Level of Confidence of 95% (U = 2Uc(y))	3.07
---------------------------------------------------------------------	------

Uncertainty of Radiated Emission Measurement (1 GHz ~ 40 GHz)

Measuring Uncertainty for a Level of Confidence of 95% (U = 2Uc(y))	3.48
---------------------------------------------------------------------	------

Uncertainty of Radiated Emission Measurement (18 GHz ~ 40 GHz)

Measuring Uncertainty for a Level of Confidence of 95% (U = 2Uc(y))	3.92
---------------------------------------------------------------------	------



Appendix A. Test Results of Conducted Test

Conducted Output Power(Average power)

LTE Band 2 Maximum Average Power [dBm]						
BW [MHz]	RB Size	RB Offset	Mod	Lowest	Middle	Highest
20	1	0	QPSK	23.84	23.75	22.61
20	1	49		23.11	23.83	23.59
20	1	99		22.73	22.78	23.04
20	50	0		22.89	22.84	22.76
20	50	24		22.88	22.83	23.38
20	50	50		22.76	22.77	23.42
20	100	0		22.83	22.81	23.48
20	1	0	16-QAM	22.99	23.07	21.83
20	1	49		22.52	22.99	22.91
20	1	99		22.21	22.19	22.37
20	50	0		21.91	21.84	21.91
20	50	24		21.88	21.86	22.42
20	50	50		21.79	21.77	22.45
20	100	0		21.86	21.78	22.47
20	1	0	64-QAM	22.08	22.07	20.91
20	1	49		21.78	22.05	21.93
20	1	99		21.29	21.37	21.51
20	50	0		20.92	20.81	21.06
20	50	24		20.89	20.82	21.36
20	50	50		20.80	20.78	21.41
20	100	0		20.88	20.79	21.44
15	1	0	QPSK	23.98	23.90	22.58
15	1	37		23.89	23.82	24.32
15	1	74		23.08	23.66	23.20
15	36	0		23.04	22.92	23.37
15	36	20		23.04	22.97	23.48
15	36	39		22.96	22.91	23.44
15	75	0		23.00	22.94	23.47
15	1	0	16-QAM	23.21	23.24	21.84
15	1	37		23.01	23.10	23.50
15	1	74		22.29	22.88	22.53
15	36	0		22.03	21.94	22.37
15	36	20		22.02	21.95	22.50
15	36	39		21.94	21.89	22.43
15	75	0		22.01	21.92	22.46
15	1	0	64-QAM	22.32	22.23	20.85
15	1	37		22.13	22.07	22.50
15	1	74		21.34	21.95	21.64
15	36	0		21.04	20.93	21.38
15	36	20		21.06	20.96	21.49
15	36	39		20.97	20.90	21.44
15	75	0		21.00	20.89	21.46



LTE Band 2 Maximum Average Power [dBm]						
BW [MHz]	RB Size	RB Offset	Mod	Lowest	Middle	Highest
10	1	0	QPSK	23.91	23.85	24.03
10	1	25		23.82	23.79	24.43
10	1	49		23.19	23.77	23.24
10	25	0		22.93	22.86	23.46
10	25	12		22.93	22.85	23.50
10	25	25		22.86	22.82	23.45
10	50	0		22.90	22.80	23.44
10	1	0	16-QAM	23.09	23.15	23.28
10	1	25		22.86	22.97	23.50
10	1	49		22.64	22.78	22.59
10	25	0		21.92	21.83	22.47
10	25	12		21.93	21.85	22.48
10	25	25		21.82	21.77	22.43
10	50	0		21.88	21.81	22.46
10	1	0	64-QAM	22.14	22.13	22.28
10	1	25		22.08	22.04	22.50
10	1	49		21.88	21.88	21.75
10	25	0		20.91	20.91	21.48
10	25	12		20.91	20.93	21.48
10	25	25		20.83	20.87	21.40
10	50	0		20.91	20.94	21.47
5	1	0	QPSK	23.91	23.77	24.43
5	1	12		23.87	23.81	24.16
5	1	24		23.81	23.71	23.34
5	12	0		22.89	22.81	23.44
5	12	7		22.90	22.82	23.47
5	12	13		22.85	22.79	23.42
5	25	0		22.88	22.83	23.46
5	1	0	16-QAM	22.99	23.03	23.49
5	1	12		23.02	23.01	23.45
5	1	24		22.80	22.85	22.69
5	12	0		21.90	21.83	22.44
5	12	7		21.91	21.83	22.47
5	12	13		21.88	21.78	22.40
5	25	0		21.88	21.80	22.43
5	1	0	64-QAM	22.11	22.01	22.44
5	1	12		22.01	21.97	22.49
5	1	24		21.97	21.92	21.89
5	12	0		20.93	20.83	21.46
5	12	7		20.96	20.85	21.50
5	12	13		20.91	20.88	21.46
5	25	0		20.87	20.89	21.41



LTE Band 2 Maximum Average Power [dBm]						
BW [MHz]	RB Size	RB Offset	Mod	Lowest	Middle	Highest
3	1	0	QPSK	23.84	23.77	24.33
3	1	8		23.85	23.76	23.67
3	1	14		23.78	23.69	23.16
3	8	0		22.90	22.82	23.46
3	8	4		22.93	22.85	23.49
3	8	7		22.89	22.81	23.39
3	15	0		22.87	22.80	23.41
3	1	0	16-QAM	22.97	22.98	23.43
3	1	8		22.96	22.97	22.94
3	1	14		22.85	22.87	22.48
3	8	0		21.96	21.86	22.49
3	8	4		21.95	21.88	22.50
3	8	7		21.92	21.84	22.48
3	15	0		21.92	21.84	22.45
3	1	0	64-QAM	22.06	21.92	22.50
3	1	8		22.05	21.97	22.12
3	1	14		21.99	21.91	21.66
3	8	0		20.90	20.80	21.43
3	8	4		20.94	20.83	21.48
3	8	7		20.88	20.81	21.44
3	15	0		20.90	20.90	21.45
1.4	1	0	QPSK	23.72	23.66	23.68
1.4	1	3		23.82	23.72	23.38
1.4	1	5		23.76	23.67	23.12
1.4	3	0		23.86	23.74	23.44
1.4	3	1		23.94	23.83	23.35
1.4	3	3		23.90	23.79	23.12
1.4	6	0		22.83	22.74	23.25
1.4	1	0	16-QAM	22.93	22.90	22.85
1.4	1	3		23.02	22.95	22.63
1.4	1	5		22.94	22.91	22.42
1.4	3	0		22.83	22.86	22.61
1.4	3	1		22.85	22.84	22.55
1.4	3	3		22.80	22.86	22.34
1.4	6	0		21.91	21.87	22.41
1.4	1	0	64-QAM	22.10	21.99	21.99
1.4	1	3		22.10	22.06	21.76
1.4	1	5		22.05	22.01	21.57
1.4	3	0		21.95	21.97	21.92
1.4	3	1		22.01	22.04	21.88
1.4	3	3		21.94	21.96	21.66
1.4	6	0		20.84	20.82	21.30



LTE Band 25 Maximum Average Power [dBm]						
BW [MHz]	RB Size	RB Offset	Mod	Lowest	Middle	Highest
20	1	0	QPSK	23.61	23.51	22.06
20	1	49		23.33	23.61	23.84
20	1	99		22.65	22.81	21.62
20	50	0		22.64	22.58	22.77
20	50	24		22.62	22.58	22.90
20	50	50		22.53	22.62	22.85
20	100	0		22.56	22.65	22.83
20	1	0	16-QAM	22.84	22.87	21.38
20	1	49		22.67	22.90	23.00
20	1	99		22.11	22.21	21.00
20	50	0		21.64	21.61	21.81
20	50	24		21.62	21.57	21.89
20	50	50		21.53	21.60	21.78
20	100	0		21.59	21.61	21.81
20	1	0	64-QAM	21.83	21.75	20.39
20	1	49		21.79	21.86	22.00
20	1	99		21.17	21.37	19.90
20	50	0		20.63	20.55	20.75
20	50	24		20.63	20.55	20.87
20	50	50		20.51	20.59	20.83
20	100	0		20.60	20.61	20.85
15	1	0	QPSK	23.57	23.54	23.61
15	1	37		23.47	23.56	23.75
15	1	74		22.60	23.42	22.00
15	36	0		22.65	22.55	22.86
15	36	20		22.65	22.68	22.90
15	36	39		22.56	22.61	22.63
15	75	0		22.62	22.67	22.87
15	1	0	16-QAM	22.89	22.86	22.90
15	1	37		22.70	22.89	23.00
15	1	74		22.03	22.68	21.29
15	36	0		21.65	21.58	21.88
15	36	20		21.64	21.68	21.87
15	36	39		21.56	21.60	21.88
15	75	0		21.63	21.60	21.84
15	1	0	64-QAM	21.92	21.85	21.88
15	1	37		21.77	21.84	22.00
15	1	74		21.12	21.73	20.23
15	36	0		20.65	20.53	20.85
15	36	20		20.67	20.67	20.89
15	36	39		20.59	20.61	20.94
15	75	0		20.60	20.59	20.81



LTE Band 25 Maximum Average Power [dBm]						
BW [MHz]	RB Size	RB Offset	Mod	Lowest	Middle	Highest
10	1	0	QPSK	23.77	23.58	23.87
10	1	25		23.70	23.63	22.86
10	1	49		23.44	23.53	22.43
10	25	0		22.76	22.56	22.89
10	25	12		22.77	22.68	22.88
10	25	25		22.70	22.65	22.22
10	50	0		22.71	22.65	22.86
10	1	0	16-QAM	22.99	22.91	23.00
10	1	25		22.85	22.90	22.19
10	1	49		22.72	22.71	21.68
10	25	0		21.73	21.52	21.84
10	25	12		21.74	21.67	21.85
10	25	25		21.66	21.59	21.46
10	50	0		21.70	21.65	21.82
10	1	0	64-QAM	22.00	21.78	22.00
10	1	25		21.86	21.90	21.29
10	1	49		21.82	21.73	20.61
10	25	0		20.74	20.52	20.83
10	25	12		20.72	20.64	20.84
10	25	25		20.66	20.59	20.64
10	50	0		20.73	20.73	20.83
5	1	0	QPSK	23.68	23.51	23.03
5	1	12		23.72	23.63	22.05
5	1	24		23.63	23.58	22.82
5	12	0		22.74	22.53	22.45
5	12	7		22.75	22.68	22.09
5	12	13		22.70	22.61	22.28
5	25	0		22.73	22.64	22.23
5	1	0	16-QAM	22.90	22.83	22.19
5	1	12		22.89	22.93	21.33
5	1	24		22.73	22.80	22.03
5	12	0		21.73	21.55	21.61
5	12	7		21.76	21.68	21.27
5	12	13		21.70	21.62	21.40
5	25	0		21.71	21.61	21.44
5	1	0	64-QAM	21.93	21.71	21.29
5	1	12		21.90	21.87	20.36
5	1	24		21.87	21.74	20.98
5	12	0		20.73	20.50	20.82
5	12	7		20.79	20.67	20.45
5	12	13		20.70	20.68	20.52
5	25	0		20.67	20.60	20.61



LTE Band 25 Maximum Average Power [dBm]						
BW [MHz]	RB Size	RB Offset	Mod	Lowest	Middle	Highest
3	1	0	QPSK	23.61	23.47	22.23
3	1	8		23.70	23.61	22.14
3	1	14		23.63	23.53	22.69
3	8	0		22.76	22.55	22.06
3	8	4		22.76	22.67	22.15
3	8	7		22.73	22.63	22.38
3	15	0		22.72	22.61	22.15
3	1	0	16-QAM	22.90	22.82	21.41
3	1	8		22.90	22.88	21.37
3	1	14		22.79	22.81	21.90
3	8	0		21.79	21.58	21.21
3	8	4		21.80	21.72	21.29
3	8	7		21.74	21.67	21.47
3	15	0		21.75	21.64	21.30
3	1	0	64-QAM	21.83	21.68	20.46
3	1	8		21.90	21.84	20.34
3	1	14		21.83	21.74	20.87
3	8	0		20.71	20.51	20.34
3	8	4		20.74	20.68	20.37
3	8	7		20.71	20.61	20.52
3	15	0		20.69	20.63	20.40
1.4	1	0	QPSK	23.59	23.40	22.25
1.4	1	3		23.61	23.57	22.51
1.4	1	5		23.58	23.51	22.57
1.4	3	0		23.69	23.48	22.27
1.4	3	1		23.70	23.65	22.37
1.4	3	3		23.69	23.58	22.47
1.4	6	0		22.64	22.54	22.35
1.4	1	0	16-QAM	22.84	22.71	21.41
1.4	1	3		22.89	22.88	21.69
1.4	1	5		22.82	22.77	21.79
1.4	3	0		22.67	22.52	21.29
1.4	3	1		22.71	22.67	21.40
1.4	3	3		22.64	22.59	21.50
1.4	6	0		21.73	21.65	21.46
1.4	1	0	64-QAM	21.84	21.67	20.35
1.4	1	3		21.89	21.80	20.61
1.4	1	5		21.80	21.75	20.71
1.4	3	0		21.80	21.64	20.44
1.4	3	1		21.81	21.77	20.55
1.4	3	3		21.79	21.71	20.65
1.4	6	0		20.64	20.58	20.44



LTE Band 4 Maximum Average Power [dBm]						
BW [MHz]	RB Size	RB Offset	Mod	Lowest	Middle	Highest
20	1	0	QPSK	24.15	24.39	24.44
20	1	49		24.17	24.33	24.42
20	1	99		24.31	24.19	23.96
20	50	0		23.27	23.46	23.50
20	50	24		23.36	23.43	23.49
20	50	50		23.38	23.42	23.44
20	100	0		23.32	23.49	23.41
20	1	0	16-QAM	23.11	23.36	23.43
20	1	49		23.18	23.41	23.33
20	1	99		23.35	23.18	23.20
20	50	0		22.19	22.35	22.40
20	50	24		22.25	22.44	22.50
20	50	50		22.27	22.33	22.41
20	100	0		22.23	22.39	22.47
20	1	0	64-QAM	22.24	22.48	22.42
20	1	49		22.36	22.46	22.43
20	1	99		22.42	22.38	22.33
20	50	0		21.19	21.37	21.42
20	50	24		21.28	21.44	21.41
20	50	50		21.30	21.36	21.43
20	100	0		21.26	21.36	21.48
15	1	0	QPSK	24.08	24.26	24.32
15	1	37		24.10	24.32	24.33
15	1	74		24.13	24.17	24.13
15	36	0		23.28	23.43	23.41
15	36	20		23.29	23.50	23.39
15	36	39		23.31	23.46	23.41
15	75	0		23.27	23.50	23.44
15	1	0	16-QAM	23.23	23.48	23.45
15	1	37		23.17	23.35	23.44
15	1	74		23.37	23.31	23.38
15	36	0		22.28	22.41	22.48
15	36	20		22.29	22.34	22.47
15	36	39		22.31	22.45	22.49
15	75	0		22.27	22.34	22.45
15	1	0	64-QAM	22.29	22.35	22.47
15	1	37		22.35	22.45	22.36
15	1	74		22.50	22.40	22.49
15	36	0		21.30	21.37	21.43
15	36	20		21.32	21.36	21.44
15	36	39		21.34	21.47	21.34
15	75	0		21.23	21.47	21.35



LTE Band 4 Maximum Average Power [dBm]						
BW [MHz]	RB Size	RB Offset	Mod	Lowest	Middle	Highest
10	1	0	QPSK	24.22	24.42	24.41
10	1	25		24.24	24.37	24.40
10	1	49		24.25	24.41	24.32
10	25	0		23.32	23.44	23.46
10	25	12		23.32	23.41	23.45
10	25	25		23.26	23.45	23.50
10	50	0		23.26	23.48	23.43
10	1	0	16-QAM	23.27	23.50	23.50
10	1	25		23.29	23.44	23.39
10	1	49		23.34	23.47	23.42
10	25	0		22.29	22.42	22.46
10	25	12		22.35	22.50	22.41
10	25	25		22.24	22.44	22.49
10	50	0		22.27	22.48	22.42
10	1	0	64-QAM	22.37	22.38	22.50
10	1	25		22.32	22.42	22.45
10	1	49		22.46	22.30	22.42
10	25	0		21.32	21.31	21.36
10	25	12		21.32	21.30	21.34
10	25	25		21.24	21.25	21.27
10	50	0		21.32	21.29	21.35
5	1	0	QPSK	24.08	24.41	24.40
5	1	12		24.15	24.35	24.42
5	1	24		24.08	24.33	24.39
5	12	0		23.19	23.50	23.43
5	12	7		23.22	23.49	23.45
5	12	13		23.23	23.46	23.46
5	25	0		23.17	23.49	23.49
5	1	0	16-QAM	23.16	23.49	23.43
5	1	12		23.23	23.44	23.31
5	1	24		23.15	23.50	23.38
5	12	0		22.19	22.50	22.49
5	12	7		22.20	22.41	22.45
5	12	13		22.27	22.45	22.49
5	25	0		22.17	22.46	22.49
5	1	0	64-QAM	22.25	22.44	22.49
5	1	12		22.30	22.39	22.48
5	1	24		22.24	22.31	22.45
5	12	0		21.19	21.33	21.45
5	12	7		21.25	21.35	21.41
5	12	13		21.29	21.47	21.35
5	25	0		21.18	21.47	21.50



LTE Band 4 Maximum Average Power [dBm]						
BW [MHz]	RB Size	RB Offset	Mod	Lowest	Middle	Highest
3	1	0	QPSK	24.26	24.33	24.33
3	1	8		24.01	24.38	24.36
3	1	14		24.01	24.38	24.37
3	8	0		23.23	23.41	23.43
3	8	4		23.22	23.43	23.44
3	8	7		23.18	23.38	23.39
3	15	0		23.17	23.39	23.35
3	1	0	16-QAM	23.16	23.42	23.34
3	1	8		23.25	23.49	23.42
3	1	14		23.19	23.41	23.28
3	8	0		22.26	22.44	22.43
3	8	4		22.25	22.44	22.44
3	8	7		22.21	22.39	22.41
3	15	0		22.23	22.40	22.41
3	1	0	64-QAM	22.24	22.47	22.46
3	1	8		22.31	22.41	22.48
3	1	14		22.30	22.41	22.44
3	8	0		21.21	21.40	21.44
3	8	4		21.24	21.44	21.46
3	8	7		21.21	21.39	21.40
3	15	0		21.18	21.40	21.38
1.4	1	0	QPSK	24.14	24.33	24.32
1.4	1	3		24.18	24.36	24.31
1.4	1	5		24.14	24.26	24.29
1.4	3	0		24.27	24.34	24.34
1.4	3	1		24.32	24.35	24.40
1.4	3	3		24.21	24.42	24.35
1.4	6	0		23.23	23.42	23.43
1.4	1	0	16-QAM	23.23	23.43	23.46
1.4	1	3		23.32	23.43	23.45
1.4	1	5		23.25	23.46	23.36
1.4	3	0		23.18	23.40	23.35
1.4	3	1		23.23	23.44	23.40
1.4	3	3		23.15	23.32	23.31
1.4	6	0		22.29	22.50	22.49
1.4	1	0	64-QAM	22.43	22.41	22.43
1.4	1	3		22.27	22.37	22.37
1.4	1	5		22.30	22.43	22.32
1.4	3	0		22.20	22.49	22.44
1.4	3	1		22.22	22.31	22.43
1.4	3	3		22.18	22.48	22.43
1.4	6	0		21.12	21.41	21.40



LTE Band 5 Maximum Average Power [dBm]						
BW [MHz]	RB Size	RB Offset	Mod	Lowest	Middle	Highest
10	1	0	QPSK	24.24	24.39	24.27
10	1	25		24.30	24.24	24.19
10	1	49		24.35	24.30	24.19
10	25	0		23.23	23.37	23.32
10	25	12		23.32	23.36	23.33
10	25	25		23.26	23.31	23.24
10	50	0		23.29	23.35	23.26
10	1	0	16-QAM	23.41	23.47	23.48
10	1	25		23.44	23.46	23.37
10	1	49		23.48	23.36	23.22
10	25	0		22.21	22.34	22.30
10	25	12		22.31	22.33	22.33
10	25	25		22.25	22.28	22.22
10	50	0		22.30	22.33	22.26
10	1	0	64-QAM	22.46	22.49	22.43
10	1	25		22.43	22.45	22.39
10	1	49		22.44	22.36	22.31
10	25	0		21.22	21.33	21.27
10	25	12		21.32	21.36	21.28
10	25	25		21.22	21.27	21.20
10	50	0		21.31	21.33	21.26
5	1	0	QPSK	24.37	24.34	24.27
5	1	12		24.28	24.33	24.20
5	1	24		24.33	24.30	24.20
5	12	0		23.31	23.42	23.34
5	12	7		23.33	23.47	23.36
5	12	13		23.41	23.39	23.32
5	25	0		23.29	23.40	23.33
5	1	0	16-QAM	23.36	23.50	23.30
5	1	12		23.33	23.48	23.33
5	1	24		23.40	23.44	23.24
5	12	0		22.15	22.30	22.18
5	12	7		22.19	22.32	22.21
5	12	13		22.24	22.28	22.16
5	25	0		22.12	22.25	22.17
5	1	0	64-QAM	22.34	22.47	22.37
5	1	12		22.36	22.47	22.29
5	1	24		22.37	22.37	22.32
5	12	0		21.21	21.34	21.22
5	12	7		21.20	21.31	21.24
5	12	13		21.24	21.27	21.17
5	25	0		21.12	21.25	21.15



LTE Band 5 Maximum Average Power [dBm]						
BW [MHz]	RB Size	RB Offset	Mod	Lowest	Middle	Highest
3	1	0	QPSK	24.36	24.30	24.33
3	1	8		24.38	24.34	24.31
3	1	14		24.30	24.29	24.30
3	8	0		23.40	23.48	23.42
3	8	4		23.43	23.50	23.45
3	8	7		23.38	23.48	23.39
3	15	0		23.37	23.48	23.38
3	1	0	16-QAM	23.32	23.49	23.19
3	1	8		23.29	23.47	23.20
3	1	14		23.25	23.41	23.09
3	8	0		22.18	22.29	22.20
3	8	4		22.21	22.31	22.22
3	8	7		22.17	22.26	22.18
3	15	0		22.15	22.25	22.17
3	1	0	64-QAM	22.29	22.40	22.26
3	1	8		22.35	22.45	22.29
3	1	14		22.28	22.44	22.31
3	8	0		21.18	21.29	21.22
3	8	4		21.22	21.32	21.25
3	8	7		21.19	21.27	21.17
3	15	0		21.18	21.26	21.20
1.4	1	0	QPSK	24.06	24.17	24.04
1.4	1	3		24.12	24.23	24.06
1.4	1	5		24.05	24.16	24.04
1.4	3	0		24.17	24.27	24.16
1.4	3	1		24.26	24.28	24.22
1.4	3	3		24.18	24.26	24.16
1.4	6	0		23.13	23.22	23.11
1.4	1	0	16-QAM	23.31	23.46	23.20
1.4	1	3		23.35	23.42	23.24
1.4	1	5		23.30	23.42	23.13
1.4	3	0		23.15	23.28	23.11
1.4	3	1		23.19	23.29	23.15
1.4	3	3		23.15	23.24	23.10
1.4	6	0		22.20	22.31	22.20
1.4	1	0	64-QAM	22.31	22.39	22.35
1.4	1	3		22.35	22.43	22.38
1.4	1	5		22.29	22.40	22.38
1.4	3	0		22.28	22.39	22.23
1.4	3	1		22.30	22.41	22.27
1.4	3	3		22.26	22.36	22.21
1.4	6	0		21.12	21.24	21.12



LTE Band 7 Maximum Average Power [dBm]						
BW [MHz]	RB Size	RB Offset	Mod	Lowest	Middle	Highest
20	1	0	QPSK	24.27	24.22	24.50
20	1	49		24.35	24.38	24.41
20	1	99		24.30	24.49	24.45
20	50	0		23.27	23.47	23.48
20	50	24		23.40	23.48	23.50
20	50	50		23.37	23.47	23.49
20	100	0		23.40	23.43	23.50
20	1	0	16-QAM	23.43	23.49	23.49
20	1	49		23.40	23.46	23.48
20	1	99		23.38	23.40	23.47
20	50	0		22.29	22.42	22.50
20	50	24		22.39	22.47	22.49
20	50	50		22.43	22.48	22.50
20	100	0		22.37	22.44	22.47
20	1	0	64-QAM	22.31	22.37	22.43
20	1	49		22.45	22.46	22.48
20	1	99		22.46	22.50	22.50
20	50	0		21.27	21.42	21.50
20	50	24		21.39	21.49	21.49
20	50	50		21.42	21.46	21.48
20	100	0		21.37	21.46	21.45
15	1	0	QPSK	24.26	24.46	24.49
15	1	37		24.31	24.40	24.48
15	1	74		24.21	24.34	24.49
15	36	0		23.39	23.44	23.45
15	36	20		23.46	23.47	23.48
15	36	39		23.22	23.31	23.46
15	75	0		23.13	23.28	23.44
15	1	0	16-QAM	23.17	23.36	23.48
15	1	37		23.23	23.27	23.36
15	1	74		23.43	23.50	23.50
15	36	0		22.38	22.47	22.50
15	36	20		22.43	22.46	22.47
15	36	39		22.24	22.38	22.41
15	75	0		22.39	22.39	22.45
15	1	0	64-QAM	22.14	22.27	22.32
15	1	37		22.23	22.35	22.46
15	1	74		22.19	22.18	22.30
15	36	0		21.42	21.47	21.50
15	36	20		21.43	21.45	21.49
15	36	39		21.26	21.36	21.48
15	75	0		21.41	21.44	21.50



LTE Band 7 Maximum Average Power [dBm]						
BW [MHz]	RB Size	RB Offset	Mod	Lowest	Middle	Highest
10	1	0	QPSK	24.39	24.43	24.46
10	1	25		24.39	24.39	24.44
10	1	49		24.33	24.36	24.47
10	25	0		23.40	23.42	23.48
10	25	12		23.43	23.41	23.43
10	25	25		23.42	23.45	23.46
10	50	0		23.12	23.27	23.48
10	1	0	16-QAM	23.15	23.25	23.33
10	1	25		23.24	23.33	23.39
10	1	49		23.21	23.36	23.40
10	25	0		22.38	22.23	22.47
10	25	12		22.41	22.40	22.46
10	25	25		22.40	22.37	22.50
10	50	0		22.42	22.47	22.50
10	1	0	64-QAM	22.06	22.36	22.49
10	1	25		22.21	22.34	22.50
10	1	49		22.06	22.29	22.48
10	25	0		21.37	21.39	21.47
10	25	12		21.41	21.47	21.50
10	25	25		21.43	21.44	21.49
10	50	0		21.39	21.33	21.46
5	1	0	QPSK	24.38	24.39	24.44
5	1	12		24.40	24.44	24.48
5	1	24		24.42	24.46	24.39
5	12	0		23.39	23.38	23.47
5	12	7		23.43	23.48	23.50
5	12	13		23.43	23.46	23.50
5	25	0		23.39	23.45	23.47
5	1	0	16-QAM	23.29	23.47	23.50
5	1	12		23.25	23.44	23.50
5	1	24		23.17	23.39	23.44
5	12	0		22.40	22.45	22.47
5	12	7		22.45	22.46	22.49
5	12	13		22.46	22.48	22.50
5	25	0		22.40	22.43	22.49
5	1	0	64-QAM	22.16	22.29	22.43
5	1	12		22.22	22.39	22.46
5	1	24		22.09	22.21	22.45
5	12	0		21.45	21.47	21.50
5	12	7		21.30	21.41	21.44
5	12	13		21.26	21.39	21.44
5	25	0		21.22	21.35	21.47



LTE Band 12 Maximum Average Power [dBm]						
BW [MHz]	RB Size	RB Offset	Mod	Lowest	Middle	Highest
10	1	0	QPSK	24.13	24.34	24.22
10	1	25		24.22	24.33	24.21
10	1	49		24.25	24.21	24.29
10	25	0		23.21	23.20	23.29
10	25	12		23.26	23.34	23.30
10	25	25		23.34	23.30	23.39
10	50	0		23.30	23.30	23.24
10	1	0	16-QAM	23.29	23.36	23.32
10	1	25		23.35	23.42	23.48
10	1	49		23.47	23.47	23.46
10	25	0		22.21	22.18	22.25
10	25	12		22.23	22.33	22.26
10	25	25		22.29	22.25	22.35
10	50	0		22.32	22.26	22.23
10	1	0	64-QAM	22.27	22.35	22.41
10	1	25		22.42	22.44	22.40
10	1	49		22.42	22.42	22.45
10	25	0		21.21	21.18	21.23
10	25	12		21.25	21.33	21.28
10	25	25		21.30	21.29	21.38
10	50	0		21.31	21.30	21.26
5	1	0	QPSK	24.07	24.07	24.23
5	1	12		24.24	24.21	24.30
5	1	24		24.22	24.23	24.26
5	12	0		23.17	23.22	23.37
5	12	7		23.30	23.25	23.40
5	12	13		23.28	23.23	23.35
5	25	0		23.25	23.23	23.40
5	1	0	16-QAM	23.35	23.28	23.46
5	1	12		23.48	23.40	23.33
5	1	24		23.44	23.42	23.46
5	12	0		22.18	22.20	22.37
5	12	7		22.33	22.25	22.41
5	12	13		22.28	22.22	22.33
5	25	0		22.25	22.21	22.38
5	1	0	64-QAM	22.32	22.25	22.40
5	1	12		22.38	22.40	22.42
5	1	24		22.39	22.37	22.40
5	12	0		21.19	21.24	21.41
5	12	7		21.31	21.27	21.45
5	12	13		21.31	21.23	21.41
5	25	0		21.27	21.20	21.38



LTE Band 12 Maximum Average Power [dBm]						
BW [MHz]	RB Size	RB Offset	Mod	Lowest	Middle	Highest
3	1	0	QPSK	24.21	24.24	24.33
3	1	8		24.24	24.28	24.31
3	1	14		24.30	24.23	24.33
3	8	0		23.26	23.31	23.44
3	8	4		23.30	23.34	23.50
3	8	7		23.25	23.28	23.48
3	15	0		23.24	23.29	23.43
3	1	0	16-QAM	23.41	23.45	23.43
3	1	8		23.43	23.44	23.42
3	1	14		23.50	23.45	23.43
3	8	0		22.29	22.34	22.47
3	8	4		22.31	22.36	22.50
3	8	7		22.28	22.33	22.42
3	15	0		22.27	22.32	22.47
3	1	0	64-QAM	22.38	22.44	22.41
3	1	8		22.41	22.44	22.48
3	1	14		22.47	22.44	22.46
3	8	0		21.27	21.32	21.45
3	8	4		21.30	21.35	21.48
3	8	7		21.27	21.30	21.47
3	15	0		21.23	21.28	21.46
1.4	1	0	QPSK	24.11	24.18	24.26
1.4	1	3		24.21	24.21	24.29
1.4	1	5		24.13	24.13	24.19
1.4	3	0		24.23	24.25	24.33
1.4	3	1		24.31	24.30	24.31
1.4	3	3		24.24	24.29	24.33
1.4	6	0		23.19	23.22	23.39
1.4	1	0	16-QAM	23.38	23.38	23.45
1.4	1	3		23.41	23.46	23.48
1.4	1	5		23.38	23.39	23.35
1.4	3	0		23.21	23.22	23.33
1.4	3	1		23.27	23.28	23.38
1.4	3	3		23.21	23.21	23.34
1.4	6	0		22.26	22.29	22.43
1.4	1	0	64-QAM	22.39	22.45	22.45
1.4	1	3		22.44	22.46	22.44
1.4	1	5		22.40	22.45	22.47
1.4	3	0		22.35	22.37	22.45
1.4	3	1		22.39	22.40	22.50
1.4	3	3		22.34	22.35	22.45
1.4	6	0		21.20	21.22	21.34



LTE Band 13 Maximum Average Power [dBm]						
BW [MHz]	RB Size	RB Offset	Mod	Lowest	Middle	Highest
10	1	0	QPSK		24.39	
10	1	25			24.36	
10	1	49			24.38	
10	25	0			23.38	
10	25	12			23.40	
10	25	25			23.48	
10	50	0			23.39	
10	1	0	16-QAM		23.45	
10	1	25			23.43	
10	1	49			23.35	
10	25	0			22.37	
10	25	12			22.40	
10	25	25			22.44	
10	50	0			22.40	
10	1	0	64-QAM		22.34	
10	1	25			22.35	
10	1	49			22.32	
10	25	0			21.16	
10	25	12			21.21	
10	25	25			21.25	
10	50	0			21.17	
5	1	0	QPSK	24.30	24.38	24.27
5	1	12		24.32	24.36	24.37
5	1	24		24.34	24.35	24.32
5	12	0		23.40	23.38	23.26
5	12	7		23.46	23.43	23.41
5	12	13		23.42	23.38	23.36
5	25	0		23.43	23.41	23.38
5	1	0	16-QAM	23.49	23.42	23.37
5	1	12		23.50	23.49	23.46
5	1	24		23.44	23.44	23.40
5	12	0		22.22	22.22	22.10
5	12	7		22.29	22.24	22.21
5	12	13		22.21	22.22	22.19
5	25	0		22.21	22.19	22.15
5	1	0	64-QAM	22.43	22.40	22.24
5	1	12		22.42	22.40	22.40
5	1	24		22.38	22.34	22.35
5	12	0		21.25	21.23	21.11
5	12	7		21.29	21.22	21.21
5	12	13		21.22	21.21	21.16
5	25	0		21.20	21.16	21.13



LTE Band 17 Maximum Average Power [dBm]						
BW [MHz]	RB Size	RB Offset	Mod	Lowest	Middle	Highest
10	1	0	QPSK	24.06	24.16	24.03
10	1	25		24.10	24.15	24.10
10	1	49		24.11	24.10	24.12
10	25	0		23.17	23.12	23.11
10	25	12		23.18	23.13	23.26
10	25	25		23.27	23.25	23.22
10	50	0		23.12	23.23	23.23
10	1	0	16-QAM	23.31	23.21	23.27
10	1	25		23.33	23.42	23.45
10	1	49		23.39	23.34	23.26
10	25	0		22.11	22.11	22.09
10	25	12		22.15	22.13	22.26
10	25	25		22.19	22.20	22.19
10	50	0		22.12	22.22	22.23
10	1	0	64-QAM	22.27	22.20	22.25
10	1	25		22.25	22.34	22.37
10	1	49		22.36	22.28	22.25
10	25	0		21.10	21.15	21.13
10	25	12		21.15	21.15	21.23
10	25	25		21.23	21.20	21.20
10	50	0		21.12	21.20	21.20
5	1	0	QPSK	24.02	24.03	24.05
5	1	12		24.05	24.15	23.99
5	1	24		24.01	24.13	24.06
5	12	0		23.07	23.05	23.11
5	12	7		23.11	23.20	23.15
5	12	13		23.08	23.15	23.12
5	25	0		23.08	23.17	23.14
5	1	0	16-QAM	23.21	23.17	23.32
5	1	12		23.21	23.37	23.32
5	1	24		23.21	23.35	23.20
5	12	0		22.07	22.03	22.14
5	12	7		22.12	22.19	22.14
5	12	13		22.08	22.16	22.09
5	25	0		22.07	22.13	22.09
5	1	0	64-QAM	22.21	22.13	22.27
5	1	12		22.22	22.29	22.23
5	1	24		22.18	22.25	22.16
5	12	0		21.10	21.07	21.14
5	12	7		21.17	21.19	21.17
5	12	13		21.11	21.17	21.15
5	25	0		21.09	21.13	21.10



LTE Band 66 Maximum Average Power [dBm]						
BW [MHz]	RB Size	RB Offset	Mod	Lowest	Middle	Highest
20	1	0	QPSK	23.73	23.94	23.79
20	1	49		23.53	23.93	23.77
20	1	99		23.73	23.82	23.60
20	50	0		22.69	22.94	22.79
20	50	24		22.77	22.97	22.75
20	50	50		22.71	22.93	22.69
20	100	0		22.74	22.98	22.74
20	1	0	16-QAM	22.68	22.98	22.91
20	1	49		22.74	22.92	22.82
20	1	99		22.71	22.82	22.59
20	50	0		21.52	21.74	21.61
20	50	24		21.56	21.79	21.55
20	50	50		21.49	21.73	21.49
20	100	0		21.56	21.80	21.55
20	1	0	64-QAM	21.77	21.99	21.90
20	1	49		21.89	21.91	21.96
20	1	99		21.75	21.86	21.75
20	50	0		20.52	20.72	20.60
20	50	24		20.57	20.81	20.57
20	50	50		20.52	20.74	20.49
20	100	0		20.56	20.80	20.54
15	1	0	QPSK	23.66	23.93	23.78
15	1	37		23.65	23.92	23.79
15	1	74		23.61	23.82	23.55
15	36	0		22.65	22.96	22.73
15	36	20		22.73	22.97	22.80
15	36	39		22.68	22.89	22.64
15	75	0		22.64	22.96	22.73
15	1	0	16-QAM	22.67	22.98	22.86
15	1	37		22.71	22.94	22.77
15	1	74		22.62	22.86	22.60
15	36	0		21.44	21.77	21.52
15	36	20		21.54	21.84	21.59
15	36	39		21.49	21.70	21.44
15	75	0		21.45	21.77	21.50
15	1	0	64-QAM	21.69	21.92	21.91
15	1	37		21.73	21.95	21.89
15	1	74		21.68	21.88	21.64
15	36	0		20.47	20.80	20.56
15	36	20		20.54	20.87	20.62
15	36	39		20.50	20.73	20.48
15	75	0		20.44	20.76	20.48



LTE Band 66 Maximum Average Power [dBm]						
BW [MHz]	RB Size	RB Offset	Mod	Lowest	Middle	Highest
10	1	0	QPSK	23.43	23.72	23.71
10	1	25		23.41	23.76	23.55
10	1	49		23.33	23.76	23.51
10	25	0		22.50	22.82	22.54
10	25	12		22.46	22.79	22.51
10	25	25		22.45	22.73	22.46
10	50	0		22.47	22.76	22.50
10	1	0	16-QAM	22.71	22.85	22.66
10	1	25		22.59	22.84	22.70
10	1	49		22.53	22.82	22.56
10	25	0		21.50	21.78	21.51
10	25	12		21.47	21.79	21.50
10	25	25		21.43	21.74	21.43
10	50	0		21.49	21.77	21.50
10	1	0	64-QAM	21.68	21.99	21.86
10	1	25		21.68	21.97	21.82
10	1	49		21.60	21.89	21.63
10	25	0		20.50	20.79	20.53
10	25	12		20.68	20.98	20.71
10	25	25		20.65	20.94	20.64
10	50	0		20.71	21.00	20.73
5	1	0	QPSK	23.55	23.73	23.60
5	1	12		23.67	23.87	23.72
5	1	24		23.50	23.60	23.51
5	12	0		22.65	22.84	22.66
5	12	7		22.72	22.91	22.74
5	12	13		22.63	22.82	22.65
5	25	0		22.65	22.85	22.66
5	1	0	16-QAM	22.68	22.75	22.68
5	1	12		22.82	22.94	22.86
5	1	24		22.60	22.67	22.63
5	12	0		21.65	21.82	21.64
5	12	7		21.76	21.93	21.76
5	12	13		21.63	21.82	21.64
5	25	0		21.66	21.82	21.64
5	1	0	64-QAM	21.70	21.85	21.84
5	1	12		21.88	21.95	21.87
5	1	24		21.65	21.85	21.73
5	12	0		20.70	20.89	20.72
5	12	7		20.78	20.97	20.77
5	12	13		20.65	20.97	20.66
5	25	0		20.64	20.93	20.64



LTE Band 66 Maximum Average Power [dBm]						
BW [MHz]	RB Size	RB Offset	Mod	Lowest	Middle	Highest
3	1	0	QPSK	23.71	23.81	23.56
3	1	8		23.70	23.82	23.73
3	1	14		23.53	23.60	23.62
3	8	0		22.72	22.94	22.73
3	8	4		22.77	22.97	22.78
3	8	7		22.68	22.90	22.71
3	15	0		22.68	22.86	22.70
3	1	0	16-QAM	22.75	22.72	22.68
3	1	8		22.83	22.95	22.86
3	1	14		22.67	22.77	22.65
3	8	0		21.78	21.95	21.78
3	8	4		21.82	21.97	21.81
3	8	7		21.71	21.92	21.73
3	15	0		21.72	21.92	21.75
3	1	0	64-QAM	21.73	21.91	21.78
3	1	8		21.88	21.94	21.82
3	1	14		21.70	21.93	21.73
3	8	0		20.73	20.93	20.73
3	8	4		20.78	21.00	20.80
3	8	7		20.70	20.92	20.69
3	15	0		20.68	20.91	20.72
1.4	1	0	QPSK	23.58	23.76	23.61
1.4	1	3		23.60	23.82	23.68
1.4	1	5		23.52	23.72	23.61
1.4	3	0		23.71	23.90	23.69
1.4	3	1		23.70	23.91	23.79
1.4	3	3		23.73	23.88	23.72
1.4	6	0		22.66	22.94	22.67
1.4	1	0	16-QAM	22.78	22.92	22.76
1.4	1	3		22.85	22.91	22.84
1.4	1	5		22.78	22.90	22.76
1.4	3	0		22.60	22.78	22.68
1.4	3	1		22.66	22.87	22.74
1.4	3	3		22.60	22.77	22.67
1.4	6	0		21.72	21.92	21.77
1.4	1	0	64-QAM	21.77	21.97	21.94
1.4	1	3		21.91	21.96	22.00
1.4	1	5		21.82	21.82	21.82
1.4	3	0		21.78	21.93	21.76
1.4	3	1		21.81	21.99	21.84
1.4	3	3		21.75	21.94	21.75
1.4	6	0		20.69	20.83	20.66



LTE Band 2

Peak-to-Average Ratio

Mode	LTE Band 2 / 20MHz				
Mod.	QPSK		16QAM		Limit: 13dB
RB Size	1RB	Full RB	1RB	Full RB	Result
Lowest CH	3.22	4.17	3.86	5.1	PASS
Middle CH	4.32	3.97	5.04	5.13	
Highest CH	4.06	4.38	4.72	5.42	
Mode	LTE Band 2 / 20MHz				
Mod.	64QAM				Limit: 13dB
RB Size	1RB	Full RB			Result
Lowest CH	4.87	5.86			PASS
Middle CH	5.54	6.32			
Highest CH	5.25	6.00			



LTE Band 2 / 20MHz / QPSK

Lowest Channel / 1RB

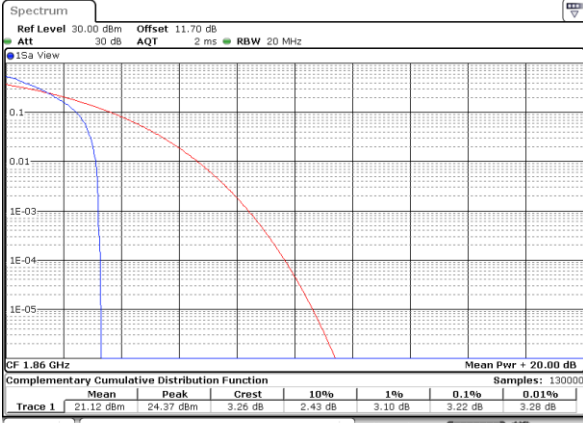

Date: 3 AUG 2017 16:14:29

Lowest Channel / Full RB

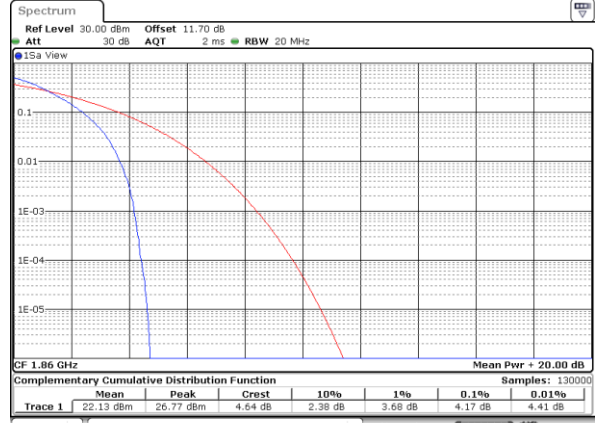

Date: 3 AUG 2017 16:16:14

Middle Channel / 1RB

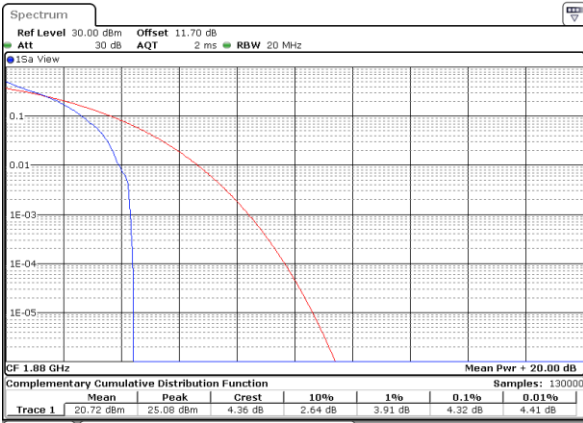

Date: 3 AUG 2017 16:16:33

Middle Channel / Full RB

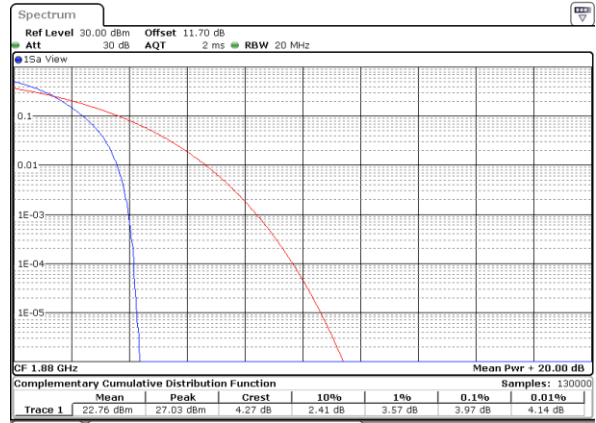

Date: 3 AUG 2017 16:17:57

Highest Channel / 1RB

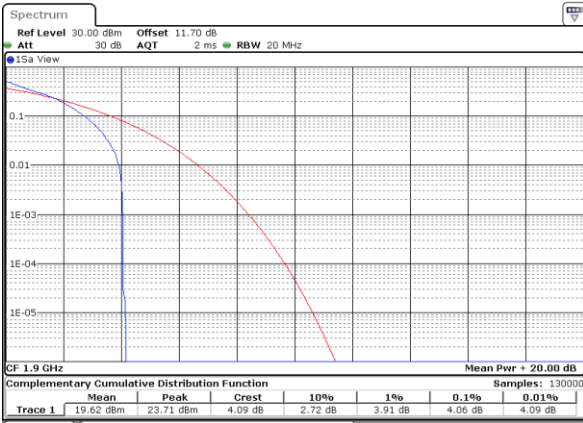

Date: 3 AUG 2017 16:18:50

Highest Channel / Full RB

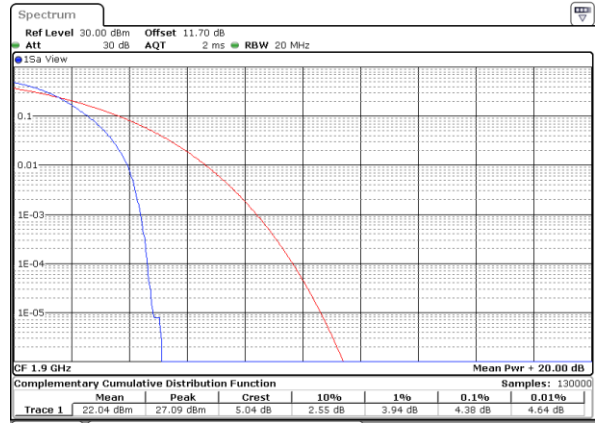

Date: 3 AUG 2017 16:18:59



LTE Band 2 / 20MHz / 16QAM

Lowest Channel / 1RB

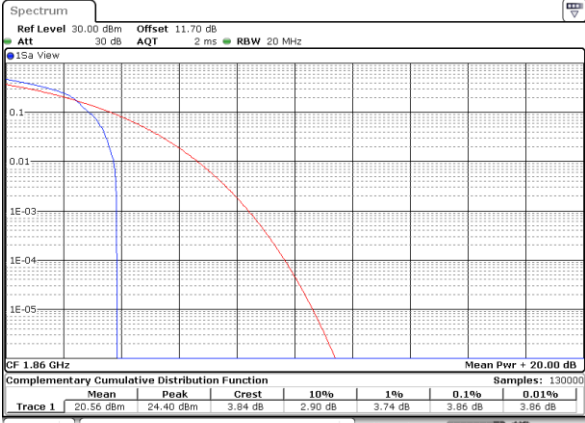

Date: 3 AUG 2017 16:12:29

Lowest Channel / Full RB

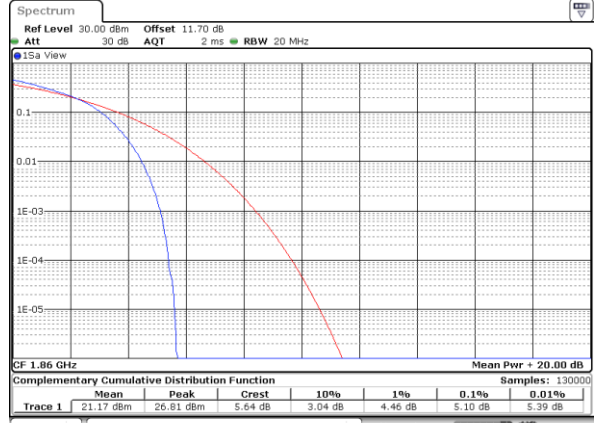

Date: 3 AUG 2017 16:12:44

Middle Channel / 1RB

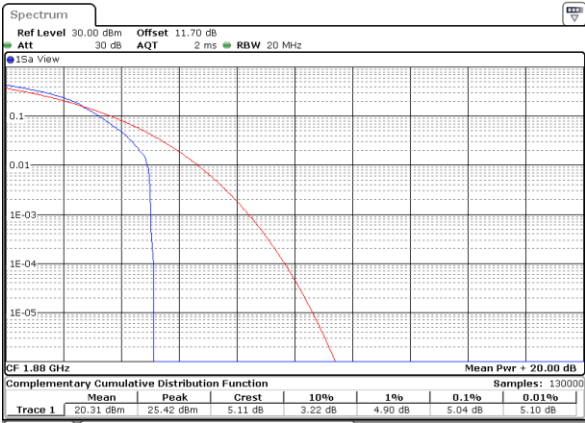

Date: 3 AUG 2017 16:12:53

Middle Channel / Full RB

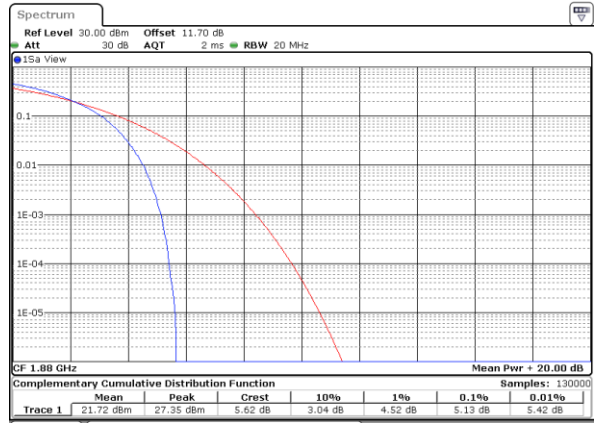

Date: 3 AUG 2017 16:13:32

Highest Channel / 1RB

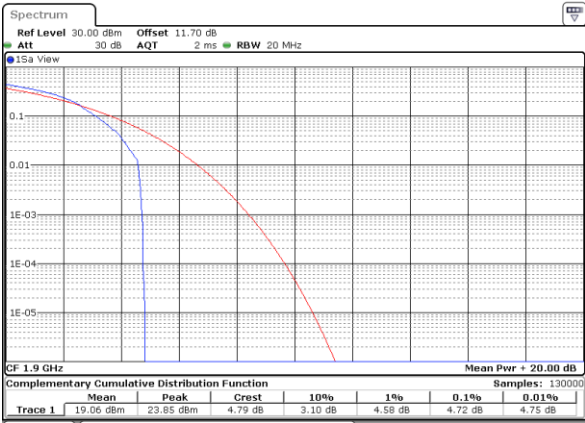

Date: 3 AUG 2017 16:13:43

Highest Channel / Full RB

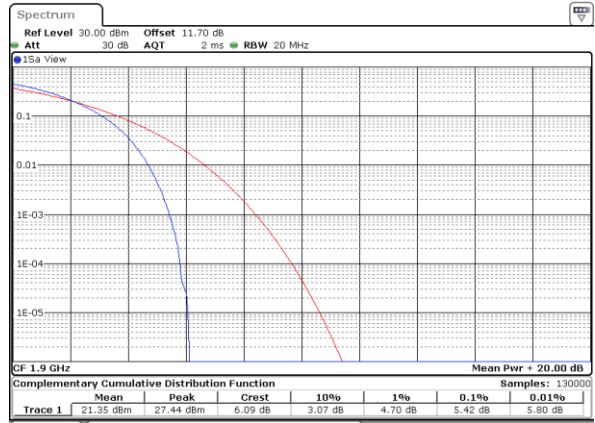

Date: 3 AUG 2017 16:14:15



LTE Band 2 / 20MHz / 64QAM

Lowest Channel / 1RB

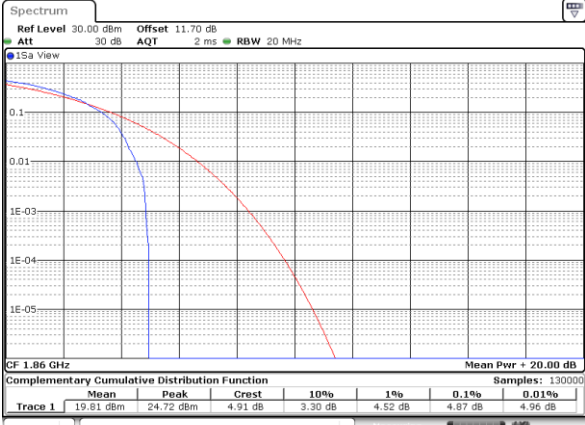

Date: 6 OCT 2017 19:51:01

Lowest Channel / Full RB

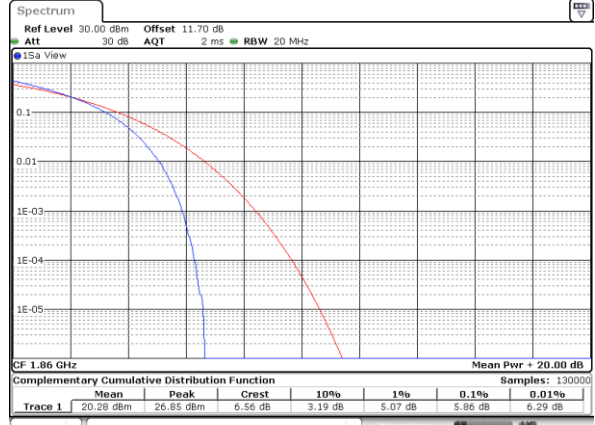

Date: 6 OCT 2017 19:51:10

Middle Channel / 1RB

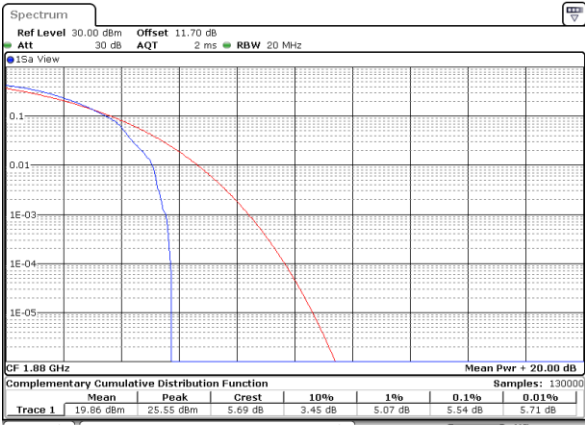

Date: 6 OCT 2017 19:51:33

Middle Channel / Full RB

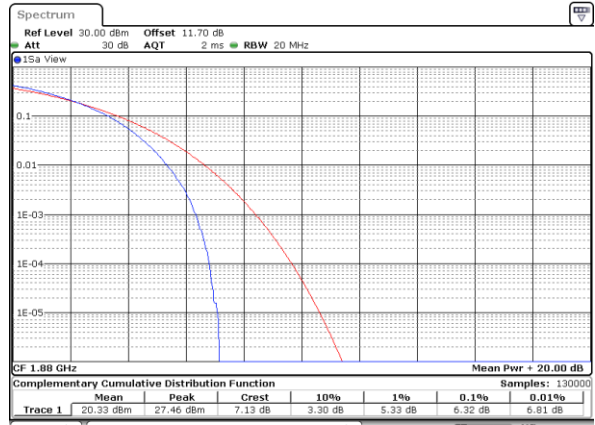

Date: 6 OCT 2017 19:51:42

Highest Channel / 1RB

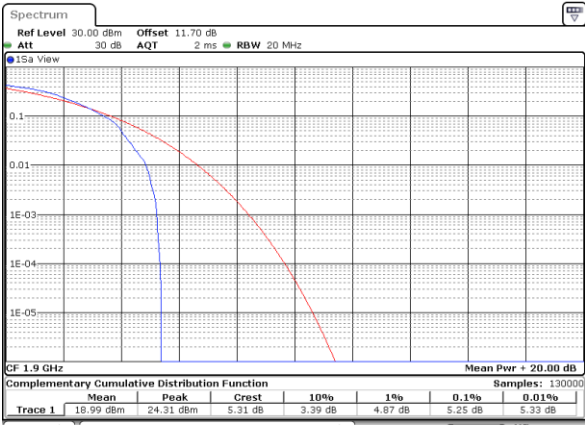

Date: 6 OCT 2017 19:51:51

Highest Channel / Full RB

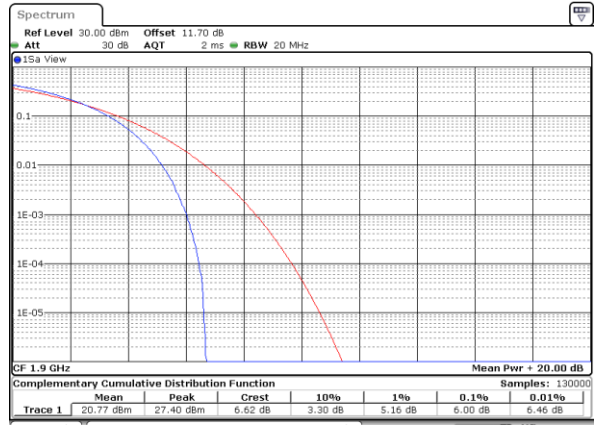

Date: 6 OCT 2017 19:52:00



26dB Bandwidth

Mode	LTE Band 2 : 26dB BW(MHz)											
BW	1.4MHz		3MHz		5MHz		10MHz		15MHz		20MHz	
Mod.	QPSK	16QAM	QPSK	16QAM	QPSK	16QAM	QPSK	16QAM	QPSK	16QAM	QPSK	16QAM
Lowest CH	1.22	1.23	2.98	2.99	4.96	4.97	9.77	9.69	14.27	14.45	20.34	20.58
Middle CH	1.23	1.23	3.01	2.98	4.93	4.93	9.83	9.79	14.33	14.54	20.38	20.06
Highest CH	1.24	1.21	3.06	3.05	4.96	4.97	9.87	9.75	14.21	14.18	20.14	20.22
Mode	LTE Band 2 : 26dB BW(MHz)											
BW	1.4MHz		3MHz		5MHz		10MHz		15MHz		20MHz	
Mod.	64QAM		64QAM		64QAM		64QAM		64QAM		64QAM	
Lowest CH	1.23	-	3.04	-	4.89	-	9.67	-	14.21	-	20.26	-
Middle CH	1.23	-	3.02	-	4.85	-	9.89	-	14.42	-	20.22	-
Highest CH	1.23	-	3	-	4.94	-	9.85	-	14.27	-	20.14	-



LTE Band 2

Lowest Channel / 1.4MHz / QPSK

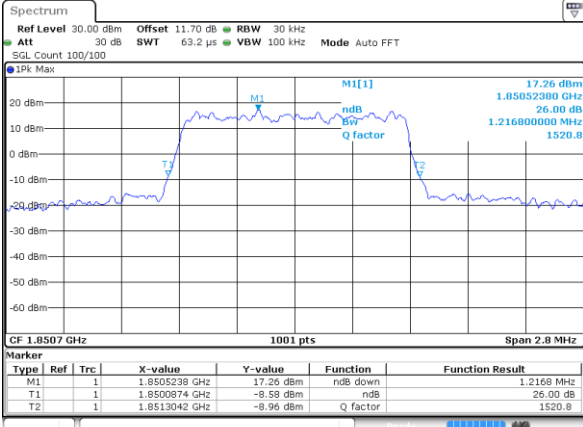

Date: 3 AUG 2017 15:56:00

Lowest Channel / 1.4MHz / 16QAM

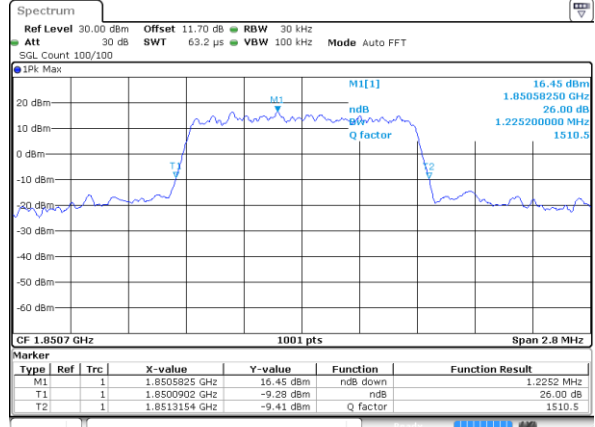

Date: 3 AUG 2017 15:56:10

Middle Channel / 1.4MHz / QPSK

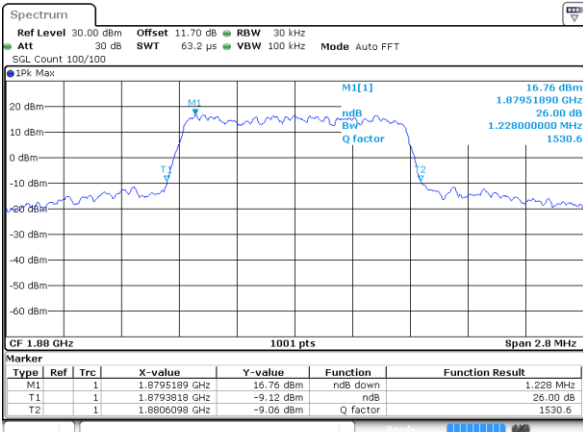

Date: 3 AUG 2017 16:03:03

Middle Channel / 1.4MHz / 16QAM

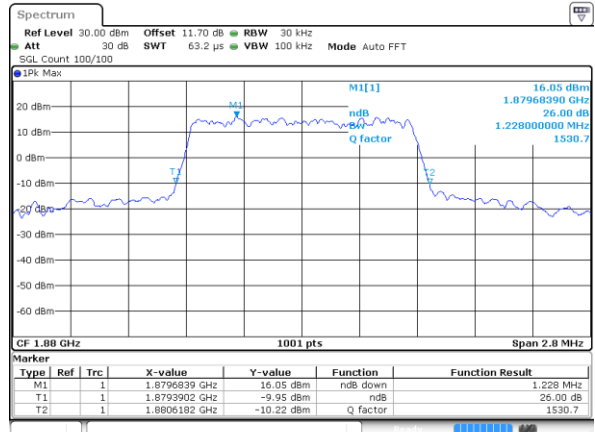

Date: 3 AUG 2017 16:03:13

Highest Channel / 1.4MHz / QPSK

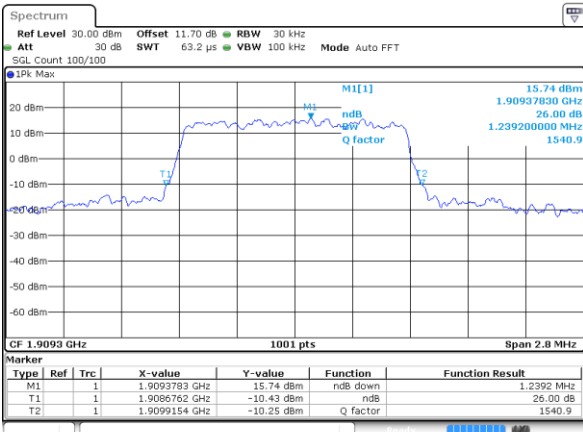

Date: 3 AUG 2017 16:05:31

Highest Channel / 1.4MHz / 16QAM

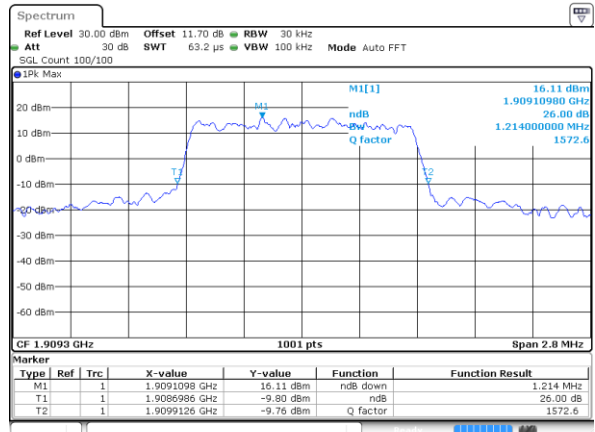

Date: 3 AUG 2017 16:05:41



LTE Band 2

Lowest Channel / 3MHz / QPSK

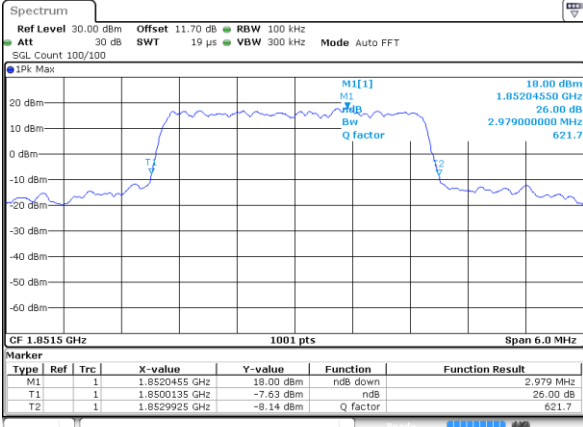

Date: 3 AUG 2017 14:21:25

Lowest Channel / 3MHz / 16QAM

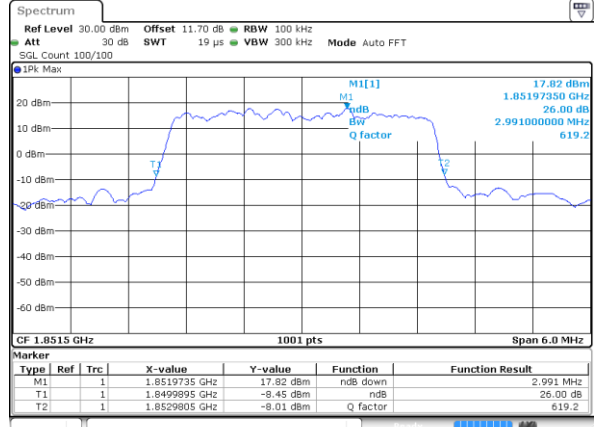

Date: 3 AUG 2017 14:21:35

Middle Channel / 3MHz / QPSK

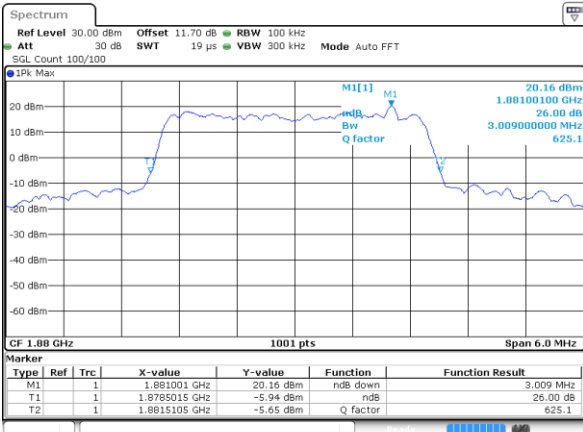

Date: 3 AUG 2017 14:28:28

Middle Channel / 3MHz / 16QAM

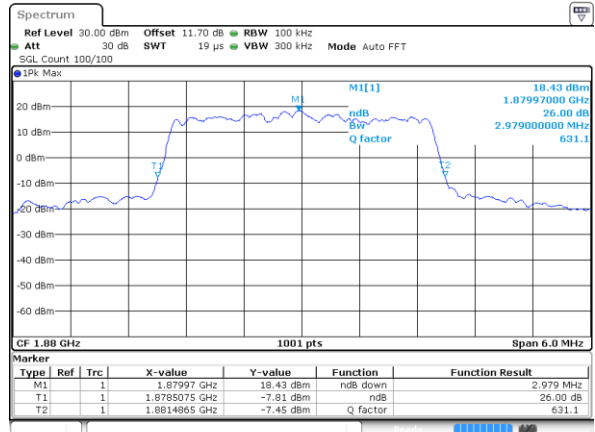

Date: 3 AUG 2017 14:28:38

Highest Channel / 3MHz / QPSK

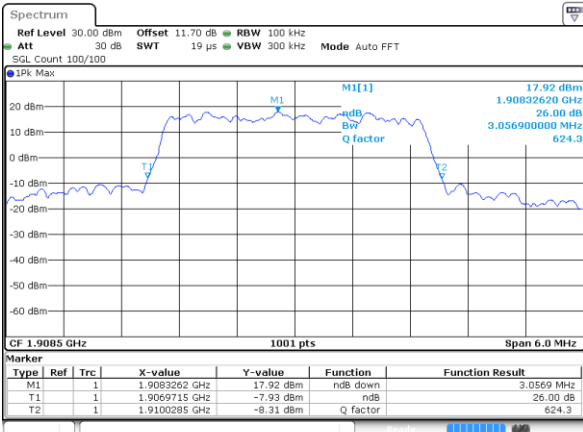

Date: 3 AUG 2017 14:30:57

Highest Channel / 3MHz / 16QAM

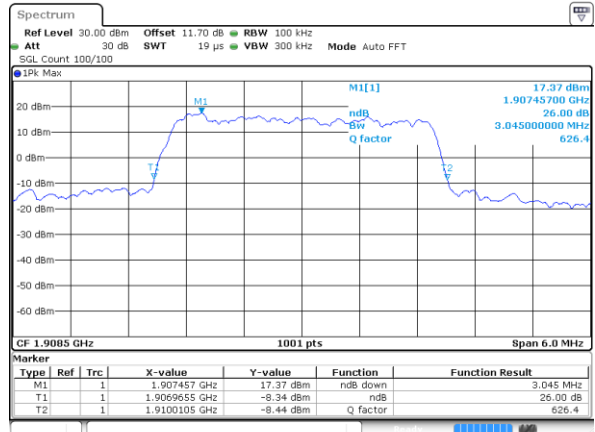

Date: 3 AUG 2017 14:31:07



LTE Band 2

Lowest Channel / 5MHz / QPSK

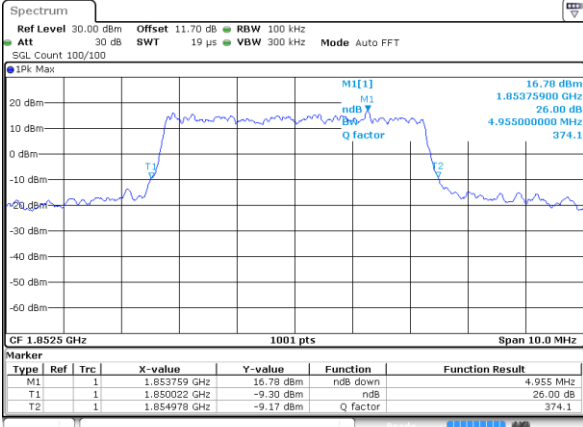

Date: 3 AUG 2017 14:37:59

Lowest Channel / 5MHz / 16QAM

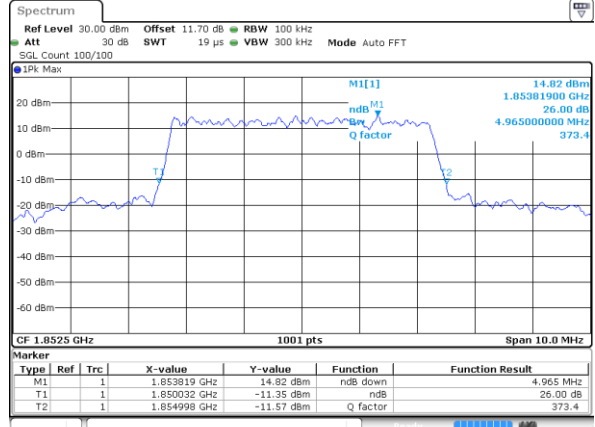

Date: 3 AUG 2017 14:38:09

Middle Channel / 5MHz / QPSK

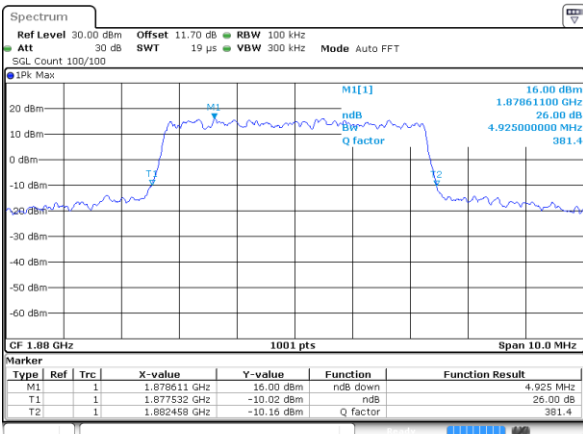

Date: 3 AUG 2017 14:45:02

Middle Channel / 5MHz / 16QAM

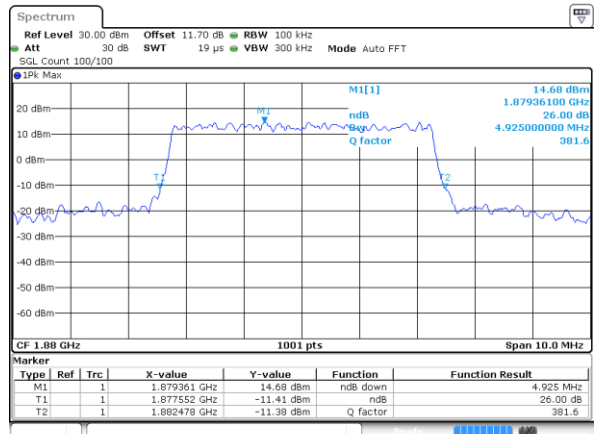

Date: 3 AUG 2017 14:45:12

Highest Channel / 5MHz / QPSK

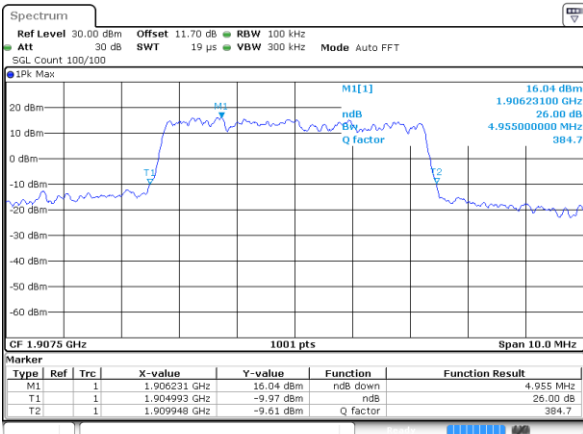

Date: 3 AUG 2017 14:47:30

Highest Channel / 5MHz / 16QAM

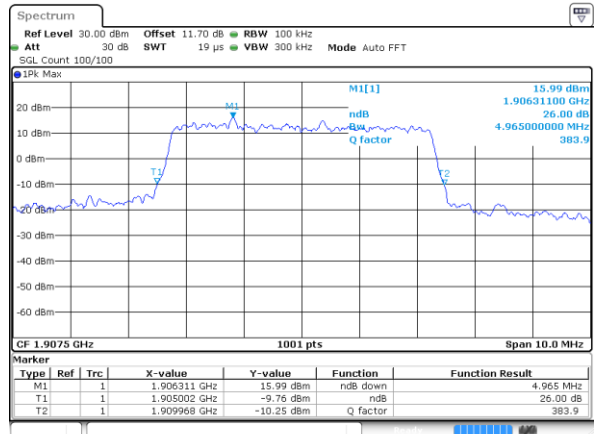

Date: 3 AUG 2017 14:47:40



LTE Band 2

Lowest Channel / 10MHz / QPSK

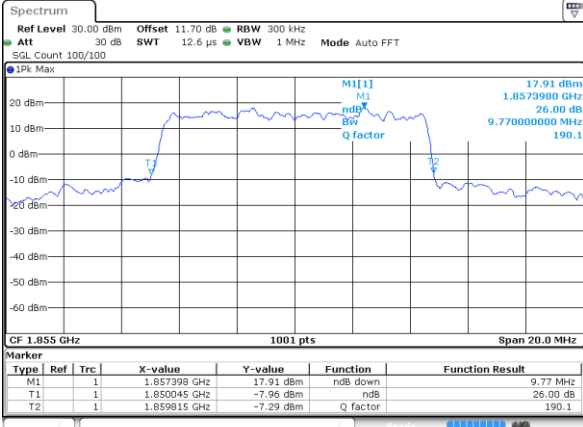

Date: 3 AUG 2017 14:54:33

Lowest Channel / 10MHz / 16QAM

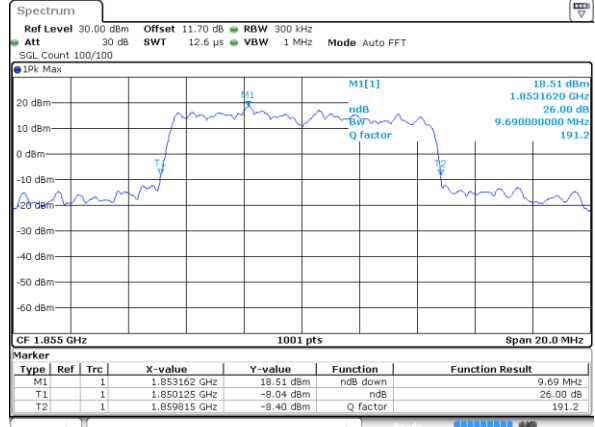

Date: 3 AUG 2017 14:54:43

Middle Channel / 10MHz / QPSK

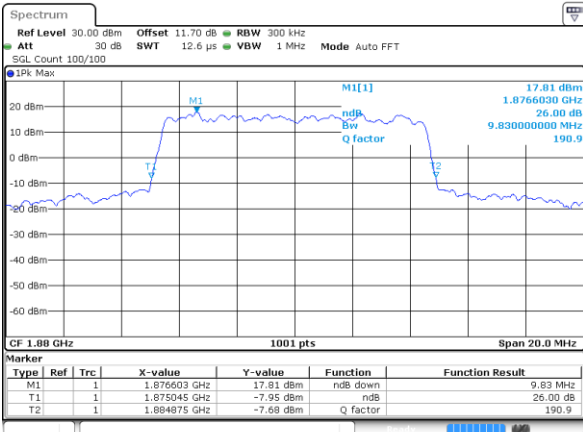

Date: 3 AUG 2017 15:01:36

Middle Channel / 10MHz / 16QAM

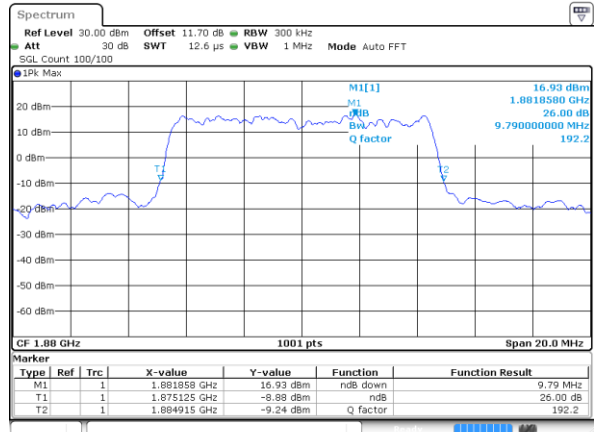

Date: 3 AUG 2017 15:01:46

Highest Channel / 10MHz / QPSK

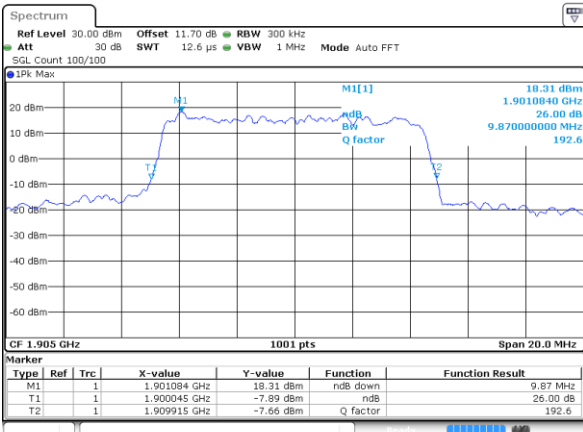

Date: 3 AUG 2017 15:04:04

Highest Channel / 10MHz / 16QAM

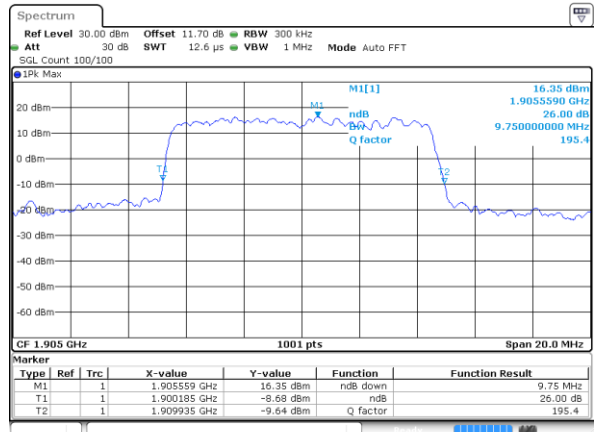

Date: 3 AUG 2017 15:04:14



LTE Band 2

Lowest Channel / 15MHz / QPSK

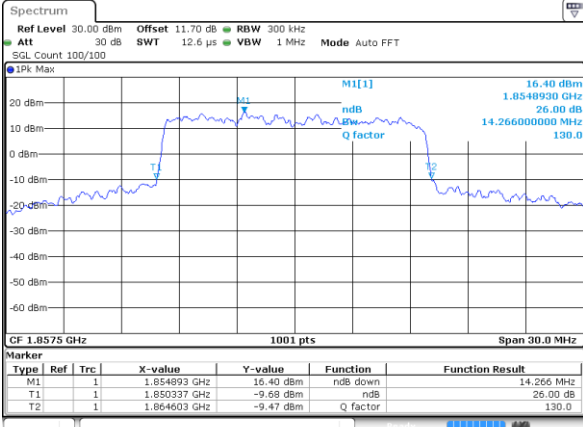

Date: 3 AUG 2017 15:11:07

Lowest Channel / 15MHz / 16QAM

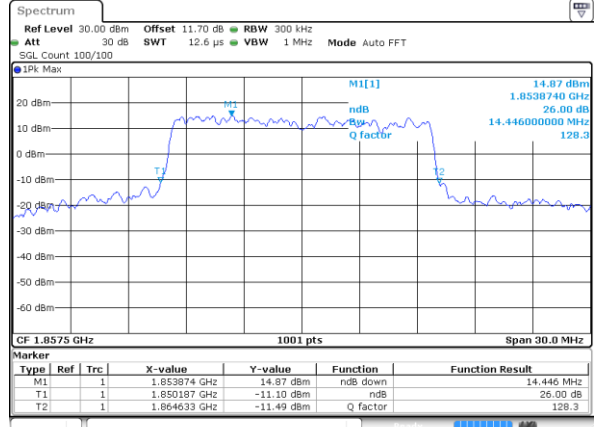

Date: 3 AUG 2017 15:11:17

Middle Channel / 15MHz / QPSK

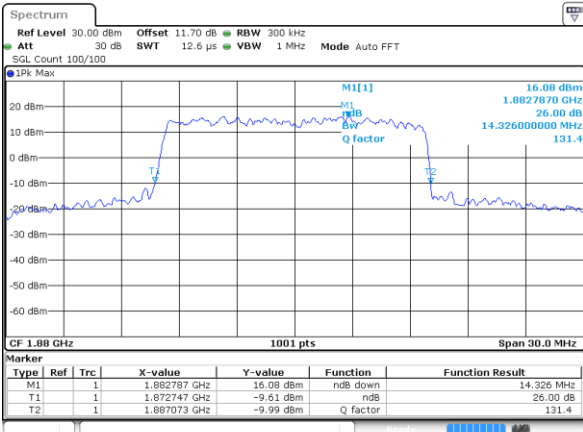

Date: 3 AUG 2017 15:18:10

Middle Channel / 15MHz / 16QAM

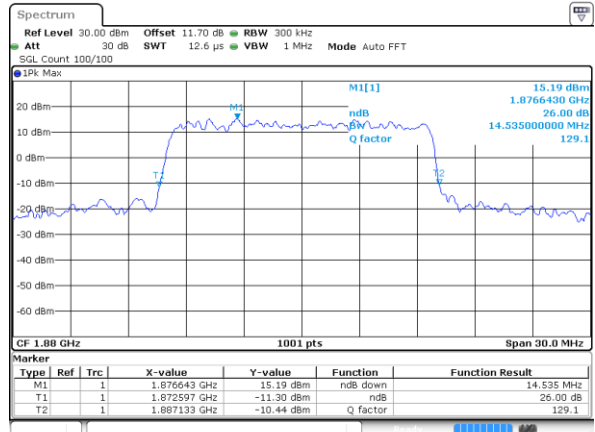

Date: 3 AUG 2017 15:18:20

Highest Channel / 15MHz / QPSK

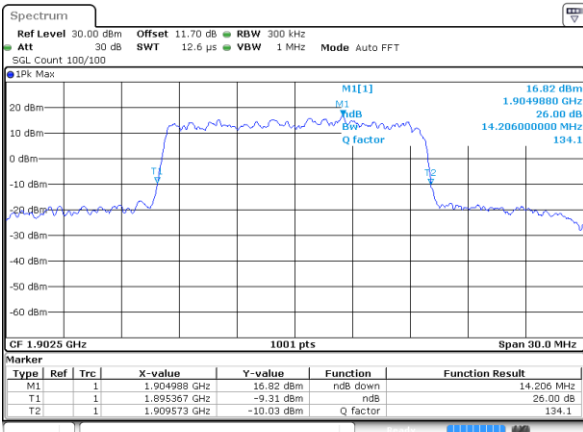

Date: 3 AUG 2017 15:20:38

Highest Channel / 15MHz / 16QAM

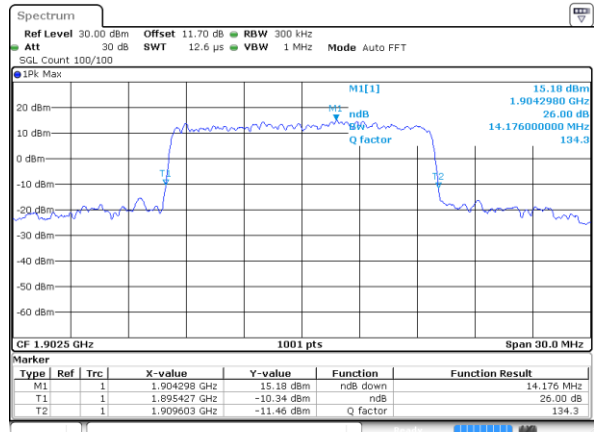

Date: 3 AUG 2017 15:20:48



LTE Band 2

Lowest Channel / 20MHz / QPSK

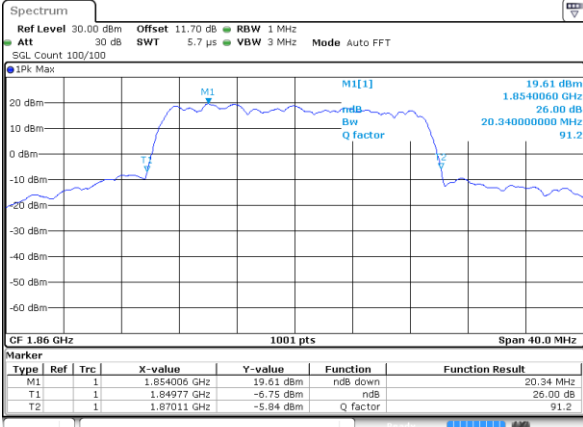

Date: 3 AUG 2017 15:27:41

Lowest Channel / 20MHz / 16QAM

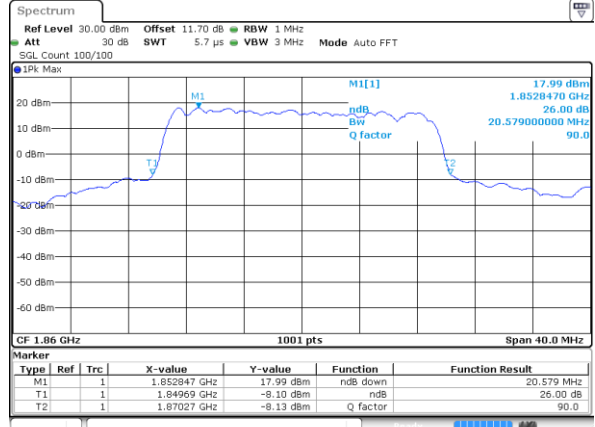

Date: 3 AUG 2017 15:27:51

Middle Channel / 20MHz / QPSK

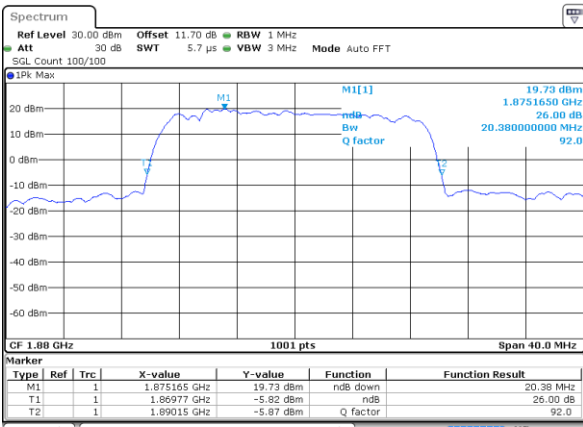

Date: 3 AUG 2017 15:34:44

Middle Channel / 20MHz / 16QAM

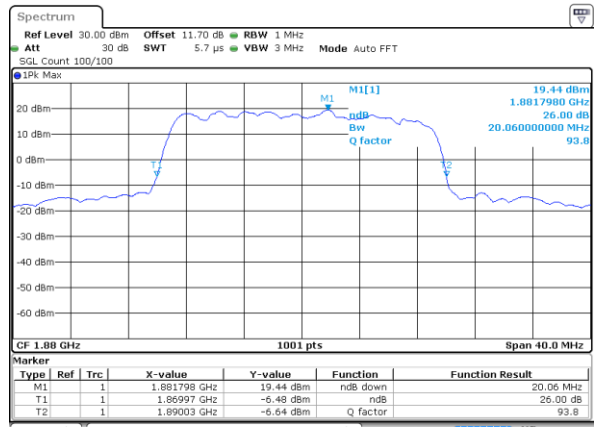

Date: 3 AUG 2017 15:34:54

Highest Channel / 20MHz / QPSK

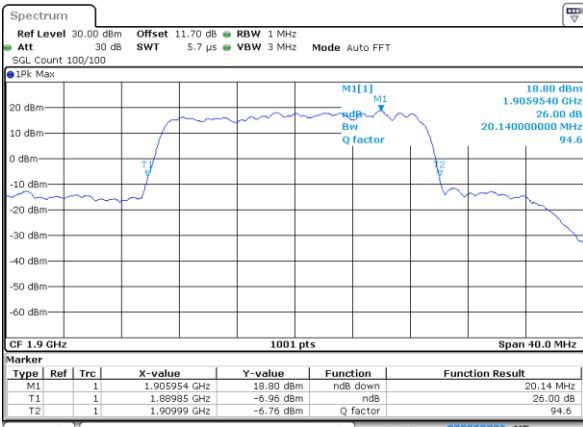

Date: 3 AUG 2017 15:37:13

Highest Channel / 20MHz / 16QAM

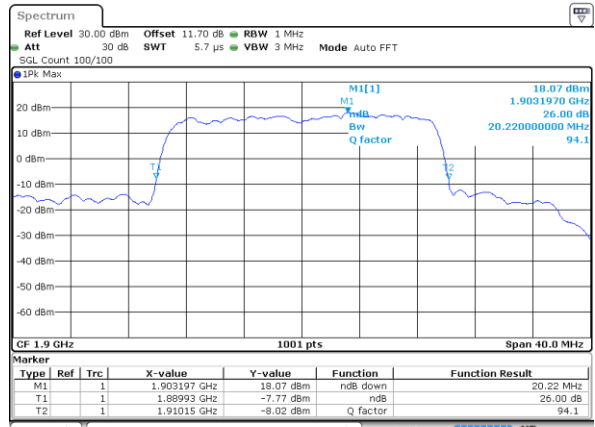

Date: 3 AUG 2017 15:37:23



LTE Band 2

Lowest Channel / 1.4MHz / 64QAM

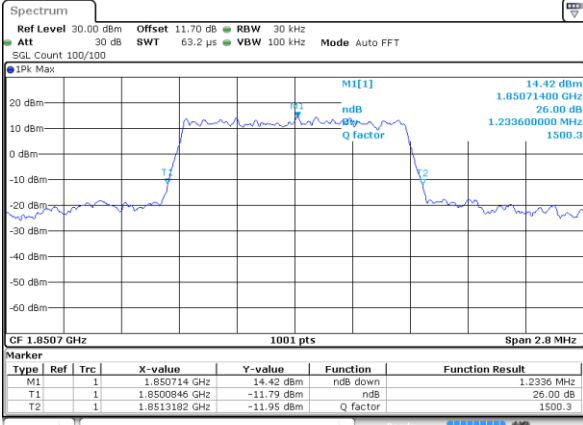

Date: 6 OCT 2017 19:42:34

Lowest Channel / 3MHz / 64QAM

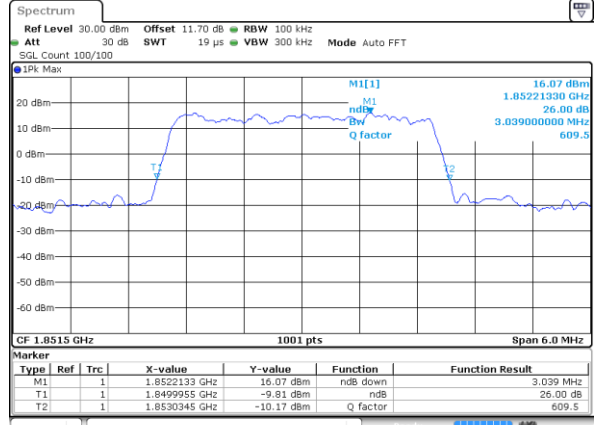

Date: 6 OCT 2017 19:01:10

Middle Channel / 1.4MHz / 64QAM

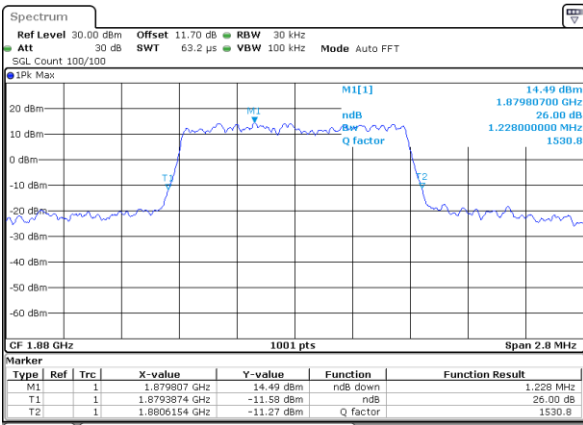

Date: 6 OCT 2017 19:46:06

Middle Channel / 3MHz / 64QAM

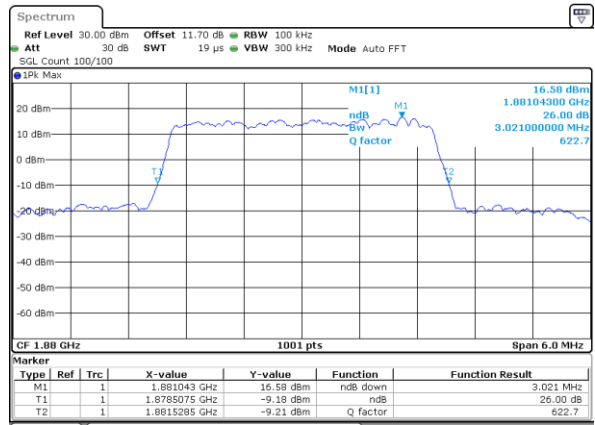

Date: 6 OCT 2017 19:04:42

Highest Channel / 1.4MHz / 64QAM

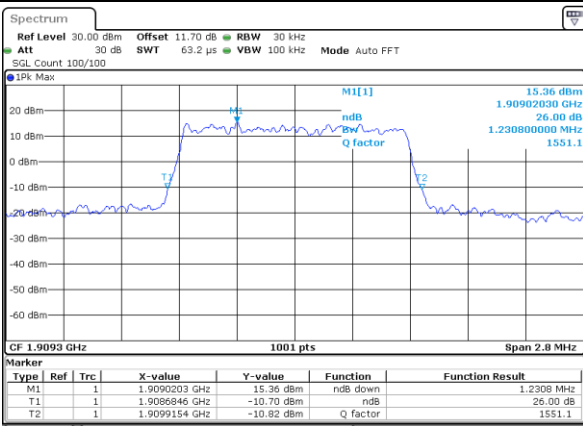

Date: 6 OCT 2017 19:47:20

Highest Channel / 3MHz / 64QAM

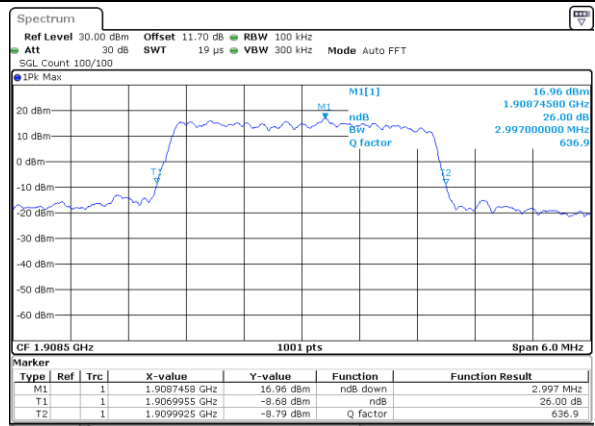

Date: 6 OCT 2017 19:05:56



LTE Band 2

Lowest Channel / 5MHz / 64QAM

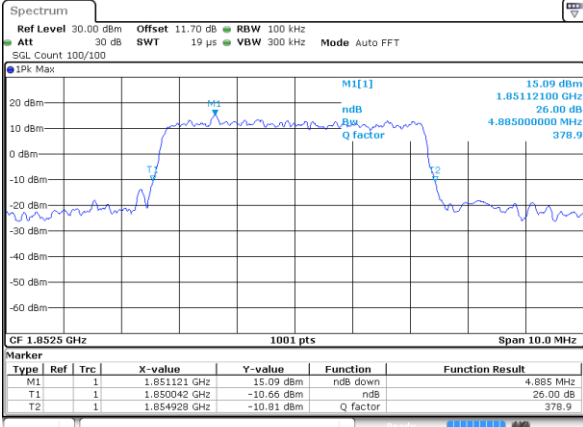

Date: 6.OCT.2017 19:09:27

Lowest Channel / 10MHz / 64QAM

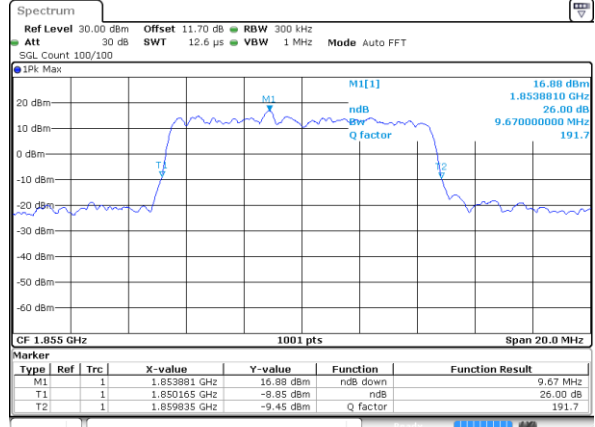

Date: 6.OCT.2017 19:17:44

Middle Channel / 5MHz / 64QAM

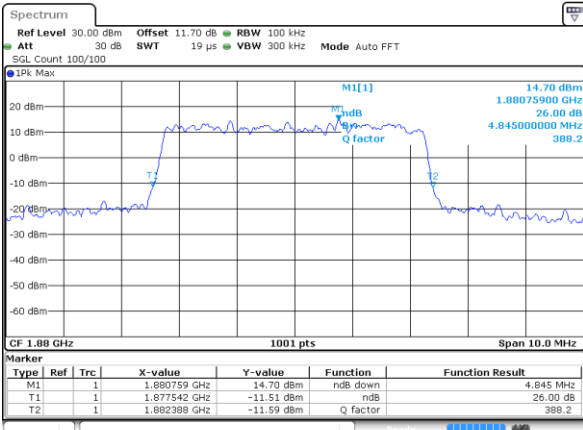

Date: 6.OCT.2017 19:12:59

Middle Channel / 10MHz / 64QAM

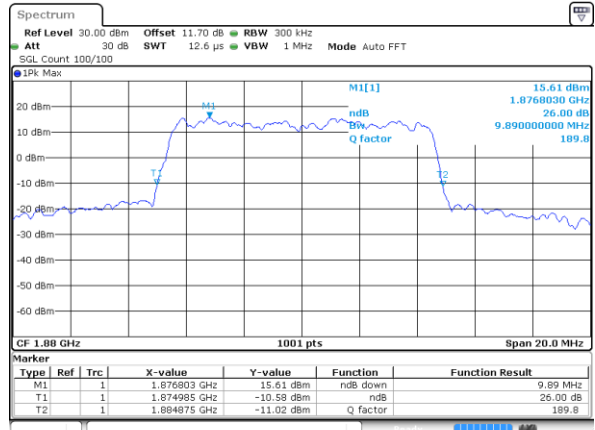

Date: 6.OCT.2017 19:21:16

Highest Channel / 5MHz / 64QAM

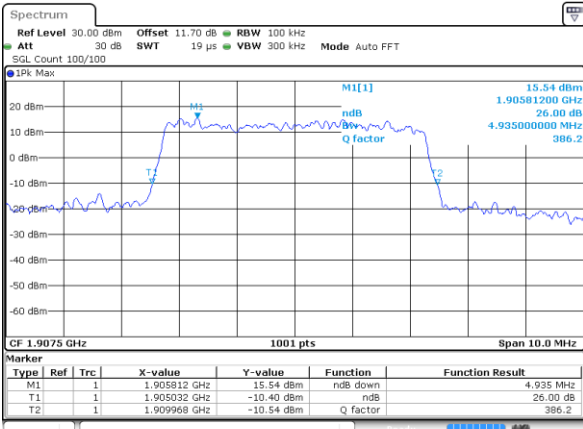

Date: 6.OCT.2017 19:14:13

Highest Channel / 10MHz / 64QAM

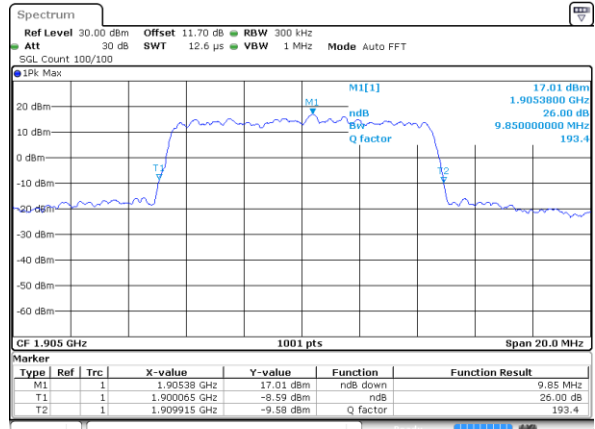

Date: 6.OCT.2017 19:22:30



LTE Band 2

Lowest Channel / 15MHz / 64QAM

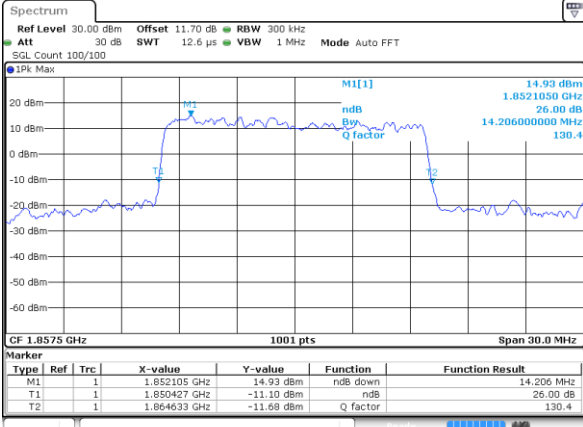

Date: 6 OCT 2017 19:26:01

Lowest Channel / 20MHz / 64QAM

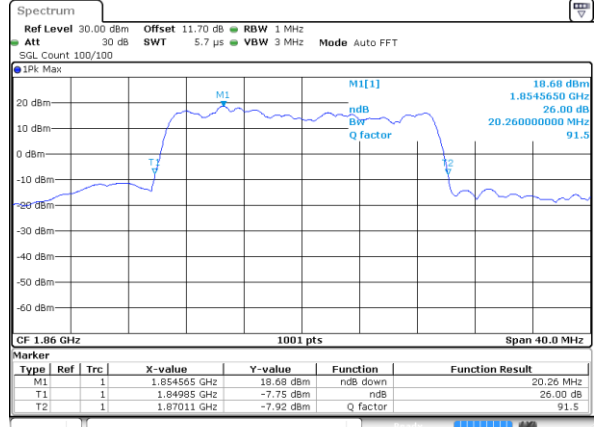

Date: 6 OCT 2017 19:34:18

Middle Channel / 15MHz / 64QAM

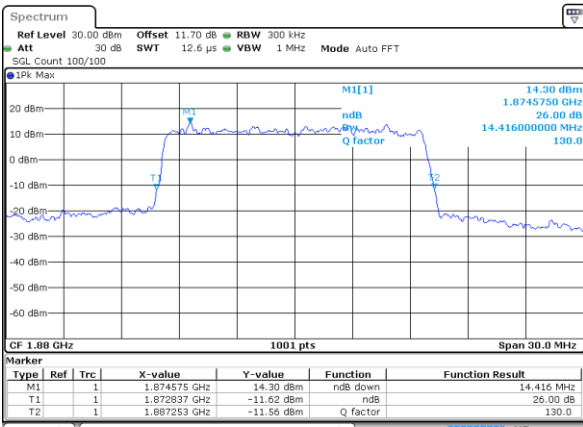

Date: 6 OCT 2017 19:29:33

Middle Channel / 20MHz / 64QAM

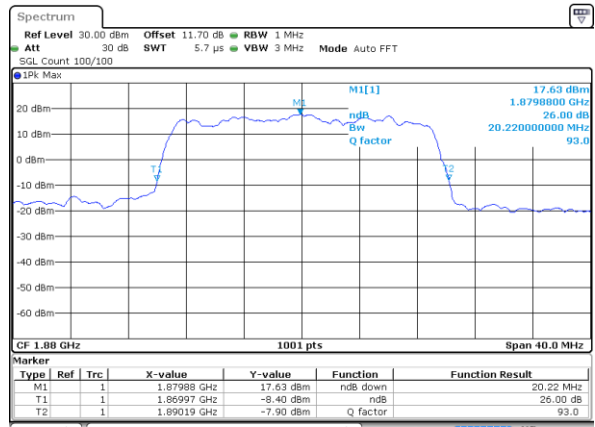

Date: 6 OCT 2017 19:37:49

Highest Channel / 15MHz / 64QAM

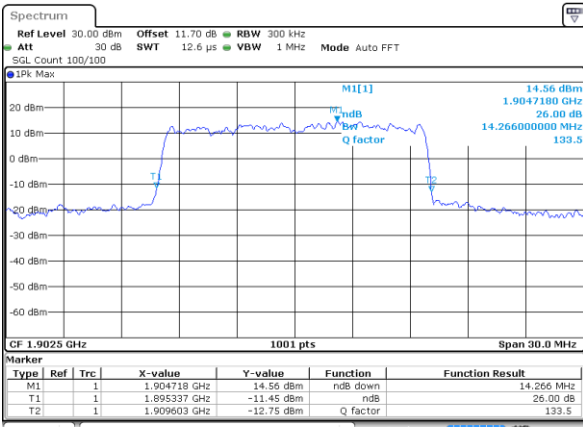

Date: 6 OCT 2017 19:30:47

Highest Channel / 20MHz / 64QAM

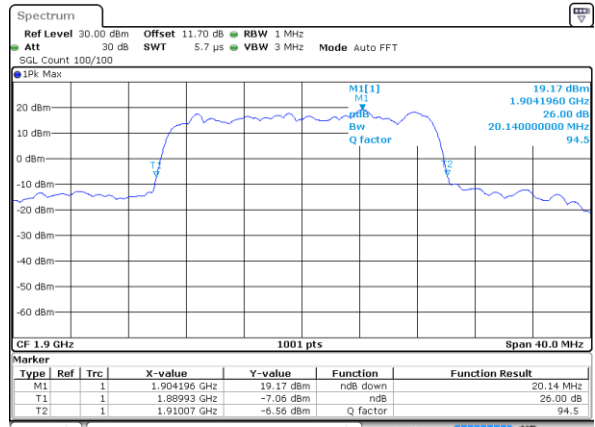

Date: 6 OCT 2017 19:38:03



Occupied Bandwidth

Mode	LTE Band 2 : 99%OBW(MHz)											
BW	1.4MHz		3MHz		5MHz		10MHz		15MHz		20MHz	
Mod.	QPSK	16QAM	QPSK	16QAM	QPSK	16QAM	QPSK	16QAM	QPSK	16QAM	QPSK	16QAM
Lowest CH	1.09	1.09	2.74	2.7	4.5	4.49	9.07	8.97	13.43	13.4	18.46	18.38
Middle CH	1.09	1.1	2.72	2.72	4.5	4.5	9.05	8.99	13.37	13.46	18.22	18.18
Highest CH	1.09	1.1	2.74	2.73	4.53	4.5	9.03	9.03	13.37	13.31	18.18	18.38
Mode	LTE Band 2 : 99%OBW(MHz)											
BW	1.4MHz		3MHz		5MHz		10MHz		15MHz		20MHz	
Mod.	64QAM		64QAM		64QAM		64QAM		64QAM		64QAM	
Lowest CH	1.09	-	2.73	-	4.51	-	9.05	-	13.46	-	18.26	-
Middle CH	1.09	-	2.72	-	4.51	-	9.05	-	13.4	-	18.22	-
Highest CH	1.09	-	2.72	-	4.5	-	8.99	-	13.4	-	18.34	-



LTE Band 2

Lowest Channel / 1.4MHz / QPSK

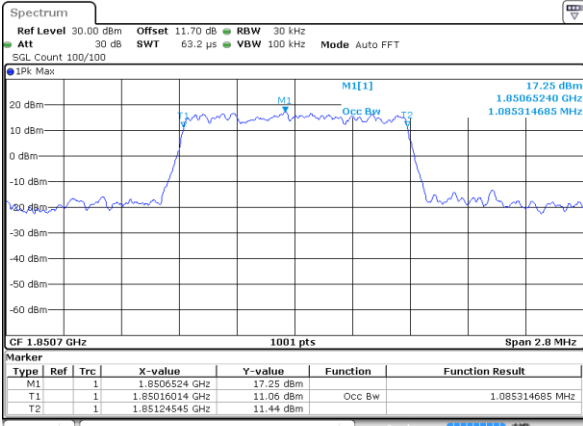

Date: 3 AUG 2017 15:55:40

Lowest Channel / 1.4MHz / 16QAM

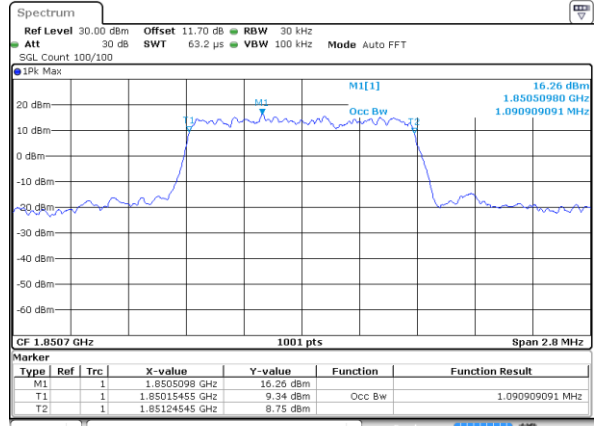

Date: 3 AUG 2017 15:55:50

Middle Channel / 1.4MHz / QPSK

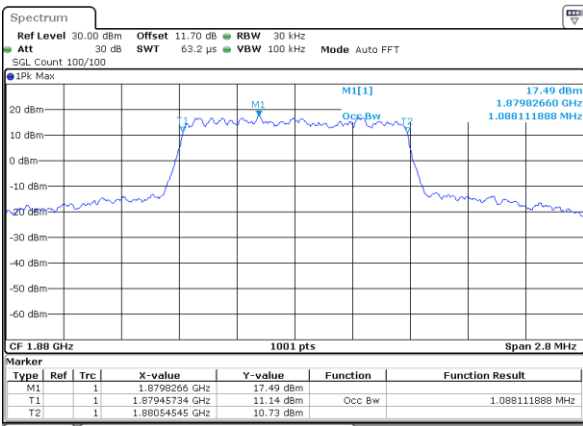

Date: 3 AUG 2017 16:02:43

Middle Channel / 1.4MHz / 16QAM

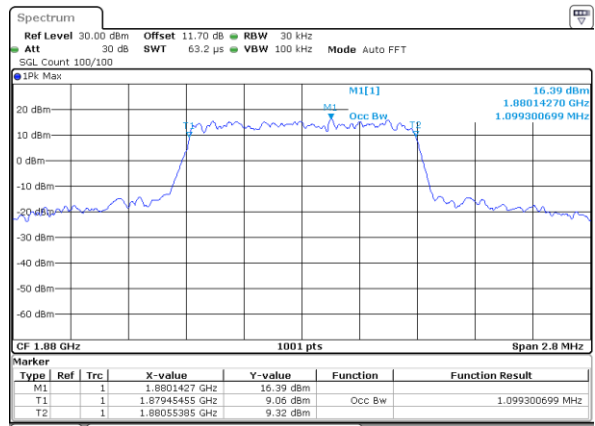

Date: 3 AUG 2017 16:02:53

Highest Channel / 1.4MHz / QPSK

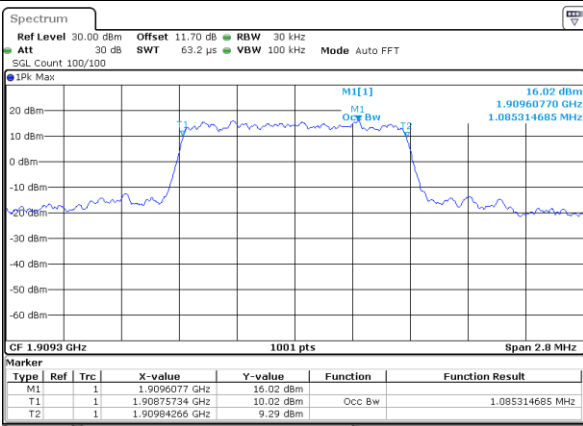

Date: 3 AUG 2017 16:05:11

Highest Channel / 1.4MHz / 16QAM

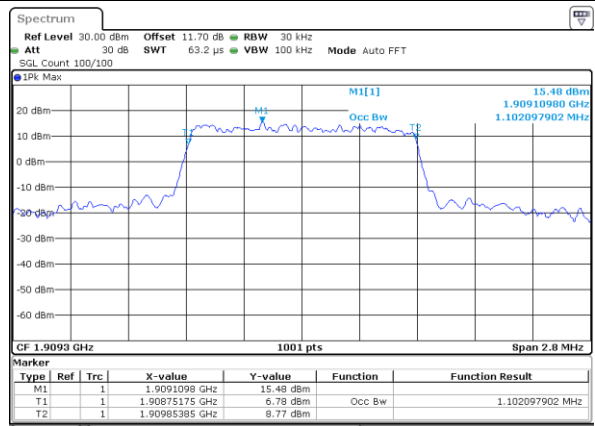

Date: 3 AUG 2017 16:05:21



LTE Band 2

Lowest Channel / 3MHz / QPSK

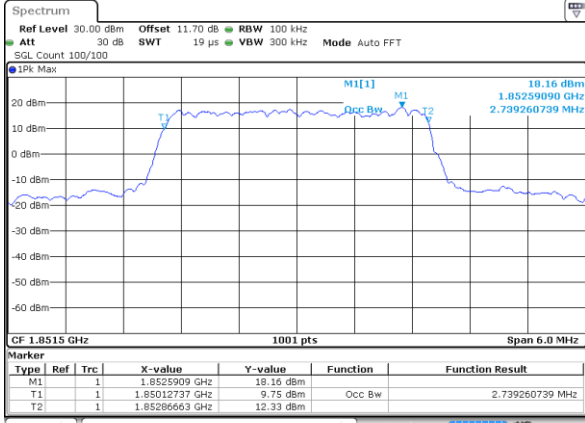

Date: 3 AUG 2017 14:21:05

Lowest Channel / 3MHz / 16QAM

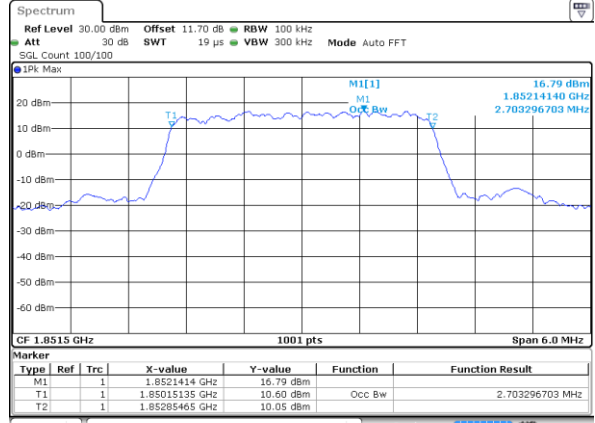

Date: 3 AUG 2017 14:21:15

Middle Channel / 3MHz / QPSK

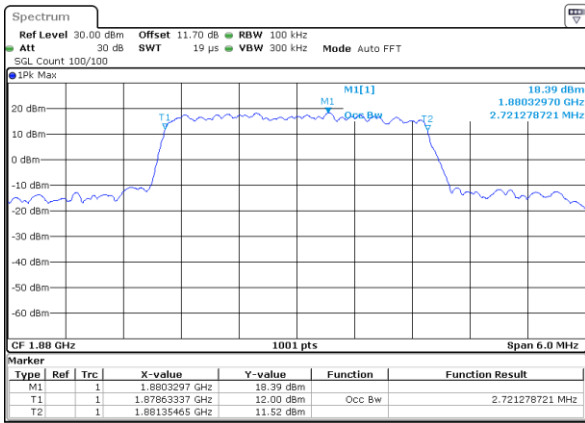

Date: 3 AUG 2017 14:28:08

Middle Channel / 3MHz / 16QAM

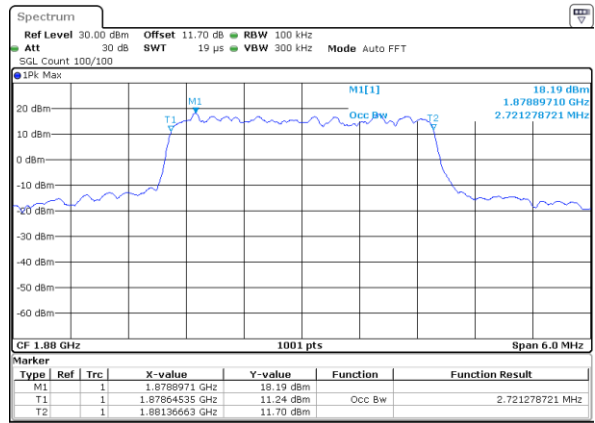

Date: 3 AUG 2017 14:28:18

Highest Channel / 3MHz / QPSK

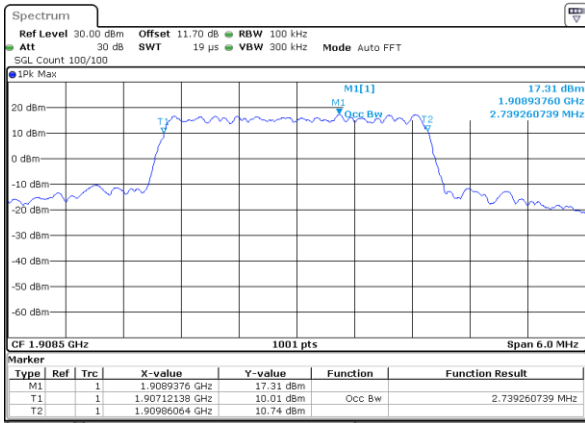

Date: 3 AUG 2017 14:30:37

Highest Channel / 3MHz / 16QAM

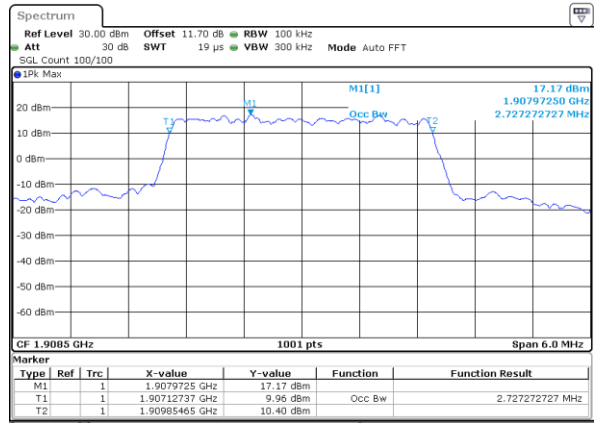

Date: 3 AUG 2017 14:30:47



LTE Band 2

Lowest Channel / 5MHz / QPSK

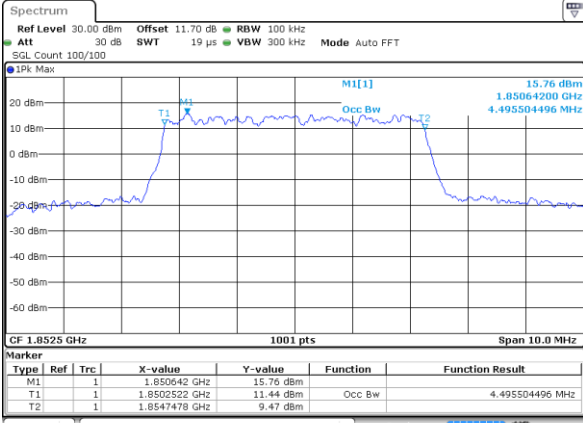

Date: 3 AUG 2017 14:37:39

Lowest Channel / 5MHz / 16QAM

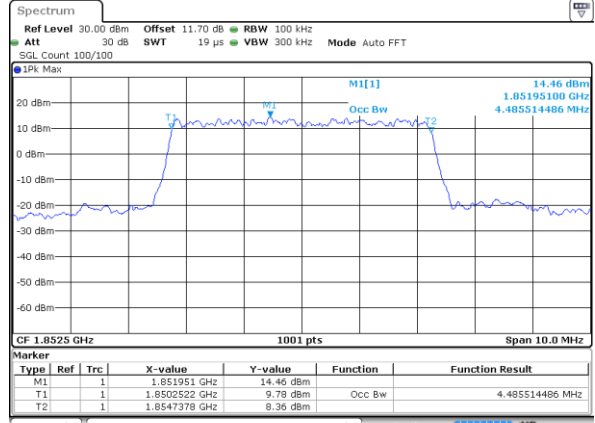

Date: 3 AUG 2017 14:37:49

Middle Channel / 5MHz / QPSK

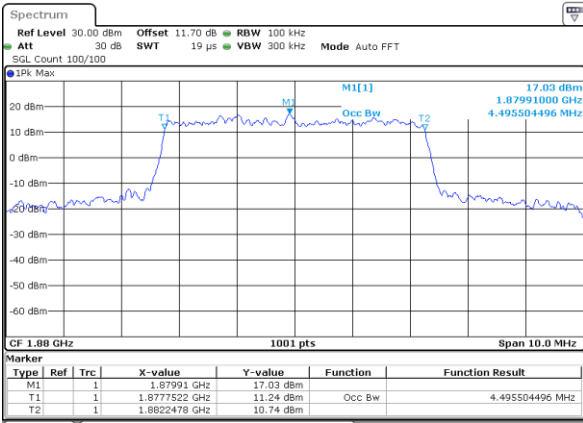

Date: 3 AUG 2017 14:44:42

Middle Channel / 5MHz / 16QAM

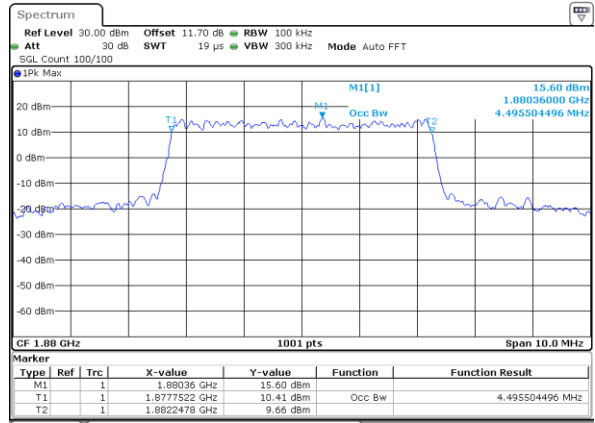

Date: 3 AUG 2017 14:44:52

Highest Channel / 5MHz / QPSK

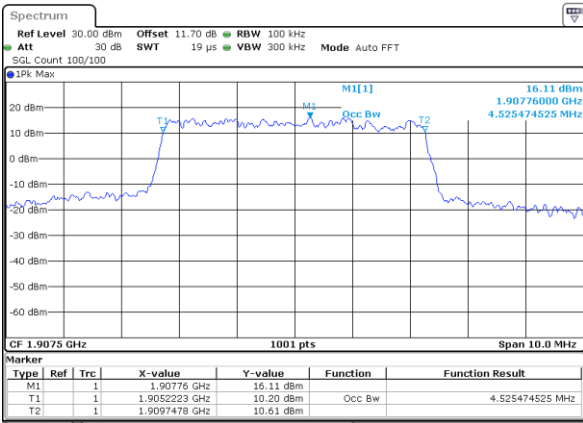

Date: 3 AUG 2017 14:47:10

Highest Channel / 5MHz / 16QAM

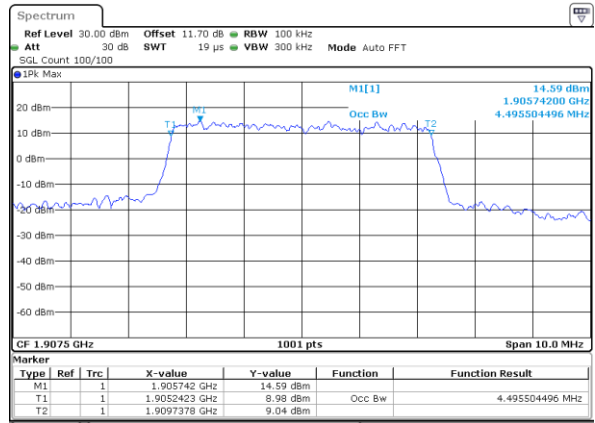

Date: 3 AUG 2017 14:47:20



LTE Band 2

Lowest Channel / 10MHz / QPSK

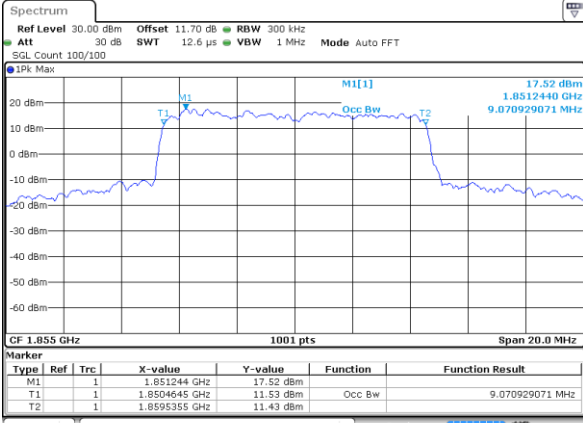

Date: 3 AUG 2017 14:54:13

Lowest Channel / 10MHz / 16QAM

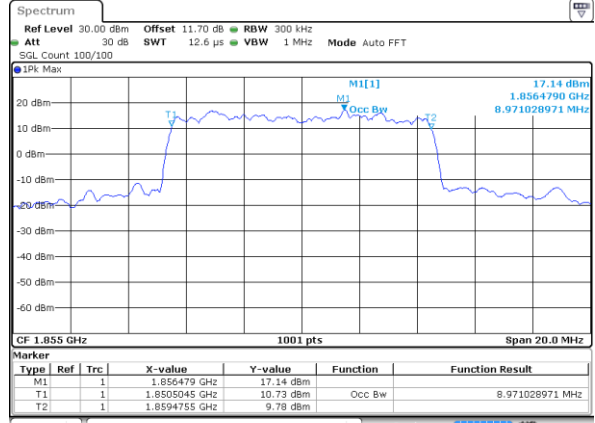

Date: 3 AUG 2017 14:54:23

Middle Channel / 10MHz / QPSK

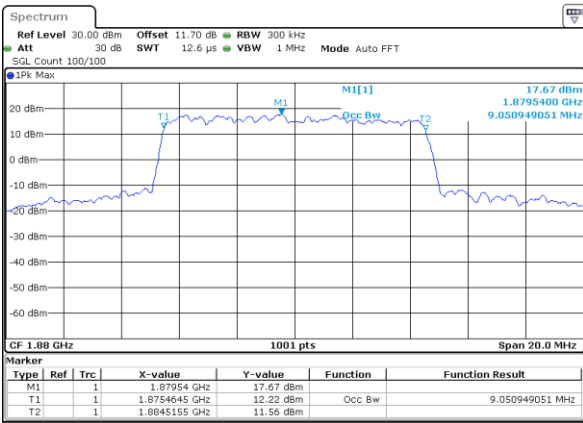

Date: 3 AUG 2017 15:01:16

Middle Channel / 10MHz / 16QAM

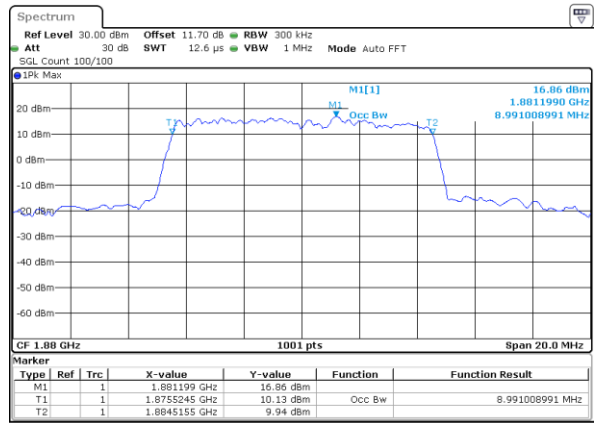

Date: 3 AUG 2017 15:01:26

Highest Channel / 10MHz / QPSK

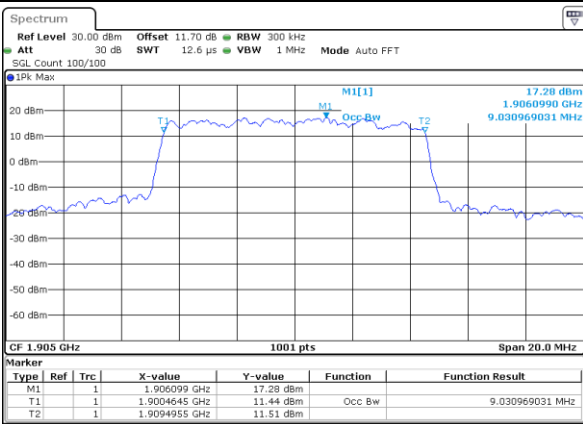

Date: 3 AUG 2017 15:03:44

Highest Channel / 10MHz / 16QAM

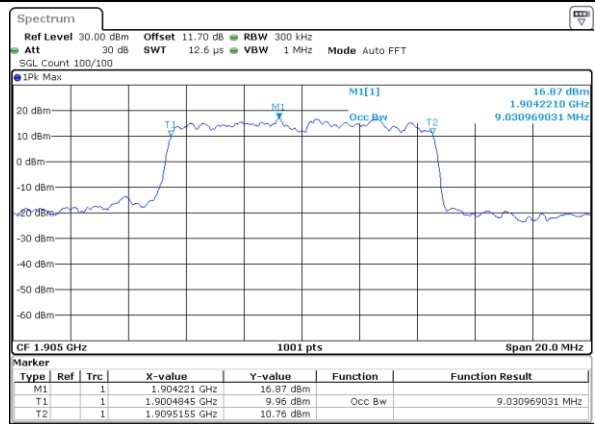

Date: 3 AUG 2017 15:03:54



LTE Band 2

Lowest Channel / 15MHz / QPSK

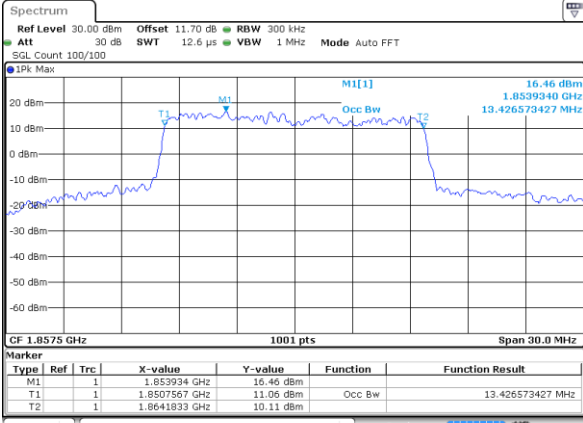

Date: 3 AUG 2017 15:10:47

Lowest Channel / 15MHz / 16QAM

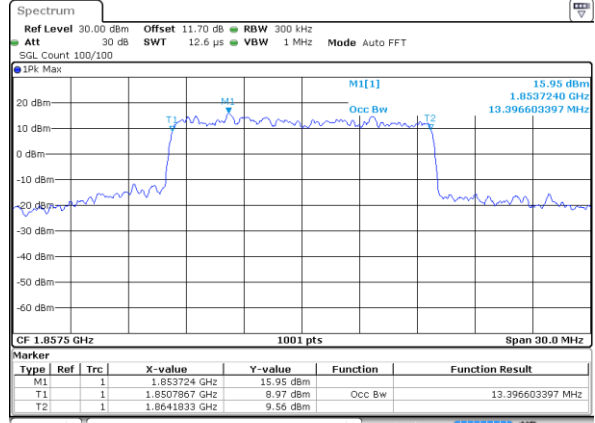

Date: 3 AUG 2017 15:10:57

Middle Channel / 15MHz / QPSK

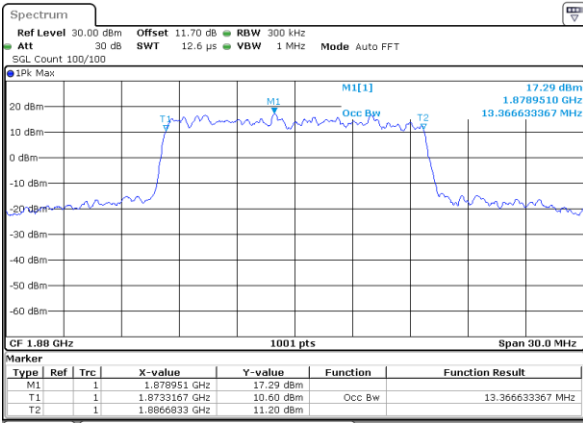

Date: 3 AUG 2017 15:17:50

Middle Channel / 15MHz / 16QAM

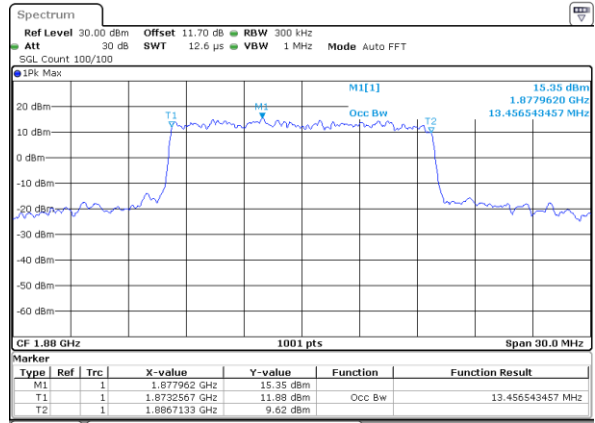

Date: 3 AUG 2017 15:16:00

Highest Channel / 15MHz / QPSK

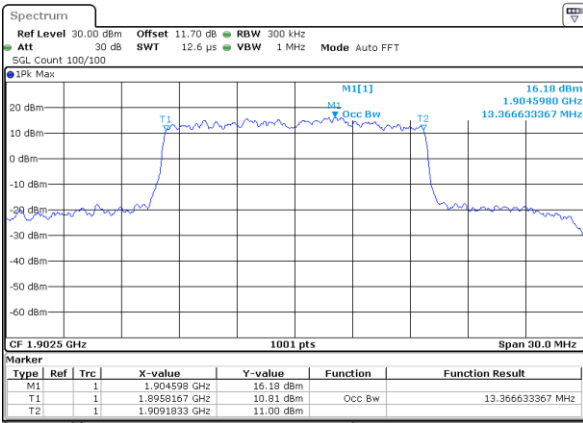

Date: 3 AUG 2017 15:20:18

Highest Channel / 15MHz / 16QAM

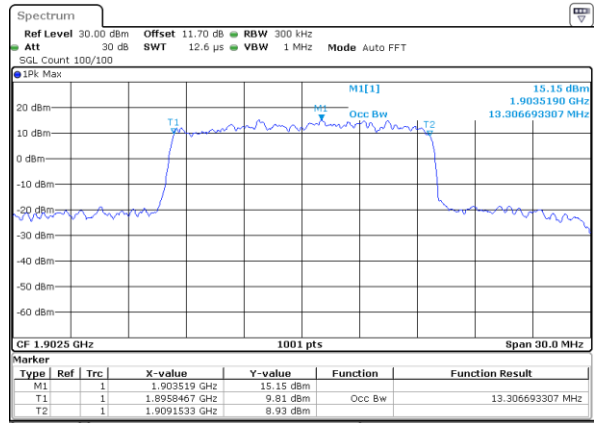

Date: 3 AUG 2017 15:20:28



LTE Band 2

Lowest Channel / 20MHz / QPSK

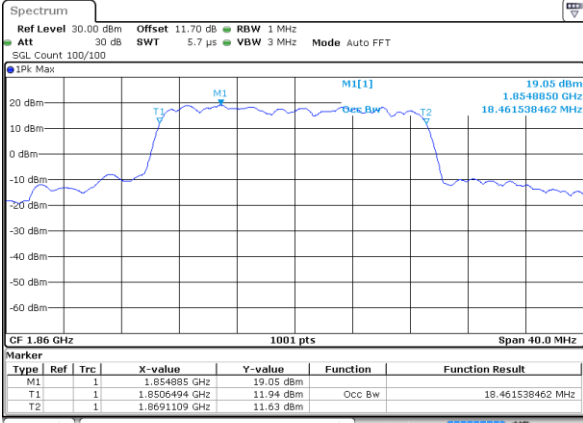

Date: 3 AUG 2017 15:27:21

Lowest Channel / 20MHz / 16QAM

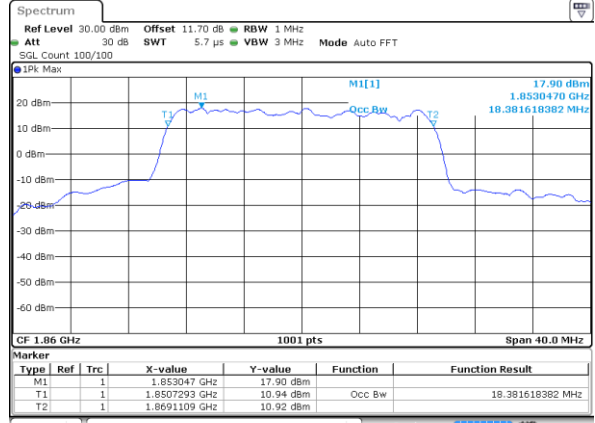

Date: 3 AUG 2017 15:27:31

Middle Channel / 20MHz / QPSK

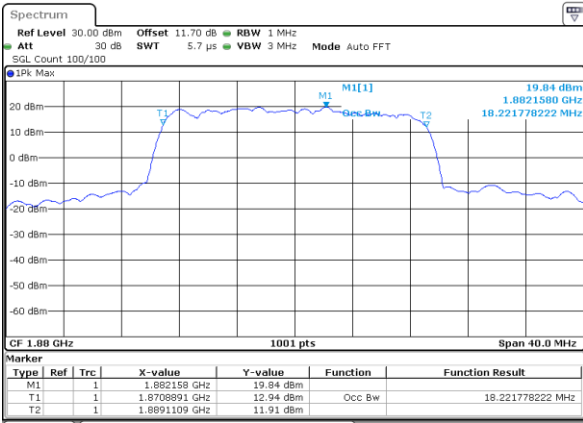

Date: 3 AUG 2017 15:34:24

Middle Channel / 20MHz / 16QAM

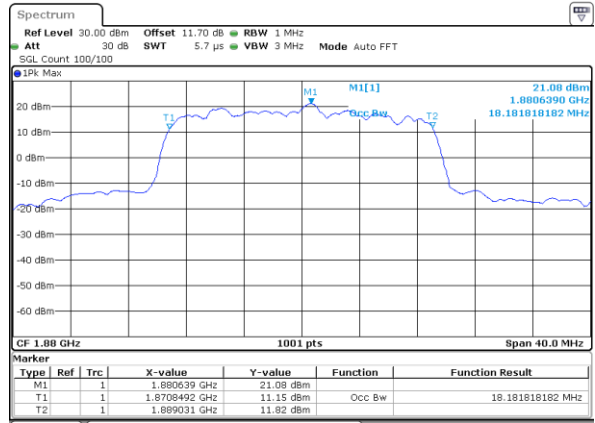

Date: 3 AUG 2017 15:34:34

Highest Channel / 20MHz / QPSK

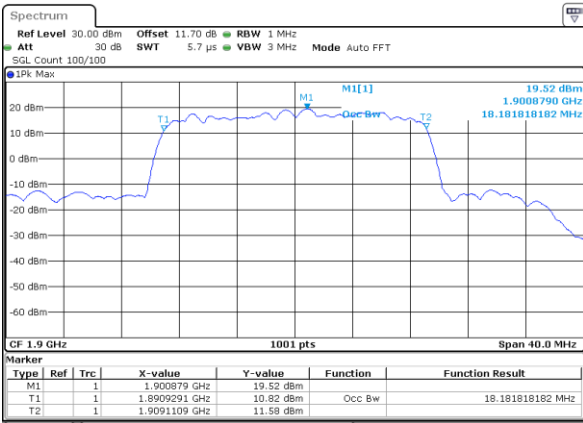

Date: 3 AUG 2017 15:36:53

Highest Channel / 20MHz / 16QAM

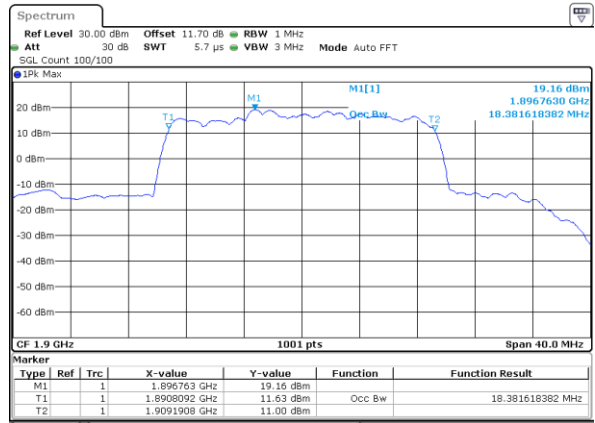

Date: 3 AUG 2017 15:37:03



LTE Band 2

Lowest Channel / 1.4MHz / 64QAM

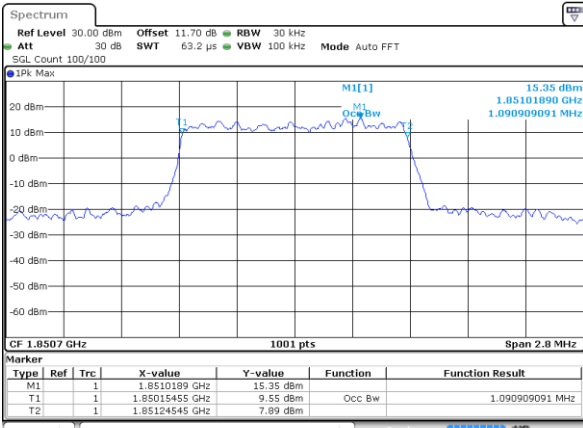

Date: 6.OCT.2017 19:42:24

Lowest Channel / 3MHz / 64QAM

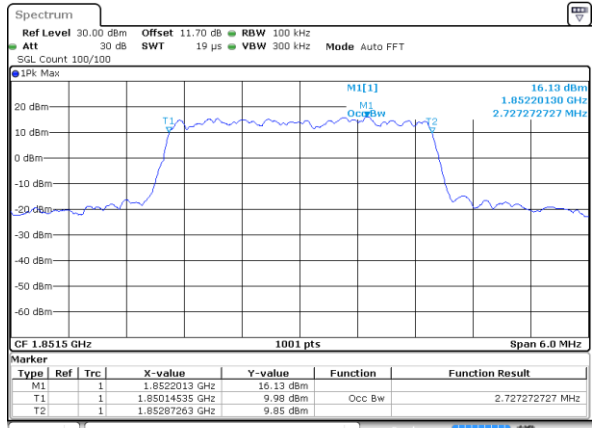

Date: 6.OCT.2017 19:00:59

Middle Channel / 1.4MHz / 64QAM

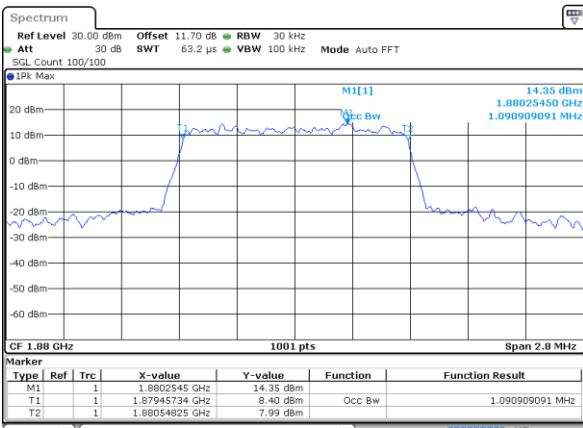

Date: 6.OCT.2017 19:45:56

Middle Channel / 3MHz / 64QAM

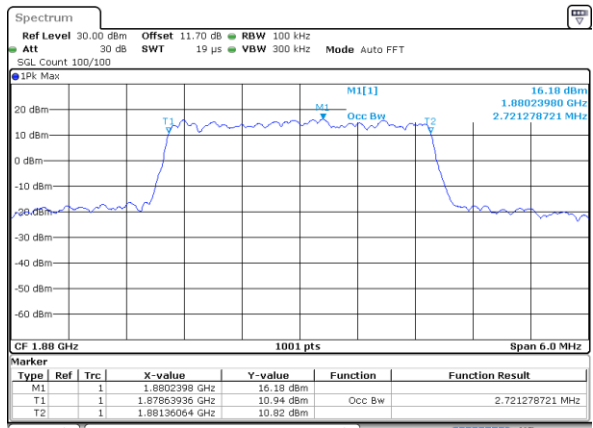

Date: 6.OCT.2017 19:04:32

Highest Channel / 1.4MHz / 64QAM

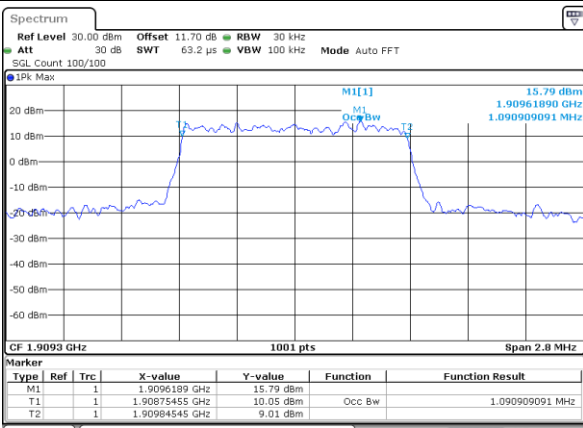

Date: 6.OCT.2017 19:47:10

Highest Channel / 3MHz / 64QAM

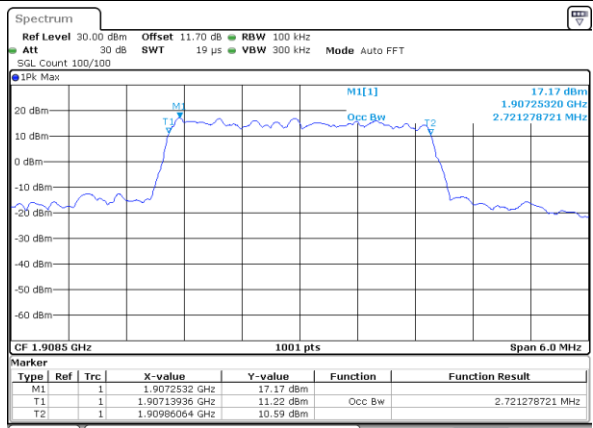

Date: 6.OCT.2017 19:05:46



LTE Band 2

Lowest Channel / 5MHz / 64QAM

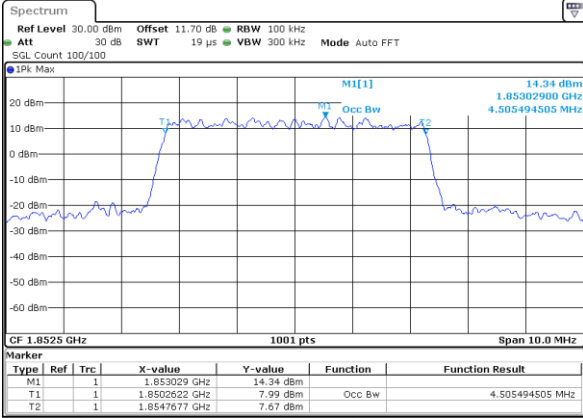

Date: 6 OCT 2017 19:09:17

Lowest Channel / 10MHz / 64QAM

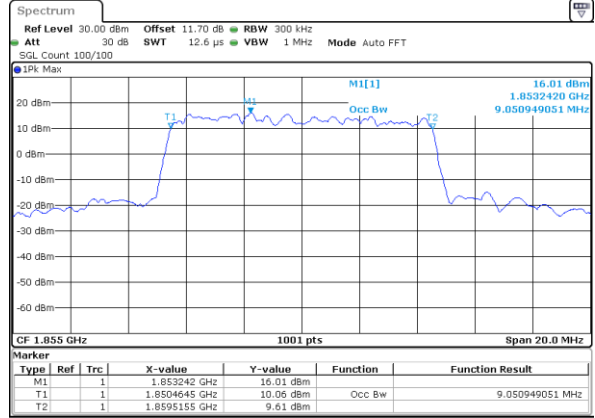

Date: 6 OCT 2017 19:17:34

Middle Channel / 5MHz / 64QAM

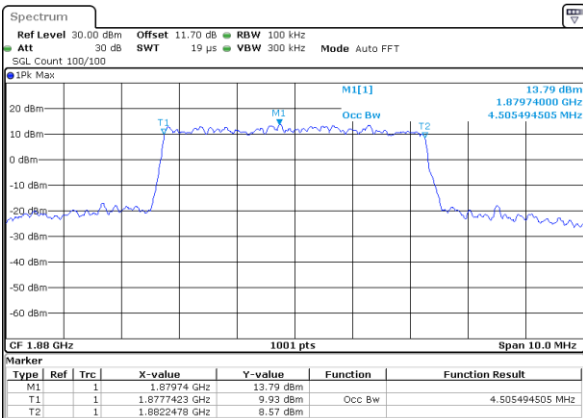

Date: 6 OCT 2017 19:12:49

Middle Channel / 10MHz / 64QAM

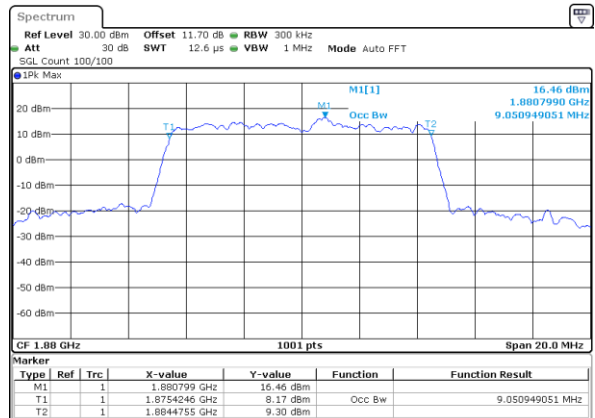

Date: 6 OCT 2017 19:21:06

Highest Channel / 5MHz / 64QAM

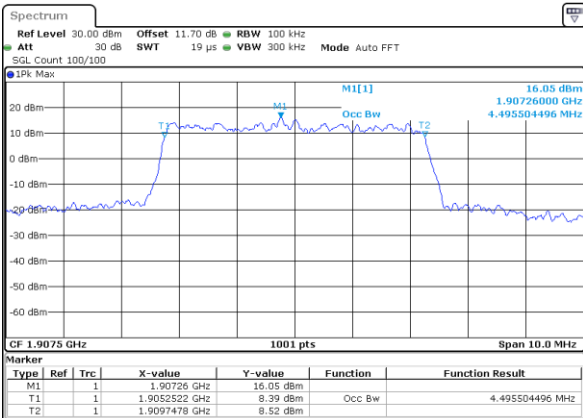

Date: 6 OCT 2017 19:14:03

Highest Channel / 10MHz / 64QAM

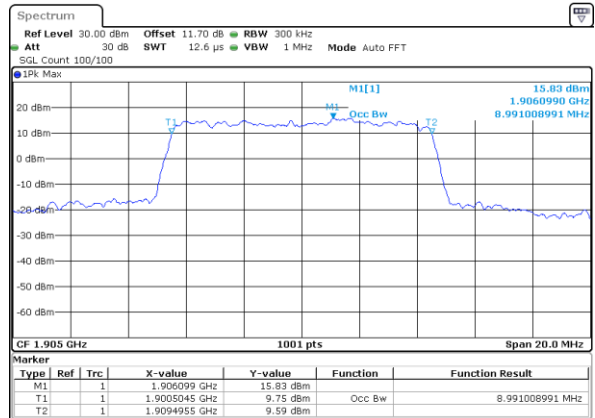

Date: 6 OCT 2017 19:22:20