



FCC RF Test Report

APPLICANT : Sony Mobile Communications Inc.
EQUIPMENT : GSM/WCDMA/LTE Phone+Bluetooth, DTS/UNII
a/b/g/n/ac and NFC
BRAND NAME : Sony
FCC ID : PY7-08608T
STANDARD : FCC Part 15 Subpart E §15.407
CLASSIFICATION : (NII) Unlicensed National Information Infrastructure

The product was received on Jun. 07, 2017 and testing was completed on Oct. 03, 2017. We, SPORTON INTERNATIONAL INC., would like to declare that the tested sample has been evaluated in accordance with the test procedures and has been in compliance with the applicable technical standards.

The test results in this report apply exclusively to the tested model / sample. Without written approval of SPORTON INTERNATIONAL INC., the test report shall not be reproduced except in full.

Reviewed by: Joseph Lin / Supervisor

Approved by: Jones Tsai / Manager



SPORTON INTERNATIONAL INC.

No. 52, Hwa Ya 1st Rd., Hwa Ya Technology Park, Kwei-Shan District, Tao Yuan City, Taiwan, R.O.C.

SPORTON INTERNATIONAL INC.

TEL : 886-3-327-3456

FAX : 886-3-328-4978

FCC ID : PY7-08608T

Page Number : 1 of 31

Report Issued Date : Oct. 26, 2017

Report Version : Rev. 02

Report Template No.: BU5-FR15EWLB4 AC MA Version 2.0



TABLE OF CONTENTS

REVISION HISTORY..... 3

SUMMARY OF TEST RESULT 4

1 GENERAL DESCRIPTION 5

 1.1 Applicant 5

 1.2 Manufacturer 5

 1.3 Product Feature of Equipment Under Test 5

 1.4 Modification of EUT 6

 1.5 Testing Location 7

 1.6 Applicable Standards 7

2 TEST CONFIGURATION OF EQUIPMENT UNDER TEST 8

 2.1 Carrier Frequency Channel 8

 2.2 Test Mode 9

 2.3 Connection Diagram of Test System 10

 2.4 Support Unit used in test configuration and system 11

 2.5 EUT Operation Test Setup 11

 2.6 Measurement Results Explanation Example 11

3 TEST RESULT 12

 3.1 6dB, 26dB and 99% Occupied Bandwidth Measurement 12

 3.2 Maximum Conducted Output Power Measurement 15

 3.3 Power Spectral Density Measurement 16

 3.4 Unwanted Radiated Emission Measurement 18

 3.5 AC Conducted Emission Measurement 24

 3.6 Frequency Stability Measurement 26

 3.7 Automatically Discontinue Transmission 27

 3.8 Antenna Requirements 28

4 LIST OF MEASURING EQUIPMENTS 29

5 UNCERTAINTY OF EVALUATION 31

APPENDIX A. CONDUCTED TEST RESULTS

APPENDIX B. AC CONDUCTED EMISSION TEST RESULT

APPENDIX C. RADIATED SPURIOUS EMISSION

APPENDIX D. RADIATED SPURIOUS EMISSION PLOTS

APPENDIX E. DUTY CYCLE PLOTS



SUMMARY OF TEST RESULT

Report Section	FCC Rule	Description	Limit	Result	Remark
3.1	15.403(i)	6dB, 26dB and 99% Occupied Bandwidth	> 500kHz	Pass	-
3.2	15.407(a)	Maximum Conducted Output Power	≤ 30 dBm	Pass	-
3.3	15.407(a)	Power Spectral Density	≤ 30 dBm/500kHz	Pass	-
3.4	15.407(b)	Unwanted Emissions	15.407(b)(4)(i) & 15.209(a)	Pass	Under limit 5.28 dB at 36.750 MHz
3.5	15.207	AC Conducted Emission	15.207(a)	Pass	Under limit 15.30 dB at 0.150 MHz
3.6	15.407(g)	Frequency Stability	Within Operation Band	Pass	-
3.7	15.407(c)	Automatically Discontinue Transmission	Discontinue Transmission	Pass	-
3.8	15.203 & 15.407(a)	Antenna Requirement	N/A	Pass	-



1 General Description

1.1 Applicant

Sony Mobile Communications Inc.

4-12-3 Higashi-Shinagawa, Shinagawa-ku, Tokyo, 140-0002, Japan

1.2 Manufacturer

Sony Mobile Communications Inc.

4-12-3 Higashi-Shinagawa, Shinagawa-ku, Tokyo, 140-0002, Japan

1.3 Product Feature of Equipment Under Test

GSM/WCDMA/LTE, Bluetooth, DTS/UNII a/b/g/n/ac, FM Receiver, NFC, and GPS.

Standards-related Product Specification	
Antenna Type / Gain	PIFA Antenna with gain -4.50 dBi

EUT Information List			
HW Version	SW Version	S/N	Performed Test Item
A	1.14	RQ3005UYBC	RF conducted measurement
		CQ300000EW	Radiated Spurious Emission
		CQ300000EL	AC Conducted Emission



Accessory List	
AC Adapter 1	Model Name: UCH12
	S/N:
	VB17W34100174 (for radiated emission) VB17W34100230 (for conducted emission)
Earphone 1	Model Name: MH410c
	S/N: N/A
USB Cable	Model Name: UCB20
	S/N: N/A

Note:

1. Above EUT list and accessory list used are electrically identical per declared by manufacturer.
2. Above the accessories list are used to exercise the EUT during test.
3. For other wireless features of this EUT, test report will be issued separately.

1.4 Modification of EUT

No modifications are made to the EUT during all test items.



1.5 Testing Location

Sporton Lab is accredited to ISO 17025 by Taiwan Accreditation Foundation (TAF code : 1190) and the FCC designation No. TW1190 and TW0007 under the FCC 2.948(e) by Mutual Recognition Agreement (MRA) in FCC Test.

Test Site	SPORTON INTERNATIONAL INC.	
Test Site Location	No. 52, Hwa Ya 1 st Rd., Hwa Ya Technology Park, Kwei-Shan District, Tao Yuan City, Taiwan, R.O.C. TEL: +886-3-327-3456 FAX: +886-3-328-4978	
Test Site No.	Sporton Site No.	
	TH05-HY	CO05-HY

Note: The test site complies with ANSI C63.4 2014 requirement.

Test Site	SPORTON INTERNATIONAL INC.	
Test Site Location	No.58, Aly. 75, Ln. 564, Wenhua 3rd Rd. Guishan Dist, Taoyuan City, Taiwan (R.O.C.) TEL: +886-3-327-0868 FAX: +886-3-327-0855	
Test Site No.	Sporton Site No.	
	03CH13-HY	

Note: The test site complies with ANSI C63.4 2014 requirement.

1.6 Applicable Standards

According to the specifications of the manufacturer, the EUT must comply with the requirements of the following standards:

- ♦ FCC Part 15 Subpart E
- ♦ FCC KDB 789033 D02 General UNII Test Procedures New Rules v01r04.
- ♦ ANSI C63.10-2013

Remark:

1. All test items were verified and recorded according to the standards and without any deviation during the test.
2. This EUT has also been tested and complied with the requirements of FCC Part 15, Subpart B, recorded in a separate test report.



2 Test Configuration of Equipment Under Test

- a. The EUT has been associated with peripherals and configuration operated in a manner tended to maximize its emission characteristics in a typical application. Frequency range investigated: conduction emission (150 kHz to 30 MHz), radiation emission (9 kHz to the 10th harmonic of the highest fundamental frequency or to 40 GHz, whichever is lower). For radiated measurement, pre-scanned in three orthogonal panels, X, Y, Z. The worst cases (Z plane) were recorded in this report.
- b. AC power line Conducted Emission was tested under maximum output power.

2.1 Carrier Frequency Channel

Frequency Band	Channel	Freq. (MHz)	Channel	Freq. (MHz)
5725-5850 MHz Band 4 (U-NII-3)	149	5745	157	5785
	151*	5755	159*	5795
	153	5765	161	5805
	155#	5775	165	5825

Note:

1. The above Frequency and Channel in "*" were 802.11n HT40 and 802.11ac VHT40.
2. The above Frequency and Channel in "#n" were 802.11ac VHT80.



2.2 Test Mode

Final test mode of conducted test items and radiated spurious emissions are considering the modulation and worse data rates as below table.

Modulation	Data Rate
802.11a	6 Mbps
802.11ac VHT20	MCS0
802.11ac VHT40	MCS0
802.11ac VHT80	MCS0

Test Cases	
AC Conducted Emission	Mode 1 : Bluetooth Link + WLAN (5GHz) Link + Earphone 1 + Battery 1 + USB Cable (Charging from Adapter 1)
Remark: For Radiated Test Cases, The tests were performance with Battery 1.	

Ch. #		Band IV : 5725-5850 MHz			
		802.11a	802.11ac VHT20	802.11ac VHT40	802.11ac VHT80
L	Low	149	149	151	-
M	Middle	157	157	-	155
H	High	165	165	159	-

2.3 Connection Diagram of Test System

<WLAN Tx Mode>

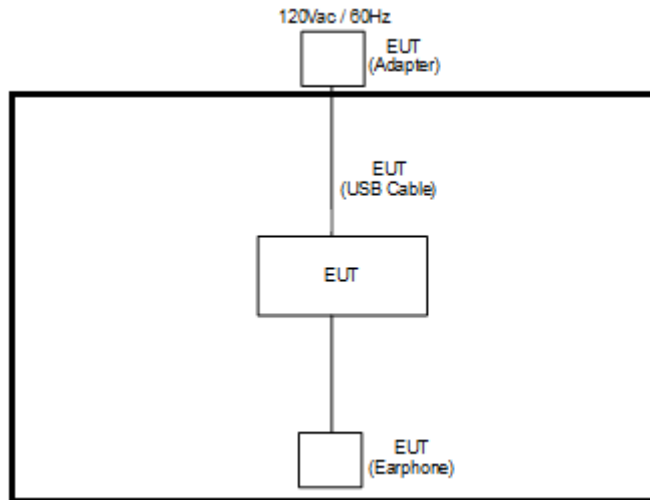

<AC Conducted Emission Mode>

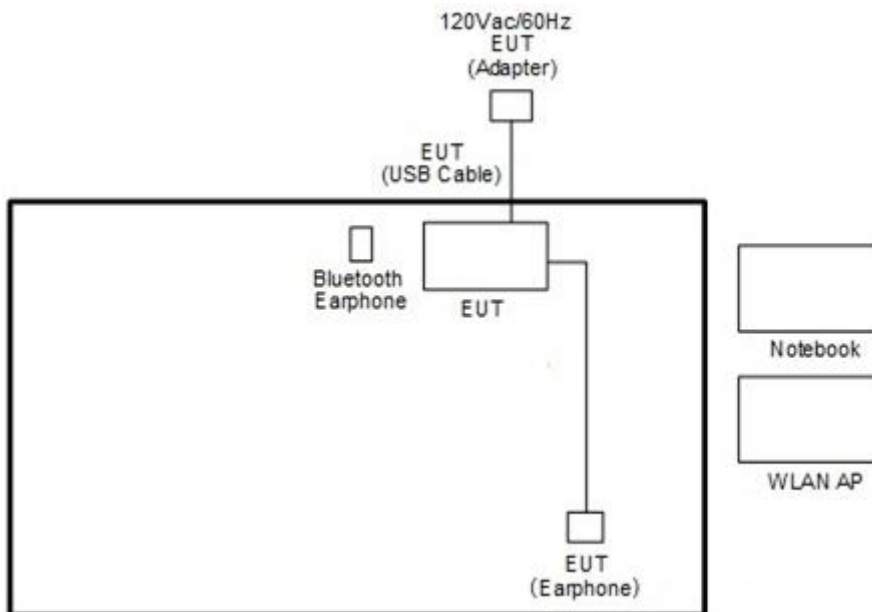



2.4 Support Unit used in test configuration and system

Item	Equipment	Trade Name	Model Name	FCC ID	Data Cable	Power Cord
1.	Bluetooth Earphone	Sony	SBH20	PY7-RD0010	N/A	N/A
2.	WLAN AP	ASUS	RT-AC66U	MSQ-RTAC66U	N/A	Unshielded, 1.8 m
3.	Notebook	DELL	Latitude E6320	FCC DoC/ Contains FCC ID: QDS-BRCM1054	N/A	AC I/P: Unshielded, 1.2 m DC O/P: Shielded, 1.8 m
4.	SD Card	SanDisk	MicroSD HC	FCC DoC	N/A	N/A

2.5 EUT Operation Test Setup

The RF test items, an engineering test program was provided and enabled to make EUT continuous transmit.

2.6 Measurement Results Explanation Example

For all conducted test items:

The offset level is set in the spectrum analyzer to compensate the RF cable loss and attenuator factor between EUT conducted output port and spectrum analyzer. With the offset compensation, the spectrum analyzer reading level is exactly the EUT RF output level.

Example :

The spectrum analyzer offset is derived from RF cable loss and attenuator factor.

Offset = RF cable loss + attenuator factor.

Following shows an offset computation example with cable loss 4.2 dB and 10dB attenuator.

$$\begin{aligned} \text{Offset(dB)} &= \text{RF cable loss(dB)} + \text{attenuator factor(dB)}. \\ &= 4.2 + 10 = 14.2 \text{ (dB)} \end{aligned}$$

3 Test Result

3.1 6dB, 26dB and 99% Occupied Bandwidth Measurement

3.1.1 Description of 6dB, 26dB & 99% Occupied Bandwidth

The minimum 6 dB bandwidth shall be at least 500 kHz.

26dB and 99% Occupied bandwidth are reporting only.

3.1.2 Measuring Instruments

The measuring equipment is listed in the section 4 of this test report.

3.1.3 Test Procedures

1. The testing follows FCC KDB 789033 D02 General UNII Test Procedures New Rules v01r04.
Section C) Emission bandwidth for the band 5.725-5.85GHz
2. Set RBW = 100kHz.
3. Set the VBW $\geq 3 \times$ RBW.
4. Detector = Peak.
5. Trace mode = max hold
6. Measure the maximum width of the emission that is 6 dB down from the peak of the emission.
7. Measure and record the results in the test report.

3.1.4 Test Setup

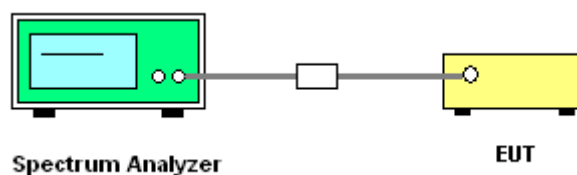



3.1.5 Test Result of 6db & 26dB & 99% Occupied Bandwidth Plots

Please refer to Appendix A.

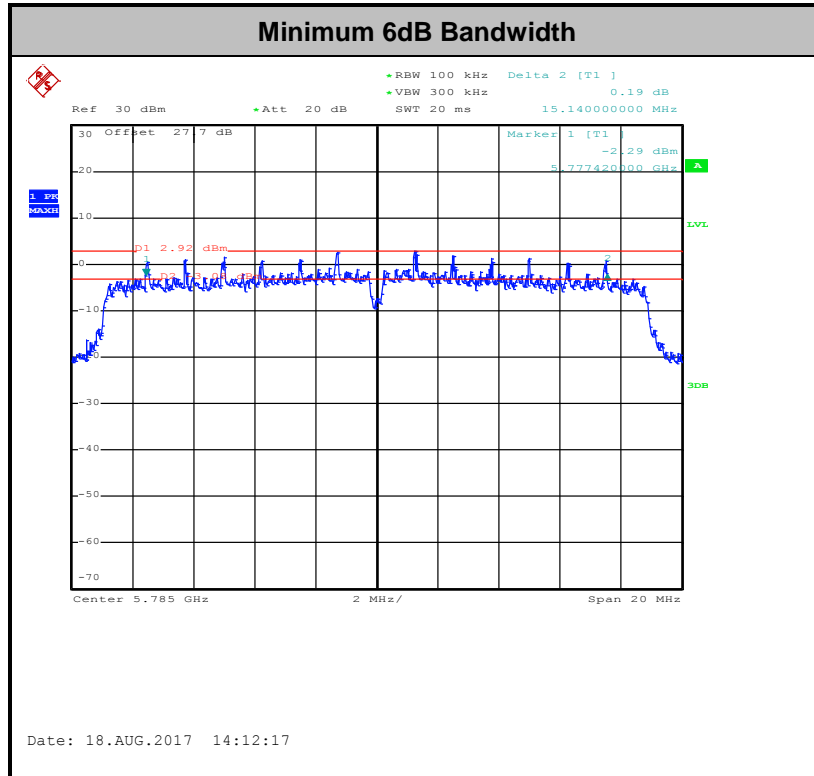

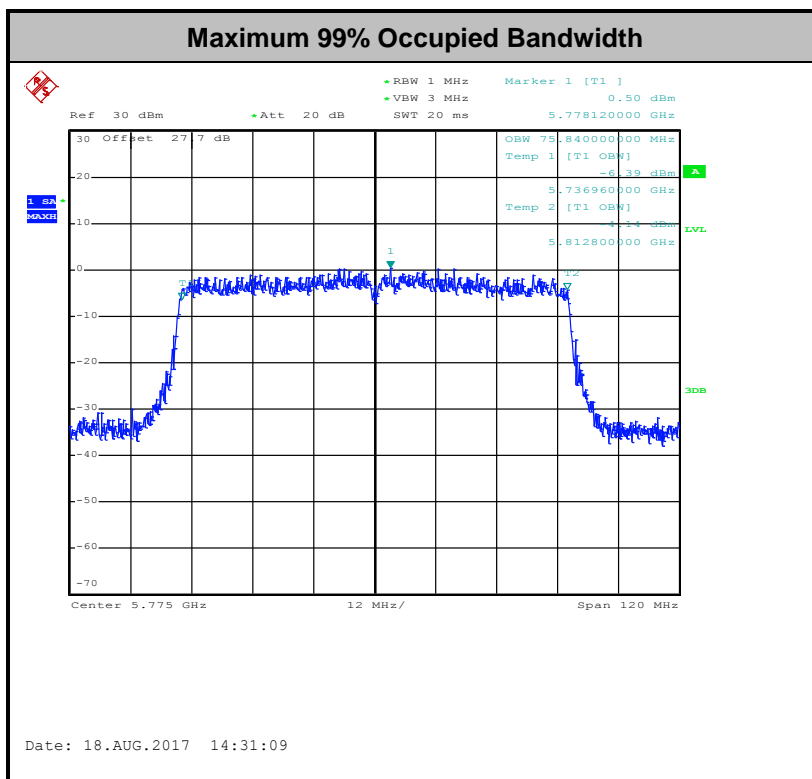
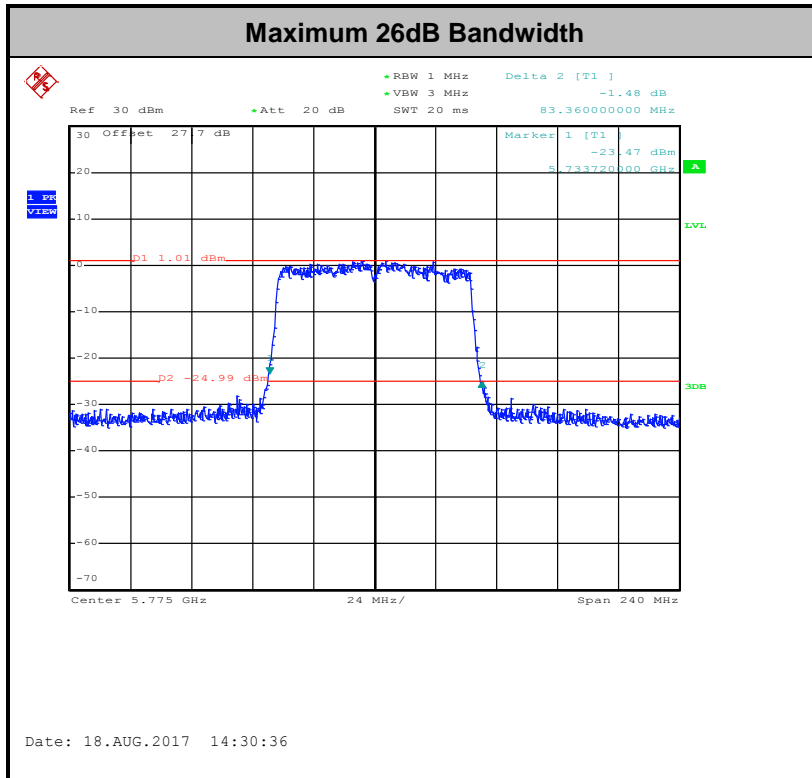

Note : The occupied channel bandwidth is maintained within the band of operation for all of the modulations.

3.2 Maximum Conducted Output Power Measurement

3.2.1 Limit of Maximum Conducted Output Power

For the band 5.725–5.85 GHz, the maximum conducted output power over the frequency band of operation shall not exceed 1 W.

If transmitting antennas of directional gain greater than 6 dBi are used, the peak output power shall be reduced by the amount in dB that the directional gain of the antenna exceeds 6 dBi.

3.2.2 Measuring Instruments

The measuring equipment is listed in the section 4 of this test report.

3.2.3 Test Procedures

The testing follows Method PM of FCC KDB 789033 D02 General UNII Test Procedures New Rules v01r04.

Method PM (Measurement using an RF average power meter):

1. Measurement is performed using a wideband RF power meter.
2. The EUT is configured to transmit continuously with a consistent duty cycle at its maximum power control level.
3. Measure the average power of the transmitter, and the average power is corrected with duty factor, $10 \log(1/x)$, where x is the duty cycle.

3.2.4 Test Setup

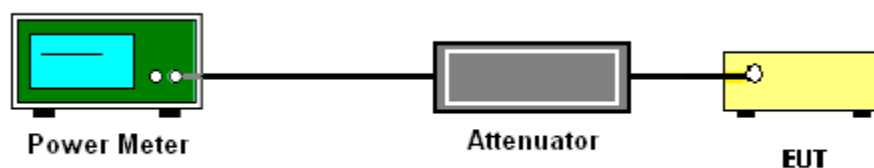

3.2.5 Test Result of Maximum Conducted Output Power

Please refer to Appendix A.



3.3 Power Spectral Density Measurement

3.3.1 Limit of Power Spectral Density

For the band 5.725–5.85 GHz, the maximum power spectral density shall not exceed 30 dBm in any 500-kHz band.

If transmitting antennas of directional gain greater than 6 dBi are used, the peak output power shall be reduced by the amount in dB that the directional gain of the antenna exceeds 6 dBi.

3.3.2 Measuring Instruments

The measuring equipment is listed in the section 4 of this test report.

3.3.3 Test Procedures

The testing follows FCC KDB 789033 D02 General UNII Test Procedures New Rules v01r04. Section F) Maximum power spectral density.

Method SA-2

(trace averaging across on and off times of the EUT transmissions, followed by duty cycle correction).

- Measure the duty cycle.
 - Set span to encompass the entire emission bandwidth (EBW) of the signal.
 - Set RBW = 1 MHz.
 - Set VBW \geq 3 MHz.
 - Number of points in sweep \geq 2 Span / RBW.
 - Sweep time = auto.
 - Detector = RMS
 - Trace average at least 100 traces in power averaging mode.
 - Add $10 \log(1/x)$, where x is the duty cycle, to the measured power in order to compute the average power during the actual transmission times. For example, add $10 \log(1/0.25) = 6$ dB if the duty cycle is 25 percent.
1. The RF output of EUT was connected to the spectrum analyzer by a low loss cable.
 2. Each plot has already offset with cable loss, and attenuator loss. Measure the PPSD and record it.

3.3.4 Test Setup

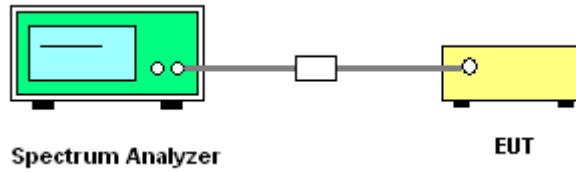

3.3.5 Test Result of Power Spectral Density

Please refer to Appendix A.

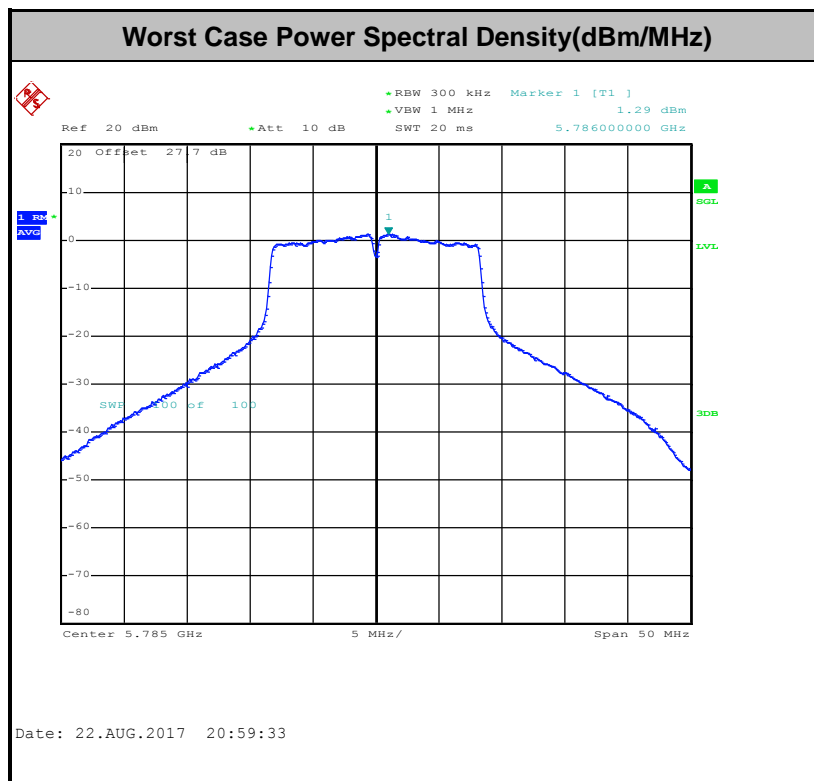

Note: Average Power Density (dB) = Measured value+ Duty Factor



3.4 Unwanted Radiated Emission Measurement

This section is to measure unwanted emissions through radiated measurement for band edge spurious emissions and out of band emissions measurement.

3.4.1 Limit of Unwanted Emissions

(1) For transmitters operating in the 5.725-5.85 GHz band:

15.407(b)(4)(i) All emissions shall be limited to a level of -27 dBm/MHz at 75 MHz or more above or below the band edge increasing linearly to 10 dBm/MHz at 25 MHz above or below the band edge, and from 25 MHz above or below the band edge increasing linearly to a level of 15.6 dBm/MHz at 5 MHz above or below the band edge, and from 5 MHz above or below the band edge increasing linearly to a level of 27 dBm/MHz at the band edge.

(2) Unwanted spurious emissions fallen in restricted bands shall comply with the general field strength limits as below table,

Frequency (MHz)	Field Strength (microvolts/meter)	Measurement Distance (meters)
0.009 – 0.490	2400/F(kHz)	300
0.490 – 1.705	24000/F(kHz)	30
1.705 – 30.0	30	30
30 – 88	100	3
88 – 216	150	3
216 - 960	200	3
Above 960	500	3

Note: The following formula is used to convert the EIRP to field strength.

$$E = \frac{1000000\sqrt{30P}}{3} \text{ } \mu\text{V/m, where P is the eirp (Watts)}$$



EIRP (dBm)	Field Strength at 3m (dBµV/m)
-17	78.3
- 27	68.3

(3) KDB789033 D02 v01r04 G)2)c)

- (i) Section 15.407(b)(1-3) specifies the unwanted emissions limit for the U-NII-1 and 2 bands. As specified, emissions above 1000 MHz that are outside of the restricted bands are subject to a peak emission limit of -27 dBm/MHz. However, an out-of-band emission that complies with both the average and peak limits of Section 15.209 is not required to satisfy the -27 dBm/MHz dBm/MHz peak emission limit.
- (ii) Section 15.407(b)(4) specifies the unwanted emissions limit for the U-NII-3 band. A band emissions mask is specified in Section 15.407(b)(4)(i). An alternative to the band emissions mask is specified in Section 15.407(b)(4)(ii). The alternative limits are based on the highest antenna gain specified in the filing. There are also marketing and importation restrictions for the alternative limit.

Note 3: An out-of-band emission that complies with both the average and peak limits of Section 15.209 is not required to satisfy the -27 dBm/MHz peak emission limit.

Note 4: Only devices with antenna gains of 10 dBi or less may be approved using the emission limits specified in Section 15.247(d) till March 2, 2018; all other devices operating in this band must use the mask specified in Section 15.407(b)(4)(i).

3.4.2 Measuring Instruments

The measuring equipment is listed in the section 4 of this test report.



3.4.3 Test Procedures

1. The testing follows FCC KDB 789033 D02 General UNII Test Procedures New Rules v01r04. Section G) Unwanted emissions measurement.

(1) Procedure for Unwanted Emissions Measurements Below 1000MHz

- RBW = 120 kHz
- VBW = 300 kHz
- Detector = Peak
- Trace mode = max hold

(2) Procedure for Peak Unwanted Emissions Measurements Above 1000 MHz

- RBW = 1 MHz
- VBW \geq 3 MHz
- Detector = Peak
- Sweep time = auto
- Trace mode = max hold

(3) Procedures for Average Unwanted Emissions Measurements Above 1000MHz

- RBW = 1 MHz
- VBW = 10 Hz, when duty cycle is no less than 98 percent.
- VBW \geq 1/T, when duty cycle is less than 98 percent where T is the minimum transmission duration over which the transmitter is on and is transmitting at its maximum power control level for the tested mode of operation.

2. The EUT was placed on a turntable with 0.8 meter for frequency below 1GHz and 1.5 meter for frequency above 1GHz respectively above ground.
3. The EUT was set 3 meters from the interference receiving antenna which was mounted on the top of a variable height antenna tower.
4. The antenna is a broadband antenna and its height is adjusted between one meter and four meters above ground to find the maximum value of the field strength for both horizontal polarization and vertical polarization of the antenna.
5. For each suspected emission, the EUT was arranged to its worst case and then adjust the antenna tower (from 1 m to 4 m) and turntable (from 0 degree to 360 degrees) to find the maximum reading.
6. For testing below 1GHz, if the emission level of the EUT in peak mode was 3 dB lower than the limit specified, then peak values of EUT will be reported, otherwise, the emissions will be repeated one by one using the CISPR quasi-peak method and reported.
7. For testing above 1GHz, the emission level of the EUT in peak mode was 20dB lower than average limit (that means the emission level in average mode also complies with the limit in average mode), then peak values of EUT will be reported, otherwise, the emissions will be measured in average mode again and reported.

3.4.4 Test Setup

For radiated emissions below 30MHz

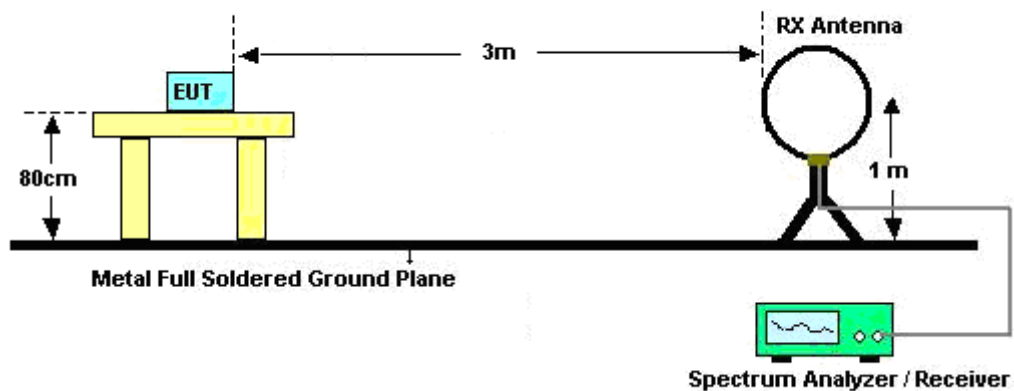

For radiated emissions from 30MHz to 1GHz

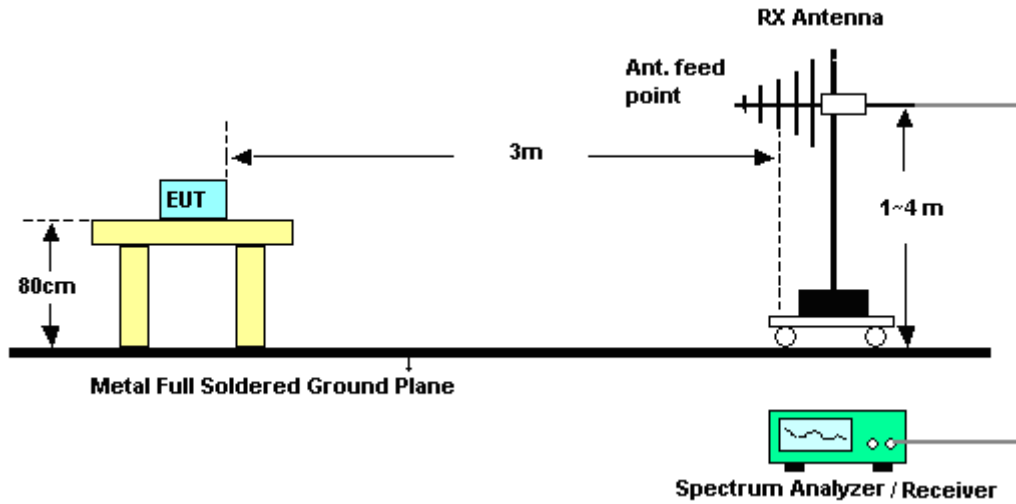

For radiated emissions above 1GHz

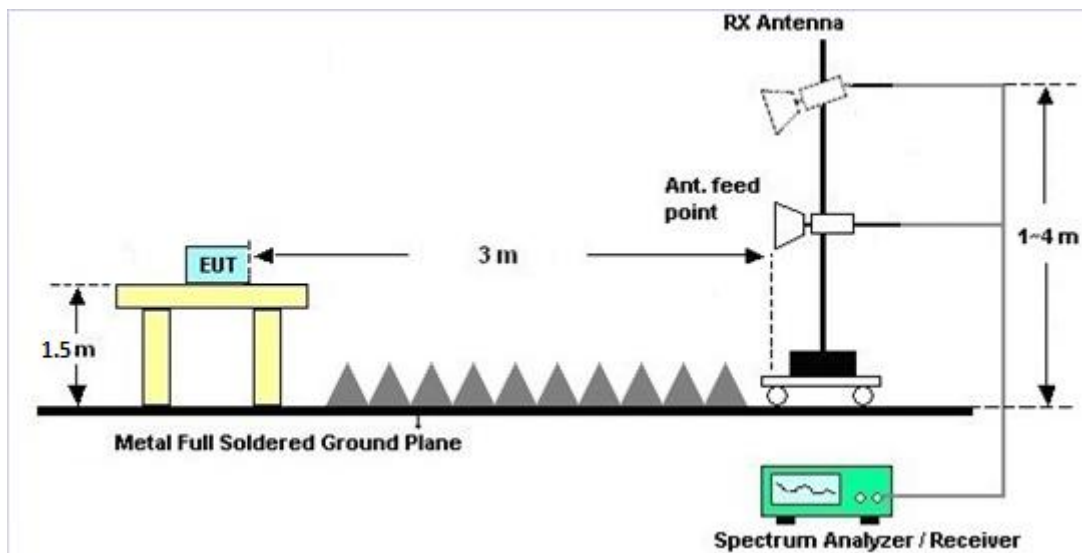



3.4.5 Test Results of Radiated Spurious Emissions (9 kHz ~ 30 MHz)

The low frequency, which started from 9 kHz to 30MHz, was pre-scanned and the result which was 20dB lower than the limit line was not reported.

There is a comparison data of both open-field test site and semi-Anechoic chamber, and the result came out very similar.

3.4.6 Test Result of Radiated Spurious at Band Edges

Please refer to Appendix C and D.

3.4.7 Duty Cycle

Please refer to Appendix E.

3.4.8 Test Result of Radiated Spurious Emissions (30MHz ~ 10th Harmonic)

Please refer to Appendix C and D.



3.5 AC Conducted Emission Measurement

3.5.1 Limit of AC Conducted Emission

For equipment that is designed to be connected to the public utility (AC) power line, the radio frequency voltage that is conducted back onto the AC power line on any frequency or frequencies within the band 150 kHz to 30 MHz shall not exceed the limits in the following table.

Frequency of emission (MHz)	Conducted limit (dB μ V)	
	Quasi-peak	Average
0.15-0.5	66 to 56*	56 to 46*
0.5-5	56	46
5-30	60	50

*Decreases with the logarithm of the frequency.

3.5.2 Measuring Instruments

The measuring equipment is listed in the section 4 of this test report.

3.5.3 Test Procedures

1. The EUT was placed 0.4 meter from the conducting wall of the shielding room was kept at least 80 centimeters from any other grounded conducting surface.
2. Connect EUT to the power mains through a line impedance stabilization network (LISN).
3. All the support units are connecting to the other LISN.
4. The LISN provides 50 ohm coupling impedance for the measuring instrument.
5. The FCC states that a 50 ohm, 50 microhenry LISN should be used.
6. Both sides of AC line were checked for maximum conducted interference.
7. The frequency range from 150 kHz to 30 MHz was searched.
8. Set the test-receiver system to Peak Detect Function and specified bandwidth with Maximum Hold Mode.

3.5.4 Test Setup

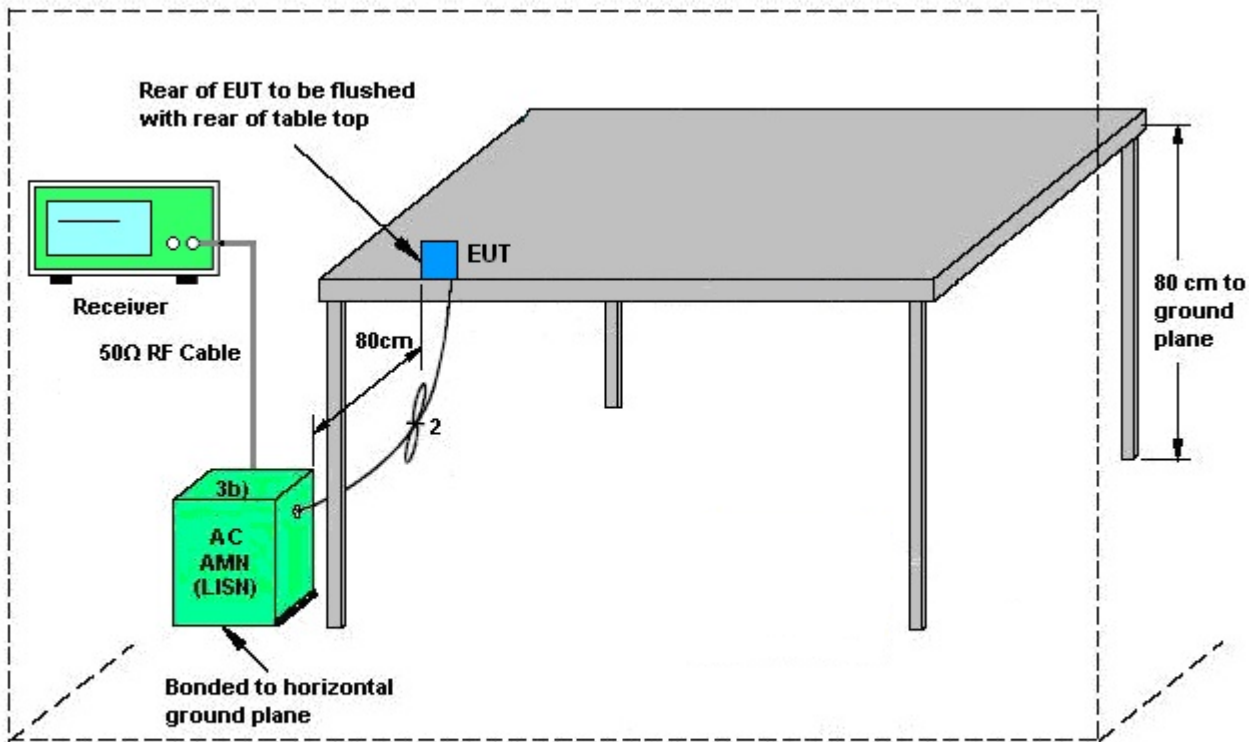

AMN = Artificial mains network (LISN)
 AE = Associated equipment
 EUT = Equipment under test
 ISN = Impedance stabilization network

3.5.5 Test Result of AC Conducted Emission

Please refer to Appendix B.

3.6 Frequency Stability Measurement

3.6.1 Limit of Frequency Stability

Manufacturers of U-NII devices are responsible for ensuring frequency stability such that an emission is maintained within the band of operation under all conditions of normal operation as specified in the user's manual.

3.6.2 Measuring Instruments

The measuring equipment is listed in the section 4 of this test report.

3.6.3 Test Procedures

1. To ensure emission at the band edge is maintained within the authorized band, those values shall be measured by radiation emissions at upper and lower frequency points, and finally compensated by frequency deviation as procedures below.
2. The EUT was operated at the maximum output power, and connected to the spectrum analyzer, which is set to maximum hold function and peak detector. The peak value of the power envelope was measured and noted. The upper and lower frequency points were respectively measured relatively 10dB lower than the measured peak value.
3. The frequency deviation was calculated by adding the upper frequency point and the lower frequency point divided by two. Those detailed values of frequency deviation are provided in table below.

3.6.4 Test Setup

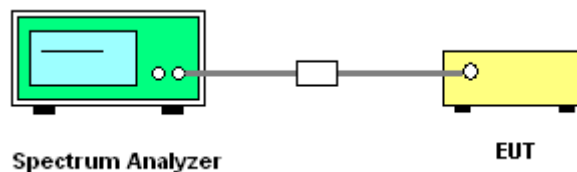

3.6.5 Test Result of Frequency Stability

Please refer to Appendix A.



3.7 Automatically Discontinue Transmission

3.7.1 Limit of Automatically Discontinue Transmission

The device shall automatically discontinue transmission in case of either absence of information to transmit or operational failure. These provisions are not intended to preclude the transmission of control or signaling information or the use of repetitive codes used by certain digital technologies to complete frame or burst intervals. Applicants shall include in their application for equipment authorization to describe how this requirement is met.

3.7.2 Measuring Instruments

The measuring equipment is listed in the section 4 of this test report.

3.7.3 Test Result of Automatically Discontinue Transmission

While the EUT is not transmitting any information, the EUT can automatically discontinue transmission and become standby mode for power saving. The EUT can detect the controlling signal of ACK message transmitting from remote device and verify whether it shall resend or discontinue transmission.



3.8 Antenna Requirements

3.8.1 Standard Applicable

If transmitting antenna directional gain is greater than 6 dBi, both the peak transmit power and the peak power spectral density shall be reduced by the amount in dB that the directional gain of the antenna exceeds 6 dBi.

3.8.2 Antenna Anti-Replacement Construction

An embedded-in antenna design is used.

3.8.3 Antenna Gain

The antenna gain is less than 6 dBi. Therefore, it is not necessary to reduce maximum peak output power limit.



4 List of Measuring Equipments

Instrument	Manufacturer	Model No.	Serial No.	Characteristics	Calibration Date	Test Date	Due Date	Remark
Power Meter	Anritsu	ML2495A	0932001	N/A	Sep. 29, 2016	Aug. 10, 2017~ Aug. 25, 2017	Sep. 28, 2017	Conducted (TH05-HY)
Power Sensor	Anritsu	MA2411B	0846202	300MHz~40GHz	Sep. 29, 2016	Aug. 10, 2017~ Aug. 25, 2017	Sep. 28, 2017	Conducted (TH05-HY)
Spectrum Analyzer	Rohde & Schwarz	FSP30	101067	9kHz ~ 30GHz	Nov. 17, 2016	Aug. 10, 2017~ Aug. 25, 2017	Nov. 16, 2017	Conducted (TH05-HY)
Hygrometer	Testo	608-H2	41410069	N/A	Aug. 28, 2016	Aug. 10, 2017~ Aug. 25, 2017	Aug. 27, 2017	Conducted (TH05-HY)
RF Cable	HUBER + SUHNER	SUCOFLEX 104	MY84209521	1GHz~26GHz	Dec. 02, 2016	Aug. 10, 2017~ Aug. 25, 2017	Dec. 01, 2017	Conducted (TH05-HY)
Temperature Chamber	ESPEC	SH-641	92013720	-40℃ ~90℃	Sep. 01, 2016	Aug. 10, 2017~ Aug. 25, 2017	Aug. 31, 2017	Conducted (TH05-HY)
AC Power Source	ChainTek	APC-1000W	N/A	N/A	N/A	Oct. 02, 2017 ~ Oct. 03, 2017	N/A	Conduction (CO05-HY)
EMI Test Receiver	Rohde & Schwarz	ESCI 7	100724	9kHz~7GHz	Sep. 20, 2017	Oct. 02, 2017 ~ Oct. 03, 2017	Sep. 19, 2018	Conduction (CO05-HY)
Hygrometer	Testo	608-H1	34913912	N/A	May 02, 2017	Oct. 02, 2017 ~ Oct. 03, 2017	May 01, 2018	Conduction (CO05-HY)
LISN	Rohde & Schwarz	ENV216	100080	9kHz~30MHz	Nov. 29, 2016	Oct. 02, 2017 ~ Oct. 03, 2017	Nov. 28, 2017	Conduction (CO05-HY)
LF Cable	HUBER + SUHNER	RG-214/U	LF01	N/A	Jan. 05, 2017	Oct. 02, 2017 ~ Oct. 03, 2017	Jan. 04, 2018	Conduction (CO05-HY)
Test Software	N/A	EMC32	8.40.0	N/A	N/A	Oct. 02, 2017 ~ Oct. 03, 2017	N/A	Conduction (CO05-HY)
Loop Antenna	Rohde & Schwarz	HFH2-Z2	100488	9 kHz~30 MHz	Oct. 20, 2016	Sep. 19, 2017 ~ Sep. 29, 2017	Oct. 19, 2018	Radiation (03CH12-HY)
Bilog Antenna	TESEQ	CBL 6111D&00800 N1D01N-06	37059&01	30MHz~1GHz	Oct. 15, 2016	Sep. 19, 2017 ~ Sep. 29, 2017	Oct. 14, 2017	Radiation (03CH12-HY)
Horn Antenna	SCHWARZBECK	BBHA 9120D	9120D-1328	1GHz ~ 18GHz	Oct. 25, 2016	Sep. 19, 2017 ~ Sep. 29, 2017	Oct. 24, 2017	Radiation (03CH12-HY)
SHF-EHF Horn Antenna	SCHWARZBECK	BBHA 9170	BBHA9170576	18GHz ~ 40GHz	Apr. 27, 2017	Sep. 19, 2017 ~ Sep. 29, 2017	Apr. 26, 2018	Radiation (03CH12-HY)
Spectrum Analyzer	Keysight	N9010A	MY54200486	10Hz ~ 44GHz	Oct. 12, 2016	Sep. 19, 2017 ~ Sep. 29, 2017	Oct. 11, 2017	Radiation (03CH12-HY)
EMI Test Receiver	Rohde & Schwarz	ESU26	100390	20Hz~26.5GHz	Dec. 23, 2016	Sep. 19, 2017 ~ Sep. 29, 2017	Dec. 22, 2017	Radiation (03CH12-HY)
Amplifier	MITEQ	TTA1840-35-HG	1871923	18GHz~40GHz, VSWR : 2.5:1 max	Jul. 18, 2017	Sep. 19, 2017 ~ Sep. 29, 2017	Jul. 17, 2018	Radiation (03CH12-HY)
Preamplifier	COM-POWER	PA-103	161075	10MHz~1GHz	Mar. 23, 2017	Sep. 19, 2017 ~ Sep. 29, 2017	Mar. 22, 2018	Radiation (03CH12-HY)
Preamplifier	MITEQ	AMF-7D-0010 1800-30-10P	1815698	1GHz~18GHz	Dec. 01, 2016	Sep. 19, 2017 ~ Sep. 29, 2017	Nov. 30, 2017	Radiation (03CH12-HY)
Preamplifier	Keysight	83017A	MY53270148	1GHz~26.5GHz	Jan. 12, 2017	Sep. 19, 2017 ~ Sep. 29, 2017	Jan. 11, 2018	Radiation (03CH12-HY)



Instrument	Manufacturer	Model No.	Serial No.	Characteristics	Calibration Date	Test Date	Due Date	Remark
Hygrometer	TECEPEL	DTM-303B	TP140349	N/A	Nov. 14, 2016	Sep. 19, 2017 ~ Sep. 29, 2017	Nov. 13, 2017	Radiation (03CH12-HY)
RF Cable	HUBER + SUHNER	SUCOFLEX 104	MY24958/4, MY28653/4, MY9839/4PE	26GHz~40GHz	Jan. 10, 2017	Sep. 19, 2017 ~ Sep. 29, 2017	Jan. 09, 2018	Radiation (03CH12-HY)
RF Cable	HUBER + SUHNER	SUCOFLEX 104	MY24958/4, MY28653/4, MY9839/4PE	1GHz~26GHz	Jan. 10, 2017	Sep. 19, 2017 ~ Sep. 29, 2017	Jan. 09, 2018	Radiation (03CH12-HY)
RF Cable	HUBER + SUHNER	SUCOFLEX 104	MY24958/4, MY28653/4, MY9839/4PE	30MHz~1GHz	Jan. 10, 2017	Sep. 19, 2017 ~ Sep. 29, 2017	Jan. 09, 2018	Radiation (03CH12-HY)
Controller	EMEC	EM1000	N/A	Control Turn table & Ant Mast	N/A	Sep. 19, 2017 ~ Sep. 29, 2017	N/A	Radiation (03CH12-HY)
Antenna Mast	EMEC	AM-BS-4500-B	N/A	1m~4m	N/A	Sep. 19, 2017 ~ Sep. 29, 2017	N/A	Radiation (03CH12-HY)
Turn Table	EMEC	TT2000	N/A	0~360 Degree	N/A	Sep. 19, 2017 ~ Sep. 29, 2017	N/A	Radiation (03CH12-HY)
Test Software	Audix	E3	6.2009-8-24	N/A	N/A	Sep. 19, 2017 ~ Sep. 29, 2017	N/A	Radiation (03CH12-HY)
Filter	Wainwright	WLKS1200-12 SS	SN2	1.2G Low Pass	Mar. 24, 2017	Sep. 19, 2017 ~ Sep. 29, 2017	Mar. 23, 2018	Radiation (03CH12-HY)
Filter	Wainwright	WHKX12-2700 -3000-18000-6 0SS	SN2	3G High Pass	Sep. 18, 2017	Sep. 19, 2017 ~ Sep. 29, 2017	Sep. 17, 2018	Radiation (03CH12-HY)
Filter	Woken	WHKX8-5272. 5-6750-18000- 40ST	SN2	6.75G Highpass	Mar. 22, 2017	Sep. 19, 2017 ~ Sep. 29, 2017	Mar. 21, 2018	Radiation (03CH12-HY)



5 Uncertainty of Evaluation

Uncertainty of Conducted Emission Measurement (150kHz ~ 30MHz)

Measuring Uncertainty for a Level of Confidence of 95% ($U = 2Uc(y)$)	2.70
---	------

Uncertainty of Radiated Emission Measurement (30 MHz ~ 1000 MHz)

Measuring Uncertainty for a Level of Confidence of 95% ($U = 2Uc(y)$)	5.10
---	------

Uncertainty of Radiated Emission Measurement (1000 MHz ~ 18000 MHz)

Measuring Uncertainty for a Level of Confidence of 95% ($U = 2Uc(y)$)	5.20
---	------

Uncertainty of Radiated Emission Measurement (18000 MHz ~ 40000 MHz)

Measuring Uncertainty for a Level of Confidence of 95% ($U = 2Uc(y)$)	4.70
---	------

Appendix A. Test Result of Conducted Test Items

Test Engineer:	Shiming Liu/Derek Hsu	Temperature:	21~25	°C
Test Date:	2017/8/10~2017/8/25	Relative Humidity:	51~54	%

TEST RESULTS DATA
6dB and 26dB EBW and 99% OBW

Band IV									
Mod.	Data Rate	NTX	CH.	Freq. (MHz)	99% Bandwidth (MHz)	26 dB Bandwidth (MHz)	6 dB Bandwidth (MHz)	6dB Bandwidth min. Limit (MHz)	Pass/Fail
11a	6M bps	1	149	5745	17.9	28.44	15.88	0.5	Pass
11a	6Mbps	1	157	5785	17.8	28.74	15.68	0.5	Pass
11a	6Mbps	1	165	5825	17.95	28.2	15.68	0.5	Pass
VHT20	MCS 0	1	149	5745	18.5	25.9	15.62	0.5	Pass
VHT20	MCS 0	1	157	5785	18.8	25.26	15.14	0.5	Pass
VHT20	MCS 0	1	165	5825	18.65	25.97	15.4	0.5	Pass
VHT40	MCS 0	1	151	5755	36.7	42.12	36.04	0.5	Pass
VHT40	MCS 0	1	159	5795	36.7	41.28	35.28	0.5	Pass
VHT80	MCS 0	1	155	5775	75.84	83.36	75.2	0.5	Pass

TEST RESULTS DATA
Average Power Table

Band IV										
Mod.	Data Rate	NTX	CH.	Freq. (MHz)	Duty Factor (dB)	Average Conducted Power (dBm)	FCC Conducted Power Limit (dBm)	DG (dBi)		Pass/Fail
11a	6M bps	1	149	5745	0.29	16.69	30.00	-4.50		Pass
11a	6Mbps	1	157	5785	0.29	16.80	30.00	-4.50		Pass
11a	6Mbps	1	165	5825	0.29	16.82	30.00	-4.50		Pass
HT20	MCS 0	1	149	5745	0.29	13.80	30.00	-4.50		Pass
HT20	MCS 0	1	157	5785	0.29	13.82	30.00	-4.50		Pass
HT20	MCS 0	1	165	5825	0.29	13.50	30.00	-4.50		Pass
HT40	MCS 0	1	151	5755	0.56	12.75	30.00	-4.50		Pass
HT40	MCS 0	1	159	5795	0.56	12.56	30.00	-4.50		Pass
VHT20	MCS 0	1	149	5745	0.31	13.82	30.00	-4.50		Pass
VHT20	MCS 0	1	157	5785	0.31	14.00	30.00	-4.50		Pass
VHT20	MCS 0	1	165	5825	0.31	13.53	30.00	-4.50		Pass
VHT40	MCS 0	1	151	5755	0.56	12.77	30.00	-4.50		Pass
VHT40	MCS 0	1	159	5795	0.56	12.58	30.00	-4.50		Pass
VHT80	MCS 0	1	155	5775	0.57	11.82	30.00	-4.50		Pass

TEST RESULTS DATA
Power Spectral Density

Band IV										
Mod.	Data Rate	NTX	CH.	Freq. (MHz)	Duty Factor (dB)	10log (500kHz /RBW) Factor (dB)	Average Power Density (dBm/500kHz)	Average PSD Limit (dBm/500kHz)	DG (dBi)	Pass/Fail
11a	6M bps	1	149	5745	0.29	2.22	3.49	30.00	-4.50	Pass
11a	6Mbps	1	157	5785	0.29	2.22	3.80	30.00	-4.50	Pass
11a	6Mbps	1	165	5825	0.29	2.22	3.74	30.00	-4.50	Pass
VHT20	MCS 0	1	149	5745	0.31	2.22	0.03	30.00	-4.50	Pass
VHT20	MCS 0	1	157	5785	0.31	2.22	-0.09	30.00	-4.50	Pass
VHT20	MCS 0	1	165	5825	0.31	2.22	-0.65	30.00	-4.50	Pass
VHT40	MCS 0	1	151	5755	0.56	2.22	-4.19	30.00	-4.50	Pass
VHT40	MCS 0	1	159	5795	0.56	2.22	-4.40	30.00	-4.50	Pass
VHT80	MCS 0	1	155	5775	0.57	2.22	-8.37	30.00	-4.50	Pass

TEST RESULTS DATA
Frequency Stability

Band IV										
Mod.	Data Rate	NTX	CH.	Freq. (MHz)	Center Frequency (MHz)	Frequency Deviation (MHz)	Frequency Stability (ppm)	Temperature (°C)	Voltage (V)	Note
11a	6M bps	1	149	5745	5745.025	0.025	4.35	55	3.85	
11a	6M bps	1	149	5745	5745.100	0.100	17.41	-30	3.85	
11a	6M bps	1	149	5745	5744.975	-0.025	-4.35	20	4.4	
11a	6M bps	1	149	5745	5745.000	0.000	0.00	20	3.4	
11a	6M bps	1	149	5745	5745.000	0.000	0.00	20	3.85	



Appendix B. AC Conducted Emission Test Results

Test Engineer :	Blue Lan	Temperature :	26~27°C
		Relative Humidity :	51~52%

EUT Information

Report NO : 760710-01
 Test Mode : Mode 1
 Test Voltage : 120Vac/60Hz
 Phase : Line

ENV216 Auto Test FCC Power Bar - L

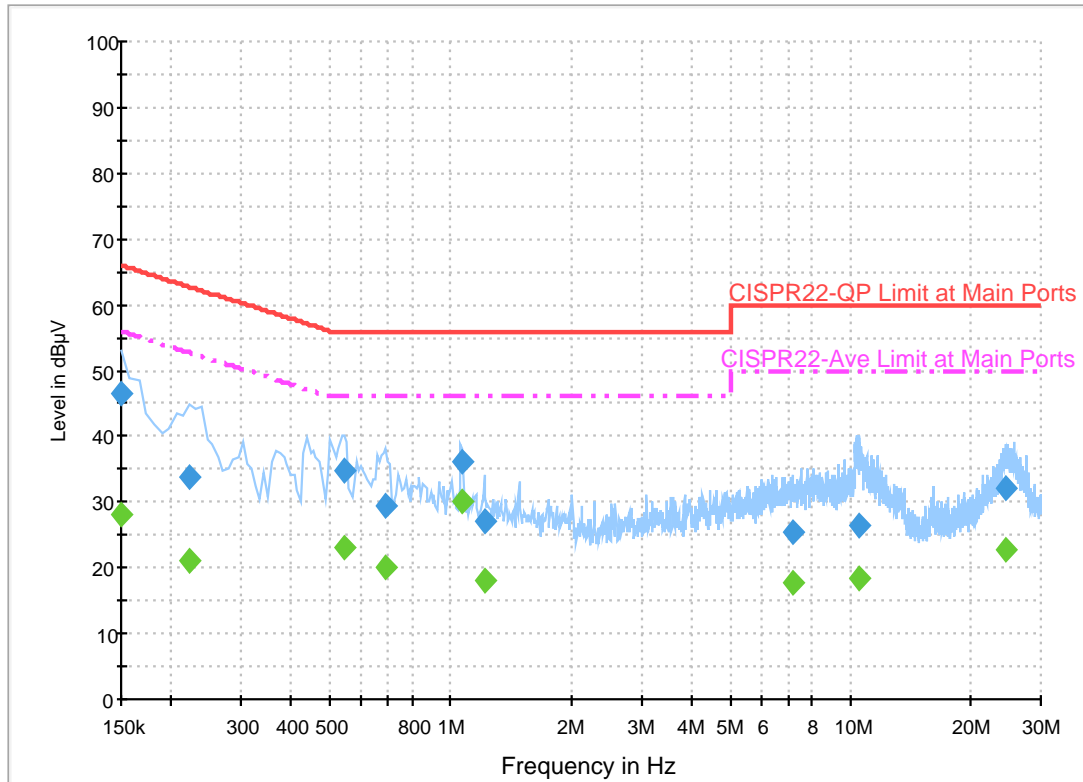

Final Result 1

Frequency (MHz)	QuasiPeak (dBµV)	Filter	Line	Corr. (dB)	Margin (dB)	Limit (dBµV)
0.150000	46.5	Off	L1	19.6	19.5	66.0
0.222000	33.7	Off	L1	19.6	29.0	62.7
0.542000	34.7	Off	L1	19.6	21.3	56.0
0.686000	29.5	Off	L1	19.6	26.5	56.0
1.070000	36.0	Off	L1	19.6	20.0	56.0
1.214000	26.9	Off	L1	19.6	29.1	56.0
7.206000	25.3	Off	L1	19.9	34.7	60.0
10.558000	26.5	Off	L1	20.1	33.5	60.0
24.494000	32.1	Off	L1	20.8	27.9	60.0

Final Result 2

Frequency (MHz)	Average (dBµV)	Filter	Line	Corr. (dB)	Margin (dB)	Limit (dBµV)
0.150000	28.0	Off	L1	19.6	28.0	56.0
0.222000	21.1	Off	L1	19.6	31.6	52.7
0.542000	23.0	Off	L1	19.6	23.0	46.0
0.686000	20.2	Off	L1	19.6	25.8	46.0
1.070000	30.0	Off	L1	19.6	16.0	46.0
1.214000	18.0	Off	L1	19.6	28.0	46.0
7.206000	17.7	Off	L1	19.9	32.3	50.0
10.558000	18.5	Off	L1	20.1	31.5	50.0
24.494000	22.8	Off	L1	20.8	27.2	50.0

EUT Information

Report NO : 760710-01
 Test Mode : Mode 1
 Test Voltage : 120Vac/60Hz
 Phase : Neutral

ENV216 Auto Test FCC Power Bar - N

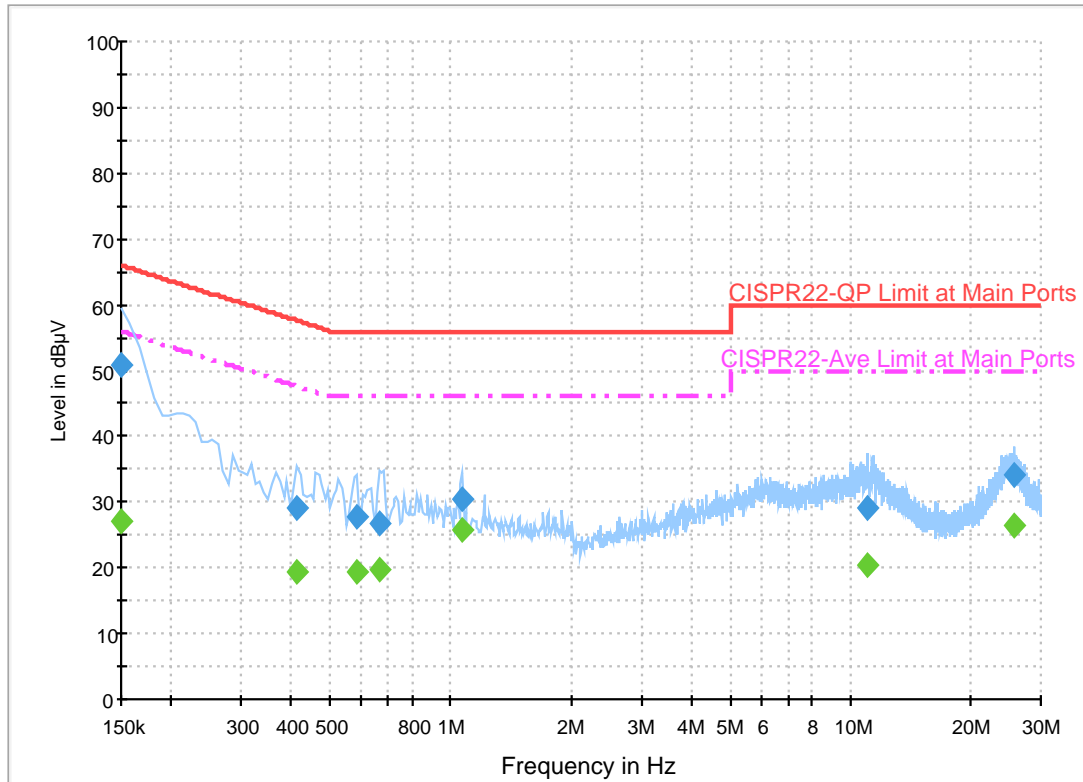

Final Result 1

Frequency (MHz)	QuasiPeak (dBµV)	Filter	Line	Corr. (dB)	Margin (dB)	Limit (dBµV)
0.150000	50.7	Off	N	19.5	15.3	66.0
0.414000	29.2	Off	N	19.5	28.4	57.6
0.582000	27.9	Off	N	19.5	28.1	56.0
0.662000	26.8	Off	N	19.5	29.2	56.0
1.070000	30.5	Off	N	19.6	25.5	56.0
11.054000	29.1	Off	N	20.1	30.9	60.0
25.598000	34.2	Off	N	21.0	25.8	60.0

Final Result 2

Frequency (MHz)	Average (dBµV)	Filter	Line	Corr. (dB)	Margin (dB)	Limit (dBµV)
0.150000	27.1	Off	N	19.5	28.9	56.0
0.414000	19.4	Off	N	19.5	28.2	47.6
0.582000	19.3	Off	N	19.5	26.7	46.0
0.662000	19.8	Off	N	19.5	26.2	46.0
1.070000	25.8	Off	N	19.6	20.2	46.0
11.054000	20.4	Off	N	20.1	29.6	50.0
25.598000	26.3	Off	N	21.0	23.7	50.0



Appendix C. Radiated Spurious Emission

Test Engineer :	Nick Yu / Peter Liao / Ray Chen	Temperature :	23~25°C
		Relative Humidity :	61~63%

Band 4 - 5725~5850MHz

WIFI 802.11a (Band Edge @ 3m)

WIFI Ant. 1	Note	Frequency (MHz)	Level (dBμV/m)	Over Limit (dB)	Limit Line (dBμV/m)	Read Level (dBμV)	Antenna Factor (dB/m)	Cable Loss (dB)	Preamp Factor (dB)	Ant Pos (cm)	Table Pos (deg)	Peak Avg. (P/A)	Pol. (H/V)	
802.11a CH 149 5745MHz		5638.6	49.45	-18.75	68.2	41.31	32.79	6.35	31	102	72	P	H	
		5685.2	50.65	-43.63	94.28	42.38	32.92	6.36	31.01	102	72	P	H	
		5720	58.84	-51.96	110.8	50.47	33.02	6.37	31.02	102	72	P	H	
		5724.6	70.16	-51.13	121.29	61.78	33.03	6.37	31.02	102	72	P	H	
	*	5745	107.83	-	-	99.4	33.09	6.37	31.03	102	72	P	H	
	*	5745	96.62	-	-	88.19	33.09	6.37	31.03	102	72	A	H	
														H
														H
			5644.6	49.82	-18.38	68.2	41.67	32.8	6.35	31	100	31	P	V
			5677.6	51.13	-37.53	88.66	42.89	32.9	6.35	31.01	100	31	P	V
			5719.8	56.65	-54.09	110.74	48.28	33.02	6.37	31.02	100	31	P	V
			5724.8	65.51	-56.23	121.74	57.13	33.03	6.37	31.02	100	31	P	V
	*		5745	104.4	-	-	95.97	33.09	6.37	31.03	100	31	P	V
	*		5745	93.34	-	-	84.91	33.09	6.37	31.03	100	31	A	V
														V
													V	



WIFI Ant. 1	Note	Frequency (MHz)	Level (dBμV/m)	Over Limit (dB)	Limit Line (dBμV/m)	Read Level (dBμV)	Antenna Factor (dB/m)	Cable Loss (dB)	Preamp Factor (dB)	Ant Pos (cm)	Table Pos (deg)	Peak Avg. (P/A)	Pol. (H/V)
		5616	49.16	-19.04	68.2	41.09	32.72	6.34	30.99	109	77	P	H
		5650.6	49.71	-18.94	68.65	41.54	32.82	6.35	31	109	77	P	H
		5719.6	50.36	-60.33	110.69	42	33.01	6.37	31.02	109	77	P	H
		5723.6	51.02	-67.99	119.01	42.64	33.03	6.37	31.02	109	77	P	H
	*	5785	107.75	-	-	99.22	33.2	6.38	31.05	109	77	P	H
	*	5785	96.91	-	-	88.38	33.2	6.38	31.05	109	77	A	H
		5855	50.63	-60.17	110.8	41.88	33.39	6.42	31.06	109	77	P	H
		5856.6	50.84	-59.51	110.35	42.08	33.4	6.42	31.06	109	77	P	H
		5907.2	50.42	-30.92	81.34	41.5	33.54	6.46	31.08	109	77	P	H
		5937.4	51.03	-17.17	68.2	42.02	33.62	6.48	31.09	109	77	P	H
													H
													H
802.11a													
CH 157													
5785MHz		5643.8	49.75	-18.45	68.2	41.6	32.8	6.35	31	100	20	P	V
		5684.6	50.46	-43.38	93.84	42.19	32.92	6.36	31.01	100	20	P	V
		5708	50.32	-57.12	107.44	42	32.98	6.36	31.02	100	20	P	V
		5723.2	50.82	-67.28	118.1	42.45	33.02	6.37	31.02	100	20	P	V
	*	5785	101.41	-	-	92.88	33.2	6.38	31.05	100	20	P	V
	*	5785	90.76	-	-	82.23	33.2	6.38	31.05	100	20	A	V
		5852.2	49.34	-67.84	117.18	40.59	33.39	6.42	31.06	100	20	P	V
		5864	50.06	-58.22	108.28	41.28	33.42	6.43	31.07	100	20	P	V
		5884	50.42	-48.1	98.52	41.58	33.48	6.44	31.08	100	20	P	V
		5942.2	50.77	-17.43	68.2	41.74	33.64	6.48	31.09	100	20	P	V
													V
													V



WiFi Ant. 1	Note	Frequency (MHz)	Level (dBμV/m)	Over Limit (dB)	Limit Line (dBμV/m)	Read Level (dBμV)	Antenna Factor (dB/m)	Cable Loss (dB)	Preamp Factor (dB)	Ant Pos (cm)	Table Pos (deg)	Peak Avg. (P/A)	Pol. (H/V)	
802.11a CH 165 5825MHz	*	5825	109.17	-	-	100.52	33.31	6.39	31.05	111	77	P	H	
	*	5825	98.19	-	-	89.54	33.31	6.39	31.05	111	77	A	H	
		5850	60.89	-61.31	122.2	52.15	33.38	6.42	31.06	111	77	P	H	
		5859	53.67	-56.01	109.68	44.91	33.41	6.42	31.07	111	77	P	H	
		5875.6	51.98	-52.77	104.75	43.17	33.45	6.43	31.07	111	77	P	H	
		5931.8	50.62	-17.58	68.2	41.63	33.61	6.47	31.09	111	77	P	H	
														H
														H
	*	5825	101.4	-	-	92.75	33.31	6.39	31.05	100	25	P	V	
	*	5825	89.96	-	-	81.31	33.31	6.39	31.05	100	25	A	V	
		5850.4	52.33	-68.96	121.29	43.59	33.38	6.42	31.06	100	25	P	V	
		5862	50.43	-58.41	108.84	41.66	33.41	6.43	31.07	100	25	P	V	
		5904.6	50.57	-32.69	83.26	41.66	33.53	6.46	31.08	100	25	P	V	
		5947.6	50.05	-18.15	68.2	41.01	33.65	6.48	31.09	100	25	P	V	
														V
														V
														V
Remark	1. No other spurious found. 2. All results are PASS against Peak and Average limit line.													



Band 4 5725~5850MHz
WIFI 802.11a (Harmonic @ 3m)

WIFI Ant. 1	Note	Frequency (MHz)	Level (dBμV/m)	Over Limit (dB)	Limit Line (dBμV/m)	Read Level (dBμV)	Antenna Factor (dB/m)	Cable Loss (dB)	Preamp Factor (dB)	Ant Pos (cm)	Table Pos (deg)	Peak Avg. (P/A)	Pol. (H/V)	
802.11a CH 149 5745MHz		11490	48.5	-25.5	74	55.54	40.2	9.82	57.57	100	0	P	H	
		17235	52.72	-15.48	68.2	54.9	41.92	12.09	56.83	100	0	P	H	
													H	
													H	
			11490	48.06	-25.94	74	55.1	40.2	9.82	57.57	100	0	P	V
			17235	54.35	-13.85	68.2	56.53	41.92	12.09	56.83	100	0	P	V
														V
														V
802.11a CH 157 5785MHz		11570	47.55	-26.45	74	54.72	40.06	9.86	57.6	100	0	P	H	
		17355	51.96	-16.24	68.2	54.26	42.18	12.19	57.3	100	0	P	H	
													H	
													H	
			11570	47.12	-26.88	74	54.29	40.06	9.86	57.6	100	0	P	V
			17355	53.91	-14.29	68.2	56.21	42.18	12.19	57.3	100	0	P	V
														V
														V
802.11a CH 165 5825MHz		11650	48.2	-25.8	74	55.49	39.9	9.9	57.6	100	0	P	H	
		17475	51.57	-16.63	68.2	53.99	42.44	12.29	57.77	100	0	P	H	
													H	
													H	
			11650	47.55	-26.45	74	54.84	39.9	9.9	57.6	100	0	P	V
			17475	51.16	-17.04	68.2	53.58	42.44	12.29	57.77	100	0	P	V
														V
														V
Remark	1. No other spurious found. 2. All results are PASS against Peak and Average limit line.													



Band 4 5725~5850MHz
WIFI 802.11ac VHT20 (Band Edge @ 3m)

WIFI Ant. 1	Note	Frequency (MHz)	Level (dBμV/m)	Over Limit (dB)	Limit Line (dBμV/m)	Read Level (dBμV)	Antenna Factor (dB/m)	Cable Loss (dB)	Preamp Factor (dB)	Ant Pos (cm)	Table Pos (deg)	Peak Avg. (P/A)	Pol. (H/V)	
802.11ac VHT20 CH 149 5745MHz		5603	50.12	-18.08	68.2	42.08	32.69	6.34	30.99	100	73	P	H	
		5696.6	50.62	-52.07	102.69	42.32	32.95	6.36	31.01	100	73	P	H	
		5720	55.91	-54.89	110.8	47.54	33.02	6.37	31.02	100	73	P	H	
		5725	62.59	-59.61	122.2	54.21	33.03	6.37	31.02	100	73	P	H	
	*	5745	105.84	-	-	97.41	33.09	6.37	31.03	100	73	P	H	
	*	5745	94.58	-	-	86.15	33.09	6.37	31.03	100	73	A	H	
														H
														H
			5646.6	49.41	-18.79	68.2	41.25	32.81	6.35	31	116	17	P	V
			5678.4	50.05	-39.21	89.26	41.81	32.9	6.35	31.01	116	17	P	V
			5719	52.3	-58.22	110.52	43.94	33.01	6.37	31.02	116	17	P	V
			5725	59.23	-62.97	122.2	50.85	33.03	6.37	31.02	116	17	P	V
	*		5745	101.69	-	-	93.26	33.09	6.37	31.03	116	17	P	V
	*		5745	90.46	-	-	82.03	33.09	6.37	31.03	116	17	A	V
													V	
													V	



WIFI Ant. 1	Note	Frequency (MHz)	Level (dBμV/m)	Over Limit (dB)	Limit Line (dBμV/m)	Read Level (dBμV)	Antenna Factor (dB/m)	Cable Loss (dB)	Preamp Factor (dB)	Ant Pos (cm)	Table Pos (deg)	Peak Avg. (P/A)	Pol. (H/V)
		5640.6	49.05	-19.15	68.2	40.91	32.79	6.35	31	100	72	P	H
		5655.8	51.09	-21.42	72.51	42.91	32.84	6.35	31.01	100	72	P	H
		5717.4	49.74	-60.33	110.07	41.39	33.01	6.36	31.02	100	72	P	H
		5722.8	50.9	-66.28	117.18	42.53	33.02	6.37	31.02	100	72	P	H
	*	5785	106.23	-	-	97.7	33.2	6.38	31.05	100	72	P	H
	*	5785	94.74	-	-	86.21	33.2	6.38	31.05	100	72	A	H
		5851.8	50.55	-67.55	118.1	41.8	33.39	6.42	31.06	100	72	P	H
		5858.4	51.07	-58.78	109.85	42.32	33.4	6.42	31.07	100	72	P	H
		5889.4	50.57	-43.94	94.51	41.72	33.49	6.44	31.08	100	72	P	H
		5926.6	51.27	-16.93	68.2	42.3	33.59	6.47	31.09	100	72	P	H
802.11ac													H
VHT20													H
CH 157		5611.2	49.79	-18.41	68.2	41.73	32.71	6.34	30.99	285	286	P	V
5785MHz		5689.4	49.62	-47.76	97.38	41.34	32.93	6.36	31.01	285	286	P	V
		5703	49.78	-56.26	106.04	41.46	32.97	6.36	31.01	285	286	P	V
		5721.4	50.38	-63.61	113.99	42.01	33.02	6.37	31.02	285	286	P	V
	*	5785	100.63	-	-	92.1	33.2	6.38	31.05	285	286	P	V
	*	5785	89.41	-	-	80.88	33.2	6.38	31.05	285	286	A	V
		5853.8	49.65	-63.89	113.54	40.9	33.39	6.42	31.06	285	286	P	V
		5859	51.02	-58.66	109.68	42.26	33.41	6.42	31.07	285	286	P	V
		5907.8	51.19	-29.7	80.89	42.27	33.54	6.46	31.08	285	286	P	V
		5949.8	51.02	-17.18	68.2	41.97	33.66	6.48	31.09	285	286	P	V
													V
													V



WIFI Ant. 1	Note	Frequency (MHz)	Level (dBμV/m)	Over Limit (dB)	Limit Line (dBμV/m)	Read Level (dBμV)	Antenna Factor (dB/m)	Cable Loss (dB)	Preamp Factor (dB)	Ant Pos (cm)	Table Pos (deg)	Peak Avg. (P/A)	Pol. (H/V)	
802.11ac VHT20 CH 165 5825MHz	*	5825	106.91	-	-	98.26	33.31	6.39	31.05	100	70	P	H	
	*	5825	95.6	-	-	86.95	33.31	6.39	31.05	100	70	A	H	
		5850.8	54.28	-66.1	120.38	45.54	33.38	6.42	31.06	100	70	P	H	
		5863	52.44	-56.12	108.56	43.66	33.42	6.43	31.07	100	70	P	H	
		5881.8	51.76	-48.39	100.15	42.92	33.47	6.44	31.07	100	70	P	H	
		5948.2	50.47	-17.73	68.2	41.43	33.65	6.48	31.09	100	70	P	H	
														H
														H
	*	5825	100.31	-	-	91.66	33.31	6.39	31.05	299	287	P	V	
	*	5825	88.91	-	-	80.26	33.31	6.39	31.05	299	287	A	V	
		5850.4	51.16	-70.13	121.29	42.42	33.38	6.42	31.06	299	287	P	V	
		5856.2	50.21	-60.25	110.46	41.45	33.4	6.42	31.06	299	287	P	V	
		5919.4	51.25	-21.08	72.33	42.3	33.57	6.47	31.09	299	287	P	V	
		5941	50.85	-17.35	68.2	41.83	33.63	6.48	31.09	299	287	P	V	
														V
													V	
Remark	1. No other spurious found. 2. All results are PASS against Peak and Average limit line.													



Band 4 5725~5850MHz
WIFI 802.11ac VHT20 (Harmonic @ 3m)

WIFI Ant. 1	Note	Frequency (MHz)	Level (dBμV/m)	Over Limit (dB)	Limit Line (dBμV/m)	Read Level (dBμV)	Antenna Factor (dB/m)	Cable Loss (dB)	Preamp Factor (dB)	Ant Pos (cm)	Table Pos (deg)	Peak Avg. (P/A)	Pol. (H/V)	
802.11ac VHT20 CH 149 5745MHz		11490	48.17	-25.83	74	55.21	40.2	9.82	57.57	100	0	P	H	
		17235	49.98	-18.22	68.2	52.16	41.92	12.09	56.83	100	0	P	H	
													H	
													H	
			11490	46.7	-27.3	74	53.74	40.2	9.82	57.57	100	0	P	V
			17235	49.66	-18.54	68.2	51.84	41.92	12.09	56.83	100	0	P	V
														V
802.11ac VHT20 CH 157 5785MHz		11570	47.83	-26.17	74	55	40.06	9.86	57.6	100	0	P	H	
		17355	49.03	-19.17	68.2	51.33	42.18	12.19	57.3	100	0	P	H	
													H	
													H	
			11570	47.89	-26.11	74	55.06	40.06	9.86	57.6	100	0	P	V
			17355	49.43	-18.77	68.2	51.73	42.18	12.19	57.3	100	0	P	V
														V
802.11ac VHT20 CH 165 5825MHz		11650	47.15	-26.85	74	54.44	39.9	9.9	57.6	100	0	P	H	
		17475	48.82	-19.38	68.2	51.24	42.44	12.29	57.77	100	0	P	H	
													H	
													H	
			11650	47.94	-26.06	74	55.23	39.9	9.9	57.6	100	0	P	V
			17475	48.11	-20.09	68.2	50.53	42.44	12.29	57.77	100	0	P	V
														V
Remark	1. No other spurious found.													
	2. All results are PASS against Peak and Average limit line.													



Band 4 5725~5850MHz
WIFI 802.11ac VHT40 (Band Edge @ 3m)

WIFI Ant. 1	Note	Frequency (MHz)	Level (dBμV/m)	Over Limit (dB)	Limit Line (dBμV/m)	Read Level (dBμV)	Antenna Factor (dB/m)	Cable Loss (dB)	Preamp Factor (dB)	Ant Pos (cm)	Table Pos (deg)	Peak Avg. (P/A)	Pol. (H/V)
		5647.6	49.42	-18.78	68.2	41.26	32.81	6.35	31	100	64	P	H
		5697.4	50.97	-52.31	103.28	42.67	32.95	6.36	31.01	100	64	P	H
		5719.6	61.31	-49.38	110.69	52.95	33.01	6.37	31.02	100	64	P	H
		5723.4	62.33	-56.22	118.55	53.95	33.03	6.37	31.02	100	64	P	H
	*	5755	101.97	-	-	93.52	33.11	6.37	31.03	100	64	P	H
	*	5755	91.02	-	-	82.57	33.11	6.37	31.03	100	64	A	H
		5852.4	50.44	-66.29	116.73	41.69	33.39	6.42	31.06	100	64	P	H
		5861.2	49.9	-59.16	109.06	41.14	33.41	6.42	31.07	100	64	P	H
		5883.6	50.74	-48.07	98.81	41.91	33.47	6.44	31.08	100	64	P	H
		5925.4	50.95	-17.25	68.2	41.98	33.59	6.47	31.09	100	64	P	H
													H
													H
802.11ac													
VHT40													
CH 151		5643.6	49.92	-18.28	68.2	41.77	32.8	6.35	31	287	277	P	V
5755MHz		5699.8	50.56	-54.49	105.05	42.25	32.96	6.36	31.01	287	277	P	V
		5715	57.1	-52.3	109.4	48.76	33	6.36	31.02	287	277	P	V
		5722.8	57.76	-59.42	117.18	49.39	33.02	6.37	31.02	287	277	P	V
	*	5755	96.98	-	-	88.53	33.11	6.37	31.03	287	277	P	V
	*	5755	85.8	-	-	77.35	33.11	6.37	31.03	287	277	A	V
		5853.2	50.21	-64.69	114.9	41.46	33.39	6.42	31.06	287	277	P	V
		5867	49.92	-57.52	107.44	41.13	33.43	6.43	31.07	287	277	P	V
		5886	50.56	-46.47	97.03	41.72	33.48	6.44	31.08	287	277	P	V
		5935	50.29	-17.91	68.2	41.28	33.62	6.48	31.09	287	277	P	V
													V
													V



WIFI Ant. 1	Note	Frequency (MHz)	Level (dBμV/m)	Over Limit (dB)	Limit Line (dBμV/m)	Read Level (dBμV)	Antenna Factor (dB/m)	Cable Loss (dB)	Preamp Factor (dB)	Ant Pos (cm)	Table Pos (deg)	Peak Avg. (P/A)	Pol. (H/V)
		5615	49.54	-18.66	68.2	41.47	32.72	6.34	30.99	107	65	P	H
		5686	49.85	-45.02	94.87	41.58	32.92	6.36	31.01	107	65	P	H
		5719.2	50.68	-59.9	110.58	42.32	33.01	6.37	31.02	107	65	P	H
		5724.2	49.81	-70.57	120.38	41.43	33.03	6.37	31.02	107	65	P	H
	*	5795	102.09	-	-	93.53	33.23	6.38	31.05	107	65	P	H
	*	5795	91.53	-	-	82.97	33.23	6.38	31.05	107	65	A	H
		5852.4	51.68	-65.05	116.73	42.93	33.39	6.42	31.06	107	65	P	H
		5858.2	51.03	-58.87	109.9	42.28	33.4	6.42	31.07	107	65	P	H
		5886.8	51.81	-44.63	96.44	42.97	33.48	6.44	31.08	107	65	P	H
		5943.8	50.26	-17.94	68.2	41.23	33.64	6.48	31.09	107	65	P	H
802.11ac													H
VHT40													H
CH 159		5619.2	49.83	-18.37	68.2	41.75	32.73	6.34	30.99	287	288	P	V
5795MHz		5657.6	49.88	-23.97	73.85	41.7	32.84	6.35	31.01	287	288	P	V
		5712	49.81	-58.75	108.56	41.48	32.99	6.36	31.02	287	288	P	V
		5724.6	50.11	-71.18	121.29	41.73	33.03	6.37	31.02	287	288	P	V
	*	5795	96.59	-	-	88.03	33.23	6.38	31.05	287	288	P	V
	*	5795	85.87	-	-	77.31	33.23	6.38	31.05	287	288	A	V
		5854.4	49.58	-62.59	112.17	40.83	33.39	6.42	31.06	287	288	P	V
		5872.8	51.14	-54.68	105.82	42.34	33.44	6.43	31.07	287	288	P	V
		5915.4	50.41	-24.87	75.28	41.47	33.56	6.47	31.09	287	288	P	V
		5928.2	50.39	-17.81	68.2	41.41	33.6	6.47	31.09	287	288	P	V
													V
													V
Remark	1. No other spurious found. 2. All results are PASS against Peak and Average limit line.												



Band 4 5725~5850MHz
WIFI 802.11ac VHT40 (Harmonic @ 3m)

WIFI Ant. 1	Note	Frequency (MHz)	Level (dBμV/m)	Over Limit (dB)	Limit Line (dBμV/m)	Read Level (dBμV)	Antenna Factor (dB/m)	Cable Loss (dB)	Preamp Factor (dB)	Ant Pos (cm)	Table Pos (deg)	Peak Avg. (P/A)	Pol. (H/V)	
802.11ac VHT40 CH 151 5755MHz		11510	47.66	-26.34	74	54.74	40.18	9.83	57.6	100	0	P	H	
		17265	50.22	-17.98	68.2	52.46	41.98	12.11	56.97	100	0	P	H	
													H	
													H	
			11510	47.52	-26.48	74	54.6	40.18	9.83	57.6	100	0	P	V
			17265	50.12	-18.08	68.2	52.36	41.98	12.11	56.97	100	0	P	V
														V
														V
802.11ac VHT40 CH 159 5795MHz		11590	48.01	-25.99	74	55.21	40.02	9.87	57.6	100	0	P	H	
		17385	49.27	-18.93	68.2	51.61	42.25	12.21	57.43	100	0	P	H	
													H	
													H	
			11590	48.2	-25.8	74	55.4	40.02	9.87	57.6	100	0	P	V
			17385	49.39	-18.81	68.2	51.73	42.25	12.21	57.43	100	0	P	V
														V
														V
Remark	1. No other spurious found. 2. All results are PASS against Peak and Average limit line.													



Band 4 5725~5850MHz
WIFI 802.11ac VHT80 (Band Edge @ 3m)

WIFI Ant. 1	Note	Frequency (MHz)	Level (dBμV/m)	Over Limit (dB)	Limit Line (dBμV/m)	Read Level (dBμV)	Antenna Factor (dB/m)	Cable Loss (dB)	Preamp Factor (dB)	Ant Pos (cm)	Table Pos (deg)	Peak Avg. (P/A)	Pol. (H/V)
		5647.4	50.23	-17.97	68.2	42.07	32.81	6.35	31	105	78	P	H
		5700	55.89	-49.31	105.2	47.58	32.96	6.36	31.01	105	78	P	H
		5719	60.57	-49.95	110.52	52.21	33.01	6.37	31.02	105	78	P	H
		5722	59.88	-55.48	115.36	51.51	33.02	6.37	31.02	105	78	P	H
	*	5775	97.57	-	-	89.06	33.17	6.38	31.04	105	78	P	H
	*	5775	86.94	-	-	78.43	33.17	6.38	31.04	105	78	A	H
		5851.2	57.43	-62.03	119.46	48.69	33.38	6.42	31.06	105	78	P	H
		5856.4	57.45	-52.96	110.41	48.69	33.4	6.42	31.06	105	78	P	H
		5875.2	52.74	-52.31	105.05	43.93	33.45	6.43	31.07	105	78	P	H
		5941.4	50.42	-17.78	68.2	41.39	33.64	6.48	31.09	105	78	P	H
802.11ac													H
VHT80													H
CH 155		5621.6	49.26	-18.94	68.2	41.17	32.74	6.34	30.99	102	17	P	V
5775MHz		5700	53.65	-51.55	105.2	45.34	32.96	6.36	31.01	102	17	P	V
		5715.6	57.29	-52.28	109.57	48.95	33	6.36	31.02	102	17	P	V
		5720.4	57.49	-54.22	111.71	49.12	33.02	6.37	31.02	102	17	P	V
	*	5775	92.82	-	-	84.31	33.17	6.38	31.04	102	17	P	V
	*	5775	81.22	-	-	72.71	33.17	6.38	31.04	102	17	A	V
		5854.4	49.38	-62.79	112.17	40.63	33.39	6.42	31.06	102	17	P	V
		5864.6	50.74	-57.37	108.11	41.96	33.42	6.43	31.07	102	17	P	V
		5905.8	50.49	-31.88	82.37	41.57	33.54	6.46	31.08	102	17	P	V
		5944	51.36	-16.84	68.2	42.33	33.64	6.48	31.09	102	17	P	V
													V
													V
Remark	1. No other spurious found. 2. All results are PASS against Peak and Average limit line.												



Band 4 5725~5850MHz

WIFI 802.11ac VHT80 (Harmonic @ 3m)

WIFI Ant. 1	Note	Frequency (MHz)	Level (dBμV/m)	Over Limit (dB)	Limit Line (dBμV/m)	Read Level (dBμV)	Antenna Factor (dB/m)	Cable Loss (dB)	Preamp Factor (dB)	Ant Pos (cm)	Table Pos (deg)	Peak Avg. (P/A)	Pol. (H/V)	
802.11ac VHT80 CH 155 5775MHz		11550	49.41	-24.59	74	56.55	40.1	9.85	57.6	100	0	P	H	
		17325	49.62	-18.58	68.2	51.88	42.12	12.16	57.17	100	0	P	H	
													H	
													H	
			11550	48.51	-25.49	74	55.65	40.1	9.85	57.6	100	0	P	V
			17325	48.81	-19.39	68.2	51.07	42.12	12.16	57.17	100	0	P	V
														V
														V
Remark	1. No other spurious found. 2. All results are PASS against Peak and Average limit line.													



Note symbol

*	Fundamental Frequency which can be ignored. However, the level of any unwanted emissions shall not exceed the level of the fundamental frequency.
!	Test result is over limit line.
P/A	Peak or Average
H/V	Horizontal or Vertical



A calculation example for radiated spurious emission is shown as below:

WIFI	Note	Frequency	Level	Over	Limit	Read	Antenna	Cable	Preamp	Ant	Table	Peak	Pol.
Ant.				Limit	Line	Level	Factor	Loss	Factor	Pos	Pos	Avg.	
1		(MHz)	(dBμV/m)	(dB)	(dBμV/m)	(dBμV)	(dB/m)	(dB)	(dB)	(cm)	(deg)	(P/A)	(H/V)
802.11b		2390	55.45	-18.55	74	54.51	32.22	4.58	35.86	103	308	P	H
CH 01													
2412MHz		2390	43.54	-10.46	54	42.6	32.22	4.58	35.86	103	308	A	H

- Level(dBμV/m) =
Antenna Factor(dB/m) + Cable Loss(dB) + Read Level(dBμV) - Preamp Factor(dB)
- Over Limit(dB) = Level(dBμV/m) – Limit Line(dBμV/m)

For Peak Limit @ 2390MHz:

- Level(dBμV/m)
= Antenna Factor(dB/m) + Cable Loss(dB) + Read Level(dBμV) - Preamp Factor(dB)
= 32.22(dB/m) + 4.58(dB) + 54.51(dBμV) – 35.86 (dB)
= 55.45 (dBμV/m)
- Over Limit(dB)
= Level(dBμV/m) – Limit Line(dBμV/m)
= 55.45(dBμV/m) – 74(dBμV/m)
= -18.55(dB)

For Average Limit @ 2390MHz:

- Level(dBμV/m)
= Antenna Factor(dB/m) + Cable Loss(dB) + Read Level(dBμV) - Preamp Factor(dB)
= 32.22(dB/m) + 4.58(dB) + 42.6(dBμV) – 35.86 (dB)
= 43.54 (dBμV/m)
- Over Limit(dB)
= Level(dBμV/m) – Limit Line(dBμV/m)
= 43.54(dBμV/m) – 54(dBμV/m)
= -10.46(dB)

Both peak and average measured complies with the limit line, so test result is “PASS”.



Appendix D. Radiated Spurious Emission Plots

Test Engineer :	Nick Yu / Peter Liao / Ray Chen	Temperature :	23~25°C
		Relative Humidity :	61~63%

Note symbol

-L	Low channel location
-R	High channel location



Band 4 - 5725~5850MHz
WIFI 802.11a (Band Edge @ 3m)

WIFI	Band 4 5725~5850MHz Band Edge @ 3m	
ANT	802.11a CH149 5745MHz	
1	Horizontal	Fundamental
Peak	<p>Site Condition : 03CH12-RY : PEAK(BE) 16-24 3m HORN_9120D_1328 HORIZONTAL</p>	<p>Site Condition : 03CH12-RY : PEAK(UNI) 3m HORN_9120D_1328 HORIZONTAL</p>



WIFI	Band 4 5725~5850MHz Band Edge @ 3m	
ANT	802.11a CH149 5745MHz	
1	Vertical	Fundamental
Peak	<p>Site Condition : 03CH12-RY : PEAK_BE(B4)_16-24 3m HORN_91200_1328 VERTICAL</p>	<p>Site Condition : 03CH12-RY : PEAK(UNI) 3m HORN_91200_1328 VERTICAL</p>



WIFI	Band 4 5725~5850MHz Band Edge @ 3m	
ANT	802.11a CH157 5785MHz	
1	Horizontal	Fundamental
Peak	<p>Site Condition : 03CH12-HY : PEAK_BE(B4)_16-24 3m HORN_91200_1328 HORIZONTAL</p>	<p>Site Condition : 03CH12-HY : PEAK(UNI) 3m HORN_91200_1328 HORIZONTAL</p>
Peak	<p>Site Condition : 03CH12-HY : PEAK_BE(B4)_16-24 3m HORN_91200_1328 HORIZONTAL</p>	Left blank



WIFI	Band 4 5725~5850MHz Band Edge @ 3m	
ANT	802.11a CH157 5785MHz	
1	Vertical	Fundamental
Peak		
Peak		Left blank



WIFI	Band 4 5725~5850MHz Band Edge @ 3m	
ANT	802.11a CH165 5825MHz	
1	Horizontal	Fundamental
Peak	<p>Site : 03C112-HY Condition : PEAK_BE(B4)_16-24 3m HORN_91200_1328 HORIZONTAL</p>	<p>Site : 03C112-HY Condition : PEAK(UNI) 3m HORN_91200_1328 HORIZONTAL</p>



WIFI	Band 4 5725~5850MHz Band Edge @ 3m	
ANT	802.11a CH165 5825MHz	
1	Vertical	Fundamental
Peak	<p>Site Condition : 03CH12-HY : PEAK_BE(B4)_16-24 3m HORN_91200_1328 VERTICAL</p>	<p>Site Condition : 03CH12-HY : PEAK(UNI) 3m HORN_91200_1328 VERTICAL</p>



**Band 4 5725~5850MHz
WIFI 802.11ac VHT20 (Band Edge @ 3m)**

WIFI	Band 4 5725~5850MHz Band Edge @ 3m	
ANT	802.11ac VHT20 CH149 5745MHz	
1	Horizontal	Fundamental
Peak	<p>Site Condition : 03CH12-HY : PEAK_BE(B4)_16-24 3m HORN_91200_1328 HORIZONTAL</p>	<p>Site Condition : 03CH12-HY : PEAK(UNI) 3m HORN_91200_1328 HORIZONTAL</p>



WIFI	Band 4 5725~5850MHz Band Edge @ 3m	
ANT	802.11ac VHT20 CH149 5745MHz	
1	Vertical	Fundamental
Peak Avg.	<p>Site Condition : 03CH12-RY : PEAK_BE(B4)_16-24 3m HORN_91200_1328 VERTICAL</p>	<p>Site Condition : 03CH12-RY : PEAK(UNI) 3m HORN_91200_1328 VERTICAL</p>



WIFI	Band 4 5725~5850MHz Band Edge @ 3m	
ANT	802.11ac VHT20 CH157 5785MHz	
1	Horizontal	Fundamental
<p>Peak</p>		
<p>Peak</p>		<p>Left blank</p>



WIFI	Band 4 5725~5850MHz Band Edge @ 3m	
ANT	802.11ac VHT20 CH157 5785MHz	
1	Vertical	Fundamental
Peak		
Peak		Left blank



WIFI	Band 4 5725~5850MHz Band Edge @ 3m	
ANT	802.11ac VHT20 CH165 5825MHz	
1	Horizontal	Fundamental
Peak	<p>Site Condition : 03C112-HY : PEAK_BE(B4)_16-24 3m HORN_91200_1328 HORIZONTAL</p>	<p>Site Condition : 03C112-HY : PEAK(UNI) 3m HORN_91200_1328 HORIZONTAL</p>



WIFI	Band 4 5725~5850MHz Band Edge @ 3m	
ANT	802.11ac VHT20 CH165 5825MHz	
1	Vertical	Fundamental
Peak Avg.		



**Band 4 5725~5850MHz
WIFI 802.11ac VHT40 (Band Edge @ 3m)**

WIFI	Band 4 5725~5850MHz Band Edge @ 3m	
ANT	802.11ac VHT40 CH151 5755MHz	
1	Horizontal	Fundamental
Peak	<p>Site Condition : 03CH12-HY : PEAK_BE(B4)_16-24 3m HORN_91200_1328 HORIZONTAL</p>	<p>Site Condition : 03CH12-HY : PEAK(UNI) 3m HORN_91200_1328 HORIZONTAL</p>
Peak	<p>Site Condition : 03CH12-HY : PEAK_BE(B4)_16-24 3m HORN_91200_1328 HORIZONTAL</p>	Left blank



WIFI	Band 4 5725~5850MHz Band Edge @ 3m	
ANT	802.11ac VHT40 CH151 5755MHz	
1	Vertical	Fundamental
Peak		
Peak		Left blank



WIFI	Band 4 5725~5850MHz Band Edge @ 3m	
ANT	802.11ac VHT40 CH159 5795MHz	
1	Horizontal	Fundamental
<p>Peak</p>	<p>Site Condition : 03CH12-HY : PEAK_BE(B4)_16-24 3m HORN_9120D_1328 HORIZONTAL</p>	<p>Site Condition : 03CH12-HY : PEAK(UNID) 3m HORN_9120D_1328 HORIZONTAL</p>
<p>Peak</p>	<p>Site Condition : 03CH12-HY : PEAK_BE(B4)_16-24 3m HORN_9120D_1328 HORIZONTAL</p>	<p>Left blank</p>



WIFI	Band 4 5725~5850MHz Band Edge @ 3m	
ANT	802.11ac VHT40 CH159 5795MHz	
1	Vertical	Fundamental
Peak	<p>Site Condition : 03CH12-HY : PEAK_BE(B4)_16-24 3m HORN_91200_1328 VERTICAL</p>	<p>Site Condition : 03CH12-HY : PEAK(UNI) 3m HORN_91200_1328 VERTICAL</p>
Peak	<p>Site Condition : 03CH12-HY : PEAK_BE(B4)_16-24 3m HORN_91200_1328 VERTICAL</p>	Left blank



**Band 4 5725~5850MHz
WIFI 802.11ac VHT80 (Band Edge @ 3m)**

WIFI	Band 4 5725~5850MHz Band Edge @ 3m	
ANT	802.11ac VHT80 CH155 5775MHz	
1	Horizontal	Fundamental
Peak	<p>Site Condition : 03CH12-HY : PEAK_BE(B4)_16-24 3m HORN_91200_1328 HORIZONTAL</p>	<p>Site Condition : 03CH12-HY : PEAK(UN1) 3m HORN_91200_1328 HORIZONTAL</p>
Peak	<p>Site Condition : 03CH12-HY : PEAK_BE(B4)_16-24 3m HORN_91200_1328 HORIZONTAL</p>	Left blank

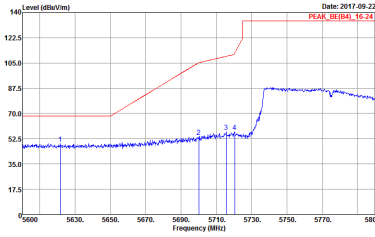
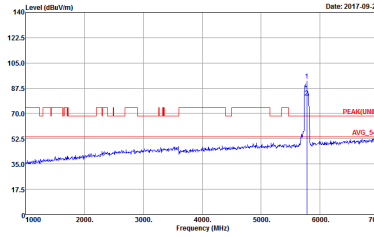
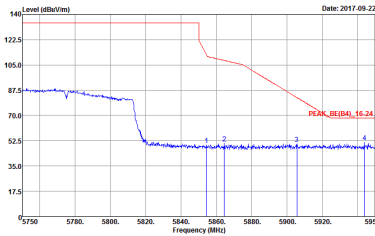

WIFI	Band 4 5725~5850MHz Band Edge @ 3m	
ANT	802.11ac VHT80 CH155 5775MHz	
1	Vertical	Fundamental
Peak	 <p>Site Condition : 03CH12-HY : PEAK_BE(B4)_16-24 3m HORN_9120D_1328 VERTICAL</p>	 <p>Site Condition : 03CH12-HY : PEAK(UNI) 3m HORN_9120D_1328 VERTICAL</p>
Peak	 <p>Site Condition : 03CH12-HY : PEAK_BE(B4)_16-24 3m HORN_9120D_1328 VERTICAL</p>	Left blank



Band 4 - 5725~5850MHz
WIFI 802.11a (Harmonic @ 3m)

WIFI	Band 4 5725~5850MHz Harmonic @ 3m	
ANT	802.11a CH149 5745MHz	
1	Horizontal	Vertical
<p>Peak Avg.</p>	<p>Site Condition : 03CH12-RY : PEAK(UNIT) 3m HORN_9120D_1328 HORIZONTAL</p>	<p>Site Condition : 03CH12-RY : PEAK(UNIT) 3m HORN_9120D_1328 VERTICAL</p>



WIFI	Band 4 5725~5850MHz Harmonic @ 3m	
ANT	802.11a CH157 5785MHz	
1	Horizontal	Vertical
Peak Avg.	<p>Horizontal spectrum plot showing Level (dBuV/m) vs Frequency (MHz). The plot includes a red line for the average level (AVG: 54) and two blue vertical lines marking peaks at 1 and 2. The site condition is 03CH12-RT : PEAK(UNIT) 3m HORN_9120D_1328 HORIZONTAL.</p>	<p>Vertical spectrum plot showing Level (dBuV/m) vs Frequency (MHz). The plot includes a red line for the average level (AVG: 54) and two blue vertical lines marking peaks at 1 and 2. The site condition is 03CH12-RT : PEAK(UNIT) 3m HORN_9120D_1328 VERTICAL.</p>



WIFI	Band 4 5725~5850MHz Harmonic @ 3m	
ANT	802.11a CH165 5825MHz	
1	Horizontal	Vertical
Peak Avg.		



Band 4 5725~5850MHz
WIFI 802.11ac VHT20 (Harmonic @ 3m)

WIFI	Band 4 5725~5850MHz Harmonic @ 3m	
ANT	802.11ac VHT20 CH149 5745MHz	
1	Horizontal	Vertical
Peak Avg.	<p>Site Condition : 03CH12-HY : PEAQ(UNI) 3m HORN_9120D_1328 HORIZONTAL</p>	<p>Site Condition : 03CH12-HY : PEAQ(UNI) 3m HORN_9120D_1328 VERTICAL</p>

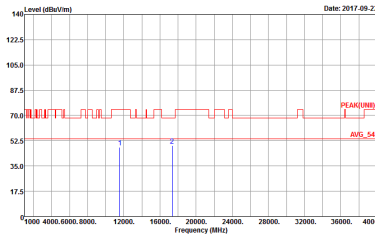
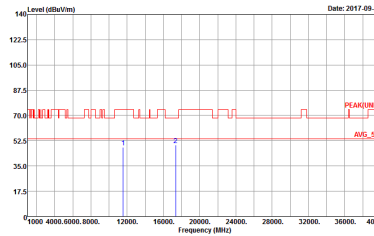

WIFI	Band 4 5725~5850MHz Harmonic @ 3m	
ANT	802.11ac VHT20 CH157 5785MHz	
1	Horizontal	Vertical
Peak Avg.	 <p>Site Condition : 03CH12-RY : PEAK(UNIT) 3m HORN_9120D_1328 HORIZONTAL</p>	 <p>Site Condition : 03CH12-RY : PEAK(UNIT) 3m HORN_9120D_1328 VERTICAL</p>



WIFI	Band 4 5725~5850MHz Harmonic @ 3m	
ANT	802.11ac VHT20 CH165 5825MHz	
1	Horizontal	Vertical
Peak Avg.	<p>Site Condition : 03CH12-RY : PEAK(UNIT) 3m HORN_9120D_1328 HORIZONTAL</p>	<p>Site Condition : 03CH12-RY : PEAK(UNIT) 3m HORN_9120D_1328 VERTICAL</p>



Band 4 5725~5850MHz
WIFI 802.11ac VHT40 (Harmonic @ 3m)

WIFI	Band 4 5725~5850MHz Harmonic @ 3m	
ANT	802.11ac VHT40 CH151 5755MHz	
1	Horizontal	Vertical
Peak Avg.	<p>Site Condition : 03CH12-HY : PEAQ(UNI) 3m HORN_9120D_1328 HORIZONTAL</p>	<p>Site Condition : 03CH12-HY : PEAQ(UNI) 3m HORN_9120D_1328 VERTICAL</p>

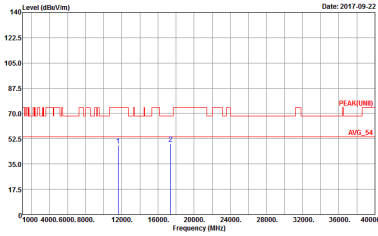
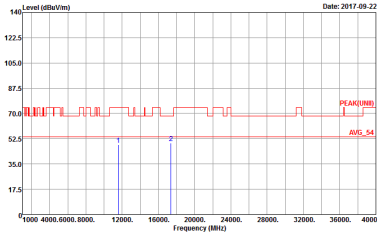

WIFI	Band 4 5725~5850MHz Harmonic @ 3m	
ANT	802.11ac VHT40 CH159 5795MHz	
1	Horizontal	Vertical
Peak Avg.	 <p>Site Condition : 03CH12-RY : PEAK(UNIT) 3m HORN_9120D_1328 HORIZONTAL</p>	 <p>Site Condition : 03CH12-RY : PEAK(UNIT) 3m HORN_9120D_1328 VERTICAL</p>



Band 4 5725~5850MHz
WIFI 802.11ac VHT80 (Harmonic @ 3m)

WIFI	Band 4 5725~5850MHz Harmonic @ 3m	
ANT	802.11ac VHT80 CH155 5775MHz	
1	Horizontal	Vertical
Peak Avg.	<p>Site Condition : 03CH12-HY : PEAQ(UNI) 3m HORN_9120D_1328 HORIZONTAL</p>	<p>Site Condition : 03CH12-HY : PEAQ(UNI) 3m HORN_9120D_1328 VERTICAL</p>



Emission below 1GHz
5GHz WIFI 802.11a (LF)

WIFI	5GHz 5725~5850MHz	
ANT	802.11a LF	
1	Horizontal	Vertical
QP / Peak		



Appendix E. Duty Cycle Plots

Band	Duty Cycle(%)	T(us)	1/T(kHz)	VBW Setting	Duty Factor(dB)
802.11a	93.55	2030	0.49	1kHz	0.29
5GHz 802.11ac VHT20	93.17	1910	0.52	1kHz	0.31
5GHz 802.11ac VHT40	87.85	933	1.07	3kHz	0.56
5GHz 802.11ac VHT80	87.65	852	1.17	3kHz	0.57



802.11a

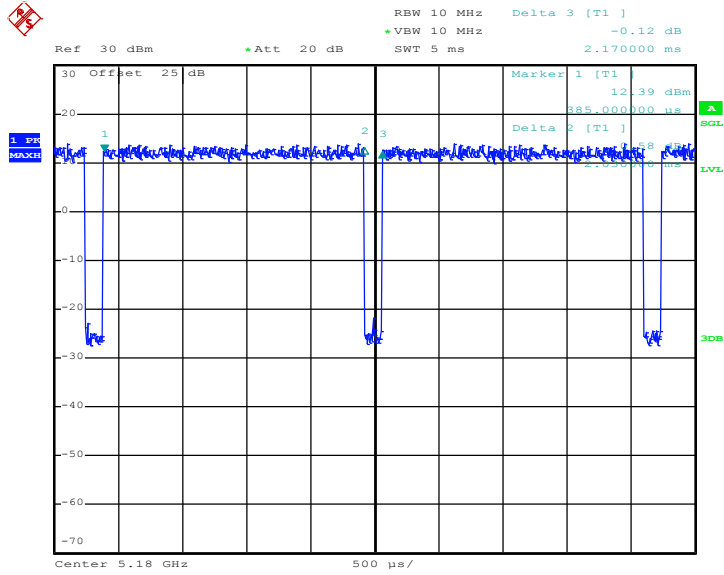

Date: 10.AUG.2017 16:58:22

802.11ac VHT20

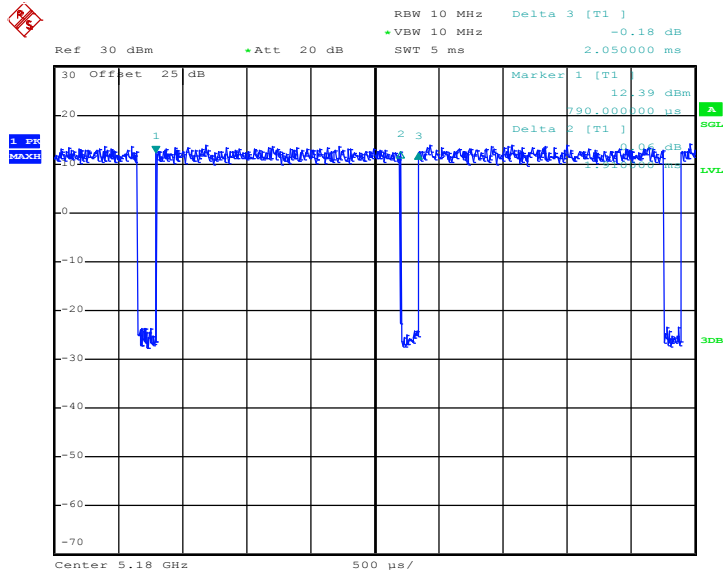

Date: 10.AUG.2017 17:03:50



802.11ac VHT40

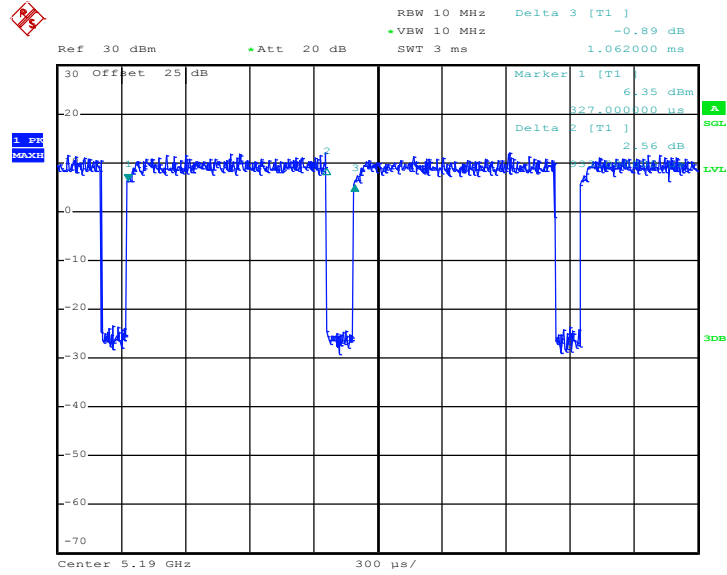

Date: 10.AUG.2017 17:09:49

802.11ac VHT80

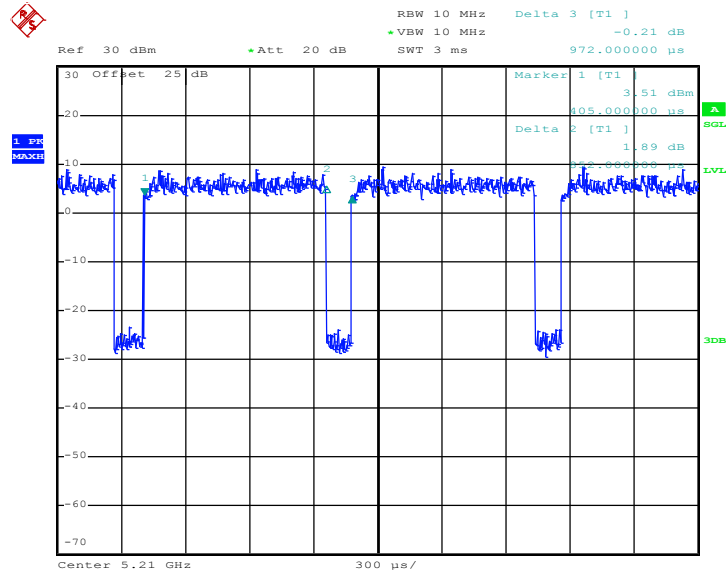

Date: 10.AUG.2017 17:12:25