



# FCC RF Test Report

**APPLICANT** : Sony Mobile Communications Inc.  
**EQUIPMENT** : GSM/WCDMA/LTE Phone+Bluetooth, DTS/UNII  
a/b/g/n/ac and NFC  
**BRAND NAME** : Sony  
**FCC ID** : PY7-57442Z  
**STANDARD** : FCC Part 15 Subpart C §15.247  
**CLASSIFICATION** : (DTS) Digital Transmission System

This is a variant report which is only valid together with the original test report. The product was received on Jun. 07, 2017 and testing was completed on Oct. 13, 2017. We, SPORTON INTERNATIONAL INC., would like to declare that the tested sample has been evaluated in accordance with the test procedures and has been in compliance with the applicable technical standards.

The test results in this report apply exclusively to the tested model / sample. Without written approval of SPORTON INTERNATIONAL INC., the test report shall not be reproduced except in full.

Reviewed by: Joseph Lin / Supervisor

Approved by: Jones Tsai / Manager



## **SPORTON INTERNATIONAL INC.**

**No. 52, Hwa Ya 1<sup>st</sup> Rd., Hwa Ya Technology Park, Kwei-Shan District, Tao Yuan City, Taiwan, R.O.C.**

SPORTON INTERNATIONAL INC.

TEL : 886-3-327-3456

FAX : 886-3-328-4978

FCC ID : PY7-57442Z

Page Number : 1 of 17

Report Issued Date : Oct. 31, 2017

Report Version : Rev. 01

Report Template No.: BU5-FR15CWL Version 2.0



# TABLE OF CONTENTS

**REVISION HISTORY.....3**

**SUMMARY OF TEST RESULT .....4**

**1 GENERAL DESCRIPTION .....5**

    1.1 Applicant .....5

    1.2 Manufacturer.....5

    1.3 Product Feature of Equipment Under Test.....5

    1.4 Modification of EUT .....5

    1.5 Testing Location .....6

    1.6 Applicable Standards.....6

**2 TEST CONFIGURATION OF EQUIPMENT UNDER TEST .....7**

    2.1 Carrier Frequency and Channel .....7

    2.2 Test Mode.....7

    2.3 Connection Diagram of Test System.....8

    2.4 EUT Operation Test Setup .....8

**3 TEST RESULT .....9**

    3.1 Output Power Measurement.....9

    3.2 Radiated Band Edges and Spurious Emission Measurement .....10

    3.3 Antenna Requirements .....14

**4 LIST OF MEASURING EQUIPMENT .....15**

**5 UNCERTAINTY OF EVALUATION .....17**

**APPENDIX A. CONDUCTED TEST RESULTS**

**APPENDIX B. RADIATED SPURIOUS EMISSION**

**APPENDIX C. RADIATED SPURIOUS EMISSION PLOTS**

**APPENDIX D. DUTY CYCLE PLOTS**

**APPENDIX E. ORIGINAL REPORT**





### SUMMARY OF TEST RESULT

Report Section	FCC Rule	Description	Limit	Result	Remark
3.1	15.247(b)	Power Output Measurement	≤ 30dBm	Pass	-
3.2	15.247(d)	Radiated Band Edges and Radiated Spurious Emission	15.209(a) & 15.247(d)	Pass	Under limit 9.94 dB at 175.800 MHz
3.3	15.203 & 15.247(b)	Antenna Requirement	N/A	Pass	-



# 1 General Description

## 1.1 Applicant

**Sony Mobile Communications Inc.**

4-12-3 Higashi-Shinagawa, Shinagawa-ku, Tokyo, 140-0002, Japan

## 1.2 Manufacturer

**Sony Mobile Communications Inc.**

4-12-3 Higashi-Shinagawa, Shinagawa-ku, Tokyo, 140-0002, Japan

## 1.3 Product Feature of Equipment Under Test

GSM/WCDMA/LTE, Bluetooth, DTS/UNII a/b/g/n/ac, FM Receiver, NFC, and GPS.

Standards-related Product Specification	
Antenna Type / Gain	PIFA Antenna type with gain -1.60 dBi

**Remark:** This is a variant report. All the test cases were performed on original report which can be referred to Sporton Report Number FR760710-01C.

EUT Information List			
HW Version	SW Version	S/N	Performed Test Item
A	1.14	CQ300000HS	RF conducted measurement
		CQ300004PQ	Radiated Spurious Emission

Accessory List	
<b>AC Adapter 1</b>	Model Name: UCH12
	S/N: 2916W46610569
<b>Earphone 1</b>	Model Name: MH410c
	S/N: N/A
<b>USB Cable</b>	Model Name: UCB20
	S/N: 1635A91C00314D8

**Note:**

1. Above EUT list and accessory list used are electrically identical per declared by manufacturer.
2. Above the accessories list are used to exercise the EUT during test.
3. For other wireless features of this EUT, test report will be issued separately.

## 1.4 Modification of EUT

No modifications are made to the EUT during all test items.



### 1.5 Testing Location

Sporton Lab is accredited to ISO 17025 by Taiwan Accreditation Foundation (TAF code : 1190) and the FCC designation No. TW1190 and TW0007 under the FCC 2.948(e) by Mutual Recognition Agreement (MRA) in FCC Test.

<b>Test Site</b>	SPORTON INTERNATIONAL INC.
<b>Test Site Location</b>	No. 52, Hwa Ya 1 <sup>st</sup> Rd., Hwa Ya Technology Park, Kwei-Shan District, Tao Yuan City, Taiwan, R.O.C. TEL: +886-3-327-3456 FAX: +886-3-328-4978
<b>Test Site No.</b>	<b>Sporton Site No.</b> TH05-HY

**Note:** The test site complies with ANSI C63.4 2014 requirement.

<b>Test Site</b>	SPORTON INTERNATIONAL INC.
<b>Test Site Location</b>	No.58, Aly. 75, Ln. 564, Wenhua 3rd Rd. Guishan Dist, Taoyuan City, Taiwan (R.O.C.) TEL: +886-3-327-0868 FAX: +886-3-327-0855
<b>Test Site No.</b>	<b>Sporton Site No.</b> 03CH13-HY

**Note:** The test site complies with ANSI C63.4 2014 requirement.

### 1.6 Applicable Standards

According to the specifications of the manufacturer, the EUT must comply with the requirements of the following standards:

- ♦ FCC Part 15 Subpart C §15.247
- ♦ FCC KDB Publication No. 558074 D01 DTS Meas. Guidance v04
- ♦ ANSI C63.10-2013

**Remark:**

1. All test items were verified and recorded according to the standards and without any deviation during the test.
2. This EUT has also been tested and complied with the requirements of FCC Part 15, Subpart B, recorded in a separate test report.



## 2 Test Configuration of Equipment Under Test

- a. The EUT has been associated with peripherals and configuration operated in a manner tended to maximize its emission characteristics in a typical application. Frequency range investigated: radiation emission (9 kHz to the 10th harmonic of the highest fundamental frequency or to 40 GHz, whichever is lower). Pre-scanned tests, X, Y, Z in three orthogonal panels, and different data rates were conducted to determine the final configuration (X plane as worst plane) from all possible combinations.

### 2.1 Carrier Frequency and Channel

Frequency Band	Channel	Freq. (MHz)	Channel	Freq. (MHz)
2400-2483.5 MHz	1	2412	7	2442
	2	2417	8	2447
	3	2422	9	2452
	4	2427	10	2457
	5	2432	11	2462
	6	2437	-	-

### 2.2 Test Mode

Final test mode of conducted test items and radiated spurious emissions are considering the modulation and worse data rates as below table.

Modulation	Data Rate
802.11b	1 Mbps
802.11ac VHT20	MCS0

Remark: For Radiated Test Cases, The tests were performance with Battery 1.

## 2.3 Connection Diagram of Test System

<WLAN Tx Mode>

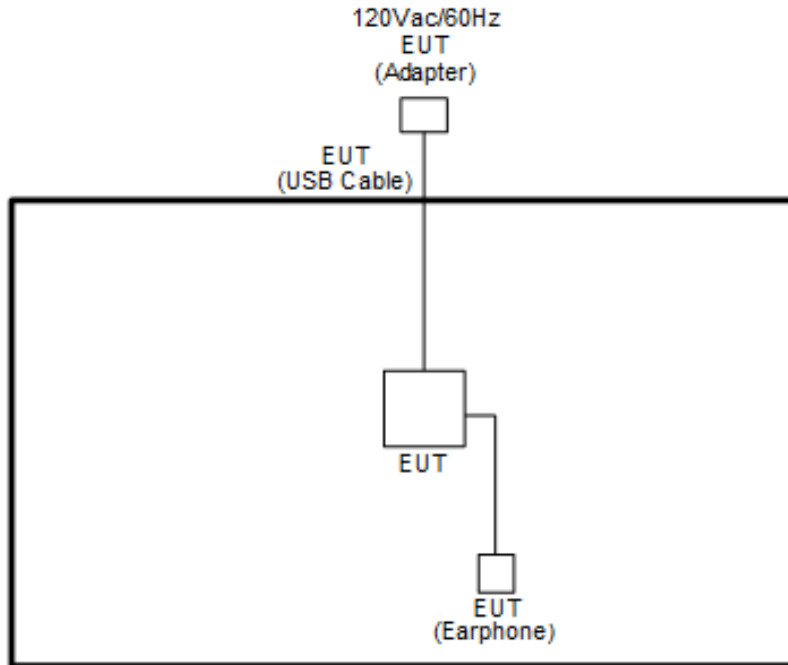

## 2.4 EUT Operation Test Setup

For RF test items, an engineering test program was provided and enabled to make EUT transmitting signals.



### 3 Test Result

#### 3.1 Output Power Measurement

##### 3.1.1 Limit of Output Power

For systems using digital modulation in the 2400-2483.5MHz, the limit for peak output power is 30dBm. If transmitting antenna of directional gain greater than 6dBi are used the peak output power from the intentional radiator shall be reduced below the above stated value by the amount in dB that the directional gain of the antenna exceeds 6 dBi. In case of point-to-point operation, the limit has to be reduced by 1dB for every 3dB that the directional gain of the antenna exceeds 6dBi.

##### 3.1.2 Measuring Instruments

The measuring equipment is listed in the section 4 of this test report.

##### 3.1.3 Test Procedures

1. The testing follows the Measurement Procedure of FCC KDB No. 558074 DTS D01 Meas. Guidance v04 section 9.1.3 PKPM1 Peak power meter method.
2. The RF output of EUT was connected to the power meter by RF cable and attenuator. The path loss was compensated to the results for each measurement.
3. Set to the maximum power setting and enable the EUT transmit continuously.
4. Measure the conducted output power and record the results in the test report.

##### 3.1.4 Test Setup

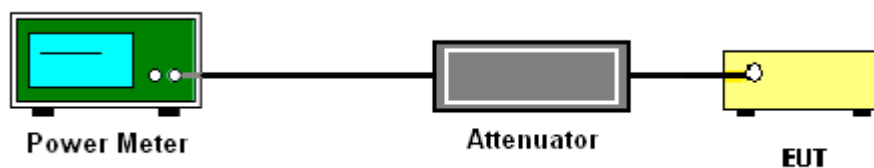

##### 3.1.5 Test Result of Peak Output Power

Please refer to Appendix A.

##### 3.1.6 Test Result of Average output Power (Reporting Only)

Please refer to Appendix A.



### 3.2 Radiated Band Edges and Spurious Emission Measurement

#### 3.2.1 Limit of Radiated band edge and Spurious Emission Measurement

In any 100 kHz bandwidth outside the intentional radiator frequency band, all harmonics/spurious must be at least 20 dB below the highest emission level within the authorized band. If the output power of this device was measured by spectrum analyzer, the attenuation under this paragraph shall be 30 dB instead of 20 dB. In addition, radiated emissions which fall in the restricted bands must also comply with the limits as below.

Frequency (MHz)	Field Strength (microvolts/meter)	Measurement Distance (meters)
0.009 – 0.490	2400/F(kHz)	300
0.490 – 1.705	24000/F(kHz)	30
1.705 – 30.0	30	30
30 – 88	100	3
88 – 216	150	3
216 - 960	200	3
Above 960	500	3

#### 3.2.2 Measuring Instruments

The measuring equipment is listed in the section 4 of this test report.



### 3.2.3 Test Procedures

1. The testing follows FCC KDB Publication No. 558074 D01 DTS Meas. Guidance v04.
2. The EUT was arranged to its worst case and then tune the antenna tower (from 1 m to 4 m) and turntable (from 0 degree to 360 degrees) to find the maximum reading. A pre-amp and a high pass filter are used for the test in order to get better signal level.
3. The EUT was placed on a turntable with 0.8 meter for frequency below 1GHz and 1.5 meter for frequency above 1GHz respectively above ground.
4. The EUT was set 3 meters from the interference receiving antenna, which was mounted on the top of a variable height antenna tower.
5. Corrected Reading: Antenna Factor + Cable Loss + Read Level - Preamp Factor = Level
6. For testing below 1GHz, if the emission level of the EUT in peak mode was 3 dB lower than the limit specified, then peak values of EUT will be reported, otherwise, the emissions will be repeated one by one using the CISPR quasi-peak method and reported.
7. For testing above 1GHz, the emission level of the EUT in peak mode was 20dB lower than average limit (that means the emission level in average mode also complies with the limit in average mode), then peak values of EUT will be reported, otherwise, the emissions will be measured in average mode again and reported.
8. Use the following spectrum analyzer settings:
  - (1) Span shall wide enough to fully capture the emission being measured;
  - (2) Set RBW=100 kHz for  $f < 1$  GHz; VBW  $\geq$  RBW; Sweep = auto; Detector function = peak; Trace = max hold;
  - (3) Set RBW = 1 MHz, VBW= 3MHz for  $f \geq 1$  GHz for peak measurement.  
For average measurement:
    - VBW = 10 Hz, when duty cycle is no less than 98 percent.
    - VBW  $\geq 1/T$ , when duty cycle is less than 98 percent where T is the minimum transmission duration over which the transmitter is on and is transmitting at its maximum power control level for the tested mode of operation.

### 3.2.4 Test Setup

For radiated emissions below 30MHz

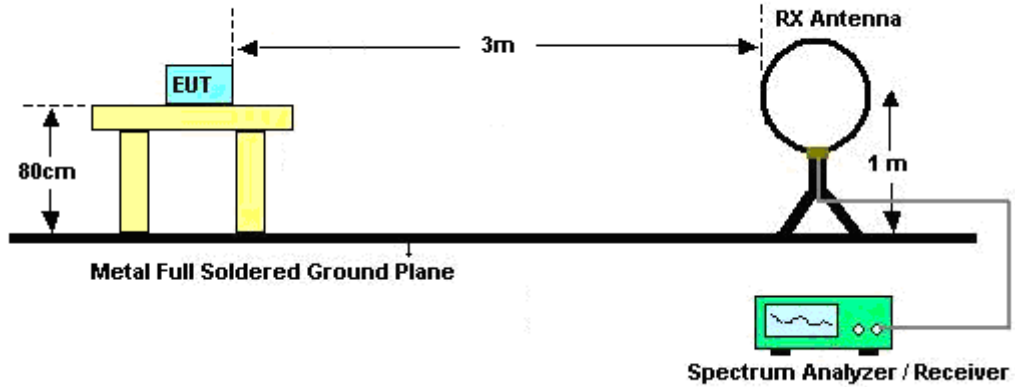

For radiated emissions from 30MHz to 1GHz

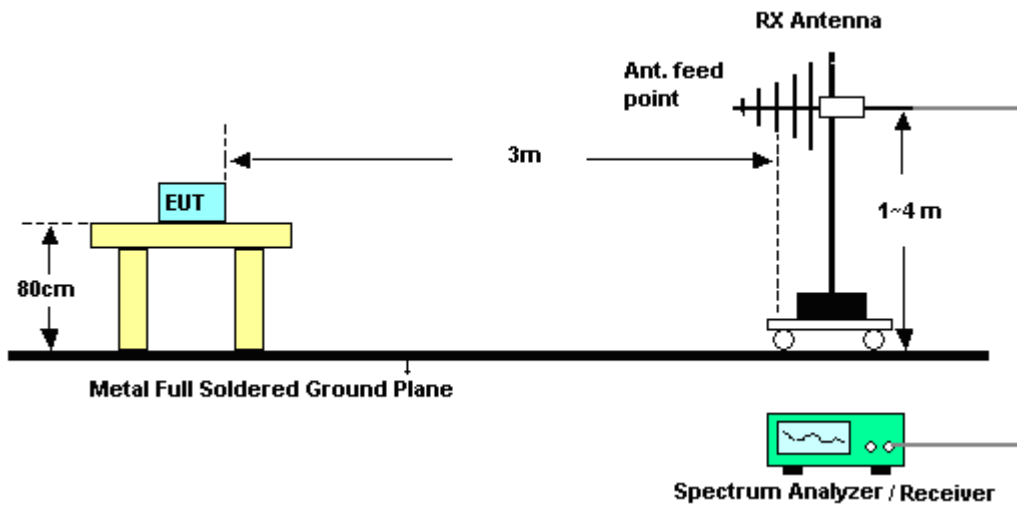

For radiated emissions above 1GHz

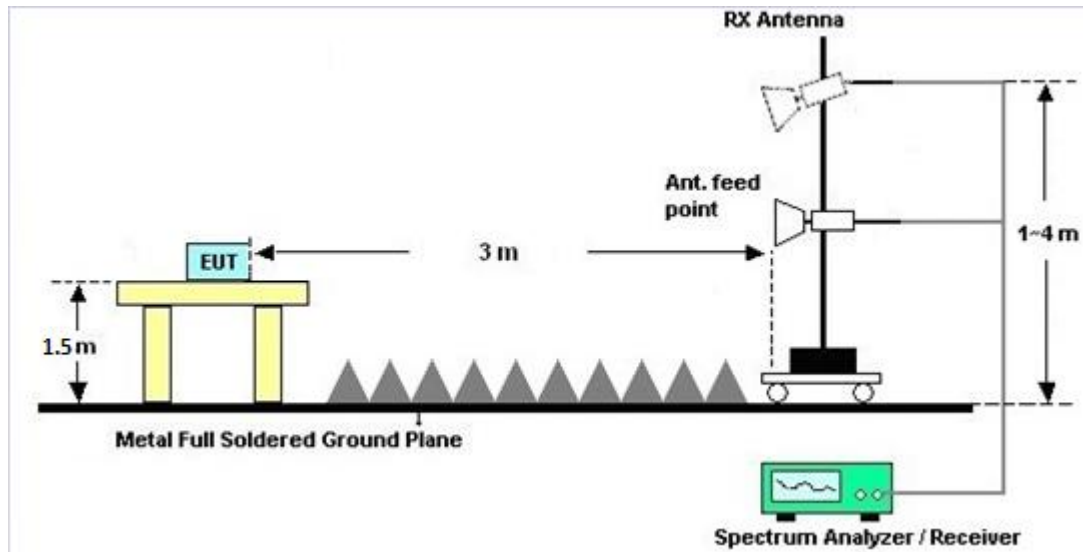

### 3.2.5 Test Results of Radiated Spurious Emissions (9kHz ~ 30MHz)

The low frequency, which started from 9 kHz to 30MHz, was pre-scanned and the result which was 20dB lower than the limit line was not reported.

There is a comparison data of both open-field test site and semi-Anechoic chamber, and the result came out very similar.

### 3.2.6 Test Result of Radiated Spurious at Band Edges

Please refer to Appendix B and C.

### 3.2.7 Duty Cycle

Please refer to Appendix D.

### 3.2.8 Test Result of Radiated Spurious Emission (30MHz ~ 10<sup>th</sup> Harmonic)

Please refer to Appendix B. and C.



### **3.3 Antenna Requirements**

#### **3.3.1 Standard Applicable**

If directional gain of transmitting antennas is greater than 6dBi, the power shall be reduced by the same level in dB comparing to gain minus 6dBi. The use of a permanently attached antenna or of an antenna that uses a unique coupling to the intentional radiator shall be considered sufficient to comply with the rule.

#### **3.3.2 Antenna Anti-Replacement Construction**

An embedded-in antenna design is used.

#### **3.3.3 Antenna Gain**

The antenna peak gain of EUT is less than 6 dBi. Therefore, it is not necessary to reduce maximum peak output power limit.



## 4 List of Measuring Equipment

Instrument	Manufacturer	Model No.	Serial No.	Characteristics	Calibration Date	Test Date	Due Date	Remark
Power Meter	Anritsu	ML2495A	1132003	N/A	Aug. 09, 2017	Sep. 14, 2017~ Sep. 28, 2017	Aug. 08, 2018	Conducted (TH05-HY)
Power Sensor	Anritsu	MA2411B	1027253	300MHz~40GHz z	Jul. 28, 2017	Sep. 14, 2017~ Sep. 28, 2017	Jul. 27, 2018	Conducted (TH05-HY)
Spectrum Analyzer	Rohde & Schwarz	FSP30	101067	9kHz ~ 30GHz	Nov. 17, 2016	Sep. 14, 2017~ Sep. 28, 2017	Nov. 16, 2017	Conducted (TH05-HY)
Hygrometer	TECEPEL	DTM-303B	TP157151	N/A	Mar. 20, 2017	Sep. 14, 2017~ Sep. 28, 2017	Mar. 19, 2018	Conducted (TH05-HY)
RF Cable	HUBER + SUHNER	SUCOFLEX 104	MY842095 21	1GHz~26GHz	Dec. 02, 2016	Sep. 14, 2017~ Sep. 28, 2017	Dec. 01, 2017	Conducted (TH05-HY)
Loop Antenna	Rohde & Schwarz	HFH2-Z2	100315	9 kHz~30 MHz	May 15, 2017	Oct. 13, 2017	May 14, 2019	Radiation (03CH13-HY)
Bilog Antenna	TESEQ	CBL 6111D&00800 N1D01N-06	40103&04	30MHz to 1GHz	Jan. 07, 2017	Oct. 13, 2017	Jan. 06, 2018	Radiation (03CH13-HY)
Horn Antenna	SCHWARZBECK	BBHA 9120 D	9120D-124 1	1GHz ~ 18GHz	May 02, 2017	Oct. 13, 2017	May 01, 2018	Radiation (03CH13-HY)
SHF-EHF Horn Antenna	SCHWARZBECK	BBHA 9170	BBHA9170 584	18GHz- 40GHz	Nov. 08, 2016	Oct. 13, 2017	Nov. 07, 2017	Radiation (03CH13-HY)
Spectrum Analyzer	Keysight	N9010A	MY553705 26	N/A	Mar. 15, 2017	Oct. 13, 2017	Mar. 14, 2018	Radiation (03CH13-HY)
EMI Test Receiver	Agilent	N9038A(MXE )	MY532900 53	20Hz to 26.5GHz	Jan. 12, 2017	Oct. 13, 2017	Jan. 11, 2018	Radiation (03CH13-HY)
Amplifier	Sonoma-Instrument	310 N	187282	9KHz~1GHz	Dec. 21, 2016	Oct. 13, 2017	Dec. 20, 2017	Radiation (03CH13-HY)
Preamplifier	MITEQ	AMF-7D-0010 1800-30-10P	1590074	1GHz~18GHz	May 22, 2017	Oct. 13, 2017	May 21, 2018	Radiation (03CH13-HY)
Preamplifier	Keysight	83017A	MY532701 47	1GHz~26.5GHz	Jan. 09, 2017	Oct. 13, 2017	Jan. 08, 2018	Radiation (03CH13-HY)
Amplifier	MITEQ	TTA1840-35-HG	1871923	18GHz~40GHz, VSWR : 2.5:1 max	Jul. 18, 2017	Oct. 13, 2017	Jul. 17, 2018	Radiation (03CH13-HY)



Instrument	Manufacturer	Model No.	Serial No.	Characteristics	Calibration Date	Test Date	Due Date	Remark
Hygrometer	TECPEL	DTM-303B	TP140320	N/A	Nov. 14, 2016	Oct. 13, 2017	Nov. 13, 2017	Radiation (03CH13-HY)
RF Cable	HUBER + SUHNER	SUCOFLEX 104	MY335041/4 MY9840/4 MY9838/4	26GHz~40GHz	Mar. 27, 2017	Oct. 13, 2017	Mar. 26, 2018	Radiation (03CH13-HY)
RF Cable	HUBER + SUHNER	SUCOFLEX 104	MY335041/4 MY9840/4 MY9838/4	30MHz~1GHz	Jan. 27, 2017	Oct. 13, 2017	Jan. 26, 2018	Radiation (03CH13-HY)
RF Cable	HUBER + SUHNER	SUCOFLEX 104	MY335041/4 MY9840/4 MY9838/4	1GHz~26GHz	Jan. 27, 2017	Oct. 13, 2017	Jan. 26, 2018	Radiation (03CH13-HY)
Controller	EMEC	EM1000	N/A	Control Turn table & Ant Mast	N/A	Oct. 13, 2017	N/A	Radiation (03CH13-HY)
Antenna Mast	EMEC	AM-BS-450 0-B	N/A	1m~4m	N/A	Oct. 13, 2017	N/A	Radiation (03CH13-HY)
Turn Table	EMEC	TT2000	N/A	0~360 Degree	N/A	Oct. 13, 2017	N/A	Radiation (03CH13-HY)
Test Software	Audix	E3	6.2009-8-24	N/A	N/A	Oct. 13, 2017	N/A	Radiation (03CH13-HY)
Filter	Wainwright	WLKS1200-12SS	SN2	1.2G Low Pass	Jul. 17, 2017	Oct. 13, 2017	Jul. 16, 2018	Radiation (03CH13-HY)
Filter	Wainwright	WHKX12-27 00-3000-18 000-60SS	SN2	3G High Pass	Sep. 18, 2017	Oct. 13, 2017	Sep. 17, 2018	Radiation (03CH13-HY)





## 5 Uncertainty of Evaluation

### Uncertainty of Radiated Emission Measurement (30 MHz ~ 1000 MHz)

Measuring Uncertainty for a Level of Confidence of 95% ( $U = 2Uc(y)$ )	4.90
---	------

### Uncertainty of Radiated Emission Measurement (1000 MHz ~ 18000 MHz)

Measuring Uncertainty for a Level of Confidence of 95% ( $U = 2Uc(y)$ )	5.40
---	------

### Uncertainty of Radiated Emission Measurement (18000 MHz ~ 40000 MHz)

Measuring Uncertainty for a Level of Confidence of 95% ( $U = 2Uc(y)$ )	4.30
---	------

## Appendix A. Test Result of Conducted Test Items

Test Engineer:	Shiming Liu	Temperature:	21~25	°C
Test Date:	2017/9/14~2017/9/28	Relative Humidity:	51~54	%

**TEST RESULTS DATA**  
**Peak Power Table**

2.4GHz Band										
Mod.	Data Rate	N <sub>TX</sub>	CH.	Freq. (MHz)	Peak Conducted Power (dBm)	Conducted Power Limit (dBm)	DG (dBi)	EIRP Power (dBm)	EIRP Power Limit (dBm)	Pass /Fail
11b	1Mbps	1	1	2412	18.67	30.00	-1.60	17.07	36.00	Pass
11b	1Mbps	1	6	2437	18.84	30.00	-1.60	17.24	36.00	Pass
11b	1Mbps	1	11	2462	18.87	30.00	-1.60	17.27	36.00	Pass
11g	6Mbps	1	1	2412	18.45	30.00	-1.60	16.85	36.00	Pass
11g	6Mbps	1	6	2437	18.48	30.00	-1.60	16.88	36.00	Pass
11g	6Mbps	1	11	2462	18.55	30.00	-1.60	16.95	36.00	Pass
HT20	MCS0	1	1	2412	18.37	30.00	-1.60	16.77	36.00	Pass
HT20	MCS0	1	6	2437	18.48	30.00	-1.60	16.88	36.00	Pass
HT20	MCS0	1	11	2462	18.50	30.00	-1.60	16.90	36.00	Pass
VHT20	MCS0	1	1	2412	18.56	30.00	-1.60	16.96	36.00	Pass
VHT20	MCS0	1	6	2437	18.25	30.00	-1.60	16.65	36.00	Pass
VHT20	MCS0	1	11	2462	18.45	30.00	-1.60	16.85	36.00	Pass

**TEST RESULTS DATA**  
**Average Power Table**  
**(Reporting Only)**

2.4GHz Band						
Mod.	Data Rate	N <sub>TX</sub>	CH.	Freq. (MHz)	Duty Factor (dB)	Average Conducted Power (dBm)
11b	1Mbps	1	1	2412	0.00	15.83
11b	1Mbps	1	6	2437	0.00	15.90
11b	1Mbps	1	11	2462	0.00	15.95
11g	6Mbps	1	1	2412	0.27	13.78
11g	6Mbps	1	6	2437	0.27	13.87
11g	6Mbps	1	11	2462	0.27	13.95
HT20	MCS0	1	1	2412	0.25	13.62
HT20	MCS0	1	6	2437	0.25	13.82
HT20	MCS0	1	11	2462	0.25	13.83
VHT20	MCS0	1	1	2412	0.16	13.85
VHT20	MCS0	1	6	2437	0.16	13.56
VHT20	MCS0	1	11	2462	0.16	13.76



## Appendix B. Radiated Spurious Emission

Test Engineer :	Alex Jheng , Bill Chang , and Wilson Wu	Temperature :	22~24°C
		Relative Humidity :	43~44%

### 2.4GHz 2400~2483.5MHz

#### WIFI 802.11b (Band Edge @ 3m)

WIFI	Note	Frequency	Level	Over	Limit	Read	Antenna	Cable	Preamp	Ant	Table	Peak	Pol.	
Ant.				Limit	Line	Level	Factor	Loss	Factor	Pos	Pos	Avg.		
1		( MHz )	( dBμV/m )	( dB )	( dBμV/m )	( dBμV )	( dB/m )	( dB )	( dB )	( cm )	( deg )	( P/A )	( H/V )	
802.11b CH 11 2462MHz	*	2462	103.22	-	-	92.26	27.1	4.9	30.97	379	310	P	H	
	*	2462	99.96	-	-	89	27.1	4.9	30.97	379	310	A	H	
		2499.72	52.06	-21.94	74	40.96	27.2	4.93	30.96	379	310	P	H	
		2484.04	41.06	-12.94	54	30.02	27.15	4.93	30.97	379	310	A	H	
													H	
													H	
	*	2462	102.53	-	-	91.57	27.1	4.9	30.97	379	265	265	P	V
	*	2462	98.72	-	-	87.76	27.1	4.9	30.97	379	265	265	A	V
		2487.24	52.05	-21.95	74	41.01	27.15	4.93	30.97	379	265	265	P	V
		2483.76	40.98	-13.02	54	29.94	27.15	4.93	30.97	379	265	265	A	V
														V
														V
Remark	1. No other spurious found. 2. All results are PASS against Peak and Average limit line.													



2.4GHz 2400~2483.5MHz

WIFI 802.11b (Harmonic @ 3m)

WIFI Ant. 1	Note	Frequency ( MHz )	Level ( dBμV/m )	Over Limit ( dB )	Limit Line ( dBμV/m )	Read Level ( dBμV )	Antenna Factor ( dB/m )	Cable Loss ( dB )	Preamp Factor ( dB )	Ant Pos ( cm )	Table Pos ( deg )	Peak Avg. ( P/A )	Pol. ( H/V )	
802.11b CH 11 2462MHz		4924	38.86	-35.14	74	56.24	31.7	7.52	57.1	100	0	P	H	
		7386	46.13	-27.87	74	57.58	36.31	9.18	57.38	100	0	P	H	
													H	
													H	
			4924	40.92	-33.08	74	58.3	31.7	7.52	57.1	100	0	P	V
			7386	49.99	-24.01	74	61.44	36.31	9.18	57.38	100	0	P	V
														V
														V
Remark	1. No other spurious found. 2. All results are PASS against Peak and Average limit line.													



**2.4GHz 2400~2483.5MHz  
WIFI 802.11ac VHT20 (Band Edge @ 3m)**

WIFI Ant. 1	Note	Frequency ( MHz )	Level ( dBμV/m )	Over Limit ( dB )	Limit Line ( dBμV/m )	Read Level ( dBμV )	Antenna Factor ( dB/m )	Cable Loss ( dB )	Preamp Factor ( dB )	Ant Pos ( cm )	Table Pos ( deg )	Peak Avg. ( P/A )	Pol. ( H/V )	
802.11ac VHT20 CH 01 2412MHz		2389.275	52.45	-21.55	74	41.79	26.89	4.83	30.99	398	300	P	H	
		2390	43.64	-10.36	54	32.98	26.89	4.83	30.99	398	300	A	H	
	*	2412	100.63	-	-	89.88	26.94	4.87	30.99	398	300	P	H	
	*	2412	92.47	-	-	81.72	26.94	4.87	30.99	398	300	A	H	
													H	
														H
			2390	54.14	-19.86	74	2390	26.89	4.83	30.99	400	265	P	V
			2389.905	43.82	-10.18	54	33.16	26.89	4.83	30.99	400	265	A	V
		*	2412	100.04	-	-	89.29	26.94	4.87	30.99	400	265	P	V
		*	2412	93.73	-	-	82.98	26.94	4.87	30.99	400	265	A	V
													V	
													V	
<b>Remark</b>	1. No other spurious found. 2. All results are PASS against Peak and Average limit line.													



2.4GHz 2400~2483.5MHz

WIFI 802.11ac VHT20 (Harmonic @ 3m)

WIFI Ant. 1	Note	Frequency ( MHz )	Level ( dBμV/m )	Over Limit ( dB )	Limit Line ( dBμV/m )	Read Level ( dBμV )	Antenna Factor ( dB/m )	Cable Loss ( dB )	Preamp Factor ( dB )	Ant Pos ( cm )	Table Pos ( deg )	Peak Avg. ( P/A )	Pol. ( H/V )	
802.11ac VHT20 CH 01 2412MHz		4824	38.72	-35.28	74	56.56	31.56	7.33	57.24	100	0	P	H	
													H	
													H	
													H	
			4824	39.73	-34.27	74	57.57	31.56	7.33	57.24	100	0	P	V
														V
														V
Remark	1. No other spurious found. 2. All results are PASS against Peak and Average limit line.													





2.4GHz 2400~2483.5MHz

Emission below 1GHz

2.4GHz WIFI 802.11b (LF)

WIFI Ant.	Note	Frequency	Level	Over Limit	Limit Line	Read Level	Antenna Factor	Cable Loss	Preamp Factor	Ant Pos	Table Pos	Peak Avg.	Pol.	
1		( MHz )	( dBμV/m )	( dB )	( dBμV/m )	( dBμV )	( dB/m )	( dB )	( dB )	( cm )	( deg )	( P/A )	( H/V )	
2.4GHz 802.11b LF		63.48	14.37	-25.63	40	37.66	8.2	0.84	32.31			P	H	
		92.64	19.26	-24.24	43.5	39.96	10.52	0.95	32.29			P	H	
		176.61	24.46	-19.04	43.5	43.32	11.98	1.35	32.27	100	0	P	H	
		547.8	21.87	-24.13	46	29.65	21.99	2.33	32.2			P	H	
		726.3	25.27	-20.73	46	30.1	24.53	2.66	32.12			P	H	
		946.1	29.87	-16.13	46	30.12	27.64	3.06	31.09			P	H	
														H
														H
														H
														H
														H
														H
			31.62	28	-12	40	38.8	20.97	0.59	32.34			P	V
			92.64	23.67	-19.83	43.5	44.37	10.52	0.95	32.29			P	V
			175.8	33.56	-9.94	43.5	52.39	12.01	1.35	32.27	100	0	P	V
			595.4	23.65	-22.35	46	30.77	22.6	2.39	32.21			P	V
			827.8	27.03	-18.97	46	30.38	25.57	2.81	31.86			P	V
			953.8	31.26	-14.74	46	30.94	28.14	3.06	31.02			P	V
														V
														V
													V	
													V	
													V	
													V	
Remark	1. No other spurious found. 2. All results are PASS against limit line.													





**Note symbol**

*	<b>Fundamental Frequency</b> which can be ignored. However, the level of any unwanted emissions shall not exceed the level of the fundamental frequency.
!	Test result is <b>over limit</b> line.
P/A	<b>Peak</b> or <b>Average</b>
H/V	<b>Horizontal</b> or <b>Vertical</b>



A calculation example for radiated spurious emission is shown as below:

WIFI	Note	Frequency	Level	Over	Limit	Read	Antenna	Cable	Preamp	Ant	Table	Peak	Pol.
Ant.				Limit	Line	Level	Factor	Loss	Factor	Pos	Pos	Avg.	
1		( MHz )	( dBμV/m )	( dB )	( dBμV/m )	( dBμV )	( dB/m )	( dB )	( dB )	( cm )	( deg )	( P/A )	( H/V )
802.11b		2390	55.45	-18.55	74	54.51	32.22	4.58	35.86	103	308	P	H
CH 01													
2412MHz		2390	43.54	-10.46	54	42.6	32.22	4.58	35.86	103	308	A	H

- Level(dBμV/m) =  
Antenna Factor(dB/m) + Cable Loss(dB) + Read Level(dBμV) - Preamp Factor(dB)
- Over Limit(dB) = Level(dBμV/m) – Limit Line(dBμV/m)

**For Peak Limit @ 2390MHz:**

- Level(dBμV/m)  
= Antenna Factor(dB/m) + Cable Loss(dB) + Read Level(dBμV) - Preamp Factor(dB)  
= 32.22(dB/m) + 4.58(dB) + 54.51(dBμV) – 35.86 (dB)  
= 55.45 (dBμV/m)
- Over Limit(dB)  
= Level(dBμV/m) – Limit Line(dBμV/m)  
= 55.45(dBμV/m) – 74(dBμV/m)  
= -18.55(dB)

**For Average Limit @ 2390MHz:**

- Level(dBμV/m)  
= Antenna Factor(dB/m) + Cable Loss(dB) + Read Level(dBμV) - Preamp Factor(dB)  
= 32.22(dB/m) + 4.58(dB) + 42.6(dBμV) – 35.86 (dB)  
= 43.54 (dBμV/m)
- Over Limit(dB)  
= Level(dBμV/m) – Limit Line(dBμV/m)  
= 43.54(dBμV/m) – 54(dBμV/m)  
= -10.46(dB)

Both peak and average measured complies with the limit line, so test result is “PASS”.



## Appendix C. Radiated Spurious Emission Plots

Test Engineer :	Alex Jheng , Bill Chang , and Wilson Wu	Temperature :	22~24°C
		Relative Humidity :	43~44%

### Note symbol

-L	Low channel location
-R	High channel location

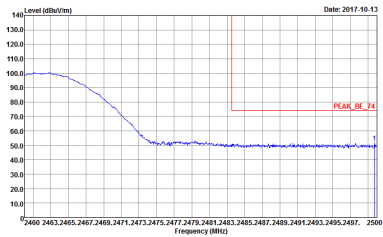
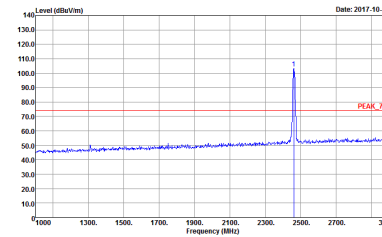
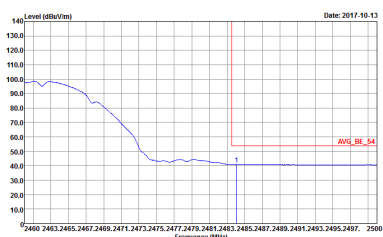
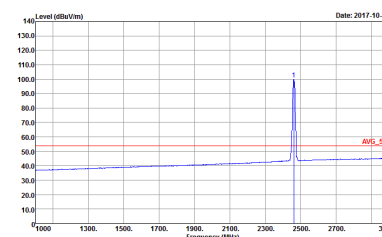

**2.4GHz 2400~2483.5MHz**  
**WIFI 802.11b (Band Edge @ 3m)**

WIFI	2.4GHz 2400~2483.5MHz Band Edge @ 3m	
ANT	802.11b CH11 2462MHz	
1	Horizontal	Fundamental
<b>Peak</b>	 <p>Site : 03CH13-HY Condition : PEAK BE 74 3m HORN 9120D 1241 HORIZONTAL</p>	 <p>Site : 03CH13-HY Condition : PEAK 74 3m HORN 9120D 1241 HORIZONTAL</p>
<b>Avg.</b>	 <p>Site : 03CH13-HY Condition : AVG BE 54 3m HORN 9120D 1241 HORIZONTAL</p>	 <p>Site : 03CH13-HY Condition : AVG 54 3m HORN 9120D 1241 HORIZONTAL</p>



WIFI	2.4GHz 2400~2483.5MHz Band Edge @ 3m	
ANT	802.11b CH11 2462MHz	
1	Vertical	Fundamental
Peak	<p>Site : 03CH13-HY Condition : PEAK_BE 74 3m HORN 9120D 1241 VERTICAL</p>	<p>Site : 03CH13-HY Condition : PEAK 74 3m HORN 9120D 1241 VERTICAL</p>
Avg.	<p>Site : 03CH13-HY Condition : AVG_BE 54 3m HORN 9120D 1241 VERTICAL</p>	<p>Site : 03CH13-HY Condition : AVG 54 3m HORN 9120D 1241 VERTICAL</p>

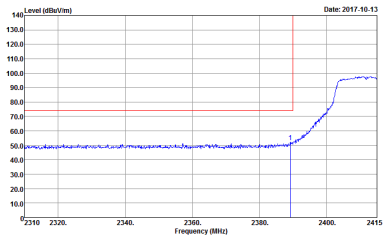
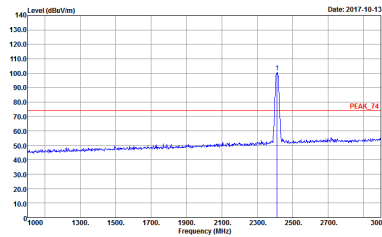
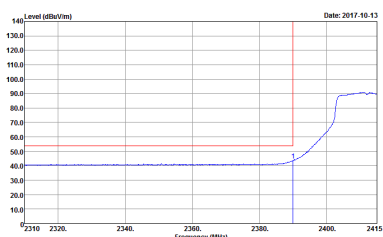
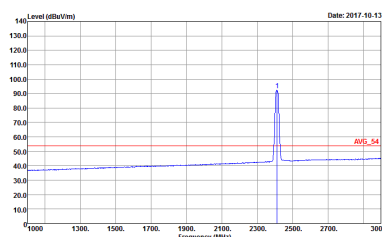

**2.4GHz 2400~2483.5MHz**  
**WIFI 802.11ac VHT20 (Band Edge @ 3m)**

WIFI	2.4GHz 2400~2483.5MHz Band Edge @ 3m	
ANT	802.11ac VHT20 CH01 2412MHz	
1	Horizontal	Fundamental
<b>Peak</b>	 <p>Site : 03CH13-HY Condition : PEAK BE 74 3m HORN 9120D 1241 HORIZONTAL</p>	 <p>Site : 03CH13-HY Condition : PEAK 74 3m HORN 9120D 1241 HORIZONTAL</p>
<b>Avg.</b>	 <p>Site : 03CH13-HY Condition : AVG BE 54 3m HORN 9120D 1241 HORIZONTAL</p>	 <p>Site : 03CH13-HY Condition : AVG 54 3m HORN 9120D 1241 HORIZONTAL</p>





WIFI	2.4GHz 2400~2483.5MHz Band Edge @ 3m	
ANT	802.11ac VHT20 CH01 2412MHz	
1	Vertical	Fundamental
Peak	<p>Site : 03CH13-HY Condition : PEAK BE 74 3m HORN 9120D 1241 VERTICAL</p>	<p>Site : 03CH13-HY Condition : PEAK 74 3m HORN 9120D 1241 VERTICAL</p>
Avg.	<p>Site : 03CH13-HY Condition : AV6 BE 54 3m HORN 9120D 1241 VERTICAL</p>	<p>Site : 03CH13-HY Condition : AV6 54 3m HORN 9120D 1241 VERTICAL</p>



2.4GHz 2400~2483.5MHz  
WIFI 802.11b (Harmonic @ 3m)

WIFI	2.4GHz 2400~2483.5MHz Harmonic @ 3m	
ANT	802.11b CH11 2462MHz	
1	Horizontal	Vertical
Peak Avg.	<p>Site : 03CH13-14Y Condition : PEAK 74 3m SHF HORN 584 HORIZONTAL</p>	<p>Site : 03CH13-14Y Condition : PEAK 74 3m SHF HORN 584 VERTICAL</p>



**2.4GHz 2400~2483.5MHz**  
**WIFI 802.11ac VHT20 (Harmonic @ 3m)**

WIFI	2.4GHz 2400~2483.5MHz Harmonic @ 3m	
ANT	802.11ac VHT20 CH01 2412MHz	
1	Horizontal	Vertical
<p><b>Peak</b></p> <p><b>Avg.</b></p>		



Emission below 1GHz  
2.4GHz WIFI 802.11b (LF)

WIFI	2.4GHz 2400~2483.5MHz	
ANT	802.11b LF	
1	Horizontal	Vertical
QP / Peak	<p>Site : 03CH13-HY Condition : QP-3m B1LOG 40103 HORIZONTAL</p>	<p>Site : 03CH13-HY Condition : QP-3m B1LOG 40103 VERTICAL</p>



Emission below 1GHz  
2.4GHz WIFI 802.11ac VHT20 (LF)

WIFI	2.4GHz 2400~2483.5MHz	
ANT	802.11ac VHT20 LF	
1	Horizontal	Vertical
QP / Peak	<p>Site : 03CH13-HY Condition : QP-3m B1LOG 40103 HORIZONTAL</p>	<p>Site : 03CH13-HY Condition : QP-3m B1LOG 40103 VERTICAL</p>



### Appendix D. Duty Cycle Plots

Band	Duty Cycle(%)	T(us)	1/T(kHz)	VBW Setting
802.11b	98.54	-	-	10Hz
802.11ac VHT20	92.49	1897	0.53	1kHz



802.11b

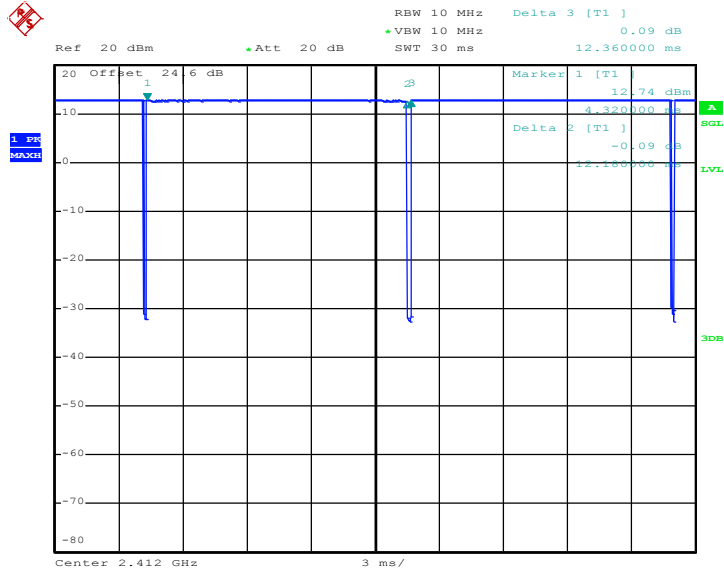

Date: 10.AUG.2017 17:16:46

802.11ac VHT20

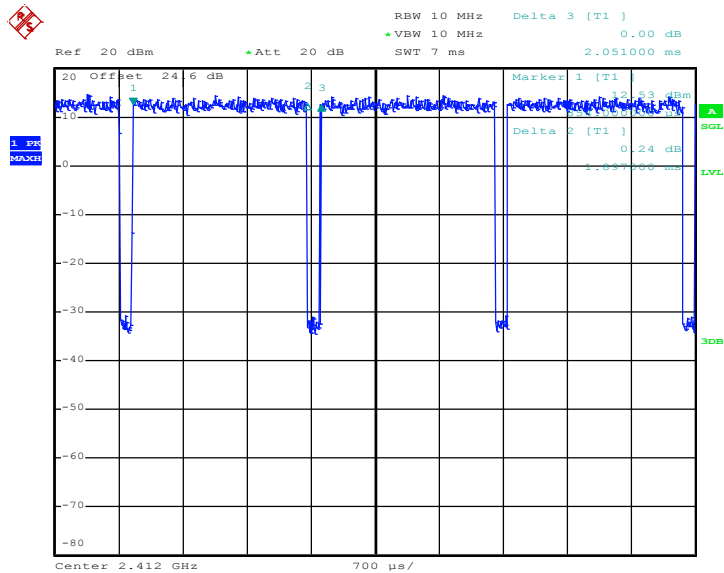

Date: 10.AUG.2017 17:24:05



## **Appendix E. Original Report**

Please refer to Sporton report number FR760710-01C