



FCC RF Test Report

APPLICANT : Sony Mobile Communications Inc.
EQUIPMENT : GSM/WCDMA/LTE Phone+Bluetooth, DTS/UNII
a/b/g/n/ac and NFC
BRAND NAME : Sony
FCC ID : PY7-57442Z
STANDARD : FCC Part 15 Subpart C §15.225
CLASSIFICATION : (DXX) Low Power Communication Device Transmitter

This is a variant report which is only valid together with the original test report. The testing was completed on Oct. 12, 2017. We, SPORTON INTERNATIONAL INC., would like to declare that the tested sample has been evaluated in accordance with the test procedures and has been in compliance with the applicable technical standards.

The test results in this report apply exclusively to the tested model / sample. Without written approval of SPORTON INTERNATIONAL INC., the test report shall not be reproduced except in full.

Reviewed by: Joseph Lin / Supervisor

Approved by: Jones Tsai / Manager



SPORTON INTERNATIONAL INC.

No. 52, Hwa Ya 1st Rd., Hwa Ya Technology Park, Kwei-Shan District, Tao Yuan City, Taiwan, R.O.C.



TABLE OF CONTENTS

REVISION HISTORY.....3

SUMMARY OF THE TEST RESULT4

1. GENERAL INFORMATION.....5

 1.1 Applicant..... 5

 1.2 Manufacturer 5

 1.3 Product Feature of Equipment Under Test 5

 1.4 Product Specification of Equipment Under Test 6

 1.5 Modification of EUT 6

 1.6 Testing Location 7

 1.7 Applicable Standards..... 7

2. TEST CONFIGURATION OF EQUIPMENT UNDER TEST8

 2.1 Descriptions of Test Mode 8

 2.2 Connection Diagram of Test System 8

 2.3 EUT Operation Test Setup 8

3. TEST RESULTS.....9

 3.1 Radiated Emissions Measurement 9

 3.2 Antenna Requirements..... 12

4. LIST OF MEASURING EQUIPMENT13

APPENDIX A. TEST RESULTS OF RADIATED TEST ITEMS

 A1. Results of Radiated Emissions (9 kHz~30MHz)

 A2. Results of Radiated Emissions (30MHz~1GHz)

APPENDIX B. ORIGINAL REPORT



SUMMARY OF THE TEST RESULT

Applied Standard: 47 CFR FCC Part 15 Subpart C				
Part	FCC Rule	Description of Test	Result	Under Limit
3.1	15.225(d) 15.209	Radiated Emissions	Complies	8.00 dB at 30.270 MHz
3.2	15.203	Antenna Requirements	Complies	-

Test Items	Uncertainty	Remark
Radiated Emissions (30MHz~1000MHz)	±5.70dB	Confidence levels of 95%



1. GENERAL INFORMATION

1.1 Applicant

Sony Mobile Communications Inc.

4-12-3 Higashi-Shinagawa, Shinagawa-ku, Tokyo, 140-0002, Japan

1.2 Manufacturer

Sony Mobile Communications Inc.

4-12-3 Higashi-Shinagawa, Shinagawa-ku, Tokyo, 140-0002, Japan

1.3 Product Feature of Equipment Under Test

GSM/WCDMA/LTE, Bluetooth, DTS/UNII a/b/g/n/ac, FM Receiver, NFC, and GPS.

Standards-related Product Specification	
Antenna Type / Gain	Loop Antenna

Remark: This is a variant report. All the test cases were performed on original report which can be referred to Sporton Report Number FR760710-01D.

EUT Information List			
HW Version	SW Version	S/N	Performed Test Item
A	1.14	CQ300004NQ	Radiated Spurious Emission

Accessory List	
AC Adapter 1	Model Name: UCH12
	S/N: 3015W41611569
Earphone 1	Model Name: MH410c
	S/N: N/A
USB Cable	Model Name: UCB20
	S/N: 1635A9100031498

Note:

- Above EUT list and accessory list used are electrically identical per declared by manufacturer.
- Above the accessories list are used to exercise the EUT during test.
- For other wireless features of this EUT, test report will be issued separately.



1.4 Product Specification of Equipment Under Test

Standards-related Product Specification	
Tx/Rx Frequency Range	13.553 ~ 13.567MHz
Channel Number	1
Type of Modulation	ASK

Remark: The above EUT's information was declared by manufacturer. Please refer to the specifications or user's manual for more detailed description.

1.5 Modification of EUT

No modifications are made to the EUT during all test items.



1.6 Testing Location

Sporton Lab is accredited to ISO 17025 by Taiwan Accreditation Foundation (TAF code : 1190) and the FCC designation No. TW1190 under the FCC 2.948(e) by Mutual Recognition Agreement (MRA) in FCC Test.

Test Site	SPORTON INTERNATIONAL INC.
Test Site Location	No. 52, Hwa Ya 1 st Rd., Hwa Ya Technology Park, Kwei-Shan District, Tao Yuan City, Taiwan, R.O.C. TEL: +886-3-3273456 / FAX: +886-3-3284978
Test Site No.	Sporton Site No. 03CH07-HY
Test Engineer	Stan Hsieh
Temperature	22~24°C
Relative Humidity	51~53%

Note: The test site complies with ANSI C63.4 2014 requirement.

1.7 Applicable Standards

According to the specifications of the manufacturer, the EUT must comply with the requirements of the following standards:

- ♦ FCC Part 15 Subpart C §15.225
- ♦ FCC KDB 414788 D01 Radiated Test Site v01
- ♦ ANSI C63.10-2013

2. TEST CONFIGURATION OF EQUIPMENT UNDER TEST

2.1 Descriptions of Test Mode

Investigation has been done on all the possible configurations.

The following table is a list of the test modes shown in this test report.

Test Items	
Radiated Emissions 9kHz~30MHz	Radiated Emissions 30MHz~1GHz

The EUT pre-scanned in four NFC type, A, B, F, V. The worst type (type F) was recorded in this report. Pre-scanned tests, X, Y, Z in three orthogonal panels to determine the final configuration (Y plane as worst plane) from all possible combinations.

2.2 Connection Diagram of Test System

< For Radiated Emissions Measurement >

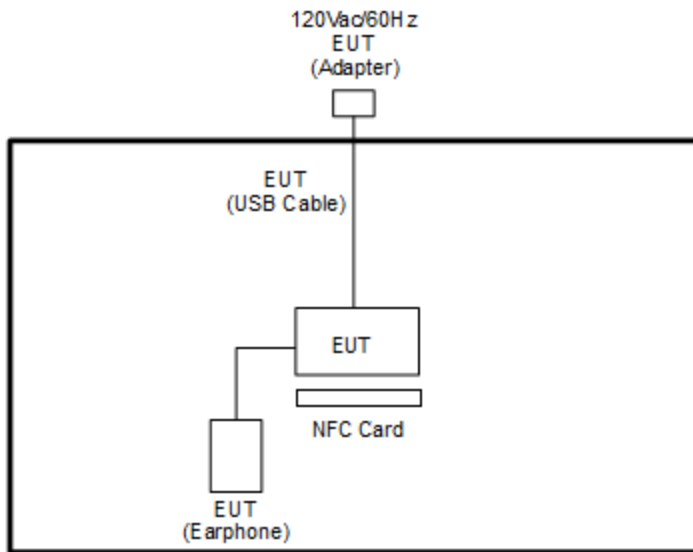

2.3 EUT Operation Test Setup

The EUT was programmed to be in continuously transmitting mode.

The ancillary equipment, NFC card, is used to make the EUT (NFC) continuously transmit at 13.56MHz and is placed around 1 cm gap to the EUT.



3. TEST RESULTS

3.1 Radiated Emissions Measurement

3.1.1 Limit

The field strength of any emissions which appear outside of 13.110 ~14.010MHz band shall not exceed the general radiated emissions limits.

Frequencies (MHz)	Field Strength (µV/m)	Measurement Distance (meters)
0.009~0.490	2400/F(kHz)	300
0.490~1.705	24000/F(kHz)	30
1.705~30.0	30	30
30~88	100	3
88~216	150	3
216~960	200	3
Above 960	500	3

3.1.2 Measuring Instruments

See list of measuring instruments of this test report.

3.1.3 Measuring Instrument Setting

The following table is the setting of receiver.

Receiver Parameter	Setting
Attenuation	Auto
Frequency Range: 9kHz~150kHz	RBW 200Hz for QP
Frequency Range: 150kHz~30MHz	RBW 9kHz for QP
Frequency Range: 30MHz~1000MHz	RBW 120kHz for Peak

Note: The emission limits shown in the above table are based on measurements employing a CISPR quasi-peak detector except for the frequency bands 9-90 kHz, 110-490 kHz. Radiated emission limits in these two bands are based on measurements employing an average detector.



3.1.4 Test Procedures

1. Configure the EUT according to ANSI C63.10. The EUT was placed on the top of the turntable 0.8 meter above ground. The phase center of the receiving antenna mounted on the top of a height-variable antenna tower was placed 3 meters far away from the turntable.
2. Power on the EUT and all the supporting units. The turntable was rotated by 360 degrees to determine the position of the highest radiation.
3. The height of the broadband receiving antenna was varied between one meter and four meters above ground to find the maximum emissions field strength of both horizontal and vertical polarization.
4. For each suspected emissions, the antenna tower was scan (from 1 M to 4 M) and then the turntable was rotated (from 0 degree to 360 degrees) to find the maximum reading.
5. Set the test-receiver system to Peak or CISPR quasi-peak Detect Function with specified bandwidth under Maximum Hold Mode.
6. When the radiated emissions limits are expressed in terms of the average value of the emissions, and pulsed operation is employed, the measurement field strength shall be determined by averaging over one complete pulse train, including blanking intervals, as long as the pulse train does not exceed 0.1 seconds. As an alternative (provided the transmitter operates for longer than 0.1 seconds) or in cases where the pulse train exceeds 0.1 seconds, the measured field strength shall be determined from the average absolute voltage during a 0.1 second interval during which the field strength is at its maximum value.
7. In case the emission is lower than 30MHz, loop antenna has to be used for measurement and the recorded data should be QP measured by receiver. Antenna Requirements

3.1.5 Test Setup

For radiated emissions below 30MHz

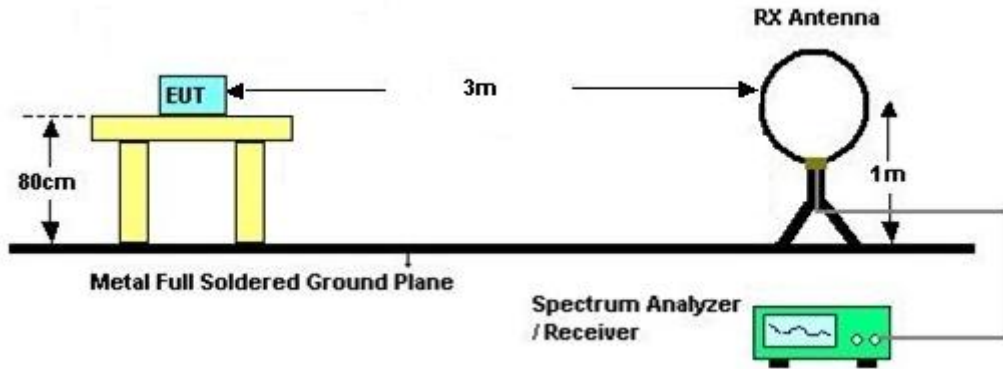

For radiated emissions above 30MHz

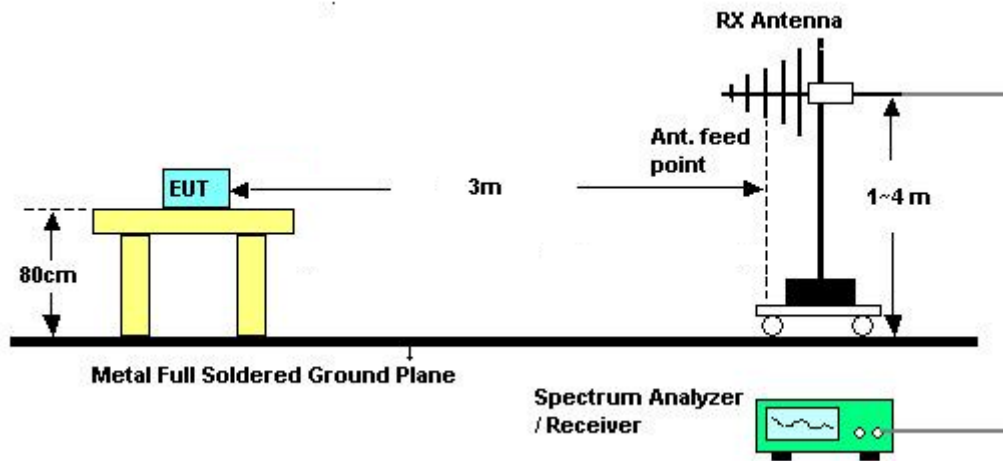

3.1.6 Test Result of Radiated Emissions Measurement

Please refer to Appendix A.

Note: There is a comparison data of both open-field test site and semi-Anechoic chamber, and the result came out very similar.



3.2 Antenna Requirements

3.2.1 Standard Applicable

Except for special regulations, the Low-power Radio-frequency Devices must not be equipped with any jacket for installing an antenna with extension cable. An intentional radiator shall be designed to ensure that no antenna other than that furnished by the responsible party shall be used with the device. The use of a permanently attached antenna or of an antenna that uses a unique coupling to the intentional radiator shall be considered sufficient to comply with the provisions of this Section. The manufacturer may design the unit so that the user can replace a broken antenna, but the use of a standard antenna jack or electrical connector is prohibited.

The use of a permanently attached antenna or of an antenna that uses a unique coupling to the intentional radiator shall be considered sufficient to comply with the rule.

3.2.2 Antenna Anti-Replacement Construction

An embedded-in antenna design is used.



4. LIST OF MEASURING EQUIPMENT

Instrument	Manufacturer	Model No.	Serial No.	Characteristics	Calibration Date	Test Date	Due Date	Remark
Bilog Antenna	TESEQ	CBL 6111D&0080 0N1D01N-06	35419&03	30MHz to 1GHz	Jan. 07, 2017	Oct. 11, 2017~ Oct. 12, 2017	Jan. 06, 2018	Radiation (03CH07-HY)
Loop Antenna	Rohde & Schwarz	HFH2-Z2	100315	9 kHz~30 MHz	May 15, 2017	Oct. 11, 2017~ Oct. 12, 2017	May 14, 2019	Radiation (03CH07-HY)
EMI Test Receiver	Agilent	N9038A(MX E)	MY5329005 3	20Hz to 26.5GHz	Jan. 12, 2017	Oct. 11, 2017~ Oct. 12, 2017	Jan. 11, 2018	Radiation (03CH07-HY)
Preamplifier	COM-POWER	PA-103A	161241	10MHz-1GHz	Mar. 14, 2017	Oct. 11, 2017~ Oct. 12, 2017	Mar. 13, 2018	Radiation (03CH07-HY)
Hygrometer	Testo	608-H1	34897197	N/A	N/A	Oct. 11, 2017~ Oct. 12, 2017	N/A	Radiation (03CH07-HY)
Filter	Wainwright	WHK20/100 0C7/40SS	SN2	20M High Pass	Nov. 22, 2016	Oct. 11, 2017~ Oct. 12, 2017	Nov. 21, 2017	Radiation (03CH07-HY)
RF Cable	HUBER + SUHNER	SUCOFLEX 104	Y84209521+ MY8420952 1	9KHz~30MHz	Jan. 03, 2017	Oct. 11, 2017~ Oct. 12, 2017	Jan. 02, 2018	Radiation (03CH07-HY)
RF Cable	HUBER + SUHNER	SUCOFLEX 104	MY8420952 1	30MHz~1GHz	Jan. 03, 2017	Oct. 11, 2017~ Oct. 12, 2017	Jan. 02, 2018	Radiation (03CH07-HY)
Antenna Mast	Max-Full	MFA520BS	N/A	1m~4m	N/A	Oct. 11, 2017~ Oct. 12, 2017	N/A	Radiation (03CH07-HY)
Turn Table	ChainTek	Chaintek 3000	N/A	0~360 Degree	N/A	Oct. 11, 2017~ Oct. 12, 2017	N/A	Radiation (03CH07-HY)
Test Software	Audix	E3	6.2009-8-24	N/A	N/A	Oct. 11, 2017~ Oct. 12, 2017	N/A	Radiation (03CH07-HY)



Appendix A. Test Results of Radiated Test Items

A1. Results of Radiated Spurious Emissions (9 kHz~30MHz)

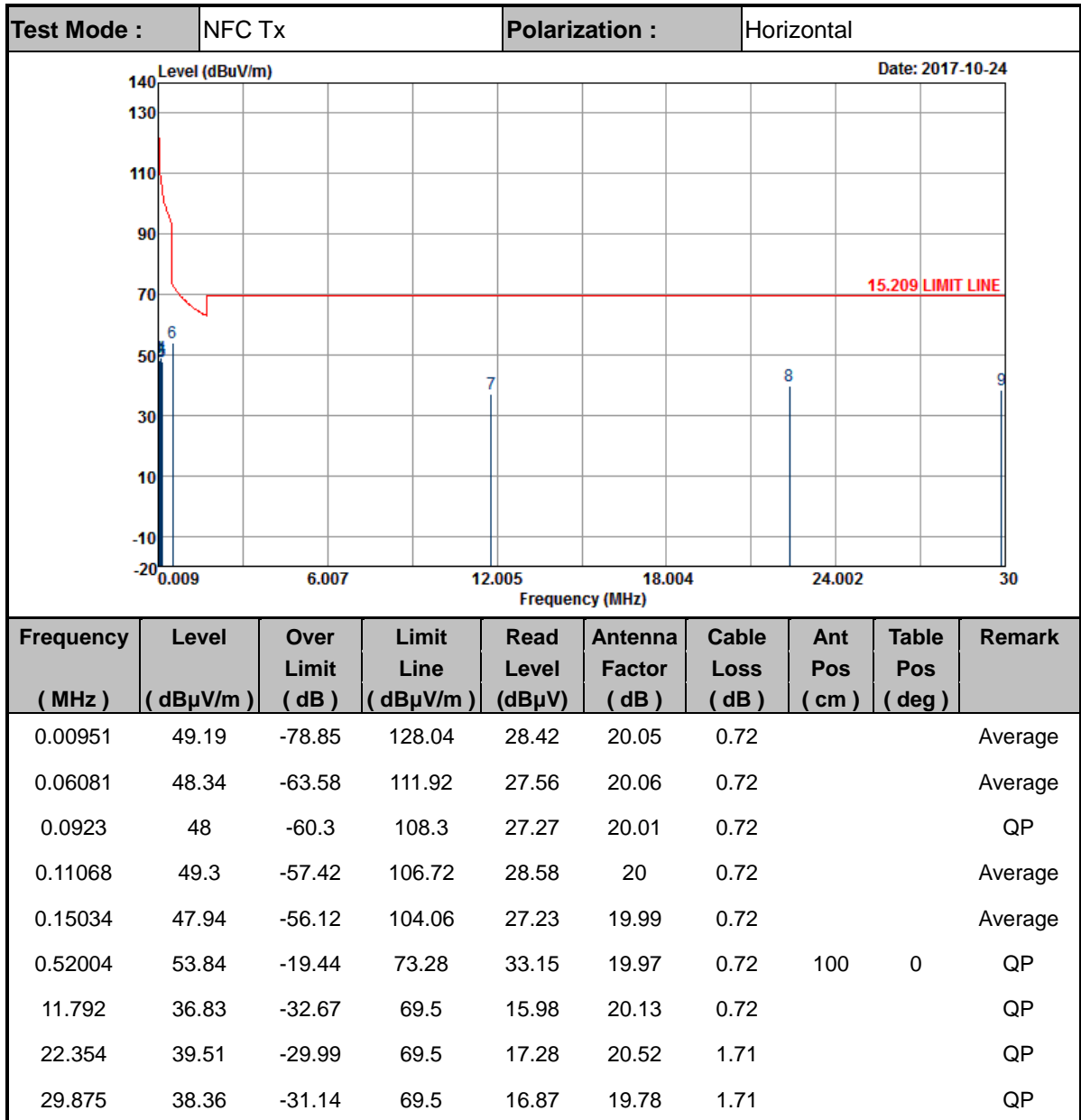

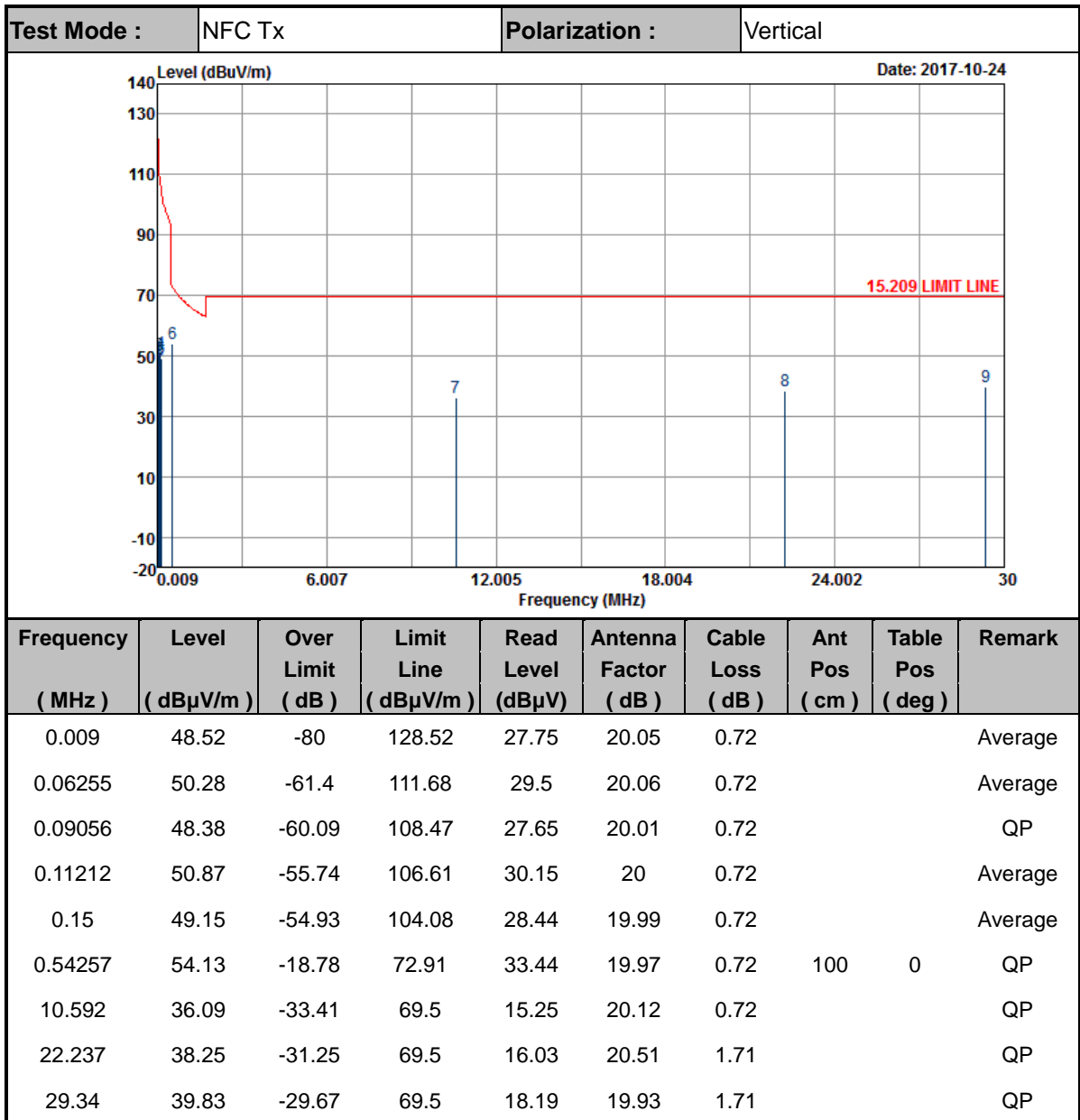

Note:

1. The amplitude of spurious emissions which are attenuated by more than 20dB below the permissible value has no need to be reported.
2. Distance extrapolation factor = 40 log (specific distance / test distance) (dB);
3. Limit line = specific limits (dBμV) + distance extrapolation factor.



A2. Results of Radiated Spurious Emissions (30MHz~1GHz)

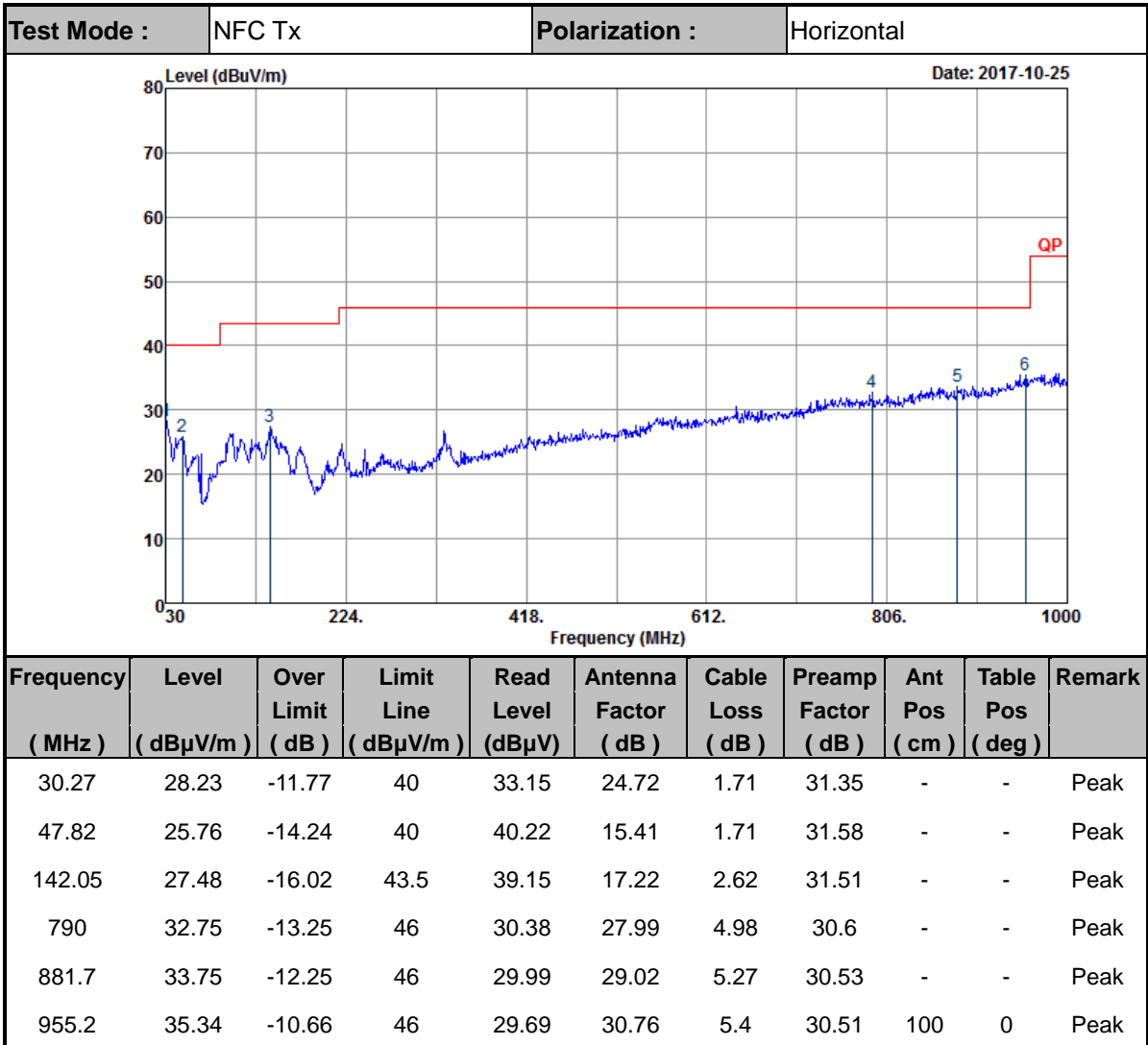

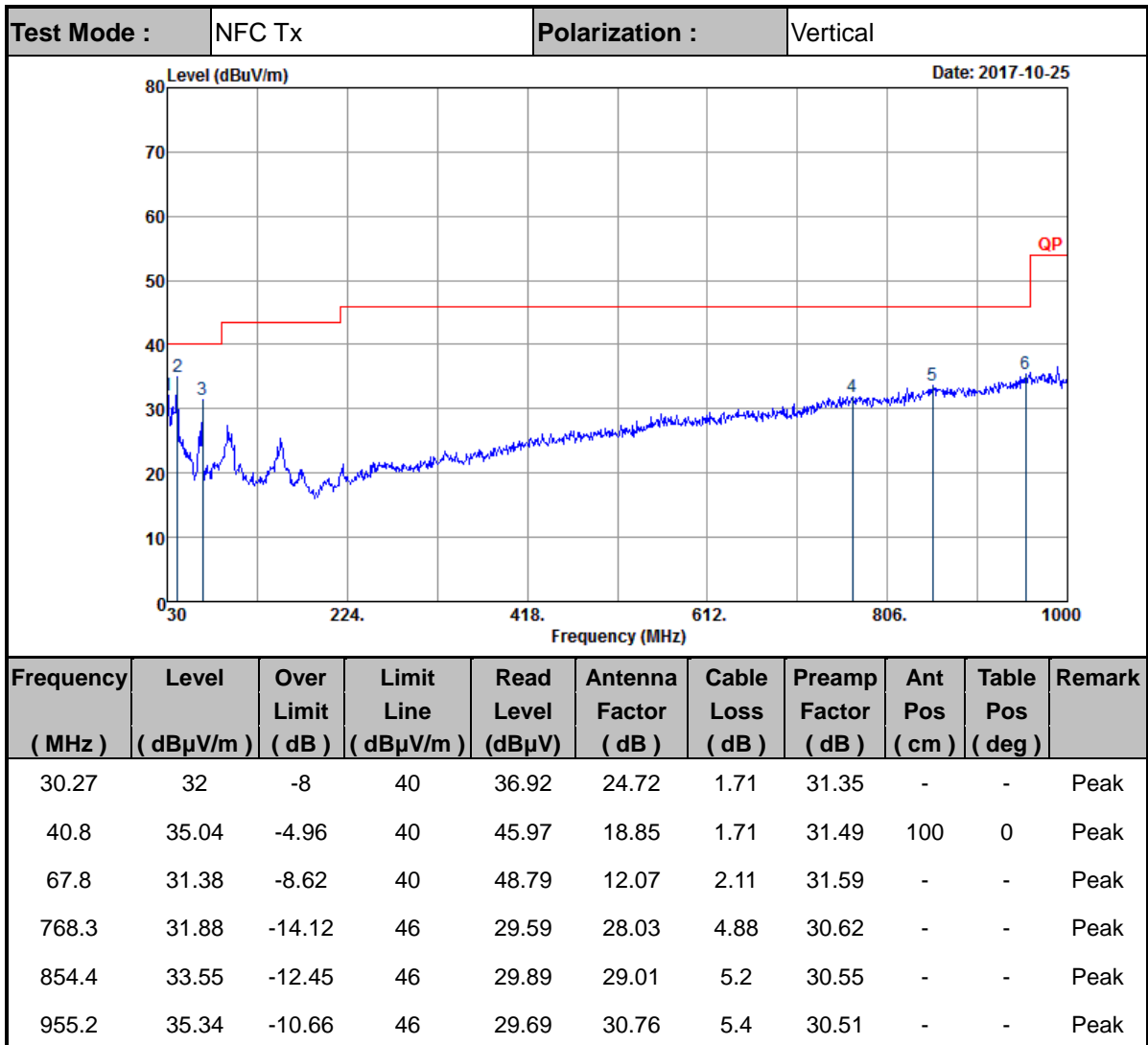

Note:

1. The amplitude of spurious emissions which are attenuated by more than 20dB below the permissible value has no need to be reported.
2. Emission level (dBμV/m) = 20 log Emission level (μV/m).
3. Corrected Reading: Antenna Factor + Cable Loss + Read Level - Preamp Factor= Level.



Appendix B. Original Report

Please refer to Sporton report number FR760710-01D