



FCC RADIO TEST REPORT

FCC ID : PY7-57442Y
Equipment : GSM/WCDMA/LTE PHONE+BLUETOOTH,
DTS/UNII A/B/G/N/AC AND NFC
Brand Name : SONY
Applicant : SONY MOBILE COMMUNICATIONS INC.
4-12-3 HIGASHI-SHINAGAWA,
SHINAGAWA-KU, TOKYO, 140-0002, JAPAN
Manufacturer : SONY MOBILE COMMUNICATIONS INC.
4-12-3 HIGASHI-SHINAGAWA,
SHINAGAWA-KU, TOKYO, 140-0002, JAPAN
Standard : FCC Part 15 Subpart E §15.407

The product was received on Aug. 30, 2018 and testing was started from Sep. 13, 2018 and completed on Sep. 22, 2018. We, SPORTON INTERNATIONAL INC., would like to declare that the tested sample has been evaluated in accordance with the test procedures and has been in compliance with the applicable technical standards.

The report must not be used by the client to claim product certification, approval, or endorsement by TAF or any agency of government.

The test results in this report apply exclusively to the tested model / sample. Without written approval of SPORTON INTERNATIONAL INC. EMC & Wireless Communications Laboratory, the test report shall not be reproduced except in full.

Approved by: Jones Tsai

SPORTON INTERNATIONAL INC. EMC & Wireless Communications Laboratory

No. 52, Huaya 1st Rd., Guishan Dist., Taoyuan City, Taiwan (R.O.C.)



Table of Contents

| | |
|---|-----------|
| History of this test report..... | 3 |
| Summary of Test Result | 4 |
| 1 General Description | 5 |
| 1.1 Product Feature of Equipment Under Test | 5 |
| 1.2 Modification of EUT | 5 |
| 1.3 Testing Location | 6 |
| 1.4 Applicable Standards | 6 |
| 2 Test Configuration of Equipment Under Test | 7 |
| 2.1 Carrier Frequency and Channel | 7 |
| 2.2 Test Mode..... | 8 |
| 2.3 Connection Diagram of Test System..... | 9 |
| 2.4 Support Unit used in test configuration and system..... | 10 |
| 2.5 EUT Operation Test Setup..... | 10 |
| 2.6 Measurement Results Explanation Example | 10 |
| 3 Test Result | 11 |
| 3.1 6dB and 26dB and 99% Occupied Bandwidth Measurement | 11 |
| 3.2 Maximum Conducted Output Power Measurement | 14 |
| 3.3 Power Spectral Density Measurement | 15 |
| 3.4 Unwanted Emissions Measurement | 17 |
| 3.5 AC Conducted Emission Measurement..... | 22 |
| 3.6 Automatically Discontinue Transmission | 24 |
| 3.7 Antenna Requirements | 25 |
| 4 List of Measuring Equipment | 26 |
| 5 Uncertainty of Evaluation | 28 |
| Appendix A. Conducted Test Results | |
| Appendix B. AC Conducted Emission Test Result | |
| Appendix C. Radiated Spurious Emission | |
| Appendix D. Radiated Spurious Emission Plots | |
| Appendix E. Duty Cycle Plots | |



Summary of Test Result

| Report Clause | Ref Std. Clause | Test Items | Result (PASS/FAIL) | Remark |
|---------------|------------------------|--|--------------------|---|
| 3.1 | 15.403 (i) | 6dB & 26dB Bandwidth | Pass | - |
| 3.1 | 2.1049 | 99% Occupied Bandwidth | Reporting only | - |
| 3.2 | 15.407 (a) | Maximum Conducted Output Power | Pass | - |
| 3.3 | 15.407 (a) | Power Spectral Density | Pass | - |
| 3.4 | 15.407(b) | Unwanted Emissions | Pass | Under limit 8.97 dB at 40.800 MHz |
| 3.5 | 15.207 | AC Conducted Emission | Pass | Under limit 9.62 dB at 1.065 MHz |
| 3.6 | 15.407 (c) | Automatically Discontinue Transmission | Pass | - |
| 3.7 | 15.203 & 15.407 (a) | Antenna Requirement | Pass | - |

Reviewed by: Wii Chang

Report Producer: Natasha Hsieh



1 General Description

1.1 Product Feature of Equipment Under Test

GSM/WCDMA/LTE, Bluetooth, DTS/UNII a/b/g/n/ac, FM Receiver, NFC, and GNSS.

| Standards-related Product Specification | |
|---|----------------------------------|
| Antenna Type / Gain | PIFA Antenna with gain -1.60 dBi |

| EUT Information List | | | |
|----------------------|------------|------------|----------------------------|
| HW Version | SW Version | S/N | Performed Test Item |
| A | 1.129 | CQ30015WW8 | RF conducted measurement |
| | | CQ3001BNCD | Radiated Spurious Emission |
| | | CQ30015X2P | AC Conducted Emission |

| Accessory List | |
|----------------|---|
| AC Adapter | Model Name: UCH32 |
| | S/N: 6218W30200215 (for radiated emission) 6218W30200140 (for conducted emission) |
| | Model Name: MH410c |
| Earphone | S/N: N/A |
| | Model Name: UCB24 |
| USB Cable | S/N: N/A |

Note:

1. Above EUT list used are electrically identical per declared by manufacturer.
2. Above the accessories list are used to exercise the EUT during test, and the serial number of each type of accessories is listed in each section of this report. .
3. For other wireless features of this EUT, test report will be issued separately.

1.2 Modification of EUT

No modifications are made to the EUT during all test items.



1.3 Testing Location

Sporton Lab is accredited to ISO 17025 by Taiwan Accreditation Foundation (TAF code : 1190) and the FCC designation No. TW1190 and TW0007 under the FCC 2.948(e) by Mutual Recognition Agreement (MRA) in FCC Test.

| | | |
|---------------------------|---|---------|
| Test Site | SPORTON INTERNATIONAL INC. | |
| Test Site Location | No.52, Huaya 1st Rd., Guishan Dist., Taoyuan City, Taiwan (R.O.C.) TEL: +886-3-327-3456 FAX: +886-3-328-4978 | |
| Test Site No. | Sporton Site No. | |
| | TH05-HY | CO05-HY |

Note: The test site complies with ANSI C63.4 2014 requirement.

| | | |
|---------------------------|---|--|
| Test Site | SPORTON INTERNATIONAL INC. | |
| Test Site Location | No.58, Aly. 75, Ln. 564, Wenhua 3rd, Rd., Guishan Dist., Taoyuan City, Taiwan (R.O.C.) TEL: +886-3-327-0868 FAX: +886-3-327-0855 | |
| Test Site No. | Sporton Site No. | |
| | 03CH16-HY | |

Note: The test site complies with ANSI C63.4 2014 requirement.

1.4 Applicable Standards

According to the specifications of the manufacturer, the EUT must comply with the requirements of the following standards:

- ♦ FCC Part 15 Subpart E
- ♦ FCC KDB 789033 D02 General UNII Test Procedures New Rules v02r01.
- ♦ FCC KDB 414788 D01 Radiated Test Site v01r01.
- ♦ FCC KDB 662911 D01 Multiple Transmitter Output v02r01.
- ♦ ANSI C63.10-2013

Remark:

1. All test items were verified and recorded according to the standards and without any deviation during the test.
2. This EUT has also been tested and complied with the requirements of FCC Part 15, Subpart B, recorded in a separate test report.



2 Test Configuration of Equipment Under Test

- a. The EUT has been associated with peripherals and configuration operated in a manner tended to maximize its emission characteristics in a typical application. Frequency range investigated: conduction emission (150 kHz to 30 MHz), radiation emission (9 kHz to the 10th harmonic of the highest fundamental frequency or to 40 GHz, whichever is lower). For radiated measurement, pre-scanned in three orthogonal panels, X, Y, Z. The worst cases (X plane) were recorded in this report.

- b. AC power line Conducted Emission was tested under maximum output power.

2.1 Carrier Frequency and Channel

| Frequency Band | Channel | Freq. (MHz) | Channel | Freq. (MHz) |
|--------------------------------------|------------------|-------------|---------|-------------|
| 5725-5850 MHz Band 4 (U-NII-3) | 149 | 5745 | 157 | 5785 |
| | 151* | 5755 | 159* | 5795 |
| | 153 | 5765 | 161 | 5805 |
| | 155 [#] | 5775 | 165 | 5825 |

Note:

- 1. The above Frequency and Channel in "*" were 802.11n HT40 and 802.11ac VHT40.
- 2. The above Frequency and Channel in "[#]" were 802.11ac VHT80.



2.2 Test Mode

Final test modes are considering the modulation and worse data rates as below table.

| Modulation | Data Rate |
|----------------------------------|-----------|
| 802.11a | 6 Mbps |
| 802.11n HT20 | MCS0 |
| 802.11n HT40 | MCS0 |
| 802.11ac VHT20 (Covered by HT20) | MCS0 |
| 802.11ac VHT40 (Covered by HT40) | MCS0 |
| 802.11ac VHT80 | MCS0 |

| Test Cases | |
|-----------------------|---|
| AC Conducted Emission | Mode 1 : Bluetooth Link + WLAN (5GHz) Link + Earphone + Battery + USB Cable (Charging from Adapter) |

| Ch. # | | Band IV : 5725-5850 MHz | | |
|-------|--------|-------------------------|--------------|--------------|
| | | 802.11a | 802.11n HT20 | 802.11n HT40 |
| L | Low | 149 | 149 | 151 |
| M | Middle | 157 | 157 | - |
| H | High | 165 | 165 | 159 |

| Ch. # | | Band IV : 5725-5850 MHz |
|-------|--------|-------------------------|
| | | 802.11ac VHT80 |
| L | Low | - |
| M | Middle | 155 |
| H | High | - |

2.3 Connection Diagram of Test System

<WLAN Tx Mode>

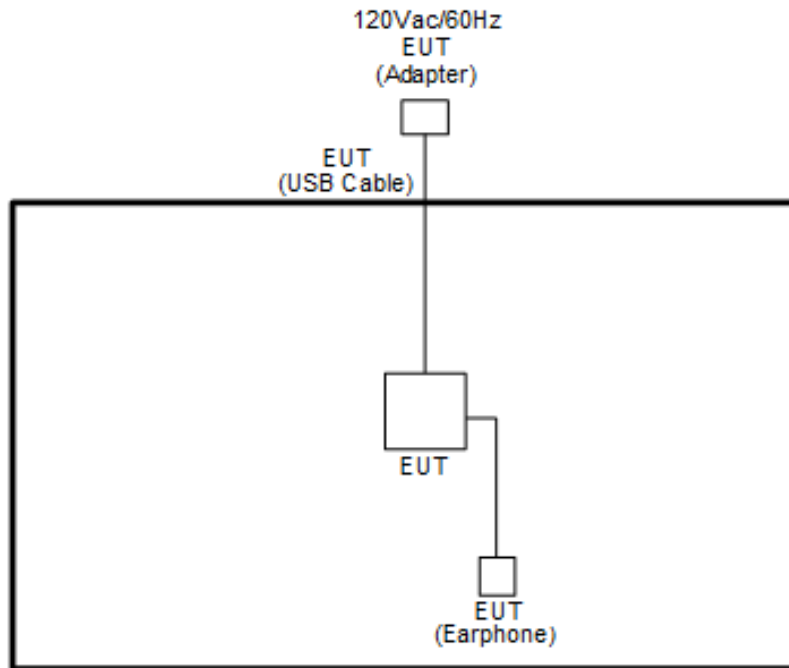

<AC Conducted Emissions Mode>

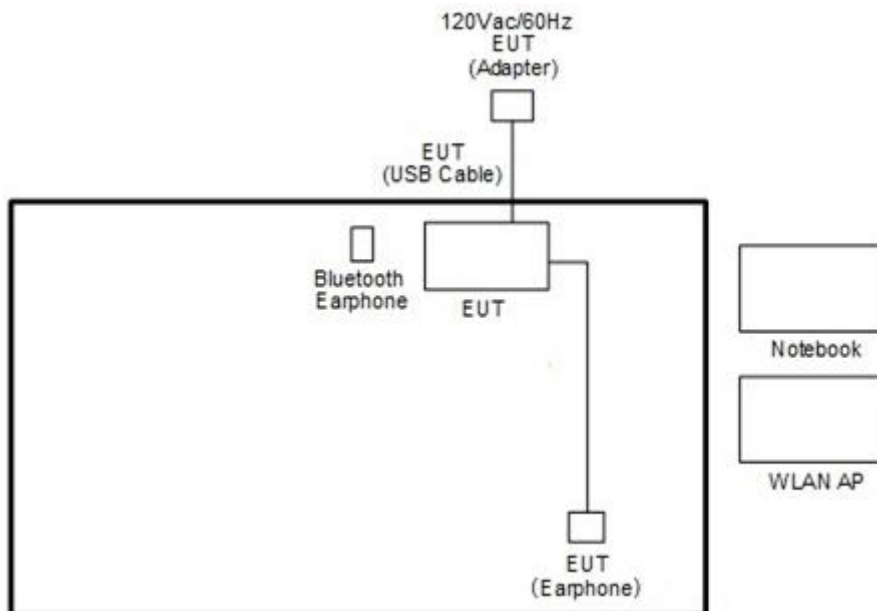



2.4 Support Unit used in test configuration and system

| Item | Equipment | Trade Name | Model Name | FCC ID | Data Cable | Power Cord |
|------|--------------------|------------|------------|--|------------|--|
| 1. | WLAN AP | ASUS | RT-AC66U | MSQ-RTAC66U | N/A | Unshielded, 1.8 m |
| 2. | Bluetooth Earphone | Sony | SBH20 | PY7-RD0010 | N/A | N/A |
| 3. | Notebook | DELL | P20G | FCC DoC/ Contains FCC ID: QDS-BRCM1051 | N/A | AC I/P: Unshielded, 1.2 m DC O/P: Shielded, 1.8 m |
| 4. | SD Card | SanDisk | MicroSD HC | FCC DoC | N/A | N/A |

2.5 EUT Operation Test Setup

The RF test items, utility “QRCT” was installed in Notebook which was programmed in order to make the EUT get into the engineering modes to provide channel selection, power level, data rate and the application type and for continuous transmitting signals.

2.6 Measurement Results Explanation Example

For all conducted test items:

The offset level is set in the spectrum analyzer to compensate the RF cable loss and attenuator factor between EUT conducted output port and spectrum analyzer. With the offset compensation, the spectrum analyzer reading level is exactly the EUT RF output level.

Example :

The spectrum analyzer offset is derived from RF cable loss and attenuator factor.

Offset = RF cable loss + attenuator factor.

Following shows an offset computation example with cable loss 4.2 dB and 10dB attenuator.

$$\begin{aligned} \text{Offset(dB)} &= \text{RF cable loss(dB)} + \text{attenuator factor(dB)}. \\ &= 4.2 + 10 = 14.2 \text{ (dB)} \end{aligned}$$

3 Test Result

3.1 6dB and 26dB and 99% Occupied Bandwidth Measurement

3.1.1 Description of 6dB and 26dB and 99% Occupied Bandwidth

The minimum 6 dB bandwidth shall be at least 500 kHz.

26dB and 99% Occupied bandwidth are reporting only.

3.1.2 Measuring Instruments

See list of measuring equipment of this test report.

3.1.3 Test Procedures

1. The testing follows FCC KDB 789033 D02 General UNII Test Procedures New Rules v02r01. Section C) Emission bandwidth for the band 5.725-5.85GHz
2. Set RBW = 100kHz.
3. Set the VBW $\geq 3 \times$ RBW.
4. Detector = Peak.
5. Trace mode = max hold
6. Measure the maximum width of the emission that is 6 dB down from the peak of the emission.
7. Measure and record the results in the test report.

3.1.4 Test Setup

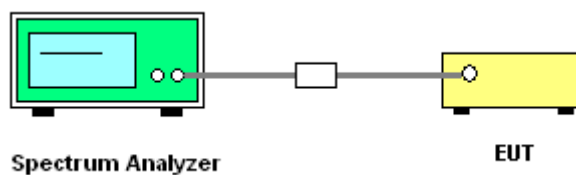

3.1.5 Test Result of 6dB Bandwidth

Please refer to Appendix A.

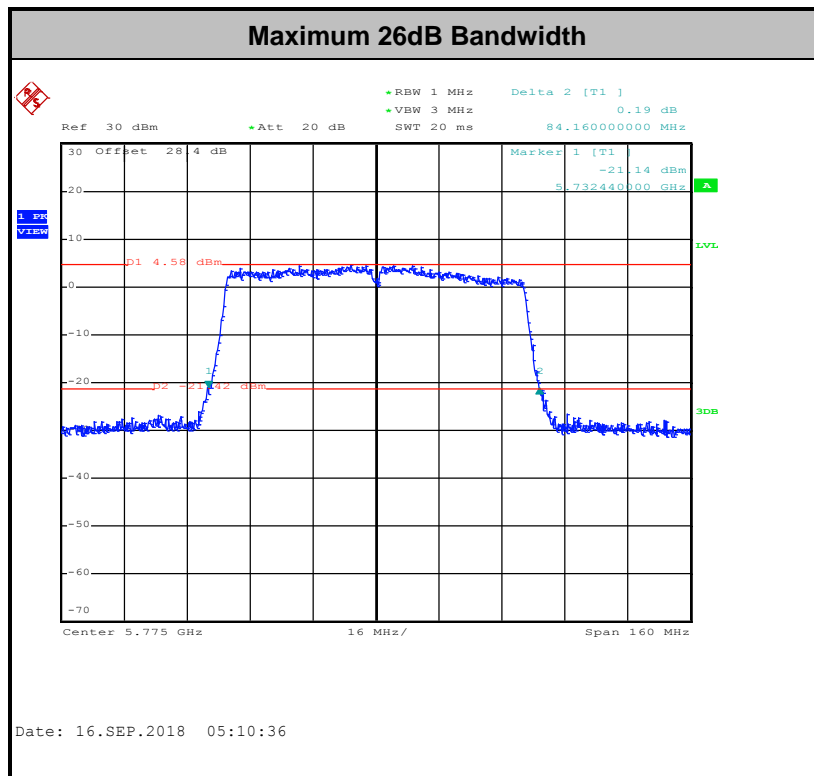
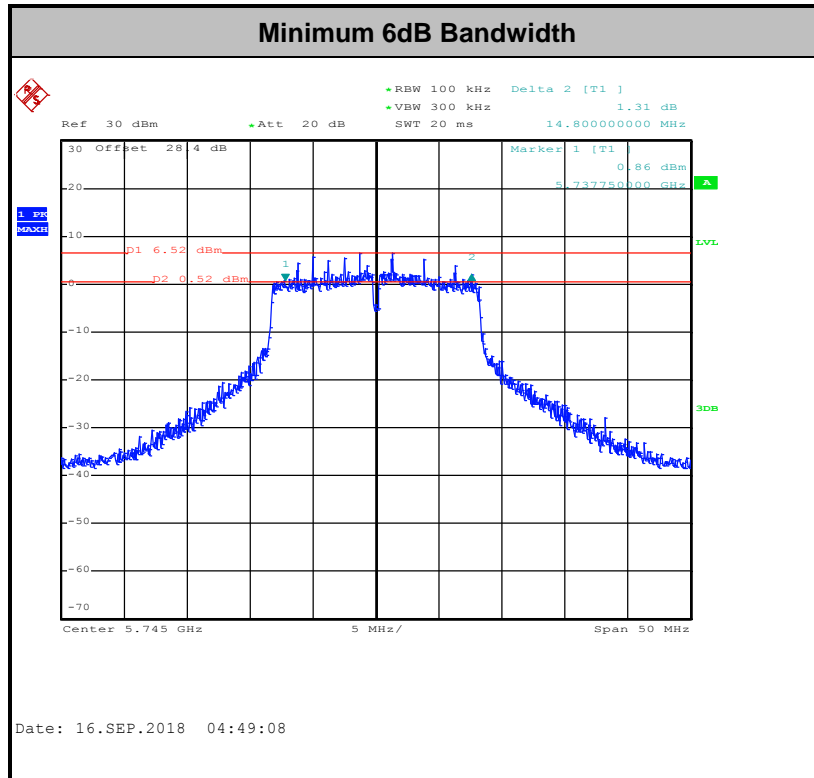

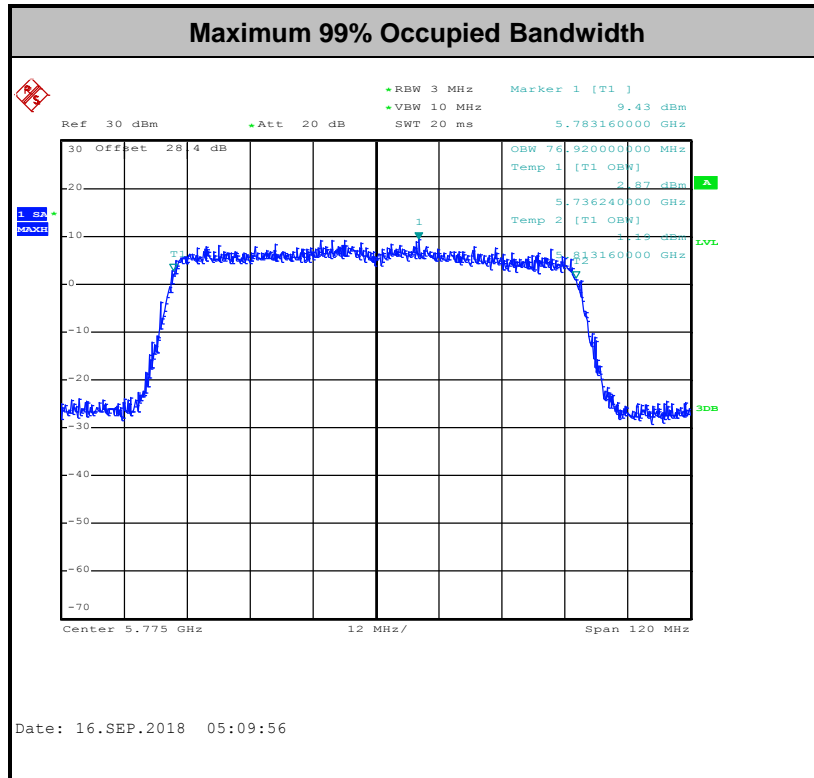

Note: The occupied channel bandwidth is maintained within the band of operation for all of the modulations.

3.2 Maximum Conducted Output Power Measurement

3.2.1 Limit of Maximum Conducted Output Power

For the band 5.725–5.85 GHz, the maximum conducted output power over the frequency band of operation shall not exceed 1 W.

If transmitting antennas of directional gain greater than 6 dBi are used, the peak output power shall be reduced by the amount in dB that the directional gain of the antenna exceeds 6 dBi.

3.2.2 Measuring Instruments

See list of measuring equipment of this test report.

3.2.3 Test Procedures

The testing follows Method PM of FCC KDB 789033 D02 General UNII Test Procedures New Rules v02r01.

Method PM (Measurement using an RF average power meter):

1. Measurement is performed using a wideband RF power meter.
2. The EUT is configured to transmit continuously with a consistent duty cycle at its maximum power control level.
3. Measure the average power of the transmitter, and the average power is corrected with duty factor, $10 \log(1/x)$, where x is the duty cycle.

3.2.4 Test Setup

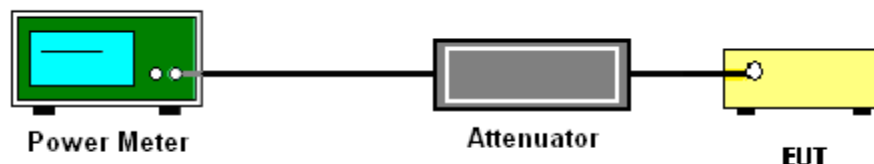

3.2.5 Test Result of Maximum Conducted Output Power

Please refer to Appendix A.



3.3 Power Spectral Density Measurement

3.3.1 Limit of Power Spectral Density

For the band 5.725–5.85 GHz, the maximum power spectral density shall not exceed 30 dBm in any 500-kHz band.

If transmitting antennas of directional gain greater than 6 dBi are used, the peak output power shall be reduced by the amount in dB that the directional gain of the antenna exceeds 6 dBi.

3.3.2 Measuring Instruments

See list of measuring equipment of this test report.

3.3.3 Test Procedures

The testing follows FCC KDB 789033 D02 General UNII Test Procedures New Rules v02r01. Section F) Maximum power spectral density.

Method SA-2

(trace averaging across on and off times of the EUT transmissions, followed by duty cycle correction).

- Measure the duty cycle.
 - Set span to encompass the entire emission bandwidth (EBW) of the signal.
 - Set RBW = 300 kHz.
 - Set VBW \geq 1 MHz.
 - Number of points in sweep \geq 2 Span / RBW.
 - Sweep time = auto.
 - Detector = RMS
 - Trace average at least 100 traces in power averaging mode.
 - Add $10 \log(500\text{kHz}/\text{RBW})$ to the test result.
 - Add $10 \log(1/x)$, where x is the duty cycle, to the measured power in order to compute the average power during the actual transmission times. For example, add $10 \log(1/0.25) = 6$ dB if the duty cycle is 25 percent.
1. The RF output of EUT was connected to the spectrum analyzer by a low loss cable.
 2. Each plot has already offset with cable loss, and attenuator loss. Measure the PPSD and record it.

3.3.4 Test Setup

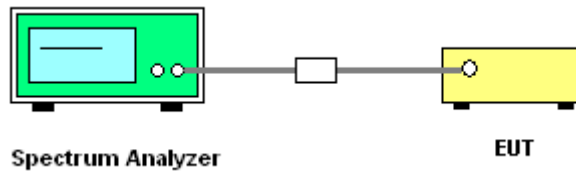

3.3.5 Test Result of Power Spectral Density

Please refer to Appendix A.

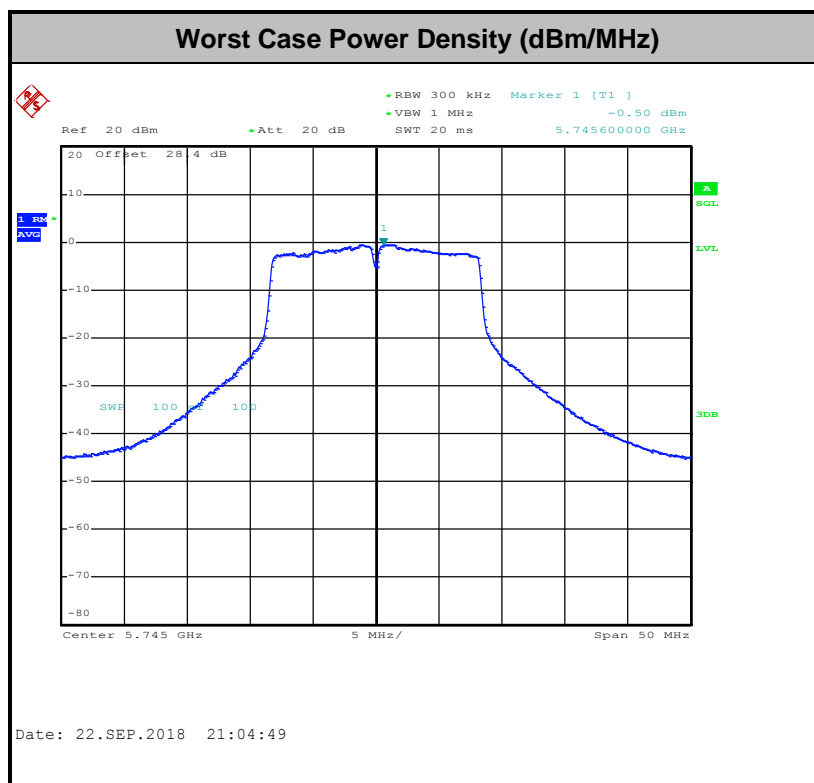



3.4 Unwanted Emissions Measurement

This section is to measure unwanted emissions through radiated measurement for band edge spurious emissions and out of band emissions measurement.

3.4.1 Limit of Unwanted Emissions

- (1) For transmitters operating in the 5.725-5.85 GHz band:
 15.407(b)(4)(i) All emissions shall be limited to a level of -27 dBm/MHz at 75 MHz or more above or below the band edge increasing linearly to 10 dBm/MHz at 25 MHz above or below the band edge, and from 25 MHz above or below the band edge increasing linearly to a level of 15.6 dBm/MHz at 5 MHz above or below the band edge, and from 5 MHz above or below the band edge increasing linearly to a level of 27 dBm/MHz at the band edge.
- (2) Unwanted spurious emissions fallen in restricted bands shall comply with the general field strength limits as below table,

| Frequency (MHz) | Field Strength (microvolts/meter) | Measurement Distance (meters) |
|-----------------|-----------------------------------|-------------------------------|
| 0.009 – 0.490 | 2400/F(kHz) | 300 |
| 0.490 – 1.705 | 24000/F(kHz) | 30 |
| 1.705 – 30.0 | 30 | 30 |
| 30 – 88 | 100 | 3 |
| 88 – 216 | 150 | 3 |
| 216 - 960 | 200 | 3 |
| Above 960 | 500 | 3 |

Note: The following formula is used to convert the EIRP to field strength.

$$E = \frac{1000000\sqrt{30P}}{3} \text{ } \mu\text{V/m, where P is the eirp (Watts)}$$



| EIRP (dBm) | Field Strength at 3m (dBµV/m) |
|------------|-------------------------------|
| - 27 | 68.3 |

(3) KDB789033 D02 v02r01 G)2)c)

- (i) Section 15.407(b)(1) to (b)(3) specify the unwanted emission limits for the U-NII-1 and U-NII-2 bands. As specified, emissions above 1000 MHz that are outside of the restricted bands are subject to a peak emission limit of -27 dBm/MHz.³
- (ii) Section 15.407(b)(4) specifies the unwanted emission limit for the U-NII-3 band. A band emissions mask is specified in Section 15.407(b)(4)(i). The emission limits are in terms of a Peak detector. An alternative to the band emissions mask is specified in Section 15.407(b)(4)(ii). The alternative limits are based on the highest antenna gain specified in the filing. There are also marketing and importation restrictions for the devices using the alternative limit.⁴

Note 3: An out-of-band emission that complies with both the average and peak limits of Section 15.209 is not required to satisfy the -27 dBm/MHz peak emission limit.

Note 4: Only devices with antenna gains of 10 dBi or less may be approved using the emission limits specified in Section 15.247(d) till March 2, 2018; all other devices operating in this band must use the mask specified in Section 15.407(b)(4)(i).

3.4.2 Measuring Instruments

See list of measuring equipment of this test report.

3.4.3 Test Procedures

1. The testing follows FCC KDB 789033 D02 General UNII Test Procedures New Rules v02r01. Section G) Unwanted emissions measurement.
 - (1) Procedure for Unwanted Emissions Measurements Below 1000MHz
 - RBW = 120 kHz
 - VBW = 300 kHz
 - Detector = Peak
 - Trace mode = max hold
 - (2) Procedure for Peak Unwanted Emissions Measurements Above 1000 MHz
 - RBW = 1 MHz
 - VBW ≥ 3 MHz
 - Detector = Peak
 - Sweep time = auto
 - Trace mode = max hold



(3) Procedures for Average Unwanted Emissions Measurements Above 1000MHz

- RBW = 1 MHz
 - VBW = 10 Hz, when duty cycle is no less than 98 percent.
 - $VBW \geq 1/T$, when duty cycle is less than 98 percent where T is the minimum transmission duration over which the transmitter is on and is transmitting at its maximum power control level for the tested mode of operation.
2. The EUT was placed on a turntable with 0.8 meter for frequency below 1GHz and 1.5 meter for frequency above 1GHz respectively above ground.
 3. The EUT was set 3 meters from the interference receiving antenna which was mounted on the top of a variable height antenna tower.
 4. The antenna is a broadband antenna and its height is adjusted between one meter and four meters above ground to find the maximum value of the field strength for both horizontal polarization and vertical polarization of the antenna.
 5. For each suspected emission, the EUT was arranged to its worst case and then adjust the antenna tower (from 1 m to 4 m) and turntable (from 0 degree to 360 degrees) to find the maximum reading.
 6. For testing below 1GHz, if the emission level of the EUT in peak mode was 3 dB lower than the limit specified, then peak values of EUT will be reported, otherwise, the emissions will be repeated one by one using the CISPR quasi-peak method and reported.
 7. For testing above 1GHz, the emission level of the EUT in peak mode was 20dB lower than average limit (that means the emission level in average mode also complies with the limit in average mode), then peak values of EUT will be reported, otherwise, the emissions will be measured in average mode again and reported.

3.4.4 Test Setup

For radiated emissions below 30MHz

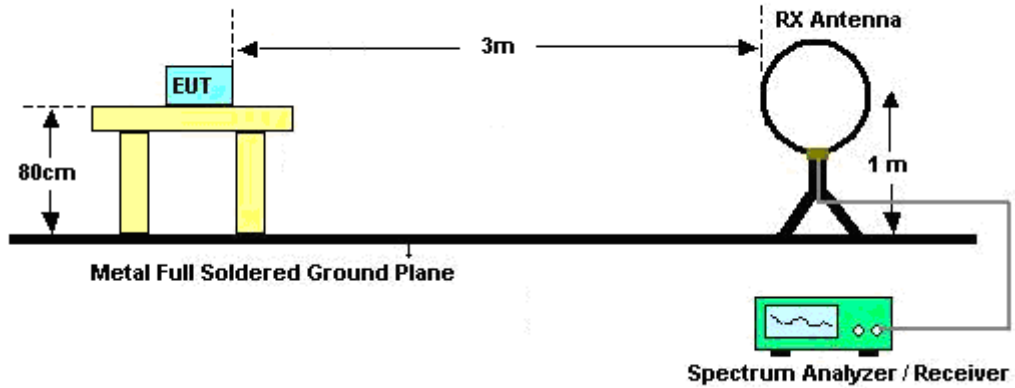

For radiated emissions from 30MHz to 1GHz

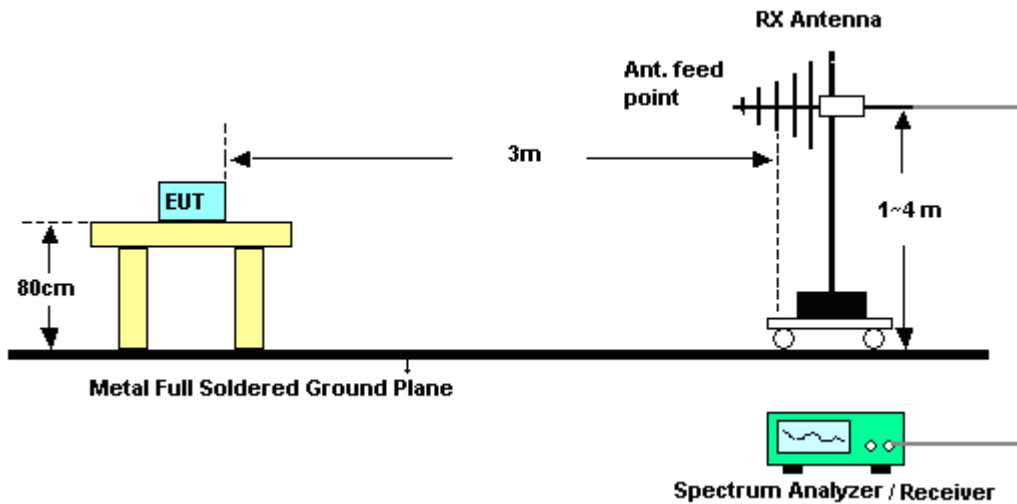

For radiated emissions above 1GHz

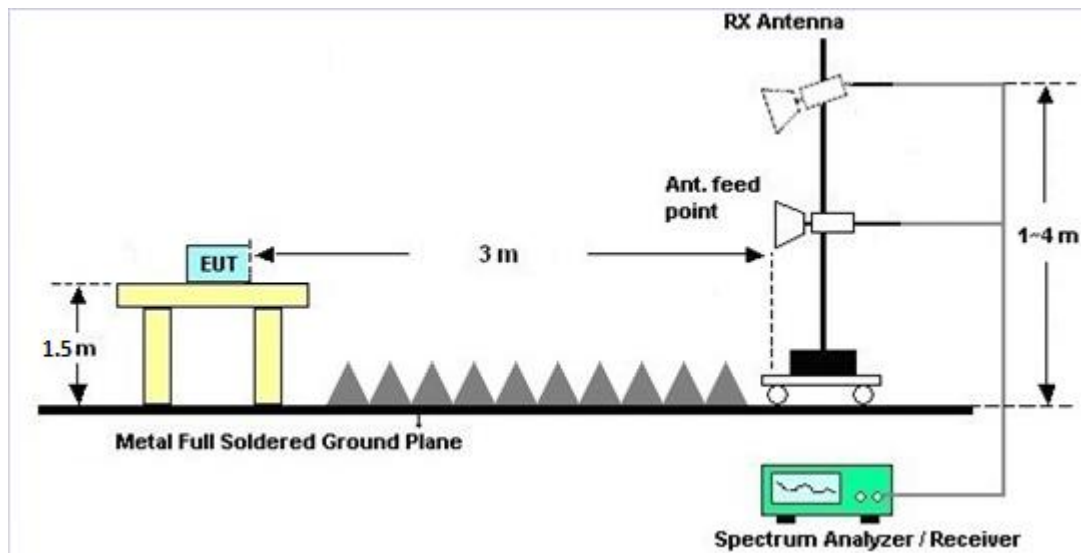

3.4.5 Test Results of Radiated Emissions (9 kHz ~ 30 MHz)

The low frequency, which started from 9 kHz to 30MHz, was pre-scanned and the result which was 20dB lower than the limit line was not reported.

There is a comparison data of both open-field test site and alternative test site - semi-Anechoic chamber according to 414788 D01 Radiated Test Site v01r01, and the result came out very similar.

3.4.6 Test Result of Radiated Band Edges

Please refer to Appendix C and D.

3.4.7 Duty Cycle

Please refer to Appendix E.

3.4.8 Test Result of Unwanted Radiated Emission (30MHz ~ 10th Harmonic)

Please refer to Appendix C and D.



3.5 AC Conducted Emission Measurement

3.5.1 Limit of AC Conducted Emission

For equipment that is designed to be connected to the public utility (AC) power line, the radio frequency voltage that is conducted back onto the AC power line on any frequency or frequencies within the band 150 kHz to 30 MHz shall not exceed the limits in the following table.

| Frequency of emission (MHz) | Conducted limit (dB μ V) | |
|-----------------------------|------------------------------|-----------|
| | Quasi-peak | Average |
| 0.15-0.5 | 66 to 56* | 56 to 46* |
| 0.5-5 | 56 | 46 |
| 5-30 | 60 | 50 |

*Decreases with the logarithm of the frequency.

3.5.2 Measuring Instruments

See list of measuring equipment of this test report.

3.5.3 Test Procedures

1. The EUT was placed 0.4 meter from the conducting wall of the shielding room was kept at least 80 centimeters from any other grounded conducting surface.
2. Connect EUT to the power mains through a line impedance stabilization network (LISN).
3. All the support units are connecting to the other LISN.
4. The LISN provides 50 ohm coupling impedance for the measuring instrument.
5. The FCC states that a 50 ohm, 50 microhenry LISN should be used.
6. Both sides of AC line were checked for maximum conducted interference.
7. The frequency range from 150 kHz to 30 MHz was searched.
8. Set the test-receiver system to Peak Detect Function and specified bandwidth with Maximum Hold Mode.

3.5.4 Test Setup

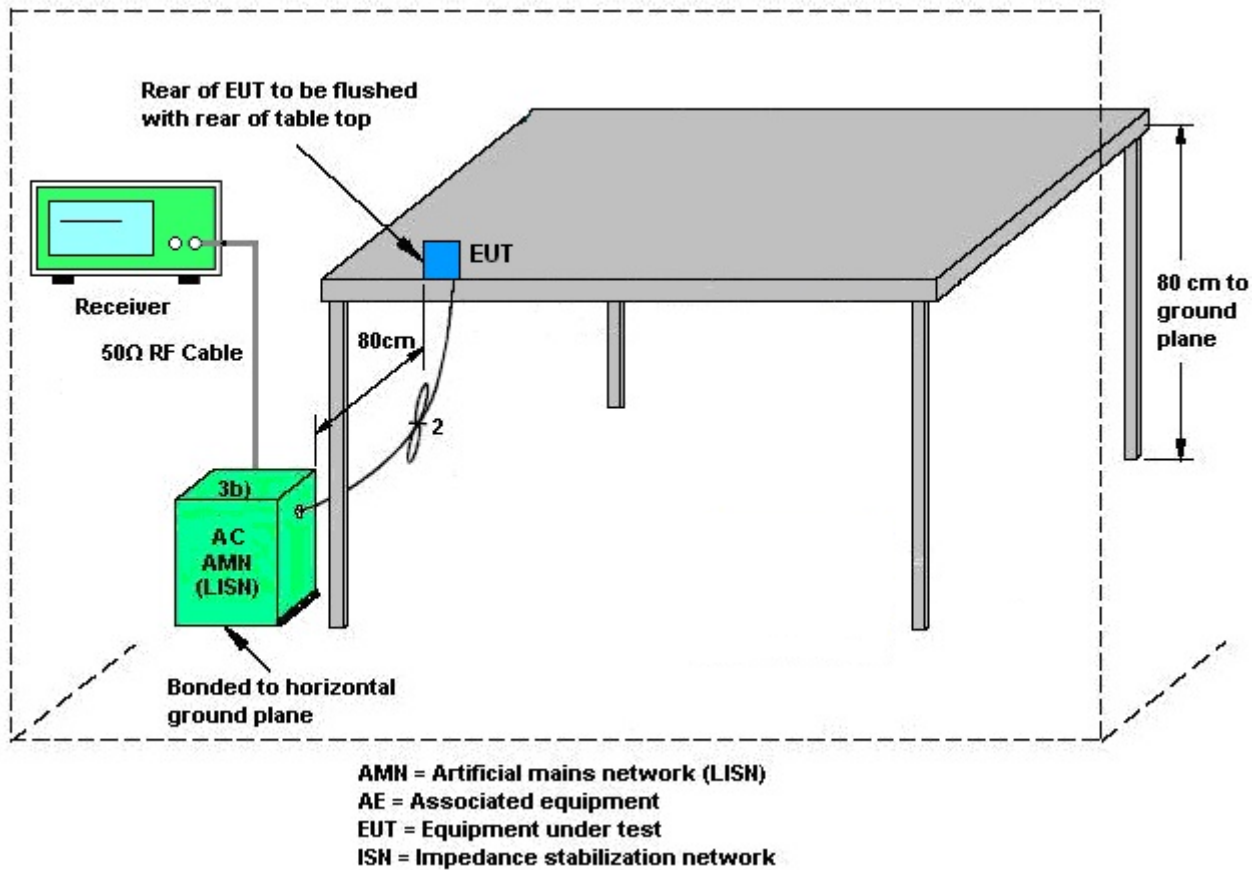

3.5.5 Test Result of AC Conducted Emission

Please refer to Appendix B.



3.6 Automatically Discontinue Transmission

3.6.1 Limit of Automatically Discontinue Transmission

The device shall automatically discontinue transmission in case of either absence of information to transmit or operational failure. These provisions are not intended to preclude the transmission of control or signaling information or the use of repetitive codes used by certain digital technologies to complete frame or burst intervals. Applicants shall include in their application for equipment authorization to describe how this requirement is met.

3.6.2 Measuring Instruments

See list of measuring equipment of this test report.

3.6.3 Test Result of Automatically Discontinue Transmission

While the EUT is not transmitting any information, the EUT can automatically discontinue transmission and become standby mode for power saving. The EUT can detect the controlling signal of ACK message transmitting from remote device and verify whether it shall resend or discontinue transmission.



3.7 Antenna Requirements

3.7.1 Standard Applicable

If transmitting antenna directional gain is greater than 6 dBi, both the peak transmit power and the peak power spectral density shall be reduced by the amount in dB that the directional gain of the antenna exceeds 6 dBi.

3.7.2 Antenna Anti-Replacement Construction

An embedded-in antenna design is used.

3.7.3 Antenna Gain

The antenna peak gain of EUT is less than 6 dBi. Therefore, it is not necessary to reduce maximum peak output power limit.



4 List of Measuring Equipment

| Instrument | Manufacturer | Model No. | Serial No. | Characteristics | Calibration Date | Test Date | Due Date | Remark |
|-----------------------|-----------------|-----------------|----------------------|-----------------|------------------|---------------------------------|---------------|--------------------------|
| Hygrometer | Testo | 608-H1 | 34893241 | N/A | Mar. 06, 2018 | Sep. 13, 2018~ Sep. 22, 2018 | Mar. 05, 2019 | Conducted (TH05-HY) |
| Power Meter | Anritsu | ML2495A | 0932001 | N/A | Sep. 26, 2017 | Sep. 13, 2018~ Sep. 22, 2018 | Sep. 25, 2018 | Conducted (TH05-HY) |
| Power Sensor | Anritsu | MA2411B | 0846202 | 300MHz~40GHz | Sep. 26, 2017 | Sep. 13, 2018~ Sep. 22, 2018 | Sep. 25, 2018 | Conducted (TH05-HY) |
| Spectrum Analyzer | Rohde & Schwarz | FSP30 | 101067 | 9kHz ~ 30GHz | Nov. 13, 2017 | Sep. 13, 2018~ Sep. 22, 2018 | Nov. 12, 2018 | Conducted (TH05-HY) |
| Switch Box & RF Cable | Burgeon | ETF-058 | EC1300484 | N/A | Mar. 01, 2018 | Sep. 13, 2018~ Sep. 22, 2018 | Feb. 28, 2019 | Conducted (TH05-HY) |
| AC Power Source | ChainTek | APC-1000W | N/A | N/A | N/A | Sep. 13, 2018 | N/A | Conduction (CO05-HY) |
| EMI Test Receiver | Rohde & Schwarz | ESR3 | 102388 | 9KHz~3.6GHz | Dec. 08, 2017 | Sep. 13, 2018 | Dec. 07, 2018 | Conduction (CO05-HY) |
| Hygrometer | Testo | 608-H1 | 34913912 | N/A | Mar. 06, 2018 | Sep. 13, 2018 | Mar. 05, 2019 | Conduction (CO05-HY) |
| LISN | Rohde & Schwarz | ENV216 | 100080 | 9kHz~30MHz | Nov. 30, 2017 | Sep. 13, 2018 | Nov. 29, 2018 | Conduction (CO05-HY) |
| Software | Rohde & Schwarz | EMC32 V10.30 | N/A | N/A | N/A | Sep. 13, 2018 | N/A | Conduction (CO05-HY) |
| LF Cable | HUBER + SUHNER | RG-214/U | LF01 | N/A | Jan. 03, 2018 | Sep. 13, 2018 | Jan. 02, 2019 | Conduction (CO05-HY) |
| Pulse Limiter | Rohde & Schwarz | ESH3-Z2 | 100851 | N/A | Jan. 03, 2018 | Sep. 13, 2018 | Jan. 02, 2019 | Conduction (CO05-HY) |
| Preamplifier | EMEC | EM18G40G | 060715 | 18GHz ~ 40GHz | Dec. 05, 2017 | Sep. 17, 2018~ Sep. 22, 2018 | Dec. 04, 2018 | Radiation (03CH16-HY) |
| Amplifier | SONOMA | 310N | 371607 | 9kHz~1000MHz | Sep. 27, 2017 | Sep. 17, 2018~ Sep. 22, 2018 | Sep. 26, 2018 | Radiation (03CH16-HY) |
| Preamplifier | Jet-Power | JPA0118-55-303 | 1710001800 054001 | 1GHz~18GHz | Apr. 16, 2018 | Sep. 17, 2018~ Sep. 22, 2018 | Apr. 15, 2019 | Radiation (03CH16-HY) |
| Preamplifier | Keysight | 83017A | MY5327026 4 | 1GHz ~ 26.5GHz | Dec. 05, 2017 | Sep. 17, 2018~ Sep. 22, 2018 | Dec. 04, 2018 | Radiation (03CH16-HY) |
| Horn Antenna | SCHWARZBECK | BBHA 9120 D | BBHA 9120 D 1212 | 1G~18GHz | May 10, 2018 | Sep. 17, 2018~ Sep. 22, 2018 | May 09, 2019 | Radiation (03CH16-HY) |
| SHF-EHF Horn Antenna | SCHWARZBECK | BBHA 9170 | BBHA91705 76 | 18GHz ~ 40GHz | Nov. 27, 2017 | Sep. 17, 2018~ Sep. 22, 2018 | Nov. 26, 2018 | Radiation (03CH16-HY) |
| Hygrometer | TECPEL | DTM-303B | TP162965 | N/A | Oct. 12, 2017 | Sep. 17, 2018~ Sep. 22, 2018 | Oct. 11, 2018 | Radiation (03CH16-HY) |
| Loop Antenna | Rohde & Schwarz | HFH2-Z2 | 100488 | 9 kHz~30 MHz | Nov. 23, 2017 | Sep. 17, 2018~ Sep. 22, 2018 | Nov. 22, 2018 | Radiation (03CH16-HY) |
| EMI Test Receiver | Keysight | N9038A (MXE) | MY57290111 | 3Hz~26.5GHz | Nov. 02, 2017 | Sep. 17, 2018~ Sep. 22, 2018 | Nov. 01, 2018 | Radiation (03CH16-HY) |



| Instrument | Manufacturer | Model No. | Serial No. | Characteristics | Calibration Date | Test Date | Due Date | Remark |
|-------------------|--------------------|--------------------------------------|-----------------|-----------------------------------|------------------|---------------------------------|---------------|--------------------------|
| Spectrum Analyzer | Agilent | N9030A | MY5235027 6 | 3Hz~44GHz | Mar. 27, 2018 | Sep. 17, 2018~ Sep. 22, 2018 | Mar. 26, 2019 | Radiation (03CH16-HY) |
| Controller | ChainTek | 3000-1 | N/A | Control Turn table & Ant. Mast | N/A | Sep. 17, 2018~ Sep. 22, 2018 | N/A | Radiation (03CH16-HY) |
| Antenna Mast | ChainTek | MBS-520-1 | N/A | 1m~4m | N/A | Sep. 17, 2018~ Sep. 22, 2018 | N/A | Radiation (03CH16-HY) |
| Turn Table | ChainTek | T-200-S-1 | N/A | 0~360 Degree | N/A | Sep. 17, 2018~ Sep. 22, 2018 | N/A | Radiation (03CH16-HY) |
| Software | AUDIX | E3 6.2009-8-24 | RK001136 | N/A | N/A | Sep. 17, 2018~ Sep. 22, 2018 | N/A | Radiation (03CH16-HY) |
| RF Cable | HUBER + SU HNER | SUCOFLEX 104 | MY9837/4P E | 9kHz-30MHz | Mar. 14, 2018 | Sep. 17, 2018~ Sep. 22, 2018 | Mar. 13, 2019 | Radiation (03CH16-HY) |
| RF Cable | HUBER + SUHNER | SUCOFLEX 126E | MY1082/26E A | 30M~18GHz | Oct. 17, 2017 | Sep. 17, 2018~ Sep. 22, 2018 | Oct. 16, 2018 | Radiation (03CH16-HY) |
| RF Cable | HUBER + SUHNER | SUCOFLEX 102 | 505134/2 | 30M~40GHz | Oct. 17, 2017 | Sep. 17, 2018~ Sep. 22, 2018 | Oct. 16, 2018 | Radiation (03CH16-HY) |
| Filter | Woken | WHKX8-587 2.5-6750-18 000-40ST | SN3 | 6.75GHz High Pass | Sep. 17, 2018 | Sep. 17, 2018~ Sep. 22, 2018 | Sep. 16, 2019 | Radiation (03CH16-HY) |
| Filter | Wainwright | WHKX12-27 00-3000-180 00-60SS | SN2 | 3G High Pass | Sep. 17, 2018 | Sep. 17, 2018~ Sep. 22, 2018 | Sep. 16, 2019 | Radiation (03CH16-HY) |
| Filter | Wainwright | WLK4-1000- 1530-8000-4 0SS | SN11 | 1G Low Pass | Sep. 17, 2018 | Sep. 17, 2018~ Sep. 22, 2018 | Sep. 16, 2019 | Radiation (03CH16-HY) |



5 Uncertainty of Evaluation

Uncertainty of Conducted Emission Measurement (150kHz ~ 30MHz)

| | |
|---|------|
| Measuring Uncertainty for a Level of Confidence of 95% ($U = 2Uc(y)$) | 2.20 |
|---|------|

Uncertainty of Radiated Emission Measurement (30 MHz ~ 1000 MHz)

| | |
|---|------|
| Measuring Uncertainty for a Level of Confidence of 95% ($U = 2Uc(y)$) | 4.90 |
|---|------|

Uncertainty of Radiated Emission Measurement (1000 MHz ~ 18000 MHz)

| | |
|---|------|
| Measuring Uncertainty for a Level of Confidence of 95% ($U = 2Uc(y)$) | 5.80 |
|---|------|

Uncertainty of Radiated Emission Measurement (18000 MHz ~ 40000 MHz)

| | |
|---|------|
| Measuring Uncertainty for a Level of Confidence of 95% ($U = 2Uc(y)$) | 3.90 |
|---|------|

Appendix A. Test Result of Conducted Test Items

| | | | | |
|----------------|-----------------------|--------------------|-------|----|
| Test Engineer: | Luffy Lin/Shiming Liu | Temperature: | 21~25 | °C |
| Test Date: | 2018/9/13~2018/9/22 | Relative Humidity: | 51~54 | % |

TEST RESULTS DATA
6dB and 26dB EBW and 99% OBW

| Band IV | | | | | | | | | | | | |
|---------|-----------|-----|-----|-------------|---------------------|-------|----------------------|-------|----------------------|-------|---------------------------------|-----------|
| Mod. | Data Rate | NTX | CH. | Freq. (MHz) | 99% Bandwidth (MHz) | | 26dB Bandwidth (MHz) | | 6 dB Bandwidth (MHz) | | 6 dB Bandwidth Min. Limit (MHz) | Pass/Fail |
| | | | | | Ant 1 | Ant 2 | Ant 1 | Ant 2 | Ant 1 | Ant 2 | | |
| 11a | 6Mbps | 1 | 149 | 5745 | 16.85 | - | 26.20 | - | 14.80 | - | 0.5 | Pass |
| 11a | 6Mbps | 1 | 157 | 5785 | 16.90 | - | 26.95 | - | 15.10 | - | 0.5 | Pass |
| 11a | 6Mbps | 1 | 165 | 5825 | 16.95 | - | 26.45 | - | 15.55 | - | 0.5 | Pass |
| HT20 | MCS0 | 1 | 149 | 5745 | 17.95 | - | 26.80 | - | 16.50 | - | 0.5 | Pass |
| HT20 | MCS0 | 1 | 157 | 5785 | 17.95 | - | 26.55 | - | 15.65 | - | 0.5 | Pass |
| HT20 | MCS0 | 1 | 165 | 5825 | 18.00 | - | 26.95 | - | 15.05 | - | 0.5 | Pass |
| HT40 | MCS0 | 1 | 151 | 5755 | 36.70 | - | 42.24 | - | 35.68 | - | 0.5 | Pass |
| HT40 | MCS0 | 1 | 159 | 5795 | 36.60 | - | 42.19 | - | 35.73 | - | 0.5 | Pass |
| VHT80 | MCS0 | 1 | 155 | 5775 | 76.92 | - | 84.16 | - | 75.36 | - | 0.5 | Pass |

TEST RESULTS DATA
Average Power Table

| Band IV | | | | | | | | | | | | | | |
|---------|-----------|-----|-----|-------------|------------------|-------|-------------------------------|-------|-----|---------------------------------|-------|----------|-------|-----------|
| Mod. | Data Rate | NTX | CH. | Freq. (MHz) | Duty Factor (dB) | | Average Conducted Power (dBm) | | | FCC Conducted Power Limit (dBm) | | DG (dBi) | | Pass/Fail |
| | | | | | Ant 1 | Ant 2 | Ant 1 | Ant 2 | SUM | Ant 1 | Ant 2 | Ant 1 | Ant 2 | |
| 11a | 6Mbps | 1 | 149 | 5745 | 0.20 | - | 15.48 | - | | 30.00 | - | -1.60 | - | Pass |
| 11a | 6Mbps | 1 | 157 | 5785 | 0.20 | - | 15.42 | - | | 30.00 | - | -1.60 | - | Pass |
| 11a | 6Mbps | 1 | 165 | 5825 | 0.20 | - | 15.45 | - | | 30.00 | - | -1.60 | - | Pass |
| HT20 | MCS0 | 1 | 149 | 5745 | 0.24 | - | 14.98 | - | | 30.00 | - | -1.60 | - | Pass |
| HT20 | MCS0 | 1 | 157 | 5785 | 0.24 | - | 14.96 | - | | 30.00 | - | -1.60 | - | Pass |
| HT20 | MCS0 | 1 | 165 | 5825 | 0.24 | - | 14.97 | - | | 30.00 | - | -1.60 | - | Pass |
| HT40 | MCS0 | 1 | 151 | 5755 | 0.41 | - | 14.47 | - | | 30.00 | - | -1.60 | - | Pass |
| HT40 | MCS0 | 1 | 159 | 5795 | 0.41 | - | 14.41 | - | | 30.00 | - | -1.60 | - | Pass |
| VHT20 | MCS0 | 1 | 149 | 5745 | 0.24 | - | 14.97 | - | | 30.00 | - | -1.60 | - | Pass |
| VHT20 | MCS0 | 1 | 157 | 5785 | 0.24 | - | 14.94 | - | | 30.00 | - | -1.60 | - | Pass |
| VHT20 | MCS0 | 1 | 165 | 5825 | 0.24 | - | 14.96 | - | | 30.00 | - | -1.60 | - | Pass |
| VHT40 | MCS0 | 1 | 151 | 5755 | 0.48 | - | 14.44 | - | | 30.00 | - | -1.60 | - | Pass |
| VHT40 | MCS0 | 1 | 159 | 5795 | 0.48 | - | 14.39 | - | | 30.00 | - | -1.60 | - | Pass |
| VHT80 | MCS0 | 1 | 155 | 5775 | 0.50 | - | 13.70 | - | | 30.00 | - | -1.60 | - | Pass |

TEST RESULTS DATA
Power Spectral Density

| Band IV | | | | | | | | | | | | | | | | |
|---------|-----------|-----|-----|-------------|------------------|-------|---------------------------------|-------|------------------------------------|-------|-----|--------------------------------|-------|----------|-------|------------|
| Mod. | Data Rate | NTX | CH. | Freq. (MHz) | Duty Factor (dB) | | 10log (500kHz /RBW) Factor (dB) | | Average Power Density (dBm/500kHz) | | | Average PSD Limit (dBm/500kHz) | | DG (dBi) | | Pass /Fail |
| | | | | | Ant 1 | Ant 2 | Ant 1 | Ant 2 | Ant 1 | Ant 2 | SUM | Ant 1 | Ant 2 | Ant 1 | Ant 2 | |
| 11a | 6Mbps | 1 | 149 | 5745 | 0.20 | - | 2.22 | - | 1.92 | - | | 30.00 | - | -1.60 | - | Pass |
| 11a | 6Mbps | 1 | 157 | 5785 | 0.20 | - | 2.22 | - | 1.68 | - | | 30.00 | - | -1.60 | - | Pass |
| 11a | 6Mbps | 1 | 165 | 5825 | 0.20 | - | 2.22 | - | 1.83 | - | | 30.00 | - | -1.60 | - | Pass |
| HT20 | MCS0 | 1 | 149 | 5745 | 0.24 | - | 2.22 | - | 1.46 | - | | 30.00 | - | -1.60 | - | Pass |
| HT20 | MCS0 | 1 | 157 | 5785 | 0.24 | - | 2.22 | - | 1.05 | - | | 30.00 | - | -1.60 | - | Pass |
| HT20 | MCS0 | 1 | 165 | 5825 | 0.24 | - | 2.22 | - | 0.84 | - | | 30.00 | - | -1.60 | - | Pass |
| HT40 | MCS0 | 1 | 151 | 5755 | 0.41 | - | 2.22 | - | -2.97 | - | | 30.00 | - | -1.60 | - | Pass |
| HT40 | MCS0 | 1 | 159 | 5795 | 0.41 | - | 2.22 | - | -3.41 | - | | 30.00 | - | -1.60 | - | Pass |
| VHT80 | MCS0 | 1 | 155 | 5775 | 0.50 | - | 2.22 | - | -6.94 | - | | 30.00 | - | -1.60 | - | Pass |

Note: PSD Sum = Max PSD(Ant. 1, Ant. 2) + 10 log (n)



Appendix B. AC Conducted Emission Test Results

| | | | |
|-----------------|----------|---------------------|---------|
| Test Engineer : | Rick Lin | Temperature : | 24~25°C |
| | | Relative Humidity : | 61~62% |

EUT Information

Report NO : 882920-01
 Test Mode : Mode 1
 Test Voltage : 120Vac/60Hz
 Phase : Line

Full Spectrum

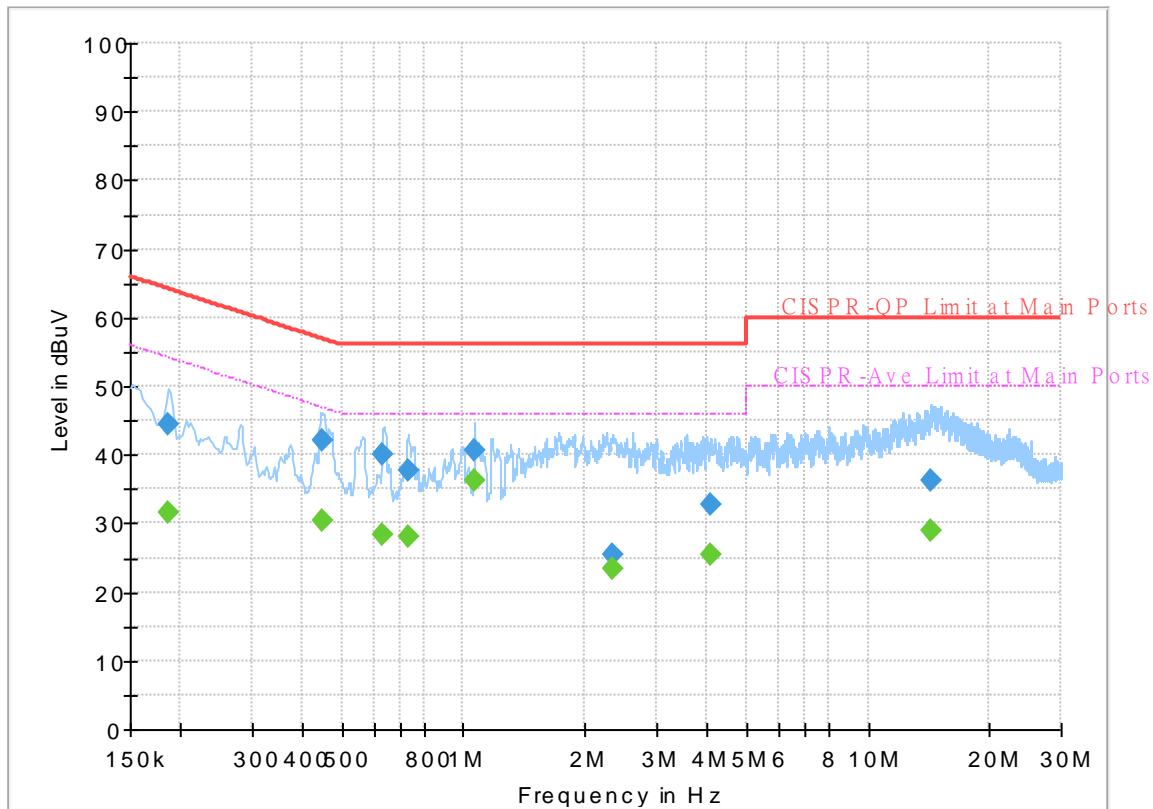

Final_Result

| Frequency (MHz) | QuasiPeak (dBuV) | CAverage (dBuV) | Limit (dBuV) | Margin (dB) | Line | Filter | Corr. (dB) |
|-----------------|------------------|-----------------|--------------|-------------|------|--------|------------|
| 0.186000 | --- | 31.53 | 54.21 | 22.68 | L1 | OFF | 19.5 |
| 0.186000 | 44.41 | --- | 64.21 | 19.80 | L1 | OFF | 19.5 |
| 0.449250 | --- | 30.48 | 46.89 | 16.41 | L1 | OFF | 19.5 |
| 0.449250 | 42.11 | --- | 56.89 | 14.78 | L1 | OFF | 19.5 |
| 0.633750 | --- | 28.47 | 46.00 | 17.53 | L1 | OFF | 19.6 |
| 0.633750 | 39.96 | --- | 56.00 | 16.04 | L1 | OFF | 19.6 |
| 0.732750 | --- | 28.06 | 46.00 | 17.94 | L1 | OFF | 19.6 |
| 0.732750 | 37.84 | --- | 56.00 | 18.16 | L1 | OFF | 19.6 |
| 1.065750 | --- | 36.38 | 46.00 | 9.62 | L1 | OFF | 19.6 |
| 1.065750 | 40.64 | --- | 56.00 | 15.36 | L1 | OFF | 19.6 |
| 2.339250 | --- | 23.43 | 46.00 | 22.57 | L1 | OFF | 19.5 |
| 2.339250 | 25.45 | --- | 56.00 | 30.55 | L1 | OFF | 19.5 |
| 4.087500 | --- | 25.54 | 46.00 | 20.46 | L1 | OFF | 19.7 |
| 4.087500 | 32.76 | --- | 56.00 | 23.24 | L1 | OFF | 19.7 |
| 14.374500 | --- | 28.84 | 50.00 | 21.16 | L1 | OFF | 20.1 |
| 14.374500 | 36.20 | --- | 60.00 | 23.80 | L1 | OFF | 20.1 |

EUT Information

Report NO : 882920-01
 Test Mode : Mode 1
 Test Voltage : 120Vac/60Hz
 Phase : Neutral

Full Spectrum

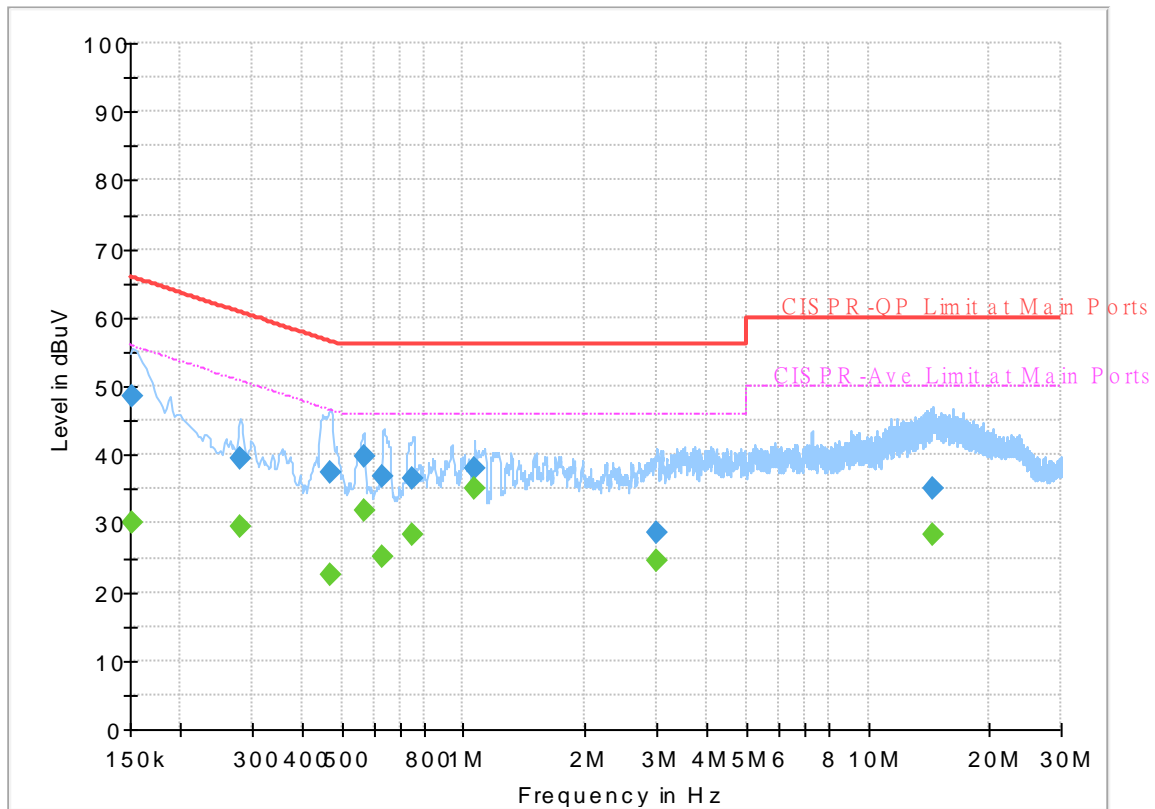

Final Result

| Frequency (MHz) | QuasiPeak (dBuV) | CAverage (dBuV) | Limit (dBuV) | Margin (dB) | Line | Filter | Corr. (dB) |
|-----------------|------------------|-----------------|--------------|-------------|------|--------|------------|
| 0.152250 | --- | 29.97 | 55.88 | 25.91 | N | OFF | 19.5 |
| 0.152250 | 48.59 | --- | 65.88 | 17.29 | N | OFF | 19.5 |
| 0.280500 | --- | 29.62 | 50.80 | 21.18 | N | OFF | 19.5 |
| 0.280500 | 39.59 | --- | 60.80 | 21.21 | N | OFF | 19.5 |
| 0.469500 | --- | 22.65 | 46.52 | 23.87 | N | OFF | 19.5 |
| 0.469500 | 37.34 | --- | 56.52 | 19.18 | N | OFF | 19.5 |
| 0.566250 | --- | 31.78 | 46.00 | 14.22 | N | OFF | 19.5 |
| 0.566250 | 39.85 | --- | 56.00 | 16.15 | N | OFF | 19.5 |
| 0.631500 | --- | 25.21 | 46.00 | 20.79 | N | OFF | 19.6 |
| 0.631500 | 36.73 | --- | 56.00 | 19.27 | N | OFF | 19.6 |
| 0.746250 | --- | 28.36 | 46.00 | 17.64 | N | OFF | 19.6 |
| 0.746250 | 36.40 | --- | 56.00 | 19.60 | N | OFF | 19.6 |
| 1.065750 | --- | 35.03 | 46.00 | 10.97 | N | OFF | 19.6 |
| 1.065750 | 38.10 | --- | 56.00 | 17.90 | N | OFF | 19.6 |
| 3.018750 | --- | 24.47 | 46.00 | 21.53 | N | OFF | 19.6 |
| 3.018750 | 28.67 | --- | 56.00 | 27.33 | N | OFF | 19.6 |
| 14.408250 | --- | 28.48 | 50.00 | 21.52 | N | OFF | 20.1 |
| 14.408250 | 34.94 | --- | 60.00 | 25.06 | N | OFF | 20.1 |



Appendix C. Radiated Spurious Emission

| | | | |
|-----------------|--|---------------------|---------|
| Test Engineer : | J.C. Liang, Andy Yang, and Master Liao | Temperature : | 22~25°C |
| | | Relative Humidity : | 50~54% |

Band 4 - 5725~5850MHz
WIFI 802.11a (Band Edge @ 3m)

| WIFI Ant. 1 | Note | Frequency (MHz) | Level (dBμV/m) | Over Limit (dB) | Limit Line (dBμV/m) | Read Level (dBμV) | Antenna Factor (dB/m) | Path Loss (dB) | Preamp Factor (dB) | Ant Pos (cm) | Table Pos (deg) | Peak Avg. (P/A) | Pol. (H/V) | |
|------------------------------|------|-------------------|------------------|-------------------|-----------------------|---------------------|-------------------------|------------------|----------------------|----------------|-------------------|-------------------|--------------|---|
| 802.11a CH 149 5745MHz | | 5620.4 | 54.96 | -13.24 | 68.2 | 38.81 | 31.92 | 13.72 | 29.49 | 100 | 328 | P | H | |
| | | 5692.4 | 55.96 | -43.64 | 99.6 | 39.53 | 32.05 | 13.91 | 29.53 | 100 | 328 | P | H | |
| | | 5719 | 58.66 | -51.86 | 110.52 | 42.13 | 32.09 | 13.98 | 29.54 | 100 | 328 | P | H | |
| | | 5723.2 | 70.94 | -47.16 | 118.1 | 54.39 | 32.1 | 13.99 | 29.54 | 100 | 328 | P | H | |
| | * | 5745 | 110.09 | - | - | 93.46 | 32.14 | 14.05 | 29.56 | 100 | 328 | P | H | |
| | * | 5745 | 101.98 | - | - | 85.35 | 32.14 | 14.05 | 29.56 | 100 | 328 | A | H | |
| | | | | | | | | | | | | | | H |
| | | | | | | | | | | | | | | H |
| | | | 5635.6 | 54.04 | -14.16 | 68.2 | 37.85 | 31.94 | 13.76 | 29.51 | 383 | 26 | P | V |
| | | | 5668.8 | 55.19 | -26.96 | 82.15 | 38.86 | 32 | 13.85 | 29.52 | 383 | 26 | P | V |
| | | | 5719 | 57.56 | -52.96 | 110.52 | 41.03 | 32.09 | 13.98 | 29.54 | 383 | 26 | P | V |
| | | | 5724.8 | 69.34 | -52.4 | 121.74 | 52.78 | 32.1 | 14 | 29.54 | 383 | 26 | P | V |
| | * | | 5745 | 109.41 | - | - | 92.78 | 32.14 | 14.05 | 29.56 | 383 | 26 | P | V |
| | * | | 5745 | 101.12 | - | - | 84.49 | 32.14 | 14.05 | 29.56 | 383 | 26 | A | V |
| | | | | | | | | | | | | | V | |
| | | | | | | | | | | | | | V | |



| WIFI Ant. | Note | Frequency | Level | Over Limit | Limit Line | Read Level | Antenna Factor | Path Loss | Preamp Factor | Ant Pos | Table Pos | Peak Avg. | Pol. |
|----------------|------|-----------|------------|------------|------------|------------|----------------|-----------|---------------|---------|-----------|-----------|-------|
| 1 | | (MHz) | (dBµV/m) | (dB) | (dBµV/m) | (dBµV) | (dB/m) | (dB) | (dB) | (cm) | (deg) | (P/A) | (H/V) |
| | | 5623.4 | 54.35 | -13.85 | 68.2 | 38.2 | 31.92 | 13.72 | 29.49 | 100 | 329 | P | H |
| | | 5694.6 | 54.11 | -47.11 | 101.22 | 37.67 | 32.05 | 13.92 | 29.53 | 100 | 329 | P | H |
| | | 5705 | 54.13 | -52.47 | 106.6 | 37.66 | 32.07 | 13.94 | 29.54 | 100 | 329 | P | H |
| | | 5723.8 | 54.13 | -65.33 | 119.46 | 37.58 | 32.1 | 13.99 | 29.54 | 100 | 329 | P | H |
| | * | 5785 | 110.1 | - | - | 93.31 | 32.21 | 14.16 | 29.58 | 100 | 329 | P | H |
| | * | 5785 | 101.88 | - | - | 85.09 | 32.21 | 14.16 | 29.58 | 100 | 329 | A | H |
| | | 5850 | 53.65 | -68.55 | 122.2 | 36.89 | 32.33 | 14.03 | 29.6 | 100 | 329 | P | H |
| | | 5856.2 | 54.25 | -56.21 | 110.46 | 37.5 | 32.34 | 14.01 | 29.6 | 100 | 329 | P | H |
| | | 5880.4 | 54.6 | -46.59 | 101.19 | 37.91 | 32.38 | 13.93 | 29.62 | 100 | 329 | P | H |
| | | 5932.2 | 53.63 | -14.57 | 68.2 | 37.03 | 32.48 | 13.76 | 29.64 | 100 | 329 | P | H |
| | | | | | | | | | | | | | H |
| | | | | | | | | | | | | | H |
| 802.11a | | | | | | | | | | | | | |
| CH 157 | | | | | | | | | | | | | |
| 5785MHz | | 5637 | 54.45 | -13.75 | 68.2 | 38.25 | 31.95 | 13.76 | 29.51 | 392 | 26 | P | V |
| | | 5682.4 | 55.43 | -36.78 | 92.21 | 39.05 | 32.03 | 13.88 | 29.53 | 392 | 26 | P | V |
| | | 5705 | 55.09 | -51.51 | 106.6 | 38.62 | 32.07 | 13.94 | 29.54 | 392 | 26 | P | V |
| | | 5723.4 | 54.62 | -63.93 | 118.55 | 38.07 | 32.1 | 13.99 | 29.54 | 392 | 26 | P | V |
| | * | 5785 | 109.4 | - | - | 92.61 | 32.21 | 14.16 | 29.58 | 392 | 26 | P | V |
| | * | 5785 | 101.04 | - | - | 84.25 | 32.21 | 14.16 | 29.58 | 392 | 26 | A | V |
| | | 5853.6 | 55.04 | -58.95 | 113.99 | 38.28 | 32.34 | 14.02 | 29.6 | 392 | 26 | P | V |
| | | 5857.2 | 54.7 | -55.48 | 110.18 | 37.95 | 32.34 | 14.01 | 29.6 | 392 | 26 | P | V |
| | | 5895.8 | 55.35 | -34.42 | 89.77 | 38.69 | 32.41 | 13.88 | 29.63 | 392 | 26 | P | V |
| | | 5938.6 | 54.92 | -13.28 | 68.2 | 38.35 | 32.49 | 13.74 | 29.66 | 392 | 26 | P | V |
| | | | | | | | | | | | | | V |
| | | | | | | | | | | | | | V |



| WIFI Ant. | Note | Frequency | Level | Over Limit | Limit Line | Read Level | Antenna Factor | Path Loss | Preamp Factor | Ant Pos | Table Pos | Peak Avg. | Pol. | |
|---------------------------------------|---------------|---|------------|------------|------------|------------|----------------|-----------|---------------|---------|-----------|-----------|---------|---|
| 1 | | (MHz) | (dBμV/m) | (dB) | (dBμV/m) | (dBμV) | (dB/m) | (dB) | (dB) | (cm) | (deg) | (P/A) | (H/V) | |
| 802.11a CH 165 5825MHz | * | 5825 | 111.14 | - | - | 94.33 | 32.28 | 14.12 | 29.59 | 100 | 312 | P | H | |
| | * | 5825 | 101.81 | - | - | 85 | 32.28 | 14.12 | 29.59 | 100 | 312 | A | H | |
| | | 5850.6 | 70.58 | -50.25 | 120.83 | 53.82 | 32.33 | 14.03 | 29.6 | 100 | 312 | P | H | |
| | | 5858 | 69.55 | -40.41 | 109.96 | 52.82 | 32.34 | 14.01 | 29.62 | 100 | 312 | P | H | |
| | | 5875.4 | 66.26 | -38.64 | 104.9 | 49.55 | 32.38 | 13.95 | 29.62 | 100 | 312 | P | H | |
| | | 5925 | 55.3 | -12.9 | 68.2 | 38.69 | 32.47 | 13.78 | 29.64 | 100 | 312 | P | H | |
| | | | | | | | | | | | | | | H |
| | | | | | | | | | | | | | | H |
| | * | 5825 | 108.81 | - | - | 92 | 32.28 | 14.12 | 29.59 | 371 | 27 | P | V | |
| | * | 5825 | 101.06 | - | - | 84.25 | 32.28 | 14.12 | 29.59 | 371 | 27 | A | V | |
| | | 5850 | 67.2 | -55 | 122.2 | 50.44 | 32.33 | 14.03 | 29.6 | 371 | 27 | P | V | |
| | | 5855.4 | 67.33 | -43.36 | 110.69 | 50.58 | 32.34 | 14.01 | 29.6 | 371 | 27 | P | V | |
| | | 5879.6 | 63.28 | -38.5 | 101.78 | 46.59 | 32.38 | 13.93 | 29.62 | 371 | 27 | P | V | |
| | | 5929 | 54.99 | -13.21 | 68.2 | 38.39 | 32.47 | 13.77 | 29.64 | 371 | 27 | P | V | |
| | | | | | | | | | | | | | | V |
| | | | | | | | | | | | | | | V |
| | | | | | | | | | | | | | | V |
| | Remark | 1. No other spurious found. 2. All results are PASS against Peak and Average limit line. | | | | | | | | | | | | |



Band 4 5725~5850MHz
WIFI 802.11a (Harmonic @ 3m)

| WIFI Ant. | Note | Frequency | Level | Over Limit | Limit Line | Read Level | Antenna Factor | Path Loss | Preamp Factor | Ant Pos | Table Pos | Peak Avg. | Pol. |
|------------------------------|---|-----------|------------|------------|------------|------------|----------------|-----------|---------------|---------|-----------|-----------|---------|
| 1 | | (MHz) | (dBμV/m) | (dB) | (dBμV/m) | (dBμV) | (dB/m) | (dB) | (dB) | (cm) | (deg) | (P/A) | (H/V) |
| 802.11a CH 149 5745MHz | | 11490 | 45.61 | -28.39 | 74 | 48.73 | 39.91 | 18.37 | 61.4 | 100 | 0 | P | H |
| | | 17235 | 46.41 | -21.79 | 68.2 | 40.47 | 40.46 | 23.27 | 57.79 | 100 | 0 | P | H |
| | | | | | | | | | | | | | H |
| | | | | | | | | | | | | | H |
| | | 11490 | 45.82 | -28.18 | 74 | 48.94 | 39.91 | 18.37 | 61.4 | 100 | 0 | P | V |
| | | 17235 | 46.25 | -21.95 | 68.2 | 40.31 | 40.46 | 23.27 | 57.79 | 100 | 0 | P | V |
| | | | | | | | | | | | | | V |
| | | | | | | | | | | | | | V |
| 802.11a CH 157 5785MHz | | 11570 | 46.32 | -27.68 | 74 | 49.65 | 39.76 | 18.44 | 61.53 | 100 | 0 | P | H |
| | | 17355 | 44.28 | -23.92 | 68.2 | 37.54 | 40.79 | 23.43 | 57.48 | 100 | 0 | P | H |
| | | | | | | | | | | | | | H |
| | | | | | | | | | | | | | H |
| | | 11570 | 45.9 | -28.1 | 74 | 49.23 | 39.76 | 18.44 | 61.53 | 100 | 0 | P | V |
| | | 17355 | 44.35 | -23.85 | 68.2 | 37.61 | 40.79 | 23.43 | 57.48 | 100 | 0 | P | V |
| | | | | | | | | | | | | | V |
| | | | | | | | | | | | | | V |
| 802.11a CH 165 5825MHz | | 11650 | 44.61 | -29.39 | 74 | 48.18 | 39.6 | 18.5 | 61.67 | 100 | 0 | P | H |
| | | 17475 | 43.14 | -25.06 | 68.2 | 35.58 | 41.13 | 23.59 | 57.16 | 100 | 0 | P | H |
| | | | | | | | | | | | | | H |
| | | | | | | | | | | | | | H |
| | | 11650 | 44.22 | -29.78 | 74 | 47.79 | 39.6 | 18.5 | 61.67 | 100 | 0 | P | V |
| | | 17475 | 43.16 | -25.04 | 68.2 | 35.6 | 41.13 | 23.59 | 57.16 | 100 | 0 | P | V |
| | | | | | | | | | | | | | V |
| | | | | | | | | | | | | | V |
| Remark | 1. No other spurious found. 2. All results are PASS against Peak and Average limit line. | | | | | | | | | | | | |



Band 4 5725~5850MHz

WIFI 802.11n HT20 (Band Edge @ 3m)

| WIFI Ant. | Note | Frequency | Level | Over Limit | Limit Line | Read Level | Antenna Factor | Path Loss | Preamp Factor | Ant Pos | Table Pos | Peak Avg. | Pol. | |
|--------------------------------------|------|-----------|------------|------------|------------|------------|----------------|-----------|---------------|---------|-----------|-----------|-------|---|
| 1 | | (MHz) | (dBμV/m) | (dB) | (dBμV/m) | (dBμV) | (dB/m) | (dB) | (dB) | (cm) | (deg) | (P/A) | (H/V) | |
| 802.11n HT20 CH 149 5745MHz | | 5604 | 55.01 | -13.19 | 68.2 | 38.94 | 31.89 | 13.67 | 29.49 | 105 | 311 | P | H | |
| | | 5700 | 62.45 | -42.75 | 105.2 | 45.99 | 32.06 | 13.93 | 29.53 | 105 | 311 | P | H | |
| | | 5719.6 | 64.25 | -46.44 | 110.69 | 47.71 | 32.1 | 13.98 | 29.54 | 105 | 311 | P | H | |
| | | 5724.8 | 68.41 | -53.33 | 121.74 | 51.85 | 32.1 | 14 | 29.54 | 105 | 311 | P | H | |
| | * | 5745 | 109.21 | - | - | 92.58 | 32.14 | 14.05 | 29.56 | 105 | 311 | P | H | |
| | * | 5745 | 101.44 | - | - | 84.81 | 32.14 | 14.05 | 29.56 | 105 | 311 | A | H | |
| | | | | | | | | | | | | | | H |
| | | | | | | | | | | | | | | H |
| | | | 5610.8 | 55.65 | -12.55 | 68.2 | 39.55 | 31.9 | 13.69 | 29.49 | 362 | 29 | P | V |
| | | | 5694.6 | 60.16 | -41.06 | 101.22 | 43.72 | 32.05 | 13.92 | 29.53 | 362 | 29 | P | V |
| | | | 5716.4 | 63.15 | -46.64 | 109.79 | 46.63 | 32.09 | 13.97 | 29.54 | 362 | 29 | P | V |
| | | | 5725 | 68.11 | -54.09 | 122.2 | 51.55 | 32.1 | 14 | 29.54 | 362 | 29 | P | V |
| | * | | 5745 | 106.88 | - | - | 90.25 | 32.14 | 14.05 | 29.56 | 362 | 29 | P | V |
| | * | | 5745 | 99.19 | - | - | 82.56 | 32.14 | 14.05 | 29.56 | 362 | 29 | A | V |
| | | | | | | | | | | | | | | V |
| | | | | | | | | | | | | | V | |



| WIFI Ant. | Note | Frequency | Level | Over Limit | Limit Line | Read Level | Antenna Factor | Path Loss | Preamp Factor | Ant Pos | Table Pos | Peak Avg. | Pol. | |
|--------------------------------------|------|-----------|------------|------------|------------|------------|----------------|-----------|---------------|---------|-----------|-----------|-------|---|
| 1 | | (MHz) | (dBµV/m) | (dB) | (dBµV/m) | (dBµV) | (dB/m) | (dB) | (dB) | (cm) | (deg) | (P/A) | (H/V) | |
| 802.11n HT20 CH 157 5785MHz | | 5624 | 54.81 | -13.39 | 68.2 | 38.66 | 31.92 | 13.72 | 29.49 | 101 | 312 | P | H | |
| | | 5697 | 55.91 | -47.08 | 102.99 | 39.47 | 32.05 | 13.92 | 29.53 | 101 | 312 | P | H | |
| | | 5713.2 | 59.84 | -49.06 | 108.9 | 43.33 | 32.08 | 13.97 | 29.54 | 101 | 312 | P | H | |
| | | 5723.8 | 62.25 | -57.21 | 119.46 | 45.7 | 32.1 | 13.99 | 29.54 | 101 | 312 | P | H | |
| | * | 5785 | 109.51 | - | - | 92.72 | 32.21 | 14.16 | 29.58 | 101 | 312 | P | H | |
| | * | 5785 | 101.8 | - | - | 85.01 | 32.21 | 14.16 | 29.58 | 101 | 312 | A | H | |
| | | 5851 | 58.25 | -61.67 | 119.92 | 41.49 | 32.33 | 14.03 | 29.6 | 101 | 312 | P | H | |
| | | 5856.4 | 56.18 | -54.23 | 110.41 | 39.43 | 32.34 | 14.01 | 29.6 | 101 | 312 | P | H | |
| | | 5895.8 | 55.84 | -33.93 | 89.77 | 39.18 | 32.41 | 13.88 | 29.63 | 101 | 312 | P | H | |
| | | 5932 | 55.66 | -12.54 | 68.2 | 39.06 | 32.48 | 13.76 | 29.64 | 101 | 312 | P | H | |
| | | | | | | | | | | | | | | H |
| | | | | | | | | | | | | | | H |
| | | | 5636 | 54.63 | -13.57 | 68.2 | 38.44 | 31.94 | 13.76 | 29.51 | 368 | 26 | P | V |
| | | | 5697.2 | 55.55 | -47.59 | 103.14 | 39.11 | 32.05 | 13.92 | 29.53 | 368 | 26 | P | V |
| | | | 5715.4 | 56.75 | -52.76 | 109.51 | 40.23 | 32.09 | 13.97 | 29.54 | 368 | 26 | P | V |
| | | | 5723.4 | 60.64 | -57.91 | 118.55 | 44.09 | 32.1 | 13.99 | 29.54 | 368 | 26 | P | V |
| | * | | 5785 | 106.52 | - | - | 89.73 | 32.21 | 14.16 | 29.58 | 368 | 26 | P | V |
| | * | | 5785 | 99.49 | - | - | 82.7 | 32.21 | 14.16 | 29.58 | 368 | 26 | A | V |
| | | | 5850 | 56.01 | -66.19 | 122.2 | 39.25 | 32.33 | 14.03 | 29.6 | 368 | 26 | P | V |
| | | | 5871.2 | 55.79 | -50.47 | 106.26 | 39.08 | 32.37 | 13.96 | 29.62 | 368 | 26 | P | V |
| | | 5891.6 | 56.37 | -36.51 | 92.88 | 39.71 | 32.4 | 13.89 | 29.63 | 368 | 26 | P | V | |
| | | 5942.4 | 55.86 | -12.34 | 68.2 | 39.3 | 32.5 | 13.72 | 29.66 | 368 | 26 | P | V | |
| | | | | | | | | | | | | | V | |
| | | | | | | | | | | | | | V | |



| WIFI Ant. | Note | Frequency | Level | Over Limit | Limit Line | Read Level | Antenna Factor | Path Loss | Preamp Factor | Ant Pos | Table Pos | Peak Avg. | Pol. | |
|--------------------------------------|---|-----------|------------|------------|------------|------------|----------------|-----------|---------------|---------|-----------|-----------|---------|---|
| 1 | | (MHz) | (dBµV/m) | (dB) | (dBµV/m) | (dBµV) | (dB/m) | (dB) | (dB) | (cm) | (deg) | (P/A) | (H/V) | |
| 802.11n HT20 CH 165 5825MHz | * | 5825 | 108.35 | - | - | 91.54 | 32.28 | 14.12 | 29.59 | 100 | 313 | P | H | |
| | * | 5825 | 100.61 | - | - | 83.8 | 32.28 | 14.12 | 29.59 | 100 | 313 | A | H | |
| | | 5851 | 68.04 | -51.88 | 119.92 | 51.28 | 32.33 | 14.03 | 29.6 | 100 | 313 | P | H | |
| | | 5857.6 | 67.51 | -42.56 | 110.07 | 50.76 | 32.34 | 14.01 | 29.6 | 100 | 313 | P | H | |
| | | 5877 | 63.33 | -40.38 | 103.71 | 46.63 | 32.38 | 13.94 | 29.62 | 100 | 313 | P | H | |
| | | 5949.2 | 56 | -12.2 | 68.2 | 39.45 | 32.51 | 13.7 | 29.66 | 100 | 313 | P | H | |
| | | | | | | | | | | | | | | H |
| | | | | | | | | | | | | | | H |
| | * | 5825 | 107.17 | - | - | 90.36 | 32.28 | 14.12 | 29.59 | 371 | 24 | P | V | |
| | * | 5825 | 98.56 | - | - | 81.75 | 32.28 | 14.12 | 29.59 | 371 | 24 | A | V | |
| | | 5850.4 | 66.86 | -54.43 | 121.29 | 50.1 | 32.33 | 14.03 | 29.6 | 371 | 24 | P | V | |
| | | 5856.6 | 65.58 | -44.77 | 110.35 | 48.83 | 32.34 | 14.01 | 29.6 | 371 | 24 | P | V | |
| | | 5876 | 62.09 | -42.37 | 104.46 | 45.38 | 32.38 | 13.95 | 29.62 | 371 | 24 | P | V | |
| | | 5947.4 | 55.49 | -12.71 | 68.2 | 38.93 | 32.51 | 13.71 | 29.66 | 371 | 24 | P | V | |
| | | | | | | | | | | | | | V | |
| | | | | | | | | | | | | | V | |
| Remark | 1. No other spurious found. 2. All results are PASS against Peak and Average limit line. | | | | | | | | | | | | | |



Band 4 5725~5850MHz
WIFI 802.11n HT20 (Harmonic @ 3m)

| WIFI Ant. | Note | Frequency | Level | Over Limit | Limit Line | Read Level | Antenna Factor | Path Loss | Preamp Factor | Ant Pos | Table Pos | Peak Avg. | Pol. |
|--------------------------------------|--|-----------|------------|------------|------------|------------|----------------|-----------|---------------|---------|-----------|-----------|-------|
| 1 | | (MHz) | (dBμV/m) | (dB) | (dBμV/m) | (dBμV) | (dB/m) | (dB) | (dB) | (cm) | (deg) | (P/A) | (H/V) |
| 802.11n HT20 CH 149 5745MHz | | 11490 | 45.94 | -28.06 | 74 | 49.06 | 39.91 | 18.37 | 61.4 | 100 | 0 | P | H |
| | | 17235 | 45.82 | -22.38 | 68.2 | 39.88 | 40.46 | 23.27 | 57.79 | 100 | 0 | P | H |
| | | | | | | | | | | | | | H |
| | | | | | | | | | | | | | H |
| | | 11490 | 46.31 | -27.69 | 74 | 49.43 | 39.91 | 18.37 | 61.4 | 100 | 0 | P | V |
| | | 17235 | 46.21 | -21.99 | 68.2 | 40.27 | 40.46 | 23.27 | 57.79 | 100 | 0 | P | V |
| | | | | | | | | | | | | | V |
| 802.11n HT20 CH 157 5785MHz | | 11570 | 46.18 | -27.82 | 74 | 49.51 | 39.76 | 18.44 | 61.53 | 100 | 0 | P | H |
| | | 17355 | 44.67 | -23.53 | 68.2 | 37.93 | 40.79 | 23.43 | 57.48 | 100 | 0 | P | H |
| | | | | | | | | | | | | | H |
| | | | | | | | | | | | | | H |
| | | 11570 | 44.8 | -29.2 | 74 | 48.13 | 39.76 | 18.44 | 61.53 | 100 | 0 | P | V |
| | | 17355 | 45.09 | -23.11 | 68.2 | 38.35 | 40.79 | 23.43 | 57.48 | 100 | 0 | P | V |
| | | | | | | | | | | | | | V |
| 802.11n HT20 CH 165 5825MHz | | 11650 | 45.55 | -28.45 | 74 | 49.12 | 39.6 | 18.5 | 61.67 | 100 | 0 | P | H |
| | | 17475 | 47.15 | -21.05 | 68.2 | 39.59 | 41.13 | 23.59 | 57.16 | 100 | 0 | P | H |
| | | | | | | | | | | | | | H |
| | | | | | | | | | | | | | H |
| | | 11650 | 44.78 | -29.22 | 74 | 48.35 | 39.6 | 18.5 | 61.67 | 100 | 0 | P | V |
| | | 17475 | 47.02 | -21.18 | 68.2 | 39.46 | 41.13 | 23.59 | 57.16 | 100 | 0 | P | V |
| | | | | | | | | | | | | | V |
| Remark | 1. No other spurious found. | | | | | | | | | | | | |
| | 2. All results are PASS against Peak and Average limit line. | | | | | | | | | | | | |



Band 4 5725~5850MHz
WIFI 802.11n HT40 (Band Edge @ 3m)

| WIFI Ant. | Note | Frequency | Level | Over Limit | Limit Line | Read Level | Antenna Factor | Path Loss | Preamp Factor | Ant Pos | Table Pos | Peak Avg. | Pol. |
|----------------|------|-----------|------------|------------|------------|------------|----------------|-----------|---------------|---------|-----------|-----------|---------|
| 1 | | (MHz) | (dBμV/m) | (dB) | (dBμV/m) | (dBμV) | (dB/m) | (dB) | (dB) | (cm) | (deg) | (P/A) | (H/V) |
| | | 5638.8 | 55.15 | -13.05 | 68.2 | 38.95 | 31.95 | 13.76 | 29.51 | 100 | 314 | P | H |
| | | 5694.6 | 64.55 | -36.67 | 101.22 | 48.11 | 32.05 | 13.92 | 29.53 | 100 | 314 | P | H |
| | | 5719.2 | 65.97 | -44.61 | 110.58 | 49.44 | 32.09 | 13.98 | 29.54 | 100 | 314 | P | H |
| | | 5720.6 | 66.66 | -45.51 | 112.17 | 50.11 | 32.1 | 13.99 | 29.54 | 100 | 314 | P | H |
| | * | 5755 | 105.38 | - | - | 88.7 | 32.16 | 14.08 | 29.56 | 100 | 314 | P | H |
| | * | 5755 | 97.51 | - | - | 80.83 | 32.16 | 14.08 | 29.56 | 100 | 314 | A | H |
| | | 5853.4 | 55.94 | -58.51 | 114.45 | 39.18 | 32.34 | 14.02 | 29.6 | 100 | 314 | P | H |
| | | 5860.8 | 56.51 | -52.66 | 109.17 | 39.78 | 32.35 | 14 | 29.62 | 100 | 314 | P | H |
| | | 5912.8 | 56.16 | -21.04 | 77.2 | 39.54 | 32.44 | 13.82 | 29.64 | 100 | 314 | P | H |
| | | 5940.8 | 55.68 | -12.52 | 68.2 | 39.12 | 32.49 | 13.73 | 29.66 | 100 | 314 | P | H |
| 802.11n | | | | | | | | | | | | | H |
| HT40 | | | | | | | | | | | | | H |
| CH 151 | | 5611.8 | 54.8 | -13.4 | 68.2 | 38.7 | 31.9 | 13.69 | 29.49 | 358 | 27 | P | V |
| 5755MHz | | 5695 | 62.25 | -39.26 | 101.51 | 45.81 | 32.05 | 13.92 | 29.53 | 358 | 27 | P | V |
| | | 5711 | 63.93 | -44.35 | 108.28 | 47.43 | 32.08 | 13.96 | 29.54 | 358 | 27 | P | V |
| | | 5724 | 64.22 | -55.7 | 119.92 | 47.67 | 32.1 | 13.99 | 29.54 | 358 | 27 | P | V |
| | * | 5755 | 102.17 | - | - | 85.49 | 32.16 | 14.08 | 29.56 | 358 | 27 | P | V |
| | * | 5755 | 95.09 | - | - | 78.41 | 32.16 | 14.08 | 29.56 | 358 | 27 | A | V |
| | | 5853.6 | 55.49 | -58.5 | 113.99 | 38.73 | 32.34 | 14.02 | 29.6 | 358 | 27 | P | V |
| | | 5862.4 | 55.23 | -53.5 | 108.73 | 38.51 | 32.35 | 13.99 | 29.62 | 358 | 27 | P | V |
| | | 5894 | 56.55 | -34.55 | 91.1 | 39.88 | 32.41 | 13.89 | 29.63 | 358 | 27 | P | V |
| | | 5943.4 | 55.24 | -12.96 | 68.2 | 38.68 | 32.5 | 13.72 | 29.66 | 358 | 27 | P | V |
| | | | | | | | | | | | | | V |
| | | | | | | | | | | | | | V |



| WIFI Ant. | Note | Frequency | Level | Over Limit | Limit Line | Read Level | Antenna Factor | Path Loss | Preamp Factor | Ant Pos | Table Pos | Peak Avg. | Pol. |
|----------------|---|-----------|------------|------------|------------|------------|----------------|-----------|---------------|---------|-----------|-----------|---------|
| 1 | | (MHz) | (dBµV/m) | (dB) | (dBµV/m) | (dBµV) | (dB/m) | (dB) | (dB) | (cm) | (deg) | (P/A) | (H/V) |
| | | 5637.6 | 55.02 | -13.18 | 68.2 | 38.82 | 31.95 | 13.76 | 29.51 | 102 | 315 | P | H |
| | | 5698.6 | 59.53 | -44.64 | 104.17 | 43.07 | 32.06 | 13.93 | 29.53 | 102 | 315 | P | H |
| | | 5718.6 | 62.58 | -47.83 | 110.41 | 46.05 | 32.09 | 13.98 | 29.54 | 102 | 315 | P | H |
| | | 5724.4 | 64.25 | -56.58 | 120.83 | 47.69 | 32.1 | 14 | 29.54 | 102 | 315 | P | H |
| | * | 5795 | 105.42 | - | - | 88.58 | 32.23 | 14.19 | 29.58 | 102 | 315 | P | H |
| | * | 5795 | 97.58 | - | - | 80.74 | 32.23 | 14.19 | 29.58 | 102 | 315 | A | H |
| | | 5854.4 | 63.95 | -48.22 | 112.17 | 47.19 | 32.34 | 14.02 | 29.6 | 102 | 315 | P | H |
| | | 5856 | 63.65 | -46.87 | 110.52 | 46.9 | 32.34 | 14.01 | 29.6 | 102 | 315 | P | H |
| | | 5875.6 | 59.9 | -44.85 | 104.75 | 43.19 | 32.38 | 13.95 | 29.62 | 102 | 315 | P | H |
| | | 5941.4 | 55.35 | -12.85 | 68.2 | 38.79 | 32.49 | 13.73 | 29.66 | 102 | 315 | P | H |
| | | | | | | | | | | | | | H |
| | | | | | | | | | | | | | H |
| 802.11n | | | | | | | | | | | | | |
| HT40 | | | | | | | | | | | | | |
| CH 159 | | 5643.2 | 55.44 | -12.76 | 68.2 | 39.21 | 31.96 | 13.78 | 29.51 | 356 | 27 | P | V |
| 5795MHz | | 5699.2 | 58.48 | -46.13 | 104.61 | 42.02 | 32.06 | 13.93 | 29.53 | 356 | 27 | P | V |
| | | 5717 | 60.25 | -49.71 | 109.96 | 43.72 | 32.09 | 13.98 | 29.54 | 356 | 27 | P | V |
| | | 5723.8 | 61.67 | -57.79 | 119.46 | 45.12 | 32.1 | 13.99 | 29.54 | 356 | 27 | P | V |
| | * | 5795 | 103.22 | - | - | 86.38 | 32.23 | 14.19 | 29.58 | 356 | 27 | P | V |
| | * | 5795 | 95.54 | - | - | 78.7 | 32.23 | 14.19 | 29.58 | 356 | 27 | A | V |
| | | 5854.2 | 62.51 | -50.11 | 112.62 | 45.75 | 32.34 | 14.02 | 29.6 | 356 | 27 | P | V |
| | | 5856.4 | 61.49 | -48.92 | 110.41 | 44.74 | 32.34 | 14.01 | 29.6 | 356 | 27 | P | V |
| | | 5882 | 57.97 | -42.03 | 100 | 41.27 | 32.39 | 13.93 | 29.62 | 356 | 27 | P | V |
| | | 5949.6 | 55.79 | -12.41 | 68.2 | 39.24 | 32.51 | 13.7 | 29.66 | 356 | 27 | P | V |
| | | | | | | | | | | | | | V |
| | | | | | | | | | | | | | V |
| Remark | 1. No other spurious found. 2. All results are PASS against Peak and Average limit line. | | | | | | | | | | | | |



**Band 4 5725~5850MHz
WIFI 802.11n HT40 (Harmonic @ 3m)**

| WIFI Ant. | Note | Frequency | Level | Over Limit | Limit Line | Read Level | Antenna Factor | Path Loss | Preamp Factor | Ant Pos | Table Pos | Peak Avg. | Pol. |
|--------------------------------------|---|-----------|------------|------------|------------|------------|----------------|-----------|---------------|---------|-----------|-----------|---------|
| 1 | | (MHz) | (dBμV/m) | (dB) | (dBμV/m) | (dBμV) | (dB/m) | (dB) | (dB) | (cm) | (deg) | (P/A) | (H/V) |
| 802.11n HT40 CH 151 5755MHz | | 11510 | 45.79 | -28.21 | 74 | 48.94 | 39.88 | 18.39 | 61.42 | 100 | 0 | P | H |
| | | 17265 | 46.27 | -21.93 | 68.2 | 40.14 | 40.54 | 23.3 | 57.71 | 100 | 0 | P | H |
| | | | | | | | | | | | | | H |
| | | | | | | | | | | | | | H |
| | | 11510 | 45.7 | -28.3 | 74 | 48.85 | 39.88 | 18.39 | 61.42 | 100 | 0 | P | V |
| | | 17265 | 46.44 | -21.76 | 68.2 | 40.31 | 40.54 | 23.3 | 57.71 | 100 | 0 | P | V |
| | | | | | | | | | | | | | V |
| | | | | | | | | | | | | | V |
| 802.11n HT40 CH 159 5795MHz | | 11590 | 46.25 | -27.75 | 74 | 49.63 | 39.72 | 18.46 | 61.56 | 100 | 0 | P | H |
| | | 17385 | 47.36 | -20.84 | 68.2 | 40.41 | 40.88 | 23.47 | 57.4 | 100 | 0 | P | H |
| | | | | | | | | | | | | | H |
| | | | | | | | | | | | | | H |
| | | 11590 | 46.25 | -27.75 | 74 | 49.63 | 39.72 | 18.46 | 61.56 | 100 | 0 | P | V |
| | | 17385 | 47.39 | -20.81 | 68.2 | 40.44 | 40.88 | 23.47 | 57.4 | 100 | 0 | P | V |
| | | | | | | | | | | | | | V |
| | | | | | | | | | | | | | V |
| Remark | 1. No other spurious found. 2. All results are PASS against Peak and Average limit line. | | | | | | | | | | | | |



Band 4 5725~5850MHz
WIFI 802.11ac VHT80 (Band Edge @ 3m)

| WIFI Ant. | Note | Frequency | Level | Over Limit | Limit Line | Read Level | Antenna Factor | Path Loss | Preamp Factor | Ant Pos | Table Pos | Peak Avg. | Pol. |
|-----------------|---|-----------|------------|------------|------------|------------|----------------|-----------|---------------|---------|-----------|-----------|-------|
| 1 | | (MHz) | (dBμV/m) | (dB) | (dBμV/m) | (dBμV) | (dB/m) | (dB) | (dB) | (cm) | (deg) | (P/A) | (H/V) |
| | | 5619.4 | 55.09 | -13.11 | 68.2 | 38.96 | 31.91 | 13.71 | 29.49 | 100 | 314 | P | H |
| | | 5699.6 | 59.52 | -45.39 | 104.91 | 43.06 | 32.06 | 13.93 | 29.53 | 100 | 314 | P | H |
| | | 5718.6 | 63.28 | -47.13 | 110.41 | 46.75 | 32.09 | 13.98 | 29.54 | 100 | 314 | P | H |
| | | 5723.2 | 63.53 | -54.57 | 118.1 | 46.98 | 32.1 | 13.99 | 29.54 | 100 | 314 | P | H |
| | * | 5775 | 101.05 | - | - | 84.3 | 32.19 | 14.13 | 29.57 | 100 | 314 | P | H |
| | * | 5775 | 93.65 | - | - | 76.9 | 32.19 | 14.13 | 29.57 | 100 | 314 | A | H |
| | | 5853.4 | 64.02 | -50.43 | 114.45 | 47.26 | 32.34 | 14.02 | 29.6 | 100 | 314 | P | H |
| | | 5858.4 | 62.65 | -47.2 | 109.85 | 45.92 | 32.35 | 14 | 29.62 | 100 | 314 | P | H |
| | | 5876.4 | 58.23 | -45.93 | 104.16 | 41.53 | 32.38 | 13.94 | 29.62 | 100 | 314 | P | H |
| | | 5933.4 | 54.81 | -13.39 | 68.2 | 38.22 | 32.48 | 13.75 | 29.64 | 100 | 314 | P | H |
| 802.11ac | | | | | | | | | | | | | H |
| VHT80 | | | | | | | | | | | | | H |
| CH 155 | | 5609 | 55.13 | -13.07 | 68.2 | 39.04 | 31.9 | 13.68 | 29.49 | 357 | 29 | P | V |
| 5775MHz | | 5684.4 | 57.4 | -36.29 | 93.69 | 41.01 | 32.03 | 13.89 | 29.53 | 357 | 29 | P | V |
| | | 5719 | 59.43 | -51.09 | 110.52 | 42.9 | 32.09 | 13.98 | 29.54 | 357 | 29 | P | V |
| | | 5723 | 59.94 | -57.7 | 117.64 | 43.39 | 32.1 | 13.99 | 29.54 | 357 | 29 | P | V |
| | * | 5775 | 99.09 | - | - | 82.34 | 32.19 | 14.13 | 29.57 | 357 | 29 | P | V |
| | * | 5775 | 91.38 | - | - | 74.63 | 32.19 | 14.13 | 29.57 | 357 | 29 | A | V |
| | | 5853.8 | 62.34 | -51.2 | 113.54 | 45.58 | 32.34 | 14.02 | 29.6 | 357 | 29 | P | V |
| | | 5855.8 | 61.94 | -48.64 | 110.58 | 45.19 | 32.34 | 14.01 | 29.6 | 357 | 29 | P | V |
| | | 5875.2 | 57.68 | -47.37 | 105.05 | 40.97 | 32.38 | 13.95 | 29.62 | 357 | 29 | P | V |
| | | 5947 | 55.94 | -12.26 | 68.2 | 39.39 | 32.5 | 13.71 | 29.66 | 357 | 29 | P | V |
| | | | | | | | | | | | | | V |
| | | | | | | | | | | | | | V |
| Remark | 1. No other spurious found. 2. All results are PASS against Peak and Average limit line. | | | | | | | | | | | | |



**Band 4 5725~5850MHz
WIFI 802.11ac VHT80 (Harmonic @ 3m)**

| WIFI Ant. | Note | Frequency | Level | Over Limit | Limit Line | Read Level | Antenna Factor | Path Loss | Preamp Factor | Ant Pos | Table Pos | Peak Avg. | Pol. | |
|--|---|-----------|------------|------------|------------|------------|----------------|-----------|---------------|---------|-----------|-----------|---------|---|
| 1 | | (MHz) | (dBμV/m) | (dB) | (dBμV/m) | (dBμV) | (dB/m) | (dB) | (dB) | (cm) | (deg) | (P/A) | (H/V) | |
| 802.11ac VHT80 CH 155 5775MHz | | 11550 | 46.17 | -27.83 | 74 | 49.44 | 39.8 | 18.42 | 61.49 | 100 | 0 | P | H | |
| | | 17325 | 48.5 | -19.7 | 68.2 | 41.96 | 40.71 | 23.39 | 57.56 | 100 | 0 | P | H | |
| | | | | | | | | | | | | | H | |
| | | | | | | | | | | | | | H | |
| | | | 11550 | 46.61 | -27.39 | 74 | 49.88 | 39.8 | 18.42 | 61.49 | 100 | 0 | P | V |
| | | | 17325 | 49.13 | -19.07 | 68.2 | 42.59 | 40.71 | 23.39 | 57.56 | 100 | 0 | P | V |
| | | | | | | | | | | | | | | V |
| | | | | | | | | | | | | | V | |
| Remark | 1. No other spurious found. 2. All results are PASS against Peak and Average limit line. | | | | | | | | | | | | | |



Emission below 1GHz
5GHz WIFI 802.11n HT20 (LF @ 3m)

Table with 14 columns: WIFI Ant., Note, Frequency (MHz), Level (dBµV/m), Over Limit (dB), Limit Line (dBµV/m), Read Level (dBµV), Antenna Factor (dB/m), Path Loss (dB), Preamp Factor (dB), Ant Pos (cm), Table Pos (deg), Peak Avg. (P/A), Pol. (H/V). Rows include data for frequencies 137.73, 149.88, 186.06, 533.8, 755.7, 958.7 and 36.48, 40.8, 44.85, 533.8, 761.3, 916.

Remark
1. No other spurious found.
2. All results are PASS against limit line.



Note symbol

| | |
|-----|--|
| * | Fundamental Frequency which can be ignored. However, the level of any unwanted emissions shall not exceed the level of the fundamental frequency. |
| ! | Test result is over limit line. |
| P/A | Peak or Average |
| H/V | Horizontal or Vertical |



A calculation example for radiated spurious emission is shown as below:

| WIFI | Note | Frequency | Level | Over | Limit | Read | Antenna | Path | Preamp | Ant | Table | Peak | Pol. |
|---------|------|-----------|------------|--------|------------|----------|----------|--------|--------|--------|---------|---------|---------|
| Ant. | | | | Limit | Line | Level | Factor | Loss | Factor | Pos | Pos | Avg. | |
| 1 | | (MHz) | (dBμV/m) | (dB) | (dBμV/m) | (dBμV) | (dB/m) | (dB) | (dB) | (cm) | (deg) | (P/A) | (H/V) |
| 802.11b | | 2390 | 55.45 | -18.55 | 74 | 54.51 | 32.22 | 4.58 | 35.86 | 103 | 308 | P | H |
| CH 01 | | | | | | | | | | | | | |
| 2412MHz | | 2390 | 43.54 | -10.46 | 54 | 42.6 | 32.22 | 4.58 | 35.86 | 103 | 308 | A | H |

1. Path Loss(dB) = Cable loss(dB) + Filter loss(dB) + Attenuator loss(dB)
2. Level(dBμV/m) = Antenna Factor(dB/m) + Path Loss(dB) + Read Level(dBμV) - Preamp Factor(dB)
3. Over Limit(dB) = Level(dBμV/m) – Limit Line(dBμV/m)

For Peak Limit @ 2390MHz:

1. Level(dBμV/m)
= Antenna Factor(dB/m) + Path Loss(dB) + Read Level(dBμV) - Preamp Factor(dB)
= 32.22(dB/m) + 4.58(dB) + 54.51(dBμV) – 35.86 (dB)
= 55.45 (dBμV/m)
2. Over Limit(dB)
= Level(dBμV/m) – Limit Line(dBμV/m)
= 55.45(dBμV/m) – 74(dBμV/m)
= -18.55(dB)

For Average Limit @ 2390MHz:

1. Level(dBμV/m)
= Antenna Factor(dB/m) + Path Loss(dB) + Read Level(dBμV) - Preamp Factor(dB)
= 32.22(dB/m) + 4.58(dB) + 42.6(dBμV) – 35.86 (dB)
= 43.54 (dBμV/m)
2. Over Limit(dB) = Level(dBμV/m) – Limit Line(dBμV/m)
= 43.54(dBμV/m) – 54(dBμV/m)
= -10.46(dB)

Both peak and average measured complies with the limit line, so test result is "PASS".



Appendix D. Radiated Spurious Emission Plots

| | | | |
|-----------------|--|---------------------|---------|
| Test Engineer : | J.C. Liang, Andy Yang, and Master Liao | Temperature : | 22~25°C |
| | | Relative Humidity : | 50~54% |

Note symbol

| | |
|----|-----------------------|
| -L | Low channel location |
| -R | High channel location |



Band 4 - 5725~5850MHz
WIFI 802.11a (Band Edge @ 3m)

| WIFI | Band 4 5725~5850MHz Band Edge @ 3m | |
|-------------|--|---|
| ANT | 802.11a CH149 5745MHz | |
| 1 | Horizontal | Fundamental |
| Peak | <p>Site : 03CH16-HY Condition : PEAK_06(04)_16-24 3m HORN_1212 HORIZONTAL Detector : Peak Project : 882920-01</p> | <p>Site : 03CH16-HY Condition : PEAK0001 3m HORN_1212 HORIZONTAL Detector : Peak Project : 882920-01</p> |



| WIFI | Band 4 5725~5850MHz Band Edge @ 3m | |
|------|--|---|
| ANT | 802.11a CH149 5745MHz | |
| 1 | Vertical | Fundamental |
| Peak | <p>Site : 03CH16-11Y Condition : PEAK_BE(B4)_16-24 3m HORN_1212 VERTICAL Detector : Peak Project : 882920-01</p> | <p>Site : 03CH16-11Y Condition : PEAK(LINE) 3m HORN_1212 VERTICAL Detector : Peak Project : 882920-01</p> |



| | | |
|------|---|---|
| WIFI | Band 4 5725~5850MHz Band Edge @ 3m | |
| ANT | 802.11a CH157 5785MHz | |
| 1 | Horizontal | Fundamental |
| Peak | <p>Date: 2018-09-20 PEAK_BE(B4)_16-24</p> <p>Site : 03CH16-HY Condition : PEAK_BE(B4)_16-24 3m HORN_1212 HORIZONTAL Detector : Peak Project : 882920-01</p> | <p>Date: 2018-09-20 PEAK(LINB)</p> <p>Site : 03CH16-HY Condition : PEAK(LINB) 3m HORN_1212 HORIZONTAL Detector : Peak Project : 882920-01</p> |
| Peak | <p>Date: 2018-09-20 PEAK_BE(B4)_16-24</p> <p>Site : 03CH16-HY Condition : PEAK_BE(B4)_16-24 3m HORN_1212 HORIZONTAL Detector : Peak Project : 882920-01</p> | Left blank |



| WIFI | Band 4 5725~5850MHz Band Edge @ 3m | |
|------|--|--|
| ANT | 802.11a CH157 5785MHz | |
| 1 | Vertical | Fundamental |
| Peak | <p>Date: 2018-09-20 PEAK_BE(B4)_16-24</p> <p>Site : 03CH16-HY Condition : PEAK_BE(B4)_16-24 3m HORN_1212 VERTICAL RBW:1000.000KHz VBW:3000.000KHz SWT:Auto Detector : Peak Project : 882920-01</p> | <p>Date: 2018-09-20 PEAK(LIN)B</p> <p>Site : 03CH16-HY Condition : PEAK(LIN)I 3m HORN_1212 VERTICAL RBW:1000.000KHz VBW:3000.000KHz SWT:Auto Detector : Peak Project : 882920-01</p> |
| Peak | <p>Date: 2018-09-20 PEAK_BE(B4)_16-24</p> <p>Site : 03CH16-HY Condition : PEAK_BE(B4)_16-24 3m HORN_1212 VERTICAL RBW:1000.000KHz VBW:3000.000KHz SWT:Auto Detector : Peak Project : 882920-01</p> | Left blank |



| WIFI | Band 4 5725~5850MHz Band Edge @ 3m | |
|------|--|---|
| ANT | 802.11a CH165 5825MHz | |
| 1 | Horizontal | Fundamental |
| Peak | <p>Site : 03CH16-11Y Condition : PEAK_BE(B4)_16-24 3m HORN_1212 HORIZONTAL Detector : Peak Project : 882920-01</p> | <p>Site : 03CH16-11Y Condition : PEAK(LINE) 3m HORN_1212 HORIZONTAL Detector : Peak Project : 882920-01</p> |

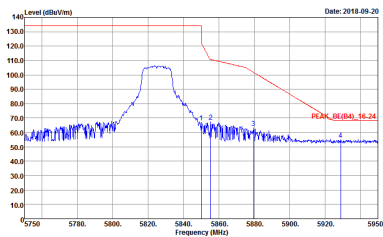
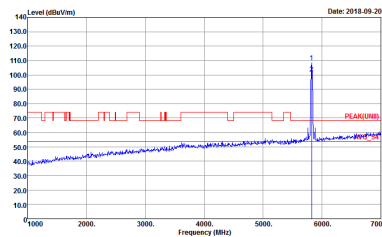

| | | |
|------|---|---|
| WIFI | Band 4 5725~5850MHz Band Edge @ 3m | |
| ANT | 802.11a CH165 5825MHz | |
| 1 | Vertical | Fundamental |
| Peak |  <p>Site : 03CH16-11Y Condition : PEAK_BE(B4)_16-24 3m HORN_1212 VERTICAL Detector : Peak Project : 882920-01</p> |  <p>Site : 03CH16-11Y Condition : PEAK(LINE) 3m HORN_1212 VERTICAL Detector : Peak Project : 882920-01</p> |



**Band 4 5725~5850MHz
WIFI 802.11n HT20 (Band Edge @ 3m)**

| WIFI | Band 4 5725~5850MHz Band Edge @ 3m | |
|-------------|--|---|
| ANT | 802.11n HT20 CH149 5745MHz | |
| 1 | Horizontal | Fundamental |
| Peak | <p>Site : 03CH16-HY Condition : PEAK_BE(B4)_16-24 3m HORN_1212 HORIZONTAL Detector : Peak Project : 882920-01 Setting : 14</p> | <p>Site : 03CH16-HY Condition : PEAK(UNIT) 3m HORN_1212 HORIZONTAL Detector : Peak Project : 882920-01 Setting : 14</p> |

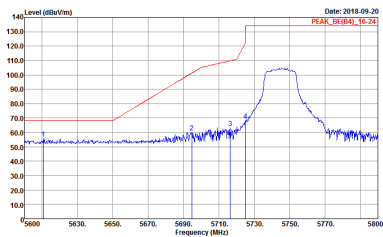
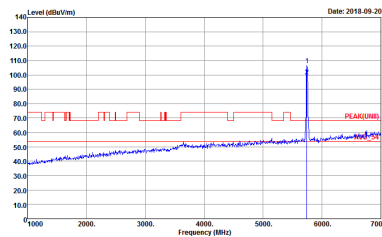

| | | |
|------|---|--|
| WIFI | Band 4 5725~5850MHz Band Edge @ 3m | |
| ANT | 802.11n HT20 CH149 5745MHz | |
| 1 | Vertical | Fundamental |
| Peak |  <p>Site : 03CH16-11Y Condition : PEAK_BE(B4)_16-24 3m HORN_1212 VERTICAL Detector : Peak Project : 882920-01 Setting : 14</p> |  <p>Site : 03CH16-11Y Condition : PEAK(LINII) 3m HORN_1212 VERTICAL Detector : Peak Project : 882920-01 Setting : 14</p> |



| WIFI | Band 4 5725~5850MHz Band Edge @ 3m | |
|------|--|--|
| ANT | 802.11n HT20 CH157 5785MHz | |
| 1 | Horizontal | Fundamental |
| Peak | <p>Date: 2018-09-20 PEAK_BE(B4)_16-24</p> <p>Site : 03CH16-HY Condition : PEAK_BE(B4)_16-24 3m HORN_1212 HORIZONTAL Detector : Peak Project : 882920-01 Setting : 14</p> | <p>Date: 2018-09-20 PEAK(LIN1)</p> <p>Site : 03CH16-HY Condition : PEAK(LIN1) 3m HORN_1212 HORIZONTAL Detector : Peak Project : 882920-01 Setting : 14</p> |
| Peak | <p>Date: 2018-09-20 PEAK_BE(B4)_16-24</p> <p>Site : 03CH16-HY Condition : PEAK_BE(B4)_16-24 3m HORN_1212 HORIZONTAL Detector : Peak Project : 882920-01 Setting : 14</p> | Left blank |

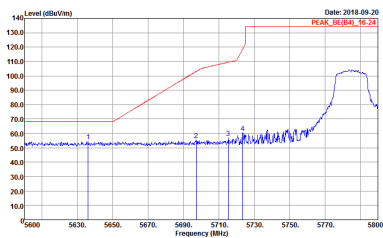
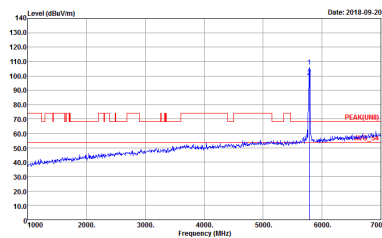
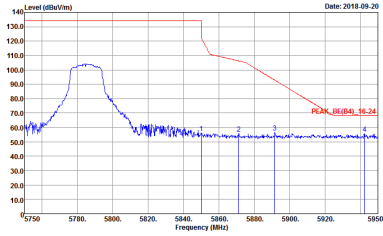

| WIFI | Band 4 5725~5850MHz Band Edge @ 3m | |
|------|--|---|
| ANT | 802.11n HT20 CH157 5785MHz | |
| 1 | Vertical | Fundamental |
| Peak |  <p>Date: 2018-09-20 PEAK_BE(B4)_16-24</p> <p>Site : 03CH16-HY Condition : PEAK_BE(B4)_16-24 3m HORN_1212 VERTICAL Detector : Peak Project : 882920-01 Setting : 14</p> |  <p>Date: 2018-09-20 PEAK(LIN1)</p> <p>Site : 03CH16-HY Condition : PEAK(LIN1) 3m HORN_1212 VERTICAL Detector : Peak Project : 882920-01 Setting : 14</p> |
| Peak |  <p>Date: 2018-09-20 PEAK_BE(B4)_16-24</p> <p>Site : 03CH16-HY Condition : PEAK_BE(B4)_16-24 3m HORN_1212 VERTICAL Detector : Peak Project : 882920-01 Setting : 14</p> | Left blank |

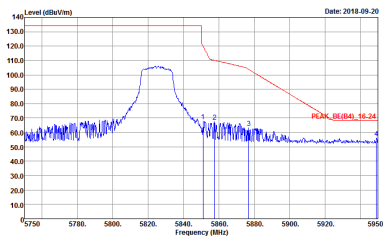
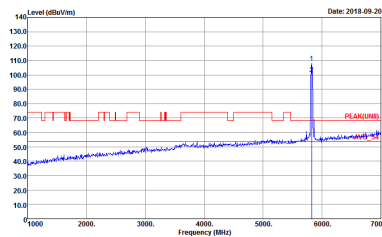

| | | |
|------|---|--|
| WIFI | Band 4 5725~5850MHz Band Edge @ 3m | |
| ANT | 802.11n HT20 CH165 5825MHz | |
| 1 | Horizontal | Fundamental |
| Peak |  <p>Site : 03CH16-11Y Condition : PEAK_BE(B4)_16-24 3m HORN_1212 HORIZONTAL Detector : Peak Project : 882920-01 Setting : 14</p> |  <p>Site : 03CH16-11Y Condition : PEAK(LINII) 3m HORN_1212 HORIZONTAL Detector : Peak Project : 882920-01 Setting : 14</p> |

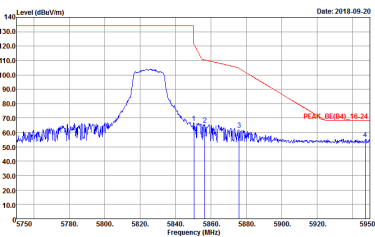
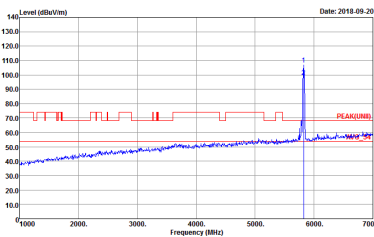

| WIFI | Band 4 5725~5850MHz Band Edge @ 3m | |
|--------------------|---|---|
| ANT | 802.11n HT20 CH165 5825MHz | |
| 1 | Vertical | Fundamental |
| <p>Peak</p> |  <p>Site : 03CH16-11Y Condition : PEAK_BE(B4)_16-24 3m HORN_1212 VERTICAL Detector : Peak Project : 882920-01 Setting : 14</p> |  <p>Site : 03CH16-11Y Condition : PEAK(LINE) 3m HORN_1212 VERTICAL Detector : Peak Project : 882920-01 Setting : 14</p> |



**Band 4 5725~5850MHz
WIFI 802.11n HT40 (Band Edge @ 3m)**

| WIFI | Band 4 5725~5850MHz Band Edge @ 3m | |
|-------------|--|---|
| ANT | 802.11n HT40 CH151 5755MHz | |
| 1 | Horizontal | Fundamental |
| Peak | <p>Site : 03CH16-HY Condition : PEAK_BE(B4)_16-24 3m HORN_1212 HORIZONTAL Detector : Peak Project : 882920-01 Setting : 14</p> | <p>Site : 03CH16-HY Condition : PEAK(UNIT) 3m HORN_1212 HORIZONTAL Detector : Peak Project : 882920-01 Setting : 14</p> |
| Peak | <p>Site : 03CH16-HY Condition : PEAK_BE(B4)_16-24 3m HORN_1212 HORIZONTAL Detector : Peak Project : 882920-01 Setting : 14</p> | Left blank |

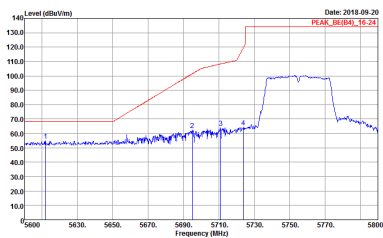
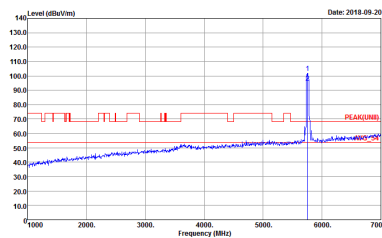
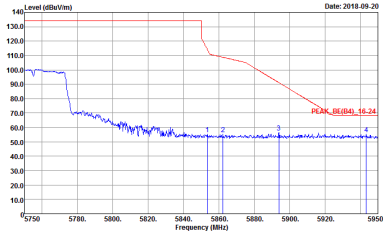

| WIFI | Band 4 5725~5850MHz Band Edge @ 3m | |
|------|--|---|
| ANT | 802.11n HT40 CH151 5755MHz | |
| 1 | Vertical | Fundamental |
| Peak |  <p>Date: 2018-09-20 PEAK_BE(B4)_16-24</p> <p>Site : 03CH16-HY Condition : PEAK_BE(B4)_16-24 3m HORN_1212 VERTICAL Detector : Peak Project : 882920-01 Setting : 14</p> |  <p>Date: 2018-09-20 PEAK(LIN1)</p> <p>Site : 03CH16-HY Condition : PEAK(LIN1) 3m HORN_1212 VERTICAL Detector : Peak Project : 882920-01 Setting : 14</p> |
| Peak |  <p>Date: 2018-09-20 PEAK_BE(B4)_16-24</p> <p>Site : 03CH16-HY Condition : PEAK_BE(B4)_16-24 3m HORN_1212 VERTICAL Detector : Peak Project : 882920-01 Setting : 14</p> | Left blank |

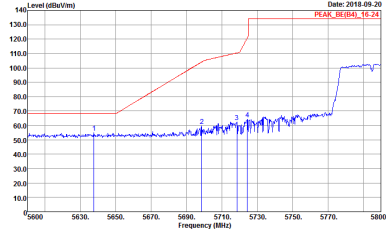
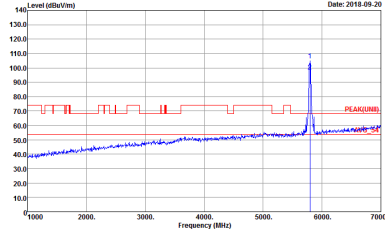
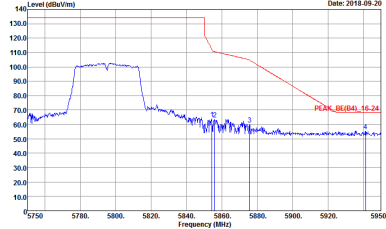

| WIFI | Band 4 5725~5850MHz Band Edge @ 3m | |
|------|--|--|
| ANT | 802.11n HT40 CH159 5795MHz | |
| 1 | Horizontal | Fundamental |
| Peak |  <p>Site : 03CH16-HY Condition : PEAK_BE(B4)_16-24 3m HORN_1212 HORIZONTAL Detector : Peak Project : 882920-01 Setting : 14</p> |  <p>Site : 03CH16-HY Condition : PEAK(LIN1) 3m HORN_1212 HORIZONTAL Detector : Peak Project : 882920-01 Setting : 14</p> |
| Peak |  <p>Site : 03CH16-HY Condition : PEAK_BE(B4)_16-24 3m HORN_1212 HORIZONTAL Detector : Peak Project : 882920-01 Setting : 14</p> | Left blank |

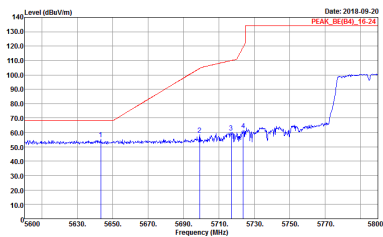
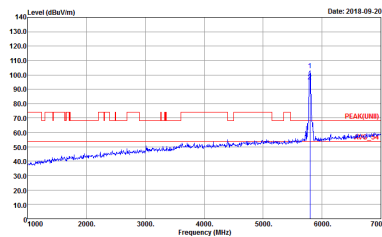
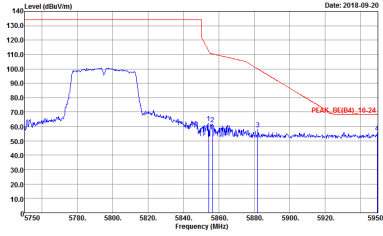

| WIFI | Band 4 5725~5850MHz Band Edge @ 3m | |
|------|--|---|
| ANT | 802.11n HT40 CH159 5795MHz | |
| 1 | Vertical | Fundamental |
| Peak |  <p>Date: 2018-09-20 PEAK_BE(B4)_16-24</p> <p>Site : 03CH16-HY Condition : PEAK_BE(B4)_16-24 3m HORN_1212 VERTICAL Detector : Peak Project : 882920-01 Setting : 14</p> |  <p>Date: 2018-09-20 PEAK(LIN1)</p> <p>Site : 03CH16-HY Condition : PEAK(LIN1) 3m HORN_1212 VERTICAL Detector : Peak Project : 882920-01 Setting : 14</p> |
| Peak |  <p>Date: 2018-09-20 PEAK_BE(B4)_16-24</p> <p>Site : 03CH16-HY Condition : PEAK_BE(B4)_16-24 3m HORN_1212 VERTICAL Detector : Peak Project : 882920-01 Setting : 14</p> | Left blank |



Band 4 5725~5850MHz
WIFI 802.11ac VHT80 (Band Edge @ 3m)

| WIFI | Band 4 5725~5850MHz Band Edge @ 3m | |
|-------------|--|---|
| ANT | 802.11ac VHT80 CH155 5775MHz | |
| 1 | Horizontal | Fundamental |
| Peak | <p>Site : 03CH16-HY Condition : PEAK_BE(84)_16-24 3m HORN_1212 HORIZONTAL Detector : Peak Project : 882920-01</p> | <p>Site : 03CH16-HY Condition : PEAK(UNIT) 3m HORN_1212 HORIZONTAL Detector : Peak Project : 882920-01</p> |
| Peak | <p>Site : 03CH16-HY Condition : PEAK_BE(84)_16-24 3m HORN_1212 HORIZONTAL Detector : Peak Project : 882920-01</p> | Left blank |



| WIFI | Band 4 5725~5850MHz Band Edge @ 3m | |
|------|---|---|
| ANT | 802.11ac VHT80 CH155 5775MHz | |
| 1 | Vertical | Fundamental |
| Peak | <p>Date: 2018-09-22 PEAK_BE(B4)_16-24</p> <p>Site : 03CH16-HY Condition : PEAK_BE(B4)_16-24 3m HORN_1212 VERTICAL Detector : Peak Project : 882920-01</p> | <p>Date: 2018-09-20 PEAK(LINB)</p> <p>Site : 03CH16-HY Condition : PEAK(LINB) 3m HORN_1212 VERTICAL Detector : Peak Project : 882920-01</p> |
| Peak | <p>Date: 2018-09-20 PEAK_BE(B4)_16-24</p> <p>Site : 03CH16-HY Condition : PEAK_BE(B4)_16-24 3m HORN_1212 VERTICAL Detector : Peak Project : 882920-01</p> | Left blank |



Band 4 - 5725~5850MHz
WIFI 802.11a (Harmonic @ 3m)

| | | |
|----------------------------|---|---|
| WIFI | Band 4 5725~5850MHz Harmonic @ 3m | |
| ANT | 802.11a CH149 5745MHz | |
| 1 | Horizontal | Vertical |
| Peak Avg. | <p>Site : 03CH16-HY Condition : PEAK(UNIT) 3m HORN_1212 HORIZONTAL Detector : Peak Project : 882920-01</p> | <p>Site : 03CH16-HY Condition : PEAK(UNIT) 3m HORN_1212 VERTICAL Detector : Peak Project : 882920-01</p> |

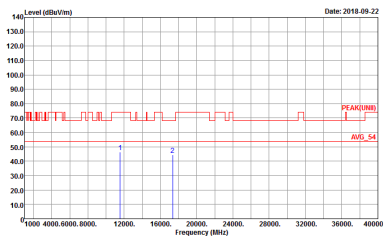
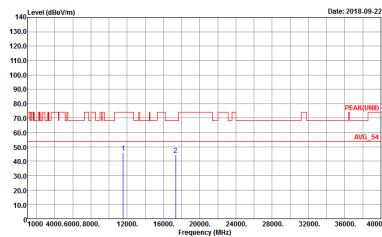

| | | |
|-------------------------|--|---|
| WIFI | Band 4 5725~5850MHz Harmonic @ 3m | |
| ANT | 802.11a CH157 5785MHz | |
| 1 | Horizontal | Vertical |
| <p>Peak</p> <p>Avg.</p> |  <p>Site : 03CH16-11Y Condition : PEAK(UNII) 3m HORN_1212 HORIZONTAL Detector : Peak Project : 882920-01</p> |  <p>Site : 03CH16-11Y Condition : PEAK(UNII) 3m HORN_1212 VERTICAL Detector : Peak Project : 882920-01</p> |



| | | |
|----------------------------|---|---|
| WIFI | Band 4 5725~5850MHz Harmonic @ 3m | |
| ANT | 802.11a CH165 5825MHz | |
| 1 | Horizontal | Vertical |
| Peak Avg. | <p>Site : 03CH16-11Y Condition : PEAK(UNII) 3m HORN_1212 HORIZONTAL Detector : Peak Project : 882920-01</p> | <p>Site : 03CH16-11Y Condition : PEAK(UNII) 3m HORN_1212 VERTICAL Detector : Peak Project : 882920-01</p> |



Band 4 5725~5850MHz
WIFI 802.11n HT20 (Harmonic @ 3m)

| WIFI | Band 4 5725~5850MHz Harmonic @ 3m | |
|--------------|---|---|
| ANT | 802.11n HT20 CH149 5745MHz | |
| 1 | Horizontal | Vertical |
| Peak Avg. | <p>Site : 03CH16-HY Condition : PEAK(UNII) 3m HORN_1212 HORIZONTAL Detector : Peak Project : 882920-01 Setting : 14</p> | <p>Site : 03CH16-HY Condition : PEAK(UNII) 3m HORN_1212 VERTICAL Detector : Peak Project : 882920-01 Setting : 14</p> |

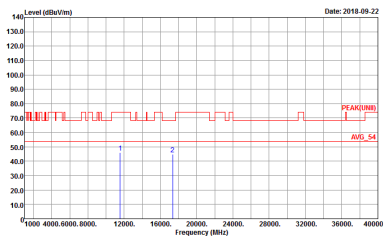
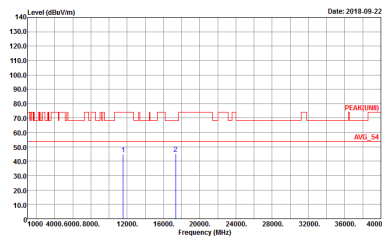

| | | |
|-------------------------|--|---|
| WIFI | Band 4 5725~5850MHz Harmonic @ 3m | |
| ANT | 802.11n HT20 CH157 5785MHz | |
| 1 | Horizontal | Vertical |
| <p>Peak</p> <p>Avg.</p> |  <p>Site : 03CH16-11F Condition : PEAK(UNII) 3m HORN_1212 HORIZONTAL Detector : Peak Project : 882920-01 Setting : 14</p> |  <p>Site : 03CH16-11F Condition : PEAK(UNII) 3m HORN_1212 VERTICAL Detector : Peak Project : 882920-01 Setting : 14</p> |

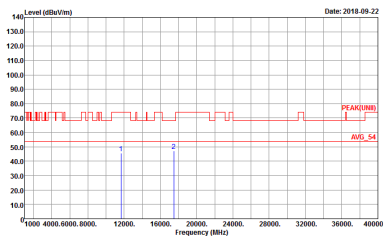
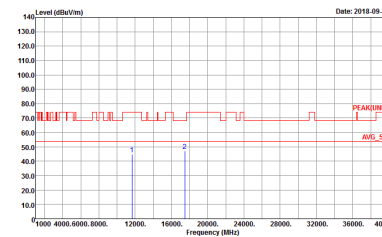

| | | |
|-------------------------|--|---|
| WIFI | Band 4 5725~5850MHz Harmonic @ 3m | |
| ANT | 802.11n HT20 CH165 5825MHz | |
| 1 | Horizontal | Vertical |
| <p>Peak</p> <p>Avg.</p> |  <p>Site : 03CH16-11Y Condition : PEAK(UNII) 3m HORN_1212 HORIZONTAL Detector : Peak Project : 882920-01</p> |  <p>Site : 03CH16-11Y Condition : PEAK(UNII) 3m HORN_1212 VERTICAL Detector : Peak Project : 882920-01</p> |



Band 4 5725~5850MHz
WIFI 802.11n HT40 (Harmonic @ 3m)

| WIFI | Band 4 5725~5850MHz Harmonic @ 3m | |
|--------------|---|---|
| ANT | 802.11n HT40 CH151 5755MHz | |
| 1 | Horizontal | Vertical |
| Peak Avg. | <p>Site : 03CH16-HY Condition : PEAK(UNII) 3m HORN_1212 HORIZONTAL Detector : Peak Project : 882920-01</p> | <p>Site : 03CH16-HY Condition : PEAK(UNII) 3m HORN_1212 VERTICAL Detector : Peak Project : 882920-01</p> |
| | | |



| | | |
|--------------|---|---|
| WIFI | Band 4 5725~5850MHz Harmonic @ 3m | |
| ANT | 802.11n HT40 CH159 5795MHz | |
| 1 | Horizontal | Vertical |
| Peak Avg. | <p>Site : 03CH16-11Y Condition : PEAK(UNII) 3m HORN_1212 HORIZONTAL Detector : Peak Project : 882920-01</p> | <p>Site : 03CH16-11Y Condition : PEAK(UNII) 3m HORN_1212 VERTICAL Detector : Peak Project : 882920-01</p> |



**Band 4 5725~5850MHz
WIFI 802.11ac VHT80 (Harmonic @ 3m)**

| WIFI | Band 4 5725~5850MHz Harmonic @ 3m | |
|--------------|--|--|
| ANT | 802.11ac VHT80 CH155 5775MHz | |
| 1 | Horizontal | Vertical |
| Peak Avg. | <p>Site : 03CH16-HY Condition : PEAK(UNII) 3m HORN_1212 HORIZONTAL Detector : Peak Project : 882920-01</p> | <p>Site : 03CH16-HY Condition : PEAK(UNII) 3m HORN_1212 VERTICAL Detector : Peak Project : 882920-01</p> |
| | | |



Emission below 1GHz
5GHz WIFI 802.11n HT20 (LF)

| WIFI | 5GHz 5725-5850MHz | |
|--------------|---|---|
| ANT | 802.11n HT20 LF | |
| 1 | Horizontal | Vertical |
| QP / Peak | <p>Site : 03CH16-HY Condition : QP 3m 80LOG_47020406 HORIZONTAL Detector : Peak Project : 882920-01</p> | <p>Site : 03CH16-HY Condition : QP 3m 80LOG_47020406 VERTICAL Detector : Peak Project : 882920-01</p> |



Appendix E. Duty Cycle Plots

| Band | Duty Cycle(%) | T(us) | 1/T(kHz) | VBW Setting | Duty Factor(dB) |
|---------------------|---------------|-------|----------|-------------|-----------------|
| 802.11a | 95.39 | 2070 | 0.48 | 1kHz | 0.20 |
| 5GHz 802.11n HT20 | 94.61 | 1930 | 0.52 | 1kHz | 0.24 |
| 5GHz 802.11n HT40 | 90.91 | 950 | 1.05 | 3kHz | 0.41 |
| 5GHz 802.11ac VHT20 | 94.53 | 1900 | 0.53 | 1kHz | 0.24 |
| 5GHz 802.11ac VHT40 | 89.47 | 935 | 1.07 | 3kHz | 0.48 |
| 5GHz 802.11ac VHT80 | 89.09 | 735 | 1.36 | 3kHz | 0.50 |



802.11a

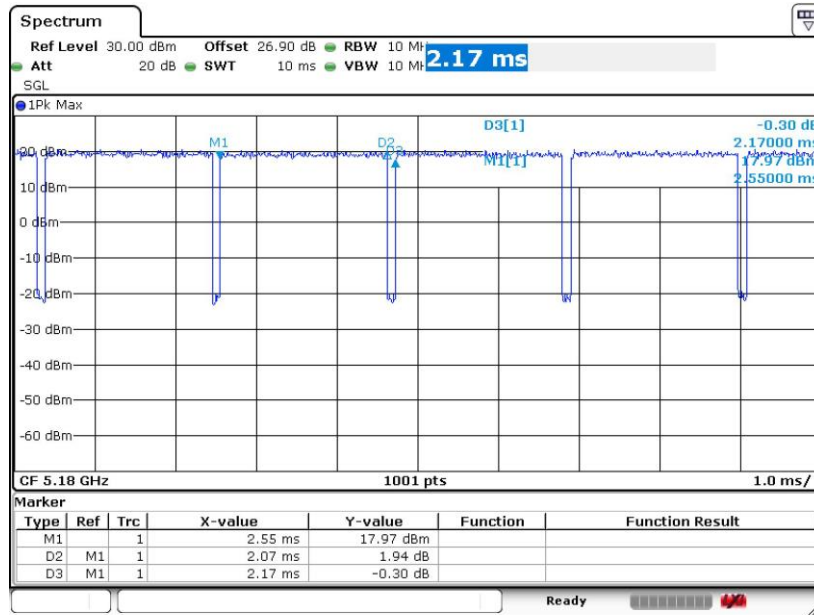

Date: 13.SEP.2018 00:35:34

802.11n HT20

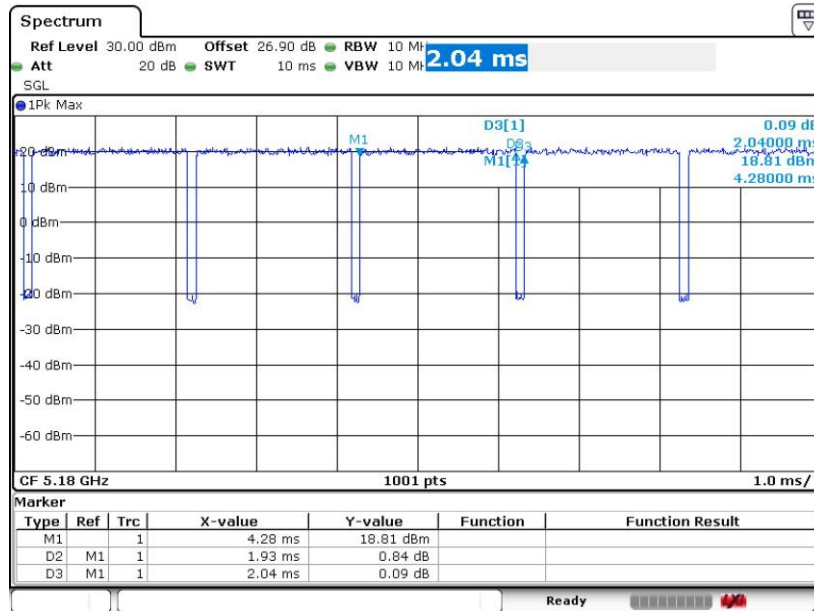

Date: 13.SEP.2018 00:46:41



802.11n HT40

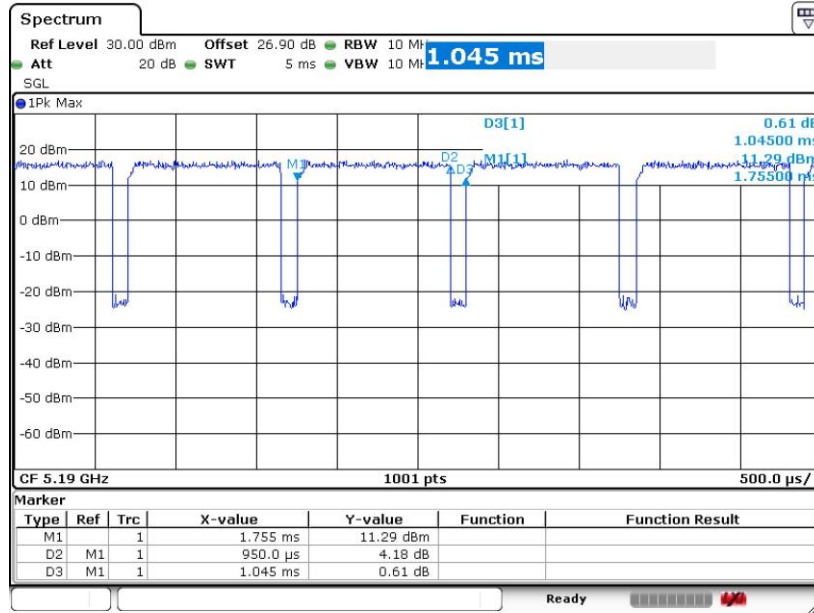

Date: 13.SEP.2018 01:02:59

802.11ac VHT20

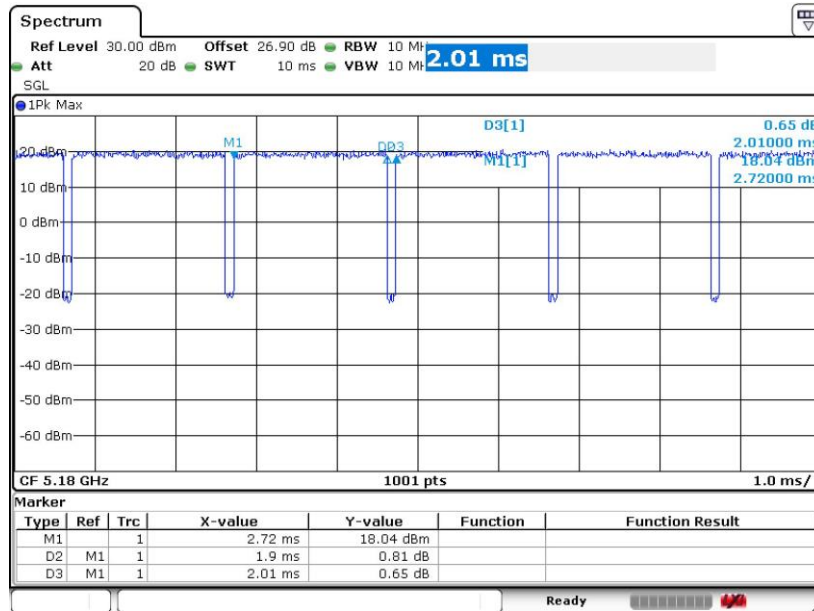

Date: 13.SEP.2018 01:13:14



802.11ac VHT40

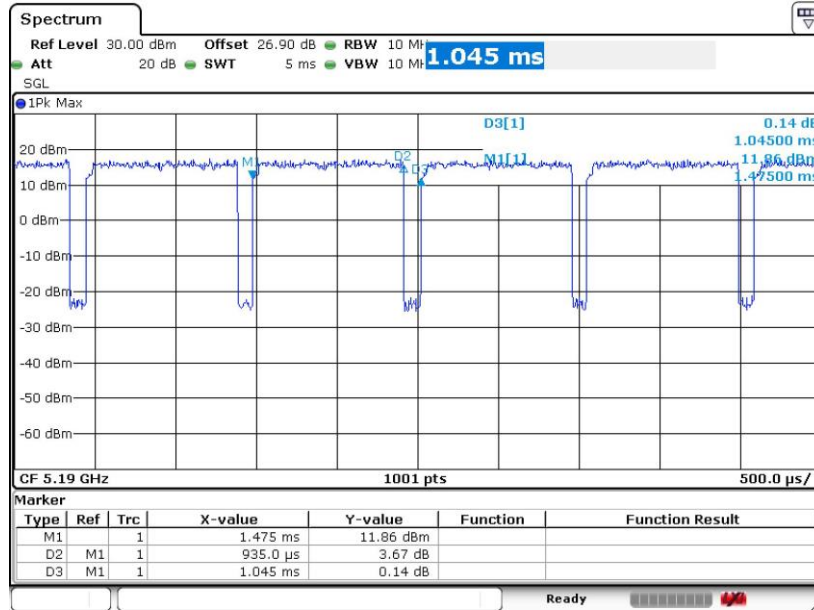

Date: 13.SEP.2018 01:19:58

802.11ac VHT80

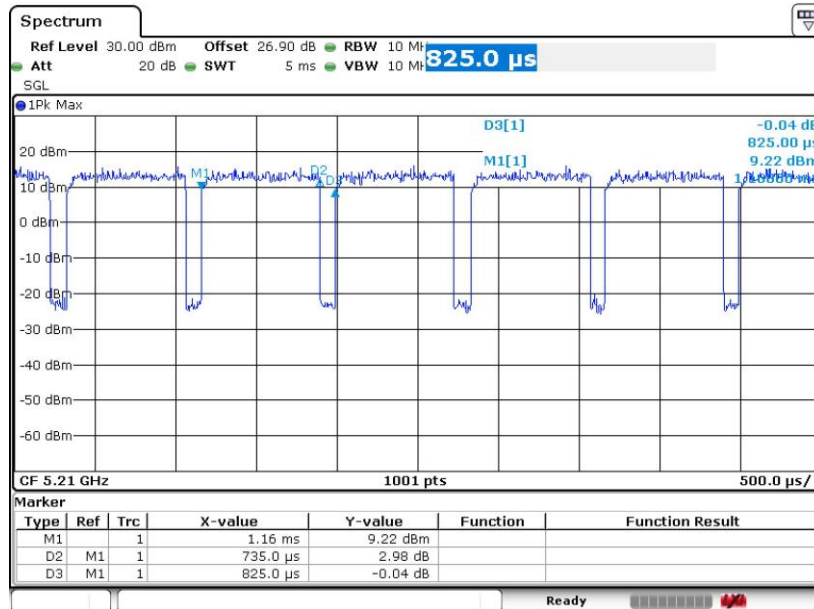

Date: 13.SEP.2018 01:23:21

————THE END————