

HEARING AID COMPATIBILITY

Applicant Name:
 Sony Mobile Communications Inc.
 4-12-3 Higashi-Shinagawa
 Shinagawa-ku
 Tokyo, 140-0002, Japan

Date of Testing:
 08/31/2020 - 09/22/2020
Test Site/Location:
 PCTEST, Columbia, MD, USA
Test Report Serial No.:
 1M2007070106-13-R3.PY7
Date of Issue:
 10/26/2020

FCC ID:	PY7-57441Y
APPLICANT:	SONY MOBILE COMMUNICATIONS INC.

Scope of Test: Audio Band Magnetic Testing (T-Coil)
Application Type: Certification
FCC Rule Part(s): CFR §20.19(b)
HAC Standard: ANSI C63.19-2011
 285076 D01 HAC Guidance v05
 285076 D02 T-Coil testing for CMRS IP v03
DUT Type: Portable Handset
Model: 57441Y
Test Device Serial No.: Pre-Production Sample [S/N: 82710, 80797]

C63.19-2011 HAC Category:	T4 (SIGNAL TO NOISE CATEGORY)
----------------------------------	--------------------------------------

Note: This revised Test Report (S/N: 1M2007070106-13-R3.PY7) supersedes and replaces the previously issued test report on the same subject device for the same type of testing as indicated. Please discard or destroy the previously issued test report(s) and dispose of it accordingly.

This wireless portable device has been shown to be hearing-aid compatible under the above rated category, specified in ANSI/IEEE Std. C63.19-2011 and has been tested in accordance with the specified measurement procedures. Test results reported herein relate only to the item(s) tested. Hearing-Aid Compatibility is based on the assumption that all production units will be designed electrically identical to the device tested in this report. North American Bands only.

I attest to the accuracy of data. All measurements reported herein were performed by me or were made under my supervision and are correct to the best of my knowledge and belief. I assume full responsibility for the completeness of these measurements and vouch for the qualifications of all persons taking them.



 Randy Ortanez
 President



FCC ID: PY7-57441Y		HAC (T-COIL) TEST REPORT	SONY	Approved by: Quality Manager
Filename: 1M2007070106-13-R3.PY7	Test Dates: 08/31/2020 - 09/22/2020	DUT Type: Portable Handset		Page 1 of 83

T A B L E O F C O N T E N T S

1.	INTRODUCTION	3
2.	DUT DESCRIPTION.....	4
3.	ANSI C63.19-2011 PERFORMANCE CATEGORIES	6
4.	METHOD OF MEASUREMENT	8
5.	VOLTE TEST SYSTEM SETUP AND DUT CONFIGURATION	18
6.	OTT VOIP TEST SYSTEM AND DUT CONFIGURATION	21
7.	FCC 3G MEASUREMENTS	28
8.	T-COIL TEST SUMMARY	29
9.	MEASUREMENT UNCERTAINTY	41
10.	EQUIPMENT LIST.....	42
11.	TEST DATA.....	43
12.	CALIBRATION CERTIFICATES.....	65
13.	CONCLUSION.....	78
14.	REFERENCES	79
15.	TEST SETUP PHOTOGRAPHS	81

FCC ID: PY7-57441Y		HAC (T-COIL) TEST REPORT	SONY	Approved by: Quality Manager
Filename: 1M2007070106-13-R3.PY7	Test Dates: 08/31/2020 - 09/22/2020	DUT Type: Portable Handset		Page 2 of 83

1. INTRODUCTION

On July 10, 2003, the Federal Communications Commission (FCC) adopted new rules requiring wireless manufacturers and service providers to provide digital wireless phones that are compatible with hearing aids. The FCC has modified the exemption for wireless phones under the Hearing Aid Compatibility Act of 1998 (HAC Act) in WT Docket 01-309 RM-8658¹ to extend the benefits of wireless telecommunications to individuals with hearing disabilities. These benefits encompass business, social and emergency communications, which increase the value of the wireless network for everyone. An estimated more than 10% of the population in the United States show signs of hearing impairment and of that fraction, almost 80% use hearing aids. Approximately 500 million people worldwide and 30 million people in the United States suffer from hearing loss.

Compatibility Tests Involved:

The standard calls for wireless communications devices to be measured for:

- RF Electric-field emissions
- T-coil mode, magnetic-signal strength in the audio band
- T-coil mode, magnetic-signal frequency response through the audio band
- T-coil mode, magnetic-signal and noise articulation index

The hearing aid must be measured for:

- RF immunity in microphone mode
- RF immunity in T-coil mode

In the following tests and results, this report includes the evaluation for a wireless communications device.

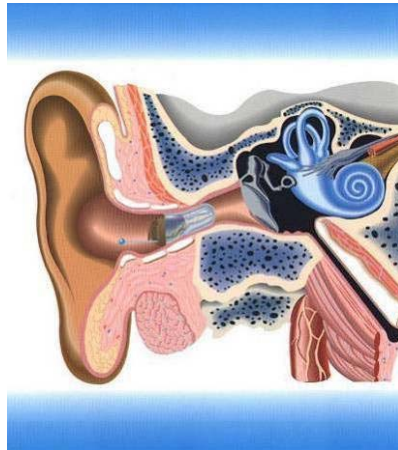



Figure 1-1 Hearing Aid *in-vitu*

¹ FCC Rule & Order, WT Docket 01-309 RM-8658

FCC ID: PY7-57441Y		HAC (T-COIL) TEST REPORT	SONY	Approved by: Quality Manager
Filename: 1M2007070106-13-R3.PY7	Test Dates: 08/31/2020 - 09/22/2020	DUT Type: Portable Handset		Page 3 of 83

2. DUT DESCRIPTION

SONY

FCC ID: PY7-57441Y
Applicant: Sony Mobile Communications Inc.
4-12-3 Higashi-Shinagawa
Shinagawa-ku
Tokyo, 140-0002, Japan
Model: 57441Y
Serial Number: 82710, 80797
HW Version: A
SW Version: 9.41
Antenna: Internal Antenna
DUT Type: Portable Handset

I. LTE Band Selection

This device supports the following pairs of LTE bands with similar frequencies: LTE B12 & B17 and B4 & B66. These pairs of LTE bands have the same target powers and share the same transmission paths. Since the supported frequency span for the smaller LTE bands are completely covered by the larger LTE bands, only the larger LTE bands (LTE B12 and B66) were evaluated for hearing-aid compliance. LTE B2 and B5 are LTE anchor bands for dual connectivity (EN-DC) scenarios between LTE and NR so they were additionally evaluated as independent LTE bands.

II. Device Serial Numbers

Several samples with identical hardware were used to support HAC testing. The manufacturer has confirmed that the device(s) tested have the same physical, mechanical, and thermal characteristics are within operational tolerances expected for production units. The serial numbers used for each test are indicated alongside the results in Section 8.



FCC ID: PY7-57441Y		HAC (T-COIL) TEST REPORT	SONY	Approved by: Quality Manager
Filename: 1M2007070106-13-R3.PY7	Test Dates: 08/31/2020 - 09/22/2020	DUT Type: Portable Handset		Page 4 of 83

Table 2-1
PY7-57441Y HAC Air Interfaces

Air-Interface	Band (MHz)	Type Transport	HAC Tested	Simultaneous But Not Tested	Name of Voice Service	Audio Codec Evaluated
GSM	850	VO	Yes	Yes: WIFI or BT	CMRS Voice ¹	EFR
	1900					
	GPRS/EDGE	VD	Yes	Yes: WIFI or BT	Google Duo ²	OPUS
	DTM	VD	Yes	Yes: WIFI or BT	CMRS Voice ¹ , Google Duo ²	EFR Google Duo: OPUS
UMTS	850	VD	Yes	Yes: WIFI or BT	CMRS Voice ¹	NB AMR
	1700					
	1900	VD	Yes	Yes: WIFI or BT	Google Duo ²	OPUS
	HSPA					
LTE (FDD)	700 (B12)	VD	Yes	Yes: WIFI or BT	VoLTE ¹ , Google Duo ²	VoLTE: NB AMR, WB AMR Google Duo: OPUS
	700 (B17)					
	780 (B13)					
	850 (B5)					
	850 (B26)					
	1700 (B4)					
	1700 (B66)					
	1900 (B2)					
	1900 (B25)					
2500 (B7)						
LTE (TDD)	2600 (B41)	VD	Yes	Yes: WIFI or BT	VoLTE ¹ , Google Duo ²	VoLTE: NB AMR, WB AMR Google Duo: OPUS
	3600 (B48)					
NR (FDD)	850 (n5)	VD	Yes ³	Yes: WIFI or BT	Google Duo ²	OPUS
	1700 (n66)					
	1900 (n2)					
NR (TDD)	28000 (n261)	VD	No ⁴	Yes: WIFI or BT	Google Duo ²	OPUS
	39000 (n260)					
WIFI	2450	VD	Yes	Yes: GSM, UMTS, LTE, or NR	Google Duo ²	Google Duo: OPUS
	5200 (U-NII 1)					
	5300 (U-NII 2A)					
	5500 (U-NII 2C)					
	5800 (U-NII 3)					
BT	2450	DT	No	Yes: GSM, UMTS, LTE, or NR	N/A	N/A
Type Transport VO = Voice Only DT = Digital Data - Not intended for Voice Services VD = CMRS and/or IP Voice over Data Transport			Notes: 1. Reference level in accordance with 7.4.2.1 of ANSI C63.19-2011 and July 2012 C63 VoLTE Interpretation. 2. Reference level is -20dBm0 in accordance with FCC KDB 285076 D02 3. NR was evaluated using an interim procedure outlined in Section 6.11.3. 4. n260 and n261 are currently outside the scope of ANSI C63.19 and FCC HAC regulations therefore they were not evaluated.			

FCC ID: PY7-57441Y		HAC (T-COIL) TEST REPORT		Approved by: Quality Manager
Filename: 1M2007070106-13-R3.PY7	Test Dates: 08/31/2020 - 09/22/2020	DUT Type: Portable Handset		Page 5 of 83

3. ANSI C63.19-2011 PERFORMANCE CATEGORIES

I. MAGNETIC COUPLING

Axial and Radial Field Intensity

All orientations of the magnetic field, in the axial and radial position along the measurement plane shall be ≥ -18 dB(A/m) at 1 kHz in a 1/3 octave band filter per §8.3.1.

Frequency Response

The frequency response of the axial component of the magnetic field shall follow the response curve specified in EIA RS-504-1983, over the frequency range 300 Hz – 3000 Hz per §8.3.2.

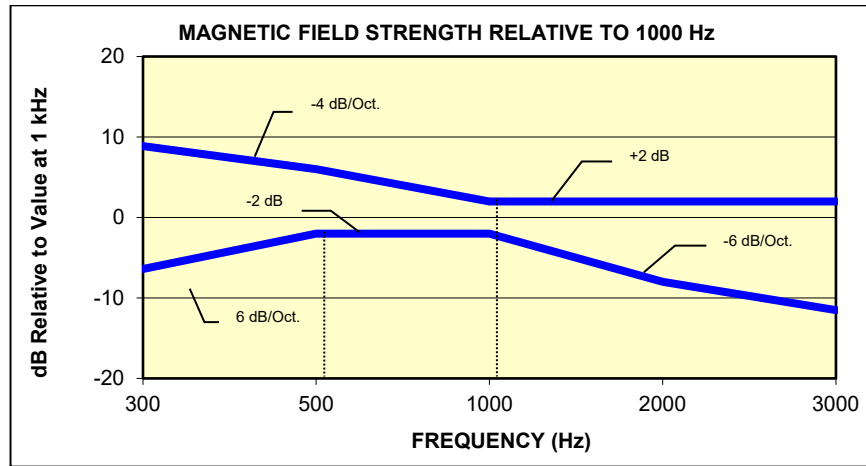

Figure 3-1
Magnetic field frequency response for Wireless Devices with an axial field ≤ -15 dB(A/m) at 1 kHz

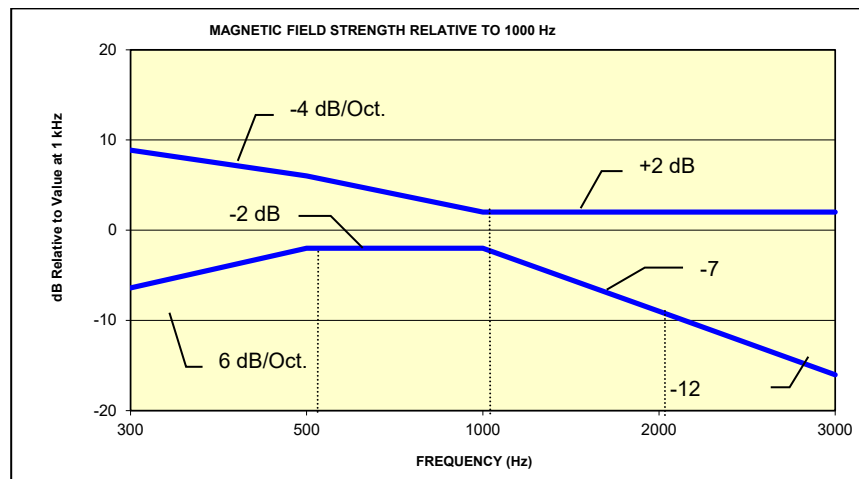



Figure 3-2
Magnetic Field frequency response for wireless devices with an axial field that exceeds -15 dB(A/m) at 1 kHz

FCC ID: PY7-57441Y		HAC (T-COIL) TEST REPORT		Approved by: Quality Manager
Filename: 1M2007070106-13-R3.PY7	Test Dates: 08/31/2020 - 09/22/2020	DUT Type: Portable Handset		Page 6 of 83

Signal Quality

The table below provides the signal quality requirement for the intended audio magnetic signal from a wireless device. Only the RF immunity of the hearing aid is measured in T-coil mode. It is assumed that a hearing aid can have no immunity to an interference signal in the audio band, which is the intended reception band for this mode. The only criterion that can be measured is the RF immunity in T-coil mode. This is measured using the same procedure as the audio coupling mode at the same levels.

The signal quality of the axial and radial components of the magnetic field was used to determine the T-coil mode category.

Category	Telephone RF Parameters
	Wireless Device Signal Quality [(Signal + Noise)-to-noise ratio in dB]
T1	0 to 10 dB
T2	10 to 20 dB
T3	20 to 30 dB
T4	> 30 dB

Table 3-1
Magnetic Coupling Parameters

Note: The FCC limit for SNNR is 20dB and the test data margins will indicate a margin from the FCC limit for compliance.

FCC ID: PY7-57441Y	 PCTEST Proud to be part of	HAC (T-COIL) TEST REPORT	SONY	Approved by: Quality Manager
Filename: 1M2007070106-13-R3.PY7	Test Dates: 08/31/2020 - 09/22/2020	DUT Type: Portable Handset		Page 7 of 83

4. METHOD OF MEASUREMENT

I. Test Setup

The equipment was connected as shown in an acoustic/RF hemi-anechoic chamber:

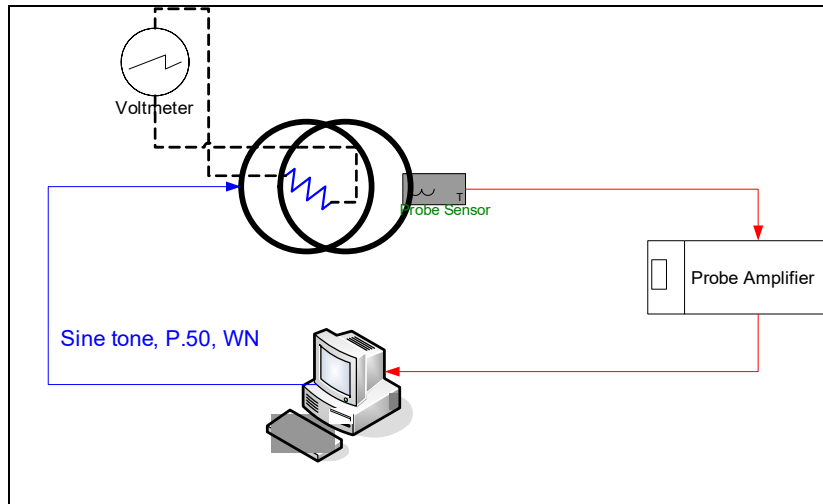

**Figure 4-1
Validation Setup with Helmholtz Coil**

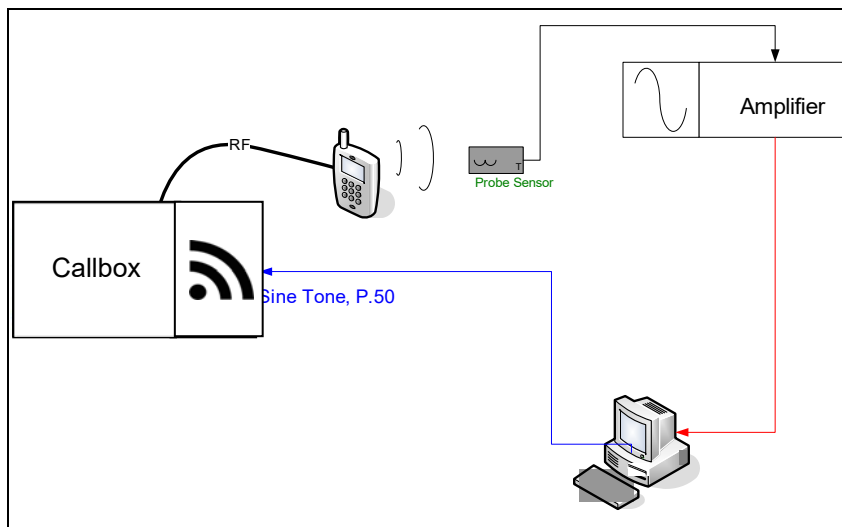

**Figure 4-2
T-Coil Test Setup**

FCC ID: PY7-57441Y	 <small>Head to be part of</small>	HAC (T-COIL) TEST REPORT	SONY	Approved by: Quality Manager
Filename: 1M2007070106-13-R3.PY7	Test Dates: 08/31/2020 - 09/22/2020	DUT Type: Portable Handset		Page 8 of 83

II. Scanning Mechanism

Manufacturer:	TEM
Accuracy:	± 0.83 cm/meter
Minimum Step Size:	0.1 mm
Maximum speed	6.1 cm/sec
Line Voltage:	115 VAC
Line Frequency:	60 Hz
Material Composite:	Delrin (Acetal)
Data Control:	Parallel Port
Dynamic Range (X-Y-Z):	45 x 31.75 x 47 cm
Dimensions:	36" x 25" x 38"
Operating Area:	36" x 49" x 55"
Reflections:	< -20 dB (in anechoic chamber)

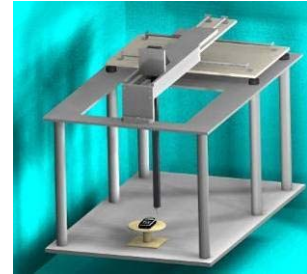

Figure 4-3
RF Near-Field Scanner

III. ITU-T P.50 Artificial Voice

Manufacturer:	ITU-T
Active Frequency Range:	100 Hz – 8 kHz
Stimulus Type:	Male and Female, no spaces
Single Sample Duration:	20.96 seconds
Activity Level:	100%

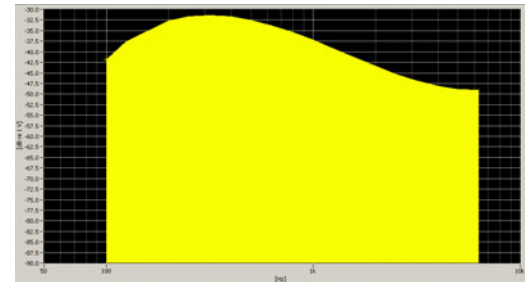

Figure 4-4
Spectral Characteristic of full P.50

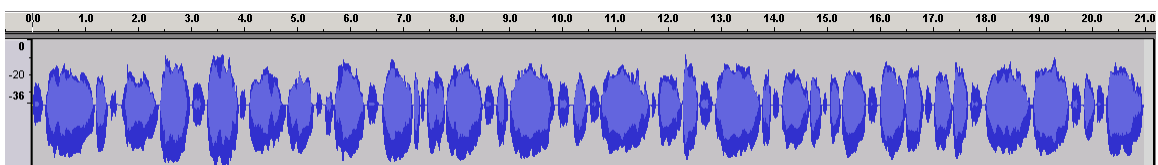

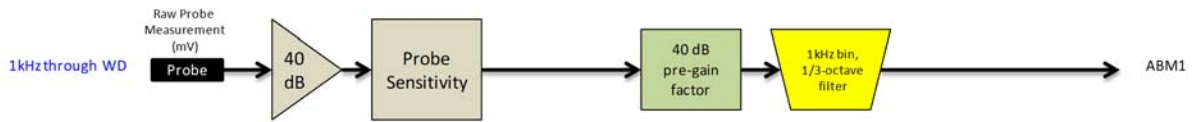

Figure 4-5
Temporal Characteristic of full P.50

FCC ID: PY7-57441Y	 PCTEST Proud to be part of	HAC (T-COIL) TEST REPORT	SONY	Approved by: Quality Manager
Filename: 1M2007070106-13-R3.PY7	Test Dates: 08/31/2020 - 09/22/2020	DUT Type: Portable Handset		Page 9 of 83

ABM1 Measurement Block Diagram:



ABM2 Measurement Block Diagram:

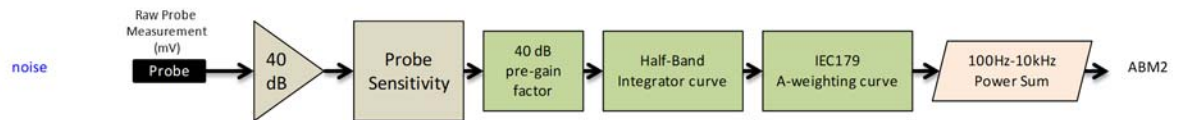

Figure 4-6 Magnetic Measurement Processing Steps

IV. Test Procedure

1. Ambient Noise Check per C63.19 §7.3.1
 - a. Ambient interference was monitored using a Real-Time Analyzer between 100-10,000 Hz with 1/3 octave filtering.
 - b. “A-weighting” and Half-Band Integration was applied to the measurements.
 - c. Since this measurement was measured in the same method as ABM2 measurements, this level was verified to be more than 10 dB below the lowest measurement signal (which is the highest ABM2 measurement for a T4 WD). Therefore the maximum noise level for a T4 WD with an ABM1 = -18 dBA/m is:

$$-18 - 30 - 10 = -58 \text{ dBA/m}$$
2. Measurement System Validation (See Figure 4-1)
 - a. The measurement system including the probe, pre-amplifier and acquisition system were validated as an entire system to ensure the reliability of test measurements.
 - b. ABM1 Validation
 The magnetic field at the center of the Helmholtz coil is given by the equation (per C63.19 Annex D.10.1):

$$H_c = \frac{NI}{r\sqrt{1.25^3}} = \frac{N\left(\frac{V}{R}\right)}{r\sqrt{1.25^3}}$$

Where H_c = magnetic field strength in amperes per meter

N = number of turns per coil

For the Helmholtz Coil, $N=20$; $r=0.13\text{m}$; $R=10.193\Omega$ and using $V=29\text{mV}$:

$$H_c = \frac{20 \cdot \left(\frac{0.029}{10.193}\right)}{0.13 \cdot \sqrt{1.25^3}} = 0.316 \text{ A/m} \approx -10 \text{ dB(A/m)}$$

For the Helmholtz Coil, $N=20$; $r=0.08\text{m}$; $R=10.2\Omega$ and using $V=18\text{mV}$:

$$H_c = \frac{20 \cdot \left(\frac{0.018}{10.2}\right)}{0.08 \cdot \sqrt{1.25^3}} = 0.316 \text{ A/m} \approx -10 \text{ dB(A/m)}$$

FCC ID: PY7-57441Y		HAC (T-COIL) TEST REPORT	SONY	Approved by: Quality Manager
Filename: 1M2007070106-13-R3.PY7	Test Dates: 08/31/2020 - 09/22/2020	DUT Type: Portable Handset		Page 10 of 83

Therefore, a pure tone of 1kHz was applied into the coils such that 29mV (S/N: SBI 1052) and 18mV (S/N: 925) was observed across the resistor. The voltmeter used for measurement was verified to be capable of measurements in the audio band range. This theoretically generates an expected field of -10 dB(A/m) in the center of the Helmholtz coil which was used to validate the probe measurement at -10dB(A/m). This was verified to be within ± 0.5 dB of the -10dB(A/m) value (see Pages 38 to 39).

c. Frequency Response Validation

The frequency response through the Helmholtz Coil was verified to be within 0.5 dB relative to 1kHz, between 300 – 3000 Hz using the P.50 signal as shown below:

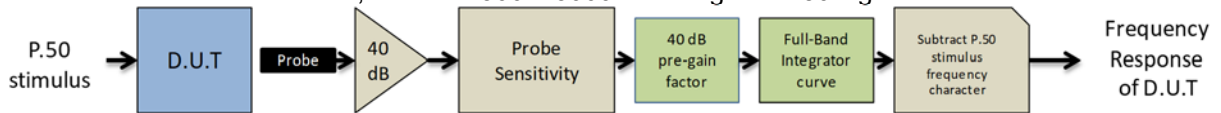

Figure 4-7 Frequency Response Validation

d. ABM2 Measurement Validation

WD noise measurements are filtered with A-weighting and Half-Band Integration over a frequency range of 100Hz – 10kHz to process ABM2 measurements. Below is the verification of the system processing A-weighting and Half-Band integration between system input to output within 0.5 dB of the theoretical result:

**Table 4-1
ABM2 Frequency Response Validation**

f (Hz)	HBI, A - Measured (dB re 1kHz)	HBI, A - Theoretical (dB re 1kHz)	dB Var.
100	-16.180	-16.170	-0.010
125	-13.257	-13.250	-0.007
160	-10.347	-10.340	-0.007
200	-8.017	-8.010	-0.007
250	-5.925	-5.920	-0.005
315	-4.045	-4.040	-0.005
400	-2.405	-2.400	-0.005
500	-1.212	-1.210	-0.002
630	-0.349	-0.350	0.001
800	0.071	0.070	0.001
1000	0.000	0.000	0.000
1250	-0.503	-0.500	-0.003
1600	-1.513	-1.510	-0.003
2000	-2.778	-2.780	0.002
2500	-4.316	-4.320	0.004
3150	-6.166	-6.170	0.004
4000	-8.322	-8.330	0.008
5000	-10.573	-10.590	0.017
6300	-13.178	-13.200	0.022
8000	-16.241	-16.270	0.029
10000	-19.495	-19.520	0.025

FCC ID: PY7-57441Y	PCTEST Proud to be part of	HAC (T-COIL) TEST REPORT	SONY	Approved by: Quality Manager
Filename: 1M2007070106-13-R3.PY7	Test Dates: 08/31/2020 - 09/22/2020	DUT Type: Portable Handset		Page 11 of 83

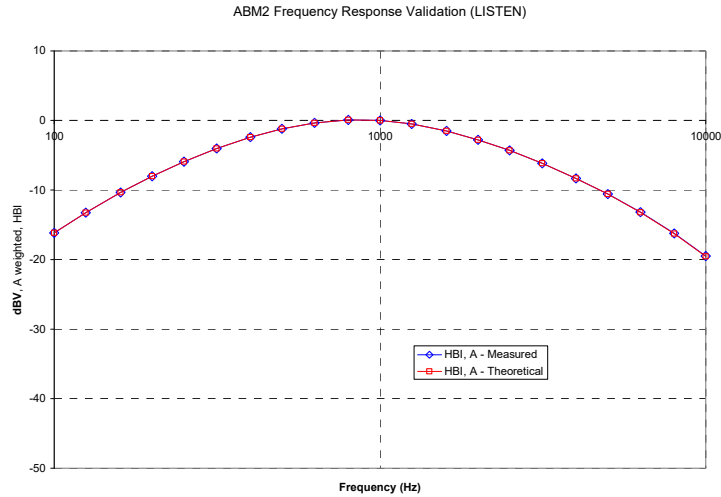

Figure 4-8
ABM2 Frequency Response Validation

The ABM2 result is a power sum from 100Hz to 10kHz with half-band integration and A-weighting. To verify the power sum measurement, a power sum over the full band was measured and verified to track with the source level (See Figure 4-9). Therefore the setup in this step was used to verify the power sum post-processing for ABM2 measurements. See below block diagram:

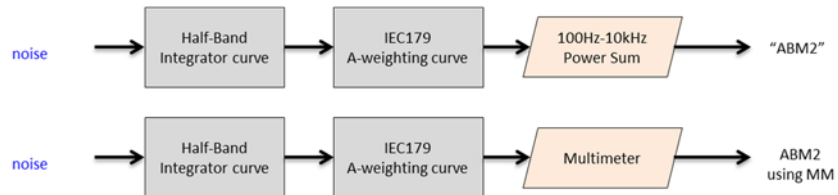

Figure 4-9
ABM2 Validation Block Diagram

The power summed output results for a known input were compared to the multi-meter results to verify any deviation in the post-processing implemented with the power-sum.

Table 4-2
ABM2 Power Sum Validation

WN Input (dBV)	Power Sum (dBV)	Multimeter-Full (dBV)	Dev (dB)
-60	-60.36	-60.2	0.16
-50	-50.19	-50.13	0.06
-40	-40.14	-40.03	0.11
-30	-30.13	-30.01	0.12
-20	-20.12	-20	0.12
-10	-10.14	-10	0.14

FCC ID: PY7-57441Y	PCTEST Road to be part of	HAC (T-COIL) TEST REPORT	SONY	Approved by: Quality Manager
Filename: 1M2007070106-13-R3.PY7	Test Dates: 08/31/2020 - 09/22/2020	DUT Type: Portable Handset		Page 12 of 83

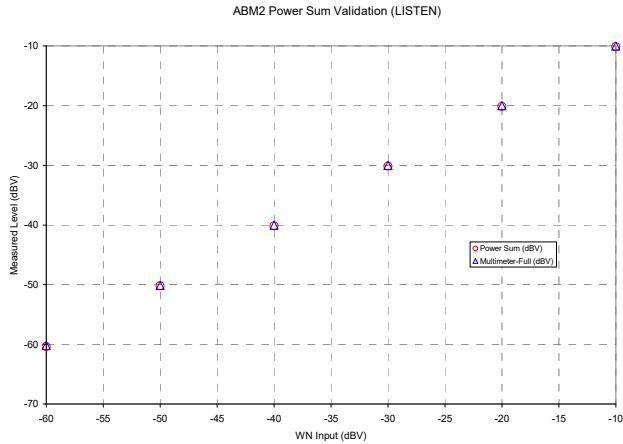

Figure 4-10
ABM2 Power Sum Validation

3. Measurement Test Setup

a. Fine scan above the WD (TEM)

- i. A multitone signal was applied to the handset such that the phone acoustic output was stable within 1dB over the probe settling time and with the acoustic output level at the C63.19 specified levels (below). The measurement step size was in 2 mm increments at a distance of 10 mm between the surface of the wireless device as shown below (note that in Figure 4-12, the grid is not to scale but merely a graphical representation of the coordinate system in use):

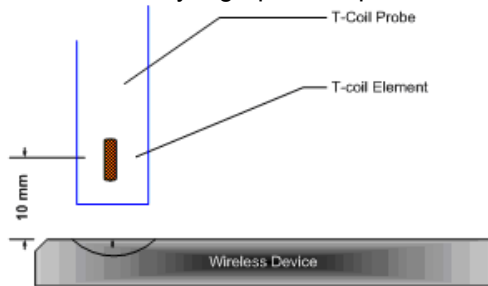

Figure 4-11
Measurement Distance

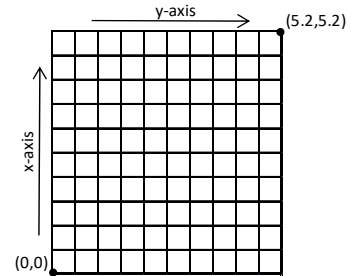





Figure 4-12
Measurement Grid

- ii. After scanning, the planar field maximum point was determined. The position of the probe was moved to this location to setup the test using the SoundCheck system.
 - iii. These steps were repeated for all T-coil orientations (axial and radial) per Figure 4-14 after a T-coil orientation was fully measured with the SoundCheck system.
- b. Speech Signal Setup to Base Station Simulator
- i. C63.19 Table 7-1 states audio reference input levels for various technologies:

Standard	Technology	Input Level (dBm0)
J-STD-007	GSM (217)	-16
T1/T1P1/3GPP	UMTS (WCDMA)	-16
iDEN™	TDMA (22 and 11 Hz)	-18

FCC ID: PY7-57441Y		HAC (T-COIL) TEST REPORT		Approved by: Quality Manager
Filename: 1M2007070106-13-R3.PY7	Test Dates: 08/31/2020 - 09/22/2020	DUT Type: Portable Handset		Page 13 of 83

- ii. See Section 5 for more information regarding CMW500 audio level settings for Voice Over LTE (VoLTE).
 - iii. See Section 6 for more information regarding audio level settings for Over-The-Top (OTT) Voice Over IP (VoIP) Testing.
 - c. Real-Time Analyzer (RTA)
 - i. The Real-Time Analyzer was configured to analyze measurements using 1/3 Octave band weighted filtering.
 - d. WD Radio Configuration Selection
 - i. The device was chosen to be tested in the worst-case ABM2 condition (See Section 7 for more information regarding worst-case configurations for UMTS. LTE configuration information can be found in Section 5 and 6. NR configuration information can be found in Section 6. WIFI configuration information can be found in Section 6.)
 - ii. Supported GSM vocoders were investigated for the worst-case ABM2 condition. GSM-EFR was deemed the worst-case condition for the GSM air interface.
- 4. Signal Quality Data Analysis
 - a. Narrow-band Magnetic Intensity
 - i. The standard specifies a 1kHz 1/3 octave band minimum field intensity for a sine tone. The ABM1 measurements were evaluated at 1kHz with 1/3 octave band filtering over an averaged period of 10 seconds.
 - b. Frequency Response
 - i. The appropriate frequency response curve was measured to curves in Figure 3-1 or Figure 3-2 between 300 – 3000 Hz using digital linear averaging (limit lines chosen according to measurement found in step 4a). A linear average over 3x the length of the artificial voice signal (3x sampling) was performed. A 10 second delay was configured in the measurement process of the stimulus to ensure handset vocoder latency effects and echo cancellation devices (if any) were appropriately stabilized during measurements.
 - ii. The appropriate post-processing was applied according to the system processing chain illustrated in Figure 4-7. All R10 frequencies were plotted with respect to 0dB at 1kHz value and aligned with respect to the EIA-504 mask.
 - iii. The margin is represented by the closest measured data point on the curve to the EIA-504 limit lines, in dB.
 - c. Signal Quality Index
 - i. Ensuring the WD was at maximum RF power, maximum volume, backlight off, display on, maximum contrast setting, keypad lights on (when possible) with no audio signal through the vocoder, the WD was measured over at least 100 Hz – 10,000 Hz, maximized over 5 seconds with a 50ms sample time for the ABM2 measurement (5 second time period is used in noise measurements under standards such as IEEE 269, etc.).
 - ii. After applying half-band integration and A-weighting to the result, a power sum was applied over each 1/3 octave bandwidth frequency for an ABM2 value.
 - iii. This result was subtracted from the ABM1 result in step a, to obtain the Signal Quality.

FCC ID: PY7-57441Y		HAC (T-COIL) TEST REPORT	SONY	Approved by: Quality Manager
Filename: 1M2007070106-13-R3.PY7	Test Dates: 08/31/2020 - 09/22/2020	DUT Type: Portable Handset	Page 14 of 83	

V. Test Setup

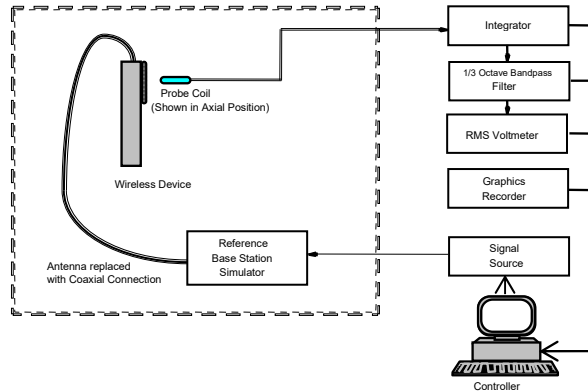

Figure 4-13
Audio Magnetic Field Test Setup



Environmental conditions such as temperature and relative humidity are monitored to ensure there are no impacts on system specifications. Proper voltage and power line frequency conditions are maintained with three phase power sources. Environmental noise and reflections are monitored through system checks.

VI. Deviation from C63.19 Test Procedure

None.

VII. Air Interface Technologies Tested

All air interfaces which support voice capabilities over a managed CMRS or pre-installed OTT VoIP applications were tested for T-coil unless otherwise noted. See Table 2-1 for more details regarding which modes were tested.

FCC ID: PY7-57441Y		HAC (T-COIL) TEST REPORT		Approved by: Quality Manager
Filename: 1M2007070106-13-R3.PY7	Test Dates: 08/31/2020 - 09/22/2020	DUT Type: Portable Handset		Page 15 of 83

VIII. Wireless Device Channels and Frequencies

1. 2G/3G Modes

The frequencies listed in the table below are those that lie in the center of the bands used for cellular telephony. Low, middle and high channels were tested in each band for FCC compliance evaluation to ensure the maximum emission is captured across the entire band. Only middle channels were evaluated for data modes.

**Table 4-3
Center Channels and Frequencies**

Test frequencies & associated channels	
Channel	Frequency (MHz)
Cellular 850	
190 (GSM)	836.60
4183 (UMTS)	836.60
AWS 1750	
1412 (UMTS)	1730.40
PCS 1900	
661 (GSM)	1880
9400 (UMTS)	1880

2. 4G (LTE) Modes

The middle channel for every band and bandwidth combination was tested for each probe orientation. The band and bandwidth combination from each probe orientation resulting in the worst-case SNNR was additionally tested using low and high channels for that band and bandwidth combination. The middle channel and supported bandwidths from the worst-case bands according to Tables 6-5 and 6-6 was additionally evaluated with OTT VoIP for each probe orientation. See Tables 8-4 to 8-13 and 8-16 to 8-17 for LTE bandwidths and channels.

3. 5G (NR) Modes

The middle channel and supported bandwidths from the worst-case NR FDD band according to Table 6-9 was evaluated with OTT VoIP for each probe orientation. The band and bandwidth combination from each probe orientation resulting in the worst-case SNNR was additionally tested using low and high channels for that band and bandwidth combination. See Table 8-18 for NR bandwidths and channels.

4. WIFI

The middle channel for each IEEE 802.11 standard was tested for each probe orientation. The 2.4GHz IEEE 802.11 standard from each probe orientation resulting in the worst-case SNNR was additionally tested using low and high channels. The 5GHz IEEE 802.11 standard from each probe orientation resulting in the worst-case SNNR was additionally tested on higher U-NII bands as well as applicable low and high channels. See Tables 8-20 to 8-24 for WIFI standards and channels.

FCC ID: PY7-57441Y	 PCTEST Proud to be part of	HAC (T-COIL) TEST REPORT	SONY	Approved by: Quality Manager
Filename: 1M2007070106-13-R3.PY7	Test Dates: 08/31/2020 - 09/22/2020	DUT Type: Portable Handset		Page 16 of 83

IX. Test Flow

The flow diagram below was followed (From C63.19):

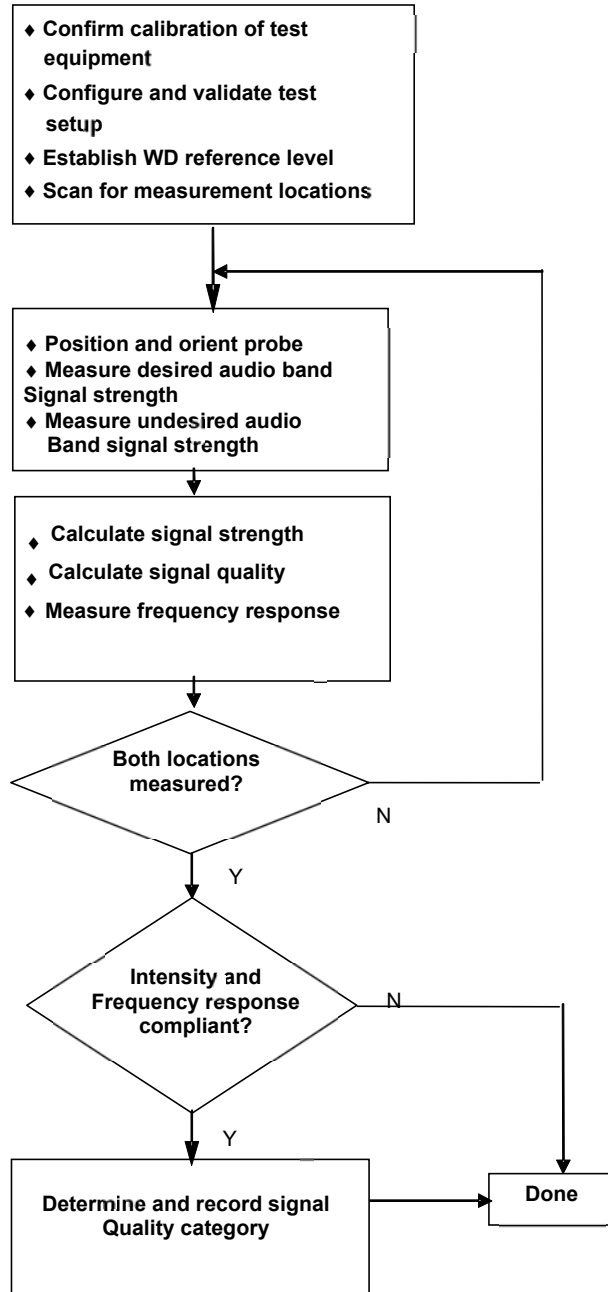



Figure 4-14
C63.19 T-Coil Signal Test Process

FCC ID: PY7-57441Y		HAC (T-COIL) TEST REPORT	SONY	Approved by: Quality Manager
Filename: 1M2007070106-13-R3.PY7	Test Dates: 08/31/2020 - 09/22/2020	DUT Type: Portable Handset		Page 17 of 83

© 2020 PCTEST

REV 3.5.M
8/18/2020

© 2020 PCTEST All rights reserved. Unless otherwise specified, no part of this report may be reproduced or utilized in any part, form or by any means, electronic or mechanical, including photocopying and microfilm, without permission in writing from PCTEST. If you have any questions about this international copyright or have an enquiry about obtaining additional rights to this report or assembly of contents thereof, please contact INFO@PCTEST.COM.

5. VOLTE TEST SYSTEM SETUP AND DUT CONFIGURATION

I. Test System Setup for VoLTE over IMS T-coil Testing

1. Equipment Setup

The general test setup used for VoLTE over IMS is shown below. The callbox used when performing VoLTE over IMS T-coil measurements is a CMW500. The Data Application Unit (DAU) of the CMW500 was used to simulate the IP Multimedia Subsystem (IMS) server.

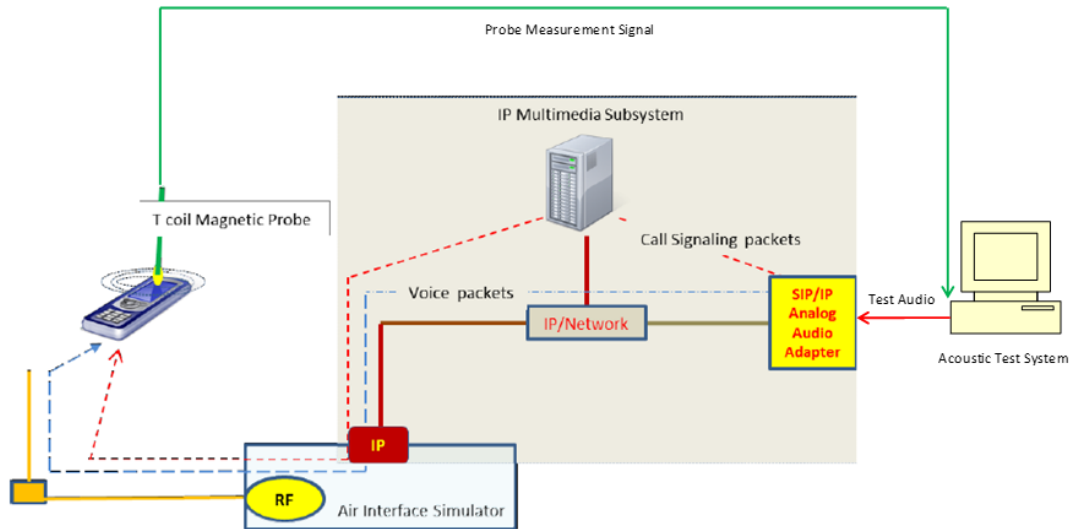



Figure 5-1
Test Setup for VoLTE over IMS T-Coil Measurements

2. Audio Level Settings

According to the July 2012 interpretations by the C63 Committee regarding the appropriate audio levels to be used for VoLTE over IMS T-coil testing, -16dBm0 shall be used for the normal speech input level*. The CMW500 base station simulator was manually configured to ensure that the settings for speech input and full scale levels resulted in the -16dBm0 speech input level to the DUT for the VoLTE over IMS connection.

* http://c63.org/documents/misc/posting/new_interpretations.htm

FCC ID: PY7-57441Y		HAC (T-COIL) TEST REPORT		Approved by: Quality Manager
Filename: 1M2007070106-13-R3.PY7	Test Dates: 08/31/2020 - 09/22/2020	DUT Type: Portable Handset		Page 18 of 83

II. DUT Configuration for VoLTE over IMS T-coil Testing

1. Radio Configuration

An investigation was performed to determine the modulation and RB configuration to be used for testing. The effects of modulation and RB configuration were found to be independent of band and bandwidth; therefore, only one band and bandwidth were used for this investigation. 16QAM, 1RB, 99% RB offset was used for the testing as the worst-case configuration for the handset. See below table for SNNR comparison between different radio configurations:

**Table 5-1
VoLTE over IMS SNNR by Radio Configuration**

Band	Frequency [MHz]	Channel	Bandwidth [MHz]	Modulation	RB Size	RB Offset	ABM1 [dB(A/m)]	ABM2 [dB(A/m)]	SNNR [dB]
66	1745.0	132322	20	QPSK	1	0	7.50	-48.92	56.42
66	1745.0	132322	20	QPSK	1	50	7.55	-48.19	55.74
66	1745.0	132322	20	QPSK	1	99	7.49	-47.80	55.29
66	1745.0	132322	20	QPSK	50	0	7.71	-49.04	56.75
66	1745.0	132322	20	QPSK	50	25	7.67	-48.67	56.34
66	1745.0	132322	20	QPSK	50	50	7.15	-48.39	55.54
66	1745.0	132322	20	QPSK	100	0	7.45	-47.93	55.38
66	1745.0	132322	20	16QAM	1	0	7.82	-46.93	54.75
66	1745.0	132322	20	16QAM	1	50	7.68	-46.33	54.01
66	1745.0	132322	20	16QAM	1	99	7.68	-45.57	53.25
66	1745.0	132322	20	16QAM	50	0	7.79	-49.00	56.79
66	1745.0	132322	20	16QAM	50	25	7.58	-49.23	56.81
66	1745.0	132322	20	16QAM	50	50	7.53	-48.23	55.76
66	1745.0	132322	20	16QAM	100	0	7.49	-47.95	55.44
66	1745.0	132322	20	64QAM	1	0	7.61	-46.45	54.06
66	1745.0	132322	20	64QAM	1	50	7.72	-46.06	53.78
66	1745.0	132322	20	64QAM	1	99	7.67	-46.01	53.68
66	1745.0	132322	20	64QAM	50	0	7.32	-49.10	56.42
66	1745.0	132322	20	64QAM	50	25	7.26	-49.31	56.57
66	1745.0	132322	20	64QAM	50	50	7.74	-48.27	56.01
66	1745.0	132322	20	64QAM	100	0	7.65	-47.89	55.54

2. Codec Configuration

An investigation was performed to determine the audio codec configuration to be used for testing. The effects of codec configuration were found to be independent of radio configuration; therefore, only one radio configuration was used for this investigation. The WB AMR 6.60kbps setting was used for the audio codec on the CMW500 for VoLTE over IMS T-coil testing. See below table for comparisons between different codecs and codec data rates:

**Table 5-2
AMR Codec Investigation – VoLTE over IMS**

Codec Setting:	WB AMR 23.85kbps	WB AMR 6.60kbps	NB AMR 12.2kbps	NB AMR 4.75kbps	Orientation	Band / BW	Channel
ABM1 (dBA/m)	8.37	7.52	11.84	11.92	Axial	Band 66 20MHz	132322
ABM2 (dBA/m)	-46.83	-47.14	-47.40	-46.57			
Frequency Response	Pass	Pass	Pass	Pass			
S+N/N (dB)	55.20	54.66	59.24	58.49			

- Mute on; Backlight off; Max Volume; Max Contrast
- TPC = "Max Power"

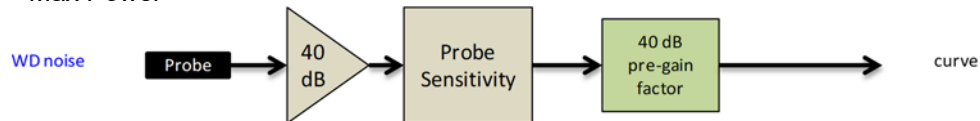

**Figure 5-2
Audio Band Magnetic Curve Measurement Block Diagram**

FCC ID: PY7-57441Y		HAC (T-COIL) TEST REPORT	SONY	Approved by: Quality Manager
Filename: 1M2007070106-13-R3.PY7	Test Dates: 08/31/2020 - 09/22/2020	DUT Type: Portable Handset		Page 19 of 83

3. LTE TDD Uplink-Downlink Configuration Investigation for VoLTE over IMS

An investigation was performed to determine the worst-case Uplink-Downlink configuration for VoLTE over IMS T-Coil testing.

Per 3GPP TS 36.211, the total frame length for each TDD radio frame of length $T_f = 307200 \cdot T_s = 10$ ms, where T_s is a number of time units equal to $1/(15000 \times 2048)$ seconds. Additionally, each radio frame consists of 10 subframes, each of length $30720 \cdot T_s = 1$ ms, and subframes can be designated as uplink (U), downlink (D), or special subframe (S), depending on the Uplink-Downlink configuration as indicated in Table 4.2-2 of 3GPP TS 36.211. In the transmission duty factor calculation, the special subframe configuration with the shortest UpPTS duration within the special subframe is used and will be applied for measurement. From 3GPP TS 36.211 Table 4.2-1, the shortest UpPTS is $2192 \cdot T_s$ which occurs in the normal cyclic prefix and special subframe configuration 4.

See table below outlining the calculated transmission duty cycles for each Uplink-Downlink configuration:

Table 5-3
Uplink-Downlink Configurations for Type 2 Frame Structures

Uplink-downlink configuration	Downlink-to-Uplink Switch-point periodicity	Subframe number										Calculated Transmission Duty Cycle (%)
		0	1	2	3	4	5	6	7	8	9	
0	5 ms	D	S	U	U	U	D	S	U	U	U	61.4%
1	5 ms	D	S	U	U	D	D	S	U	U	D	41.4%
2	5 ms	D	S	U	D	D	D	S	U	D	D	21.4%
3	10 ms	D	S	U	U	U	D	D	D	D	D	30.7%
4	10 ms	D	S	U	U	D	D	D	D	D	D	20.7%
5	10 ms	D	S	U	D	D	D	D	D	D	D	10.7%
6	5 ms	D	S	U	U	U	D	S	U	U	D	51.4%

a. Power Class 3 Uplink-Downlink Configuration Investigation



Power Class 3 was evaluated with the following radio configuration: channel 40620, 20MHz BW, 16QAM, 1RB, 99RB Offset. For Power Class 3, all configurations (0-6) are supported. The configuration which resulted in the worst SNNR was used for full testing. Uplink-Downlink configuration 2 was used as the worst-case configuration for Power Class 3 VoLTE over IMS T-Coil testing. See table below for the SNNR comparison between each Uplink-Downlink configuration:

Table 5-4
Power Class 3 VoLTE over IMS SNNR by UL-DL Configuration

Frequency [MHz]	Channel	Bandwidth [MHz]	Modulation	RB Size	RB Offset	UL-DL Configuration	ABM1 [dB(A/m)]	ABM2 [dB(A/m)]	SNNR [dB]
2593.0	40620	20	16QAM	1	99	0	7.77	-38.54	46.31
2593.0	40620	20	16QAM	1	99	1	7.90	-38.20	46.10
2593.0	40620	20	16QAM	1	99	2	7.67	-37.78	45.45
2593.0	40620	20	16QAM	1	99	3	7.67	-41.32	48.99
2593.0	40620	20	16QAM	1	99	4	7.61	-41.01	48.62
2593.0	40620	20	16QAM	1	99	5	8.09	-40.43	48.52
2593.0	40620	20	16QAM	1	99	6	7.75	-38.55	46.30

b. Conclusion

Per the investigations above, UL-DL Configuration 2 was used to evaluate Power Class 3 VoLTE over IMS.

FCC ID: PY7-57441Y		HAC (T-COIL) TEST REPORT		Approved by: Quality Manager
Filename: 1M2007070106-13-R3.PY7	Test Dates: 08/31/2020 - 09/22/2020	DUT Type: Portable Handset		Page 20 of 83

6. OTT VOIP TEST SYSTEM AND DUT CONFIGURATION

I. Test System Setup for OTT VoIP T-Coil Testing

1. OTT VoIP Application

Google Duo is a pre-installed application on the DUT which allows for VoIP calls in a held-to-ear scenario. Duo uses the OPUS audio codec and supports a bitrate range of 6kb/s to 75kb/s. All air interfaces capable of a data connection were evaluated with Google Duo.

2. Equipment Setup

A CMW500 callbox was used to perform OTT VoIP T-coil measurements. The Data Application Unit (DAU) of the CMW500 was connected to the internet and allowed for an IP data connection on the DUT. An auxiliary VoIP unit was used to initiate an OTT VoIP call to the DUT. The auxiliary VoIP unit allowed for the configuration and monitoring of the OTT VoIP codec bitrate during a call. Both high and low bitrate settings were evaluated in to determine the worst-case configuration.

3. Audio Level Settings

According to KDB 285076 D02, the average speech level of -20dBm0 shall be used for protocols not specifically listed in Table 7.1 of ANSI C63.19-2011 or the ANSI C63.19-2011 VoLTE interpretation². The auxiliary VoIP unit allowed for monitoring the signal input level to ensure that the settings for speech input and full scale levels resulted in the -20dBm0 speech input level to the DUT for the OTT VoIP call.

Note: The green highlighted text is approved by FCC under the TCB PAG Re-Use Policy 388624 D01 IV. D. for T-Coil Testing for WI-FI calling and Google Duo.

II. DUT Configuration for OTT VoIP T-Coil Testing



1. Codec Configuration

An investigation was performed for each applicable data mode to determine the audio codec configuration to be used for testing. The effects of codec configuration were found to be independent of radio configuration; therefore, only one radio configuration for each applicable data mode was used for these investigations. The 75kbps codec setting was used for the audio codec on the auxiliary VoIP unit for OTT VoIP T-Coil testing. See below tables for comparisons between codec data rates on all applicable data modes:

**Table 6-1
Codec Investigation – OTT VoIP (EDGE)**

Codec Setting:	75kbps	6kbps	Orientation	Channel
ABM1 (dBA/m)	25.15	25.58	Axial	190
ABM2 (dBA/m)	-34.26	-34.14		
Frequency Response	Pass	Pass		
S+N/N (dB)	59.41	59.72		

² FCC Office of Engineering and Technology KDB, "285076 D02 T-Coil Testing for CMRS IP v03," September 13, 2017

FCC ID: PY7-57441Y		HAC (T-COIL) TEST REPORT		Approved by: Quality Manager
Filename: 1M2007070106-13-R3.PY7	Test Dates: 08/31/2020 - 09/22/2020	DUT Type: Portable Handset		Page 21 of 83

**Table 6-2
Codec Investigation – OTT VoIP (HSPA)**

Codec Setting:	75kbps	6kbps	Orientation	Channel
ABM1 (dBA/m)	25.00	25.42	Axial	4183
ABM2 (dBA/m)	-48.90	-48.93		
Frequency Response	Pass	Pass		
S+N/N (dB)	73.90	74.35		

**Table 6-3
Codec Investigation – OTT VoIP (LTE)**

Codec Setting:	75kbps	6kbps	Orientation	Band / BW	Channel
ABM1 (dBA/m)	25.54	25.42	Axial	Band 12 10MHz	23095
ABM2 (dBA/m)	-44.05	-48.11			
Frequency Response	Pass	Pass			
S+N/N (dB)	69.59	73.53			



**Table 6-4
Codec Investigation – OTT VoIP (WIFI)**

Codec Setting:	75kbps	6kbps	Orientation	Band	Standard	Channel
ABM1 (dBA/m)	25.03	25.55	Axial	2.4GHz	IEEE 802.11b	6
ABM2 (dBA/m)	-40.22	-41.68				
Frequency Response	Pass	Pass				
S+N/N (dB)	65.25	67.23				

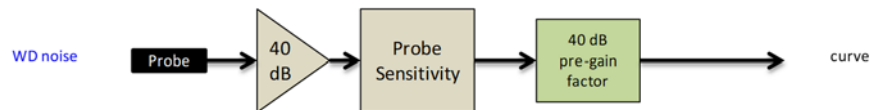
- Mute on; Backlight off; Max Volume; Max Contrast
- Radio Configurations can be found in Section 8.II.F



**Figure 6-1
Audio Band Magnetic Curve Measurement Block Diagram**

FCC ID: PY7-57441Y		HAC (T-COIL) TEST REPORT		Approved by: Quality Manager
Filename: 1M2007070106-13-R3.PY7	Test Dates: 08/31/2020 - 09/22/2020	DUT Type: Portable Handset		Page 22 of 83

2. Radio Configuration for OTT VoIP (LTE)

An investigation was performed to determine the worst-case LTE FDD band to be used for OTT VoIP testing. LTE FDD Band 5 was used for the testing as the worst-case configuration for the handset. See below table for SNNR comparison between different LTE FDD bands:

Table 6-5
OTT VoIP (LTE FDD) SNNR by LTE Band

Band	Frequency [MHz]	Channel	Bandwidth [MHz]	Modulation	RB Size	RB Offset	ABM1 [dB(A/m)]	ABM2 [dB(A/m)]	SNNR [dB]
12	707.5	23095	10	16QAM	1	49	25.14	-44.09	69.23
13	782.0	23230	10	16QAM	1	49	25.45	-45.93	71.38
26	831.5	26865	15	16QAM	1	74	25.36	-44.15	69.51
5	836.5	20525	10	16QAM	1	49	24.76	-44.45	69.21
66	1745.0	132322	20	16QAM	1	99	25.49	-45.84	71.33
2	1880.0	18900	20	16QAM	1	99	25.44	-46.81	72.25
25	1882.5	26365	20	16QAM	1	99	25.27	-47.56	72.83
7	2535.0	21100	20	16QAM	1	99	24.50	-46.89	71.39

An investigation was performed to determine the worst-case LTE TDD band to be used for OTT VoIP testing. LTE TDD Band 48 was used for the testing as the worst-case configuration for the handset. See below table for SNNR comparison between different LTE TDD bands:

Table 6-6
OTT VoIP (LTE TDD) SNNR by LTE Band

Band	Frequency [MHz]	Channel	Bandwidth [MHz]	Modulation	RB Size	RB Offset	ABM1 [dB(A/m)]	ABM2 [dB(A/m)]	SNNR [dB]
41 (PC3)	2593.0	40620	20	16QAM	1	99	25.59	-37.97	63.56
48	3625.0	55990	20	16QAM	1	99	25.40	-33.75	59.15

3. Interim Procedure for evaluation OTT VoIP (NR)

The following procedure is used to evaluate OTT VoIP (NR) given equipment limitations.

- a. This procedure is applicable for OTT VoIP (NR) voice calls that use the same protocol, codec(s), and reference level as OTT VoIP (LTE) (i.e. -20dBm0).
- b. Establish the ABM1_{NR} value by using the ABM1_{LTE} magnetic intensity for an LTE call using a correlating LTE band through existing procedures and test equipment.
- c. Establish an ABM2_{NR} value using factory test mode (FTM) to simulate a NR connection for the desired NR band and channel under test.
- d. The following information is documented in Section 9:
 - i. ABM2_{LTE} and ABM2_{NR} for respective tests.
 - ii. Calculate SNNR:
 1. $ABM1 = ABM1_{LTE}$
 2. $ABM2 = ABM2_{NR}$
 3. $SNNR_{NR} = [ABM1_{LTE} - ABM2_{NR}] - 3dB$
 - a. A 3dB margin is built in to ensure conservative results with this interim procedure.

The above is only applicable for OTT VoIP scenarios, this device does not support VoNR over IMS.

The manufacturer has confirmed the handset as designed is expected to exhibit similar audio intensity levels between an OTT VoIP call placed over a 4G LTE and a 5G Sub-6GHz data connection.

FCC ID: PY7-57441Y		HAC (T-COIL) TEST REPORT	SONY	Approved by: Quality Manager
Filename: 1M2007070106-13-R3.PY7	Test Dates: 08/31/2020 - 09/22/2020	DUT Type: Portable Handset		Page 23 of 83

4. Radio Configuration for OTT VoIP (NR)

An investigation was performed to determine the waveform, modulation, and RB configuration to be used for testing. Due to equipment limitations, the procedure outlined in 6.11.3 was used to evaluate the SNNR for each radio configuration below. CP-OFDM 16QAM, 1RB, 1RB offset was determined to be the worst-case configuration for the handset and will be used for full testing in Section 8.

**Table 6-7
NR OTT VoIP SNNR by Radio Configuration (CP-OFDM)**

Band	Frequency [MHz]	Channel	Bandwidth [MHz]	Waveform	Modulation	RB Size	RB Offset	ABM _{1LTE} [dB(A/m)]	ABM _{2NR} [dB(A/m)]	SNNR _{NR} [dB]
n5	836.5	167300	20	CP-OFDM	QPSK	1	1	24.76	-49.00	73.76
n5	836.5	167300	20	CP-OFDM	QPSK	1	53	24.76	-48.87	73.63
n5	836.5	167300	20	CP-OFDM	QPSK	1	104	24.76	-48.60	73.36
n5	836.5	167300	20	CP-OFDM	QPSK	53	0	24.76	-49.49	74.25
n5	836.5	167300	20	CP-OFDM	QPSK	53	26	24.76	-49.53	74.29
n5	836.5	167300	20	CP-OFDM	QPSK	53	53	24.76	-49.66	74.42
n5	836.5	167300	20	CP-OFDM	QPSK	106	0	24.76	-49.42	74.18
n5	836.5	167300	20	CP-OFDM	16QAM	1	1	24.76	-46.93	71.69
n5	836.5	167300	20	CP-OFDM	16QAM	1	53	24.76	-47.20	71.96
n5	836.5	167300	20	CP-OFDM	16QAM	1	104	24.76	-47.06	71.82
n5	836.5	167300	20	CP-OFDM	16QAM	53	0	24.76	-49.54	74.30
n5	836.5	167300	20	CP-OFDM	16QAM	53	26	24.76	-49.56	74.32
n5	836.5	167300	20	CP-OFDM	16QAM	53	53	24.76	-49.72	74.48
n5	836.5	167300	20	CP-OFDM	16QAM	106	0	24.76	-49.47	74.23
n5	836.5	167300	20	CP-OFDM	64QAM	1	1	24.76	-48.61	73.37
n5	836.5	167300	20	CP-OFDM	64QAM	1	53	24.76	-48.99	73.75
n5	836.5	167300	20	CP-OFDM	64QAM	1	104	24.76	-48.65	73.41
n5	836.5	167300	20	CP-OFDM	64QAM	53	0	24.76	-49.90	74.66
n5	836.5	167300	20	CP-OFDM	64QAM	53	26	24.76	-49.58	74.34
n5	836.5	167300	20	CP-OFDM	64QAM	53	53	24.76	-49.87	74.63
n5	836.5	167300	20	CP-OFDM	64QAM	106	0	24.76	-49.12	73.88

**Table 6-8
NR OTT VoIP SNNR by Radio Configuration (DFT-s-OFDM)**

Band	Frequency [MHz]	Channel	Bandwidth [MHz]	Waveform	Modulation	RB Size	RB Offset	ABM _{1LTE} [dB(A/m)]	ABM _{2NR} [dB(A/m)]	SNNR _{NR} [dB]
n5	836.5	167300	20	DFT-s-OFDM	$\pi/2$ -BPSK	1	1	24.76	-49.25	74.01
n5	836.5	167300	20	DFT-s-OFDM	$\pi/2$ -BPSK	1	53	24.76	-49.26	74.02
n5	836.5	167300	20	DFT-s-OFDM	$\pi/2$ -BPSK	1	104	24.76	-49.22	73.98
n5	836.5	167300	20	DFT-s-OFDM	$\pi/2$ -BPSK	50	0	24.76	-49.40	74.16
n5	836.5	167300	20	DFT-s-OFDM	$\pi/2$ -BPSK	50	28	24.76	-49.50	74.26
n5	836.5	167300	20	DFT-s-OFDM	$\pi/2$ -BPSK	50	56	24.76	-49.40	74.16
n5	836.5	167300	20	DFT-s-OFDM	$\pi/2$ -BPSK	100	0	24.76	-49.49	74.25
n5	836.5	167300	20	DFT-s-OFDM	QPSK	1	1	24.76	-49.36	74.12
n5	836.5	167300	20	DFT-s-OFDM	QPSK	1	53	24.76	-49.20	73.96
n5	836.5	167300	20	DFT-s-OFDM	QPSK	1	104	24.76	-49.05	73.81
n5	836.5	167300	20	DFT-s-OFDM	QPSK	50	0	24.76	-49.47	74.23
n5	836.5	167300	20	DFT-s-OFDM	QPSK	50	28	24.76	-49.55	74.31
n5	836.5	167300	20	DFT-s-OFDM	QPSK	50	56	24.76	-49.31	74.07
n5	836.5	167300	20	DFT-s-OFDM	QPSK	100	0	24.76	-49.89	74.65
n5	836.5	167300	20	DFT-s-OFDM	16QAM	1	1	24.76	-48.73	73.49
n5	836.5	167300	20	DFT-s-OFDM	16QAM	1	53	24.76	-48.38	73.14
n5	836.5	167300	20	DFT-s-OFDM	16QAM	1	104	24.76	-48.82	73.58
n5	836.5	167300	20	DFT-s-OFDM	16QAM	50	0	24.76	-49.26	74.02
n5	836.5	167300	20	DFT-s-OFDM	16QAM	50	28	24.76	-49.26	74.02
n5	836.5	167300	20	DFT-s-OFDM	16QAM	50	56	24.76	-49.12	73.88
n5	836.5	167300	20	DFT-s-OFDM	16QAM	100	0	24.76	-49.33	74.09
n5	836.5	167300	20	DFT-s-OFDM	64QAM	1	1	24.76	-48.62	73.38
n5	836.5	167300	20	DFT-s-OFDM	64QAM	1	53	24.76	-48.70	73.46
n5	836.5	167300	20	DFT-s-OFDM	64QAM	1	104	24.76	-48.56	73.32
n5	836.5	167300	20	DFT-s-OFDM	64QAM	50	0	24.76	-49.31	74.07
n5	836.5	167300	20	DFT-s-OFDM	64QAM	50	28	24.76	-49.15	73.91
n5	836.5	167300	20	DFT-s-OFDM	64QAM	50	56	24.76	-49.19	73.95
n5	836.5	167300	20	DFT-s-OFDM	64QAM	100	0	24.76	-49.04	73.80

FCC ID: PY7-57441Y		HAC (T-COIL) TEST REPORT	SONY	Approved by: Quality Manager
Filename: 1M2007070106-13-R3.PY7	Test Dates: 08/31/2020 - 09/22/2020	DUT Type: Portable Handset		Page 24 of 83

An investigation was performed to determine the worst-case NR FDD band to be used for OTT VoIP testing. NR n5 was used for the testing as the worst-case configuration for the handset. See below table for SNNR comparison between different NR FDD bands:

Table 6-9
OTT VoIP (NR FDD) SNNR by Band

Band	Frequency [MHz]	Channel	Bandwidth [MHz]	Waveform	Modulation	RB Size	RB Offset	ABM1 _{LTE} [dB(A/m)]	ABM2 _{NR} [dB(A/m)]	SNNR _{NR} [dB]
n5	836.5	167300	20	CP-OFDM	16QAM	1	1	24.76	-46.82	71.58
n66	1745.0	349000	20	CP-OFDM	16QAM	1	1	25.49	-48.28	73.77
n2	1880.0	376000	20	CP-OFDM	16QAM	1	1	25.44	-47.34	72.78

5. Radio Configuration for OTT VoIP (WIFI)

An investigation was performed on all applicable data rates and modulations to determine the radio configuration to be used for testing. See tables below for SNNR comparison between radio configurations in each IEEE 802.11 standard:

Table 6-10
IEEE 802.11b SNNR by Radio Configuration

Mode	Channel	Modulation	Data Rate [Mbps]	ABM1 [dB(A/m)]	ABM2 [dB(A/m)]	SNNR [dB]
IEEE 802.11b	6	DSSS	1	25.45	-40.40	65.85
IEEE 802.11b	6	DSSS	2	25.42	-40.16	65.58
IEEE 802.11b	6	CCK	5.5	25.68	-42.17	67.85
IEEE 802.11b	6	CCK	11	25.45	-42.29	67.74

Table 6-11
IEEE 802.11g/a SNNR by Radio Configuration

Mode	Channel	Modulation	Data Rate [Mbps]	ABM1 [dB(A/m)]	ABM2 [dB(A/m)]	SNNR [dB]
IEEE 802.11g	6	BPSK	6	25.62	-42.99	68.61
IEEE 802.11g	6	BPSK	9	25.45	-43.08	68.53
IEEE 802.11g	6	QPSK	12	25.20	-43.57	68.77
IEEE 802.11g	6	QPSK	18	25.48	-43.32	68.80
IEEE 802.11g	6	16QAM	24	25.36	-43.81	69.17
IEEE 802.11g	6	16QAM	36	25.50	-44.02	69.52
IEEE 802.11g	6	64QAM	48	25.43	-43.45	68.88
IEEE 802.11g	6	64QAM	54	25.59	-43.79	69.38

FCC ID: PY7-57441Y		HAC (T-COIL) TEST REPORT	SONY	Approved by: Quality Manager
Filename: 1M2007070106-13-R3.PY7	Test Dates: 08/31/2020 - 09/22/2020	DUT Type: Portable Handset		Page 25 of 83

Table 6-12
IEEE 802.11n/ac 20MHz BW SNNR by Radio Configuration

Mode	Bandwidth [MHz]	Channel	Modulation	MCS Index	ABM1 [dB(A/m)]	ABM2 [dB(A/m)]	SNNR [dB]
IEEE 802.11n	20	40	BPSK	0	25.49	-42.46	67.95
IEEE 802.11n	20	40	QPSK	1	25.48	-43.37	68.85
IEEE 802.11n	20	40	QPSK	2	25.76	-44.20	69.96
IEEE 802.11n	20	40	16QAM	3	25.27	-43.79	69.06
IEEE 802.11n	20	40	16QAM	4	25.53	-45.23	70.76
IEEE 802.11n	20	40	64QAM	5	25.55	-44.54	70.09
IEEE 802.11n	20	40	64QAM	6	25.48	-44.49	69.97
IEEE 802.11n	20	40	64QAM	7	25.23	-43.92	69.15
IEEE 802.11ac	20	40	256QAM	8	25.40	-44.51	69.91

Table 6-13
IEEE 802.11ax SU 20MHz BW SNNR by Radio Configuration

Mode	Bandwidth [MHz]	Channel	Modulation	MCS Index	ABM1 [dB(A/m)]	ABM2 [dB(A/m)]	SNNR [dB]
IEEE 802.11ax SU	20	40	BPSK	0	25.25	-35.33	60.58
IEEE 802.11ax SU	20	40	QPSK	1	25.32	-35.50	60.82
IEEE 802.11ax SU	20	40	QPSK	2	25.37	-35.60	60.97
IEEE 802.11ax SU	20	40	16QAM	3	25.39	-35.51	60.90
IEEE 802.11ax SU	20	40	16QAM	4	25.25	-36.04	61.29
IEEE 802.11ax SU	20	40	64QAM	5	25.24	-35.41	60.65
IEEE 802.11ax SU	20	40	64QAM	6	25.19	-35.71	60.90
IEEE 802.11ax SU	20	40	64QAM	7	25.24	-35.83	61.07
IEEE 802.11ax SU	20	40	256QAM	8	25.28	-35.58	60.86
IEEE 802.11ax SU	20	40	256QAM	9	25.22	-35.81	61.03
IEEE 802.11ax SU	20	40	1024QAM	10	25.31	-35.91	61.22
IEEE 802.11ax SU	20	40	1024QAM	11	25.13	-35.70	60.83

Table 6-14
IEEE 802.11ax RU 20MHz BW SNNR by Radio Configuration

Mode	Bandwidth [MHz]	Channel	Modulation	MCS Index	RU Index	ABM1 [dB(A/m)]	ABM2 [dB(A/m)]	SNNR [dB]
IEEE 802.11ax RU	20	40	BPSK	0	0	25.23	-35.91	61.14
IEEE 802.11ax RU	20	40	BPSK	0	8	25.29	-35.94	61.23
IEEE 802.11ax RU	20	40	BPSK	0	37	25.27	-35.80	61.07
IEEE 802.11ax RU	20	40	BPSK	0	40	25.23	-35.60	60.83
IEEE 802.11ax RU	20	40	BPSK	0	53	25.26	-35.91	61.17
IEEE 802.11ax RU	20	40	BPSK	0	54	25.17	-35.80	60.97
IEEE 802.11ax RU	20	40	BPSK	0	61	25.30	-35.66	60.96

FCC ID: PY7-57441Y	 PCTEST <small>Head to be part of</small>	HAC (T-COIL) TEST REPORT	SONY	Approved by: Quality Manager
Filename: 1M2007070106-13-R3.PY7	Test Dates: 08/31/2020 - 09/22/2020	DUT Type: Portable Handset		Page 26 of 83

Table 6-15
IEEE 802.11n/ac 40MHz BW SNNR by Radio Configuration

Mode	Bandwidth [MHz]	Channel	Modulation	MCS Index	ABM1 [dB(A/m)]	ABM2 [dB(A/m)]	SNNR [dB]
IEEE 802.11n	40	38	BPSK	0	25.39	-43.75	69.14
IEEE 802.11n	40	38	QPSK	1	25.24	-43.45	68.69
IEEE 802.11n	40	38	QPSK	2	25.30	-44.00	69.30
IEEE 802.11n	40	38	16QAM	3	25.30	-44.97	70.27
IEEE 802.11n	40	38	16QAM	4	25.46	-43.96	69.42
IEEE 802.11n	40	38	64QAM	5	25.38	-43.99	69.37
IEEE 802.11n	40	38	64QAM	6	25.37	-44.24	69.61
IEEE 802.11n	40	38	64QAM	7	25.29	-44.13	69.42
IEEE 802.11ac	40	38	256QAM	8	25.23	-44.56	69.79
IEEE 802.11ac	40	38	256QAM	9	25.30	-44.62	69.92

Table 6-16
IEEE 802.11ax SU 40MHz BW SNNR by Radio Configuration

Mode	Bandwidth [MHz]	Channel	Modulation	MCS Index	ABM1 [dB(A/m)]	ABM2 [dB(A/m)]	SNNR [dB]
IEEE 802.11ax SU	40	38	BPSK	0	25.11	-35.29	60.40
IEEE 802.11ax SU	40	38	QPSK	1	25.15	-35.59	60.74
IEEE 802.11ax SU	40	38	QPSK	2	25.16	-35.81	60.97
IEEE 802.11ax SU	40	38	16QAM	3	25.13	-35.65	60.78
IEEE 802.11ax SU	40	38	16QAM	4	25.14	-35.43	60.57
IEEE 802.11ax SU	40	38	64QAM	5	25.15	-35.58	60.73
IEEE 802.11ax SU	40	38	64QAM	6	25.13	-35.97	61.10
IEEE 802.11ax SU	40	38	64QAM	7	25.22	-35.74	60.96
IEEE 802.11ax SU	40	38	256QAM	8	25.15	-35.82	60.97
IEEE 802.11ax SU	40	38	256QAM	9	25.09	-35.74	60.83
IEEE 802.11ax SU	40	38	1024QAM	10	25.24	-353.84	379.08
IEEE 802.11ax SU	40	38	1024QAM	11	25.19	-35.88	61.07

Table 6-17
IEEE 802.11ax RU 40MHz BW SNNR by Radio Configuration

Mode	Bandwidth [MHz]	Channel	Modulation	MCS Index	RU Index	ABM1 [dB(A/m)]	ABM2 [dB(A/m)]	SNNR [dB]
IEEE 802.11ax RU	40	38	BPSK	0	0	25.17	-35.68	60.85
IEEE 802.11ax RU	40	38	BPSK	0	17	25.22	-35.79	61.01
IEEE 802.11ax RU	40	38	BPSK	0	37	25.28	-35.48	60.76
IEEE 802.11ax RU	40	38	BPSK	0	44	25.20	-36.03	61.23
IEEE 802.11ax RU	40	38	BPSK	0	53	25.07	-35.83	60.90
IEEE 802.11ax RU	40	38	BPSK	0	56	25.18	-35.66	60.84
IEEE 802.11ax RU	40	38	BPSK	0	61	25.14	-35.57	60.71
IEEE 802.11ax RU	40	38	BPSK	0	62	25.13	-35.61	60.74
IEEE 802.11ax RU	40	38	BPSK	0	65	25.17	-35.61	60.78

FCC ID: PY7-57441Y		HAC (T-COIL) TEST REPORT	SONY	Approved by: Quality Manager
Filename: 1M2007070106-13-R3.PY7	Test Dates: 08/31/2020 - 09/22/2020	DUT Type: Portable Handset		Page 27 of 83

7. FCC 3G MEASUREMENTS

I. UMTS Test Configurations

AMR at 12.2kbps, 13.6kbps SRB (thick, purple data curve) was used for the testing as the worst-case configuration for the handset. See below plot for ABM noise comparison between vocoder rates:

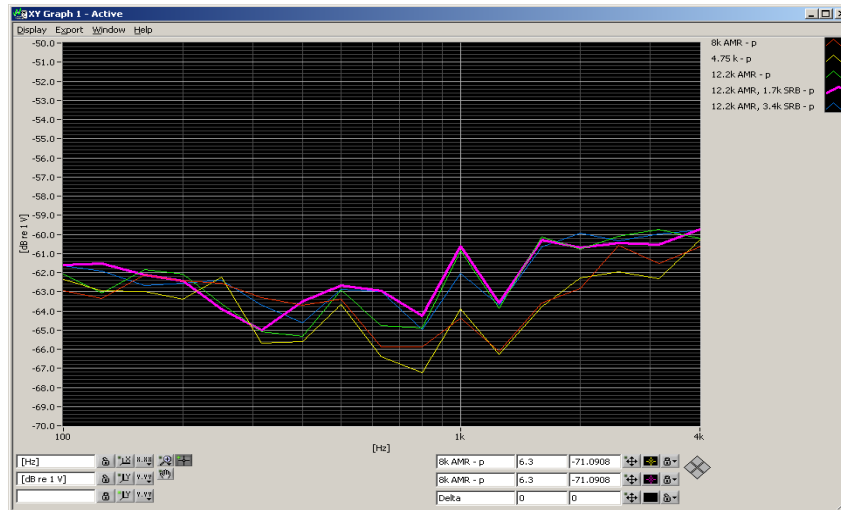

Figure 7-1
UMTS Audio Band Magnetic Noise

Table 7-1
Codec Investigation - UMTS

Codec Setting:	AMR 12.2kbps	AMR 7.95kbps	AMR 4.75kbps	Orientation	Channel
ABM1 (dBA/m)	11.80	11.66	11.65	Axial	4183
ABM2 (dBA/m)	-46.04	-47.07	-46.45		
Frequency Response	Pass	Pass	Pass		
S+N/N (dB)	57.84	58.73	58.10		

- Mute on; Backlight off; Max Volume; Max Contrast
- TPC="All 1s"

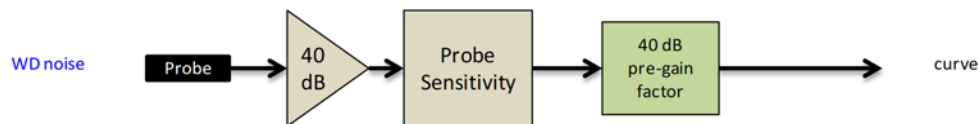



Figure 7-2
Audio Band Magnetic Curve Measurement Block Diagram

FCC ID: PY7-57441Y	PCTEST Proud to be part of	HAC (T-COIL) TEST REPORT	SONY	Approved by: Quality Manager
Filename: 1M2007070106-13-R3.PY7	Test Dates: 08/31/2020 - 09/22/2020	DUT Type: Portable Handset		Page 28 of 83

8. T-COIL TEST SUMMARY

**Table 8-1
Consolidated Tabled Results**

		Freq. Response Margin		Magnetic Intensity Verdict		FCC SNNR Verdict		Margin from FCC Limit (dB)	C63.19-2011 Rating
		8.3.2		8.3.1		8.3.4			
		Axial	Radial	Axial	Radial	Axial	Radial		
GSM	Cellular	PASS	NA	PASS	PASS	PASS	PASS	-23.02	T4
	PCS	PASS	NA	PASS	PASS	PASS	PASS		
EDGE (OTT VoIP)	Cellular	PASS	NA	PASS	PASS	PASS	PASS	-39.48	T4
	PCS	PASS	NA	PASS	PASS	PASS	PASS		
UMTS	Cellular	PASS	NA	PASS	PASS	PASS	PASS	-33.41	T4
	AWS	PASS	NA	PASS	PASS	PASS	PASS		
	PCS	PASS	NA	PASS	PASS	PASS	PASS		
HSPA (OTT VoIP)	Cellular	PASS	NA	PASS	PASS	PASS	PASS	-48.08	T4
	AWS	PASS	NA	PASS	PASS	PASS	PASS		
	PCS	PASS	NA	PASS	PASS	PASS	PASS		
LTE FDD	B12	PASS	NA	PASS	PASS	PASS	PASS	-24.36	T4
	B13	PASS	NA	PASS	PASS	PASS	PASS		
	B26	PASS	NA	PASS	PASS	PASS	PASS		
	B5	PASS	NA	PASS	PASS	PASS	PASS		
	B66	PASS	NA	PASS	PASS	PASS	PASS		
	B2	PASS	NA	PASS	PASS	PASS	PASS		
	B25	PASS	NA	PASS	PASS	PASS	PASS		
LTE FDD (OTT VoIP)	B5	PASS	NA	PASS	PASS	PASS	PASS	-42.27	T4
LTE TDD	B41 (PC3)	PASS	NA	PASS	PASS	PASS	PASS	-18.16	T4
	B48	PASS	NA	PASS	PASS	PASS	PASS		
LTE TDD (OTT VoIP)	B48	PASS	NA	PASS	PASS	PASS	PASS	-36.00	T4
NR FDD (OTT VoIP)	n5	NA	NA	PASS	PASS	PASS	PASS	-42.37	T4
WLAN (OTT VoIP)	IEEE 802.11b	PASS	NA	PASS	PASS	PASS	PASS	-34.36	T4
	IEEE 802.11g	PASS	NA	PASS	PASS	PASS	PASS		
	IEEE 802.11n	PASS	NA	PASS	PASS	PASS	PASS		
	IEEE 802.11ax SU	PASS	NA	PASS	PASS	PASS	PASS		
	IEEE 802.11ax RU	PASS	NA	PASS	PASS	PASS	PASS		
U-NII (OTT VoIP)	IEEE 802.11a	PASS	NA	PASS	PASS	PASS	PASS	-32.23	T4
	IEEE 802.11n	PASS	NA	PASS	PASS	PASS	PASS		
	IEEE 802.11ac	PASS	NA	PASS	PASS	PASS	PASS		
	IEEE 802.11ax SU	PASS	NA	PASS	PASS	PASS	PASS		
	IEEE 802.11ax RU	PASS	NA	PASS	PASS	PASS	PASS		

FCC ID: PY7-57441Y		HAC (T-COIL) TEST REPORT	SONY	Approved by: Quality Manager
Filename: 1M2007070106-13-R3.PY7	Test Dates: 08/31/2020 - 09/22/2020	DUT Type: Portable Handset		Page 29 of 83

I. Raw Handset Data

Table 8-2
Raw Data Results for GSM

Mode	Orientation	Channel	Sample S/N	ABM1 [dB(A/m)]	ABM2 [dB(A/m)]	Ambient Noise [dB(A/m)]	Frequency Response Margin (dB)	S+N/N (dB)	FCC Limit (dB)	Margin from FCC Limit (dB)	C63.19-2011 Rating	Test Coordinates
GSM850	Axial	128	82710	12.12	-32.19	-64.19	0.79	44.31	20.00	-24.31	T4	1.8, 2.6
		190	82710	12.34	-32.03		0.81	44.37	20.00	-24.37	T4	
		251	82710	12.34	-31.30		0.82	43.64	20.00	-23.64	T4	
	Radial	128	82710	5.53	-38.15	-59.91	N/A	43.68	20.00	-23.68	T4	2.0, 3.6
		190	82710	4.93	-38.55			43.48	20.00	-23.48	T4	
		251	82710	4.94	-38.08			43.02	20.00	-23.02	T4	
GSM1900	Axial	512	82710	12.17	-35.69	-64.19	0.78	47.86	20.00	-27.86	T4	1.8, 2.6
		661	82710	12.08	-35.60		0.82	47.68	20.00	-27.68	T4	
		810	82710	12.19	-35.80		0.77	47.99	20.00	-27.99	T4	
	Radial	512	82710	4.93	-40.51	-59.91	N/A	45.44	20.00	-25.44	T4	2.0, 3.6
		661	82710	4.83	-40.73			45.56	20.00	-25.56	T4	
		810	82710	4.97	-40.95			45.92	20.00	-25.92	T4	

Table 8-3
Raw Data Results for UMTS

Mode	Orientation	Channel	Sample S/N	ABM1 [dB(A/m)]	ABM2 [dB(A/m)]	Ambient Noise [dB(A/m)]	Frequency Response Margin (dB)	S+N/N (dB)	FCC Limit (dB)	Margin from FCC Limit (dB)	C63.19-2011 Rating	Test Coordinates
UMTS V	Axial	4132	82710	11.10	-47.19	-59.23	0.84	58.29	20.00	-38.29	T4	1.8, 2.6
		4183	82710	11.28	-47.51		0.52	58.79	20.00	-38.79	T4	
		4233	82710	11.93	-47.63		0.64	59.56	20.00	-39.56	T4	
	Radial	4132	82710	4.55	-50.76	-59.91	N/A	55.31	20.00	-35.31	T4	2.0, 3.6
		4183	82710	4.67	-50.45			55.12	20.00	-35.12	T4	
		4233	82710	4.39	-51.02			55.41	20.00	-35.41	T4	
UMTS IV	Axial	1312	82710	11.28	-47.72	-59.23	0.50	59.00	20.00	-39.00	T4	1.8, 2.6
		1412	82710	11.83	-47.92		0.79	59.75	20.00	-39.75	T4	
		1513	82710	11.87	-48.36		0.37	60.23	20.00	-40.23	T4	
	Radial	1312	82710	4.87	-52.21	-59.91	N/A	57.08	20.00	-37.08	T4	2.0, 3.6
		1412	82710	4.35	-49.73			54.08	20.00	-34.08	T4	
		1513	82710	4.36	-50.16			54.52	20.00	-34.52	T4	
UMTS II	Axial	9262	82710	11.95	-49.39	-59.23	0.45	61.34	20.00	-41.34	T4	1.8, 2.6
		9400	82710	11.77	-49.41		0.80	61.18	20.00	-41.18	T4	
		9538	82710	11.47	-48.42		0.68	59.89	20.00	-39.89	T4	
	Radial	9262	82710	4.81	-51.07	-59.91	N/A	55.88	20.00	-35.88	T4	2.0, 3.6
		9400	82710	4.54	-50.04			54.58	20.00	-34.58	T4	
		9538	82710	4.37	-49.04			53.41	20.00	-33.41	T4	

Table 8-4
Raw Data Results for LTE B12

Mode	Orientation	Bandwidth	Channel	Sample S/N	ABM1 [dB(A/m)]	ABM2 [dB(A/m)]	Ambient Noise [dB(A/m)]	Frequency Response Margin (dB)	S+N/N (dB)	FCC Limit (dB)	Margin from FCC Limit (dB)	C63.19-2011 Rating	Test Coordinates
LTE Band 12	Axial	10MHz	23095	82710	7.49	-44.37	-59.23	1.49	51.86	20.00	-31.86	T4	1.8, 2.6
		5MHz	23095	82710	7.62	-44.01		1.33	51.63	20.00	-31.63	T4	
		3MHz	23095	82710	7.23	-44.37		1.41	51.60	20.00	-31.60	T4	
		1.4MHz	23095	82710	7.61	-45.32		1.51	52.93	20.00	-32.93	T4	
	Radial	10MHz	23095	82710	-0.29	-45.77	-63.68	N/A	45.48	20.00	-25.48	T4	2.0, 3.6
		5MHz	23095	82710	-0.28	-45.51			45.23	20.00	-25.23	T4	
		3MHz	23095	82710	-0.10	-46.26			46.16	20.00	-26.16	T4	
		1.4MHz	23095	82710	-0.41	-47.14			46.73	20.00	-26.73	T4	

FCC ID: PY7-57441Y		HAC (T-COIL) TEST REPORT	SONY	Approved by: Quality Manager
Filename: 1M2007070106-13-R3.PY7	Test Dates: 08/31/2020 - 09/22/2020	DUT Type: Portable Handset		Page 30 of 83

Table 8-5
Raw Data Results for LTE B13

Mode	Orientation	Bandwidth	Channel	Sample S/N	ABM1 [dB(A/m)]	ABM2 [dB(A/m)]	Ambient Noise [dB(A/m)]	Frequency Response Margin (dB)	S+N/N (dB)	FCC Limit (dB)	Margin from FCC Limit (dB)	C63.19-2011 Rating	Test Coordinates
LTE Band 13	Axial	10MHz	23230	82710	7.75	-45.62	-59.23	1.45	53.37	20.00	-33.37	T4	1.8, 2.6
		5MHz	23230	82710	7.51	-44.16		1.31	51.67	20.00	-31.67	T4	
	Radial	10MHz	23230	82710	-0.12	-47.63	-63.68	N/A	47.51	20.00	-27.51	T4	2.0, 3.6
		5MHz	23230	82710	0.03	-45.01		45.04	20.00	-25.04	T4		

Table 8-6
Raw Data Results for LTE B26

Mode	Orientation	Bandwidth	Channel	Sample S/N	ABM1 [dB(A/m)]	ABM2 [dB(A/m)]	Ambient Noise [dB(A/m)]	Frequency Response Margin (dB)	S+N/N (dB)	FCC Limit (dB)	Margin from FCC Limit (dB)	C63.19-2011 Rating	Test Coordinates
LTE Band 26	Axial	15MHz	26865	82710	7.54	-44.04	-59.23	1.43	51.58	20.00	-31.58	T4	1.8, 2.6
		10MHz	26865	82710	7.75	-44.14		1.39	51.89	20.00	-31.89	T4	
		5MHz	26865	82710	7.95	-44.78		1.22	52.73	20.00	-32.73	T4	
		3MHz	26865	82710	7.28	-43.95		1.32	51.23	20.00	-31.23	T4	
		1.4MHz	26865	82710	7.71	-46.81		1.32	54.52	20.00	-34.52	T4	
	Radial	15MHz	26865	82710	-0.32	-45.96	-63.68	N/A	45.64	20.00	-25.64	T4	2.0, 3.6
		10MHz	26865	82710	-0.24	-45.51		45.27	20.00	-25.27	T4		
		5MHz	26865	82710	-0.23	-45.76		45.53	20.00	-25.53	T4		
		3MHz	26865	82710	-0.38	-45.59		45.21	20.00	-25.21	T4		
		1.4MHz	26865	82710	-0.09	-47.42		47.33	20.00	-27.33	T4		

Table 8-7
Raw Data Results for LTE B5

Mode	Orientation	Bandwidth	Channel	Sample S/N	ABM1 [dB(A/m)]	ABM2 [dB(A/m)]	Ambient Noise [dB(A/m)]	Frequency Response Margin (dB)	S+N/N (dB)	FCC Limit (dB)	Margin from FCC Limit (dB)	C63.19-2011 Rating	Test Coordinates
LTE Band 5	Axial	10MHz	20600	82710	7.56	-42.98	-59.23	1.26	50.54	20.00	-30.54	T4	1.8, 2.6
		10MHz	20525	82710	7.59	-43.58		1.47	51.17	20.00	-31.17	T4	
		10MHz	20450	82710	7.88	-45.10		1.34	52.98	20.00	-32.98	T4	
		5MHz	20525	82710	7.35	-44.98		1.51	52.33	20.00	-32.33	T4	
		3MHz	20525	82710	7.73	-44.58		1.49	52.31	20.00	-32.31	T4	
		1.4MHz	20525	82710	7.39	-46.65		1.47	54.04	20.00	-34.04	T4	
	Radial	10MHz	20600	82710	-0.41	-44.77	-63.68	N/A	44.36	20.00	-24.36	T4	2.0, 3.6
		10MHz	20525	82710	-0.43	-45.09		44.66	20.00	-24.66	T4		
		10MHz	20450	82710	-0.52	-45.24		44.72	20.00	-24.72	T4		
		5MHz	20525	82710	-0.19	-45.87		45.68	20.00	-25.68	T4		
		3MHz	20525	82710	-0.42	-47.51		47.09	20.00	-27.09	T4		
		1.4MHz	20525	82710	-0.43	-47.81		47.38	20.00	-27.38	T4		

Table 8-8
Raw Data Results for LTE B66

Mode	Orientation	Bandwidth	Channel	Sample S/N	ABM1 [dB(A/m)]	ABM2 [dB(A/m)]	Ambient Noise [dB(A/m)]	Frequency Response Margin (dB)	S+N/N (dB)	FCC Limit (dB)	Margin from FCC Limit (dB)	C63.19-2011 Rating	Test Coordinates
LTE Band 66	Axial	20MHz	132322	82710	7.68	-45.37	-59.23	1.46	53.05	20.00	-33.05	T4	1.8, 2.6
		15MHz	132322	82710	7.54	-44.45		1.29	51.99	20.00	-31.99	T4	
		10MHz	132322	82710	7.37	-44.25		1.50	51.62	20.00	-31.62	T4	
		5MHz	132322	82710	7.18	-45.37		1.38	52.55	20.00	-32.55	T4	
		3MHz	132322	82710	7.72	-45.17		1.36	52.89	20.00	-32.89	T4	
		1.4MHz	132322	82710	7.14	-46.70		1.35	53.84	20.00	-33.84	T4	
	Radial	20MHz	132322	82710	-0.43	-47.04	-63.68	N/A	46.61	20.00	-26.61	T4	2.0, 3.6
		15MHz	132322	82710	-0.49	-46.11		45.62	20.00	-25.62	T4		
		10MHz	132322	82710	-0.41	-46.30		45.89	20.00	-25.89	T4		
		5MHz	132322	82710	-0.15	-46.98		46.83	20.00	-26.83	T4		
		3MHz	132322	82710	-0.41	-46.54		46.13	20.00	-26.13	T4		
		1.4MHz	132322	82710	-0.04	-48.09		48.05	20.00	-28.05	T4		

FCC ID: PY7-57441Y		HAC (T-COIL) TEST REPORT	SONY	Approved by: Quality Manager
Filename: 1M2007070106-13-R3.PY7	Test Dates: 08/31/2020 - 09/22/2020	DUT Type: Portable Handset		Page 31 of 83

Table 8-9
Raw Data Results for LTE B25

Mode	Orientation	Bandwidth	Channel	Sample S/N	ABM1 [dB(A/m)]	ABM2 [dB(A/m)]	Ambient Noise [dB(A/m)]	Frequency Response Margin (dB)	S+N/N (dB)	FCC Limit (dB)	Margin from FCC Limit (dB)	C63.19-2011 Rating	Test Coordinates
LTE Band 25	Axial	20MHz	26365	82710	7.53	-46.40	-59.23	1.40	53.93	20.00	-33.93	T4	1.8, 2.6
		15MHz	26365	82710	7.82	-46.02		1.44	53.84	20.00	-33.84	T4	
		10MHz	26365	82710	7.85	-45.41		1.51	53.26	20.00	-33.26	T4	
		5MHz	26365	82710	7.81	-45.45		1.44	53.26	20.00	-33.26	T4	
		3MHz	26365	82710	7.83	-44.94		1.39	52.77	20.00	-32.77	T4	
		1.4MHz	26365	82710	7.98	-46.30		1.27	54.28	20.00	-34.28	T4	
	Radial	20MHz	26365	82710	-0.27	-47.43	-63.68	N/A	47.16	20.00	-27.16	T4	2.0, 3.6
		15MHz	26365	82710	-0.13	-47.03		46.90	20.00	-26.90	T4		
		10MHz	26365	82710	-0.10	-46.48		46.38	20.00	-26.38	T4		
		5MHz	26365	82710	-0.35	-46.28		45.93	20.00	-25.93	T4		
		3MHz	26365	82710	-0.01	-46.29		46.28	20.00	-26.28	T4		
		1.4MHz	26365	82710	-0.10	-46.78		46.68	20.00	-26.68	T4		

Table 8-10
Raw Data Results for LTE B2

Mode	Orientation	Bandwidth	Channel	Sample S/N	ABM1 [dB(A/m)]	ABM2 [dB(A/m)]	Ambient Noise [dB(A/m)]	Frequency Response Margin (dB)	S+N/N (dB)	FCC Limit (dB)	Margin from FCC Limit (dB)	C63.19-2011 Rating	Test Coordinates
LTE Band 2	Axial	20MHz	18900	82710	7.57	-46.11	-59.23	1.37	53.68	20.00	-33.68	T4	1.8, 2.6
		15MHz	18900	82710	7.43	-45.67		1.40	53.10	20.00	-33.10	T4	
		10MHz	18900	82710	7.57	-44.89		1.47	52.46	20.00	-32.46	T4	
		5MHz	18900	82710	7.72	-45.17		1.47	52.89	20.00	-32.89	T4	
		3MHz	18900	82710	7.55	-44.82		1.48	52.37	20.00	-32.37	T4	
		1.4MHz	18900	82710	7.73	-45.80		1.44	53.53	20.00	-33.53	T4	
	Radial	20MHz	18900	82710	-0.45	-47.57	-63.68	N/A	47.12	20.00	-27.12	T4	2.0, 3.6
		15MHz	18900	82710	-0.36	-46.73		46.37	20.00	-26.37	T4		
		10MHz	18900	82710	-0.29	-46.31		46.02	20.00	-26.02	T4		
		5MHz	18900	82710	-0.50	-46.57		46.07	20.00	-26.07	T4		
		3MHz	18900	82710	-0.17	-46.01		45.84	20.00	-25.84	T4		
		1.4MHz	18900	82710	0.10	-47.07		47.17	20.00	-27.17	T4		

Table 8-11
Raw Data Results for LTE B7

Mode	Orientation	Bandwidth	Channel	Sample S/N	ABM1 [dB(A/m)]	ABM2 [dB(A/m)]	Ambient Noise [dB(A/m)]	Frequency Response Margin (dB)	S+N/N (dB)	FCC Limit (dB)	Margin from FCC Limit (dB)	C63.19-2011 Rating	Test Coordinates
LTE Band 7	Axial	20MHz	21100	82710	7.76	-46.57	-59.23	1.40	54.33	20.00	-34.33	T4	1.8, 2.6
		15MHz	21100	82710	7.73	-45.58		1.55	53.31	20.00	-33.31	T4	
		10MHz	21100	82710	7.51	-45.36		1.41	52.87	20.00	-32.87	T4	
		5MHz	21100	82710	7.99	-45.87		1.32	53.86	20.00	-33.86	T4	
		3MHz	21100	82710	-0.46	-48.07		47.61	20.00	-27.61	T4		
	Radial	15MHz	21100	82710	-0.19	-47.42	-63.68	N/A	47.23	20.00	-27.23	T4	2.0, 3.6
		10MHz	21100	82710	-0.47	-46.81		46.34	20.00	-26.34	T4		
		5MHz	21100	82710	-0.28	-48.02		47.74	20.00	-27.74	T4		

Table 8-12
Raw Data Results for LTE B41 Power Class 3

Mode	Orientation	Bandwidth	Channel	Sample S/N	ABM1 [dB(A/m)]	ABM2 [dB(A/m)]	Ambient Noise [dB(A/m)]	Frequency Response Margin (dB)	S+N/N (dB)	FCC Limit (dB)	Margin from FCC Limit (dB)	C63.19-2011 Rating	Test Coordinates
LTE Band 41	Axial	20MHz	40620	82710	7.75	-37.82	-59.23	1.31	45.57	20.00	-25.57	T4	1.8, 2.6
		15MHz	40620	82710	8.12	-37.87		1.35	45.99	20.00	-25.99	T4	
		10MHz	40620	82710	8.19	-38.11		1.28	46.30	20.00	-26.30	T4	
		5MHz	40620	82710	7.95	-38.66		1.31	46.61	20.00	-26.61	T4	
		3MHz	40620	82710	-0.41	-41.75		41.34	20.00	-21.34	T4		
	Radial	15MHz	40620	82710	-0.10	-41.80	-63.68	N/A	41.70	20.00	-21.70	T4	2.0, 3.6
		10MHz	40620	82710	-0.53	-42.34		41.81	20.00	-21.81	T4		
		5MHz	40620	82710	-0.48	-42.43		41.95	20.00	-21.95	T4		

FCC ID: PY7-57441Y		HAC (T-COIL) TEST REPORT	SONY	Approved by: Quality Manager
Filename: 1M2007070106-13-R3.PY7	Test Dates: 08/31/2020 - 09/22/2020	DUT Type: Portable Handset		Page 32 of 83

Table 8-13
Raw Data Results for LTE B48

Mode	Orientation	Bandwidth	Channel	Sample S/N	ABM1 [dB(A/m)]	ABM2 [dB(A/m)]	Ambient Noise [dB(A/m)]	Frequency Response Margin (dB)	S+N/N (dB)	FCC Limit (dB)	Margin from FCC Limit (dB)	C63.19-2011 Rating	Test Coordinates
LTE Band 48	Axial	20MHz	55990	82710	7.86	-33.93	-59.23	1.23	41.79	20.00	-21.79	T4	1.8, 2.6
		15MHz	56665	82710	7.75	-34.34		1.45	42.09	20.00	-22.09	T4	
		15MHz	55990	82710	7.78	-33.67		1.25	41.45	20.00	-21.45	T4	
		15MHz	55315	82710	7.95	-34.43		7.95	42.38	20.00	-22.38	T4	
		10MHz	55990	82710	8.10	-33.77		1.29	41.87	20.00	-21.87	T4	
		5MHz	55990	82710	7.71	-34.01		1.31	41.72	20.00	-21.72	T4	
	Radial	20MHz	56640	82710	-0.29	-39.24	-63.68	N/A	38.95	20.00	-18.95	T4	2.0, 3.6
		20MHz	55990	82710	-0.40	-38.72			38.32	20.00	-18.32	T4	
		20MHz	55340	82710	-0.39	-38.55			38.16	20.00	-18.16	T4	
		15MHz	55990	82710	-0.21	-39.04			38.83	20.00	-18.83	T4	
		10MHz	55990	82710	-0.55	-39.12			38.57	20.00	-18.57	T4	
		5MHz	55990	82710	-0.39	-39.42			39.03	20.00	-19.03	T4	

Table 8-14
Raw Data Results for EDGE (OTT VoIP)

Mode	Orientation	Channel	Sample S/N	ABM1 [dB(A/m)]	ABM2 [dB(A/m)]	Ambient Noise [dB(A/m)]	Frequency Response Margin (dB)	S+N/N (dB)	FCC Limit (dB)	Margin from FCC Limit (dB)	C63.19-2011 Rating	Test Coordinates
EDGE850	Axial	190	82710	25.03	-35.15	-59.23	0.86	60.18	20.00	-40.18	T4	1.8, 2.6
	Radial	190	82710	18.24	-41.24	-59.91	N/A	59.48	20.00	-39.48	T4	2.0, 3.6
EDGE1900	Axial	661	82710	25.01	-37.42	-59.23	0.86	62.43	20.00	-42.43	T4	1.8, 2.6
	Radial	661	82710	18.30	-43.01	-59.91	N/A	61.31	20.00	-41.31	T4	2.0, 3.6

Table 8-15
Raw Data Results for HSPA (OTT VoIP)

Mode	Orientation	Channel	Sample S/N	ABM1 [dB(A/m)]	ABM2 [dB(A/m)]	Ambient Noise [dB(A/m)]	Frequency Response Margin (dB)	S+N/N (dB)	FCC Limit (dB)	Margin from FCC Limit (dB)	C63.19-2011 Rating	Test Coordinates
HSPA V	Axial	4183	82710	25.35	-48.85	-59.23	0.98	74.20	20.00	-54.20	T4	1.8, 2.6
	Radial	4183	82710	18.00	-50.15	-59.91	N/A	68.15	20.00	-48.15	T4	2.0, 3.6
HSPA IV	Axial	1412	82710	25.11	-49.93	-59.23	0.98	75.04	20.00	-55.04	T4	1.8, 2.6
	Radial	1412	82710	18.08	-50.00	-59.91	N/A	68.08	20.00	-48.08	T4	2.0, 3.6
HSPA II	Axial	9400	82710	25.23	-49.54	-59.23	0.70	74.77	20.00	-54.77	T4	1.8, 2.6
	Radial	9400	82710	18.06	-50.11	-59.91	N/A	68.17	20.00	-48.17	T4	2.0, 3.6

Table 8-16
Raw Data Results for LTE B5 (OTT VoIP)

Mode	Orientation	Bandwidth	Channel	Sample S/N	ABM1 [dB(A/m)]	ABM2 [dB(A/m)]	Ambient Noise [dB(A/m)]	Frequency Response Margin (dB)	S+N/N (dB)	FCC Limit (dB)	Margin from FCC Limit (dB)	C63.19-2011 Rating	Test Coordinates
LTE Band 5	Axial	10MHz	20525	82710	25.45	-44.18	-59.23	1.24	69.63	20.00	-49.63	T4	1.8, 2.6
		5MHz	20625	82710	24.74	-44.30		1.19	69.04	20.00	-49.04	T4	
		5MHz	20525	82710	24.88	-44.05		1.27	68.93	20.00	-48.93	T4	
		5MHz	20425	82710	24.86	-45.87		1.24	70.73	20.00	-50.73	T4	
		3MHz	20525	82710	25.22	-43.86		1.28	69.08	20.00	-49.08	T4	
		1.4MHz	20525	82710	25.42	-46.02		1.22	71.44	20.00	-51.44	T4	
		Radial	10MHz	20600	82710	17.76		-44.51	-63.68	N/A	62.27	20.00	
	10MHz		20525	82710	17.81	-45.52	63.33	20.00			-43.33	T4	
	10MHz		20450	82710	17.77	-45.62	63.39	20.00			-43.39	T4	
	5MHz		20525	82710	17.81	-47.14	64.95	20.00			-44.95	T4	
	3MHz		20525	82710	17.78	-45.74	63.52	20.00			-43.52	T4	
	1.4MHz		20525	82710	17.73	-46.22	63.95	20.00			-43.95	T4	

FCC ID: PY7-57441Y		HAC (T-COIL) TEST REPORT	SONY	Approved by: Quality Manager
Filename: 1M2007070106-13-R3.PY7	Test Dates: 08/31/2020 - 09/22/2020	DUT Type: Portable Handset		Page 33 of 83

Table 8-17
Raw Data Results for LTE B48 (OTT VoIP)

Mode	Orientation	Bandwidth	Channel	Sample S/N	ABM1 [dB(A/m)]	ABM2 [dB(A/m)]	Ambient Noise [dB(A/m)]	Frequency Response Margin (dB)	S+N/N (dB)	FCC Limit (dB)	Margin from FCC Limit (dB)	C63.19-2011 Rating	Test Coordinates
LTE Band 48	Axial	20MHz	55990	82710	25.80	-33.89	-59.23	1.13	59.69	20.00	-39.69	T4	1.8, 2.6
		15MHz	56665	82710	25.16	-34.40		1.16	59.56	20.00	-39.56	T4	
		15MHz	55990	82710	25.06	-33.66		1.15	58.72	20.00	-38.72	T4	
		15MHz	55315	82710	24.77	-33.43		1.09	58.20	20.00	-38.20	T4	
		10MHz	55990	82710	25.08	-33.79		1.13	58.87	20.00	-38.87	T4	
		5MHz	55990	82710	25.28	-34.19		1.15	59.47	20.00	-39.47	T4	
	Radial	20MHz	56640	82710	17.43	-39.32	-63.68	N/A	56.75	20.00	-36.75	T4	2.0, 3.6
		20MHz	55990	82710	17.40	-38.85			56.25	20.00	-36.25	T4	
		20MHz	55340	82710	17.44	-38.56			56.00	20.00	-36.00	T4	
		15MHz	55990	82710	17.69	-39.40			57.09	20.00	-37.09	T4	
		10MHz	55990	82710	17.38	-39.37			56.75	20.00	-36.75	T4	
		5MHz	55990	82710	17.42	-39.37			56.79	20.00	-36.79	T4	

Table 8-18
Raw Data Results for NR n5 (OTT VoIP)

Mode	Orientation	Bandwidth	Channel	Sample S/N	ABM1 _{LTE} [dB(A/m)]	ABM2 _{NR} [dB(A/m)]	ABM2 _{LTE} [dB(A/m)]	Ambient Noise [dB(A/m)]	Frequency Response Margin (dB)	S+N/N _{NR} (dB)	S+N/N _{NR} - 3 dB (dB)	FCC Limit (dB)	Margin from FCC Limit (dB)	C63.19-2011 Rating	Test Coordinates
NR n5	Axial	20MHz	167300	80797	25.45	-47.15	-44.18	-64.57	N/A	72.60	69.60	20.00	-49.60	T4	1.8, 2.6
		15MHz	168300	80797	25.45	-47.71	-44.18			73.16	70.16	20.00	-50.16	T4	
		15MHz	167300	80797	25.45	-47.12	-44.18			72.57	69.57	20.00	-49.57	T4	
		15MHz	166300	80797	25.45	-47.49	-44.18			72.94	69.94	20.00	-49.94	T4	
		10MHz	167300	80797	25.45	-47.66	-44.18			73.11	70.11	20.00	-50.11	T4	
		5MHz	167300	80797	25.45	-47.92	-44.18			73.37	70.37	20.00	-50.37	T4	
		20MHz	167300	80797	17.81	-47.91	-45.52			65.72	62.72	20.00	-42.72	T4	
		15MHz	168300	80797	17.81	-48.48	-45.52			66.29	63.29	20.00	-43.29	T4	
	Radial	15MHz	167300	80797	17.81	-47.56	-45.52	-63.68	N/A	65.37	62.37	20.00	-42.37	T4	2.0, 3.6
		15MHz	166300	80797	17.81	-48.00	-45.52			65.81	62.81	20.00	-42.81	T4	
		10MHz	167300	80797	17.81	-48.27	-45.52			66.08	63.08	20.00	-43.08	T4	
		5MHz	167300	80797	17.81	-48.67	-45.52			66.48	63.48	20.00	-43.48	T4	

Table 8-19
Raw Data Results for LTE B5 (OTT VoIP – Additional Measurements for NR)

Mode	Orientation	Bandwidth	Channel	Sample S/N	ABM1 _{LTE} [dB(A/m)]	ABM2 _{NR} [dB(A/m)]	ABM2 _{LTE} [dB(A/m)]	Ambient Noise [dB(A/m)]	Frequency Response Margin (dB)	S+N/N _{LTE} (dB)	S+N/N _{NR} - 3 dB (dB)	FCC Limit (dB)	Margin from FCC Limit (dB)	C63.19-2011 Rating	Test Coordinates
LTE Band 5	Axial	10MHz	20525	82710	25.45	N/A	-44.18	-64.57	N/A	69.63	N/A	20.00	-49.63	T4	1.8, 2.6
	Radial	10MHz	20525	82710	17.81	N/A	-45.52	-63.68		63.33	N/A	20.00	-43.33	T4	2.0, 3.6

Table 8-20
Raw Data Results for 2.4GHz WIFI (OTT VoIP)

Mode	Orientation	Channel	Sample S/N	ABM1 [dB(A/m)]	ABM2 [dB(A/m)]	Ambient Noise [dB(A/m)]	Frequency Response Margin (dB)	S+N/N (dB)	FCC Limit (dB)	Margin from FCC Limit (dB)	C63.19-2011 Rating	Test Coordinates
IEEE 802.11b	Axial	6	82710	25.25	-40.49	-64.57	0.72	65.74	20.00	-45.74	T4	1.8, 2.6
	Radial	6	82710	17.67	-38.94	-63.68	N/A	56.61	20.00	-36.61	T4	2.0, 3.6
IEEE 802.11g	Axial	6	82710	25.06	-43.66	-64.57	0.70	68.72	20.00	-48.72	T4	1.8, 2.6
	Radial	6	82710	18.01	-38.78	-63.68	N/A	56.79	20.00	-36.79	T4	2.0, 3.6
IEEE 802.11n	Axial	6	82710	25.36	-43.72	-64.57	0.76	69.08	20.00	-49.08	T4	1.8, 2.6
	Radial	6	82710	17.36	-38.87	-63.68	N/A	56.23	20.00	-36.23	T4	2.0, 3.6
IEEE 802.11ax SU	Axial	6	82710	25.37	-36.21	-64.57	0.77	61.58	20.00	-41.58	T4	1.8, 2.6
	Radial	6	82710	17.80	-37.25	-63.68	N/A	55.05	20.00	-35.05	T4	2.0, 3.6
IEEE 802.11ax RU	Axial	1	82710	25.32	-37.25	-64.57	0.76	62.57	20.00	-42.57	T4	1.8, 2.6
		6	82710	25.23	-36.08		0.77	61.31	20.00	-41.31	T4	
		11	82710	25.49	-37.00		0.73	62.49	20.00	-42.49	T4	
	Radial	1	82710	17.64	-37.06	-63.68	N/A	54.70	20.00	-34.70	T4	2.0, 3.6
		6	82710	17.64	-36.91			54.55	20.00	-34.55	T4	
		11	82710	17.64	-36.72			54.36	20.00	-34.36	T4	

Table 8-21
Raw Data Results for 5GHz WIFI IEEE 802.11a (OTT VoIP)

Mode	Orientation	Bandwidth	U-NII	Channel	Sample S/N	ABM1 [dB(A/m)]	ABM2 [dB(A/m)]	Ambient Noise [dB(A/m)]	Frequency Response Margin (dB)	S+N/N (dB)	FCC Limit (dB)	Margin from FCC Limit (dB)	C63.19-2011 Rating	Test Coordinates
IEEE 802.11a	Axial	20MHz	1	40	82710	25.49	-43.50	-64.57	0.75	68.99	20.00	-48.99	T4	1.8, 2.6
	Radial	20MHz	1	40	82710	17.61	-38.70	-63.68	N/A	56.31	20.00	-36.31	T4	2.0, 3.6

Table 8-22
Raw Data Results for 5GHz WIFI IEEE 802.11n (OTT VoIP)

Mode	Orientation	Bandwidth	U-NII	Channel	Sample S/N	ABM1 [dB(A/m)]	ABM2 [dB(A/m)]	Ambient Noise [dB(A/m)]	Frequency Response Margin (dB)	S+N/N (dB)	FCC Limit (dB)	Margin from FCC Limit (dB)	C63.19-2011 Rating	Test Coordinates
IEEE 802.11n	Axial	40MHz	1	38	82710	25.37	-43.88	-64.57	0.75	69.25	20.00	-49.25	T4	1.8, 2.6
		20MHz	1	40	82710	25.49	-42.50		0.77	67.99	20.00	-47.99	T4	
	Radial	40MHz	1	38	82710	17.54	-40.02	-63.68	N/A	57.56	20.00	-37.56	T4	2.0, 3.6
		20MHz	1	40	82710	17.60	-38.82			56.42	20.00	-36.42	T4	

Table 8-23
Raw Data Results for 5GHz WIFI IEEE 802.11ac (OTT VoIP)

Mode	Orientation	Bandwidth	U-NII	Channel	Sample S/N	ABM1 [dB(A/m)]	ABM2 [dB(A/m)]	Ambient Noise [dB(A/m)]	Frequency Response Margin (dB)	S+N/N (dB)	FCC Limit (dB)	Margin from FCC Limit (dB)	C63.19-2011 Rating	Test Coordinates
IEEE 802.11ac	Axial	40MHz	1	38	82710	25.30	-42.23	-64.57	0.74	67.53	20.00	-47.53	T4	1.8, 2.6
		20MHz	1	40	82710	25.28	-42.27		0.72	67.55	20.00	-47.55	T4	
	Radial	40MHz	1	38	82710	17.65	-37.73	-63.68	N/A	55.38	20.00	-35.38	T4	2.0, 3.6
		20MHz	1	40	82710	17.57	-36.76			54.33	20.00	-34.33	T4	

Table 8-24
Raw Data Results for 5GHz WIFI IEEE 802.11ax (OTT VoIP)

Mode	Orientation	Bandwidth	U-NII	Channel	Sample S/N	ABM1 [dB(A/m)]	ABM2 [dB(A/m)]	Ambient Noise [dB(A/m)]	Frequency Response Margin (dB)	S+N/N (dB)	FCC Limit (dB)	Margin from FCC Limit (dB)	C63.19-2011 Rating	Test Coordinates
IEEE 802.11ax SU	Axial	40MHz	1	38	82710	25.39	-35.64	-64.57	0.76	61.03	20.00	-41.03	T4	1.8, 2.6
		20MHz	1	40	82710	25.35	-35.62		0.73	60.97	20.00	-40.97	T4	
		40MHz	2A	54	82710	25.45	-35.79		0.76	61.24	20.00	-41.24	T4	
		20MHz	2A	52	82710	25.20	-35.48		0.76	60.68	20.00	-40.68	T4	
		20MHz	2A	56	82710	25.31	-35.49		0.79	60.80	20.00	-40.80	T4	
		20MHz	2A	64	82710	25.33	-35.51		0.74	60.84	20.00	-40.84	T4	
		40MHz	2C	118	82710	25.42	-35.75		0.79	61.17	20.00	-41.17	T4	
		20MHz	2C	120	82710	25.26	-36.12		0.75	61.38	20.00	-41.38	T4	
		40MHz	3	151	82710	25.39	-36.62		0.76	62.01	20.00	-42.01	T4	
	20MHz	3	157	82710	25.31	-36.59	0.74	61.90	20.00	-41.90	T4			
	Radial	40MHz	1	38	82710	17.84	-34.64	-63.68	N/A	52.48	20.00	-32.48	T4	2.0, 3.6
		20MHz	1	36	82710	17.59	-34.91			52.50	20.00	-32.50	T4	
		20MHz	1	40	82710	17.49	-34.74			52.23	20.00	-32.23	T4	
		20MHz	1	48	82710	17.79	-34.86			52.65	20.00	-32.65	T4	
		40MHz	2A	54	82710	17.84	-35.15			52.99	20.00	-32.99	T4	
		20MHz	2A	56	82710	17.72	-34.93			52.65	20.00	-32.65	T4	
		40MHz	2C	118	82710	17.74	-35.76			53.50	20.00	-33.50	T4	
		20MHz	2C	120	82710	17.81	-38.23			56.04	20.00	-36.04	T4	
40MHz		3	151	82710	17.70	-36.77	54.47			20.00	-34.47	T4		
20MHz	3	157	82710	17.81	-36.17	53.98	20.00	-33.98	T4					
IEEE 802.11ax RU	Axial	40MHz	1	38	82710	25.39	-35.60	-64.57	0.72	60.99	20.00	-40.99	T4	1.8, 2.6
		20MHz	1	40	82710	25.55	-35.72		0.71	61.27	20.00	-41.27	T4	
	Radial	40MHz	1	38	82710	17.75	-35.00	-63.68	N/A	52.75	20.00	-32.75	T4	2.0, 3.6
		20MHz	1	40	82710	17.75	-34.83			52.58	20.00	-32.58	T4	

FCC ID: PY7-57441Y		HAC (T-COIL) TEST REPORT	SONY	Approved by: Quality Manager
Filename: 1M2007070106-13-R3.PY7	Test Dates: 08/31/2020 - 09/22/2020	DUT Type: Portable Handset		Page 35 of 83

II. Test Notes

A. General

1. Phone Condition: Mute on; Backlight off; Max Volume; Max Contrast
2. 'Radial' orientation refers to radial transverse.
3. Hearing Aid Mode (**Phone→Settings→Accessibility→Hearing aids**) was set to ON for Frequency Response compliance
4. Speech Signal: ITU-T P.50 Artificial Voice
5. Bluetooth and WIFI were disabled while testing 2G/3G/4G/5G modes.
6. Licensed data modes and Bluetooth were disabled while testing WIFI modes.
7. The Margin from FCC limit column indicates a margin from the FCC limit for compliance (T4).

B. GSM

1. Power Configuration: GSM850: PCL=5, GSM1900: PCL=0;
2. Vocoder Configuration: EFR (GSM);
3. GSM voice test cases cover DTM operations.

C. UMTS

1. Power Configuration: TPC= "All 1s";
2. Vocoder Configuration: AMR 12.2 kbps (UMTS);

D. LTE FDD

1. Power Configuration: TPC = "Max Power"
2. Radio Configuration: 16QAM, 1RB, 99%RB offset
3. Vocoder Configuration: WB AMR 6.60kbps
4. The worst-case band and bandwidth combination for each probe orientation is additionally tested on the low and high channels for those combinations. LTE Band 5 at 10MHz is the worst-case for both Axial and Radial probe orientations.

E. LTE TDD

1. Power Configuration: TPC = "Max Power"
2. Radio Configuration: 16QAM, 1RB, 99% RB offset
3. Power Class 3 Uplink-Downlink configuration: 2
4. Vocoder Configuration: WB AMR 6.60kbps
5. The worst-case band and bandwidth combination for each probe orientation is additionally tested on the low and high channels for those combinations. LTE Band 48 at 15MHz is the worst-case for the Axial probe orientation. LTE Band 48 at 20MHz is the worst-case for the Radial probe orientation.

FCC ID: PY7-57441Y	 PCTEST Proud to be part of	HAC (T-COIL) TEST REPORT	SONY	Approved by: Quality Manager
Filename: 1M2007070106-13-R3.PY7	Test Dates: 08/31/2020 - 09/22/2020	DUT Type: Portable Handset		Page 36 of 83

F. OTT VoIP

1. Vocoder Configuration: 75kbps
2. EDGE Configuration
 - a. MCS Index: 7
 - b. Number of TX slots: 2
 - c. EDGE test cases cover DTM operations.
3. HSPA Configuration:
 - a. Release: 6
 - b. 3GPP 34.121 Subtest 1
4. LTE FDD Configuration:
 - a. Power Configuration: TPC = "Max Power"
 - b. Radio Configuration: 16QAM, 1RB, 99% RB offset
 - c. LTE Band 5 was the worst-case band from Table 6-5 and was used to test both Axial and Radial probe orientations.
 - d. The worst-case band and bandwidth combination for each probe orientation is additionally tested on the low and high channels for those combinations. LTE Band 5 at 5MHz is the worst-case for the Axial probe orientation. LTE Band 5 at 10MHz bandwidth is the worst-case for the Radial probe orientation.
5. LTE TDD Configuration:
 - a. Power Configuration: TPC = "Max Power"
 - b. Radio Configuration: 16QAM, 1RB, 99% RB offset
 - c. Power Class 3 Uplink-Downlink configuration: 2
 - d. LTE Band 48 was the worst-case band from Table 6-6 and was used to test both Axial and Radial probe orientations.
 - e. The worst-case band and bandwidth combination for each probe orientation is additionally tested on the low and high channels for those combinations. LTE Band 48 at 15MHz is the worst-case for the Axial probe orientation. LTE Band 48 at 20MHz is the worst-case for the Radial probe orientation.
6. NR FDD Configuration
 - a. Power Configuration: TxAGC is set such that the DUT operates at max power.
 - b. Radio Configuration: CP-OFDM, 16QAM, 1RB, 1RB Offset
 - c. Due to equipment limitations, ABM1 measurements were not possible. Therefore, the procedure outlined in Section 6.II.3 was followed to obtain SNNR values. Additionally, Frequency Response measurements were not possible due to equipment limitations.
 - d. NR n5 was the worst-case band from Table 6-9 and was used to test both Axial and Radial probe orientations.
 - e. The worst-case band and bandwidth combination for each probe orientation is additionally tested on the low and high channels for those combinations. NR n5 at 15MHz is the worst-case for both Axial and Radial probe orientations.
7. WIFI Configuration:
 - a. Radio Configuration
 - i. IEEE 802.11b: DSSS, 2Mbps
 - ii. IEEE 802.11g/a: BPSK, 9Mbps
 - iii. IEEE 802.11n/ac 20MHz: BPSK, MCS 0
 - iv. IEEE 802.11ax SU 20MHz: BPSK, MCS 0
 - v. IEEE 802.11n/ac 40MHz: QPSK, MCS 1
 - vi. IEEE 802.11ax SU 40MHz: BPSK, MCS 0
 - b. RU Index
 - i. IEEE 802.11ax RU 20MHz: 40
 - ii. IEEE 802.11ax RU 40MHz: 61

FCC ID: PY7-57441Y	 PCTEST Proud to be part of	HAC (T-COIL) TEST REPORT	SONY	Approved by: Quality Manager
Filename: 1M2007070106-13-R3.PY7	Test Dates: 08/31/2020 - 09/22/2020	DUT Type: Portable Handset		Page 37 of 83

- c. The worst-case standard for 2.4GHz WIFI in each probe orientation is additionally tested on the low and high channels. IEEE 802.11ax RU is the worst-case for both Axial and Radial probe orientations.
- d. The worst-case standard for 5GHz WIFI in each probe orientation is additionally tested on higher U-NII bands as well as applicable low and high channels. IEEE 802.11ax SU 20MHz BW (U-NII 2A) is the worst-case for the Axial probe orientation. IEEE 802.11ax SU 20MHz (U-NII 1) is the worst-case for the Radial probe orientation.

III. 1 kHz Vocoder Application Check

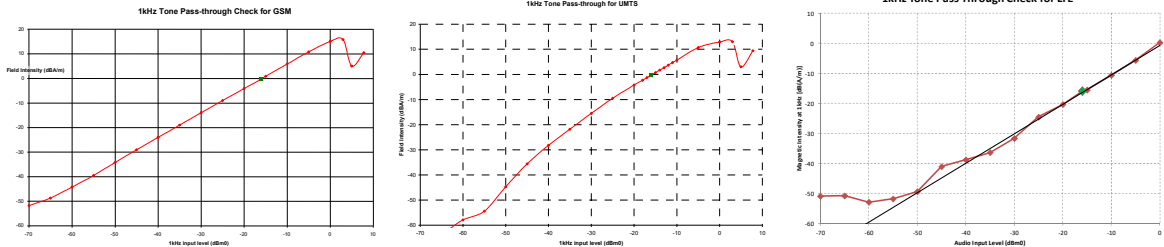

This model was verified to be within the linear region for ABM1 measurements at -16 dBm0 for GSM, UMTS, and VoLTE over IMS. This measurement was taken in the axial configuration above the maximum location.

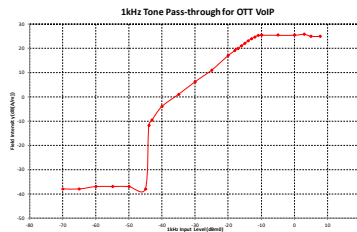



This model was verified to be within the linear region for ABM1 measurements at -20 dBm0 for OTT VoIP. This measurement was taken in the axial configuration above the maximum location.

IV. T-Coil Validation Test Results

Table 8-25
Helmholtz Coil Validation Table of Results – 8/31/2020

Item	Target	Result	Verdict
Axial			
Magnetic Intensity, -10 dBA/m	-10 ± 0.5 dB	-10.323	PASS
Environmental Noise	< -58 dBA/m	-64.19	PASS
Frequency Response, from limits	> 0 dB	0.80	PASS

FCC ID: PY7-57441Y		HAC (T-COIL) TEST REPORT		Approved by: Quality Manager
Filename: 1M2007070106-13-R3.PY7	Test Dates: 08/31/2020 - 09/22/2020	DUT Type: Portable Handset		Page 38 of 83

**Table 8-26
Helmholtz Coil Validation Table of Results – 9/16/2020**

Item	Target	Result	Verdict
Axial			
Magnetic Intensity, -10 dBA/m	-10 ± 0.5 dB	-9.879	PASS
Environmental Noise	< -58 dBA/m	-59.23	PASS
Frequency Response, from limits	> 0 dB	0.80	PASS
Radial			
Magnetic Intensity, -10 dBA/m	-10 ± 0.5 dB	-10.100	PASS
Environmental Noise	< -58 dBA/m	-59.91	PASS
Frequency Response, from limits	> 0 dB	0.80	PASS

**Table 8-27
Helmholtz Coil Validation Table of Results – 9/21/2020**

Item	Target	Result	Verdict
Axial			
Magnetic Intensity, -10 dBA/m	-10 ± 0.5 dB	-10.232	PASS
Environmental Noise	< -58 dBA/m	-64.57	PASS
Frequency Response, from limits	> 0 dB	0.80	PASS
Radial			
Magnetic Intensity, -10 dBA/m	-10 ± 0.5 dB	-10.345	PASS
Environmental Noise	< -58 dBA/m	-63.68	PASS
Frequency Response, from limits	> 0 dB	0.80	PASS

FCC ID: PY7-57441Y	 PCTEST <small>Head to be part of</small>	HAC (T-COIL) TEST REPORT	SONY	Approved by: Quality Manager
Filename: 1M2007070106-13-R3.PY7	Test Dates: 08/31/2020 - 09/22/2020	DUT Type: Portable Handset		Page 39 of 83

V. ABM1 Magnetic Field Distribution Scan Overlays

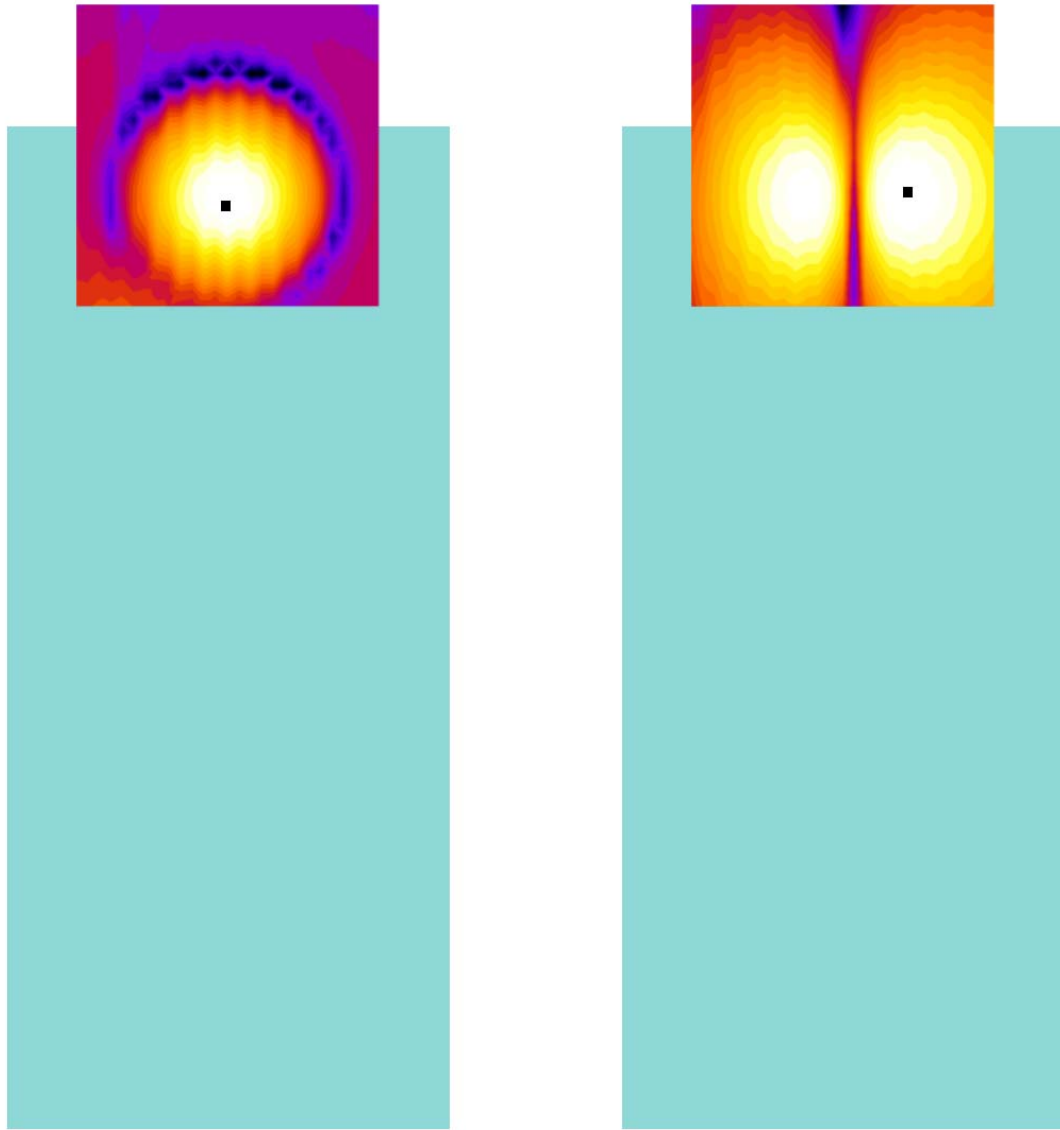

Axial

Radial (Transverse)

Figure 8-1
T-Coil Scan Overlay Magnetic Field Distributions

Notes:

1. Final measurement locations are indicated by a cursor on the contour plots.
2. See Test Setup Photographs for actual WD overlay.

FCC ID: PY7-57441Y		HAC (T-COIL) TEST REPORT	SONY	Approved by: Quality Manager
Filename: 1M2007070106-13-R3.PY7	Test Dates: 08/31/2020 - 09/22/2020	DUT Type: Portable Handset		Page 40 of 83

© 2020 PCTEST

REV 3.5.M
8/18/2020

© 2020 PCTEST All rights reserved. Unless otherwise specified, no part of this report may be reproduced or utilized in any part, form or by any means, electronic or mechanical, including photocopying and microfilm, without permission in writing from PCTEST. If you have any questions about this international copyright or have an enquiry about obtaining additional rights to this report or assembly of contents thereof, please contact INFO@PCTEST.COM.

9. MEASUREMENT UNCERTAINTY

**Table 9-1
Uncertainty Estimation Table**

Contribution	Data +/- %	Data +/- dB	Data Type	Probability distribution	Divisor	Standard uncertainty	Standard Uncertainty (dB)
ABM Noise	7.0%	0.29	Std. Dev.	Normal k=1	1.00	7.0%	
RF Reflections	4.7%	0.20	Specification	Rectangular	1.73	2.7%	
Reference Signal Level	12.2%	0.50	Specification	Rectangular	1.73	7.0%	
Positioning Accuracy	10.0%	0.41	Uncertainty	Rectangular	1.73	5.8%	
Probe Coil Sensitivity	12.2%	0.50	Specification	Rectangular	1.73	7.0%	
Probe Linearity	2.4%	0.10	Std. Dev.	Normal k=1	1.00	2.4%	
Cable Loss	2.8%	0.12	Specification	Rectangular	1.73	1.6%	
Frequency Analyzer	5.0%	0.21	Specification	Rectangular	1.73	2.9%	
System Repeatability	5.0%	0.21	Std. Dev.	Normal k=1	1.00	5.0%	
WD Repeatability	9.0%	0.37	Std. Dev.	Normal k=1	1.00	9.0%	
Positioner Accuracy	1.0%	0.04	Specification	Rectangular	1.73	0.6%	
Combined standard uncertainty, u_c (k=1)						17.7%	0.71
Expanded uncertainty (k=2), 95% confidence level						35.3%	1.31

Notes:

1. Test equipments are calibrated according to techniques outlined in NIS81, NIS3003 and NIST Tech Note 1297.
2. All equipments have traceability according to NIST. Measurement Uncertainties are defined in further detail in NIS 81 and NIST Tech Note 1297 and UKAS M3003.

Measurement uncertainty reflects the quality and accuracy of a measured result as compared to the true value. Such statements are generally required when stating results of measurements so that it is clear to the intended audience that the results may differ when reproduced by different facilities. Measurement results vary due to the measurement uncertainty of the instrumentation, measurement technique, and test engineer. Most uncertainties are calculated using the tolerances of the instrumentation used in the measurement, the measurement setup variability, and the technique used in performing the test. While not generally included, the variability of the equipment under test also figures into the overall measurement uncertainty. Another component of the overall uncertainty is based on the variability of repeated measurements (so-called Type A uncertainty). This may mean that the Hearing Aid compatibility tests may have to be repeated by taking down the test setup and resetting it up so that there are a statistically significant number of repeat measurements to identify the measurement uncertainty. By combining the repeat measurement results with that of the instrumentation chain using the technique contained in NIS 81 and NIS 3003, the overall measurement uncertainty was estimated.

FCC ID: PY7-57441Y		HAC (T-COIL) TEST REPORT	SONY	Approved by: Quality Manager
Filename: 1M2007070106-13-R3.PY7	Test Dates: 08/31/2020 - 09/22/2020	DUT Type: Portable Handset		Page 41 of 83

10. EQUIPMENT LIST

**Table 10-1
Equipment List**

Manufacturer	Model	Description	Cal Date	Cal Interval	Cal Due	Serial Number
Control Company	4040	Temperature / Humidity Monitor	6/29/2019	Biennial	6/29/2021	192291470
Dell	Latitude E6540	SoundCheck Acoustic Analyzer Laptop	4/24/2019	Biennial	4/24/2021	7BFNM32
RME	Fireface UC	Soundcheck Acoustic Analyzer External Audio Interface	4/24/2019	Biennial	4/24/2021	23528889
Listen	SoundConnect	Microphone Power Supply	4/22/2019	Biennial	4/22/2021	PS2612
Rohde & Schwarz	CMW500	Wideband Radio Communication Tester	2/4/2020	Annual	2/4/2021	162125
Rohde & Schwarz	CMW500	Radio Communication Tester	5/21/2020	Annual	5/21/2021	128635
Seekonk	NC-100	Torque Wrench (8" lb)	8/4/2020	Biennial	8/4/2022	N/A
TEM		HAC System Controller with Software	N/A		N/A	N/A
TEM		HAC Positioner	N/A		N/A	N/A
TEM	Helmholtz Coil	Helmholtz Coil	10/10/2018	Biennial	10/10/2020	SBI 1052
TEM	Helmholtz Coil	Helmholtz Coil	5/20/2019	Biennial	5/20/2021	925
TEM	Axial T-Coil Probe	Axial T-Coil Probe	9/19/2018	Biennial	9/19/2020	TEM-1123
TEM	Axial T-Coil Probe	Axial T-Coil Probe	5/17/2019	Biennial	5/17/2021	TEM-1124
TEM	Radial T-Coil Probe	Radial T-Coil Probe	9/19/2018	Biennial	9/19/2020	TEM-1129
TEM	Radial T-Coil Probe	Radial T-Coil Probe	5/17/2019	Biennial	5/17/2021	TEM-1130

Note: Equipment was used only within its valid calibration period.

FCC ID: PY7-57441Y	 PCTEST <small>Head to be part of</small>	HAC (T-COIL) TEST REPORT	SONY	Approved by: Quality Manager
Filename: 1M2007070106-13-R3.PY7	Test Dates: 08/31/2020 - 09/22/2020	DUT Type: Portable Handset		Page 42 of 83

11. TEST DATA

FCC ID: PY7-57441Y	 PCTEST <small>Head to be part of</small>	HAC (T-COIL) TEST REPORT	SONY	Approved by: Quality Manager
Filename: 1M2007070106-13-R3.PY7	Test Dates: 08/31/2020 - 09/22/2020	DUT Type: Portable Handset	Page 43 of 83	

© 2020 PCTEST

REV 3.5.M
8/18/2020

© 2020 PCTEST All rights reserved. Unless otherwise specified, no part of this report may be reproduced or utilized in any part, form or by any means, electronic or mechanical, including photocopying and microfilm, without permission in writing from PCTEST. If you have any questions about this international copyright or have an enquiry about obtaining additional rights to this report or assembly of contents thereof, please contact INFO@PCTEST.COM.



PCTEST Hearing-Aid Compatibility Facility

DUT: HH Coil – SN: 925

Type: HH Coil
Serial: 925

Measurement Standard: ANSI C63.19-2011

Equipment:

- Probe: Axial T-Coil Probe – SN: TEM-1124; Calibrated: 05/17/2019
- Helmholtz Coil – SN: 925; Calibrated: 05/20/2019

Noise Spectrum

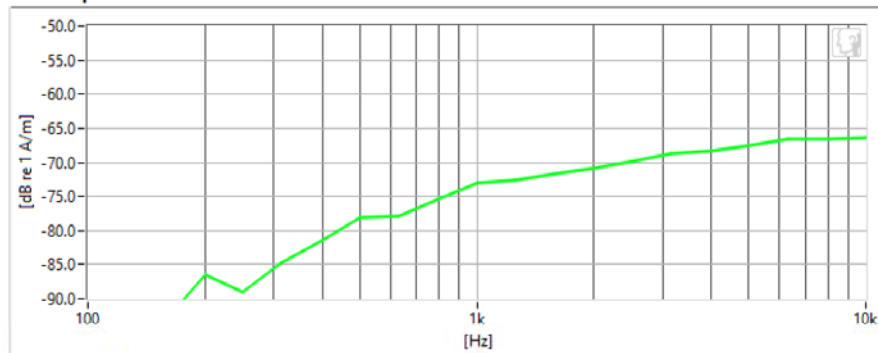

Frequency Response

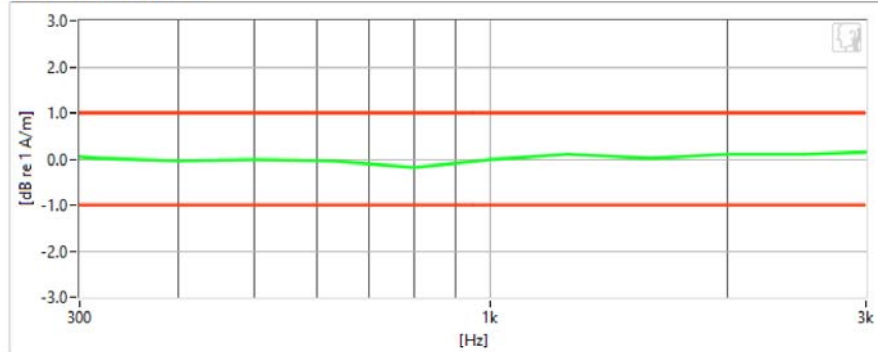

Results

Verification 1kHz Intensity	-10.323 dB	✓	Max/Min	-9.5/-10.5
Verification ABM2	-64.19 dB	✓	Maximum	-58.0
Frequency Response Margin	800m dB	✓	Tolerance curves	Aligned Data

PCTEST 2020

FCC ID: PY7-57441Y		HAC (T-COIL) TEST REPORT	SONY	Approved by: Quality Manager
Filename: 1M2007070106-13-R3.PY7	Test Dates: 08/31/2020 - 09/22/2020	DUT Type: Portable Handset		Page 44 of 83



PCTEST Hearing-Aid Compatibility Facility

DUT: HH Coil – SN: SBI 1052

Type: HH Coil
Serial: SBI 1052

Measurement Standard: ANSI C63.19-2011

Equipment:

- Probe: Axial T-Coil Probe – SN: TEM-1123; Calibrated: 09/19/2018
- Helmholtz Coil – SN: SBI 1052; Calibrated: 10/10/2018

Noise Spectrum

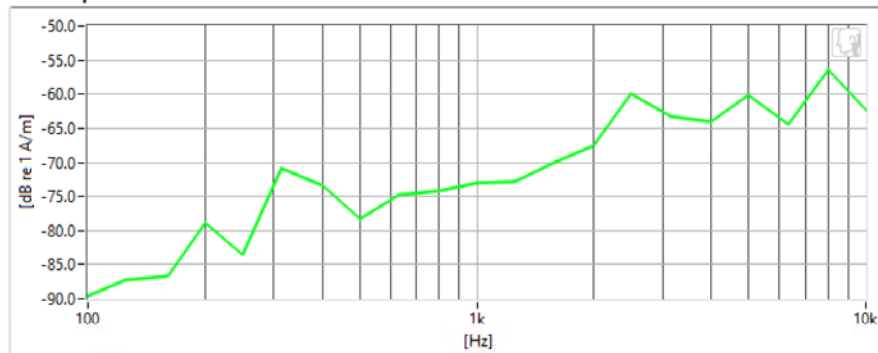

Frequency Response

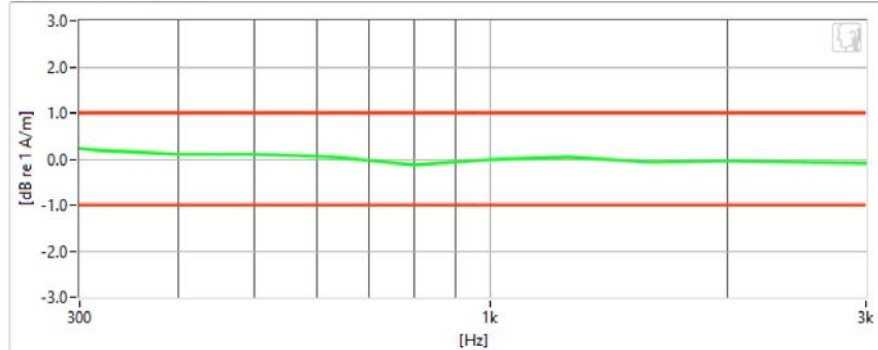

Results

Verification 1kHz Intensity	-9.879 dB	✓	Max/Min	-9.5/-10.5
Verification ABM2	-59.23 dB	✓	Maximum	-58.0
Frequency Response Margin	800m dB	✓	Tolerance curves	Aligned Data

PCTEST 2020

FCC ID: PY7-57441Y		HAC (T-COIL) TEST REPORT	SONY	Approved by: Quality Manager
Filename: 1M2007070106-13-R3.PY7	Test Dates: 08/31/2020 - 09/22/2020	DUT Type: Portable Handset		Page 45 of 83



PCTEST Hearing-Aid Compatibility Facility

DUT: HH Coil – SN: 925

Type: HH Coil
Serial: 925

Measurement Standard: ANSI C63.19-2011

Equipment:

- Probe: Axial T-Coil Probe – SN: TEM-1124; Calibrated: 05/17/2019
- Helmholtz Coil – SN: 925; Calibrated: 10/10/2019

Noise Spectrum

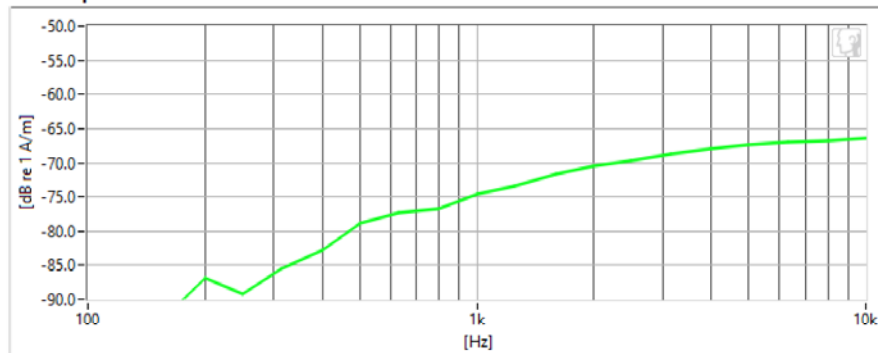

Frequency Response

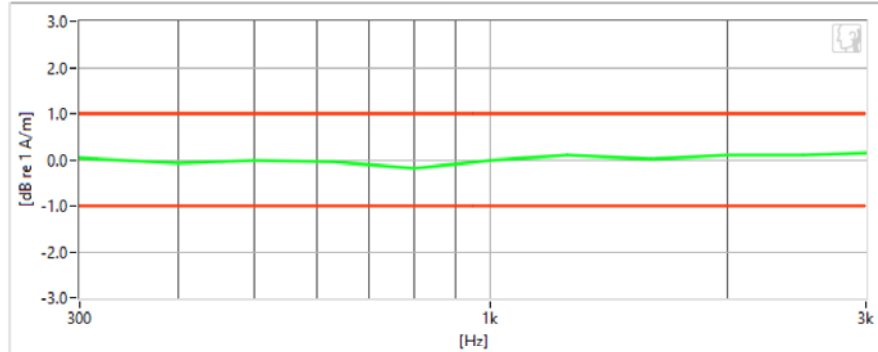

Results

Verification 1kHz Intensity	-10.232 dB	✓	Max/Min	-9.5/-10.5
Verification ABM2	-64.57 dB	✓	Maximum	-58.0
Frequency Response Margin	800m dB	✓	Tolerance curves	Aligned Data

PCTEST 2020

FCC ID: PY7-57441Y		HAC (T-COIL) TEST REPORT	SONY	Approved by: Quality Manager
Filename: 1M2007070106-13-R3.PY7	Test Dates: 08/31/2020 - 09/22/2020	DUT Type: Portable Handset		Page 46 of 83



PCTEST Hearing-Aid Compatibility Facility

DUT: HH Coil – SN: SBI 1052

Type: HH Coil
Serial: SBI 1052

Measurement Standard: ANSI C63.19-2011

Equipment:

- Probe: Radial T-Coil Probe – SN: TEM-1129; Calibrated: 09/19/2018
- Helmholtz Coil – SN: SBI 1052; Calibrated: 10/10/2018

Noise Spectrum

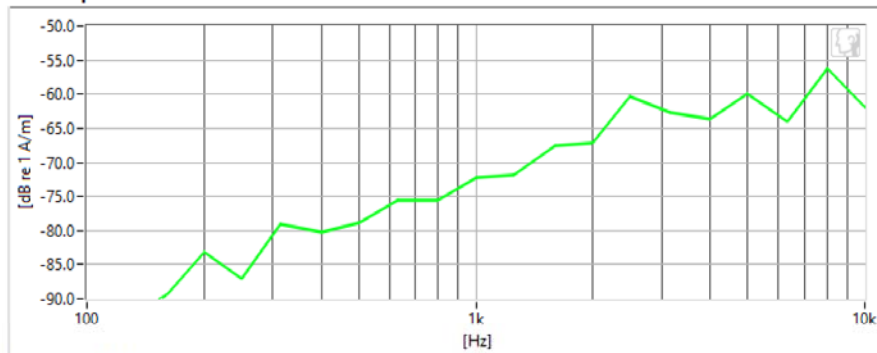

Frequency Response

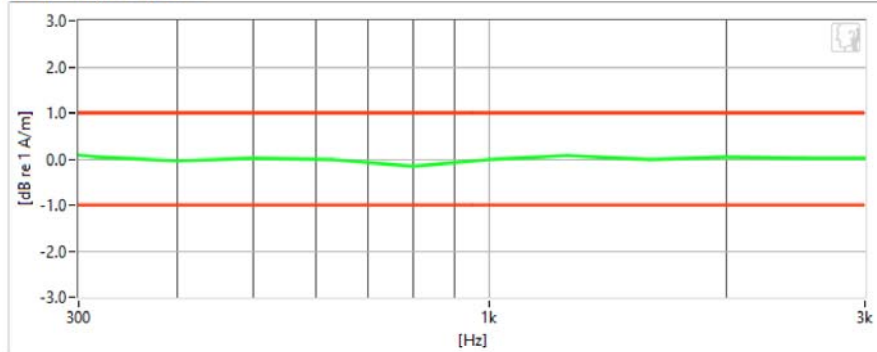

Results

Verification 1kHz Intensity	-10.1 dB	✓	Max/Min	-9.5/-10.5
Verification ABM2	-59.91 dB	✓	Maximum	-58.0
Frequency Response Margin	800m dB	✓	Tolerance curves	Aligned Data

PCTEST 2020

FCC ID: PY7-57441Y		HAC (T-COIL) TEST REPORT	SONY	Approved by: Quality Manager
Filename: 1M2007070106-13-R3.PY7	Test Dates: 08/31/2020 - 09/22/2020	DUT Type: Portable Handset		Page 47 of 83



PCTEST Hearing-Aid Compatibility Facility

DUT: HH Coil – SN: 925

Type: HH Coil
Serial: 925

Measurement Standard: ANSI C63.19-2011

Equipment:

- Probe: Radial T-Coil Probe – SN: TEM-1130; Calibrated: 05/17/2019
- Helmholtz Coil – SN: 925; Calibrated: 05/20/2019

Noise Spectrum

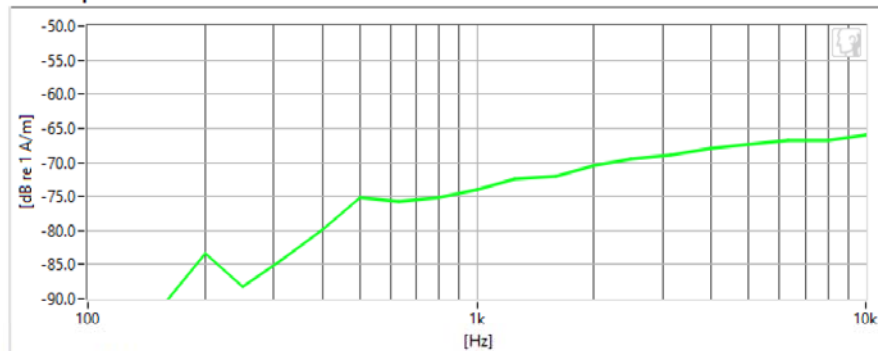

Frequency Response

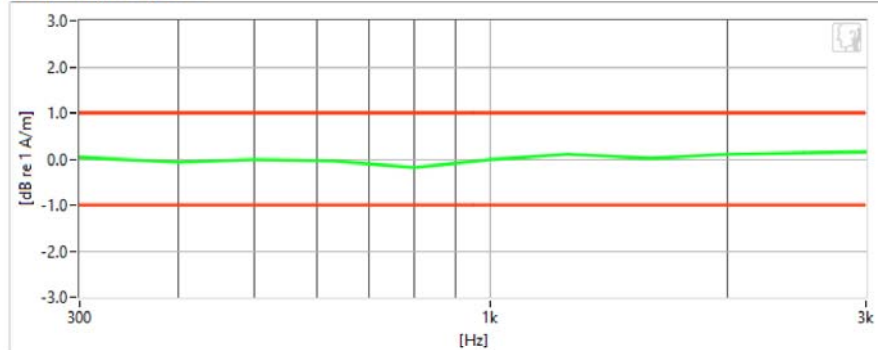

Results

Verification 1kHz Intensity	-10.345 dB	✓	Max/Min	-9.5/-10.5
Verification ABM2	-63.68 dB	✓	Maximum	-58.0
Frequency Response Margin	800m dB	✓	Tolerance curves	Aligned Data

PCTEST 2020

FCC ID: PY7-57441Y		HAC (T-COIL) TEST REPORT	SONY	Approved by: Quality Manager
Filename: 1M2007070106-13-R3.PY7	Test Dates: 08/31/2020 - 09/22/2020	DUT Type: Portable Handset		Page 48 of 83



PCTEST
Proud to be part of element

PCTEST Hearing-Aid Compatibility Facility

DUT: PY7-57441Y

Type: Portable Handset
Serial: 82710

Measurement Standard: ANSI C63.19-2011

Equipment:

- Probe: Axial T-Coil Probe – SN: TEM-1124; Calibrated: 5/17/2019

Test Configuration:

- Mode: GSM850
- Channel: 251
- Speech Signal: ITU-T P.50 Artificial Voice

Noise Spectrum

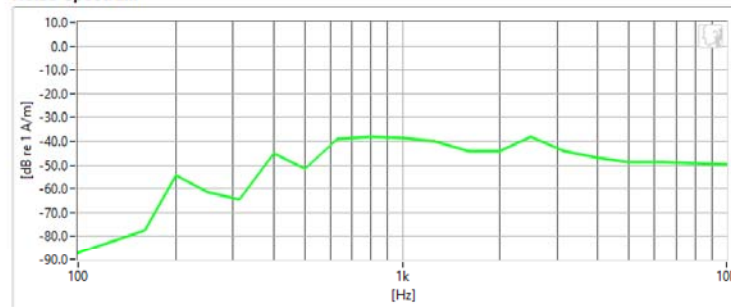

Frequency Response

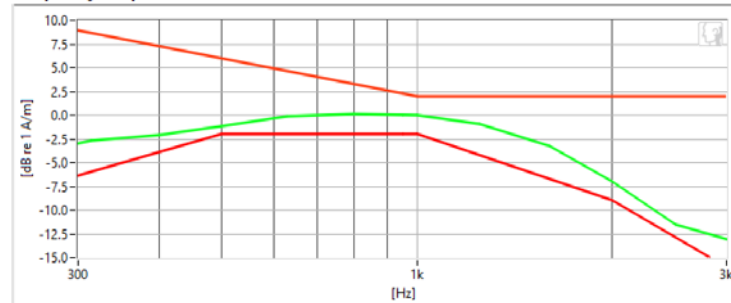

Results

ABM1	12.34 dB	✓	Minimum	-18.0
ABM2	-31.31 dB	✓	Maximum	0
SNNR	43.64 dB	✓	Minimum	20
Aligned Response - P.50	820m dB	✓	Tolerance curves	Aligned Data

PCTEST 2020

FCC ID: PY7-57441Y		HAC (T-COIL) TEST REPORT	SONY	Approved by: Quality Manager
Filename: 1M2007070106-13-R3.PY7	Test Dates: 08/31/2020 - 09/22/2020	DUT Type: Portable Handset		Page 49 of 83



PCTEST[®]

 Proud to be part of  element

PCTEST Hearing-Aid Compatibility Facility

DUT: PY7-57441Y

Type: Portable Handset
Serial: 82710

Measurement Standard: ANSI C63.19-2011

Equipment:

- Probe: Axial T-Coil Probe – SN: TEM-1124; Calibrated: 5/17/2019

Test Configuration:

- Mode: GSM1900
- Channel: 661
- Speech Signal: ITU-T P.50 Artificial Voice

Noise Spectrum

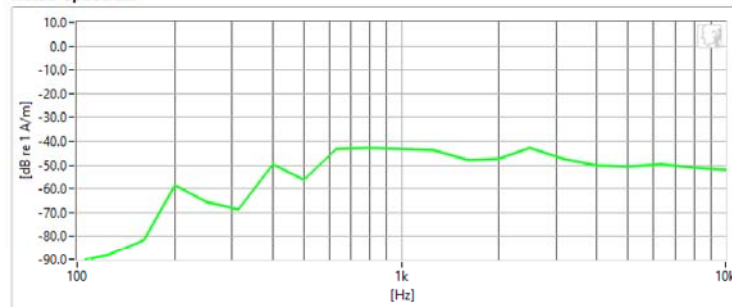

Frequency Response

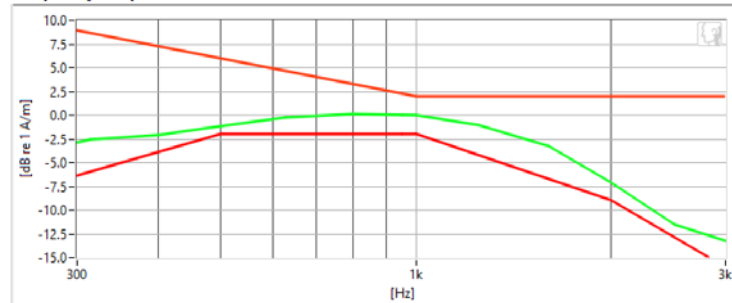

Results

ABM1	12.08 dB	✓	Minimum	-18.0
ABM2	-35.6 dB	✓	Maximum	0.0
SNNR	47.68 dB	✓	Minimum	20.0
Aligned Response - P.50	820m dB	✓	Tolerance curves	Aligned Data

PCTEST 2020

FCC ID: PY7-57441Y		HAC (T-COIL) TEST REPORT	SONY	Approved by: Quality Manager
Filename: 1M2007070106-13-R3.PY7	Test Dates: 08/31/2020 - 09/22/2020	DUT Type: Portable Handset		Page 50 of 83



PCTEST®

 Proud to be part of 

PCTEST Hearing-Aid Compatibility Facility

DUT: PY7-57441Y
 Type: Portable Handset
 Serial: 82710

Measurement Standard: ANSI C63.19-2011

Equipment:

- Probe: Axial T-Coil Probe – SN: TEM-1123; Calibrated: 09/19/2018

Test Configuration:

- Mode: UMTS V
- Channel: 4132
- Speech Signal: ITU-T P.50 Artificial Voice

Noise Spectrum

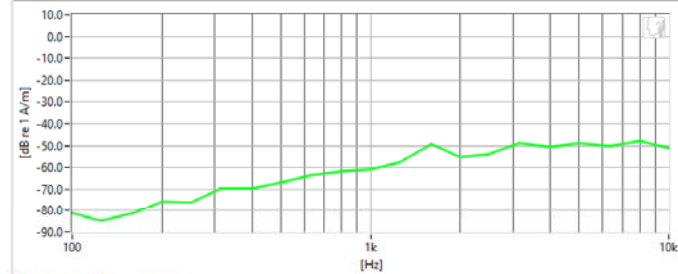

Frequency Response

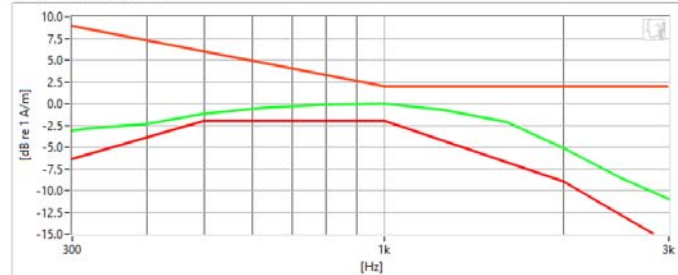

Results

ABM1	11.1 dB	✓	Minimum	-18.0
ABM2	-47.2 dB	✓	Maximum	0.0
SNNR	58.29 dB	✓	Minimum	20.0
Aligned Response - P.50	840m dB	✓	Tolerance curves	Aligned Data

PCTEST 2020

FCC ID: PY7-57441Y		HAC (T-COIL) TEST REPORT	SONY	Approved by: Quality Manager
Filename: 1M2007070106-13-R3.PY7	Test Dates: 08/31/2020 - 09/22/2020	DUT Type: Portable Handset		Page 51 of 83



PCTEST®

 Proud to be part of 

PCTEST Hearing-Aid Compatibility Facility

DUT: PY7-57441Y

Type: Portable Handset
Serial: 82710

Measurement Standard: ANSI C63.19-2011

Equipment:

- Probe: Axial T-Coil Probe – SN: TEM-1123; Calibrated: 09/19/2018

Test Configuration:

- Mode: UMTS IV
- Channel: 1312
- Speech Signal: ITU-T P.50 Artificial Voice

Noise Spectrum

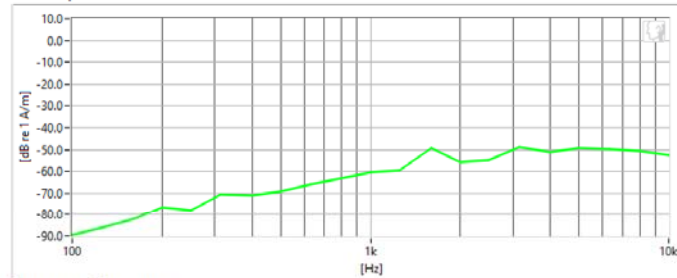

Frequency Response

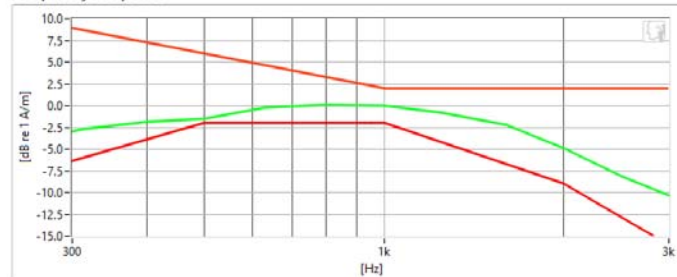

Results

ABM1	11.28 dB	✓	Minimum	-18.0
ABM2	-47.72 dB	✓	Maximum	0.0
SNNR	59 dB	✓	Minimum	20.0
Aligned Response - P.50	500m dB	✓	Tolerance curves	Aligned Data

PCTEST 2020

FCC ID: PY7-57441Y		HAC (T-COIL) TEST REPORT	SONY	Approved by: Quality Manager
Filename: 1M2007070106-13-R3.PY7	Test Dates: 08/31/2020 - 09/22/2020	DUT Type: Portable Handset		Page 52 of 83



PCTEST

 Proud to be part of 

PCTEST Hearing-Aid Compatibility Facility

DUT: PY7-57441Y
 Type: Portable Handset
 Serial: 82710

Measurement Standard: ANSI C63.19-2011

Equipment:

- Probe: Axial T-Coil Probe – SN: TEM-1123; Calibrated: 09/19/2018

Test Configuration:

- Mode: UMTS II
- Channel: 9538
- Speech Signal: ITU-T P.50 Artificial Voice

Noise Spectrum

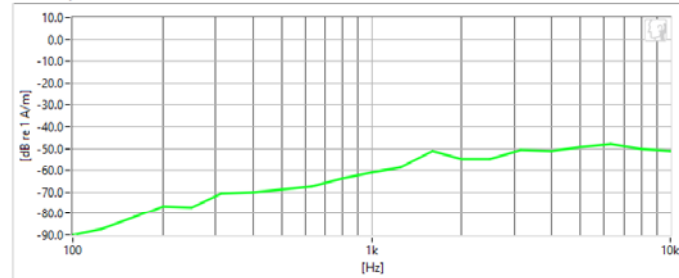

Frequency Response

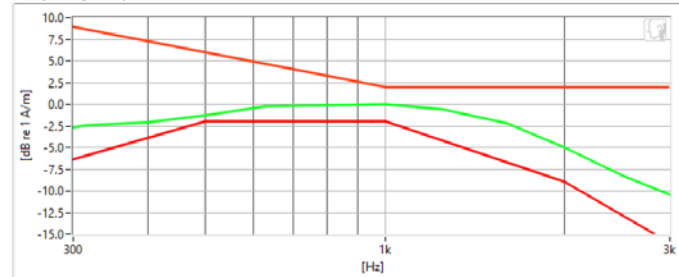

Results

ABM1	11.47 dB	✓	Minimum	-18.0
ABM2	-48.42 dB	✓	Maximum	0.0
SNNR	59.89 dB	✓	Minimum	20.0
Aligned Response - P.50	680m dB	✓	Tolerance curves	Aligned Data

PCTEST 2020

FCC ID: PY7-57441Y		HAC (T-COIL) TEST REPORT	SONY	Approved by: Quality Manager
Filename: 1M2007070106-13-R3.PY7	Test Dates: 08/31/2020 - 09/22/2020	DUT Type: Portable Handset		Page 53 of 83



PCTEST®

 Proud to be part of 

PCTEST Hearing-Aid Compatibility Facility

DUT: PY7-57441Y
 Type: Portable Handset
 Serial: 82710

Measurement Standard: ANSI C63.19-2011

Equipment:

- Probe: Axial T-Coil Probe – SN: TEM-1123; Calibrated: 09/19/2018

Test Configuration:

- Mode: LTE FDD Band 5
- Bandwidth: 10MHz
- Channel: 20600
- Speech Signal: ITU-T P.50 Artificial Voice

Noise Spectrum

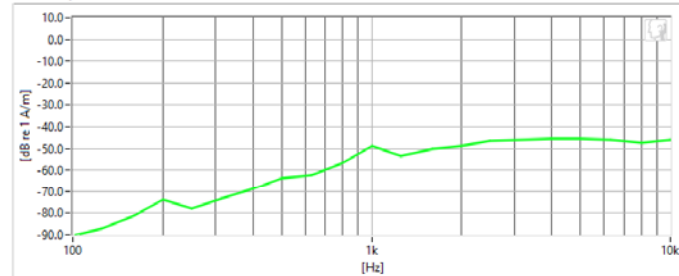

Frequency Response

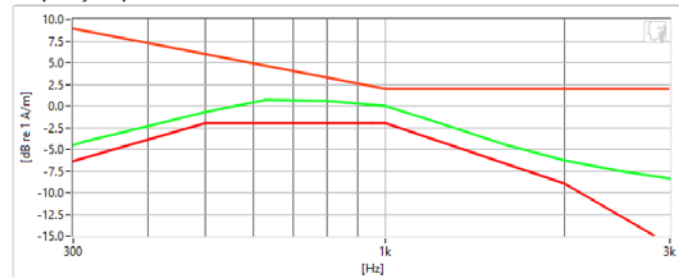

Results

ABM1	7.56 dB	✓	Minimum	-18.0
ABM2	-42.98 dB	✓	Maximum	0
SNNR	50.54 dB	✓	Minimum	20
Aligned Response - P.50	1.26 dB	✓	Tolerance curves	Aligned Data

PCTEST 2020

FCC ID: PY7-57441Y		HAC (T-COIL) TEST REPORT	SONY	Approved by: Quality Manager
Filename: 1M2007070106-13-R3.PY7	Test Dates: 08/31/2020 - 09/22/2020	DUT Type: Portable Handset		Page 54 of 83



PCTEST

 Proud to be part of 

PCTEST Hearing-Aid Compatibility Facility

DUT: PY7-57441Y

Type: Portable Handset
Serial: 82710

Measurement Standard: ANSI C63.19-2011

Equipment:

- Probe: Axial T-Coil Probe – SN: TEM-1123; Calibrated: 09/19/2018

Test Configuration:

- Mode: LTE TDD Band 48
- Bandwidth: 15MHz
- Channel: 55990
- Speech Signal: ITU-T P.50 Artificial Voice

Noise Spectrum

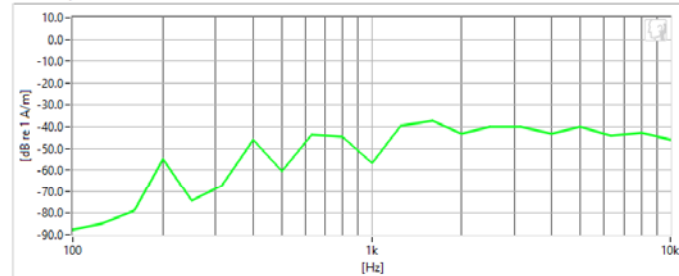

Frequency Response

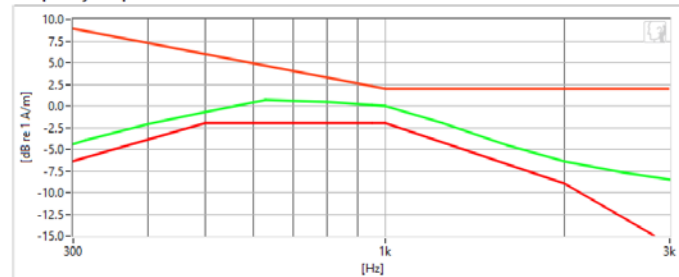

Results

ABM1	7.78 dB	✓	Minimum	-18.0
ABM2	-33.68 dB	✓	Maximum	0
SNNR	41.45 dB	✓	Minimum	20
Aligned Response - P.50	1.25 dB	✓	Tolerance curves	Aligned Data

PCTEST 2020

FCC ID: PY7-57441Y		HAC (T-COIL) TEST REPORT	SONY	Approved by: Quality Manager
Filename: 1M2007070106-13-R3.PY7	Test Dates: 08/31/2020 - 09/22/2020	DUT Type: Portable Handset		Page 55 of 83



PCTEST®

 Proud to be part of 

PCTEST Hearing-Aid Compatibility Facility

DUT: PY7-57441Y

Type: Portable Handset
Serial: 82710

Measurement Standard: ANSI C63.19-2011

Equipment:

- Probe: Axial T-Coil Probe – SN: TEM-1123; Calibrated: 09/19/2018

Test Configuration:

- VoIP Application: Google Duo
- Mode: LTE TDD Band 48
- Bandwidth: 15MHz
- Channel: 55315
- Speech Signal: ITU-T P.50 Artificial Voice

Noise Spectrum

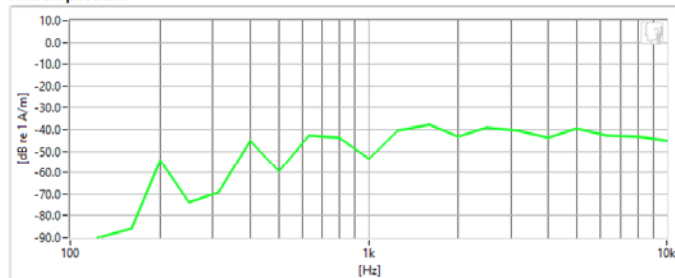

Frequency Response

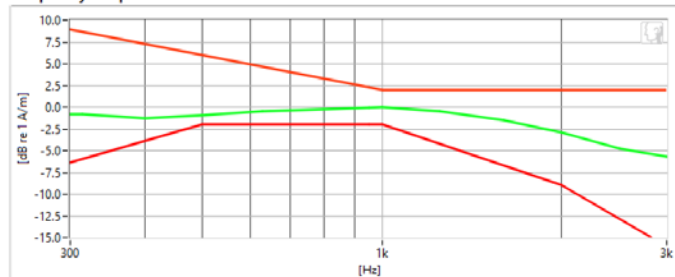

Results

ABM1	24.77 dB	✓	Minimum	-18.0
ABM2	-33.43 dB	✓	Maximum	0.0
SNNR	58.2 dB	✓	Minimum	20.0
Aligned Response - P.50	1.09 dB	✓	Tolerance curves	Aligned Data

PCTEST 2020

FCC ID: PY7-57441Y		HAC (T-COIL) TEST REPORT	SONY	Approved by: Quality Manager
Filename: 1M2007070106-13-R3.PY7	Test Dates: 08/31/2020 - 09/22/2020	DUT Type: Portable Handset		Page 56 of 83



PCTEST Hearing-Aid Compatibility Facility

DUT: PY7-57441Y

Type: Portable Handset
Serial: 82710

Measurement Standard: ANSI C63.19-2011

Equipment:

- Probe: Radial T-Coil Probe – SN: TEM-1129; Calibrated: 09/19/2018

Test Configuration:

- Mode: GSM850
- Channel: 251

Noise Spectrum

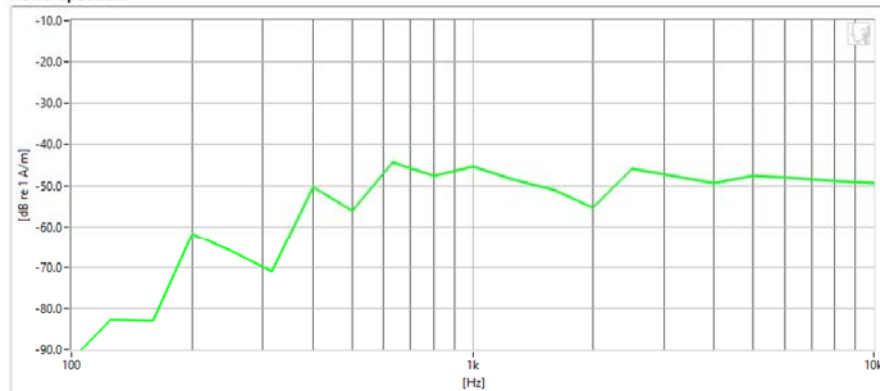

Results

ABM1	4.94 dB	✓	Minimum	-18.0
ABM2	-38.08 dB	✓	Maximum	0.0
SNNR	43.02 dB	✓	Minimum	20.0

PCTEST 2020

FCC ID: PY7-57441Y		HAC (T-COIL) TEST REPORT	SONY	Approved by: Quality Manager
Filename: 1M2007070106-13-R3.PY7	Test Dates: 08/31/2020 - 09/22/2020	DUT Type: Portable Handset		Page 57 of 83

© 2020 PCTEST

REV 3.5.M
8/18/2020



PCTEST Hearing-Aid Compatibility Facility

DUT: PY7-57441Y

Type: Portable Handset
Serial: 82710

Measurement Standard: ANSI C63.19-2011

Equipment:

- Probe: Radial T-Coil Probe – SN: TEM-1129; Calibrated: 09/19/2018

Test Configuration:

- Mode: GSM1900
- Channel: 512

Noise Spectrum

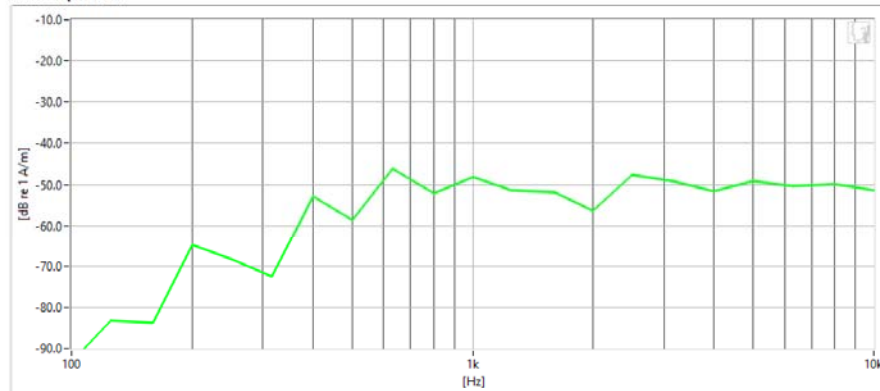

Results

ABM1	4.93 dB	✓	Minimum	-18.0
ABM2	-40.5 dB	✓	Maximum	0.0
SNNR	45.44 dB	✓	Minimum	20.0

PCTEST 2020

FCC ID: PY7-57441Y		HAC (T-COIL) TEST REPORT	SONY	Approved by: Quality Manager
Filename: 1M2007070106-13-R3.PY7	Test Dates: 08/31/2020 - 09/22/2020	DUT Type: Portable Handset		Page 58 of 83

© 2020 PCTEST

REV 3.5.M
8/18/2020



PCTEST Hearing-Aid Compatibility Facility

DUT: PY7-57441Y

Type: Portable Handset
Serial: 82710

Measurement Standard: ANSI C63.19-2011

Equipment:

- Probe: Radial T-Coil Probe – SN: TEM-1129; Calibrated: 09/19/2018

Test Configuration:

- Mode: UMTS V
- Channel: 4183

Noise Spectrum

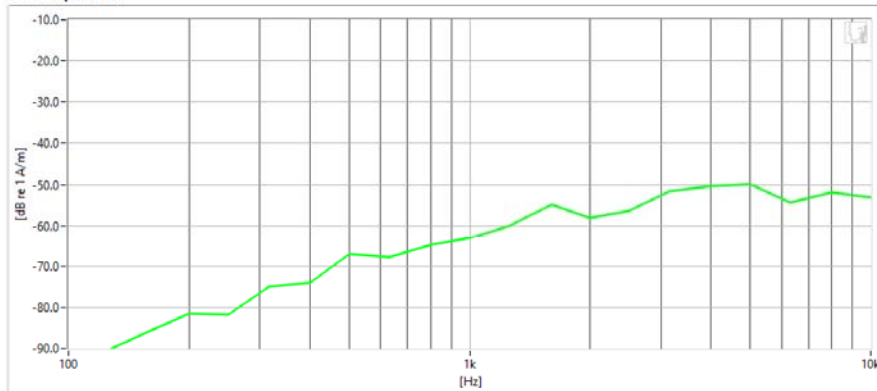

Results

ABM1	4.67 dB	✓	Minimum	-18.0
ABM2	-50.45 dB	✓	Maximum	0.0
SNNR	55.12 dB	✓	Minimum	20.0

PCTEST 2020

FCC ID: PY7-57441Y		HAC (T-COIL) TEST REPORT	SONY	Approved by: Quality Manager
Filename: 1M2007070106-13-R3.PY7	Test Dates: 08/31/2020 - 09/22/2020	DUT Type: Portable Handset		Page 59 of 83

© 2020 PCTEST

REV 3.5.M
8/18/2020



PCTEST Hearing-Aid Compatibility Facility

DUT: PY7-57441Y

Type: Portable Handset
Serial: 82710

Measurement Standard: ANSI C63.19-2011

Equipment:

- Probe: Radial T-Coil Probe – SN: TEM-1129; Calibrated: 09/19/2018

Test Configuration:

- Mode: UMTS IV
- Channel: 1412

Noise Spectrum

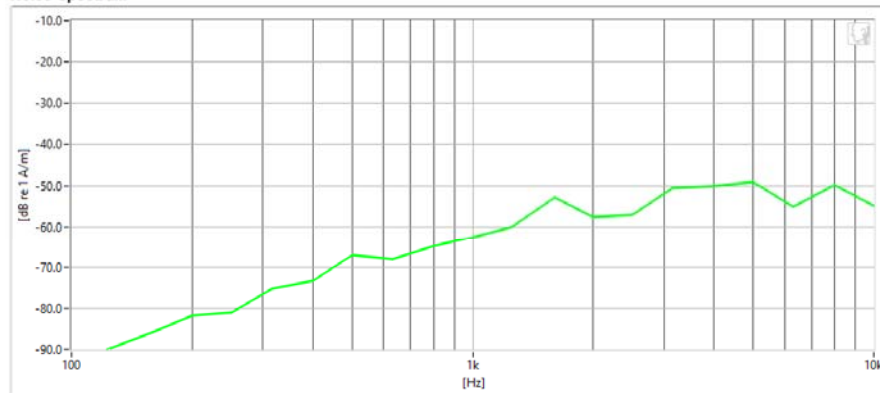

Results

ABM1	4.35 dB	✓	Minimum	-18.0
ABM2	-49.73 dB	✓	Maximum	0.0
SNNR	54.08 dB	✓	Minimum	20.0

PCTEST 2020

FCC ID: PY7-57441Y		HAC (T-COIL) TEST REPORT	SONY	Approved by: Quality Manager
Filename: 1M2007070106-13-R3.PY7	Test Dates: 08/31/2020 - 09/22/2020	DUT Type: Portable Handset		Page 60 of 83



PCTEST Hearing-Aid Compatibility Facility

DUT: PY7-57441Y

Type: Portable Handset
Serial: 82710

Measurement Standard: ANSI C63.19-2011

Equipment:

- Probe: Radial T-Coil Probe – SN: TEM-1129; Calibrated: 09/19/2018

Test Configuration:

- Mode: UMTS II
- Channel: 9538

Noise Spectrum

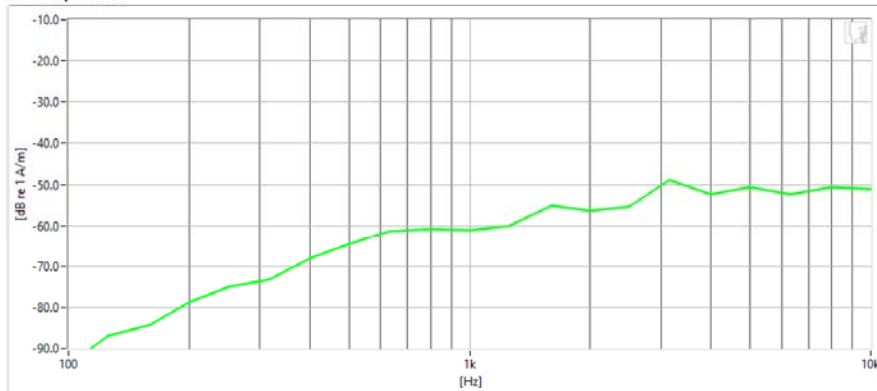

Results

ABM1	4.37 dB	✓	Minimum	-18.0
ABM2	-49.04 dB	✓	Maximum	0.0
SNNR	53.41 dB	✓	Minimum	20.0

PCTEST 2020

FCC ID: PY7-57441Y		HAC (T-COIL) TEST REPORT	SONY	Approved by: Quality Manager
Filename: 1M2007070106-13-R3.PY7	Test Dates: 08/31/2020 - 09/22/2020	DUT Type: Portable Handset		Page 61 of 83



PCTEST

 Proud to be part of 

PCTEST Hearing-Aid Compatibility Facility

DUT: PY7-57441Y

Type: Portable Handset
Serial: 82710

Measurement Standard: ANSI C63.19-2011

Equipment:

- Probe: Radial T-Coil Probe – SN: TEM-1130; Calibrated: 5/17/2019

Test Configuration:

- Mode: LTE FDD Band 5
- Bandwidth: 10MHz
- Channel: 20600

Noise Spectrum

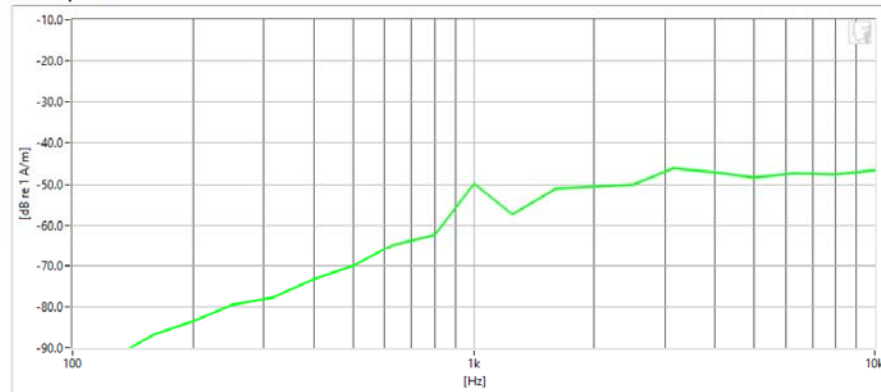

Results

ABM1	-410m dB	✓	Minimum	-18.0
ABM2	-44.77 dB	✓	Maximum	0.0
SNNR	44.36 dB	✓	Minimum	20.0

PCTEST 2020

FCC ID: PY7-57441Y		HAC (T-COIL) TEST REPORT	SONY	Approved by: Quality Manager
Filename: 1M2007070106-13-R3.PY7	Test Dates: 08/31/2020 - 09/22/2020	DUT Type: Portable Handset		Page 62 of 83



PCTEST[®]

Proud to be part of element

PCTEST Hearing-Aid Compatibility Facility

DUT: PY7-57441Y

Type: Portable Handset
Serial: 82710

Measurement Standard: ANSI C63.19-2011

Equipment:

- Probe: Radial T-Coil Probe – SN: TEM-1130; Calibrated: 5/17/2019

Test Configuration:

- Mode: LTE TDD Band 48
- Bandwidth: 20MHz
- Channel: 55340

Noise Spectrum

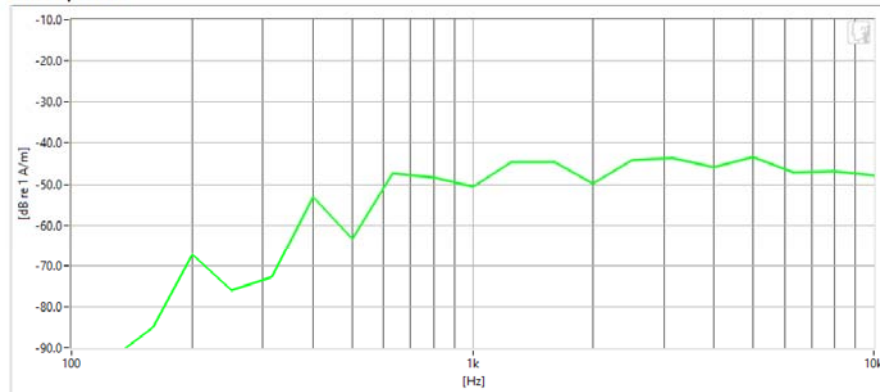

Results

ABM1	-390m dB	✓	Minimum	-18.0
ABM2	-38.55 dB	✓	Maximum	0.0
SNNR	38.16 dB	✓	Minimum	20.0

PCTEST 2020

FCC ID: PY7-57441Y		HAC (T-COIL) TEST REPORT	SONY	Approved by: Quality Manager
Filename: 1M2007070106-13-R3.PY7	Test Dates: 08/31/2020 - 09/22/2020	DUT Type: Portable Handset		Page 63 of 83



PCTEST Hearing-Aid Compatibility Facility

DUT: PY7-57441Y

Type: Portable Handset
Serial: 82710

Measurement Standard: ANSI C63.19-2011

Equipment:

- Probe: Radial T-Coil Probe – SN: TEM-1130; Calibrated: 5/17/2019

Test Configuration:

- VoIP Application: Google Duo
- Mode: 5GHz WLAN
- Standard: IEEE 802.11ax (SU)
- Bandwidth: 20MHz
- Channel: 40

Noise Spectrum

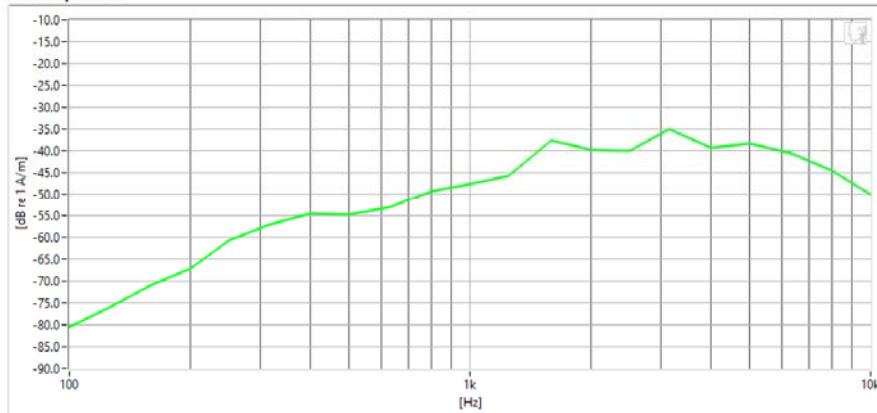

Results

ABM1	17.49 dB	✓	Minimum	-18.0
ABM2	-34.75 dB	✓	Maximum	0.0
SNNR	52.23 dB	✓	Minimum	20.0

PCTEST 2020

FCC ID: PY7-57441Y		HAC (T-COIL) TEST REPORT	SONY	Approved by: Quality Manager
Filename: 1M2007070106-13-R3.PY7	Test Dates: 08/31/2020 - 09/22/2020	DUT Type: Portable Handset		Page 64 of 83

12. CALIBRATION CERTIFICATES

FCC ID: PY7-57441Y	 PCTEST <small>Head to be part of</small>	HAC (T-COIL) TEST REPORT	SONY	Approved by: Quality Manager
Filename: 1M2007070106-13-R3.PY7	Test Dates: 08/31/2020 - 09/22/2020	DUT Type: Portable Handset		Page 65 of 83

© 2020 PCTEST

REV 3.5.M
8/18/2020

© 2020 PCTEST All rights reserved. Unless otherwise specified, no part of this report may be reproduced or utilized in any part, form or by any means, electronic or mechanical, including photocopying and microfilm, without permission in writing from PCTEST. If you have any questions about this international copyright or have an enquiry about obtaining additional rights to this report or assembly of contents thereof, please contact INFO@PCTEST.COM.

West Caldwell Calibration Laboratories Inc.

Certificate of Calibration

for

AXIAL T COIL PROBE

Manufactured by: TEM CONSULTING LP
Model No: AXIAL T COIL PROBE
Serial No: TEM-1123
Calibration Recall No: 29156

Submitted By:

Customer: Andrew Harwell
Company: PCTest Engineering Lab
Address: 6660-B Dobbin Road
Columbia MD 21045

The subject instrument was calibrated to the indicated specification using standards traceable to the National Institute of Standards and Technology or to accepted values of natural physical constants. This document certifies that the instrument met the following specification upon its return to the submitter.

West Caldwell Calibration Laboratories Procedure No. AXIAL T C TEM C

Upon receipt for Calibration, the instrument was found to be:

Within (X)

tolerance of the indicated specification. See attached Report of Calibration.
The information supplied relates to the calibrated item listed above.

West Caldwell Calibration Laboratories' calibration control system meets the requirements, ISO 10012-1 MIL-STD-45662A, ANSI/NCSL Z540-1, IEC Guide 25, ISO 9001:2008 and ISO 17025.

Note: With this Certificate, Report of Calibration is included.

Approved by: *Fc*

Calibration Date: 19-Sep-18

Felix Christopher (QA Mgr.)

Certificate No: 29156 -2

ISO/IEC 17025:2005

QA Doc. #1051 Rev. 2.0 10/1/01

Certificate Page 1 of 1

West Caldwell Calibration Laboratories, Inc.
uncompromised calibration
1575 State Route 96, Victor, NY 14564, U.S.A.



Calibration Lab. Cert. # 1533.01

FCC ID: PY7-57441Y		HAC (T-COIL) TEST REPORT	SONY	Approved by: Quality Manager
Filename: 1M2007070106-13-R3.PY7	Test Dates: 08/31/2020 - 09/22/2020	DUT Type: Portable Handset		Page 66 of 83

© 2020 PCTEST

REV 3.5.M
8/18/2020

© 2020 PCTEST All rights reserved. Unless otherwise specified, no part of this report may be reproduced or utilized in any part, form or by any means, electronic or mechanical, including photocopying and microfilm, without permission in writing from PCTEST. If you have any questions about this international copyright or have an enquiry about obtaining additional rights to this report or assembly of contents thereof, please contact INFO@PCTEST.COM.



REPORT OF CALIBRATION

for

TEM Consulting LP Axial T Coil Probe
Company: PCTest Engineering Lab

Model No.: Axial T Coil Probe

Serial No.: TEM-1123
I. D. No.: XXXX

Calibration results:			
Probe Sensitivity measured with Helmholtz Coil			
<i>Helmholtz Coil;</i>			
the number of turns on each coil;	10	No.	Before & after data same: ...X...
the radius of each coil, in meters;	0.204	m	
the current in the coils, in amperes.;	0.08	A	
<i>Helmholtz Coil Constant;</i>	7.09	A/m/V	Laboratory Environment:
<i>Helmholtz Coil magnetic field;</i>	5.95	A/m	Ambient Temperature: 22.7 °C
			Ambient Humidity: 52.1 % RH
			Ambient Pressure: 99.326 kPa
			Calibration Date: 19-Sep-2018
Probe Sensitivity at	1000	Hz.	Calibration Due:
was	-59.89	dBV/A/m	Report Number: 29156 -2
	1.013	mV/A/m	Control Number: 29156
Probe resistance	903	Ohms	
The above listed instrument meets or exceeds the tested manufacturer's specifications.			
This Calibration is traceable through NIST test numbers: 683/284413-14			
The expanded uncertainty of calibration: 0.30dB at 95% confidence level with a coverage factor of k=2.			
Graph represents Probes Frequency Response.			

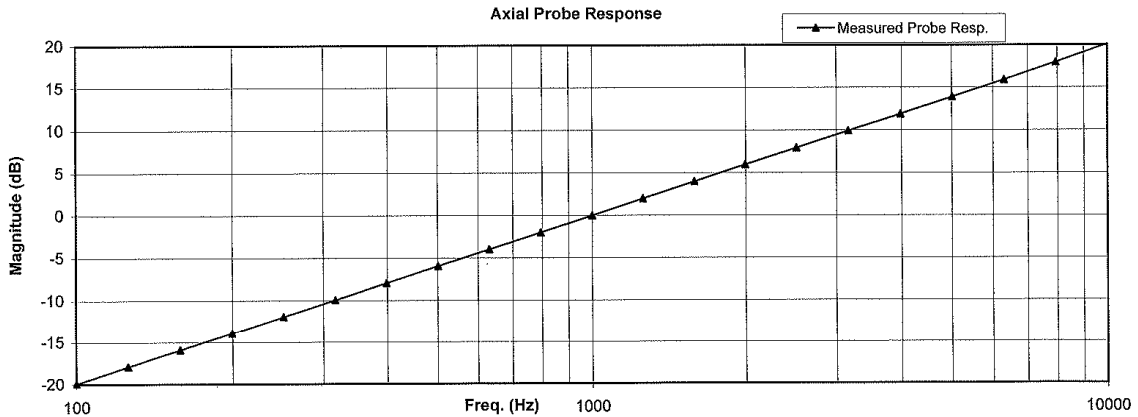

The above listed instrument was checked using calibration procedure documented in West Caldwell Calibration Laboratories Inc. procedure : Rev. 7.0 Jan. 24, 2014 Doc. # 1038 HCATEMC
Calibration was performed by West Caldwell Calibration Laboratories Inc. under Operating Procedures intended to implement the requirements of ISO10012-1, IEC Guide 25, ANSI/NCSL Z540-1, (MIL-STD-45662A) and ISO 9001:2008, ISO 17025

Cal. Date: 19-Sep-2018
Calibrated on WCCL system type 9700

Measurements performed by: *James Zhu*
James Zhu

This document shall not be reproduced, except in full, without the written approval from West Caldwell Cal. Labs. Inc.

Rev. 7.0 Jan. 24, 2014 Doc. # 1038 HCATEMC

FCC ID: PY7-57441Y		HAC (T-COIL) TEST REPORT	SONY	Approved by: Quality Manager
Filename: 1M2007070106-13-R3.PY7	Test Dates: 08/31/2020 - 09/22/2020	DUT Type: Portable Handset		Page 67 of 83

HCATEMC_TEM-1123_Sep-19-2018

West Caldwell Calibration Laboratories Inc.

1575 State Route 96, Victor NY 14564
Tel. (585) 586-3900 FAX (585) 586-4327

Calibration Data Record

TEM Consulting LP Axial T Coil Probe
Company: PCTest Engineering Lab

for
Model No.: Axial T Coil Probe

Serial No.: TEM-1123

Test	Function	Tolerance	Measured values		
			Before	Out	Remarks
1.0	Probe Sensitivity at	1000 Hz. dBV/A/m	-59.89		
2.0	Probe Level Linearity	Ref. (0 dB)	6	6.03	
			0	0.00	
			-6	-6.03	
			-12	-12.05	
3.0	Probe Frequency Response	Ref. (0 dB)	100	-19.9	
			126	-17.9	
			158	-15.9	
			200	-13.9	
			251	-11.9	
			316	-9.9	
			398	-7.9	
			501	-6.0	
			631	-4.0	
			794	-2.0	
			1000	0.0	
			1259	2.0	
			1585	4.0	
			1995	5.9	
			2512	7.9	
			3162	9.9	
3981	11.9				
5012	13.9				
6310	15.9				
7943	18.0				
10000	20.1				

Instruments used for calibration:			Date of Cal.	Traceability No.	Due Date
HP	34401A	S/N US360641	25-Jul-2018	,287708	25-Jul-2019
HP	34401A	S/N US361024	25-Jul-2018	,287708	25-Jul-2019
HP	33120A	S/N US360437	25-Jul-2018	,287708	25-Jul-2019
B&K	2133	S/N 1583254	25-Jul-2018	683/284413-14	25-Jul-2019

Cal. Date: 19-Sep-2018

Tested by: James Zhu

Calibrated on WCCL system type 9700

This document shall not be reproduced, except in full, without the written approval from West Caldwell Cal. Labs. Inc.

Rev. 7.0 Jan. 24, 2014 Doc. # 1038 HCATEMC

FCC ID: PY7-57441Y		HAC (T-COIL) TEST REPORT	SONY	Approved by: Quality Manager
Filename: 1M2007070106-13-R3.PY7	Test Dates: 08/31/2020 - 09/22/2020	DUT Type: Portable Handset		Page 68 of 83

West Caldwell Calibration Laboratories Inc.

Certificate of Calibration

for

AXIAL T COIL PROBE

Manufactured by: TEM CONSULTING
 Model No: AXIAL T COIL PROBE
 Serial No: TEM-1124
 Calibration Recall No: 29973

Submitted By:

Customer: ANDREW HARWELL
 Company: PCTEST ENGINEERING LAB
 Address: 6660-B DOBBIN ROAD
 COLUMBIA MD 21045

The subject instrument was calibrated to the indicated specification using standards traceable to the National Institute of Standards and Technology or to accepted values of natural physical constants. This document certifies that the instrument met the following specification upon its return to the submitter.

West Caldwell Calibration Laboratories Procedure No. AXIAL T C TEM C

RAH
6/4/2019

Upon receipt for Calibration, the instrument was found to be:

Within (X)

tolerance of the indicated specification. See attached Report of Calibration.
 The information supplied relates to the calibrated item listed above.
 West Caldwell Calibration Laboratories' calibration control system meets the requirements, ISO 10012-1 MIL-STD-45662A, ANSI/NCSL Z540-1, IEC Guide 25, ISO 9001:2015 and ISO 17025.

Note: With this Certificate, Report of Calibration is included.

Approved by:

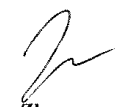

James Zhu

Calibration Date: 17-May-19

Quality Manager
 ISO/IEC 17025:2005

Certificate No: 29973 -1

QA Doc. #1051 Rev. 2.0 10/1/01

Certificate Page 1 of 1

uncompromised calibration
West Caldwell Calibration Laboratories, Inc.
 1575 State Route 96, Victor, NY 14564, U.S.A.



Calibration Lab. Cert. # 1533.01

FCC ID: PY7-57441Y		HAC (T-COIL) TEST REPORT	SONY	Approved by: Quality Manager
Filename: 1M2007070106-13-R3.PY7	Test Dates: 08/31/2020 - 09/22/2020	DUT Type: Portable Handset		Page 69 of 83



ISO/IEC 17025: 2005



Calibration Lab. Cert. # 1533.01

REPORT OF CALIBRATION

for

TEM Consulting LP Axial T Coil Probe
Company: PCTest Engineering Labs

Model No.: Axial T Coil Probe

Serial No.: TEM-1124
I. D. No.: XXXX

Calibration results:

Probe Sensitivity measured with Helmholtz Coil

Helmholtz Coil;
the number of turns on each coil; 10 No.
the radius of each coil, in meters; 0.204 m
the current in the coils, in amperes.; 0.09 A
Helmholtz Coil Constant; 7.09 A/m/V
Helmholtz Coil magnetic field; 5.96 A/m

Before & after data same: ...X...

Laboratory Environment:
Ambient Temperature: 20.7 °C
Ambient Humidity: 42.7 % RH
Ambient Pressure: 98.256 kPa
Calibration Date: 17-May-2019
Calibration Due: 17-May-2020
Report Number: 29973 -1
Control Number: 29973

Probe Sensitivity at 1000 Hz.
was -60.41 dBV/A/m
0.954 mV/A/m
Probe resistance 903 Ohms

The above listed instrument meets or exceeds the tested manufacturer's specifications.

This Calibration is traceable through NIST test numbers: 683/290345-18

The expanded uncertainty of calibration: 0.30dB at 95% confidence level with a coverage factor of k=2.

Graph represents Probes Frequency Response.

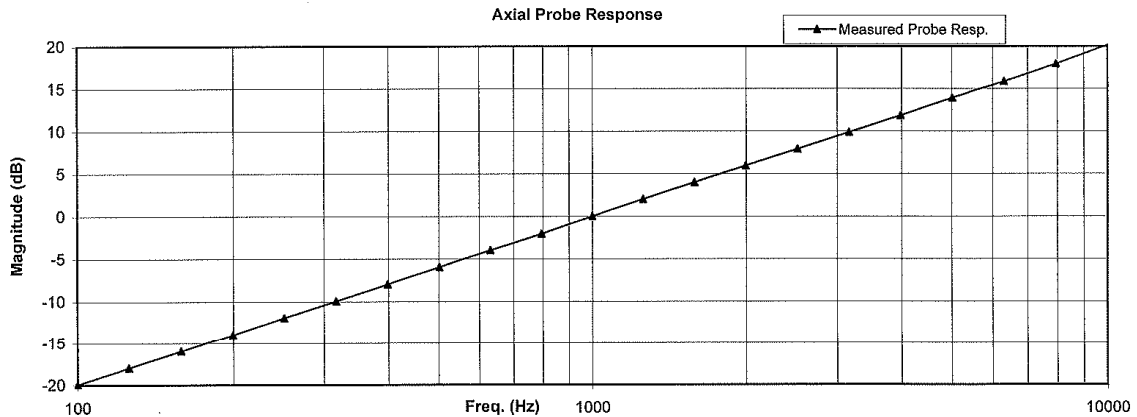

The above listed instrument was checked using calibration procedure documented in West Caldwell

Calibration Laboratories Inc. procedure :

Rev. 7.0 Jan. 24, 2014 Doc. # 1038 HCATEMC

Calibration was performed by West Caldwell Calibration Laboratories Inc. under Operating Procedures

intended to implement the requirements of ISO10012-1, IEC Guide 25, ANSI/NCSL Z540-1, (MIL-STD-45662A) and ISO 17025

Cal. Date: 17-May-2019

Measurements performed by: *James Zhu*

Calibrated on WCCL system type 9700

James Zhu

This document shall not be reproduced, except in full, without the written approval from West Caldwell Cal. Labs. Inc.

Rev. 7.0 Jan. 24, 2014 Doc. # 1038 HCATEMC

FCC ID: PY7-57441Y	PCTEST Proud to be part of	HAC (T-COIL) TEST REPORT	SONY	Approved by: Quality Manager
Filename: 1M2007070106-13-R3.PY7	Test Dates: 08/31/2020 - 09/22/2020	DUT Type: Portable Handset		Page 70 of 83

HCATEMC_TEM-1124_May-17-2019

West Caldwell Calibration Laboratories Inc.

1575 State Route 96, Victor NY 14564
Tel. (585) 586-3900 FAX (585) 586-4327

Calibration Data Record

TEM Consulting LP Axial T Coil Probe
Company: PCTest Engineering Labs

for
Model No.: Axial T Coil Probe

Serial No.: TEM-1124

Test	Function	Tolerance	Measured values			
			Before	Out	Remarks	
1.0	Probe Sensitivity at	1000 Hz. dBV/A/m	-60.41			
2.0	Probe Level Linearity	dB				
		6	6.10			
		Ref. (0 dB)	0	0.00		
		-6	-6.00			
		-12	-12.00			
3.0	Probe Frequency Response	Hz				
		100	-19.9			
		126	-17.9			
		158	-16.0			
		200	-14.0			
		251	-12.0			
		316	-10.0			
		398	-8.0			
		501	-6.0			
		631	-3.9			
		794	-2.0			
		Ref. (0 dB)	1000	0.0		
			1259	2.0		
			1585	4.0		
			1995	5.9		
			2512	7.9		
			3162	9.9		
	3981	11.9				
	5012	13.9				
	6310	15.9				
	7943	18.0				
	10000	20.2				

Instruments used for calibration:			Date of Cal.	Traceability No.	Due Date
HP	34401A	S/N US360641	25-Jul-2018	,1010733	26-Jul-2019
HP	34401A	S/N US361024	25-Jul-2018	,1010733	26-Jul-2019
HP	33120A	S/N US360437	25-Jul-2018	,1010733	26-Jul-2019
B&K	2133	S/N 1583254	25-Jul-2018	683/290345-18	26-Jul-2019

Cal. Date: 17-May-2019

Tested by: James Zhu

Calibrated on WCCL system type 9700

This document shall not be reproduced, except in full, without the written approval from West Caldwell Cal. Labs. Inc.

Rev. 7.0 Jan. 24, 2014 Doc. # 1038 HCATEMC

FCC ID: PY7-57441Y		HAC (T-COIL) TEST REPORT	SONY	Approved by: Quality Manager
Filename: 1M2007070106-13-R3.PY7	Test Dates: 08/31/2020 - 09/22/2020	DUT Type: Portable Handset		Page 71 of 83

West Caldwell Calibration Laboratories Inc.

Certificate of Calibration

for

RADIAL T COIL PROBE

Manufactured by: TEM CONSULTING LP
 Model No: RADIAL T COIL PROBE
 Serial No: TEM-1129
 Calibration Recall No: 29156

Submitted By:

Customer: Andrew Harwell
 Company: PCTest Engineering Lab
 Address: 6660-B Dobbin Road
 Columbia MD 21045

The subject instrument was calibrated to the indicated specification using standards traceable to the National Institute of Standards and Technology or to accepted values of natural physical constants. This document certifies that the instrument met the following specification upon its return to the submitter.

West Caldwell Calibration Laboratories Procedure No. RADIAL T TEM C

Upon receipt for Calibration, the instrument was found to be:

Within (X)

tolerance of the indicated specification. See attached Report of Calibration.
 The information supplied relates to the calibrated item listed above.
 West Caldwell Calibration Laboratories' calibration control system meets the requirements, ISO 10012-1 MIL-STD-45662A, ANSI/NCSL Z540-1, IEC Guide 25, ISO 9001:2008 and ISO 17025.

JAH
12/4/2018

Note: With this Certificate, Report of Calibration is included.

Approved by: FC

Calibration Date: 19-Sep-18

Felix Christopher (QA Mgr.)

Certificate No: 29156 -1

ISO/IEC 17025:2005

QA Doc. #1051 Rev. 2.0 10/1/01

Certificate Page 1 of 1

West Caldwell Calibration Laboratories, Inc.
 uncompromised calibration
 1575 State Route 96, Victor, NY 14564, U.S.A.



Calibration Lab. Cert. # 1533.01

FCC ID: PY7-57441Y		HAC (T-COIL) TEST REPORT	SONY	Approved by: Quality Manager
Filename: 1M2007070106-13-R3.PY7	Test Dates: 08/31/2020 - 09/22/2020	DUT Type: Portable Handset		Page 72 of 83



REPORT OF CALIBRATION

for

TEM Consulting LP Radial T Coil Probe
Company: PCTest Engineering Lab

Model No.: Radial T Coil Probe

Serial No.: TEM-1129
I. D. No.: XXXX

Calibration results:			
Probe Sensitivity measured with Helmholtz Coil			
<i>Helmholtz Coil;</i>			
the number of turns on each coil;	10	No.	Before & after data same: ...X...
the radius of each coil, in meters;	0.204	m	
the current in the coils, in amperes.;	0.08	A	
<i>Helmholtz Coil Constant;</i>	7.09	A/m/V	Laboratory Environment:
<i>Helmholtz Coil magnetic field;</i>	5.95	A/m	Ambient Temperature: 22.7 °C
			Ambient Humidity: 52.1 % RH
			Ambient Pressure: 99.326 kPa
			Calibration Date: 19-Sep-2018
Probe Sensitivity at	1000	Hz.	Re-calibration Due:
was	-60.37	dBV/A/m	Report Number: 29156 -1
	0.958	mV/A/m	Control Number: 29156
Probe resistance	886	Ohms	

The above listed instrument meets or exceeds the tested manufacturer's specifications.

This Calibration is traceable through NIST test numbers: 683/284413-14

The expanded uncertainty of calibration: 0.30dB at 95% confidence level with a coverage factor of k=2.

Graph represents Probes Frequency Response.

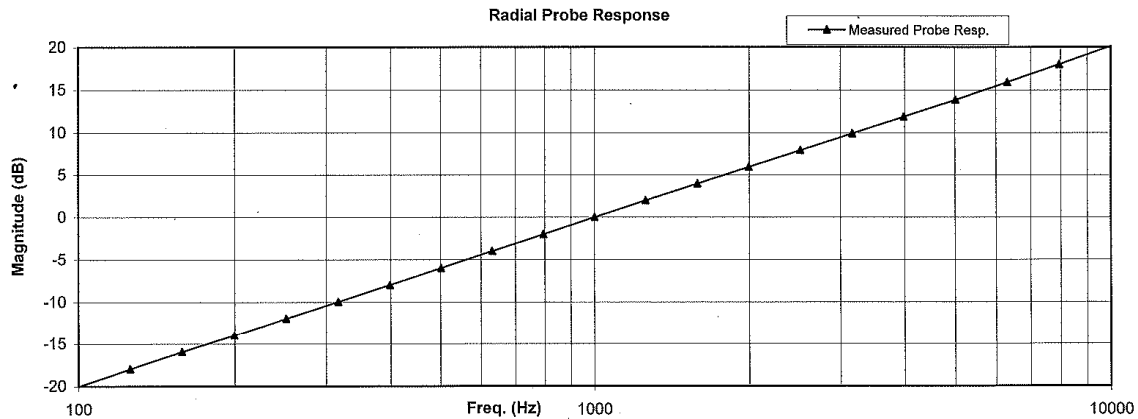

The above listed instrument was checked using calibration procedure documented in West Caldwell Calibration Laboratories Inc. procedure : Rev. 7.0 Jan. 24, 2014 Doc. # 1038 HCRTEMC
Calibration was performed by West Caldwell Calibration Laboratories Inc. under Operating Procedures intended to implement the requirements of ISO10012-1, IEC Guide 25, ANSI/NCSS Z540-1, (MIL-STD-45662A) and ISO 9001:2008, ISO 17025

Cal. Date: 19-Sep-2018
Calibrated on WCCL system type 9700

Measurements performed by: James Zhu

This document shall not be reproduced, except in full, without the written approval from West Caldwell Cal. Labs, Inc.

Rev. 7.0 Jan. 24, 2014 Doc. # 1038 HCRTEMC

FCC ID: PY7-57441Y		HAC (T-COIL) TEST REPORT		Approved by: Quality Manager
Filename: 1M2007070106-13-R3.PY7	Test Dates: 08/31/2020 - 09/22/2020	DUT Type: Portable Handset		Page 73 of 83

HCRTEMC_TEM-1129_Sep-19-2018

West Caldwell Calibration Laboratories Inc.

1575 State Route 96, Victor NY 14564
Tel. (585) 586-3900 FAX (585) 586-4327

Calibration Data Record

TEM Consulting LP Radial T Coil Probe
Company: PCTest Engineering Lab

for
Model No.: Radial T Coil Probe

Serial No.: TEM-1129

Test	Function	Tolerance	Measured values		
			Before	Out	Remarks
1.0	Probe Sensitivity at	1000 Hz. dBV/A/m	-60.37		
2.0	Probe Level Linearity	Ref. (0 dB)	dB		
			6	6.03	
			0	0.00	
			-6	-6.03	
			-12	-12.05	
3.0	Probe Frequency Response	Ref. (0 dB)	Hz		
			100	-20.0	
			126	-17.9	
			158	-15.9	
			200	-14.0	
			251	-12.0	
			316	-10.0	
			398	-8.0	
			501	-6.0	
			631	-4.0	
			794	-2.0	
			1000	0.0	
			1259	2.0	
			1585	4.0	
			1995	6.0	
			2512	7.9	
			3162	9.9	
3981	11.9				
5012	13.9				
6310	15.9				
7943	18.0				
10000	20.1				

Instruments used for calibration:				Date of Cal.	Traceability No.	Due Date
HP	34401A	S/N US360641	25-Jul-2018	,287708	25-Jul-2019	
HP	34401A	S/N US361024	25-Jul-2018	,287708	25-Jul-2019	
HP	33120A	S/N US360437	25-Jul-2018	,287708	25-Jul-2019	
B&K	2133	S/N 1583254	25-Jul-2018	683/284413-14	25-Jul-2019	

Cal. Date: 19-Sep-2018

Tested by: James Zhu

Calibrated on WCCL system type 9700

This document shall not be reproduced, except in full, without the written approval from West Caldwell Cal. Labs. Inc.

Rev. 7.0 Jan. 24, 2014 Doc. # 1038 HCRTEMC

Page 2 of 2

FCC ID: PY7-57441Y		HAC (T-COIL) TEST REPORT	SONY	Approved by: Quality Manager
Filename: 1M2007070106-13-R3.PY7	Test Dates: 08/31/2020 - 09/22/2020	DUT Type: Portable Handset		Page 74 of 83

© 2020 PCTEST

REV 3.5.M
8/18/2020

© 2020 PCTEST All rights reserved. Unless otherwise specified, no part of this report may be reproduced or utilized in any part, form or by any means, electronic or mechanical, including photocopying and microfilm, without permission in writing from PCTEST. If you have any questions about this international copyright or have an enquiry about obtaining additional rights to this report or assembly of contents thereof, please contact INFO@PCTEST.COM.

West Caldwell Calibration Laboratories Inc.

Certificate of Calibration

for

RADIAL T COIL PROBE

Manufactured by: TEM CONSULTING
Model No: RADIAL T COIL PROBE
Serial No: TEM-1130
Calibration Recall No: 29973

Submitted By:

Customer: ANDREW HARWELL
Company: PCTEST ENGINEERING LAB
Address: 6660-B DOBBIN ROAD
COLUMBIA MD 21045

The subject instrument was calibrated to the indicated specification using standards traceable to the National Institute of Standards and Technology or to accepted values of natural physical constants. This document certifies that the instrument met the following specification upon its return to the submitter.

West Caldwell Calibration Laboratories Procedure No. RADIAL T TEM C

Upon receipt for Calibration, the instrument was found to be:

Within (X)

tolerance of the indicated specification. See attached Report of Calibration.

The information supplied relates to the calibrated item listed above.

West Caldwell Calibration Laboratories' calibration control system meets the requirements, ISO 10012-1 MIL-STD-45662A, ANSI/NCSL Z540-1, IEC Guide 25, ISO 9001:2015 and ISO 17025.

Note: With this Certificate, Report of Calibration is included.

Approved by:

James Zhu

Calibration Date: 17-May-19

Certificate No: 29973 -2

Quality Manager
ISO/IEC 17025:2005

QA Doc. #1051 Rev. 2.0 10/101

Certificate Page 1 of 1

**West Caldwell
Calibration
Laboratories, Inc.**
uncompromised calibration
1575 State Route 96, Victor, NY 14584, U.S.A.



Calibration Lab. Cert. # 1533.01

FCC ID: PY7-57441Y		HAC (T-COIL) TEST REPORT	SONY	Approved by: Quality Manager
Filename: 1M2007070106-13-R3.PY7	Test Dates: 08/31/2020 - 09/22/2020	DUT Type: Portable Handset		Page 75 of 83

© 2020 PCTEST

REV 3.5.M
8/18/2020

© 2020 PCTEST All rights reserved. Unless otherwise specified, no part of this report may be reproduced or utilized in any part, form or by any means, electronic or mechanical, including photocopying and microfilm, without permission in writing from PCTEST. If you have any questions about this international copyright or have an enquiry about obtaining additional rights to this report or assembly of contents thereof, please contact INFO@PCTEST.COM.



ISO/IEC 17025: 2005



Calibration Lab. Cert. # 1533.01

REPORT OF CALIBRATION

for

TEM Consulting LP Radial T Coil Probe
Company: PCTest Engineering Labs

Model No.: Radial T Coil Probe

Serial No.: TEM-1130
I. D. No.: XXXX

Calibration results:			
Probe Sensitivity measured with Helmholtz Coil			
<i>Helmholtz Coil;</i>			
the number of turns on each coil;	10	No.	Before & after data same: ...X...
the radius of each coil, in meters;	0.204	m	
the current in the coils, in amperes.;	0.08	A	
<i>Helmholtz Coil Constant;</i>	7.09	A/m/V	Laboratory Environment:
<i>Helmholtz Coil magnetic field;</i>	5.94	A/m	Ambient Temperature: 20.7 °C
			Ambient Humidity: 42.7 % RH
			Ambient Pressure: 98.256 kPa
			Calibration Date: 17-May-2019
			Calibration Due: 17-May-2020
			Report Number: 29973 -2
			Control Number: 29973
Probe Sensitivity at	1000	Hz.	
was	-60.37	dBV/A/m	
	0.958	mV/A/m	
Probe resistance	895	Ohms	

The above listed instrument meets or exceeds the tested manufacturer's specifications.

This Calibration is traceable through NIST test numbers: 683/290345-18

The expanded uncertainty of calibration: 0.30dB at 95% confidence level with a coverage factor of K=2.

Graph represents Probes Frequency Response.

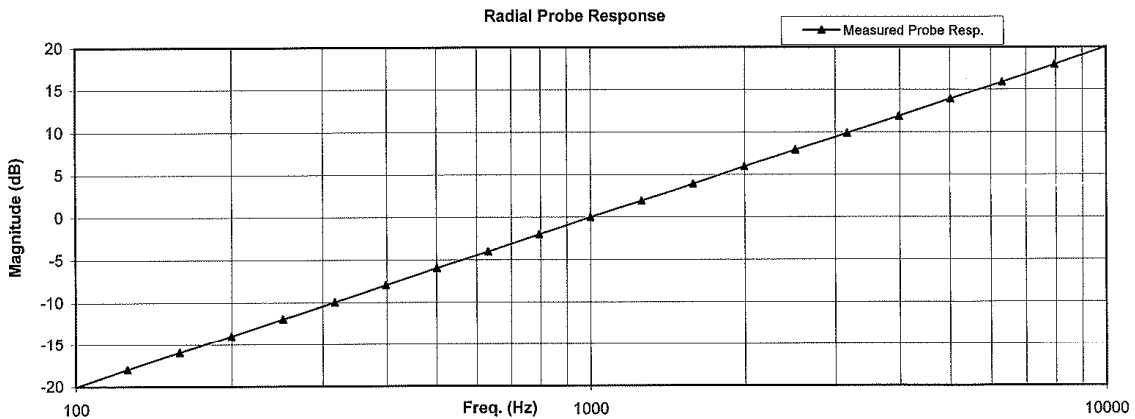

The above listed instrument was checked using calibration procedure documented in West Caldwell

Calibration Laboratories Inc. procedure :

Rev. 7.0 Jan. 24, 2014 Doc. # 1038 HCRTEMC

Calibration was performed by West Caldwell Calibration Laboratories Inc. under Operating Procedures

intended to implement the requirements of ISO10012-1, IEC Guide 25, ANSI/NCSL Z540-1, (MIL-STD-45662A) and ISO 17025

Cal. Date: 17-May-2019

Measurements performed by: *James Zhu*

Calibrated on WCCL system type 9700

James Zhu

This document shall not be reproduced, except in full, without the written approval from West Caldwell Cal. Labs. Inc.

Rev. 7.0 Jan. 24, 2014 Doc. # 1038 HCRTEMC

FCC ID: PY7-57441Y	PCTEST Proud to be part of	HAC (T-COIL) TEST REPORT	SONY	Approved by: Quality Manager
Filename: 1M2007070106-13-R3.PY7	Test Dates: 08/31/2020 - 09/22/2020	DUT Type: Portable Handset		Page 76 of 83

HCRTEMC_TEM-1130_May-17-2019

West Caldwell Calibration Laboratories Inc.

1575 State Route 96, Victor NY 14564
Tel. (585) 586-3900 FAX (585) 586-4327

Calibration Data Record

TEM Consulting LP Radial T Coil Probe for Model No.: Radial T Coil Probe Serial No.: TEM-1130
Company: PCTest Engineering Labs

Test	Function	Tolerance	Measured values		
			Before	Out	Remarks
1.0	Probe Sensitivity at	1000 Hz. dBV/A/m	-60.37		
2.0	Probe Level Linearity	Ref. (0 dB)	dB		
			6	6.00	
			0	0.00	
			-6	-6.10	
3.0	Probe Frequency Response	Ref. (0 dB)	Hz		
			100	-20.0	
			126	-17.9	
			158	-16.0	
			200	-14.0	
			251	-12.0	
			316	-10.0	
			398	-8.0	
			501	-6.0	
			631	-4.0	
			794	-2.0	
			1000	0.0	
			1259	1.9	
			1585	3.9	
			1995	5.9	
			2512	7.9	
			3162	9.9	
3981	11.9				
5012	13.9				
6310	15.9				
7943	18.0				
10000	20.1				

Instruments used for calibration:				Date of Cal.	Traceability No.	Due Date
HP	34401A	S/N US360641	25-Jul-2018	,1010733	26-Jul-2019	
HP	34401A	S/N US361024	25-Jul-2018	,1010733	26-Jul-2019	
HP	33120A	S/N US360437	25-Jul-2018	,1010733	26-Jul-2019	
B&K	2133	S/N 1583254	25-Jul-2018	683/290345-18	26-Jul-2019	

Cal. Date: 17-May-2019
Calibrated on WCCL system type 9700

Tested by: James Zhu

This document shall not be reproduced, except in full, without the written approval from West Caldwell Cal. Labs. Inc.

Rev. 7.0 Jan. 24, 2014 Doc. # 1038 HCRTEMC

FCC ID: PY7-57441Y		HAC (T-COIL) TEST REPORT	SONY	Approved by: Quality Manager
Filename: 1M2007070106-13-R3.PY7	Test Dates: 08/31/2020 - 09/22/2020	DUT Type: Portable Handset		Page 77 of 83

13. CONCLUSION

The measurements indicate that the wireless communications device complies with the HAC limits specified in accordance with the ANSI C63.19 Standard and FCC WT Docket No. 01-309 RM-8658. Precise laboratory measures were taken to assure repeatability of the tests. The tested device complies with the requirements in respect to all parameters specific to the test. The test results and statements relate only to the item(s) tested.

The measurement system and techniques presented in this evaluation are proposed in the ANSI standard as a means of best approximating wireless device compatibility with a hearing-aid. The literature is under continual re-construction.

FCC ID: PY7-57441Y	 PCTEST <small>Head to be part of</small>	HAC (T-COIL) TEST REPORT	SONY	Approved by: Quality Manager
Filename: 1M2007070106-13-R3.PY7	Test Dates: 08/31/2020 - 09/22/2020	DUT Type: Portable Handset		Page 78 of 83

© 2020 PCTEST

REV 3.5.M
8/18/2020

© 2020 PCTEST All rights reserved. Unless otherwise specified, no part of this report may be reproduced or utilized in any part, form or by any means, electronic or mechanical, including photocopying and microfilm, without permission in writing from PCTEST. If you have any questions about this international copyright or have an enquiry about obtaining additional rights to this report or assembly of contents thereof, please contact INFO@PCTEST.COM.

14. REFERENCES

1. ANSI C63.19-2011, American National Standard for Methods of Measurement of Compatibility between Wireless communication devices and Hearing Aids., New York, NY, IEEE, May 2011
2. FCC Office of Engineering and Technology KDB, "285076 D01 HAC Guidance v05," September 13, 2017
3. FCC Office of Engineering and Technology KDB, "285076 D02 T-Coil Testing for CMRS IP v03," September 13, 2017
4. FCC Public Notice DA 06-1215, *Wireless Telecommunications Bureau and Office of Engineering and Technology Clarify Use of Revised Wireless Phone Hearing Aid Compatibility Standard*, June 6, 2006
5. FCC 3G Review Guidance, Laboratory Division OET FCC, May/June 2006
6. Berger, H. S., "Compatibility Between Hearing Aids and Wireless Devices," Electronic Industries Forum, Boston, MA, May, 1997
7. Berger, H. S., "Hearing Aid and Cellular Phone Compatibility: Working Toward Solutions," *Wireless Telephones and Hearing Aids: New Challenges for Audiology*, Gallaudet University, Washington, D.C., May, 1997 (To be reprinted in the American Journal of Audiology).
8. Berger, H. S., "Hearing Aid Compatibility with Wireless Communications Devices," IEEE International Symposium on Electromagnetic Compatibility, Austin, TX, August, 1997.
9. Bronaugh, E. L., "Simplifying EMI Immunity (Susceptibility) Tests in TEM Cells," in the 1990 IEEE International Symposium on Electromagnetic Compatibility Symposium Record, Washington, D.C., August 1990, pp. 488-491
10. Byrne, D. and Dillon, H., The National Acoustics Laboratory (NAL) New Procedure for Selecting the Gain and Frequency Response of a Hearing Aid, Ear and Hearing 7:257-265, 1986.
11. Crawford, M. L., "Measurement of Electromagnetic Radiation from Electronic Equipment using TEM Transmission Cells," U.S. Department of Commerce, National Bureau of Standards, NBSIR 73-306, Feb. 1973.
12. Crawford, M. L., and Workman, J. L., "Using a TEM Cell for EMC Measurements of Electronic Equipment," U.S. Department of Commerce, National Bureau of Standards. Technical Note 1013, July 1981.
13. EHIMA GSM Project, Development phase, Project Report (1st part) Revision A. Technical-Audiological Laboratory and Telecom Denmark, October 1993.
14. EHIMA GSM Project, Development phase, Part II Project Report. Technical-Audiological Laboratory and Telecom Denmark, June 1994.
15. EHIMA GSM Project Final Report, Hearing Aids and GSM Mobile Telephones: Interference Problems, Methods of Measurement and Levels of Immunity. Technical-Audiological Laboratory and Telecom Denmark, 1995.
16. HAMPIS Report, Comparison of Mobile phone electromagnetic near field with an upscaled electromagnetic far field, using hearing aid as reference, 21 October 1999.
17. Hearing Aids/GSM, Report from OTWIDAM, Technical-Audiological Laboratory and Telecom Denmark, April 1993.
18. IEEE 100, The Authoritative Dictionary of IEEE Standards Terms, Seventh Edition.
19. Joyner, K. H, et. al., Interference to Hearing Aids by the New Digital Mobile Telephone System, Global System for Mobile (GSM) Communication Standard, National Acoustic Laboratory, Australian Hearing Series, Sydney 1993.
20. Joyner, K. H., et. al., Interference to Hearing Aids by the Digital Mobile Telephone System, Global System for Mobile Communications (GSM), NAL Report #131, National Acoustic Laboratory, Australian Hearing Series, Sydney, 1995.
21. Kecker, W. T., Crawford, M. L., and Wilson, W. A., "Construction of a Transverse Electromagnetic Cell", U.S. Department of Commerce, National Bureau of Standards, Technical Note 1011, Nov. 1978.
22. Konigstein, D., and Hansen, D., "A New Family of TEM Cells with enlarged bandwidth and Optimized working Volume," in the Proceedings of the 7th International Symposium on EMC, Zurich, Switzerland, March 1987; 50:9, pp. 127-132.

FCC ID: PY7-57441Y		HAC (T-COIL) TEST REPORT	SONY	Approved by: Quality Manager
Filename: 1M2007070106-13-R3.PY7	Test Dates: 08/31/2020 - 09/22/2020	DUT Type: Portable Handset		Page 79 of 83

© 2020 PCTEST

REV 3.5.M
8/18/2020

© 2020 PCTEST All rights reserved. Unless otherwise specified, no part of this report may be reproduced or utilized in any part, form or by any means, electronic or mechanical, including photocopying and microfilm, without permission in writing from PCTEST. If you have any questions about this international copyright or have an enquiry about obtaining additional rights to this report or assembly of contents thereof, please contact INFO@PCTEST.COM.

23. Kuk, F., and Hjorstgaard, N. K., "Factors affecting interference from digital cellular telephones," Hearing Journal, 1997; 50:9, pp 32-34.
24. Ma, M. A., and Kanda, M., "Electromagnetic Compatibility and Interference Metrology," U.S. Department of Commerce, National Bureau of Standards, Technical Note 1099, July 1986, pp. 17-43.
25. Ma, M. A., Sreenivashiah, I. , and Chang, D. C., "A Method of Determining the Emission and Susceptibility Levels of Electrically Small Objects Using a TEM Cell," U.S. Department of Commerce, National Bureau of Standards, Technial Note 1040, July 1981.
26. McCandless, G. A., and Lyregaard, P. E., Prescription of Gain/Output (POGO) for Hearing Aids, Hearing Instruments 1:16-21, 1983
27. Skopec, M., "Hearing Aid Electromagnetic Interference from Digital Wireless Telephones, "IEEE Transactions on Rehabilitation Engineering, vol. 6, no. 2, pp. 235-239, June 1998.
28. Technical Report, GSM 05.90, GSM EMC Considerations, European Telecommunications Standards Institute, January 1993.
29. Victorian, T. A., "Digital Cellular Telephone Interference and Hearing Aid Compatibility—an Update," Hearing Journal 1998; 51:10, pp. 53-60
30. Wong, G. S. K., and Embleton, T. F. W., eds., AIP Handbook of Condenser Microphones: Theory, Calibration and Measurements, AIP Press.

FCC ID: PY7-57441Y	 PCTEST <small>Head to be part of</small>	HAC (T-COIL) TEST REPORT	SONY	Approved by: Quality Manager
Filename: 1M2007070106-13-R3.PY7	Test Dates: 08/31/2020 - 09/22/2020	DUT Type: Portable Handset		Page 80 of 83

© 2020 PCTEST

REV 3.5.M
8/18/2020

© 2020 PCTEST All rights reserved. Unless otherwise specified, no part of this report may be reproduced or utilized in any part, form or by any means, electronic or mechanical, including photocopying and microfilm, without permission in writing from PCTEST. If you have any questions about this international copyright or have an enquiry about obtaining additional rights to this report or assembly of contents thereof, please contact INFO@PCTEST.COM.