

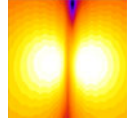

# ELEMENT

7185 Oakland Mills Road, Columbia, MD 21046 USA  
Tel. 410.290.6652 / Fax 410.290.6654  
http://www.pctest.com



## HEARING AID COMPATIBILITY

**Applicant Name:**  
SONY CORPORATION  
1-7-1 Konan Minato-ku  
Tokyo, 108-0075, Japan

**Date of Testing:**  
3/21/2022 – 6/6/2022  
**Test Site/Location:**  
ELEMENT, Columbia, MD, USA  
**Test Report Serial No.:**  
1M2206010068-05-R4.PY7  
**Date of Issue:**  
6/27/2022

<b>FCC ID:</b>	<b>PY7-57325M</b>
<b>APPLICANT:</b>	<b>SONY CORPORATION</b>

**Scope of Test:** Audio Band Magnetic Testing (T-Coil)  
**Application Type:** Class II Permissive Change  
**FCC Rule Part(s):** CFR §20.19(b)  
**HAC Standard:** ANSI C63.19-2011  
 285076 D01 HAC Guidance v05  
 285076 D02 T-Coil testing for CMRS IP v03

**DUT Type:** Portable Handset  
**Model:** 57325M  
**Test Device Serial No.:** Pre-Production Sample [S/N: 05JAZ, 00GC5, 05HAZ]  
**Class II Permissive Change(s):** See FCC Change Document

<b>C63.19-2011 HAC Category:</b>	<b>T4 (SIGNAL TO NOISE CATEGORY)</b>
----------------------------------	--------------------------------------

Note: This revised Test Report (S/N: 1M2206010068-05-R4.PY7) supersedes and replaces the previously issued test report on the same subject device for the same type of testing as indicated. Please discard or destroy the previously issued test report(s) and dispose of it accordingly.

This wireless portable device has been shown to be hearing-aid compatible under the above rated category, specified in ANSI/IEEE Std. C63.19-2011 and has been tested in accordance with the specified measurement procedures. Test results reported herein relate only to the item(s) tested. Hearing-Aid Compatibility is based on the assumption that all production units will be designed electrically identical to the device tested in this report. North American Bands only.

I attest to the accuracy of data. All measurements reported herein were performed by me or were made under my supervision and are correct to the best of my knowledge and belief. I assume full responsibility for the completeness of these measurements and vouch for the qualifications of all persons taking them.

RJ Ortanez  
Vice President



<b>FCC ID:</b> PY7-57325M		<b>HAC (T-COIL) TEST REPORT</b>	<b>SONY</b>	<b>Approved by:</b> Quality Manager
<b>Filename:</b> 1M2206010068-05-R4.PY7	<b>Test Dates:</b> 3/21/2022 – 6/6/2022	<b>DUT Type:</b> Portable Handset		Page 1 of 88

# TABLE OF CONTENTS

---

1.	INTRODUCTION .....	3
2.	DUT DESCRIPTION.....	4
3.	ANSI C63.19-2011 PERFORMANCE CATEGORIES .....	6
4.	METHOD OF MEASUREMENT .....	8
5.	VOLTE TEST SYSTEM SETUP AND DUT CONFIGURATION .....	18
6.	OTT VOIP TEST SYSTEM AND DUT CONFIGURATION .....	22
7.	FCC 3G MEASUREMENTS .....	31
8.	T-COIL TEST SUMMARY .....	32
9.	MEASUREMENT UNCERTAINTY .....	47
10.	EQUIPMENT LIST.....	48
11.	TEST DATA.....	49
12.	CALIBRATION CERTIFICATES.....	76
13.	CONCLUSION.....	83
14.	REFERENCES .....	84
15.	TEST SETUP PHOTOGRAPHS .....	86

<b>FCC ID:</b> PY7-57325M		<b>HAC (T-COIL) TEST REPORT</b>	<b>SONY</b>	<b>Approved by:</b> Quality Manager
<b>Filename:</b> 1M2206010068-05-R4.PY7	<b>Test Dates:</b> 3/21/2022 – 6/6/2022	<b>DUT Type:</b> Portable Handset		Page 2 of 88

# 1. INTRODUCTION

On July 10, 2003, the Federal Communications Commission (FCC) adopted new rules requiring wireless manufacturers and service providers to provide digital wireless phones that are compatible with hearing aids. The FCC has modified the exemption for wireless phones under the Hearing Aid Compatibility Act of 1998 (HAC Act) in WT Docket 01-309 RM-8658<sup>1</sup> to extend the benefits of wireless telecommunications to individuals with hearing disabilities. These benefits encompass business, social and emergency communications, which increase the value of the wireless network for everyone. An estimated more than 10% of the population in the United States show signs of hearing impairment and of that fraction, almost 80% use hearing aids. Approximately 500 million people worldwide and 30 million people in the United States suffer from hearing loss.

## Compatibility Tests Involved:

The standard calls for wireless communications devices to be measured for:

- RF Electric-field emissions
- T-coil mode, magnetic-signal strength in the audio band
- T-coil mode, magnetic-signal frequency response through the audio band
- T-coil mode, magnetic-signal and noise articulation index

The hearing aid must be measured for:

- RF immunity in microphone mode
- RF immunity in T-coil mode

In the following tests and results, this report includes the evaluation for a wireless communications device.

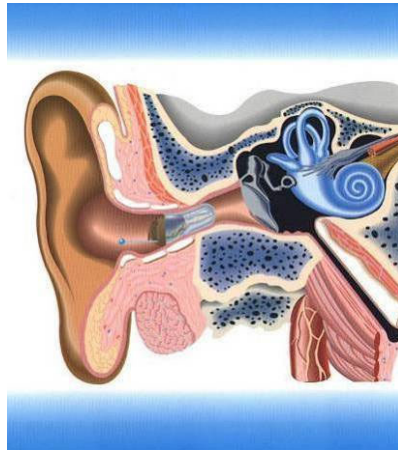



Figure 1-1 Hearing Aid *in-vitu*

<sup>1</sup> FCC Rule & Order, WT Docket 01-309 RM-8658

FCC ID: PY7-57325M		HAC (T-COIL) TEST REPORT	<b>SONY</b>	Approved by: Quality Manager
Filename: 1M2206010068-05-R4.PY7	Test Dates: 3/21/2022 – 6/6/2022	DUT Type: Portable Handset		Page 3 of 88

## 2. DUT DESCRIPTION





FCC ID: PY7-57325M  
Applicant: SONY CORPORATION  
1-7-1 Konan Minato-ku  
Tokyo, 108-0075, Japan  
Model: 57325M  
Serial Number: 05JAZ, 00GC5, 05HAZ  
HW Version: A  
SW Version: 0.1144  
Antenna: Internal Antenna  
DUT Type: Portable Handset

### I. LTE Band Selection

This device supports LTE capabilities with overlapping transmission frequency ranges. When the supported frequency range of an LTE band falls completely within an LTE band with a larger transmission frequency range, both LTE bands have the same target power (or the band with the larger transmission frequency range has a higher target power), and both LTE bands share the same transmission path and signal characteristics, hearing-aid compatibility compliance was only assessed for the band with the larger transmission frequency range. However, overlapped LTE bands which are anchor bands for dual connectivity (EN-DC) scenarios between LTE and NR were evaluated as independent LTE bands.



### II. Device Serial Numbers

Several samples with identical hardware were used to support HAC testing. The manufacturer has confirmed that the device(s) tested have the same physical, mechanical, and thermal characteristics are within operational tolerances expected for production units. The serial numbers used for each test are indicated alongside the results in Section 8.

FCC ID: PY7-57325M		HAC (T-COIL) TEST REPORT		Approved by: Quality Manager
Filename: 1M2206010068-05-R4.PY7	Test Dates: 3/21/2022 – 6/6/2022	DUT Type: Portable Handset		Page 4 of 88

**Table 2-1  
PY7-57325M HAC Air Interfaces**

Air-Interface	Band (MHz)	Type Transport	HAC Tested	Simultaneous But Not Tested	Name of Voice Service	Audio Codec Evaluated
GSM	850	VO	Yes	Yes: WIFI or BT	CMRS Voice <sup>1</sup>	EFR
	1900					
UMTS	GPRS/EDGE	VD	Yes	Yes: WIFI or BT	Google Duo <sup>2</sup>	OPUS
	850	VD	Yes	Yes: WIFI or BT	CMRS Voice <sup>1</sup>	NB AMR, WB AMR
	1700					
	1900					
HSPA	VD	Yes	Yes: WIFI or BT	Google Duo <sup>2</sup>	OPUS	
LTE (FDD)	680 (B71)	VD	Yes <sup>3</sup>	Yes: NR, WIFI or BT	VoLTE <sup>1</sup> , Google Duo <sup>2</sup>	VoLTE: NB AMR, WB AMR, EVS Google Duo: OPUS
	700 (B12)					
	700 (B17)					
	780 (B13)					
	850 (B5)					
	1700 (B4)					
	1700 (B66)					
	1900 (B2)					
1900 (B25)						
LTE (TDD)	2600 (B38)	VD	Yes	Yes: NR, WIFI or BT	VoLTE <sup>1</sup> , Google Duo <sup>2</sup>	VoLTE: NB AMR, WB AMR, EVS Google Duo: OPUS
	2600 (B41)					
	3600 (B48)					
NR (FDD)	680 (n71)	VD	Yes <sup>3,4</sup>	Yes: LTE, WIFI or BT	Google Duo <sup>2</sup>	OPUS
	850 (n5)					
	1700 (n66)					
	1900 (n2)					
NR (TDD)	2600 (n41)	VD	Yes <sup>4</sup>	Yes: LTE, WIFI or BT	Google Duo <sup>2</sup>	OPUS
	3700 (n77)					
WIFI	2450	VD	Yes <sup>5,6</sup>	Yes: GSM, UMTS, LTE, or NR	Google Duo <sup>2</sup>	Google Duo: OPUS
	5200 (U-NII 1)					
	5300 (U-NII 2A)					
	5500 (U-NII 2C)					
	5800 (U-NII 3)					
6175 (U-NII 5)						
WIFI	6475 (U-NII 6)	DT	No <sup>6</sup>	Yes: GSM, UMTS, LTE, or NR	N/A	N/A
	6700 (U-NII 7)					
	7000 (U-NII 8)					
BT	2450	DT	No	Yes: GSM, UMTS, LTE, or NR	N/A	N/A
Type Transport VO = Voice Only DT = Digital Data - Not intended for Voice Services VD = CMRS and/or IP Voice over Data Transport			Notes: 1. Reference level in accordance with 7.4.2.1 of ANSI C63.19-2011 and July 2012 C63 VoLTE Interpretation. 2. Reference level is -20dBm0 in accordance with FCC KDB 285076 D02 3. LTE B71 and NR n71, while outside the scope of ANSI C63.19 and FCC HAC regulations, were additionally tested according to the existing HAC procedures with currently available test equipment. 4. NR was evaluated using an interim procedure outlined in Section 6.II.4. 5. WIFI U-NII band 5 was evaluated for operations which are entirely below 6 GHz. Operations partially or entirely above 6 GHz were not evaluated due to equipment limitations and being outside of the current scope of ANSI C63.19 and FCC HAC regulations. 6. WIFI U-NII bands 5 through 8 were not evaluated due to equipment limitations and being outside of the scope of ANSI C63.19 and FCC HAC regulations.			

FCC ID: PY7-57325M		HAC (T-COIL) TEST REPORT		Approved by: Quality Manager
Filename: 1M2206010068-05-R4.PY7	Test Dates: 3/21/2022 – 6/6/2022	DUT Type: Portable Handset	Page 5 of 88	

### 3. ANSI C63.19-2011 PERFORMANCE CATEGORIES

#### I. MAGNETIC COUPLING

##### Axial and Radial Field Intensity

All orientations of the magnetic field, in the axial and radial position along the measurement plane shall be  $\geq -18$  dB(A/m) at 1 kHz in a 1/3 octave band filter per §8.3.1.

##### Frequency Response

The frequency response of the axial component of the magnetic field shall follow the response curve specified in EIA RS-504-1983, over the frequency range 300 Hz – 3000 Hz per §8.3.2.

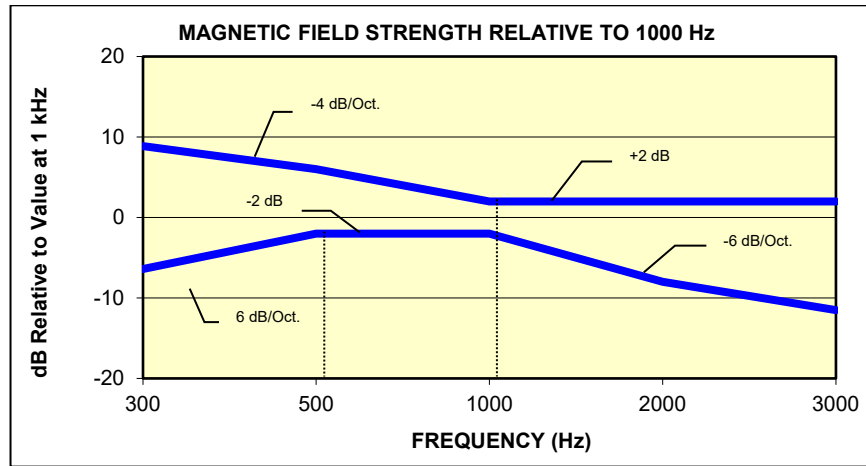

**Figure 3-1**  
Magnetic field frequency response for Wireless Devices with an axial field  $\leq -15$  dB(A/m) at 1 kHz

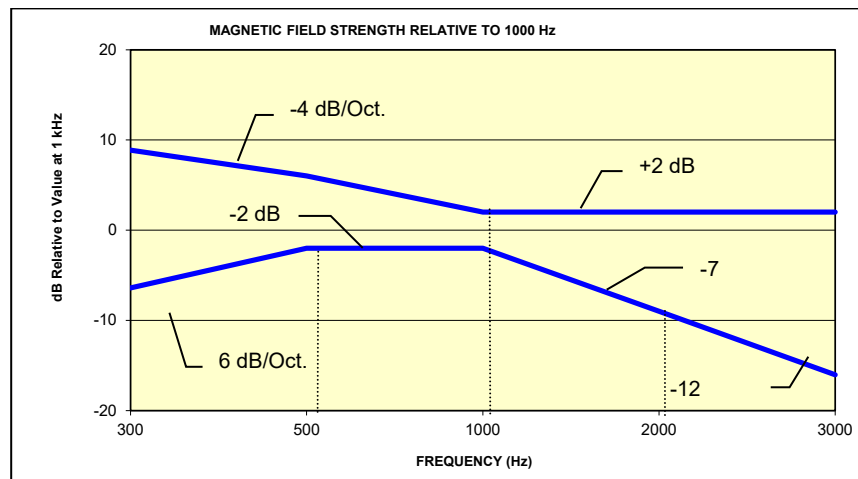

**Figure 3-2**  
Magnetic Field frequency response for wireless devices with an axial field that exceeds  $-15$  dB(A/m) at 1 kHz

FCC ID: PY7-57325M		HAC (T-COIL) TEST REPORT		Approved by: Quality Manager
Filename: 1M2206010068-05-R4.PY7	Test Dates: 3/21/2022 – 6/6/2022	DUT Type: Portable Handset		Page 6 of 88

## Signal Quality

The table below provides the signal quality requirement for the intended audio magnetic signal from a wireless device. Only the RF immunity of the hearing aid is measured in T-coil mode. It is assumed that a hearing aid can have no immunity to an interference signal in the audio band, which is the intended reception band for this mode. The only criterion that can be measured is the RF immunity in T-coil mode. This is measured using the same procedure as the audio coupling mode at the same levels.

The signal quality of the axial and radial components of the magnetic field was used to determine the T-coil mode category.

Category	Telephone RF Parameters
	Wireless Device Signal Quality [(Signal + Noise)-to-noise ratio in dB]
T1	0 to 10 dB
T2	10 to 20 dB
T3	20 to 30 dB
T4	> 30 dB

Table 3-1  
**Magnetic Coupling Parameters**

Note: The FCC limit for SNNR is 20dB and the test data margins will indicate a margin from the FCC limit for compliance.

FCC ID: PY7-57325M		HAC (T-COIL) TEST REPORT	<b>SONY</b>	Approved by: Quality Manager
Filename: 1M2206010068-05-R4.PY7	Test Dates: 3/21/2022 – 6/6/2022	DUT Type: Portable Handset		Page 7 of 88

## 4. METHOD OF MEASUREMENT

### I. Test Setup

The equipment was connected as shown in an RF-shielded chamber:

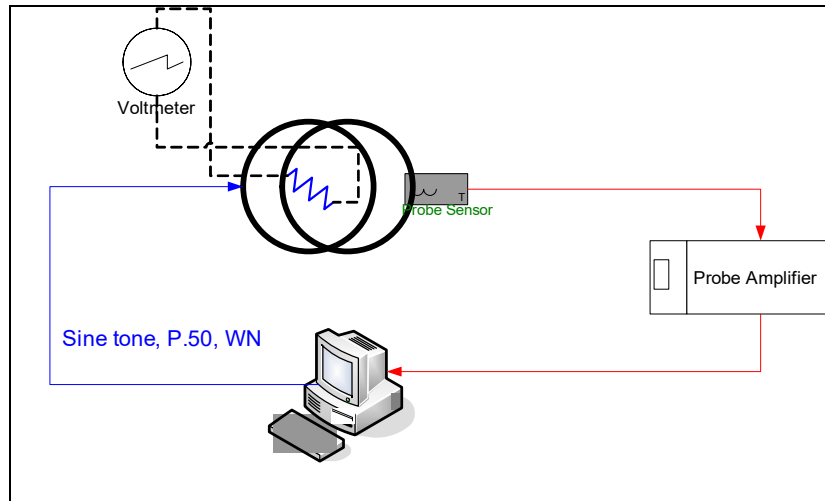

**Figure 4-1**  
**Validation Setup with Helmholtz Coil**

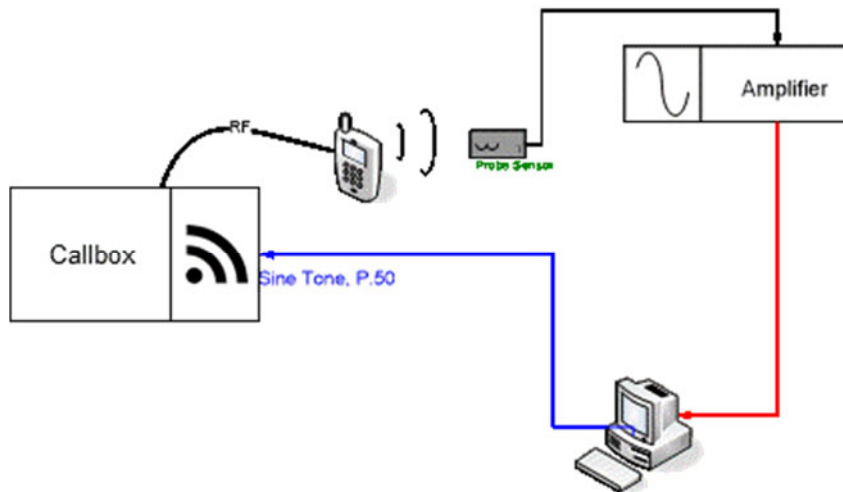

**Figure 4-2**  
**T-Coil Test Setup**

FCC ID: PY7-57325M		HAC (T-COIL) TEST REPORT	<b>SONY</b>	Approved by: Quality Manager
Filename: 1M2206010068-05-R4.PY7	Test Dates: 3/21/2022 – 6/6/2022	DUT Type: Portable Handset		Page 8 of 88



## II. Scanning Mechanism

Manufacturer:	TEM
Accuracy:	± 0.83 cm/meter
Minimum Step Size:	0.1 mm
Maximum speed	6.1 cm/sec
Line Voltage:	115 VAC
Line Frequency:	60 Hz
Material Composite:	Delrin (Acetal)
Data Control:	Parallel Port
Dynamic Range (X-Y-Z):	45 x 31.75 x 47 cm
Dimensions:	36" x 25" x 38"
Operating Area:	36" x 49" x 55"
Reflections:	< -20 dB (in anechoic chamber)

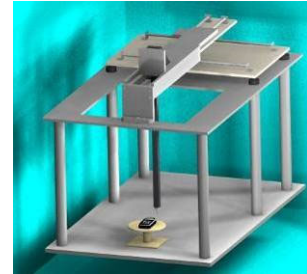

**Figure 4-3**  
RF Near-Field Scanner

## III. ITU-T P.50 Artificial Voice

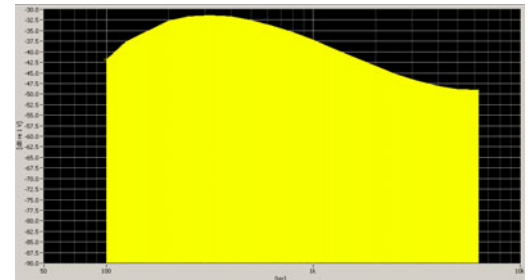

Manufacturer:	ITU-T
Active Frequency Range:	100 Hz – 8 kHz
Stimulus Type:	Male and Female, no spaces
Single Sample Duration:	20.96 seconds
Activity Level:	100%

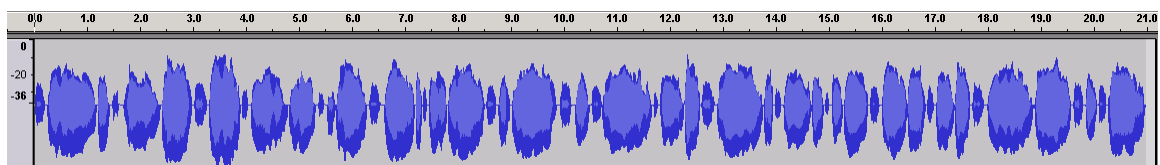

**Figure 4-4**  
Spectral Characteristic of full P.50



**Figure 4-5**  
Temporal Characteristic of full P.50

FCC ID: PY7-57325M		HAC (T-COIL) TEST REPORT		Approved by: Quality Manager
Filename: 1M2206010068-05-R4.PY7	Test Dates: 3/21/2022 – 6/6/2022	DUT Type: Portable Handset		Page 9 of 88

ABM1 Measurement Block Diagram:

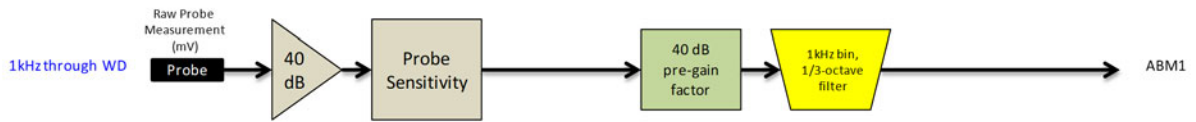

ABM2 Measurement Block Diagram:

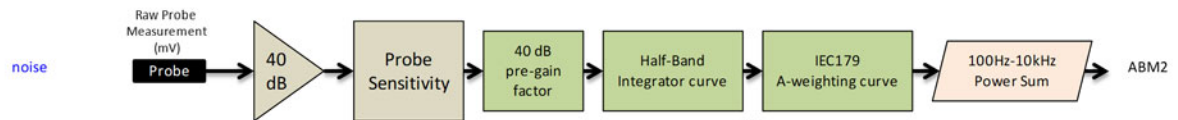

Figure 4-6 Magnetic Measurement Processing Steps

## IV. Test Procedure

1. Ambient Noise Check per C63.19 §7.3.1
  - a. Ambient interference was monitored using a Real-Time Analyzer between 100-10,000 Hz with 1/3 octave filtering.
  - b. “A-weighting” and Half-Band Integration was applied to the measurements.
  - c. Since this measurement was measured in the same method as ABM2 measurements, this level was verified to be more than 10 dB below the lowest measurement signal (which is the highest ABM2 measurement for a T4 WD). Therefore the maximum noise level for a T4 WD with an ABM1 = -18 dBA/m is:  

$$-18 - 30 - 10 = -58 \text{ dBA/m}$$
2. Measurement System Validation (See Figure 4-1)
  - a. The measurement system including the probe, pre-amplifier and acquisition system were validated as an entire system to ensure the reliability of test measurements.
  - b. ABM1 Validation  
 The magnetic field at the center of the Helmholtz coil is given by the equation (per C63.19 Annex D.10.1):

$$H_c = \frac{NI}{r\sqrt{1.25^3}} = \frac{N\left(\frac{V}{R}\right)}{r\sqrt{1.25^3}}$$



Where  $H_c$  = magnetic field strength in amperes per meter

N = number of turns per coil

For Helmholtz Coil SN: SBI 1052, N=20; r=0.13m; R=10.193Ω and using V=29mV:

$$H_c = \frac{20 \cdot \left(\frac{0.029}{10.193}\right)}{0.13 \cdot \sqrt{1.25^3}} = 0.316 \text{ A/m} \approx -10 \text{ dB(A/m)}$$

Therefore a pure tone of 1kHz was applied into the coils such that 29mV was observed across the resistor. The voltmeter used for measurement was verified to be capable of measurements in the audio band range. This theoretically generates an expected field of -10 dB(A/m) in the center of the Helmholtz coil which was used to validate the probe measurement at -10dB(A/m). This was verified to be within ± 0.5 dB of the -10dB(A/m) value (see Page 44).

FCC ID: PY7-57325M		HAC (T-COIL) TEST REPORT		Approved by: Quality Manager
Filename: 1M2206010068-05-R4.PY7	Test Dates: 3/21/2022 – 6/6/2022	DUT Type: Portable Handset		Page 10 of 88

c. Frequency Response Validation

The frequency response through the Helmholtz Coil was verified to be within 0.5 dB relative to 1kHz, between 300 – 3000 Hz using the P.50 signal as shown below:

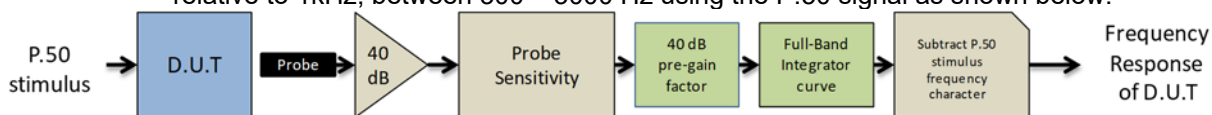

Figure 4-7 Frequency Response Validation

d. ABM2 Measurement Validation

WD noise measurements are filtered with A-weighting and Half-Band Integration over a frequency range of 100Hz – 10kHz to process ABM2 measurements. Below is the verification of the system processing A-weighting and Half-Band integration between system input to output within 0.5 dB of the theoretical result:

Table 4-1  
ABM2 Frequency Response Validation

f (Hz)	HBI, A - Measured (dB re 1kHz)	HBI, A - Theoretical (dB re 1kHz)	dB Var.
100	-16.180	-16.170	-0.010
125	-13.257	-13.250	-0.007
160	-10.347	-10.340	-0.007
200	-8.017	-8.010	-0.007
250	-5.925	-5.920	-0.005
315	-4.045	-4.040	-0.005
400	-2.405	-2.400	-0.005
500	-1.212	-1.210	-0.002
630	-0.349	-0.350	0.001
800	0.071	0.070	0.001
1000	0.000	0.000	0.000
1250	-0.503	-0.500	-0.003
1600	-1.513	-1.510	-0.003
2000	-2.778	-2.780	0.002
2500	-4.316	-4.320	0.004
3150	-6.166	-6.170	0.004
4000	-8.322	-8.330	0.008
5000	-10.573	-10.590	0.017
6300	-13.178	-13.200	0.022
8000	-16.241	-16.270	0.029
10000	-19.495	-19.520	0.025

FCC ID: PY7-57325M		HAC (T-COIL) TEST REPORT	<b>SONY</b>	Approved by: Quality Manager
Filename: 1M2206010068-05-R4.PY7	Test Dates: 3/21/2022 – 6/6/2022	DUT Type: Portable Handset		Page 11 of 88

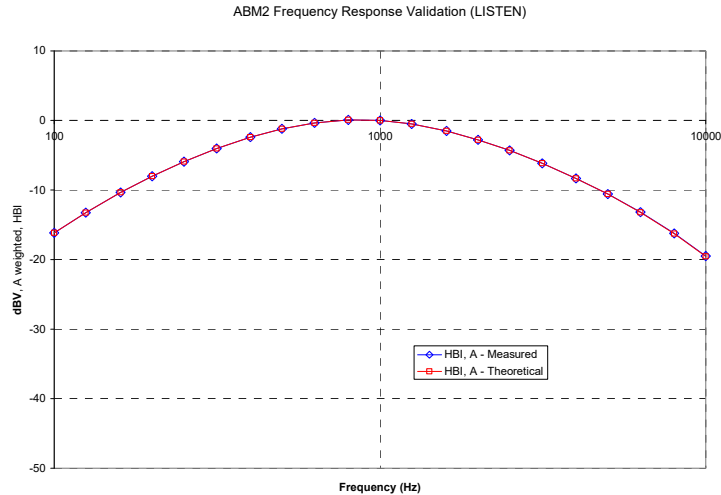

**Figure 4-8**  
**ABM2 Frequency Response Validation**

The ABM2 result is a power sum from 100Hz to 10kHz with half-band integration and A-weighting. To verify the power sum measurement, a power sum over the full band was measured and verified to track with the source level (See Figure 4-9). Therefore the setup in this step was used to verify the power sum post-processing for ABM2 measurements. See below block diagram:

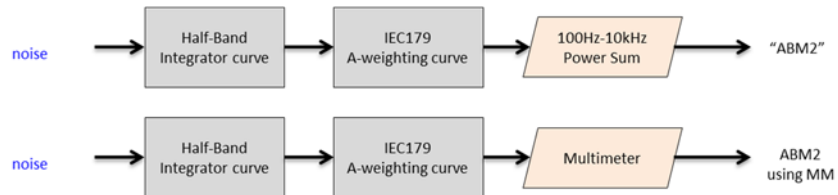

**Figure 4-9**  
**ABM2 Validation Block Diagram**

The power summed output results for a known input were compared to the multi-meter results to verify any deviation in the post-processing implemented with the power-sum.

**Table 4-2**  
**ABM2 Power Sum Validation**

WN Input (dBV)	Power Sum (dBV)	Multimeter-Full (dBV)	Dev (dB)
-60	-60.36	-60.2	0.16
-50	-50.19	-50.13	0.06
-40	-40.14	-40.03	0.11
-30	-30.13	-30.01	0.12
-20	-20.12	-20	0.12
-10	-10.14	-10	0.14

FCC ID: PY7-57325M		HAC (T-COIL) TEST REPORT		Approved by: Quality Manager
Filename: 1M2206010068-05-R4.PY7	Test Dates: 3/21/2022 – 6/6/2022	DUT Type: Portable Handset		Page 12 of 88

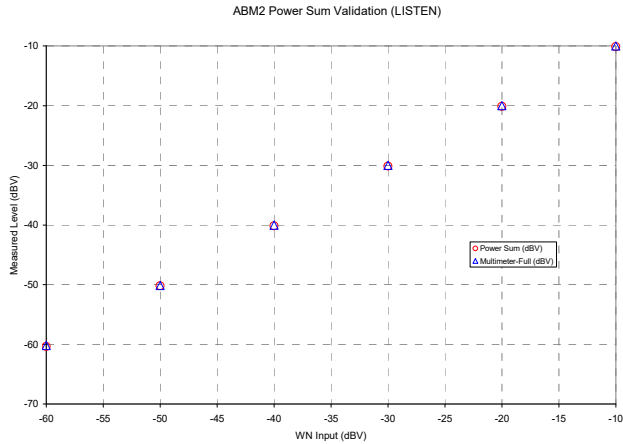
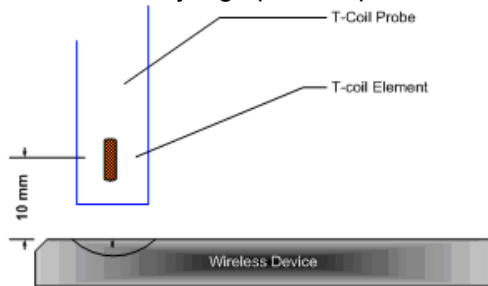

**Figure 4-10**  
**ABM2 Power Sum Validation**

3. Measurement Test Setup

a. Fine scan above the WD (TEM)

- i. A multitone signal was applied to the handset such that the phone acoustic output was stable within 1dB over the probe settling time and with the acoustic output level at the C63.19 specified levels (below). The measurement step size was in 2 mm increments at a distance of 10 mm between the surface of the wireless device as shown below (note that in Figure 4-12, the grid is not to scale but merely a graphical representation of the coordinate system in use):



**Figure 4-11**  
**Measurement Distance**

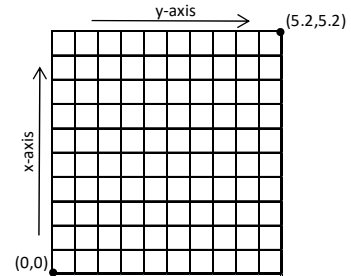

**Figure 4-12**  
**Measurement Grid**

- ii. After scanning, the planar field maximum point was determined. The position of the probe was moved to this location to setup the test using the SoundCheck system.
  - iii. These steps were repeated for all T-coil orientations (axial and radial) per Figure 4-14 after a T-coil orientation was fully measured with the SoundCheck system.
- b. Speech Signal Setup to Base Station Simulator
- i. C63.19 Table 7-1 states audio reference input levels for various technologies:

Standard	Technology	Input Level (dBm0)
TIA/EIA/IS-2000	CDMA	-18
J-STD-007	GSM (217)	-16
T1/T1P1/3GPP	UMTS (WCDMA)	-16
IDEN™	TDMA (22 and 11 Hz)	-18

FCC ID: PY7-57325M		HAC (T-COIL) TEST REPORT		Approved by: Quality Manager
Filename: 1M2206010068-05-R4.PY7	Test Dates: 3/21/2022 – 6/6/2022	DUT Type: Portable Handset		Page 13 of 88

- ii. See Section 5 for more information regarding CMW500 audio level settings for Voice Over LTE (VoLTE) testing.
    - iii. See Section 6 for more information regarding audio level settings for Over-The-Top (OTT) Voice Over IP (VoIP) Testing.
  - c. Real-Time Analyzer (RTA)
    - i. The Real-Time Analyzer was configured to analyze measurements using 1/3 Octave band weighted filtering.
  - d. WD Radio Configuration Selection
    - i. The device was chosen to be tested in the worst-case ABM2 condition (See Section 7 for more information regarding worst-case configurations for UMTS. LTE configuration information can be found in Section 5 and 6. NR configuration information can be found in Section 6. WIFI configuration information can be found in Section 6.)
    - ii. Supported GSM vocoders were investigated for the worst-case ABM2 condition. GSM-EFR was deemed the worst-case condition for the GSM air interface.
- 4. Signal Quality Data Analysis
  - a. Narrow-band Magnetic Intensity
    - i. The standard specifies a 1kHz 1/3 octave band minimum field intensity for a sine tone. The ABM1 measurements were evaluated at 1kHz with 1/3 octave band filtering over an averaged period of 10 seconds.
  - b. Frequency Response
    - i. The appropriate frequency response curve was measured to curves in Figure 3-1 or Figure 3-2 between 300 – 3000 Hz using digital linear averaging (limit lines chosen according to measurement found in step 4a). A linear average over 3x the length of the artificial voice signal (3x sampling) was performed. A 10 second delay was configured in the measurement process of the stimulus to ensure handset vocoder latency effects and echo cancellation devices (if any) were appropriately stabilized during measurements.
    - ii. The appropriate post-processing was applied according to the system processing chain illustrated in Figure 4-7. All R10 frequencies were plotted with respect to 0dB at 1kHz value and aligned with respect to the EIA-504 mask.
    - iii. The margin is represented by the closest measured data point on the curve to the EIA-504 limit lines, in dB.
  - c. Signal Quality Index
    - i. Ensuring the WD was at maximum RF power, maximum volume, backlight off, display on, maximum contrast setting, keypad lights on (when possible) with no audio signal through the vocoder, the WD was measured over at least 100 Hz – 10,000 Hz, maximized over 5 seconds with a 50ms sample time for the ABM2 measurement (5 second time period is used in noise measurements under standards such as IEEE 269, etc.).
    - ii. After applying half-band integration and A-weighting to the result, a power sum was applied over each 1/3 octave bandwidth frequency for an ABM2 value.
    - iii. This result was subtracted from the ABM1 result in step a, to obtain the Signal Quality.

FCC ID: PY7-57325M		HAC (T-COIL) TEST REPORT	<b>SONY</b>	Approved by: Quality Manager
Filename: 1M2206010068-05-R4.PY7	Test Dates: 3/21/2022 – 6/6/2022	DUT Type: Portable Handset		Page 14 of 88

## V. Test Setup

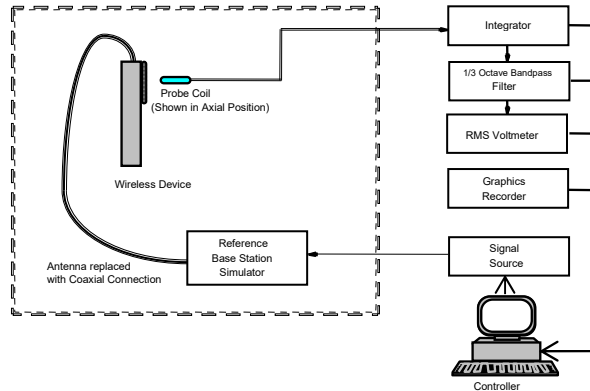

**Figure 4-13**  
**Audio Magnetic Field Test Setup**



Environmental conditions such as temperature and relative humidity are monitored to ensure there are no impacts on system specifications. Proper voltage and power line frequency conditions are maintained with three phase power sources. Environmental noise and reflections are monitored through system checks.

## VI. Deviation from C63.19 Test Procedure

Non-conducted RF connection due to inaccessible RF ports.

## VII. Air Interface Technologies Tested

All air interfaces which support voice capabilities over a managed CMRS or pre-installed OTT VoIP applications were tested for T-coil unless otherwise noted. See Table 2-1 for more details regarding which modes were tested.

FCC ID: PY7-57325M		HAC (T-COIL) TEST REPORT		Approved by: Quality Manager
Filename: 1M2206010068-05-R4.PY7	Test Dates: 3/21/2022 – 6/6/2022	DUT Type: Portable Handset		Page 15 of 88

## VIII. Wireless Device Channels and Frequencies

### 1. 2G/3G Modes

The frequencies listed in the table below are those that lie in the center of the bands used for cellular telephony. Low, middle and high channels were tested in each band for FCC compliance evaluation to ensure the maximum emission is captured across the entire band. Only middle channels were evaluated for data modes.

**Table 4-3  
Center Channels and Frequencies**

Test frequencies & associated channels	
Channel	Frequency (MHz)
<b>Cellular 850</b>	
190 (GSM)	836.60
4183 (UMTS)	836.60
<b>AWS 1750</b>	
1412 (UMTS)	1730.40
<b>PCS 1900</b>	
661 (GSM)	1880
9400 (UMTS)	1880

### 2. 4G (LTE) Modes

The middle channel for every band and bandwidth combination was tested for each probe orientation. The band and bandwidth combination from each probe orientation resulting in the worst-case SNNR was additionally tested using low and high channels for that band and bandwidth combination. Low-mid and mid-high channels were additionally tested for LTE TDD. The middle channels and supported bandwidths from the worst-case band according to Table 6-5 and 6-6 were additionally evaluated with OTT VoIP for each probe orientation. See Tables 8-4 to 8-18 as well as 8-21 and 8-22 for LTE bandwidths and channels.

### 3. 5G (NR) Modes

The middle channel and supported bandwidths from the worst-case NR FDD band according to Table 6-10 was evaluated with OTT VoIP for each probe orientation. NR TDD was additionally evaluated with OTT VoIP for each probe orientation according to Table 6-11. The band and bandwidth combination from each probe orientation resulting in the worst-case SNNR was additionally tested using low and high channels for that band and bandwidth combination. Low-mid and mid-high channels were additionally tested for NR TDD. See Tables 8-23 and 8-25 for NR bandwidths and channels.

### 4. WIFI

The middle channel for each IEEE 802.11 standard was tested for each probe orientation. The 2.4GHz IEEE 802.11 standard from each probe orientation resulting in the worst-case SNNR was additionally tested using low and high channels. The 5GHz IEEE 802.11 standard from each probe orientation resulting in the worst-case SNNR was additionally tested on higher U-NII bands as well as applicable low and high channels. See Tables 8-27 to 8-31 for WIFI standards and channels.

FCC ID: PY7-57325M		HAC (T-COIL) TEST REPORT	<b>SONY</b>	Approved by: Quality Manager
Filename: 1M2206010068-05-R4.PY7	Test Dates: 3/21/2022 – 6/6/2022	DUT Type: Portable Handset		Page 16 of 88



## IX. Test Flow

The flow diagram below was followed (From C63.19):

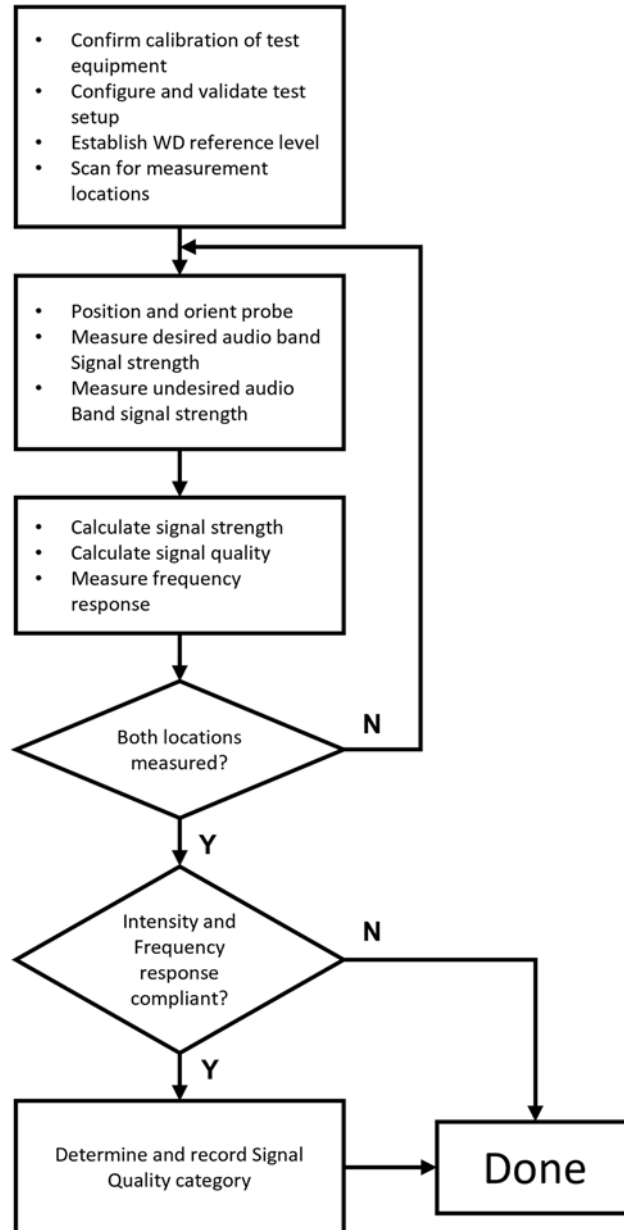

**Figure 4-14**  
**C63.19 T-Coil Signal Test Process**

FCC ID: PY7-57325M		HAC (T-COIL) TEST REPORT	<b>SONY</b>	Approved by: Quality Manager
Filename: 1M2206010068-05-R4.PY7	Test Dates: 3/21/2022 – 6/6/2022	DUT Type: Portable Handset		Page 17 of 88

## 5. VOLTE TEST SYSTEM SETUP AND DUT CONFIGURATION

### I. Test System Setup for VoLTE over IMS T-coil Testing

#### 1. Equipment Setup

The general test setup used for VoLTE over IMS is shown below. The callbox used when performing VoLTE over IMS T-coil measurements is a CMW500. The Data Application Unit (DAU) of the CMW500 was used to simulate the IP Multimedia Subsystem (IMS) server.

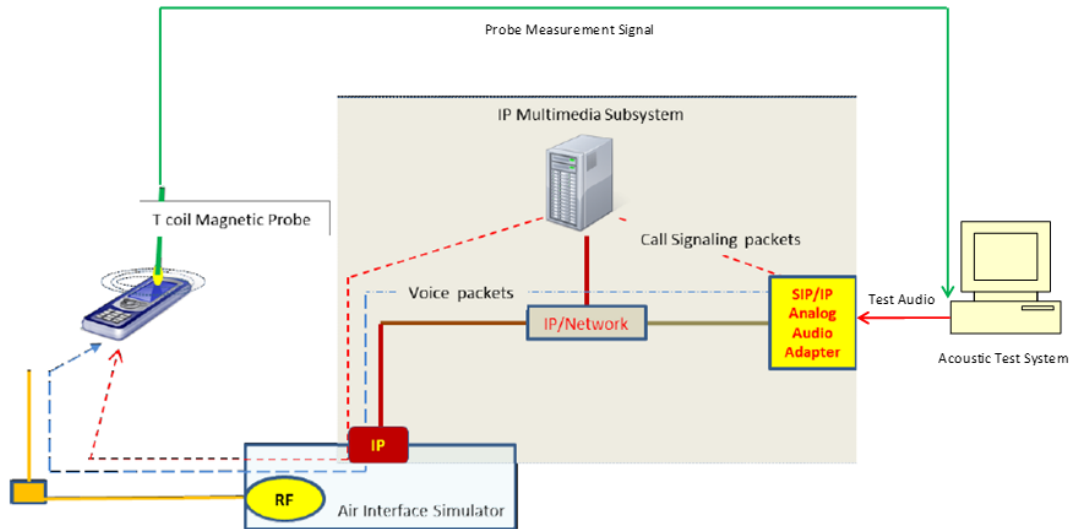



**Figure 5-1**  
**Test Setup for VoLTE over IMS T-Coil Measurements**

#### 2. Audio Level Settings

According to the July 2012 interpretations by the C63 Committee regarding the appropriate audio levels to be used for VoLTE over IMS T-coil testing, -16dBm0 shall be used for the normal speech input level\*. The CMW500 base station simulator was manually configured to ensure that the settings for speech input and full scale levels resulted in the -16dBm0 speech input level to the DUT for the VoLTE over IMS connection.

\* [http://c63.org/documents/misc/posting/new\\_interpretations.htm](http://c63.org/documents/misc/posting/new_interpretations.htm)

FCC ID: PY7-57325M		HAC (T-COIL) TEST REPORT		Approved by: Quality Manager
Filename: 1M2206010068-05-R4.PY7	Test Dates: 3/21/2022 – 6/6/2022	DUT Type: Portable Handset		Page 18 of 88

© 2022 ELEMENT

REV 3.5.M  
8/18/2020

© 2022 ELEMENT All rights reserved. Unless otherwise specified, no part of this report may be reproduced or utilized in any part, form or by any means, electronic or mechanical, including photocopying and microfilm, without permission in writing from ELEMENT. If you have any questions about this international copyright or have an enquiry about obtaining additional rights to this report or assembly of contents thereof, please contact CT.INFO@ELEMENT.COM.

## II. DUT Configuration for VoLTE over IMS T-coil Testing

### 1. Radio Configuration

An investigation was performed to determine the modulation and RB configuration to be used for testing. The effects of modulation and RB configuration were found to be independent of band and bandwidth; therefore, only one band and bandwidth were used for this investigation. 16QAM, 1RB, 50%RB offset was used for the testing as the worst-case configuration for the handset. See below table for SNNR comparison between different radio configurations:

**Table 5-1**  
**VoLTE over IMS SNNR by Radio Configuration**



Band	Frequency [MHz]	Channel	Bandwidth [MHz]	Modulation	RB Size	RB Offset	ABM1 [dB(A/m)]	ABM2 [dB(A/m)]	SNNR [dB]
66	1745.0	132322	20	QPSK	1	0	5.73	-47.82	53.55
66	1745.0	132322	20	QPSK	1	50	5.97	-45.88	51.85
66	1745.0	132322	20	QPSK	1	99	5.74	-45.92	51.66
66	1745.0	132322	20	QPSK	50	0	5.77	-51.53	57.30
66	1745.0	132322	20	QPSK	50	25	6.08	-53.39	59.47
66	1745.0	132322	20	QPSK	50	50	6.00	-51.65	57.65
66	1745.0	132322	20	QPSK	100	0	5.85	-53.20	59.05
66	1745.0	132322	20	16QAM	1	0	6.01	-42.26	48.27
66	1745.0	132322	20	16QAM	1	50	6.00	-38.80	44.80
66	1745.0	132322	20	16QAM	1	99	5.62	-39.51	45.13
66	1745.0	132322	20	16QAM	50	0	6.02	-50.76	56.78
66	1745.0	132322	20	16QAM	50	25	5.91	-49.84	55.75
66	1745.0	132322	20	16QAM	50	50	5.87	-49.06	54.93
66	1745.0	132322	20	16QAM	100	0	5.94	-51.24	57.18
66	1745.0	132322	20	64QAM	1	0	5.93	-43.27	49.20
66	1745.0	132322	20	64QAM	1	50	5.95	-40.25	46.20
66	1745.0	132322	20	64QAM	1	99	5.86	-40.56	46.42
66	1745.0	132322	20	64QAM	50	0	5.82	-49.79	55.61
66	1745.0	132322	20	64QAM	50	25	5.86	-50.46	56.32
66	1745.0	132322	20	64QAM	50	50	5.90	-49.68	55.58
66	1745.0	132322	20	64QAM	100	0	5.81	-51.18	56.99

### 2. Codec Configuration

An investigation was performed to determine the audio codec configuration to be used for testing. The effects of codec configuration were found to be independent of radio configuration; therefore, only one radio configuration was used for this investigation. The WB AMR 6.60kbps setting was used for the audio codec on the CMW500 for VoLTE over IMS T-coil testing. See below table for comparisons between different codecs and codec data rates:

**Table 5-2**  
**AMR Codec Investigation – VoLTE over IMS**

Codec Setting:	WB AMR 23.85kbps	WB AMR 6.60kbps	NB AMR 12.2kbps	NB AMR 4.75kbps	Orientation	Band / BW	Channel
ABM1 (dBA/m)	7.15	5.89	8.02	8.02	Axial	LTE B66 20MHz	132322
ABM2 (dBA/m)	-42.40	-42.81	-42.89	-42.98			
Frequency Response	Pass	Pass	Pass	Pass			
S+N/N (dB)	49.55	48.70	50.91	51.00			

FCC ID: PY7-57325M		HAC (T-COIL) TEST REPORT		Approved by: Quality Manager
Filename: 1M2206010068-05-R4.PY7	Test Dates: 3/21/2022 – 6/6/2022	DUT Type: Portable Handset		Page 19 of 88

**Table 5-3**  
**EVS Codec Investigation - VoLTE over IMS**

Codec Setting:	EVS Primary SWB 13.2kbps	EVS Primary SWB 9.6kbps	EVS Primary WB 13.2kbps	EVS Primary WB 5.9kbps	EVS Primary NB 13.2kbps	EVS Primary NB 5.9kbps	Orientation	Band / BW	Channel
ABM1 (dBA/m)	8.17	7.68	8.08	6.92	8.60	7.91	Axial	LTE B66 20MHz	132322
ABM2 (dBA/m)	-42.33	-42.45	-42.43	-42.26	-42.51	-42.39			
Frequency Response	Pass	Pass	Pass	Pass	Pass	Pass			
S+N/N (dB)	50.50	50.13	50.51	49.18	51.11	50.30			

- Mute on; Backlight off; Max Volume; Max Contrast
- TPC = "Max Power"

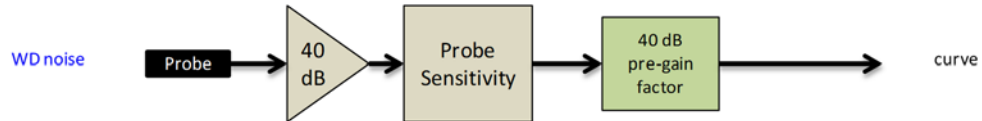

**Figure 5-2**  
**Audio Band Magnetic Curve Measurement Block Diagram**

### 3. LTE TDD Uplink-Downlink Configuration Investigation for VoLTE over IMS

An investigation was performed to determine the worst-case Uplink-Downlink configuration for VoLTE over IMS T-Coil testing.

Per 3GPP TS 36.211, the total frame length for each TDD radio frame of length  $T_f = 307200 \cdot T_s = 10$  ms, where  $T_s$  is a number of time units equal to  $1/(15000 \times 2048)$  seconds. Additionally, each radio frame consists of 10 subframes, each of length  $30720 \cdot T_s = 1$  ms, and subframes can be designated as uplink (U), downlink (D), or special subframe (S), depending on the Uplink-Downlink configuration as indicated in Table 4.2-2 of 3GPP TS 36.211. In the transmission duty factor calculation, the special subframe configuration with the shortest UpPTS duration within the special subframe is used and will be applied for measurement. From 3GPP TS 36.211 Table 4.2-1, the shortest UpPTS is  $2192 \cdot T_s$  which occurs in the normal cyclic prefix and special subframe configuration 4.

See table below outlining the calculated transmission duty cycles for each Uplink-Downlink configuration:

**Table 5-4**  
**Uplink-Downlink Configurations for Type 2 Frame Structures**

Uplink-downlink configuration	Downlink-to-Uplink Switch-point periodicity	Subframe number										Calculated Transmission Duty Cycle (%)
		0	1	2	3	4	5	6	7	8	9	
0	5 ms	D	S	U	U	U	D	S	U	U	U	61.4%
1	5 ms	D	S	U	U	D	D	S	U	U	D	41.4%
2	5 ms	D	S	U	D	D	D	S	U	D	D	21.4%
3	10 ms	D	S	U	U	U	D	D	D	D	D	30.7%
4	10 ms	D	S	U	U	D	D	D	D	D	D	20.7%
5	10 ms	D	S	U	D	D	D	D	D	D	D	10.7%
6	5 ms	D	S	U	U	U	D	S	U	U	D	51.4%

FCC ID: PY7-57325M		HAC (T-COIL) TEST REPORT		Approved by: Quality Manager
Filename: 1M2206010068-05-R4.PY7	Test Dates: 3/21/2022 – 6/6/2022	DUT Type: Portable Handset		Page 20 of 88

**a. Power Class 3 Uplink-Downlink Configuration Investigation**

Power Class 3 was evaluated with the following radio configuration: channel 40620, 20MHz BW, 16QAM, 1RB, 50%RB offset. For Power Class 3, all configurations (0-6) are supported. The configuration which resulted in the worst SNNR was used for full testing. Uplink-Downlink configuration 0 was used as the worst-case configuration for Power Class 3 VoLTE over IMS T-Coil testing. See table below for the SNNR comparison between each Uplink-Downlink configuration:

**Table 5-5  
Power Class 3 VoLTE over IMS SNNR by UL-DL Configuration**

Frequency [MHz]	Channel	Bandwidth [MHz]	Modulation	RB Size	RB Offset	UL-DL Configuration	ABM1 [dB(A/m)]	ABM2 [dB(A/m)]	SNNR [dB]
2593.0	40620	20	16QAM	1	50	0	5.70	-35.63	41.33
2593.0	40620	20	16QAM	1	50	1	5.96	-35.40	41.36
2593.0	40620	20	16QAM	1	50	2	6.05	-35.88	41.93
2593.0	40620	20	16QAM	1	50	3	5.89	-38.14	44.03
2593.0	40620	20	16QAM	1	50	4	6.03	-37.40	43.43
2593.0	40620	20	16QAM	1	50	5	6.03	-39.14	45.17
2593.0	40620	20	16QAM	1	50	6	6.03	-35.56	41.59

**b. Conclusion**

Per the investigations above, UL-DL Configuration 0 was used to evaluate Power Class 3 VoLTE over IMS.

FCC ID: PY7-57325M		HAC (T-COIL) TEST REPORT	<b>SONY</b>	Approved by: Quality Manager
Filename: 1M2206010068-05-R4.PY7	Test Dates: 3/21/2022 – 6/6/2022	DUT Type: Portable Handset		Page 21 of 88

## 6. OTT VOIP TEST SYSTEM AND DUT CONFIGURATION

### I. Test System Setup for OTT VoIP T-Coil Testing

#### 1. OTT VoIP Application

Google Duo is a pre-installed application on the DUT which allows for VoIP calls in a held-to-ear scenario. Duo uses the OPUS audio codec and supports a bitrate range of 6kb/s to 75kb/s. All air interfaces capable of a data connection were evaluated with Google Duo.

#### 2. Equipment Setup

A CMW500 callbox was used to perform OTT VoIP T-coil measurements. The Data Application Unit (DAU) of the CMW500 was connected to the internet and allowed for an IP data connection on the DUT. An auxiliary VoIP unit was used to initiate an OTT VoIP call to the DUT. The auxiliary VoIP unit allowed for the configuration and monitoring of the OTT VoIP codec bitrate during a call. Both high and low bitrate settings were evaluated in to determine the worst-case configuration.

#### 3. Audio Level Settings

According to KDB 285076 D02, the average speech level of -20dBm0 shall be used for protocols not specifically listed in Table 7.1 of ANSI C63.19-2011 or the ANSI C63.19-2011 VoLTE interpretation<sup>2</sup>. The auxiliary VoIP unit allowed for monitoring the signal input level to ensure that the settings for speech input and full scale levels resulted in the -20dBm0 speech input level to the DUT for the OTT VoIP call.

Note: The green highlighted text is approved by FCC under the TCB PAG Re-Use Policy 388624 D01 IV. D. for T-Coil Testing for WI-FI calling and Google Duo.

### II. DUT Configuration for OTT VoIP T-Coil Testing



#### 1. Codec Configuration

An investigation was performed for each applicable data mode to determine the audio codec configuration to be used for testing. The effects of codec configuration were found to be independent of radio configuration; therefore, only one radio configuration for each applicable data mode was used for these investigations. The 6kbps codec setting was used for the audio codec on the auxiliary VoIP unit for OTT VoIP T-Coil testing. See below tables for comparisons between codec data rates on all applicable data modes:

**Table 6-1**  
**Codec Investigation – OTT VoIP (EDGE)**

Codec Setting:	75kbps	6kbps	Orientation	Channel
ABM1 (dBA/m)	29.14	28.85	Axial	661
ABM2 (dBA/m)	-37.87	-37.02		
Frequency Response	Pass	Pass		
S+N/N (dB)	67.01	65.87		

<sup>2</sup> FCC Office of Engineering and Technology KDB, "285076 D02 T-Coil Testing for CMRS IP v03," September 13, 2017

FCC ID: PY7-57325M		HAC (T-COIL) TEST REPORT		Approved by: Quality Manager
Filename: 1M2206010068-05-R4.PY7	Test Dates: 3/21/2022 – 6/6/2022	DUT Type: Portable Handset		Page 22 of 88

**Table 6-2  
Codec Investigation – OTT VoIP (HSPA)**

Codec Setting:	75kbps	6kbps	Orientation	Channel
ABM1 (dBA/m)	29.29	28.88	Axial	9400
ABM2 (dBA/m)	-50.27	-50.03		
Frequency Response	Pass	Pass		
S+N/N (dB)	79.56	78.91		

**Table 6-3  
Codec Investigation – OTT VoIP (LTE)**

Codec Setting:	75kbps	6kbps	Orientation	Band / BW	Channel
ABM1 (dBA/m)	29.24	28.82	Axial	LTE B66 20MHz	132322
ABM2 (dBA/m)	-38.53	-37.75			
Frequency Response	Pass	Pass			
S+N/N (dB)	67.77	66.57			

**Table 6-4  
Codec Investigation – OTT VoIP (WIFI)**

Codec Setting:	75kbps	6kbps	Orientation	Band	Standard	Channel
ABM1 (dBA/m)	29.85	29.29	Axial	2.4GHz	IEEE802.11b	6
ABM2 (dBA/m)	-39.56	-39.80				
Frequency Response	Pass	Pass				
S+N/N (dB)	69.41	69.09				

- Mute on; Backlight off; Max Volume; Max Contrast
- Radio Configurations can be found in Section 8.II.F

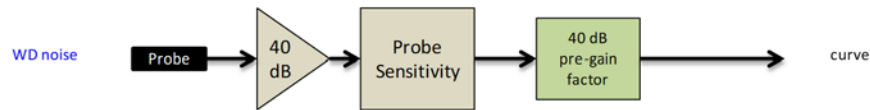

**Figure 6-1  
Audio Band Magnetic Curve Measurement Block Diagram**

FCC ID: PY7-57325M		HAC (T-COIL) TEST REPORT	<b>SONY</b>	Approved by: Quality Manager
Filename: 1M2206010068-05-R4.PY7	Test Dates: 3/21/2022 – 6/6/2022	DUT Type: Portable Handset		Page 23 of 88

## 2. Radio Configuration for OTT VoIP (LTE)

An investigation was performed to determine the worst-case LTE FDD band to be used for OTT VoIP testing. LTE FDD Band 2 was used for the testing as the worst-case configuration for the handset. See below table for SNNR comparison between different LTE FDD bands:

**Table 6-5**  
**OTT VoIP (LTE FDD) SNNR by LTE Band**

Band	Frequency [MHz]	Channel	Bandwidth [MHz]	Modulation	RB Size	RB Offset	ABM1 [dB(A/m)]	ABM2 [dB(A/m)]	SNNR [dB]
71	680.5	133297	20	16QAM	1	50	28.66	-43.07	71.73
12	707.5	23095	10	16QAM	1	25	28.78	-43.44	72.22
12 (ASDIV)	707.5	23095	10	16QAM	1	25	28.67	-39.81	68.48
13	782.0	23230	10	16QAM	1	25	28.79	-44.17	72.96
13 (ASDIV)	782.0	23230	10	16QAM	1	25	29.19	-42.19	71.38
5	836.5	20525	10	16QAM	1	25	28.89	-42.21	71.10
5 (ASDIV)	836.5	20525	10	16QAM	1	25	28.63	-42.73	71.36
4	1732.5	20175	20	16QAM	1	50	28.81	-39.99	68.80
66	1745.0	132322	20	16QAM	1	50	28.79	-37.94	66.73
2	1880.0	18900	20	16QAM	1	50	28.81	-37.31	66.12
25	1882.5	26365	20	16QAM	1	50	28.70	-37.88	66.58
7	2535.0	21100	20	16QAM	1	50	29.02	-38.80	67.82

An investigation was performed to determine the worst-case LTE TDD band to be used for OTT VoIP testing. LTE TDD Band 41 (PC3) was used for the testing as the worst-case configuration for the handset. See below table for SNNR comparison between different LTE TDD bands:

**Table 6-6**  
**OTT VoIP (LTE TDD) SNNR by LTE Band**



Band	Frequency [MHz]	Channel	Bandwidth [MHz]	Modulation	RB Size	RB Offset	ABM1 [dB(A/m)]	ABM2 [dB(A/m)]	SNNR [dB]
41 (PC3)	2593.0	40620	20	16QAM	1	50	28.97	-33.13	62.10
48	3625.0	55990	20	16QAM	1	50	29.13	-43.71	72.84

## 3. LTE FDD EN-DC Radio Configuration for OTT VoIP (LTE)

LTE FDD EN-DC was evaluated to ensure that the LTE standalone was the worst-case scenario. The configuration in Table 6-6 were determined from Table 6-5 and satisfy the configuration requirements as defined in 3GPP 36.101.

**Table 6-7**  
**LTE FDD SNNR for OTT VoIP LTE FDD EN-DC**

Combination	LTE							NR							ABM1 [dB(A/m)]	ABM2 [dB(A/m)]	SNNR [dB]	
	LTE Band	LTE Bandwidth [MHz]	LTE Channel	LTE Frequency [MHz]	Modulation	LTE # RB	LTE RB Offset	NR Band	NR Bandwidth [MHz]	NR Channel	NR Frequency [MHz]	Waveform	Modulation	NR # RB				NR RB Offset
LTE Band 66 EN-DC Sub	LTE B66	20	132322	1745.0	16QAM	1	50	NR n2	20	376000	1880.0	DFT-s-OFDM	16QAM	1	53	28.79	-46.70	75.49
LTE Band 2 EN-DC Sub	LTE B2	20	18900	1880.0	16QAM	1	50	NR n66	20	349000	1745.0	DFT-s-OFDM	16QAM	1	53	28.81	-45.47	74.28

FCC ID: PY7-57325M		HAC (T-COIL) TEST REPORT		Approved by: Quality Manager
Filename: 1M2206010068-05-R4.PY7	Test Dates: 3/21/2022 – 6/6/2022	DUT Type: Portable Handset		Page 24 of 88



#### 4. Interim Procedure for evaluation OTT VoIP (NR)

The following procedure is used to evaluate OTT VoIP (NR) given equipment limitations.

- a. This procedure is applicable for OTT VoIP (NR) voice calls that use the same protocol, codec(s), and reference level as OTT VoIP (LTE) (i.e. -20dBm0).
- b. Establish the  $ABM1_{NR}$  value by using the  $ABM1_{LTE}$  magnetic intensity for an LTE call using a correlating LTE band through existing procedures and test equipment.
- c. Establish an  $ABM2_{NR}$  value using factory test mode (FTM) to simulate a NR connection for the desired NR band and channel under test.
- d. The following information is documented in Section 9:
  - i.  $ABM2_{LTE}$  and  $ABM2_{NR}$  for respective tests.
  - ii. Calculate SNNR:
    1.  $ABM1 = ABM1_{LTE}$
    2.  $ABM2 = ABM2_{NR}$
    3.  $SNNR_{NR} = [ABM1_{LTE} - ABM2_{NR}] - 3dB$ 
      - a. A 3dB margin is built in to ensure conservative results with this interim procedure.

The above is only applicable for OTT VoIP scenarios, this device does not support VoNR over IMS.

The manufacturer has confirmed the handset as designed is expected to exhibit similar audio intensity levels between an OTT VoIP call placed over a 4G LTE and a 5G Sub-6GHz data connection.

FCC ID: PY7-57325M		HAC (T-COIL) TEST REPORT	<b>SONY</b>	Approved by: Quality Manager
Filename: 1M2206010068-05-R4.PY7	Test Dates: 3/21/2022 – 6/6/2022	DUT Type: Portable Handset		Page 25 of 88

## 5. Radio Configuration for OTT VoIP (NR)

An investigation was performed to determine the waveform, modulation, and RB configuration to be used for testing. Due to equipment limitations, the procedure outlined in 6.11.4 was used to evaluate the SNNR for each radio configuration below. DFT-s-OFDM, 16QAM, 1RB, 50%RB offset was determined to be the worst-case configuration for the handset and will be used for full testing in Section 9.

**Table 6-8**  
**NR OTT VoIP SNNR by Radio Configuration (CP-OFDM)**

Band	Frequency [MHz]	Channel	Bandwidth [MHz]	Waveform	Modulation	RB Size	RB Offset	ABM <sub>1LTE</sub> [dB(A/m)]	ABM <sub>2NR</sub> [dB(A/m)]	SNNR <sub>NR</sub> [dB]
n71	680.5	136100	20	CP-OFDM	QPSK	1	1	28.66	-44.67	73.33
n71	680.5	136100	20	CP-OFDM	QPSK	1	53	28.66	-44.95	73.61
n71	680.5	136100	20	CP-OFDM	QPSK	1	104	28.66	-45.73	74.39
n71	680.5	136100	20	CP-OFDM	QPSK	53	0	28.66	-47.35	76.01
n71	680.5	136100	20	CP-OFDM	QPSK	53	26	28.66	-45.25	73.91
n71	680.5	136100	20	CP-OFDM	QPSK	53	53	28.66	-45.72	74.38
n71	680.5	136100	20	CP-OFDM	QPSK	106	0	28.66	-45.66	74.32
n71	680.5	136100	20	CP-OFDM	16QAM	1	1	28.66	-42.93	71.59
n71	680.5	136100	20	CP-OFDM	16QAM	1	53	28.66	-43.49	72.15
n71	680.5	136100	20	CP-OFDM	16QAM	1	104	28.66	-45.20	73.86
n71	680.5	136100	20	CP-OFDM	16QAM	53	0	28.66	-45.18	73.84
n71	680.5	136100	20	CP-OFDM	16QAM	53	26	28.66	-44.57	73.23
n71	680.5	136100	20	CP-OFDM	16QAM	53	53	28.66	-45.65	74.31
n71	680.5	136100	20	CP-OFDM	16QAM	106	0	28.66	-45.58	74.24
n71	680.5	136100	20	CP-OFDM	64QAM	1	1	28.66	-45.42	74.08
n71	680.5	136100	20	CP-OFDM	64QAM	1	53	28.66	-45.25	73.91
n71	680.5	136100	20	CP-OFDM	64QAM	1	104	28.66	-45.90	74.56
n71	680.5	136100	20	CP-OFDM	64QAM	53	0	28.66	-45.26	73.92
n71	680.5	136100	20	CP-OFDM	64QAM	53	26	28.66	-45.35	74.01
n71	680.5	136100	20	CP-OFDM	64QAM	53	53	28.66	-45.59	74.25
n71	680.5	136100	20	CP-OFDM	64QAM	106	0	28.66	-45.55	74.21
n71	680.5	136100	20	CP-OFDM	256QAM	1	1	28.66	-45.14	73.80
n71	680.5	136100	20	CP-OFDM	256QAM	1	53	28.66	-44.82	73.48
n71	680.5	136100	20	CP-OFDM	256QAM	1	104	28.66	-45.70	74.36
n71	680.5	136100	20	CP-OFDM	256QAM	53	0	28.66	-45.50	74.16
n71	680.5	136100	20	CP-OFDM	256QAM	53	26	28.66	-45.29	73.95
n71	680.5	136100	20	CP-OFDM	256QAM	53	53	28.66	-45.43	74.09
n71	680.5	136100	20	CP-OFDM	256QAM	106	0	28.66	-45.56	74.22

FCC ID: PY7-57325M		HAC (T-COIL) TEST REPORT	<b>SONY</b>	Approved by: Quality Manager
Filename: 1M2206010068-05-R4.PY7	Test Dates: 3/21/2022 – 6/6/2022	DUT Type: Portable Handset		Page 26 of 88

**Table 6-9  
NR OTT VoIP SNNR by Radio Configuration (DFT-s-OFDM)**

Band	Frequency [MHz]	Channel	Bandwidth [MHz]	Waveform	Modulation	RB Size	RB Offset	ABM1 <sub>LTE</sub> [dB(A/m)]	ABM2 <sub>NR</sub> [dB(A/m)]	SNNR <sub>NR</sub> [dB]
n71	680.5	136100	20	DFT-s-OFDM	$\pi/2$ -BPSK	1	1	28.66	-45.01	73.67
n71	680.5	136100	20	DFT-s-OFDM	$\pi/2$ -BPSK	1	53	28.66	-45.67	74.33
n71	680.5	136100	20	DFT-s-OFDM	$\pi/2$ -BPSK	1	104	28.66	-45.62	74.28
n71	680.5	136100	20	DFT-s-OFDM	$\pi/2$ -BPSK	50	0	28.66	-45.52	74.18
n71	680.5	136100	20	DFT-s-OFDM	$\pi/2$ -BPSK	50	28	28.66	-45.44	74.10
n71	680.5	136100	20	DFT-s-OFDM	$\pi/2$ -BPSK	50	53	28.66	-45.22	73.88
n71	680.5	136100	20	DFT-s-OFDM	$\pi/2$ -BPSK	100	0	28.66	-44.93	73.59
n71	680.5	136100	20	DFT-s-OFDM	QPSK	1	1	28.66	-45.61	74.27
n71	680.5	136100	20	DFT-s-OFDM	QPSK	1	53	28.66	-45.58	74.24
n71	680.5	136100	20	DFT-s-OFDM	QPSK	1	104	28.66	-45.54	74.20
n71	680.5	136100	20	DFT-s-OFDM	QPSK	50	0	28.66	-45.27	73.93
n71	680.5	136100	20	DFT-s-OFDM	QPSK	50	28	28.66	-45.32	73.98
n71	680.5	136100	20	DFT-s-OFDM	QPSK	50	53	28.66	-45.37	74.03
n71	680.5	136100	20	DFT-s-OFDM	QPSK	100	0	28.66	-45.41	74.07
n71	680.5	136100	20	DFT-s-OFDM	16QAM	1	1	28.66	-42.66	71.32
n71	680.5	136100	20	DFT-s-OFDM	16QAM	1	53	28.66	-42.38	71.04
n71	680.5	136100	20	DFT-s-OFDM	16QAM	1	104	28.66	-45.63	74.29
n71	680.5	136100	20	DFT-s-OFDM	16QAM	50	0	28.66	-45.24	73.90
n71	680.5	136100	20	DFT-s-OFDM	16QAM	50	28	28.66	-45.28	73.94
n71	680.5	136100	20	DFT-s-OFDM	16QAM	50	53	28.66	-45.53	74.19
n71	680.5	136100	20	DFT-s-OFDM	16QAM	100	0	28.66	-45.15	73.81
n71	680.5	136100	20	DFT-s-OFDM	64QAM	1	1	28.66	-43.63	72.29
n71	680.5	136100	20	DFT-s-OFDM	64QAM	1	53	28.66	-42.55	71.21
n71	680.5	136100	20	DFT-s-OFDM	64QAM	1	104	28.66	-45.64	74.30
n71	680.5	136100	20	DFT-s-OFDM	64QAM	50	0	28.66	-45.14	73.80
n71	680.5	136100	20	DFT-s-OFDM	64QAM	50	28	28.66	-44.76	73.42
n71	680.5	136100	20	DFT-s-OFDM	64QAM	50	53	28.66	-45.16	73.82
n71	680.5	136100	20	DFT-s-OFDM	64QAM	100	0	28.66	-45.06	73.72
n71	680.5	136100	20	DFT-s-OFDM	256QAM	1	1	28.66	-45.44	74.10
n71	680.5	136100	20	DFT-s-OFDM	256QAM	1	53	28.66	-45.17	73.83
n71	680.5	136100	20	DFT-s-OFDM	256QAM	1	104	28.66	-45.56	74.22
n71	680.5	136100	20	DFT-s-OFDM	256QAM	50	0	28.66	-45.34	74.00
n71	680.5	136100	20	DFT-s-OFDM	256QAM	50	28	28.66	-45.37	74.03
n71	680.5	136100	20	DFT-s-OFDM	256QAM	50	53	28.66	-45.65	74.31
n71	680.5	136100	20	DFT-s-OFDM	256QAM	100	0	28.66	-45.06	73.72

An investigation was performed to determine the worst-case NR FDD band to be used for OTT VoIP testing. NR n71 was used for the testing as the worst-case configuration for the handset. See below table for SNNR comparison between different NR FDD bands:

**Table 6-10  
OTT VoIP (NR FDD) SNNR by Band**

Band	Frequency [MHz]	Channel	Bandwidth [MHz]	Waveform	Modulation	RB Size	RB Offset	ABM1 <sub>LTE</sub> [dB(A/m)]	ABM2 <sub>NR</sub> [dB(A/m)]	SNNR <sub>NR</sub> [dB]
n71	680.5	136100	20	DFT-s-OFDM	16QAM	1	53	28.66	-42.79	71.45
n5	836.5	167300	20	DFT-s-OFDM	16QAM	1	53	28.89	-43.32	72.21
n5 (ASDIV)	836.5	167300	20	DFT-s-OFDM	16QAM	1	53	28.63	-44.57	73.20
n66	1745.0	349000	20	DFT-s-OFDM	16QAM	1	53	28.79	-45.38	74.17
n2	1880.0	376000	20	DFT-s-OFDM	16QAM	1	53	28.81	-46.49	75.30

An investigation was performed to determine the worst-case NR TDD band to be used for OTT VoIP testing. NR n41 was used for the testing as the worst-case configuration for the handset. See below table for SNNR comparison between different NR TDD bands:

**Table 6-11  
OTT VoIP (NR TDD) SNNR by Band**

Band	Frequency [MHz]	Channel	Bandwidth [MHz]	Waveform	Modulation	RB Size	RB Offset	ABM1 <sub>LTE</sub> [dB(A/m)]	ABM2 <sub>NR</sub> [dB(A/m)]	SNNR <sub>NR</sub> [dB]
n41	2592.99	518598	100	DFT-s-OFDM	16QAM	1	137	28.97	-40.61	69.58
n41 (UL MIMO)	2592.99	518598	100	DFT-s-OFDM	16QAM	1	137	28.97	-45.43	74.40
n77	3840.00	656000	100	DFT-s-OFDM	16QAM	1	137	29.13	-42.08	71.21
n77 (UL MIMO)	3840.00	656000	100	DFT-s-OFDM	16QAM	1	137	29.13	-40.90	70.03

FCC ID: PY7-57325M		HAC (T-COIL) TEST REPORT	<b>SONY</b>	Approved by: Quality Manager
Filename: 1M2206010068-05-R4.PY7	Test Dates: 3/21/2022 – 6/6/2022	DUT Type: Portable Handset		Page 27 of 88

## 6. Radio Configuration for OTT VoIP (WIFI)

An investigation was performed on all applicable data rates and modulations to determine the radio configuration to be used for testing. See tables below for SNNR comparison between radio configurations in each IEEE 802.11 standard:

**Table 6-12**  
**IEEE 802.11b SNNR by Radio Configuration**

Mode	Channel	Modulation	Data Rate [Mbps]	ABM1 [dB(A/m)]	ABM2 [dB(A/m)]	SNNR [dB]
IEEE 802.11b	6	DSSS	1	29.31	-39.05	68.36
IEEE 802.11b	6	DSSS	2	29.27	-38.11	67.38
IEEE 802.11b	6	CCK	5.5	29.21	-38.10	<b>67.31</b>
IEEE 802.11b	6	CCK	11	29.58	-38.37	67.95

**Table 6-13**  
**IEEE 802.11g/a SNNR by Radio Configuration**

Mode	Channel	Modulation	Data Rate [Mbps]	ABM1 [dB(A/m)]	ABM2 [dB(A/m)]	SNNR [dB]
IEEE 802.11g	6	BPSK	6	29.31	-40.38	69.69
IEEE 802.11g	6	BPSK	9	29.15	-39.26	<b>68.41</b>
IEEE 802.11g	6	QPSK	12	29.10	-40.07	69.17
IEEE 802.11g	6	QPSK	18	29.23	-39.96	69.19
IEEE 802.11g	6	16QAM	24	29.54	-40.45	69.99
IEEE 802.11g	6	16QAM	36	29.11	-39.56	68.67
IEEE 802.11g	6	64QAM	48	29.35	-40.81	70.16
IEEE 802.11g	6	64QAM	54	29.07	-41.77	70.84

**Table 6-14**  
**IEEE 802.11n/ac 20MHz BW SNNR by Radio Configuration**

Mode	Bandwidth [MHz]	Channel	Modulation	MCS Index	ABM1 [dB(A/m)]	ABM2 [dB(A/m)]	SNNR [dB]
IEEE 802.11n	20	40	BPSK	0	29.13	-38.64	67.77
IEEE 802.11n	20	40	QPSK	1	29.05	-38.15	<b>67.20</b>
IEEE 802.11n	20	40	QPSK	2	29.03	-39.04	68.07
IEEE 802.11n	20	40	16QAM	3	28.96	-39.45	68.41
IEEE 802.11n	20	40	16QAM	4	29.10	-39.57	68.67
IEEE 802.11n	20	40	64QAM	5	29.11	-38.54	67.65
IEEE 802.11n	20	40	64QAM	6	29.03	-38.26	67.29
IEEE 802.11n	20	40	64QAM	7	29.03	-38.60	67.63
IEEE 802.11ac	20	40	256QAM	8	29.26	-38.50	67.76

FCC ID: PY7-57325M		HAC (T-COIL) TEST REPORT	<b>SONY</b>	Approved by: Quality Manager
Filename: 1M2206010068-05-R4.PY7	Test Dates: 3/21/2022 – 6/6/2022	DUT Type: Portable Handset		Page 28 of 88

**Table 6-15**  
**IEEE 802.11ax SU 20MHz BW SNNR by Radio Configuration**

Mode	Bandwidth [MHz]	Channel	Modulation	MCS Index	ABM1 [dB(A/m)]	ABM2 [dB(A/m)]	SNNR [dB]
IEEE 802.11ax SU	20	40	BPSK	0	29.14	-38.55	67.69
IEEE 802.11ax SU	20	40	QPSK	1	29.16	-38.19	<b>67.35</b>
IEEE 802.11ax SU	20	40	QPSK	2	29.29	-38.38	67.67
IEEE 802.11ax SU	20	40	16QAM	3	29.34	-38.99	68.33
IEEE 802.11ax SU	20	40	16QAM	4	29.26	-39.21	68.47
IEEE 802.11ax SU	20	40	64QAM	5	29.11	-39.23	68.34
IEEE 802.11ax SU	20	40	64QAM	6	29.15	-39.42	68.57
IEEE 802.11ax SU	20	40	64QAM	7	29.17	-39.93	69.10
IEEE 802.11ax SU	20	40	256QAM	8	29.12	-40.97	70.09
IEEE 802.11ax SU	20	40	256QAM	9	29.06	-40.95	70.01
IEEE 802.11ax SU	20	40	1024QAM	10	29.33	-41.34	70.67
IEEE 802.11ax SU	20	40	1024QAM	11	29.16	-42.51	71.67

**Table 6-16**  
**IEEE 802.11ax RU 20MHz BW SNNR by Radio Configuration**

Mode	Bandwidth [MHz]	Channel	Modulation	MCS Index	RU Index	ABM1 [dB(A/m)]	ABM2 [dB(A/m)]	SNNR [dB]
IEEE 802.11ax RU	20	40	QPSK	1	0	29.04	-38.45	67.49
IEEE 802.11ax RU	20	40	QPSK	1	8	29.13	-38.71	67.84
IEEE 802.11ax RU	20	40	QPSK	1	37	29.08	-38.26	67.34
IEEE 802.11ax RU	20	40	QPSK	1	40	29.27	-37.61	<b>66.88</b>
IEEE 802.11ax RU	20	40	QPSK	1	53	29.27	-37.99	67.26
IEEE 802.11ax RU	20	40	QPSK	1	54	29.23	-38.51	67.74
IEEE 802.11ax RU	20	40	QPSK	1	61	29.08	-38.44	67.52

**Table 6-17**  
**IEEE 802.11n/ac 40MHz BW SNNR by Radio Configuration**

Mode	Bandwidth [MHz]	Channel	Modulation	MCS Index	ABM1 [dB(A/m)]	ABM2 [dB(A/m)]	SNNR [dB]
IEEE 802.11n	40	38	BPSK	0	29.17	-38.94	68.11
IEEE 802.11n	40	38	QPSK	1	29.22	-38.68	<b>67.90</b>
IEEE 802.11n	40	38	QPSK	2	29.08	-39.47	68.55
IEEE 802.11n	40	38	16QAM	3	29.13	-39.98	69.11
IEEE 802.11n	40	38	16QAM	4	29.18	-39.86	69.04
IEEE 802.11n	40	38	64QAM	5	29.10	-39.71	68.81
IEEE 802.11n	40	38	64QAM	6	28.90	-39.05	67.95
IEEE 802.11n	40	38	64QAM	7	28.99	-40.21	69.20
IEEE 802.11ac	40	38	256QAM	8	28.94	-41.23	70.17
IEEE 802.11ac	40	38	256QAM	9	29.36	-43.87	73.23

FCC ID: PY7-57325M		HAC (T-COIL) TEST REPORT	<b>SONY</b>	Approved by: Quality Manager
Filename: 1M2206010068-05-R4.PY7	Test Dates: 3/21/2022 – 6/6/2022	DUT Type: Portable Handset		Page 29 of 88

**Table 6-18**  
**IEEE 802.11ax SU 40MHz BW SNNR by Radio Configuration**

Mode	Bandwidth [MHz]	Channel	Modulation	MCS Index	ABM1 [dB(A/m)]	ABM2 [dB(A/m)]	SNNR [dB]
IEEE 802.11ax SU	40	38	BPSK	0	29.38	-38.42	67.80
IEEE 802.11ax SU	40	38	QPSK	1	29.21	-39.32	68.53
IEEE 802.11ax SU	40	38	QPSK	2	29.12	-39.81	68.93
IEEE 802.11ax SU	40	38	16QAM	3	29.09	-40.44	69.53
IEEE 802.11ax SU	40	38	16QAM	4	29.04	-42.18	71.22
IEEE 802.11ax SU	40	38	64QAM	5	29.08	-42.05	71.13
IEEE 802.11ax SU	40	38	64QAM	6	29.03	-42.51	71.54
IEEE 802.11ax SU	40	38	64QAM	7	28.85	-42.66	71.51
IEEE 802.11ax SU	40	38	256QAM	8	29.27	-42.25	71.52
IEEE 802.11ax SU	40	38	256QAM	9	29.43	-42.10	71.53
IEEE 802.11ax SU	40	38	1024QAM	10	29.22	-41.52	70.74
IEEE 802.11ax SU	40	38	1024QAM	11	29.21	-41.38	70.59

**Table 6-19**  
**IEEE 802.11ax RU 40MHz BW SNNR by Radio Configuration**

Mode	Bandwidth [MHz]	Channel	Modulation	MCS Index	RU Index	ABM1 [dB(A/m)]	ABM2 [dB(A/m)]	SNNR [dB]
IEEE 802.11ax RU	40	38	BPSK	0	0	28.99	-38.62	67.61
IEEE 802.11ax RU	40	38	BPSK	0	17	28.90	-39.10	68.00
IEEE 802.11ax RU	40	38	BPSK	0	37	29.03	-38.41	67.44
IEEE 802.11ax RU	40	38	BPSK	0	44	29.24	-38.08	67.32
IEEE 802.11ax RU	40	38	BPSK	0	53	29.19	-39.16	68.35
IEEE 802.11ax RU	40	38	BPSK	0	56	29.17	-39.08	68.25
IEEE 802.11ax RU	40	38	BPSK	0	61	29.19	-38.88	68.07
IEEE 802.11ax RU	40	38	BPSK	0	62	29.15	-38.91	68.06
IEEE 802.11ax RU	40	38	BPSK	0	65	29.33	-39.28	68.61

FCC ID: PY7-57325M		HAC (T-COIL) TEST REPORT	<b>SONY</b>	Approved by: Quality Manager
Filename: 1M2206010068-05-R4.PY7	Test Dates: 3/21/2022 – 6/6/2022	DUT Type: Portable Handset		Page 30 of 88

## 7. FCC 3G MEASUREMENTS

### I. UMTS Test Configurations

WB AMR 6.60kbps, 13.6kbps SRB was used for the testing as the worst-case configuration for the handset.

**Table 7-1**  
**Codec Investigation - UMTS**

Codec Setting:	WB AMR 23.85kbps	WB AMR 6.60kbps	NB AMR 12.2kbps	NB AMR 4.75kbps	Orientation	Channel
ABM1 (dBA/m)	7.52	6.32	8.27	8.02	Axial	9400
ABM2 (dBA/m)	-52.45	-51.79	-51.86	-52.33		
Frequency Response	Pass	Pass	Pass	Pass		
S+N/N (dB)	59.97	58.11	60.13	60.35		

- Mute on; Backlight off; Max Volume; Max Contrast
- TPC="All 1s"

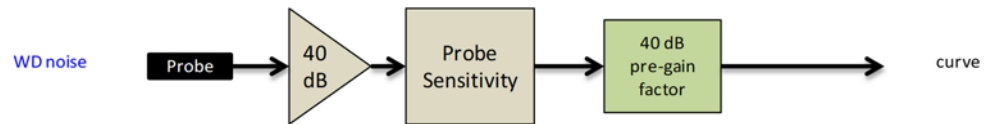

**Figure 7-1**  
**Audio Band Magnetic Curve Measurement Block Diagram**

FCC ID: PY7-57325M	element	HAC (T-COIL) TEST REPORT	<b>SONY</b>	Approved by: Quality Manager
Filename: 1M2206010068-05-R4.PY7	Test Dates: 3/21/2022 – 6/6/2022	DUT Type: Portable Handset		Page 31 of 88

## 8. T-COIL TEST SUMMARY

**Table 8-1  
Consolidated Tabled Results**

		Freq. Response Margin		Magnetic Intensity Verdict		FCC SNNR Verdict		Margin from FCC Limit (dB)	C63.19-2011 Rating
		8.3.2		8.3.1		8.3.4			
		Axial	Radial	Axial	Radial	Axial	Radial		
<b>GSM</b>	Cellular	PASS	NA	PASS	PASS	PASS	PASS	<b>-12.15</b>	<b>T4</b>
	PCS	PASS	NA	PASS	PASS	PASS	PASS		
<b>EDGE (OTT VoIP)</b>	Cellular	PASS	NA	PASS	PASS	PASS	PASS	<b>-33.89</b>	<b>T4</b>
	PCS	PASS	NA	PASS	PASS	PASS	PASS		
<b>UMTS</b>	Cellular	PASS	NA	PASS	PASS	PASS	PASS	<b>-28.96</b>	<b>T4</b>
	AWS	PASS	NA	PASS	PASS	PASS	PASS		
	PCS	PASS	NA	PASS	PASS	PASS	PASS		
<b>HSPA (OTT VoIP)</b>	Cellular	PASS	NA	PASS	PASS	PASS	PASS	<b>-51.57</b>	<b>T4</b>
	AWS	PASS	NA	PASS	PASS	PASS	PASS		
	PCS	PASS	NA	PASS	PASS	PASS	PASS		
<b>LTE FDD</b>	B71	PASS	NA	PASS	PASS	PASS	PASS	<b>-19.22</b>	<b>T4</b>
	B12	PASS	NA	PASS	PASS	PASS	PASS		
	B13	PASS	NA	PASS	PASS	PASS	PASS		
	B5	PASS	NA	PASS	PASS	PASS	PASS		
	B4	PASS	NA	PASS	PASS	PASS	PASS		
	B66	PASS	NA	PASS	PASS	PASS	PASS		
	B2	PASS	NA	PASS	PASS	PASS	PASS		
	B25	PASS	NA	PASS	PASS	PASS	PASS		
<b>LTE FDD (OTT VoIP)</b>	B7	PASS	NA	PASS	PASS	PASS	PASS	<b>-41.25</b>	<b>T4</b>
<b>LTE TDD</b>	B41 (PC3)	PASS	NA	PASS	PASS	PASS	PASS	<b>-13.26</b>	<b>T4</b>
	B48	PASS	NA	PASS	PASS	PASS	PASS		
<b>LTE TDD (OTT VoIP)</b>	B41 (PC3)	PASS	NA	PASS	PASS	PASS	PASS	<b>-34.22</b>	<b>T4</b>
<b>NR FDD (OTT VoIP)</b>	n71	NA	NA	PASS	PASS	PASS	PASS	<b>-40.89</b>	<b>T4</b>
<b>NR TDD (OTT VoIP)</b>	n41	NA	NA	PASS	PASS	PASS	PASS	<b>-30.43</b>	<b>T4</b>
<b>WLAN (OTT VoIP)</b>	IEEE 802.11b	PASS	NA	PASS	PASS	PASS	PASS	<b>-45.88</b>	<b>T4</b>
	IEEE 802.11g	PASS	NA	PASS	PASS	PASS	PASS		
	IEEE 802.11n	PASS	NA	PASS	PASS	PASS	PASS		
	IEEE 802.11ax SU	PASS	NA	PASS	PASS	PASS	PASS		
	IEEE 802.11ax RU	PASS	NA	PASS	PASS	PASS	PASS		
<b>U-NII (OTT VoIP)</b>	IEEE 802.11a	PASS	NA	PASS	PASS	PASS	PASS	<b>-46.49</b>	<b>T4</b>
	IEEE 802.11n	PASS	NA	PASS	PASS	PASS	PASS		
	IEEE 802.11ac	PASS	NA	PASS	PASS	PASS	PASS		
	IEEE 802.11ax SU	PASS	NA	PASS	PASS	PASS	PASS		
	IEEE 802.11ax RU	PASS	NA	PASS	PASS	PASS	PASS		

FCC ID: PY7-57325M		<b>HAC (T-COIL) TEST REPORT</b>	<b>SONY</b>	Approved by: Quality Manager
Filename: <b>1M2206010068-05-R4.PY7</b>	Test Dates: <b>3/21/2022 – 6/6/2022</b>	DUT Type: <b>Portable Handset</b>		Page 32 of 88



# I. Raw Handset Data

**Table 8-2  
Raw Data Results for GSM**



Mode	Orientation	Channel	Device SN	ABM1 [dB(A/m)]	ABM2 [dB(A/m)]	Ambient Noise [dB(A/m)]	Frequency Response Margin (dB)	S+N/N (dB)	FCC Limit (dB)	Margin from FCC Limit (dB)	C63.19-2011 Rating	Test Coordinates
GSM850	Axial	128	05JAZ	8.53	-31.64	-58.28	1.43	40.17	20.00	-20.17	T4	2.0, 3.0
		190	05JAZ	8.74	-33.07		1.47	41.81	20.00	-21.81	T4	
		251	05JAZ	8.55	-34.28		1.50	42.83	20.00	-22.83	T4	
	Radial	128	05JAZ	2.32	-33.80	-62.21	N/A	36.12	20.00	-16.12	T4	2.0, 3.8
		190	05JAZ	2.24	-31.75			33.99	20.00	-13.99	T4	
		251	05JAZ	2.30	-29.85			32.15	20.00	-12.15	T4	
GSM1900	Axial	512	05JAZ	8.56	-36.35	-58.28	1.52	44.91	20.00	-24.91	T4	2.0, 3.0
		661	05JAZ	8.70	-36.34		1.50	45.04	20.00	-25.04	T4	
		810	05JAZ	8.72	-37.23		1.50	45.95	20.00	-25.95	T4	
	Radial	512	05JAZ	2.01	-32.88	-62.21	N/A	34.89	20.00	-14.89	T4	2.0, 3.8
		661	05JAZ	2.29	-33.37			35.66	20.00	-15.66	T4	
		810	05JAZ	2.29	-33.10			35.39	20.00	-15.39	T4	

**Table 8-3  
Raw Data Results for UMTS**

Mode	Orientation	Channel	Device SN	ABM1 [dB(A/m)]	ABM2 [dB(A/m)]	Ambient Noise [dB(A/m)]	Frequency Response Margin (dB)	S+N/N (dB)	FCC Limit (dB)	Margin from FCC Limit (dB)	C63.19-2011 Rating	Test Coordinates
UMTS V	Axial	4132	05JAZ	6.31	-54.06	-58.28	2.00	60.37	20.00	-40.37	T4	2.0, 3.0
		4183	05JAZ	6.16	-52.26		2.00	58.42	20.00	-38.42	T4	
		4233	05JAZ	6.06	-53.79		2.00	59.85	20.00	-39.85	T4	
	Radial	4132	05JAZ	-0.88	-51.57	-62.21	N/A	50.69	20.00	-30.69	T4	2.0, 3.8
		4183	05JAZ	-1.05	-51.34			50.29	20.00	-30.29	T4	
		4233	05JAZ	-0.86	-50.71			49.85	20.00	-29.85	T4	
UMTS IV	Axial	1312	05JAZ	6.41	-51.72	-58.28	2.00	58.13	20.00	-38.13	T4	2.0, 3.0
		1412	05JAZ	6.31	-52.31		2.00	58.62	20.00	-38.62	T4	
		1513	05JAZ	6.21	-51.86		2.00	58.07	20.00	-38.07	T4	
	Radial	1312	05JAZ	-0.81	-50.62	-62.21	N/A	49.81	20.00	-29.81	T4	2.0, 3.8
		1412	05JAZ	-1.05	-51.31			50.26	20.00	-30.26	T4	
		1513	05JAZ	-0.75	-49.71			48.96	20.00	-28.96	T4	
UMTS II	Axial	9262	05JAZ	6.10	-52.84	-58.28	2.00	58.94	20.00	-38.94	T4	2.0, 3.0
		9400	05JAZ	6.09	-52.02		1.95	58.11	20.00	-38.11	T4	
		9538	05JAZ	6.16	-51.61		2.00	57.77	20.00	-37.77	T4	
	Radial	9262	05JAZ	-1.01	-51.99	-62.21	N/A	50.98	20.00	-30.98	T4	2.0, 3.8
		9400	05JAZ	-1.14	-51.09			49.95	20.00	-29.95	T4	
		9538	05JAZ	-1.10	-52.10			51.00	20.00	-31.00	T4	

**Table 8-4  
Raw Data Results for LTE B71**

Mode	Orientation	Bandwidth	Channel	Device SN	ABM1 [dB(A/m)]	ABM2 [dB(A/m)]	Ambient Noise [dB(A/m)]	Frequency Response Margin (dB)	S+N/N (dB)	FCC Limit (dB)	Margin from FCC Limit (dB)	C63.19-2011 Rating	Test Coordinates
LTE Band 71	Axial	20MHz	133297	00GC5	6.12	-42.36	-61.12	2.00	48.48	20.00	-28.48	T4	2.0, 3.0
		15MHz	133297	00GC5	5.88	-43.14		2.00	49.02	20.00	-29.02	T4	
		10MHz	133297	00GC5	5.89	-42.90		2.00	48.79	20.00	-28.79	T4	
		5MHz	133297	00GC5	5.63	-43.11		2.00	48.74	20.00	-28.74	T4	
	Radial	20MHz	133297	00GC5	-0.09	-43.59	-62.21	N/A	43.50	20.00	-23.50	T4	2.0, 3.8
		15MHz	133297	00GC5	-0.40	-45.41			45.01	20.00	-25.01	T4	
		10MHz	133297	00GC5	-0.06	-45.72			45.66	20.00	-25.66	T4	
		5MHz	133297	00GC5	0.08	-44.71			44.79	20.00	-24.79	T4	

FCC ID: PY7-57325M		HAC (T-COIL) TEST REPORT		Approved by: Quality Manager
Filename: 1M2206010068-05-R4.PY7	Test Dates: 3/21/2022 – 6/6/2022	DUT Type: Portable Handset		Page 33 of 88

**Table 8-5**  
**Raw Data Results for LTE B12**

Mode	Orientation	Bandwidth	Channel	Device SN	ABM1 [dB(A/m)]	ABM2 [dB(A/m)]	Ambient Noise [dB(A/m)]	Frequency Response Margin (dB)	S+N/N (dB)	FCC Limit (dB)	Margin from FCC Limit (dB)	C63.19-2011 Rating	Test Coordinates
LTE Band 12	Axial	10MHz	23095	05JAZ	5.76	-44.30	-58.28	1.91	50.06	20.00	-30.06	T4	2.0, 3.0
		5MHz	23095	05JAZ	5.75	-43.80		2.00	49.55	20.00	-29.55	T4	
		3MHz	23095	05JAZ	5.78	-44.08		1.95	49.86	20.00	-29.86	T4	
		1.4MHz	23095	05JAZ	5.95	-43.91		2.00	49.86	20.00	-29.86	T4	
	Radial	10MHz	23095	05JAZ	-0.46	-44.90	-62.21	N/A	44.44	20.00	-24.44	T4	2.0, 3.8
		5MHz	23095	05JAZ	0.04	-43.99			44.03	20.00	-24.03	T4	
		3MHz	23095	05JAZ	0.26	-45.30			45.56	20.00	-25.56	T4	
		1.4MHz	23095	05JAZ	0.21	-44.01			44.22	20.00	-24.22	T4	

**Table 8-6**  
**Raw Data Results for LTE B12 (ASDIV)**

Mode	Orientation	Bandwidth	Channel	Device SN	ABM1 [dB(A/m)]	ABM2 [dB(A/m)]	Ambient Noise [dB(A/m)]	Frequency Response Margin (dB)	S+N/N (dB)	FCC Limit (dB)	Margin from FCC Limit (dB)	C63.19-2011 Rating	Test Coordinates
LTE Band 12	Axial	10MHz	23095	00GC5	6.03	-42.26	-61.12	2.00	48.29	20.00	-28.29	T4	2.0, 3.0
		5MHz	23095	00GC5	6.27	-42.48		2.00	48.75	20.00	-28.75	T4	
		3MHz	23095	00GC5	6.40	-42.56		2.00	48.96	20.00	-28.96	T4	
		1.4MHz	23095	00GC5	6.32	-42.43		2.00	48.75	20.00	-28.75	T4	
	Radial	10MHz	23095	00GC5	-0.27	-44.97	-62.21	N/A	44.70	20.00	-24.70	T4	2.0, 3.8
		5MHz	23095	00GC5	-0.23	-45.17			44.94	20.00	-24.94	T4	
		3MHz	23095	00GC5	-0.31	-46.17			45.86	20.00	-25.86	T4	
		1.4MHz	23095	00GC5	-0.18	-46.06			45.88	20.00	-25.88	T4	

**Table 8-7**  
**Raw Data Results for LTE B13**



Mode	Orientation	Bandwidth	Channel	Device SN	ABM1 [dB(A/m)]	ABM2 [dB(A/m)]	Ambient Noise [dB(A/m)]	Frequency Response Margin (dB)	S+N/N (dB)	FCC Limit (dB)	Margin from FCC Limit (dB)	C63.19-2011 Rating	Test Coordinates
LTE Band 13	Axial	10MHz	23230	05JAZ	5.61	-44.77	-58.28	2.00	50.38	20.00	-30.38	T4	2.0, 3.0
		5MHz	23230	05JAZ	5.76	-44.59		2.00	50.35	20.00	-30.35	T4	
	Radial	10MHz	23230	05JAZ	-0.85	-45.99	-62.21	N/A	45.14	20.00	-25.14	T4	2.0, 3.8
		5MHz	23230	05JAZ	0.14	-45.04			45.18	20.00	-25.18	T4	

**Table 8-8**  
**Raw Data Results for LTE B13 (ASDIV)**

Mode	Orientation	Bandwidth	Channel	Device SN	ABM1 [dB(A/m)]	ABM2 [dB(A/m)]	Ambient Noise [dB(A/m)]	Frequency Response Margin (dB)	S+N/N (dB)	FCC Limit (dB)	Margin from FCC Limit (dB)	C63.19-2011 Rating	Test Coordinates
LTE Band 13	Axial	10MHz	23230	00GC5	6.13	-42.69	-61.12	2.00	48.82	20.00	-28.82	T4	2.0, 3.0
		5MHz	23230	00GC5	6.00	-43.84		2.00	49.84	20.00	-29.84	T4	
	Radial	10MHz	23230	00GC5	-0.44	-46.92	-62.21	N/A	46.48	20.00	-26.48	T4	2.0, 3.8
		5MHz	23230	00GC5	-0.10	-46.56			46.46	20.00	-26.46	T4	

**Table 8-9**  
**Raw Data Results for LTE B5**

Mode	Orientation	Bandwidth	Channel	Device SN	ABM1 [dB(A/m)]	ABM2 [dB(A/m)]	Ambient Noise [dB(A/m)]	Frequency Response Margin (dB)	S+N/N (dB)	FCC Limit (dB)	Margin from FCC Limit (dB)	C63.19-2011 Rating	Test Coordinates
LTE Band 5	Axial	10MHz	20525	05JAZ	5.81	-43.38	-58.28	2.00	49.19	20.00	-29.19	T4	2.0, 3.0
		5MHz	20525	05JAZ	5.85	-43.44		1.98	49.29	20.00	-29.29	T4	
		3MHz	20525	05JAZ	5.62	-43.69		2.00	49.31	20.00	-29.31	T4	
		1.4MHz	20525	05JAZ	5.98	-43.52		2.00	49.50	20.00	-29.50	T4	
	Radial	10MHz	20525	05JAZ	-0.60	-45.32	-62.21	N/A	44.72	20.00	-24.72	T4	2.0, 3.8
		5MHz	20525	05JAZ	0.14	-44.82			44.96	20.00	-24.96	T4	
		3MHz	20525	05JAZ	0.22	-44.33			44.55	20.00	-24.55	T4	
		1.4MHz	20525	05JAZ	0.21	-44.51			44.72	20.00	-24.72	T4	

FCC ID: PY7-57325M		HAC (T-COIL) TEST REPORT		Approved by: Quality Manager
Filename: 1M2206010068-05-R4.PY7	Test Dates: 3/21/2022 – 6/6/2022	DUT Type: Portable Handset		Page 34 of 88

**Table 8-10**  
**Raw Data Results for LTE B5 (ASDIV)**

Mode	Orientation	Bandwidth	Channel	Device SN	ABM1 [dB(A/m)]	ABM2 [dB(A/m)]	Ambient Noise [dB(A/m)]	Frequency Response Margin (dB)	S+N/N (dB)	FCC Limit (dB)	Margin from FCC Limit (dB)	C63.19-2011 Rating	Test Coordinates
LTE Band 5	Axial	10MHz	20525	00GC5	6.11	-42.36	-61.12	2.00	48.47	20.00	-28.47	T4	2.0, 3.0
		5MHz	20525	00GC5	6.12	-43.32		2.00	49.44	20.00	-29.44	T4	
		3MHz	20525	00GC5	5.84	-43.02		2.00	48.86	20.00	-28.86	T4	
		1.4MHz	20525	00GC5	6.10	-43.50		2.00	49.60	20.00	-29.60	T4	
	Radial	10MHz	20525	00GC5	-0.41	-45.91	-62.21	N/A	45.50	20.00	-25.50	T4	2.0, 3.8
		5MHz	20525	00GC5	-0.26	-45.21			44.95	20.00	-24.95	T4	
		3MHz	20525	00GC5	-0.16	-45.26			45.10	20.00	-25.10	T4	
		1.4MHz	20525	00GC5	-0.32	-45.58			45.26	20.00	-25.26	T4	

**Table 8-11**  
**Raw Data Results for LTE B66**



Mode	Orientation	Bandwidth	Channel	Device SN	ABM1 [dB(A/m)]	ABM2 [dB(A/m)]	Ambient Noise [dB(A/m)]	Frequency Response Margin (dB)	S+N/N (dB)	FCC Limit (dB)	Margin from FCC Limit (dB)	C63.19-2011 Rating	Test Coordinates
LTE Band 66	Axial	20MHz	132322	05JAZ	6.06	-38.58	-58.28	2.00	44.64	20.00	-24.64	T4	2.0, 3.0
		15MHz	132322	05JAZ	5.82	-39.68		2.00	45.50	20.00	-25.50	T4	
		10MHz	132322	05JAZ	5.88	-39.26		2.00	45.14	20.00	-25.14	T4	
		5MHz	132322	05JAZ	5.96	-39.26		2.00	45.22	20.00	-25.22	T4	
		3MHz	132322	05JAZ	5.61	-39.65		2.00	45.26	20.00	-25.26	T4	
		1.4MHz	132322	05JAZ	5.65	-39.77		2.00	45.42	20.00	-25.42	T4	
	Radial	20MHz	132322	05JAZ	0.16	-39.08	-62.21	N/A	39.24	20.00	-19.24	T4	2.0, 3.8
		15MHz	132322	05JAZ	0.23	-40.56			40.79	20.00	-20.79	T4	
		10MHz	132322	05JAZ	0.21	-40.80			41.01	20.00	-21.01	T4	
		5MHz	132322	05JAZ	0.21	-40.46			40.67	20.00	-20.67	T4	
		3MHz	132322	05JAZ	0.06	-40.32			40.38	20.00	-20.38	T4	
		1.4MHz	132322	05JAZ	0.22	-40.64			40.86	20.00	-20.86	T4	

**Table 8-12**  
**Raw Data Results for LTE B66 EN-DC**

Mode	Orientation	Bandwidth	Channel	Device SN	ABM1 [dB(A/m)]	ABM2 [dB(A/m)]	Ambient Noise [dB(A/m)]	Frequency Response Margin (dB)	S+N/N (dB)	FCC Limit (dB)	Margin from FCC Limit (dB)	C63.19-2011 Rating	Test Coordinates
LTE Band 66	Axial	20MHz	132322	00GC5	6.39	-49.14	-62.85	2.00	55.53	20.00	-35.53	T4	2.0, 3.0
		15MHz	132322	00GC5	6.05	-49.27		2.00	55.32	20.00	-35.32	T4	
		10MHz	132322	00GC5	6.23	-49.10		1.78	55.33	20.00	-35.33	T4	
		5MHz	132322	00GC5	6.15	-47.69		1.81	53.84	20.00	-33.84	T4	
		3MHz	132322	00GC5	5.93	-47.25		1.62	53.18	20.00	-33.18	T4	
		1.4MHz	132322	00GC5	6.22	-47.06		1.96	53.28	20.00	-33.28	T4	
	Radial	20MHz	132322	00GC5	0.43	-48.77	-62.28	N/A	49.20	20.00	-29.20	T4	2.0, 3.8
		15MHz	132322	00GC5	0.33	-48.99			49.32	20.00	-29.32	T4	
		10MHz	132322	00GC5	0.46	-48.45			48.91	20.00	-28.91	T4	
		5MHz	132322	00GC5	0.49	-46.01			46.50	20.00	-26.50	T4	
		3MHz	132322	00GC5	0.49	-46.38			46.87	20.00	-26.87	T4	
		1.4MHz	132322	00GC5	0.00	-46.49			46.49	20.00	-26.49	T4	

**Table 8-13**  
**Raw Data Results for LTE B4**

Mode	Orientation	Bandwidth	Channel	Device SN	ABM1 [dB(A/m)]	ABM2 [dB(A/m)]	Ambient Noise [dB(A/m)]	Frequency Response Margin (dB)	S+N/N (dB)	FCC Limit (dB)	Margin from FCC Limit (dB)	C63.19-2011 Rating	Test Coordinates
LTE Band 4	Axial	20MHz	20175	05JAZ	6.08	-40.99	-58.28	2.00	47.07	20.00	-27.07	T4	2.0, 3.0
		15MHz	20175	05JAZ	5.80	-41.26		2.00	47.06	20.00	-27.06	T4	
		10MHz	20175	05JAZ	5.85	-41.31		2.00	47.16	20.00	-27.16	T4	
		5MHz	20175	05JAZ	5.98	-41.05		2.00	47.03	20.00	-27.03	T4	
		3MHz	20175	05JAZ	5.84	-41.31		2.00	47.15	20.00	-27.15	T4	
		1.4MHz	20175	05JAZ	6.03	-41.25		2.00	47.28	20.00	-27.28	T4	
	Radial	20MHz	20175	05JAZ	0.19	-41.35	-62.21	N/A	41.54	20.00	-21.54	T4	2.0, 3.8
		15MHz	20175	05JAZ	0.17	-41.57			41.74	20.00	-21.74	T4	
		10MHz	20175	05JAZ	0.26	-42.36			42.62	20.00	-22.62	T4	
		5MHz	20175	05JAZ	0.21	-42.18			42.39	20.00	-22.39	T4	
		3MHz	20175	05JAZ	0.13	-42.03			42.16	20.00	-22.16	T4	
		1.4MHz	20175	05JAZ	0.20	-41.97			42.17	20.00	-22.17	T4	

FCC ID: PY7-57325M		HAC (T-COIL) TEST REPORT		Approved by: Quality Manager
Filename: 1M2206010068-05-R4.PY7	Test Dates: 3/21/2022 – 6/6/2022	DUT Type: Portable Handset		Page 35 of 88

**Table 8-14**  
**Raw Data Results for LTE B25**



Mode	Orientation	Bandwidth	Channel	Device SN	ABM1 [dB(A/m)]	ABM2 [dB(A/m)]	Ambient Noise [dB(A/m)]	Frequency Response Margin (dB)	S+N/N (dB)	FCC Limit (dB)	Margin from FCC Limit (dB)	C63.19-2011 Rating	Test Coordinates
LTE Band 25	Axial	20MHz	26365	05JAZ	5.90	-38.92	-58.28	2.00	44.82	20.00	-24.82	T4	2.0, 3.0
		15MHz	26365	05JAZ	5.86	-39.51		2.00	45.37	20.00	-25.37	T4	
		10MHz	26365	05JAZ	5.79	-39.74		2.00	45.53	20.00	-25.53	T4	
		5MHz	26365	05JAZ	5.82	-39.28		2.00	45.10	20.00	-25.10	T4	
		3MHz	26365	05JAZ	6.10	-39.67		2.00	45.77	20.00	-25.77	T4	
		1.4MHz	26365	05JAZ	5.72	-40.17		2.00	45.89	20.00	-25.89	T4	
	Radial	20MHz	26365	05JAZ	0.19	-39.86	-62.21	N/A	40.05	20.00	-20.05	T4	2.0, 3.8
		15MHz	26365	05JAZ	0.21	-40.29			40.50	20.00	-20.50	T4	
		10MHz	26365	05JAZ	0.18	-40.63			40.81	20.00	-20.81	T4	
		5MHz	26365	05JAZ	0.20	-40.47			40.67	20.00	-20.67	T4	
		3MHz	26365	05JAZ	0.22	-40.45			40.67	20.00	-20.67	T4	
		1.4MHz	26365	05JAZ	0.25	-40.78			41.03	20.00	-21.03	T4	

**Table 8-15**  
**Raw Data Results for LTE B2**

Mode	Orientation	Bandwidth	Channel	Device SN	ABM1 [dB(A/m)]	ABM2 [dB(A/m)]	Ambient Noise [dB(A/m)]	Frequency Response Margin (dB)	S+N/N (dB)	FCC Limit (dB)	Margin from FCC Limit (dB)	C63.19-2011 Rating	Test Coordinates			
LTE Band 2	Axial	20MHz	19100	05JAZ	6.23	-40.40	-58.28	2.00	46.63	20.00	-26.63	T4	2.0, 3.0			
		20MHz	18900	05JAZ	5.73	-38.22		2.00	43.95	20.00	-23.95	T4				
		20MHz	18700	05JAZ	5.71	-39.67		2.00	45.38	20.00	-25.38	T4				
		15MHz	18900	05JAZ	5.85	-39.04		2.00	44.89	20.00	-24.89	T4				
		10MHz	18900	05JAZ	5.74	-38.83		2.00	44.57	20.00	-24.57	T4				
		5MHz	18900	05JAZ	5.84	-38.64		2.00	44.48	20.00	-24.48	T4				
		3MHz	18900	05JAZ	5.80	-38.82		2.00	44.62	20.00	-24.62	T4				
		1.4MHz	18900	05JAZ	5.65	-38.94		2.00	44.59	20.00	-24.59	T4				
		Radial	20MHz	19100	05JAZ	0.09		-42.32	-62.21	N/A	42.41	20.00		-22.41	T4	2.0, 3.8
			20MHz	18900	05JAZ	0.18		-39.04			39.22	20.00		-19.22	T4	
	20MHz		18700	05JAZ	0.13	-41.88	42.01	20.00			-22.01	T4				
	15MHz		18900	05JAZ	0.21	-40.23	40.44	20.00			-20.44	T4				
	10MHz		18900	05JAZ	0.04	-40.33	40.37	20.00			-20.37	T4				
	5MHz		18900	05JAZ	0.17	-39.84	40.01	20.00			-20.01	T4				
	3MHz		18900	05JAZ	0.23	-40.05	40.28	20.00			-20.28	T4				
	1.4MHz		18900	05JAZ	0.24	-40.16	40.40	20.00			-20.40	T4				

**Table 8-16**  
**Raw Data Results for LTE B2 EN-DC**

Mode	Orientation	Bandwidth	Channel	Device SN	ABM1 [dB(A/m)]	ABM2 [dB(A/m)]	Ambient Noise [dB(A/m)]	Frequency Response Margin (dB)	S+N/N (dB)	FCC Limit (dB)	Margin from FCC Limit (dB)	C63.19-2011 Rating	Test Coordinates
LTE Band 2	Axial	20MHz	18900	00GC5	6.33	-51.66	-62.85	1.61	57.99	20.00	-37.99	T4	2.0, 3.0
		15MHz	18900	00GC5	6.33	-50.31		2.00	56.64	20.00	-36.64	T4	
		10MHz	18900	00GC5	6.07	-50.80		2.00	56.87	20.00	-36.87	T4	
		5MHz	18900	00GC5	6.37	-50.32		1.83	56.69	20.00	-36.69	T4	
		3MHz	18900	00GC5	6.40	-48.63		1.84	55.03	20.00	-35.03	T4	
		1.4MHz	18900	00GC5	6.14	-51.42		1.80	57.56	20.00	-37.56	T4	
	Radial	20MHz	18900	00GC5	-0.09	-50.52	-62.28	N/A	50.43	20.00	-30.43	T4	2.0, 3.8
		15MHz	18900	00GC5	0.12	-48.75			48.87	20.00	-28.87	T4	
		10MHz	18900	00GC5	0.10	-46.60			46.70	20.00	-26.70	T4	
		5MHz	18900	00GC5	0.08	-46.98			47.06	20.00	-27.06	T4	
		3MHz	18900	00GC5	0.35	-46.75			47.10	20.00	-27.10	T4	
		1.4MHz	18900	00GC5	0.45	-47.99			48.44	20.00	-28.44	T4	

FCC ID: PY7-57325M		HAC (T-COIL) TEST REPORT		Approved by: Quality Manager
Filename: 1M2206010068-05-R4.PY7	Test Dates: 3/21/2022 – 6/6/2022	DUT Type: Portable Handset		Page 36 of 88

**Table 8-17**  
**Raw Data Results for LTE B41 Power Class 3**

Mode	Orientation	Bandwidth	Channel	Device SN	ABM1 [dB(A/m)]	ABM2 [dB(A/m)]	Ambient Noise [dB(A/m)]	Frequency Response Margin (dB)	S+N/N (dB)	FCC Limit (dB)	Margin from FCC Limit (dB)	C63.19-2011 Rating	Test Coordinates
LTE Band 41 (PC3)	Axial	20MHz	40620	05JAZ	5.97	-35.79	-61.12	2.00	41.76	20.00	-21.76	T4	2.0, 3.0
		15MHz	40620	05JAZ	5.68	-36.10		2.00	41.78	20.00	-21.78	T4	
		10MHz	41490	05JAZ	5.93	-36.90		2.00	42.83	20.00	-22.83	T4	
		10MHz	41055	05JAZ	5.66	-34.08		2.00	39.74	20.00	-19.74	T4	
		10MHz	40620	05JAZ	5.69	-36.02		2.00	41.71	20.00	-21.71	T4	
		10MHz	40185	05JAZ	6.26	-35.62		2.00	41.88	20.00	-21.88	T4	
		10MHz	39750	05JAZ	5.84	-34.33		2.00	40.17	20.00	-20.17	T4	
		5MHz	40620	05JAZ	5.84	-36.22		2.00	42.06	20.00	-22.06	T4	
	Radial	20MHz	40620	05JAZ	0.17	-34.95	-62.21	N/A	35.12	20.00	-15.12	T4	2.0, 3.8
		15MHz	40620	05JAZ	-0.14	-35.19			35.05	20.00	-15.05	T4	
		10MHz	41490	05JAZ	0.22	-36.21			36.43	20.00	-16.43	T4	
		10MHz	41055	05JAZ	0.17	-33.09			33.26	20.00	-13.26	T4	
		10MHz	40620	05JAZ	-0.19	-34.94			34.75	20.00	-14.75	T4	
		10MHz	40185	05JAZ	0.13	-35.16			35.29	20.00	-15.29	T4	
		10MHz	39750	05JAZ	0.27	-34.47			34.74	20.00	-14.74	T4	
		5MHz	40620	05JAZ	0.22	-35.09			35.31	20.00	-15.31	T4	

**Table 8-18**  
**Raw Data Results for LTE B48**



Mode	Orientation	Bandwidth	Channel	Device SN	ABM1 [dB(A/m)]	ABM2 [dB(A/m)]	Ambient Noise [dB(A/m)]	Frequency Response Margin (dB)	S+N/N (dB)	FCC Limit (dB)	Margin from FCC Limit (dB)	C63.19-2011 Rating	Test Coordinates
LTE Band 48	Axial	20MHz	55990	00GC5	5.87	-44.03	-61.12	2.00	49.90	20.00	-29.90	T4	2.0, 3.0
		15MHz	55990	00GC5	5.94	-44.68		2.00	50.62	20.00	-30.62	T4	
		10MHz	55990	00GC5	5.71	-44.18		2.00	49.89	20.00	-29.89	T4	
		5MHz	55990	00GC5	5.87	-44.85		2.00	50.72	20.00	-30.72	T4	
		20MHz	55990	00GC5	-0.09	-42.21		-62.21	N/A	42.12	20.00	-22.12	
	15MHz	55990	00GC5	-0.03	-42.43	42.40	20.00			-22.40	T4		
	10MHz	55990	00GC5	0.04	-42.38	42.42	20.00			-22.42	T4		
	5MHz	55990	00GC5	-0.10	-42.95	42.85	20.00			-22.85	T4		
	5MHz	55990	00GC5	-0.10	-42.95	42.85	20.00			-22.85	T4		

**Table 8-19**  
**Raw Data Results for EDGE (OTT VoIP)**

Mode	Orientation	Channel	Device SN	ABM1 [dB(A/m)]	ABM2 [dB(A/m)]	Ambient Noise [dB(A/m)]	Frequency Response Margin (dB)	S+N/N (dB)	FCC Limit (dB)	Margin from FCC Limit (dB)	C63.19-2011 Rating	Test Coordinates
EDGE850	Axial	190	05JAZ	28.83	-34.29	-61.12	1.12	63.12	20.00	-43.12	T4	2.0, 3.0
	Radial	190	05JAZ	21.56	-32.33	-62.21	N/A	53.89	20.00	-33.89	T4	2.0, 3.8
EDGE1900	Axial	661	05JAZ	28.73	-36.81	-61.12	1.34	65.54	20.00	-45.54	T4	2.0, 3.0
	Radial	661	05JAZ	21.73	-35.09	-62.21	N/A	56.82	20.00	-36.82	T4	2.0, 3.8

**Table 8-20**  
**Raw Data Results for HSPA (OTT VoIP)**

Mode	Orientation	Channel	Device SN	ABM1 [dB(A/m)]	ABM2 [dB(A/m)]	Ambient Noise [dB(A/m)]	Frequency Response Margin (dB)	S+N/N (dB)	FCC Limit (dB)	Margin from FCC Limit (dB)	C63.19-2011 Rating	Test Coordinates
HSPA V	Axial	4183	05JAZ	28.61	-49.45	-61.12	1.08	78.06	20.00	-58.06	T4	2.0, 3.0
	Radial	4183	05JAZ	21.59	-50.85	-62.21	N/A	72.44	20.00	-52.44	T4	2.0, 3.8
HSPA IV	Axial	1412	05JAZ	28.83	-52.18	-61.12	0.97	81.01	20.00	-61.01	T4	2.0, 3.0
	Radial	1412	05JAZ	21.75	-49.91	-62.21	N/A	71.66	20.00	-51.66	T4	2.0, 3.8
HSPA II	Axial	9400	05JAZ	28.65	-50.26	-61.12	0.88	78.91	20.00	-58.91	T4	2.0, 3.0
	Radial	9400	05JAZ	21.82	-49.75	-62.21	N/A	71.57	20.00	-51.57	T4	2.0, 3.8

FCC ID: PY7-57325M		HAC (T-COIL) TEST REPORT		Approved by: Quality Manager
Filename: 1M2206010068-05-R4.PY7	Test Dates: 3/21/2022 – 6/6/2022	DUT Type: Portable Handset		Page 37 of 88

**Table 8-21**  
**Raw Data Results for LTE FDD B2 (OTT VoIP)**

Mode	Orientation	Bandwidth	Channel	Device SN	ABM1 [dB(A/m)]	ABM2 [dB(A/m)]	Ambient Noise [dB(A/m)]	Frequency Response Margin (dB)	S+N/N (dB)	FCC Limit (dB)	Margin from FCC Limit (dB)	C63.19-2011 Rating	Test Coordinates
LTE Band 2	Axial	20MHz	19100	05JAZ	28.84	-39.88	-61.12	1.12	68.72	20.00	-48.72	T4	2.0, 3.0
		20MHz	18900	05JAZ	28.73	-37.16		0.77	65.89	20.00	-45.89	T4	
		20MHz	18700	05JAZ	29.01	-39.47		1.05	68.48	20.00	-48.48	T4	
		15MHz	18900	05JAZ	28.80	-38.05		1.22	66.85	20.00	-46.85	T4	
		10MHz	18900	05JAZ	28.76	-37.87		0.96	66.63	20.00	-46.63	T4	
		5MHz	18900	05JAZ	28.87	-37.45		1.03	66.32	20.00	-46.32	T4	
		3MHz	18900	05JAZ	29.02	-38.10		1.04	67.12	20.00	-47.12	T4	
	1.4MHz	18900	05JAZ	28.68	-38.15	1.07	66.83	20.00	-46.83	T4			
	Radial	20MHz	19100	05JAZ	21.57	-41.13	-62.21	N/A	62.70	20.00	-42.70	T4	2.0, 3.8
		20MHz	18900	05JAZ	21.74	-39.51			61.25	20.00	-41.25	T4	
		20MHz	18700	05JAZ	21.58	-40.92			62.50	20.00	-42.50	T4	
		15MHz	18900	05JAZ	21.77	-39.99			61.76	20.00	-41.76	T4	
		10MHz	18900	05JAZ	21.68	-40.31			61.99	20.00	-41.99	T4	
		5MHz	18900	05JAZ	21.60	-39.68			61.28	20.00	-41.28	T4	
3MHz		18900	05JAZ	21.57	-40.15	61.72			20.00	-41.72	T4		
1.4MHz	18900	05JAZ	21.64	-40.12	61.76	20.00	-41.76	T4					

**Table 8-22**  
**Raw Data Results for LTE TDD B41 (PC3) (OTT VoIP)**



Mode	Orientation	Bandwidth	Channel	Device SN	ABM1 [dB(A/m)]	ABM2 [dB(A/m)]	Ambient Noise [dB(A/m)]	Frequency Response Margin (dB)	S+N/N (dB)	FCC Limit (dB)	Margin from FCC Limit (dB)	C63.19-2011 Rating	Test Coordinates	
LTE Band 41 (PC3)	Axial	20MHz	40620	05JAZ	28.71	-33.22	-61.12	1.17	61.93	20.00	-41.93	T4	2.0, 3.0	
		15MHz	40620	05JAZ	28.77	-33.35		1.23	62.12	20.00	-42.12	T4		
		10MHz	41490	05JAZ	28.80	-34.65		1.07	63.45	20.00	-43.45	T4		
		10MHz	41055	05JAZ	28.74	-32.58		1.08	61.32	20.00	-41.32	T4		
		10MHz	40620	05JAZ	28.79	-33.07		1.06	61.86	20.00	-41.86	T4		
		10MHz	40185	05JAZ	28.71	-33.86		1.15	62.57	20.00	-42.57	T4		
		10MHz	39750	05JAZ	29.06	-33.01		1.00	62.07	20.00	-42.07	T4		
	Radial	5MHz	40620	05JAZ	28.74	-33.29	-62.21	N/A	1.01	62.03	20.00	-42.03	T4	2.0, 3.8
		20MHz	41490	05JAZ	21.62	-35.03			56.65	20.00	-36.65	T4		
		20MHz	41055	05JAZ	21.59	-32.63			54.22	20.00	-34.22	T4		
		20MHz	40620	05JAZ	21.58	-33.75			55.33	20.00	-35.33	T4		
		20MHz	40185	05JAZ	21.82	-35.29			57.11	20.00	-37.11	T4		
		20MHz	39750	05JAZ	21.75	-33.77			55.52	20.00	-35.52	T4		
		15MHz	40620	05JAZ	21.79	-34.59			56.38	20.00	-36.38	T4		
10MHz	40620	05JAZ	21.54	-34.38	55.92	20.00	-35.92	T4						
5MHz	40620	05JAZ	21.73	-34.34	56.07	20.00	-36.07	T4						

**Table 8-23**  
**Raw Data Results for NR FDD n71 (OTT VoIP)**

Mode	Orientation	Bandwidth	Channel	Device SN	ABM1 <sub>LTE</sub> [dB(A/m)]	ABM2 <sub>NR</sub> [dB(A/m)]	Ambient Noise [dB(A/m)]	Frequency Response Margin (dB)	S+N/N <sub>LTE</sub> (dB)	S+N/N <sub>NR</sub> - 3 dB (dB)	FCC Limit (dB)	Margin from FCC Limit (dB)	C63.19-2011 Rating	Test Coordinates
NR n71	Axial	20MHz	136100	00GC5	28.82	-42.58	-61.12	N/A	71.40	68.40	20.00	-48.40	T4	2.0, 3.0
		15MHz	136100	00GC5	28.82	-42.41			71.23	68.23	20.00	-48.23	T4	
		10MHz	136100	00GC5	28.82	-43.89			72.71	69.71	20.00	-49.71	T4	
		5MHz	139100	00GC5	28.82	-44.71			73.53	70.53	20.00	-50.53	T4	
		5MHz	136100	00GC5	28.82	-42.28			71.10	68.10	20.00	-48.10	T4	
		5MHz	133100	00GC5	28.82	-42.09			70.91	67.91	20.00	-47.91	T4	
		5MHz	136100	00GC5	21.80	-43.98			65.78	62.78	20.00	-42.78	T4	
	Radial	15MHz	136100	00GC5	21.80	-44.16	-62.21	N/A	65.96	62.96	20.00	-42.96	T4	2.0, 3.8
		10MHz	136100	00GC5	21.80	-44.02			65.82	62.82	20.00	-42.82	T4	
		5MHz	139100	00GC5	21.80	-43.62			65.42	62.42	20.00	-42.42	T4	
		5MHz	136100	00GC5	21.80	-43.47			65.27	62.27	20.00	-42.27	T4	
		5MHz	133100	00GC5	21.80	-42.09			63.89	60.89	20.00	-40.89	T4	

**Table 8-24**  
**Raw Data Results for LTE FDD B71 (OTT VoIP – Additional Measurements for NR)**

Mode	Orientation	Bandwidth	Channel	Device SN	ABM1 <sub>LTE</sub> [dB(A/m)]	ABM2 <sub>NR</sub> [dB(A/m)]	Ambient Noise [dB(A/m)]	Frequency Response Margin (dB)	S+N/N <sub>LTE</sub> (dB)	S+N/N <sub>NR</sub> - 3 dB (dB)	FCC Limit (dB)	Margin from FCC Limit (dB)	C63.19-2011 Rating	Test Coordinates
LTE Band 71	Axial	20MHz	133297	00GC5	28.82	N/A	-61.12	N/A	71.38	N/A	20.00	-51.38	T4	2.0, 3.0
	Radial	20MHz	133297	00GC5	21.80		-62.21		65.26		20.00	-45.26	T4	2.0, 3.8

FCC ID: PY7-57325M		HAC (T-COIL) TEST REPORT		Approved by: Quality Manager
Filename: 1M2206010068-05-R4.PY7	Test Dates: 3/21/2022 – 6/6/2022	DUT Type: Portable Handset		Page 38 of 88

**Table 8-25**  
**Raw Data Results for NR TDD n41 (OTT VoIP)**

Mode	Orientation	Bandwidth	Channel	Device SN	ABM1 <sub>LTE</sub> [dB(A/m)]	ABM2 <sub>NR</sub> [dB(A/m)]	Ambient Noise [dB(A/m)]	Frequency Response Margin (dB)	S+N/N <sub>ref</sub> (dB)	S+N/N <sub>ref</sub> - 3 dB (dB)	FCC Limit (dB)	Margin from FCC Limit (dB)	C63.19-2011 Rating	Test Coordinates
NR n41	Axial	100MHz	518598	00GC5	29.13	-40.90	-58.77	N/A	70.03	67.03	20.00	-47.03	T4	2.0, 3.0
		90MHz	518598	00GC5	29.13	-41.02			70.15	67.15	20.00	-47.15	T4	
		80MHz	518598	00GC5	29.13	-41.03			70.16	67.16	20.00	-47.16	T4	
		60MHz	518598	00GC5	29.13	-40.98			70.11	67.11	20.00	-47.11	T4	
		50MHz	518598	00GC5	29.13	-40.86			69.99	66.99	20.00	-46.99	T4	
		40MHz	518598	00GC5	29.13	-40.84			69.97	66.97	20.00	-46.97	T4	
		30MHz	534996	00GC5	29.13	-39.96			69.09	66.09	20.00	-46.09	T4	
		30MHz	526800	00GC5	29.13	-40.15			69.28	66.28	20.00	-46.28	T4	
		30MHz	518598	00GC5	29.13	-40.74			69.87	66.87	20.00	-46.87	T4	
		30MHz	510402	00GC5	29.13	-40.05			69.18	66.18	20.00	-46.18	T4	
	30MHz	502200	00GC5	29.13	-40.35	69.48	66.48	20.00	-46.48	T4				
	20MHz	518598	00GC5	29.13	-40.81	69.94	66.94	20.00	-46.94	T4				
	Radial	100MHz	518598	00GC5	21.87	-33.59	-58.17	N/A	55.46	52.46	20.00	-32.46	T4	2.0, 3.8
		90MHz	518598	00GC5	21.87	-33.52			55.39	52.39	20.00	-32.39	T4	
		80MHz	518598	00GC5	21.87	-32.94			54.81	51.81	20.00	-31.81	T4	
		60MHz	531996	00GC5	21.87	-33.02			54.89	51.89	20.00	-31.89	T4	
		60MHz	525300	00GC5	21.87	-31.56			53.43	50.43	20.00	-30.43	T4	
		60MHz	518598	00GC5	21.87	-32.31			54.18	51.18	20.00	-31.18	T4	
		60MHz	511902	00GC5	21.87	-32.98			54.85	51.85	20.00	-31.85	T4	
		60MHz	505200	00GC5	21.87	-32.20			54.07	51.07	20.00	-31.07	T4	
50MHz		518598	00GC5	21.87	-32.92	54.79			51.79	20.00	-31.79	T4		
40MHz		518598	00GC5	21.87	-32.73	54.60			51.60	20.00	-31.60	T4		
30MHz	518598	00GC5	21.87	-32.83	54.70	51.70	20.00	-31.70	T4					
20MHz	518598	00GC5	21.87	-32.70	54.57	51.57	20.00	-31.57	T4					

**Table 8-26**  
**Raw Data Results for LTE TDD B41 (OTT VoIP – Additional Measurements for NR)**



Mode	Orientation	Bandwidth	Channel	Device SN	ABM1 <sub>LTE</sub> [dB(A/m)]	ABM2 <sub>NR</sub> [dB(A/m)]	Ambient Noise [dB(A/m)]	Frequency Response Margin (dB)	S+N/N <sub>LTE</sub> (dB)	S+N/N <sub>ref</sub> - 3 dB (dB)	FCC Limit (dB)	Margin from FCC Limit (dB)	C63.19-2011 Rating	Test Coordinates
LTE Band 41	Axial	20MHz	40620	00GC5	29.13	N/A	-58.77	N/A	62.28	N/A	20.00	-42.28	T4	2.0, 3.0
	Radial	20MHz	40620	00GC5	21.87	N/A	-58.17		54.99	N/A	20.00	-34.99	T4	2.0, 3.8

**Table 8-27**  
**Raw Data Results for 2.4GHz WIFI (OTT VoIP)**

Mode	Orientation	Channel	Device SN	ABM1 [dB(A/m)]	ABM2 [dB(A/m)]	Ambient Noise [dB(A/m)]	Frequency Response Margin (dB)	S+N/N (dB)	FCC Limit (dB)	Margin from FCC Limit (dB)	C63.19-2011 Rating	Test Coordinates
IEEE 802.11b	Axial	6	05JAZ	29.08	-38.22	-58.28	1.14	67.30	20.00	-47.30	T4	2.0, 3.0
	Radial	6	05JAZ	21.97	-45.39	-62.21	N/A	67.36	20.00	-47.36	T4	2.0, 3.8
IEEE 802.11g	Axial	6	05JAZ	28.92	-39.69	-58.28	0.97	68.61	20.00	-48.61	T4	2.0, 3.0
	Radial	6	05JAZ	21.60	-47.12	-62.21	N/A	68.72	20.00	-48.72	T4	2.0, 3.8
IEEE 802.11n	Axial	6	05JAZ	28.98	-38.52	-58.28	1.10	67.50	20.00	-47.50	T4	2.0, 3.0
	Radial	6	05JAZ	21.70	-44.28	-62.21	N/A	65.98	20.00	-45.98	T4	2.0, 3.8
IEEE 802.11ax SU	Axial	1	05JAZ	28.96	-41.37	-58.28	1.11	70.33	20.00	-50.33	T4	2.0, 3.0
		6	05JAZ	28.91	-38.38		1.22	67.29	20.00	-47.29	T4	
		11	05JAZ	28.95	-40.71		1.15	69.66	20.00	-49.66	T4	
	Radial	1	05JAZ	21.57	-46.64	-62.21	N/A	68.21	20.00	-48.21	T4	2.0, 3.8
		6	05JAZ	21.51	-44.37			65.88	20.00	-45.88	T4	
IEEE 802.11ax RU	Axial	6	05JAZ	28.81	-38.53	-58.28	1.18	67.34	20.00	-47.34	T4	2.0, 3.0
	Radial	6	05JAZ	21.54	-45.40	-62.21	N/A	66.94	20.00	-46.94	T4	2.0, 3.8

**Table 8-28**  
**Raw Data Results for 5GHz WIFI IEEE 802.11a (OTT VoIP)**

Mode	Orientation	Bandwidth	U-NII	Channel	Device SN	ABM1 [dB(A/m)]	ABM2 [dB(A/m)]	Ambient Noise [dB(A/m)]	Frequency Response Margin (dB)	S+N/N (dB)	FCC Limit (dB)	Margin from FCC Limit (dB)	C63.19-2011 Rating	Test Coordinates
IEEE 802.11a	Axial	20MHz	1	40	05JAZ	29.14	-39.94	-58.28	1.14	69.08	20.00	-49.08	T4	2.0, 3.0
	Radial	20MHz	1	40	05JAZ	21.72	-47.26	-62.21	N/A	68.98	20.00	-48.98	T4	2.0, 3.8

FCC ID: PY7-57325M		HAC (T-COIL) TEST REPORT		Approved by: Quality Manager
Filename: 1M2206010068-05-R4.PY7	Test Dates: 3/21/2022 – 6/6/2022	DUT Type: Portable Handset		Page 39 of 88

**Table 8-29**  
**Raw Data Results for 5GHz WIFI IEEE 802.11n (OTT VoIP)**

Mode	Orientation	Bandwidth	U-NII	Channel	Device SN	ABM1 [dB(A/m)]	ABM2 [dB(A/m)]	Ambient Noise [dB(A/m)]	Frequency Response Margin (dB)	S+N/N (dB)	FCC Limit (dB)	Margin from FCC Limit (dB)	C63.19-2011 Rating	Test Coordinates
IEEE 802.11n	Axial	40MHz	1	38	05JAZ	28.98	-38.98	-58.28	1.19	67.96	20.00	-47.96	T4	2.0, 3.0
		20MHz	1	40	05JAZ	29.35	-38.70		1.18	68.05	20.00	-48.05	T4	
	Radial	40MHz	1	38	05JAZ	21.63	-45.82	-62.21	N/A	67.45	20.00	-47.45	T4	
		20MHz	1	40	05JAZ	21.66	-46.12			67.78	20.00	-47.78	T4	

**Table 8-30**  
**Raw Data Results for 5GHz WIFI IEEE 802.11ac (OTT VoIP)**

Mode	Orientation	Bandwidth	U-NII	Channel	Device SN	ABM1 [dB(A/m)]	ABM2 [dB(A/m)]	Ambient Noise [dB(A/m)]	Frequency Response Margin (dB)	S+N/N (dB)	FCC Limit (dB)	Margin from FCC Limit (dB)	C63.19-2011 Rating	Test Coordinates
IEEE 802.11ac	Axial	40MHz	1	38	05JAZ	29.32	-38.57	-58.28	1.26	67.89	20.00	-47.89	T4	2.0, 3.0
		20MHz	1	40	05JAZ	28.98	-39.24		1.23	68.22	20.00	-48.22	T4	
	Radial	40MHz	1	38	05JAZ	21.60	-45.72	-62.21	N/A	67.32	20.00	-47.32	T4	
		20MHz	1	40	05JAZ	21.68	-46.66			68.34	20.00	-48.34	T4	



**Table 8-31**  
**Raw Data Results for 5GHz WIFI IEEE 802.11ax (OTT VoIP)**

Mode	Orientation	Bandwidth	U-NII	Channel	Device SN	ABM1 [dB(A/m)]	ABM2 [dB(A/m)]	Ambient Noise [dB(A/m)]	Frequency Response Margin (dB)	S+N/N (dB)	FCC Limit (dB)	Margin from FCC Limit (dB)	C63.19-2011 Rating	Test Coordinates		
IEEE 802.11ax SU	Axial	40MHz	1	38	05JAZ	29.03	-38.86	-58.28	1.33	67.89	20.00	-47.89	T4	2.0, 3.0		
		20MHz	1	40	05JAZ	28.94	-38.57		1.17	67.51	20.00	-47.51	T4			
	Radial	40MHz	1	38	05JAZ	21.63	-46.33	-62.21	N/A	67.96	20.00	-47.96	T4			
		20MHz	1	40	05JAZ	21.83	-45.23			67.06	20.00	-47.06	T4			
	IEEE 802.11ax RU	Axial	40MHz	1	38	05JAZ	28.82	-38.65	-58.28	1.05	67.47	20.00	-47.47		T4	2.0, 3.0
			20MHz	1	36	05JAZ	28.84	-38.74		1.28	67.58	20.00	-47.58		T4	
20MHz			1	40	05JAZ	29.39	-37.10	1.08		66.49	20.00	-46.49	T4			
20MHz			1	48	05JAZ	29.11	-37.81	1.25		66.92	20.00	-46.92	T4			
40MHz			2A	54	05JAZ	29.00	-37.99	1.14		66.99	20.00	-46.99	T4			
20MHz			2A	56	05JAZ	28.86	-37.99	1.21		66.85	20.00	-46.85	T4			
40MHz			2C	118	05JAZ	29.01	-38.81	1.20		67.82	20.00	-47.82	T4			
20MHz			2C	120	05JAZ	29.25	-38.80	0.96		68.05	20.00	-48.05	T4			
40MHz			3	151	05JAZ	29.13	-40.29	1.22		69.42	20.00	-49.42	T4			
20MHz			3	157	05JAZ	28.92	-40.10	0.97		69.02	20.00	-49.02	T4			
40MHz			5	3	05HAZ	28.67	-43.09	0.99		71.76	20.00	-51.76	T4			
20MHz			5	1	05HAZ	28.48	-44.05	1.04		72.53	20.00	-52.53	T4			
Radial		40MHz	1	38	05JAZ	21.86	-45.00	-62.21	N/A	66.86	20.00	-46.86	T4	2.0, 3.8		
		20MHz	1	36	05JAZ	21.55	-45.95			67.50	20.00	-47.50	T4			
		20MHz	1	40	05JAZ	21.80	-45.01			66.61	20.00	-46.61	T4			
		20MHz	1	48	05JAZ	21.66	-45.66			67.22	20.00	-47.22	T4			
		40MHz	2A	54	05JAZ	21.68	-45.77			67.45	20.00	-47.45	T4			
		20MHz	2A	56	05JAZ	21.58	-45.29			66.87	20.00	-46.87	T4			
		40MHz	2C	118	05JAZ	21.70	-45.93			67.63	20.00	-47.63	T4			
		20MHz	2C	120	05JAZ	21.70	-46.75			68.45	20.00	-48.45	T4			
		40MHz	3	151	05JAZ	21.72	-48.67			70.39	20.00	-50.39	T4			
		20MHz	3	157	05JAZ	21.65	-46.17			67.82	20.00	-47.82	T4			
		40MHz	5	3	05HAZ	21.71	-47.27			68.98	20.00	-48.98	T4			
		20MHz	5	1	05HAZ	21.99	-45.91			67.90	20.00	-47.90	T4			

## II. Test Notes

### A. General

1. Phone Condition: Mute on; Backlight off; Max Volume; Max Contrast
2. 'Radial' orientation refers to radial transverse.
3. Hearing Aid Mode (Phone > Settings > Accessibility > Hearing aids) ON was set to ON for Frequency Response compliance
4. Speech Signal: ITU-T P.50 Artificial Voice
5. Bluetooth and WIFI were disabled while testing 2G/3G/4G/5G modes.
6. Licensed data modes and Bluetooth were disabled while testing WIFI modes.
7. The Margin from FCC limit column indicates a margin from the FCC limit for compliance (T4).

FCC ID: PY7-57325M		HAC (T-COIL) TEST REPORT		Approved by: Quality Manager
Filename: 1M2206010068-05-R4.PY7	Test Dates: 3/21/2022 – 6/6/2022	DUT Type: Portable Handset		Page 40 of 88



B. GSM

1. Power Configuration: GSM850: PCL=5, GSM1900: PCL=0;
2. Vocoder Configuration: EFR (GSM);

C. UMTS

1. Power Configuration: TPC= "All 1s";
2. Vocoder Configuration: WB AMR 6.60kbps (UMTS);

D. LTE FDD

1. Power Configuration: TPC = "Max Power"
2. Radio Configuration: 16QAM, 1RB, 50%RB offset
3. Vocoder Configuration: WB AMR 6.60kbps
4. The worst-case band and bandwidth combination for each probe orientation is additionally tested on the low and high channels for those combinations. LTE Band 2 at 20MHz is the worst-case for both Axial and Radial probe orientations.

E. LTE TDD

1. Power Configuration: TPC = "Max Power"
2. Radio Configuration: 16QAM, 1RB, 50%RB offset
3. Power Class 3 Uplink-Downlink configuration: 0
4. Vocoder Configuration: WB AMR 6.60kbps
5. The worst-case band and bandwidth combination for each probe orientation is additionally tested on the low, low-mid, high-mid, and high channels for those combinations. LTE Band 41 (Power Class 3) at 10MHz is the worst-case for both Axial and Radial probe orientations.

F. OTT VoIP

1. Vocoder Configuration: 6kbps
2. EDGE Configuration
  - a. MCS Index: 7
  - b. Number of TX slots: 2
3. HSPA Configuration:
  - a. Release: 6
  - b. 3GPP 34.121 Subtest 1
4. LTE FDD Configuration:
  - a. Power Configuration: TPC = "Max Power"
  - b. Radio Configuration: 16QAM, 1RB, 50%RB offset
  - c. LTE Band 2 was the worst-case band from Table 6-5 and was used to test both Axial and Radial probe orientations.
  - d. The worst-case band and bandwidth combination for each probe orientation is additionally tested on the low and high channels for those combinations. LTE Band 2 at 20MHz is the worst-case for both Axial and Radial probe orientations.
5. LTE TDD Configuration:
  - a. Power Configuration: TPC = "Max Power"
  - b. Radio Configuration: 16QAM, 1RB, 50%RB offset
  - c. LTE Band 41 (PC3) was the worst-case band from Table 6-6 and was used to test both Axial and Radial probe orientations.
  - d. The worst-case band and bandwidth combination for each probe orientation is additionally tested on the low, low-mid, high-mid, and high channels for those combinations. LTE Band

FCC ID: PY7-57325M		HAC (T-COIL) TEST REPORT	<b>SONY</b>	Approved by: Quality Manager
Filename: 1M2206010068-05-R4.PY7	Test Dates: 3/21/2022 – 6/6/2022	DUT Type: Portable Handset		Page 41 of 88

41 (Power Class 3) at 10MHz is the worst-case for the Axial probe orientation. LTE Band 41 (Power Class 3) at 20MHz is the worst-case for the Radial probe orientation.

6. NR FDD Configuration

- a. Power Configuration: TxAGC is set such that the DUT operates at max power.
- b. Radio Configuration: DFT-s-OFDM, 16QAM, 1RB, 50%RB offset
- c. Due to equipment limitations, ABM1 measurements were not possible. Therefore, the procedure outlined in Section 6.6.II.4 was followed to obtain SNNR values. Additionally, Frequency Response measurements were not possible due to equipment limitations.
- d. NR n71 was the worst-case band from Table 6-10 and was used to test both Axial and Radial probe orientations.
- e. The worst-case band and bandwidth combination for each probe orientation is additionally tested on the low and high channels for those combinations. NR n71 at 5MHz is the worst-case for both Axial and Radial probe orientations.

7. NR TDD Configuration

- a. Power Configuration: TxAGC is set such that the DUT operates at max power.
- b. Radio Configuration: DFT-s-OFDM, 16QAM, 1RB, 50%RB offset
- c. Due to equipment limitations, ABM1 measurements were not possible. Therefore, the procedure outlined in Section 6.6.II.4 was followed to obtain SNNR values. Additionally, Frequency Response measurements were not possible due to equipment limitations.
- d. NR n41 was the worst-case band from Table 6-11 and was used to test both Axial and Radial probe orientations.
- e. The worst-case band and bandwidth combination for each probe orientation is additionally tested on the low and high channels for those combinations. NR n41 at 30MHz is the worst-case for the Axial probe orientation. NR n41 at 60MHz is the worst-case for the Radial probe orientation.

8. WIFI Configuration:

- a. Radio Configuration
  - i. IEEE 802.11b: CCK, 5.5Mbps
  - ii. IEEE 802.11g/a: BPSK, 9Mbps
  - iii. IEEE 802.11n/ac 20MHz: QPSK, MCS 1
  - iv. IEEE 802.11ax SU 20MHz: QPSK, MCS 1
  - v. IEEE 802.11n/ac 40MHz: QPSK, MCS 1
  - vi. IEEE 802.11ax SU 40MHz: BPSK, MCS 0
- b. RU Index
  - i. IEEE 802.11ax RU 20MHz: RU Index 40
  - ii. IEEE 802.11ax RU 40MHz: RU Index 44
- c. The worst-case standard for 2.4GHz WIFI in each probe orientation is additionally tested on the low and high channels. IEEE 802.11ax SU is the worst-case for both Axial and Radial probe orientations.
- d. The worst-case standard for 5GHz WIFI in each probe orientation is additionally tested on higher U-NII bands as well as applicable low and high channels. IEEE 802.11ax RU 20MHz BW (U-NII 1) is the worst-case for both Axial and Radial probe orientations.

FCC ID: PY7-57325M		HAC (T-COIL) TEST REPORT	<b>SONY</b>	Approved by: Quality Manager
Filename: 1M2206010068-05-R4.PY7	Test Dates: 3/21/2022 – 6/6/2022	DUT Type: Portable Handset		Page 42 of 88

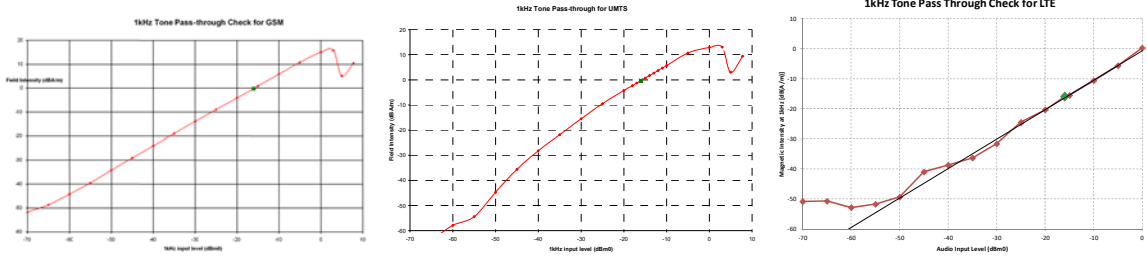

### III. 1 kHz Vocoder Application Check

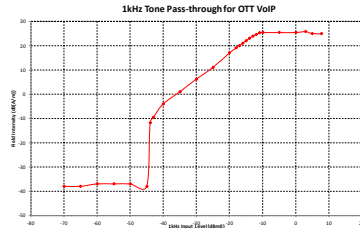

This model was verified to be within the linear region for ABM1 measurements at -16 dBm0 for GSM, UMTS, and VoLTE over IMS. This measurement was taken in the axial configuration above the maximum location.



This model was verified to be within the linear region for ABM1 measurements at -20 dBm0 for OTT VoIP. This measurement was taken in the axial configuration above the maximum location.

FCC ID: PY7-57325M		HAC (T-COIL) TEST REPORT		Approved by: Quality Manager
Filename: 1M2206010068-05-R4.PY7	Test Dates: 3/21/2022 – 6/6/2022	DUT Type: Portable Handset		Page 43 of 88

#### IV. T-Coil Validation Test Results

**Table 8-32  
Helmholtz Coil Verification Table of Results – 03/21/22**

Item	Target	Result	Verdict
Axial			
Magnetic Intensity, -10 dBA/m	-10 ± 0.5 dB	-9.969	PASS
Environmental Noise	< -58 dBA/m	-58.28	PASS
Frequency Response, from limits	> 0 dB	0.80	PASS
Radial			
Magnetic Intensity, -10 dBA/m	-10 ± 0.5 dB	-10.212	PASS
Environmental Noise	< -58 dBA/m	-58.83	PASS
Frequency Response, from limits	> 0 dB	0.80	PASS

**Table 8-33  
Helmholtz Coil Verification Table of Results – 03/28/22**

Item	Target	Result	Verdict
Axial			
Magnetic Intensity, -10 dBA/m	-10 ± 0.5 dB	-10.030	PASS
Environmental Noise	< -58 dBA/m	-61.12	PASS
Frequency Response, from limits	> 0 dB	0.80	PASS
Radial			
Magnetic Intensity, -10 dBA/m	-10 ± 0.5 dB	-10.144	PASS
Environmental Noise	< -58 dBA/m	-62.21	PASS
Frequency Response, from limits	> 0 dB	0.80	PASS

**Table 8-34  
Helmholtz Coil Verification Table of Results – 04/04/22**

Item	Target	Result	Verdict
Axial			
Magnetic Intensity, -10 dBA/m	-10 ± 0.5 dB	-9.802	PASS
Environmental Noise	< -58 dBA/m	-58.77	PASS
Frequency Response, from limits	> 0 dB	0.50	PASS
Radial			
Magnetic Intensity, -10 dBA/m	-10 ± 0.5 dB	-10.219	PASS
Environmental Noise	< -58 dBA/m	-58.17	PASS
Frequency Response, from limits	> 0 dB	0.70	PASS

FCC ID: PY7-57325M		HAC (T-COIL) TEST REPORT	<b>SONY</b>	Approved by: Quality Manager
Filename: 1M2206010068-05-R4.PY7	Test Dates: 3/21/2022 – 6/6/2022	DUT Type: Portable Handset		Page 44 of 88

**Table 8-35  
Helmholtz Coil Verification Table of Results – 04/18/22**

Item	Target	Result	Verdict
Axial			
Magnetic Intensity, -10 dBA/m	-10 ± 0.5 dB	-10.065	PASS
Environmental Noise	< -58 dBA/m	-62.85	PASS
Frequency Response, from limits	> 0 dB	0.70	PASS
Radial			
Magnetic Intensity, -10 dBA/m	-10 ± 0.5 dB	-10.282	PASS
Environmental Noise	< -58 dBA/m	-62.28	PASS
Frequency Response, from limits	> 0 dB	0.70	PASS

**Table 8-36  
Helmholtz Coil Verification Table of Results – 06/06/22**

Item	Target	Result	Verdict
Axial			
Magnetic Intensity, -10 dBA/m	-10 ± 0.5 dB	-10.073	PASS
Environmental Noise	< -58 dBA/m	-61.19	PASS
Frequency Response, from limits	> 0 dB	0.70	PASS
Radial			
Magnetic Intensity, -10 dBA/m	-10 ± 0.5 dB	-10.183	PASS
Environmental Noise	< -58 dBA/m	-61.28	PASS
Frequency Response, from limits	> 0 dB	0.70	PASS

FCC ID: PY7-57325M		HAC (T-COIL) TEST REPORT	<b>SONY</b>	Approved by: Quality Manager
Filename: 1M2206010068-05-R4.PY7	Test Dates: 3/21/2022 – 6/6/2022	DUT Type: Portable Handset		Page 45 of 88

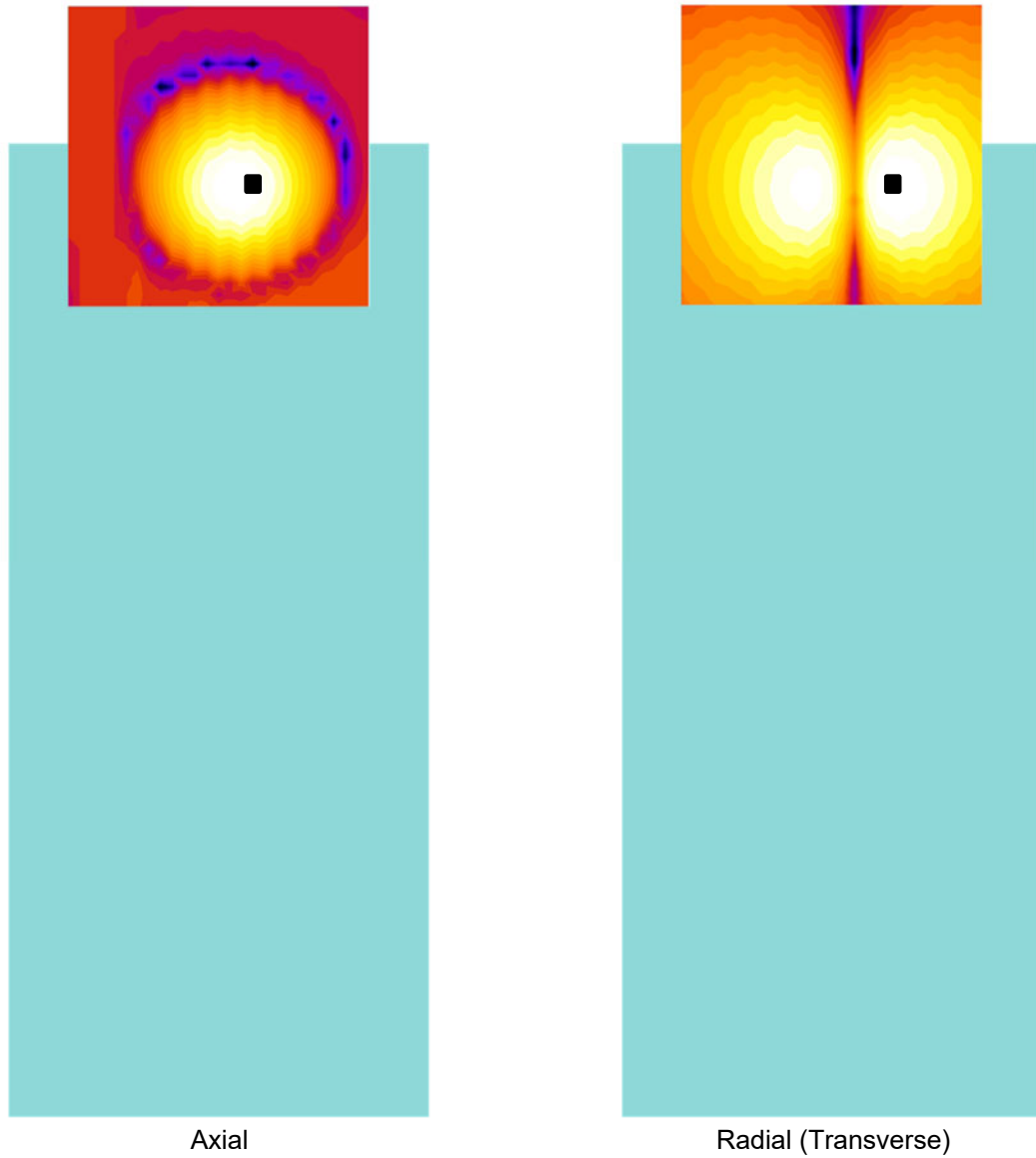

## V. ABM1 Magnetic Field Distribution Scan Overlays



**Figure 8-1**  
**T-Coil Scan Overlay Magnetic Field Distributions**

**Notes:**

1. Final measurement locations are indicated by a cursor on the contour plots.
2. See Test Setup Photographs for actual WD overlay.

FCC ID: PY7-57325M		HAC (T-COIL) TEST REPORT		Approved by: Quality Manager
Filename: 1M2206010068-05-R4.PY7	Test Dates: 3/21/2022 – 6/6/2022	DUT Type: Portable Handset		Page 46 of 88

## 9. MEASUREMENT UNCERTAINTY

**Table 9-1  
Uncertainty Estimation Table**

Contribution	Data +/- %	Data +/- dB	Data Type	Probability distribution	Divisor	Standard uncertainty	Standard Uncertainty (dB)
ABM Noise	7.0%	0.29	Std. Dev.	Normal k=1	1.00	7.0%	
RF Reflections	4.7%	0.20	Specification	Rectangular	1.73	2.7%	
Reference Signal Level	12.2%	0.50	Specification	Rectangular	1.73	7.0%	
Positioning Accuracy	10.0%	0.41	Uncertainty	Rectangular	1.73	5.8%	
Probe Coil Sensitivity	12.2%	0.50	Specification	Rectangular	1.73	7.0%	
Probe Linearity	2.4%	0.10	Std. Dev.	Normal k=1	1.00	2.4%	
Cable Loss	2.8%	0.12	Specification	Rectangular	1.73	1.6%	
Frequency Analyzer	5.0%	0.21	Specification	Rectangular	1.73	2.9%	
System Repeatability	5.0%	0.21	Std. Dev.	Normal k=1	1.00	5.0%	
WD Repeatability	9.0%	0.37	Std. Dev.	Normal k=1	1.00	9.0%	
Positioner Accuracy	1.0%	0.04	Specification	Rectangular	1.73	0.6%	
Combined standard uncertainty, $u_c$ (k=1)						17.7%	0.71
Expanded uncertainty (k=2), 95% confidence level						35.3%	1.31

Notes:

1. Test equipments are calibrated according to techniques outlined in NIS81, NIS3003 and NIST Tech Note 1297.
2. All equipments have traceability according to NIST. Measurement Uncertainties are defined in further detail in NIS 81 and NIST Tech Note 1297 and UKAS M3003.

Measurement uncertainty reflects the quality and accuracy of a measured result as compared to the true value. Such statements are generally required when stating results of measurements so that it is clear to the intended audience that the results may differ when reproduced by different facilities. Measurement results vary due to the measurement uncertainty of the instrumentation, measurement technique, and test engineer. Most uncertainties are calculated using the tolerances of the instrumentation used in the measurement, the measurement setup variability, and the technique used in performing the test. While not generally included, the variability of the equipment under test also figures into the overall measurement uncertainty. Another component of the overall uncertainty is based on the variability of repeated measurements (so-called Type A uncertainty). This may mean that the Hearing Aid compatibility tests may have to be repeated by taking down the test setup and resetting it up so that there are a statistically significant number of repeat measurements to identify the measurement uncertainty. By combining the repeat measurement results with that of the instrumentation chain using the technique contained in NIS 81 and NIS 3003, the overall measurement uncertainty was estimated.

FCC ID: PY7-57325M		HAC (T-COIL) TEST REPORT	<b>SONY</b>	Approved by: Quality Manager
Filename: 1M2206010068-05-R4.PY7	Test Dates: 3/21/2022 – 6/6/2022	DUT Type: Portable Handset		Page 47 of 88

## 10. EQUIPMENT LIST

**Table 10-1  
Equipment List**

Manufacturer	Model	Description	Cal Date	Cal Interval	Cal Due	Serial Number
Dell	Latitude E6540	SoundCheck Acoustic Analyzer Laptop	9/29/2020	Biennial	9/29/2022	2655082910
Listen	SoundConnect	Microphone Power Supply	9/24/2020	Biennial	9/24/2022	0899-PS150
RME	Fireface UC	Soundcheck Acoustic Analyzer External Audio Interface	9/29/2020	Biennial	9/29/2022	23792992
Rohde & Schwarz	CMW500	Wideband Radio Communication Tester	9/24/2021	Annual	9/24/2022	167286
Rohde & Schwarz	CMW500	Radio Communication Tester	9/30/2021	Annual	9/30/2022	140144
Rohde & Schwarz	CMW500	Radio Communication Tester	7/19/2021	Annual	7/19/2022	128635
Seekonk	NC-100	Torque Wrench (8" lb)	8/4/2020	Biennial	8/4/2022	21053
TEM	Axial T-Coil Probe	Axial T-Coil Probe	9/23/2020	Biennial	9/23/2022	TEM-1123
TEM	Radial T-Coil Probe	Radial T-Coil Probe	9/23/2020	Biennial	9/23/2022	TEM-1129
TEM		HAC Positioner	N/A		N/A	N/A
TEM		HAC System Controller with Software	N/A		N/A	N/A
TEM	Helmholtz Coil	Helmholtz Coil	9/23/2020	Biennial	9/23/2022	SBI 1052

FCC ID: PY7-57325M		HAC (T-COIL) TEST REPORT	<b>SONY</b>	Approved by: Quality Manager
Filename: 1M2206010068-05-R4.PY7	Test Dates: 3/21/2022 – 6/6/2022	DUT Type: Portable Handset		Page 48 of 88

© 2022 ELEMENT

REV 3.5.M  
8/18/2020

© 2022 ELEMENT All rights reserved. Unless otherwise specified, no part of this report may be reproduced or utilized in any part, form or by any means, electronic or mechanical, including photocopying and microfilm, without permission in writing from ELEMENT. If you have any questions about this international copyright or have an enquiry about obtaining additional rights to this report or assembly of contents thereof, please contact CT.INFO@ELEMENT.COM.



# 11. TEST DATA

<b>FCC ID:</b> PY7-57325M		<b>HAC (T-COIL) TEST REPORT</b>	<b>SONY</b>	<b>Approved by:</b> Quality Manager
<b>Filename:</b> 1M2206010068-05-R4.PY7	<b>Test Dates:</b> 3/21/2022 – 6/6/2022	<b>DUT Type:</b> Portable Handset	Page 49 of 88	

© 2022 ELEMENT

REV 3.5.M  
8/18/2020

© 2022 ELEMENT All rights reserved. Unless otherwise specified, no part of this report may be reproduced or utilized in any part, form or by any means, electronic or mechanical, including photocopying and microfilm, without permission in writing from ELEMENT. If you have any questions about this international copyright or have an enquiry about obtaining additional rights to this report or assembly of contents thereof, please contact CT.INFO@ELEMENT.COM.



**Element Hearing-Aid Compatibility Facility**

**DUT: HH Coil – SN: SBI 1052**

Type: HH Coil  
Serial: SBI 1052

Measurement Standard: ANSI C63.19-2011

**Equipment:**

- Probe: Axial T-Coil Probe – SN: TEM-1123; Calibrated: 9/23/2020
- Helmholtz Coil – SN: SBI 1052; Calibrated: 9/23/2020

**Noise Spectrum**

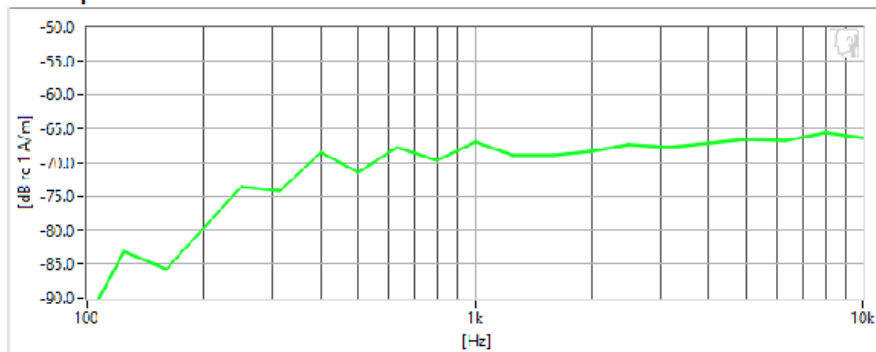

**Frequency Response**

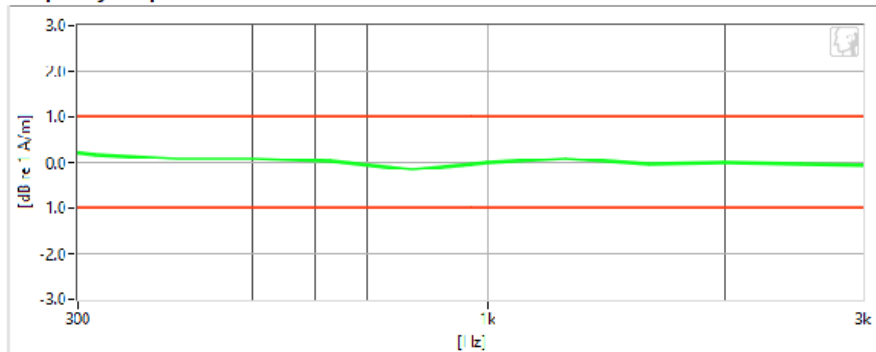

**Results**

Verification 1kHz Intensity	-9.969 dB	✓	Max/Min	-9.5/-10.5
Verification ABM2	-58.28 dB	✓	Maximum	-58.0
Frequency Response Margin	800m dB	✓	Tolerance curves	Aligned Data

FCC ID: PY7-57325M		HAC (T-COIL) TEST REPORT	<b>SONY</b>	Approved by: Quality Manager
Filename: 1M2206010068-05-R4.PY7	Test Dates: 3/21/2022 – 6/6/2022	DUT Type: Portable Handset		Page 50 of 88



**Element Hearing-Aid Compatibility Facility**

**DUT: HH Coil – SN: SBI 1052**

Type: HH Coil  
Serial: SBI 1052

Measurement Standard: ANSI C63.19-2011

**Equipment:**

- Probe: Axial T-Coil Probe – SN: TEM-1123; Calibrated: 9/23/2020
- Helmholtz Coil – SN: SBI 1052; Calibrated: 9/23/2020

**Noise Spectrum**

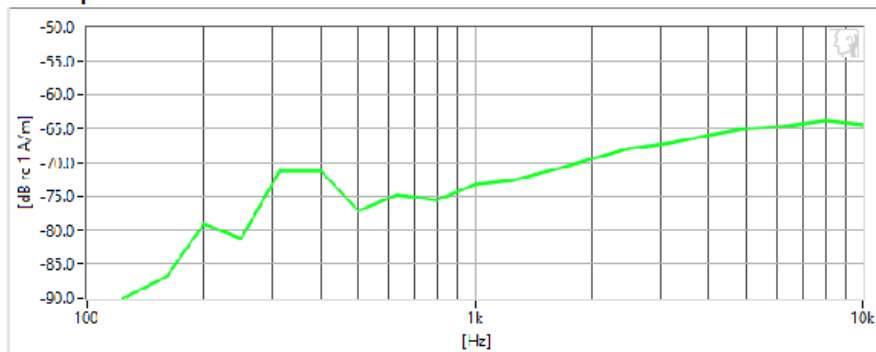

**Frequency Response**

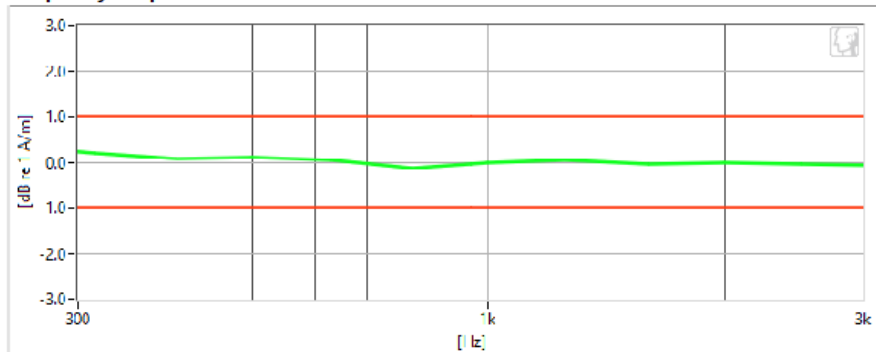

**Results**

Verification 1kHz Intensity	-10.03 dB	✓	Max/Min	-9.5/-10.5
Verification ABM2	-61.12 dB	✓	Maximum	-58.0
Frequency Response Margin	800m dB	✓	Tolerance curves	Aligned Data

FCC ID: PY7-57325M		HAC (T-COIL) TEST REPORT	<b>SONY</b>	Approved by: Quality Manager
Filename: 1M2206010068-05-R4.PY7	Test Dates: 3/21/2022 – 6/6/2022	DUT Type: Portable Handset		Page 51 of 88



**Element Hearing-Aid Compatibility Facility**

**DUT: HH Coil – SN: SBI 1052**

Type: HH Coil  
Serial: SBI 1052

Measurement Standard: ANSI C63.19-2011

**Equipment:**

- Probe: Axial T-Coil Probe – SN: TEM-1123; Calibrated: 9/23/2020
- Helmholtz Coil – SN: SBI 1052; Calibrated: 9/23/2020

**Noise Spectrum**

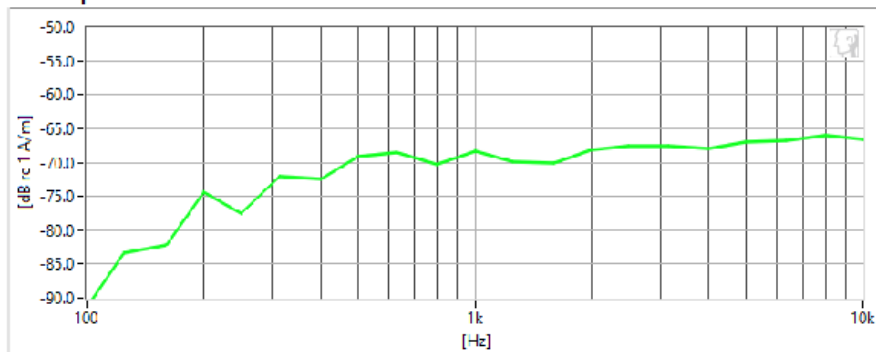

**Frequency Response**

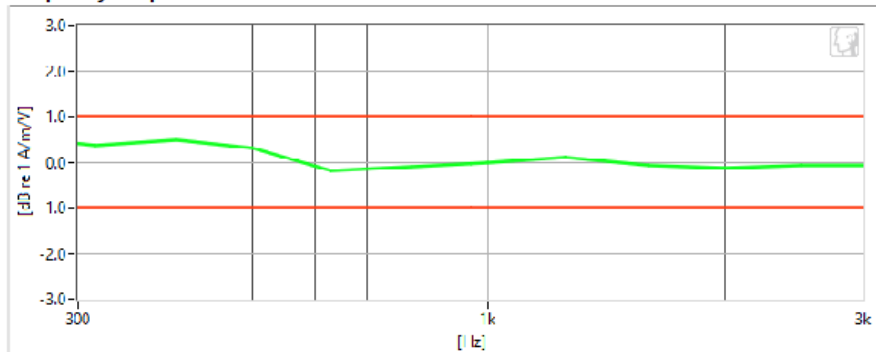

**Results**

Verification 1kHz Intensity	-9.802 dB	✓	Max/Min	-9.5/-10.5
Verification ABM2	-58.77 dB	✓	Maximum	-58.0
Frequency Response Margin	500m dB	✓	Tolerance curves	Aligned Data

FCC ID: PY7-57325M		HAC (T-COIL) TEST REPORT	<b>SONY</b>	Approved by: Quality Manager
Filename: 1M2206010068-05-R4.PY7	Test Dates: 3/21/2022 – 6/6/2022	DUT Type: Portable Handset		Page 52 of 88



**Element Hearing-Aid Compatibility Facility**

**DUT: HH Coil – SN: SBI 1052**

Type: HH Coil  
Serial: SBI 1052

**Measurement Standard:** ANSI C63.19-2011

**Equipment:**

- Probe: Axial T-Coil Probe – SN: TEM-1123; Calibrated: 9/23/2020
- Helmholtz Coil – SN: SBI 1052; Calibrated: 9/23/2020

**Noise Spectrum**

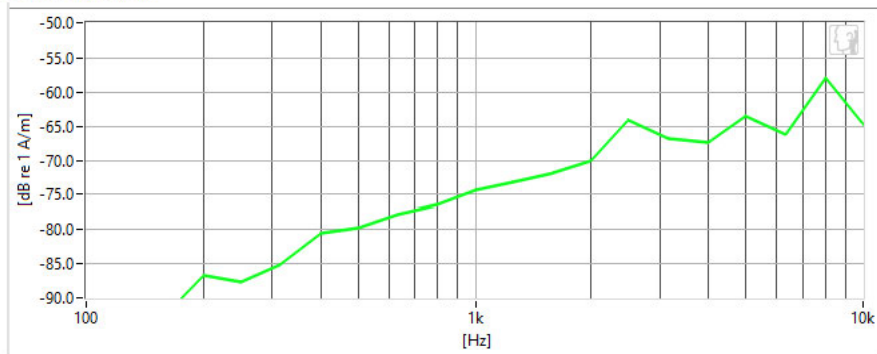

**Frequency Response**

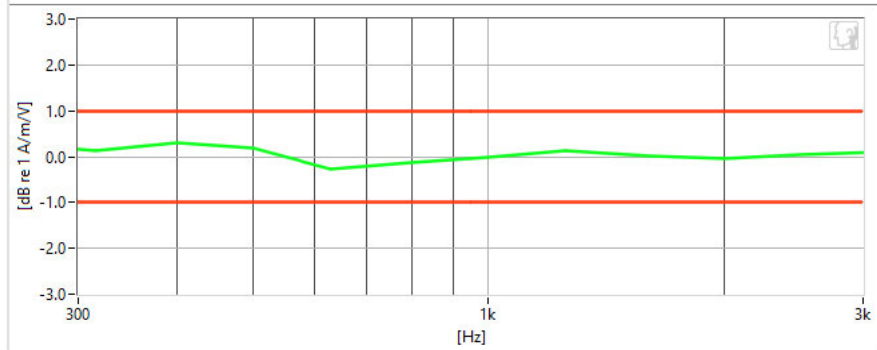

**Results**

Verification 1kHz Intensity	-10.065 dB	✓	Max/Min	-9.5/-10.5
Verification ABM2	-62.85 dB	✓	Maximum	-58.0
Frequency Response Margin	700m dB	✓	Tolerance curves	Aligned Data

FCC ID: PY7-57325M		HAC (T-COIL) TEST REPORT	<b>SONY</b>	Approved by: Quality Manager
Filename: 1M2206010068-05-R4.PY7	Test Dates: 3/21/2022 – 6/6/2022	DUT Type: Portable Handset		Page 53 of 88



## Element Hearing-Aid Compatibility Facility

### DUT: HH Coil – SN: SBI 1052

Type: HH Coil  
Serial: SBI 1052

Measurement Standard: ANSI C63.19-2011

#### Equipment:

- Probe: Axial T-Coil Probe – SN: TEM-1123; Calibrated: 9/23/2020
- Helmholtz Coil – SN: SBI 1052; Calibrated: 9/23/2020

#### Noise Spectrum

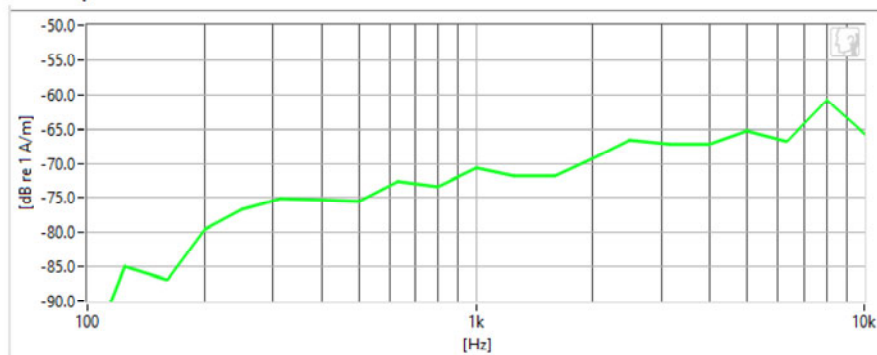

#### Frequency Response

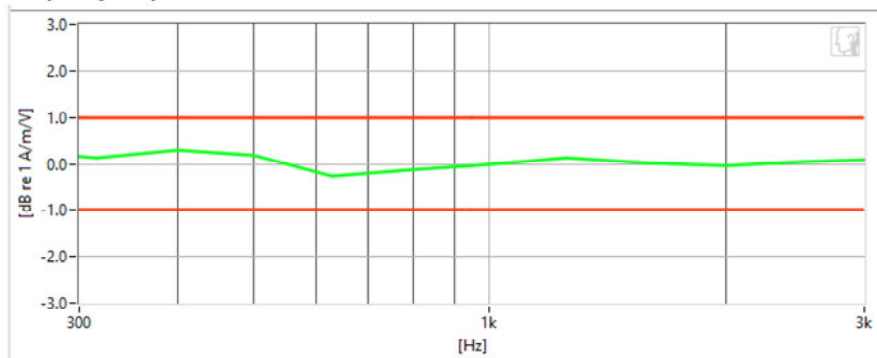

#### Results

Verification 1kHz Intensity	-10.073 dB	✓	Max/Min	-9.5/-10.5
Verification ABM2	-61.19 dB	✓	Maximum	-58.0
Frequency Response Margin	700m dB	✓	Tolerance curves	Aligned Data

FCC ID: PY7-57325M		HAC (T-COIL) TEST REPORT	<b>SONY</b>	Approved by: Quality Manager
Filename: 1M2206010068-05-R4.PY7	Test Dates: 3/21/2022 – 6/6/2022	DUT Type: Portable Handset		Page 54 of 88



**Element Hearing-Aid Compatibility Facility**

**DUT: HH Coil – SN: SBI 1052**

Type: HH Coil  
Serial: SBI 1052

Measurement Standard: ANSI C63.19-2011

**Equipment:**

- Probe: Radial T-Coil Probe – SN: TEM-1129; Calibrated: 9/23/2020
- Helmholtz Coil – SN: SBI 1052; Calibrated: 9/23/2020

**Noise Spectrum**

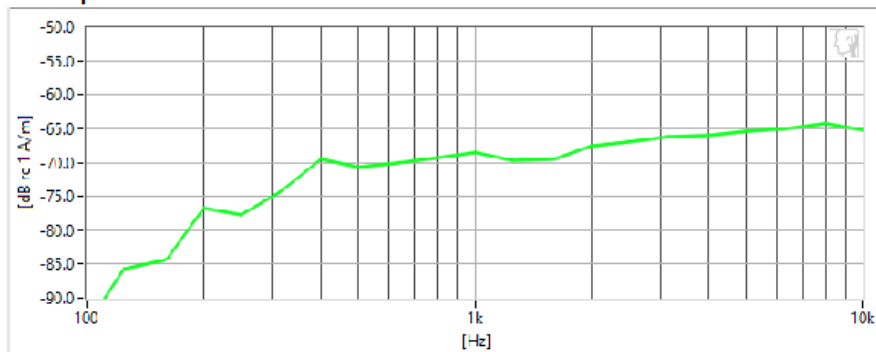

**Frequency Response**

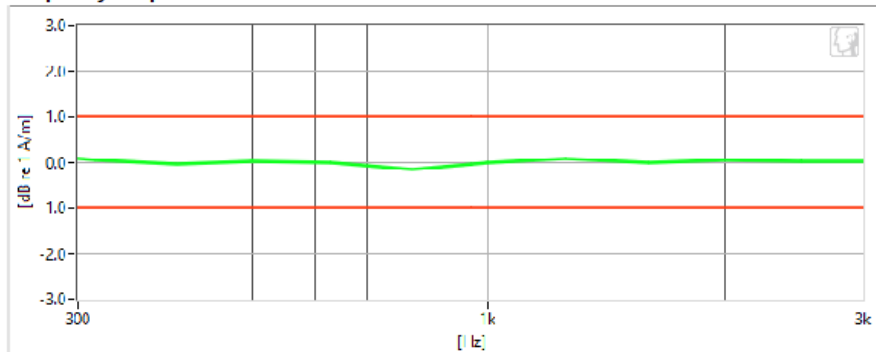

**Results**

Verification 1kHz Intensity	-0.2 ± 2 dB	✓	Max/Min	-9.5/-10.5
Verification ABM2	-58.83 dB	✓	Maximum	-58.0
Frequency Response Margin	800m dB	✓	Tolerance curves	Aligned Data

FCC ID: PY7-57325M		HAC (T-COIL) TEST REPORT	<b>SONY</b>	Approved by: Quality Manager
Filename: 1M2206010068-05-R4.PY7	Test Dates: 3/21/2022 – 6/6/2022	DUT Type: Portable Handset		Page 55 of 88



**Element Hearing-Aid Compatibility Facility**

**DUT: HH Coil – SN: SBI 1052**

Type: HH Coil  
Serial: SBI 1052

Measurement Standard: ANSI C63.19-2011

**Equipment:**

- Probe: Radial T-Coil Probe – SN: TEM-1129; Calibrated: 9/23/2020
- Helmholtz Coil – SN: SBI 1052; Calibrated: 9/23/2020

**Noise Spectrum**

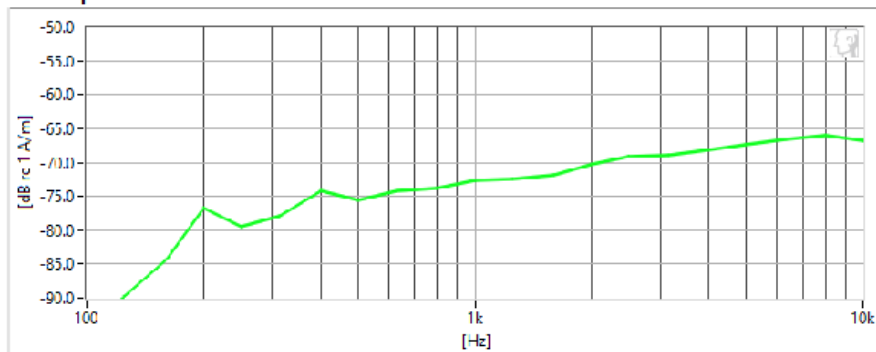

**Frequency Response**

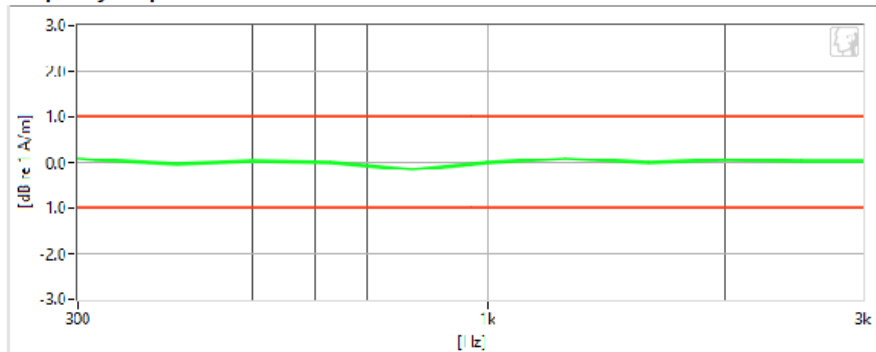

**Results**

Verification 1kHz Intensity	-0.144 dB	✓	Max/Min	-9.5/-10.5
Verification ABM2	-62.21 dB	✓	Maximum	-58.0
Frequency Response Margin	800m dB	✓	Tolerance curves	Aligned Data

FCC ID: PY7-57325M		HAC (T-COIL) TEST REPORT	<b>SONY</b>	Approved by: Quality Manager
Filename: 1M2206010068-05-R4.PY7	Test Dates: 3/21/2022 – 6/6/2022	DUT Type: Portable Handset		Page 56 of 88





## Element Hearing-Aid Compatibility Facility

**DUT: HH Coil – SN: SBI 1052**

Type: HH Coil  
Serial: SBI 1052

**Measurement Standard:** ANSI C63.19-2011

**Equipment:**

- Probe: Radial T-Coil Probe – SN: TEM-1129; Calibrated: 9/23/2020
- Helmholtz Coil – SN: SBI 1052; Calibrated: 9/23/2020

**Noise Spectrum**

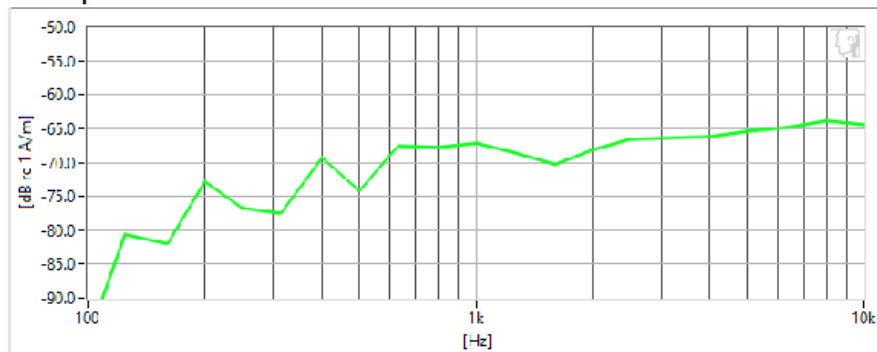

**Frequency Response**

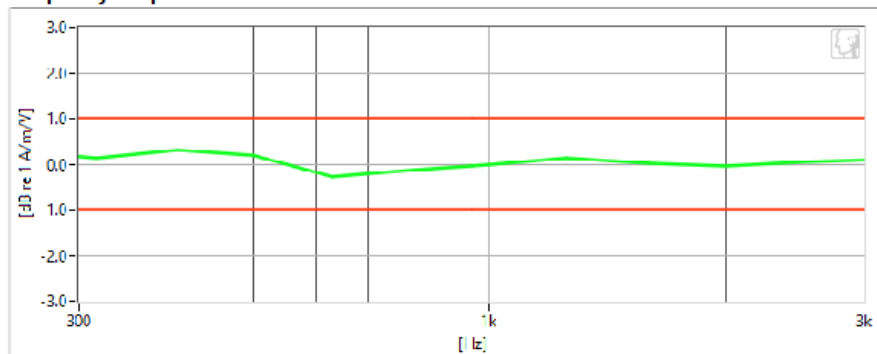

**Results**

Verification 1kHz Intensity	-0.29 dB	✓	Max/Min	-9.5/-10.5
Verification ABM2	-58.17 dB	✓	Maximum	-58.0
Frequency Response Margin	700m dB	✓	Tolerance curves	Aligned Data

FCC ID: PY7-57325M		HAC (T-COIL) TEST REPORT	<b>SONY</b>	Approved by: Quality Manager
Filename: 1M2206010068-05-R4.PY7	Test Dates: 3/21/2022 – 6/6/2022	DUT Type: Portable Handset		Page 57 of 88



**Element Hearing-Aid Compatibility Facility**

**DUT: HH Coil – SN: SBI 1052**

Type: HH Coil  
Serial: SBI 1052

**Measurement Standard:** ANSI C63.19-2011

**Equipment:**

- Probe: Radial T-Coil Probe – SN: TEM-1129; Calibrated: 9/23/2020
- Helmholtz Coil – SN: SBI 1052; Calibrated: 9/23/2020

**Noise Spectrum**

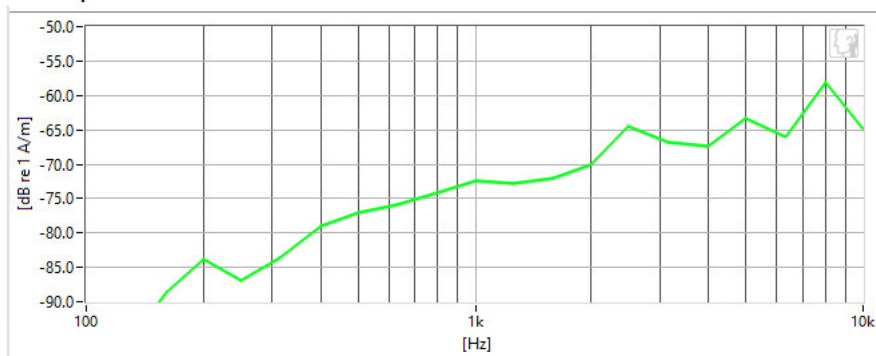

**Frequency Response**

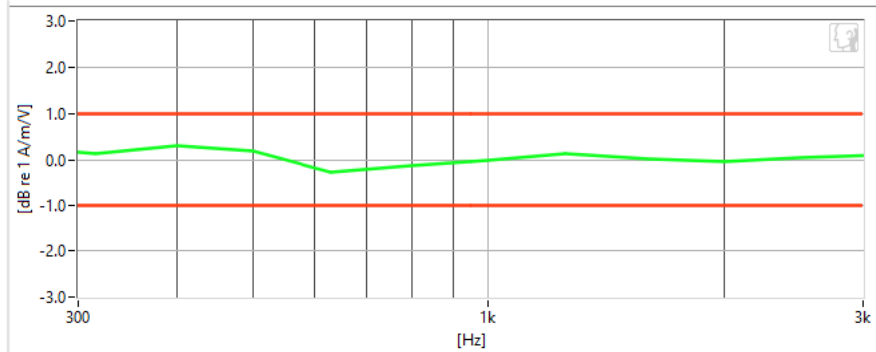

**Results**

Verification 1kHz Intensity	-10.282 dB	✓	Max/Min	-9.5/-10.5
Verification ABM2	-62.28 dB	✓	Maximum	-58.0
Frequency Response Margin	700m dB	✓	Tolerance curves	Aligned Data

FCC ID: PY7-57325M		HAC (T-COIL) TEST REPORT	<b>SONY</b>	Approved by: Quality Manager
Filename: 1M2206010068-05-R4.PY7	Test Dates: 3/21/2022 – 6/6/2022	DUT Type: Portable Handset		Page 58 of 88



## Element Hearing-Aid Compatibility Facility

### DUT: HH Coil – SN: SBI 1052

Type: HH Coil  
Serial: SBI 1052

Measurement Standard: ANSI C63.19-2011

#### Equipment:

- Probe: Radial T-Coil Probe – SN: TEM-1129; Calibrated: 9/23/2020
- Helmholtz Coil – SN: SBI 1052; Calibrated: 9/23/2020

#### Noise Spectrum

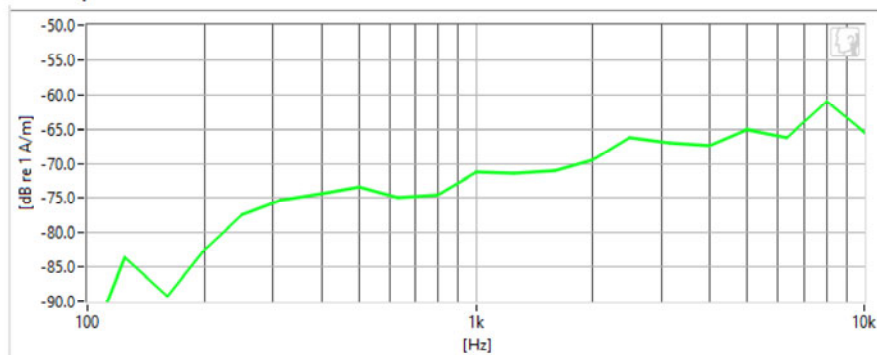

#### Frequency Response

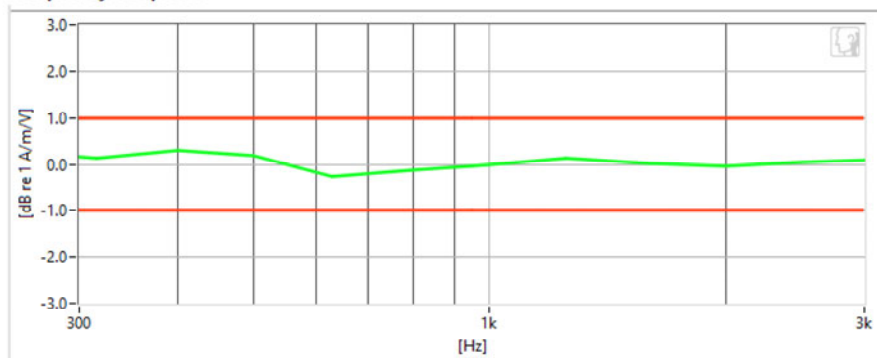

#### Results

Verification 1kHz Intensity	-10.183 dB	✓	Max/Min	-9.5/-10.5
Verification ABM2	-61.28 dB	✓	Maximum	-58.0
Frequency Response Margin	700m dB	✓	Tolerance curves	Aligned Data

FCC ID: PY7-57325M		HAC (T-COIL) TEST REPORT	<b>SONY</b>	Approved by: Quality Manager
Filename: 1M2206010068-05-R4.PY7	Test Dates: 3/21/2022 – 6/6/2022	DUT Type: Portable Handset		Page 59 of 88



**Element Hearing-Aid Compatibility Facility**

**DUT: PY7-57325M**

Type: Portable Handset  
Serial: 05JAZ

**Measurement Standard:** ANSI C63.19-2011

**Equipment:**

- Probe: Axial T-Coil Probe – SN: TEM-1123; Calibrated: 9/23/2020

**Test Configuration:**

- Mode: GSM850
- Channel: 128
- Speech Signal: ITU-T P.50 Artificial Voice

**Noise Spectrum**

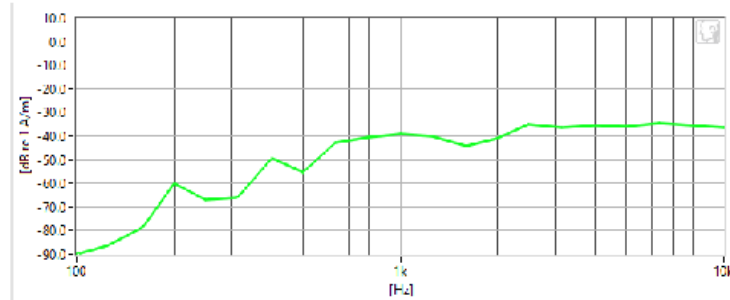

**Frequency Response**

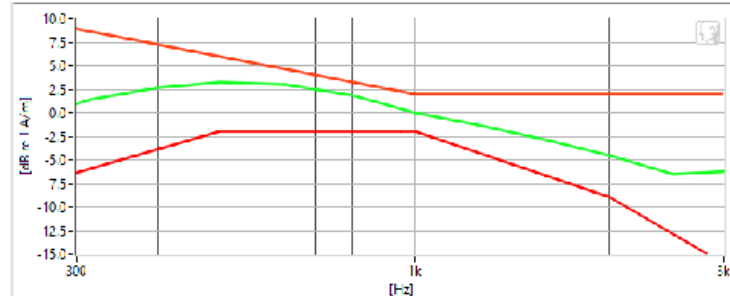

**Results**

ADM1	0.53 dB	✓	Minimum	18.0
ADM2	-31.64 dB	✓	Maximum	0.0
SNNR	40.17 dB	✓	Minimum	20.0
Aligned Response: P.50	1.43 dB	✓	Tolerance curves	Aligned Data

FCC ID: PY7-57325M		HAC (T-COIL) TEST REPORT	<b>SONY</b>	Approved by: Quality Manager
Filename: 1M2206010068-05-R4.PY7	Test Dates: 3/21/2022 – 6/6/2022	DUT Type: Portable Handset		Page 60 of 88



**Element Hearing-Aid Compatibility Facility**

**DUT: PY7-57325M**

Type: Portable Handset  
Serial: 05JAZ

**Measurement Standard:** ANSI C63.19-2011

**Equipment:**

- Probe: Axial T-Coil Probe – SN: TEM-1123; Calibrated: 9/23/2020

**Test Configuration:**

- Mode: GSM1900
- Channel: 512
- Speech Signal: ITU-T P.50 Artificial Voice

**Noise Spectrum**

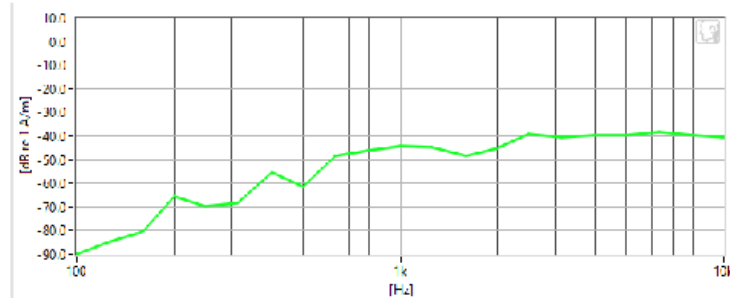

**Frequency Response**

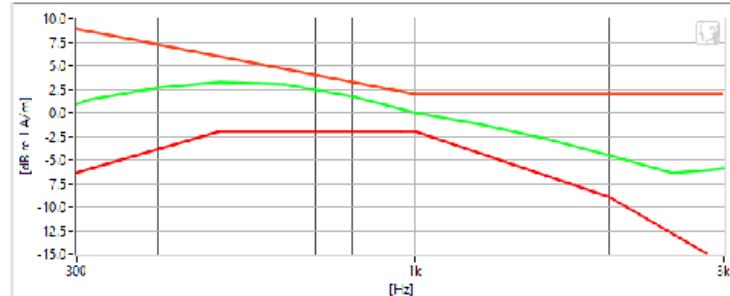

**Results**

ADM1	0.56 dB	✓	Minimum	18.0
ADM2	-36.35 dB	✓	Maximum	0.0
SNNR	44.91 dB	✓	Minimum	20.0
Aligned Response: P.50	1.52 dB	✓	Tolerance curves	Aligned Data

FCC ID: PY7-57325M		HAC (T-COIL) TEST REPORT	<b>SONY</b>	Approved by: Quality Manager
Filename: 1M2206010068-05-R4.PY7	Test Dates: 3/21/2022 – 6/6/2022	DUT Type: Portable Handset		Page 61 of 88



**Element Hearing-Aid Compatibility Facility**

**DUT: PY7-57325M**

Type: Portable Handset  
Serial: 05JAZ

**Measurement Standard:** ANSI C63.19-2011

**Equipment:**

- Probe: Axial T-Coil Probe – SN: TEM-1123; Calibrated: 9/23/2020

**Test Configuration:**

- Mode: UMTS V
- Channel: 4183
- Speech Signal: ITU-T P.50 Artificial Voice

**Noise Spectrum**

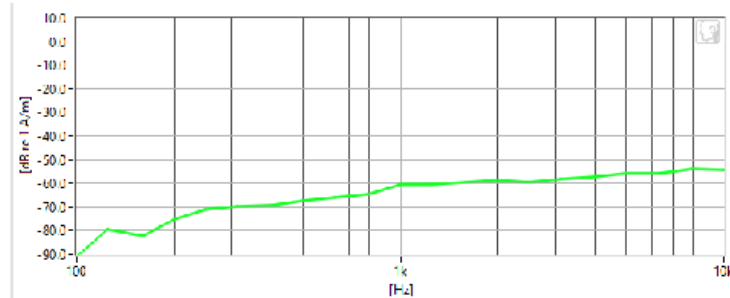

**Frequency Response**

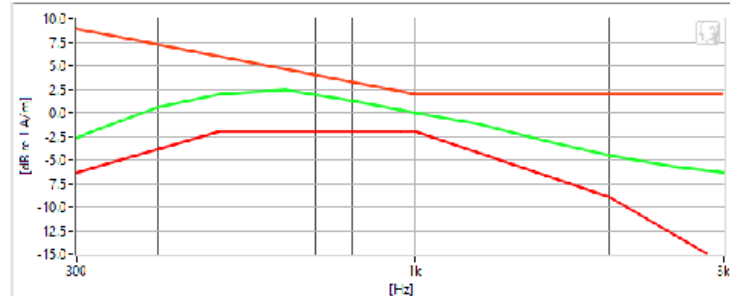

**Results**

ADM1	6.16 dB	✓	Minimum	18.0
ADM2	-52.26 dB	✓	Maximum	0
SNNR	50.42 dB	✓	Minimum	20
Aligned Response: P.50	2 dB	✓	Tolerance curves	Aligned Data

FCC ID: PY7-57325M		HAC (T-COIL) TEST REPORT	<b>SONY</b>	Approved by: Quality Manager
Filename: 1M2206010068-05-R4.PY7	Test Dates: 3/21/2022 – 6/6/2022	DUT Type: Portable Handset		Page 62 of 88



**Element Hearing-Aid Compatibility Facility**

**DUT: PY7-57325M**

Type: Portable Handset  
Serial: 05JAZ

**Measurement Standard:** ANSI C63.19-2011

**Equipment:**

- Probe: Axial T-Coil Probe – SN: TEM-1123; Calibrated: 9/23/2020

**Test Configuration:**

- Mode: UMTS IV
- Channel: 1513
- Speech Signal: ITU-T P.50 Artificial Voice

**Noise Spectrum**

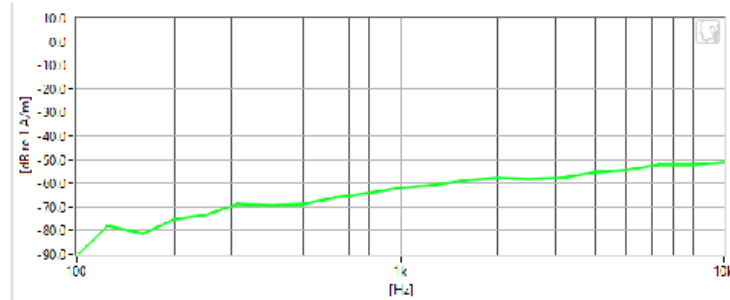

**Frequency Response**

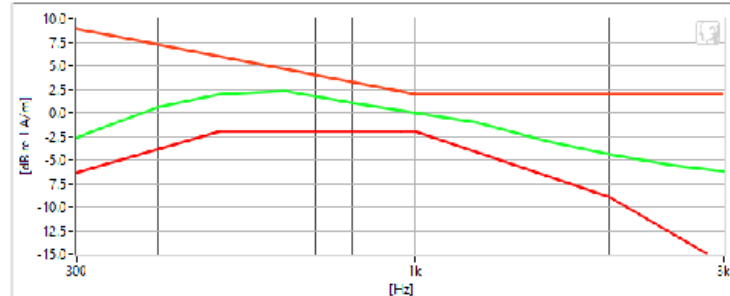

**Results**

ADM1	6.21 dB	✓	Minimum	18.0
ADM2	-51.06 dB	✓	Maximum	0.0
SNNR	50.07 dB	✓	Minimum	20.0
Aligned Response:	P.50	✓	Tolerance curves:	Aligned Data

FCC ID: PY7-57325M		HAC (T-COIL) TEST REPORT	<b>SONY</b>	Approved by: Quality Manager
Filename: 1M2206010068-05-R4.PY7	Test Dates: 3/21/2022 – 6/6/2022	DUT Type: Portable Handset		Page 63 of 88



**Element Hearing-Aid Compatibility Facility**

**DUT: PY7-57325M**

Type: Portable Handset  
Serial: 05JAZ

**Measurement Standard:** ANSI C63.19-2011

**Equipment:**

- Probe: Axial T-Coil Probe – SN: TEM-1123; Calibrated: 9/23/2020

**Test Configuration:**

- Mode: UMTS II
- Channel: 9538
- Speech Signal: ITU-T P.50 Artificial Voice

**Noise Spectrum**

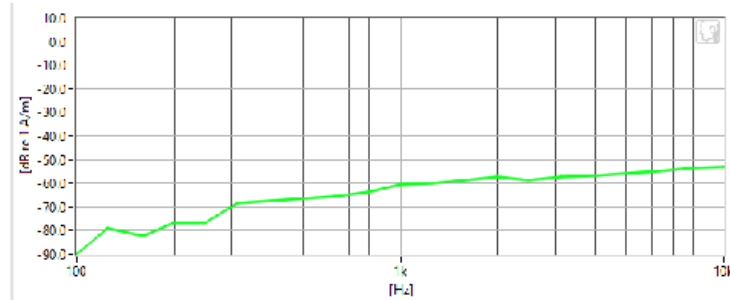

**Frequency Response**

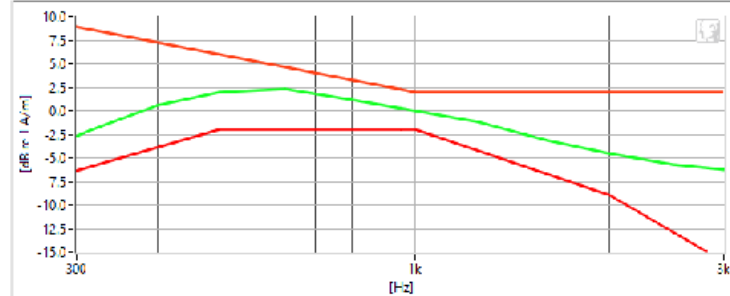

**Results**

ADM1	6.16 dB	✓	Minimum	18.0
ADM2	-51.62 dB	✓	Maximum	0
SNNR	57.77 dB	✓	Minimum	20
Aligned Response: P.50	2 dB	✓	Tolerance curves	Aligned Data

FCC ID: PY7-57325M		HAC (T-COIL) TEST REPORT	<b>SONY</b>	Approved by: Quality Manager
Filename: 1M2206010068-05-R4.PY7	Test Dates: 3/21/2022 – 6/6/2022	DUT Type: Portable Handset		Page 64 of 88





**Element Hearing-Aid Compatibility Facility**

**DUT: PY7-57325M**

Type: Portable Handset  
Serial: 05JAZ

**Measurement Standard:** ANSI C63.19-2011

**Equipment:**

- Probe: Axial T-Coil Probe – SN: TEM-1123; Calibrated: 9/23/2020

**Test Configuration:**

- Mode: LTE FDD Band 2
- Bandwidth: 20MHz
- Channel: 18900
- Speech Signal: ITU-T P.50 Artificial Voice

**Noise Spectrum**

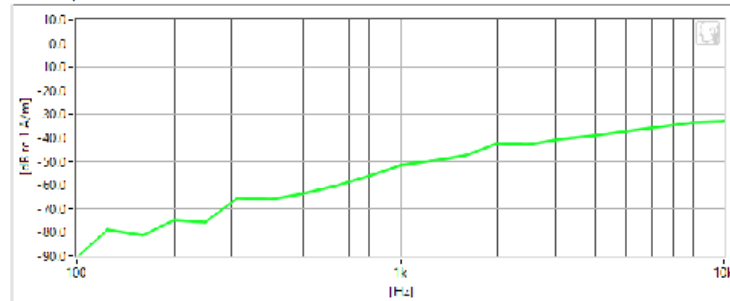

**Frequency Response**

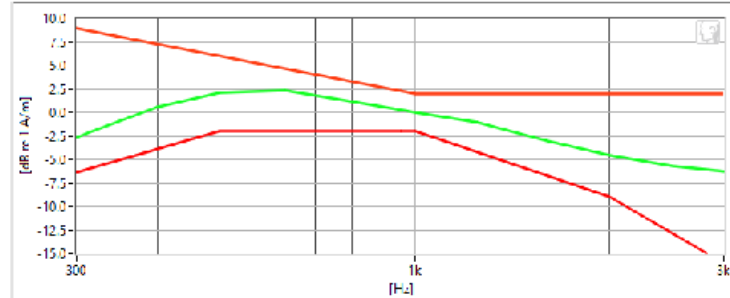

**Results**

ABM1	5.73 dB	✓	Minimum	-13.0
ABM2	35.22 dB	✓	Maximum	0.0
SNNR	45.05 dB	✓	Minimum	20.0
Aligned Response - P.50	2 dB	✓	Tolerance curves	Aligned Data

FCC ID: PY7-57325M		HAC (T-COIL) TEST REPORT	<b>SONY</b>	Approved by: Quality Manager
Filename: 1M2206010068-05-R4.PY7	Test Dates: 3/21/2022 – 6/6/2022	DUT Type: Portable Handset		Page 65 of 88



**Element Hearing-Aid Compatibility Facility**

**DUT: PY7-57325M**

Type: Portable Handset  
Serial: 05JAZ

**Measurement Standard:** ANSI C63.19-2011

**Equipment:**

- Probe: Axial T-Coil Probe – SN: TEM-1123; Calibrated: 9/23/2020

**Test Configuration:**

- Mode: LTE TDD Band 41 (PC3)
- Bandwidth: 10MHz
- Channel: 41055
- Speech Signal: ITU-T P.50 Artificial Voice

**Noise Spectrum**

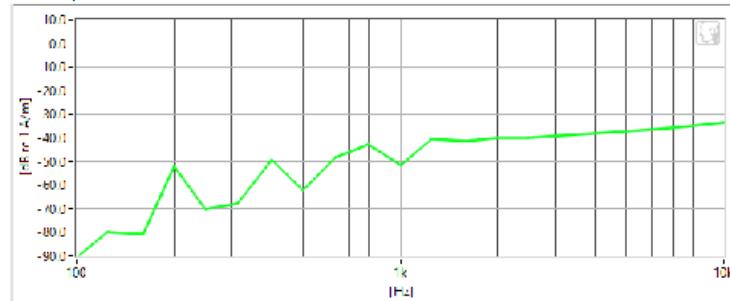

**Frequency Response**

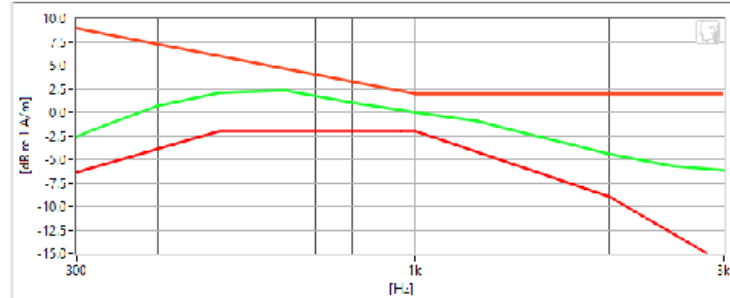

**Results**

ABM1	5.66 dB	✓	Minimum	-13.0
ABM2	34.09 dB	✓	Maximum	0.0
SNNR	39.74 dB	✓	Minimum	20.0
Aligned Response - P.50	2 dB	✓	Tolerance curves	Aligned Data

FCC ID: PY7-57325M		HAC (T-COIL) TEST REPORT	<b>SONY</b>	Approved by: Quality Manager
Filename: 1M2206010068-05-R4.PY7	Test Dates: 3/21/2022 – 6/6/2022	DUT Type: Portable Handset		Page 66 of 88



**Element Hearing-Aid Compatibility Facility**

**DUT: PY7-57325M**

Type: Portable Handset  
Serial: 00GC5

**Measurement Standard:** ANSI C63.19-2011

**Equipment:**

- Probe: Axial T-Coil Probe – SN: TEM-1123; Calibrated: 9/23/2020

**Test Configuration:**

- VoIP Application: Google Duo
- Mode: LTE TDD Band 41 (PC3)
- Bandwidth: 10MHz
- Channel: 41055
- Speech Signal: ITU-T P.50 Artificial Voice

**Noise Spectrum**

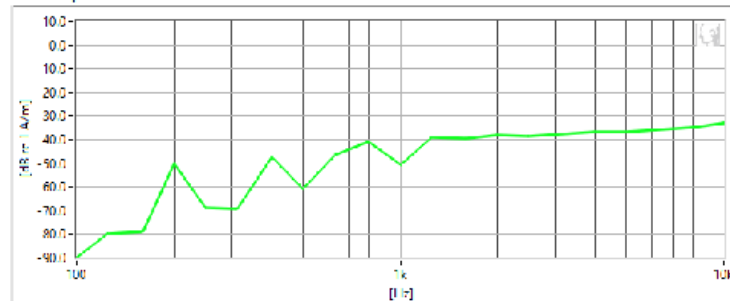

**Frequency Response**

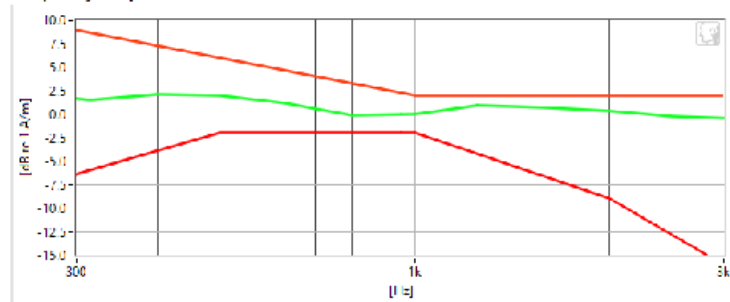

**Results**

ABM1	28.74 dB	✓	Minimum	-18.0
ABM2	-32.58 dB	✓	Maximum	0
SNNR	61.32 dB	✓	Minimum	20
Aligned Response - P.50	1.08 dR	✓	Tolerance curves	Aligned Data

FCC ID: PY7-57325M		HAC (T-COIL) TEST REPORT	<b>SONY</b>	Approved by: Quality Manager
Filename: 1M2206010068-05-R4.PY7	Test Dates: 3/21/2022 – 6/6/2022	DUT Type: Portable Handset		Page 67 of 88



**Element Hearing-Aid Compatibility Facility**

**DUT: PY7-57325M**

Type: Portable Handset  
Serial: 05JAZ

**Measurement Standard:** ANSI C63.19-2011

**Equipment:**

- Probe: Radial T-Coil Probe – SN: TEM-1129; Calibrated: 9/23/2020

**Test Configuration:**

- Mode: GSM850
- Channel: 251

**Noise Spectrum**

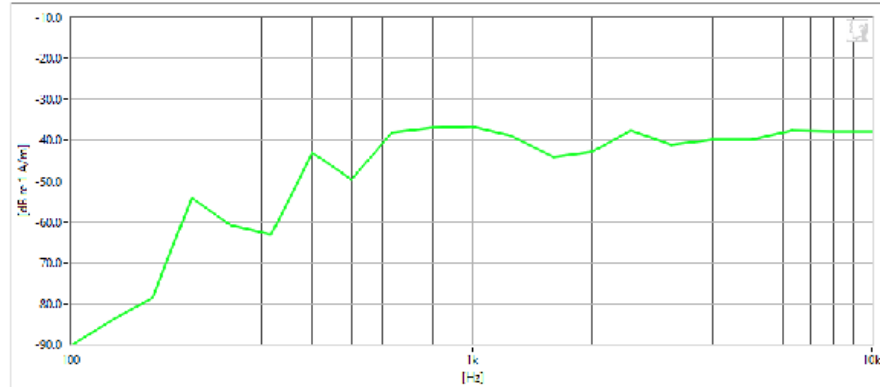

**Results**

ABM1	2.3 dB	✓	Minimum	-18.0
ABM2	-29.85 dB	✓	Maximum	0.0
SNNR	32.15 dB	✓	Minimum	20.0

FCC ID: PY7-57325M		HAC (T-COIL) TEST REPORT	<b>SONY</b>	Approved by: Quality Manager
Filename: 1M2206010068-05-R4.PY7	Test Dates: 3/21/2022 – 6/6/2022	DUT Type: Portable Handset		Page 68 of 88



**Element Hearing-Aid Compatibility Facility**

**DUT: PY7-57325M**

Type: Portable Handset  
Serial: 05JAZ

**Measurement Standard:** ANSI C63.19-2011

**Equipment:**

- Probe: Radial T-Coil Probe – SN: TEM-1129; Calibrated: 9/23/2020

**Test Configuration:**

- Mode: GSM1900
- Channel: 512

**Noise Spectrum**

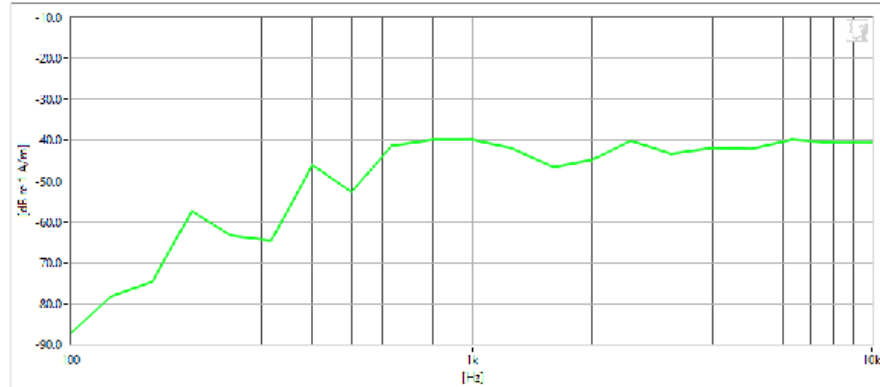

**Results**

ABM1	2.01 dB	✓	Minimum	-18.0
ABM2	-32.88 dB	✓	Maximum	0.0
SNNR	34.89 dB	✓	Minimum	20.0

FCC ID: PY7-57325M		HAC (T-COIL) TEST REPORT	<b>SONY</b>	Approved by: Quality Manager
Filename: 1M2206010068-05-R4.PY7	Test Dates: 3/21/2022 – 6/6/2022	DUT Type: Portable Handset		Page 69 of 88



**Element Hearing-Aid Compatibility Facility**

**DUT: PY7-57325M**

Type: Portable Handset  
Serial: 05JAZ

**Measurement Standard:** ANSI C63.19-2011

**Equipment:**

- Probe: Radial T-Coil Probe – SN: TEM-1129; Calibrated: 9/23/2020

**Test Configuration:**

- Mode: UMTS V
- Channel: 4233

**Noise Spectrum**

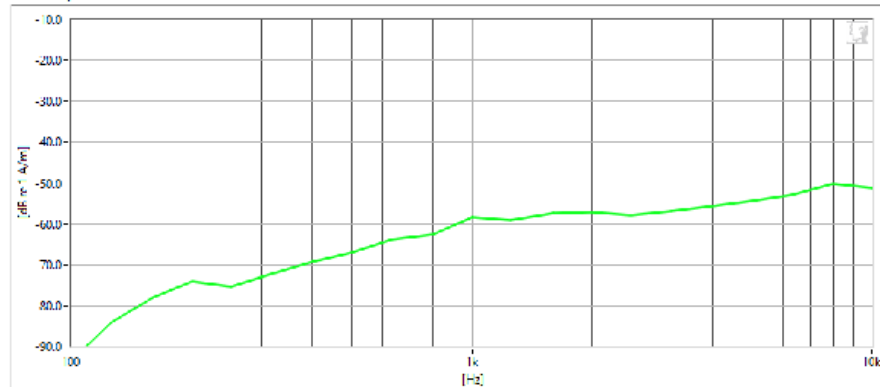

**Results**

ABM1	960m dB	✓	Minimum	-18.0
ABM2	-50.72 dB	✓	Maximum	0.0
SNNR	49.85 dB	✓	Minimum	20.0

FCC ID: PY7-57325M		HAC (T-COIL) TEST REPORT	<b>SONY</b>	Approved by: Quality Manager
Filename: 1M2206010068-05-R4.PY7	Test Dates: 3/21/2022 – 6/6/2022	DUT Type: Portable Handset		Page 70 of 88



**Element Hearing-Aid Compatibility Facility**

**DUT: PY7-57325M**

Type: Portable Handset  
Serial: 05JAZ

**Measurement Standard:** ANSI C63.19-2011

**Equipment:**

- Probe: Radial T-Coil Probe – SN: TEM-1129; Calibrated: 9/23/2020

**Test Configuration:**

- Mode: UMTS IV
- Channel: 1513

**Noise Spectrum**

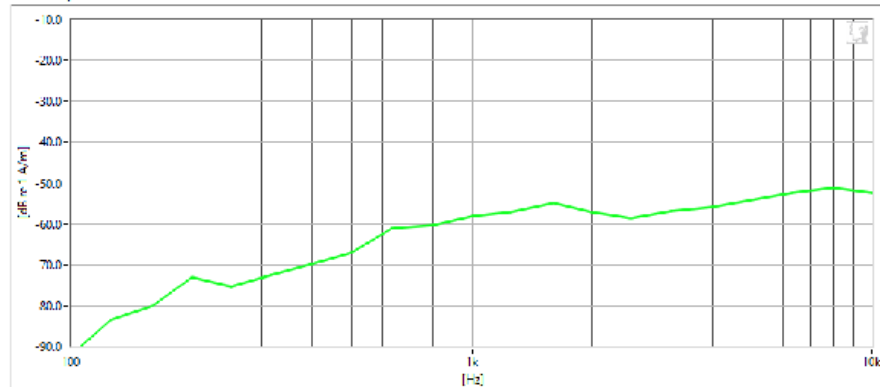

**Results**

ABM1	750m dB	✓	Minimum	-18.0
ABM2	-49.7 dB	✓	Maximum	0.0
SNNR	48.96 dB	✓	Minimum	20.0

FCC ID: PY7-57325M		HAC (T-COIL) TEST REPORT	<b>SONY</b>	Approved by: Quality Manager
Filename: 1M2206010068-05-R4.PY7	Test Dates: 3/21/2022 – 6/6/2022	DUT Type: Portable Handset		Page 71 of 88



**Element Hearing-Aid Compatibility Facility**

**DUT: PY7-57325M**

Type: Portable Handset  
Serial: 05JAZ

**Measurement Standard:** ANSI C63.19-2011

**Equipment:**

- Probe: Radial T-Coil Probe – SN: TEM-1129; Calibrated: 9/23/2020

**Test Configuration:**

- Mode: UMTS II
- Channel: 9400

**Noise Spectrum**

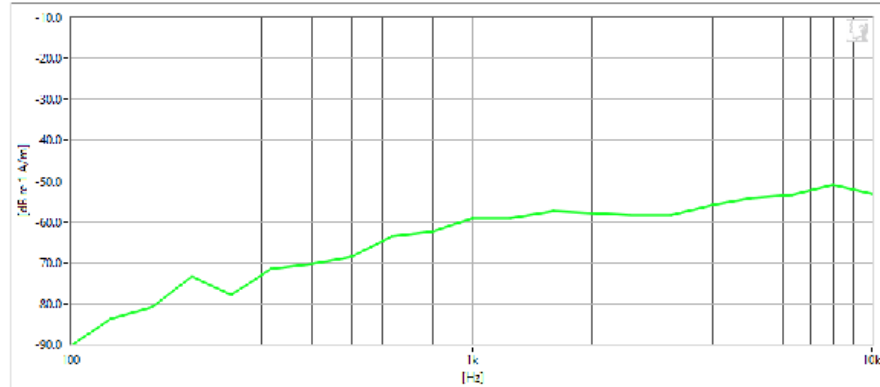

**Results**

ABM1	1.14 dB	✓	Minimum	-18.0
ABM2	-51.09 dB	✓	Maximum	0.0
SNNR	49.95 dB	✓	Minimum	20.0

FCC ID: PY7-57325M		HAC (T-COIL) TEST REPORT	<b>SONY</b>	Approved by: Quality Manager
Filename: 1M2206010068-05-R4.PY7	Test Dates: 3/21/2022 – 6/6/2022	DUT Type: Portable Handset		Page 72 of 88





**Element Hearing-Aid Compatibility Facility**

**DUT: PY7-57325M**

Type: Portable Handset  
Serial: 05JAZ

**Measurement Standard:** ANSI C63.19-2011

**Equipment:**

- Probe: Radial T-Coil Probe – SN: TEM-1129; Calibrated: 9/23/2020

**Test Configuration:**

- Mode: LTE FDD Band 2
- Bandwidth: 20MHz
- Channel: 18900

Noise Spectrum

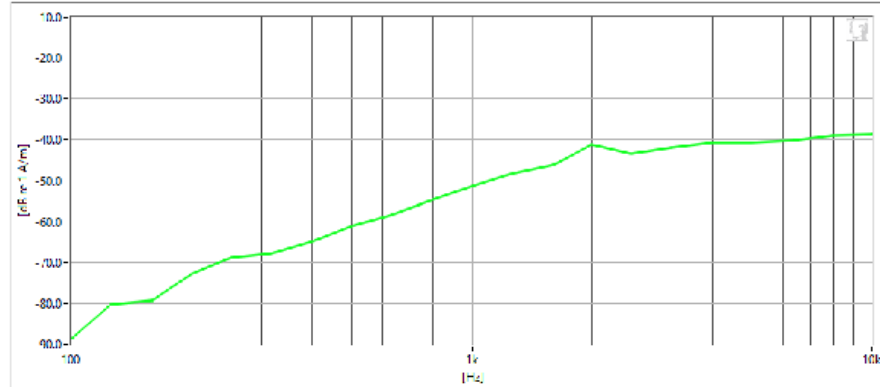

**Results**

ABM1	180m dB	✓	Minimum	-18.0
ABM2	-39.05 dB	✓	Maximum	0.0
SNNR	39.22 dB	✓	Minimum	20.0

FCC ID: PY7-57325M		HAC (T-COIL) TEST REPORT	<b>SONY</b>	Approved by: Quality Manager
Filename: 1M2206010068-05-R4.PY7	Test Dates: 3/21/2022 – 6/6/2022	DUT Type: Portable Handset		Page 73 of 88



**Element Hearing-Aid Compatibility Facility**

**DUT: PY7-57325M**

Type: Portable Handset  
Serial: 05JAZ

**Measurement Standard:** ANSI C63.19-2011

**Equipment:**

- Probe: Radial T-Coil Probe – SN: TEM-1129; Calibrated: 9/23/2020

**Test Configuration:**

- Mode: LTE TDD Band 41 (PC3)
- Bandwidth: 10MHz
- Channel: 41055

Noise Spectrum

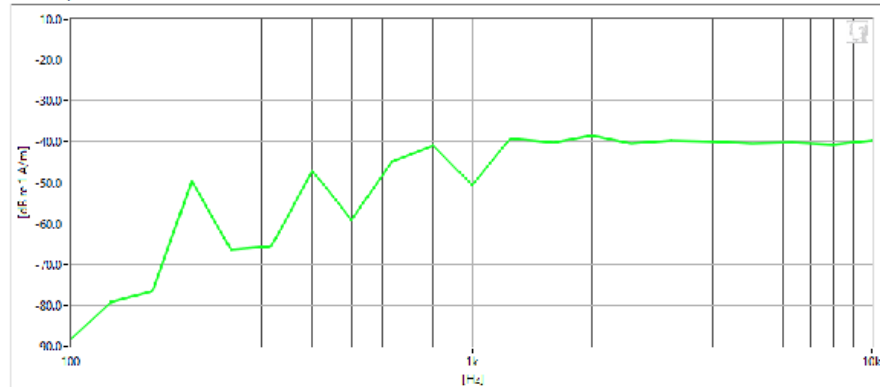

**Results**

ABM1	170m dB	✓	Minimum	-18.0
ABM2	-33.09 dB	✓	Maximum	0.0
SNNR	33.26 dB	✓	Minimum	20.0

FCC ID: PY7-57325M		HAC (T-COIL) TEST REPORT	<b>SONY</b>	Approved by: Quality Manager
Filename: 1M2206010068-05-R4.PY7	Test Dates: 3/21/2022 – 6/6/2022	DUT Type: Portable Handset		Page 74 of 88



## Element Hearing-Aid Compatibility Facility

**DUT: PY7-57325M**

Type: Portable Handset  
Serial: 00GC5

**Measurement Standard:** ANSI C63.19-2011

**Equipment:**

- Probe: Radial T-Coil Probe – SN: TEM-1129; Calibrated: 9/23/2020

**Test Configuration:**

- VoIP Application: Google Duo
- Mode: NR TDD n41
- Bandwidth: 60MHz
- Channel: 525300

**Noise Spectrum**

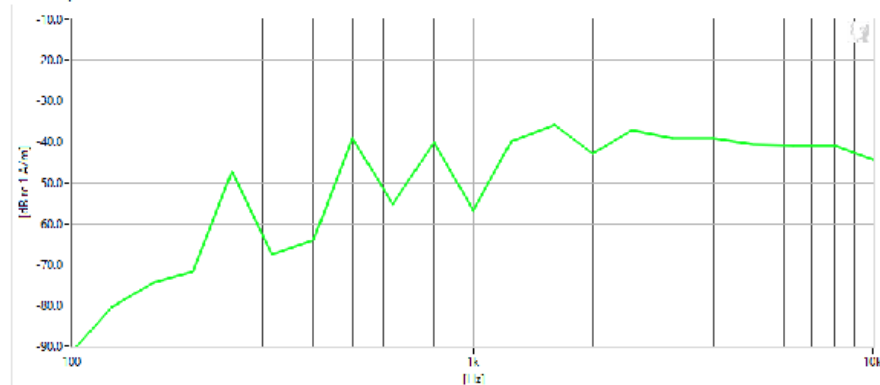

**Results**

ABM2	-31.56 dB	✓	Maximum	0.0
------	-----------	---	---------	-----

FCC ID: PY7-57325M		HAC (T-COIL) TEST REPORT	<b>SONY</b>	Approved by: Quality Manager
Filename: 1M2206010068-05-R4.PY7	Test Dates: 3/21/2022 – 6/6/2022	DUT Type: Portable Handset		Page 75 of 88

## 12. CALIBRATION CERTIFICATES

FCC ID: PY7-57325M		HAC (T-COIL) TEST REPORT	<b>SONY</b>	Approved by: Quality Manager
Filename: 1M2206010068-05-R4.PY7	Test Dates: 3/21/2022 – 6/6/2022	DUT Type: Portable Handset		Page 76 of 88

© 2022 ELEMENT

REV 3.5.M  
8/18/2020

© 2022 ELEMENT All rights reserved. Unless otherwise specified, no part of this report may be reproduced or utilized in any part, form or by any means, electronic or mechanical, including photocopying and microfilm, without permission in writing from ELEMENT. If you have any questions about this international copyright or have an enquiry about obtaining additional rights to this report or assembly of contents thereof, please contact CT.INFO@ELEMENT.COM.

West Caldwell Calibration Laboratories Inc.

# Certificate of Conformance

for

AXIAL T COIL PROBE

Manufactured by: TEM CONSULTING  
 Model No: AXIAL T COIL PROBE  
 Serial No: TEM-1123  
 Calibration Recall No: 31288

Submitted By:

Customer: ANDREW HARWELL  
 Company: PCTEST ENGINEERING LAB  
 Address: 6660-B DOBBIN ROAD  
 COLUMBIA MD 21045

The subject instrument was calibrated to the indicated specification using standards traceable to the SI through the National Institute of Standards and Technology or to accepted values of natural physical constants. This document certifies that the instrument met the following specification upon its return to the submitter.

West Caldwell Calibration Laboratories Procedure No. AXIAL T C TEM C

Upon receipt for Calibration, the instrument was found to be:

Within ( X )

tolerance of the indicated specification. See attached Report of Calibration.

The information supplied relates to the calibrated item listed above and statement of conformance for ALL given specifications and standards fall under the decision rule:  $A=(L-(U95))$ , where A is acceptance limit, L is manufacturer specifications and U95 is confidence level of 95% at k=2. This includes but not limited to: 1. Measured value does not meet manufacturer's tolerance, 2. Manufacturer's tolerance is too small compared to calibration and measurement capability uncertainties, 3. Test uncertainty ratio does not meet the 4:1 ratio due to test instrumentation limitations. The decision rule has been communicated and approved by customer during contract

West Caldwell Calibration Laboratories' calibration control system meets the following requirements, ISO 10012-1 MIL STD 45662A, ANSI/NCSL Z540-1, IEC Guide 25, ISO 9001:2015, and ISO 17025

Note: With this Certificate, Report of Calibration is included.

Approved by:

Calibration Date: 23-Sep-20

James Zhu

Certificate No: 31288 - 2

Quality Manager  
 ISO/IEC 17025:2017

QA Doc. #1051 Rev. 3.0 5/29/20

Certificate Page 1 of 1

**West Caldwell Calibration Laboratories, Inc.**  
 uncompromised calibration  
 1575 State Route 96, Victor, NY 14564, U.S.A.



Calibration Lab. Cert. # 1533.01

FCC ID: PY7-57325M		HAC (T-COIL) TEST REPORT	<b>SONY</b>	Approved by: Quality Manager
Filename: 1M2206010068-05-R4.PY7	Test Dates: 3/21/2022 – 6/6/2022	DUT Type: Portable Handset		Page 77 of 88



# REPORT OF CALIBRATION

for

TEM Consulting LP Axial T Coil Probe  
Company: PCTest Engineering Lab

Model No.: Axial T Coil Probe

Serial No.: TEM-1123  
I. D. No.: XXXX

Calibration results:			
Probe Sensitivity measured with Helmholtz Coil			
<i>Helmholtz Coil;</i>			
the number of turns on each coil;	10	No.	Before & after data same: ...X...
the radius of each coil, in meters;	0.204	m	
the current in the coils, in amperes.;	0.08	A	
<i>Helmholtz Coil Constant;</i>		7.04	A/m/V
<i>Helmholtz Coil magnetic field;</i>		5.71	A/m
Probe Sensitivity at	1000	Hz.	Laboratory Environment:
was	-60.24	dBV/A/m	Ambient Temperature: 20.7 °C
	0.972	mV/A/m	Ambient Humidity: 42.1 % RH
Probe resistance	898	Ohms	Ambient Pressure: 99.094 kPa
			Calibration Date: 23-Sep-2020
			Calibration Due:
			Report Number: 31288 -2
			Control Number: 31288

The above listed instrument meets or exceeds the tested manufacturer's specifications.  
This Calibration is traceable through NIST test numbers: 684.07/O-0000001126-20  
The expanded uncertainty of calibration: 0.30dB at 95% confidence level with a coverage factor of k=2.  
Graph represents Probes Frequency Response.

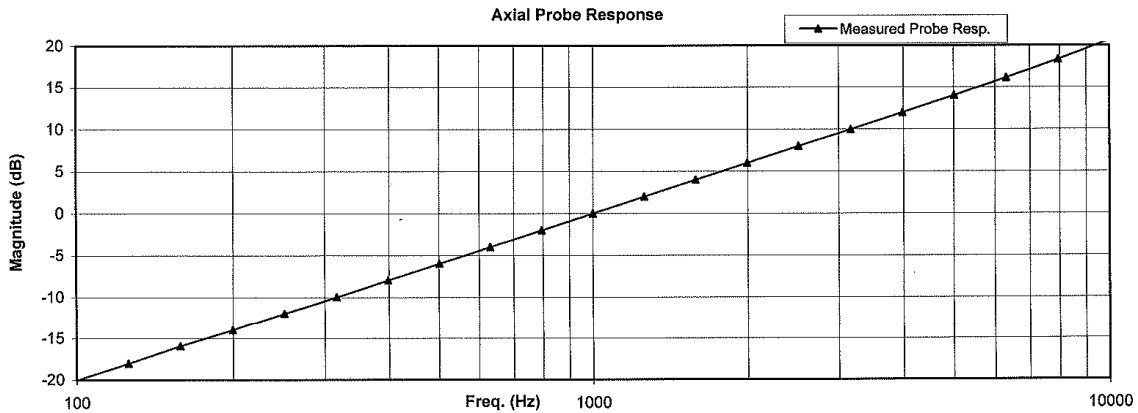

The above listed instrument was checked using calibration procedure documented in West Caldwell Calibration Laboratories Inc. procedure : **Rev. 7.0 Jan. 24, 2014 Doc. # 1038 HCATEMC**  
Calibration was performed by West Caldwell Calibration Laboratories Inc. under Operating Procedures intended to implement the requirements of ISO10012-1, IEC Guide 25, ANSI/NCSL Z540-1, (MIL-STD-45662A) and ISO 9001:2015, ISO 17025

Cal. Date: 23-Sep-2020  
Calibrated on WCCL system type 9700

Measurements performed by: *[Signature]*  
**James Zhu**

This document shall not be reproduced, except in full, without the written approval from West Caldwell Cal. Labs, Inc.

Rev. 7.0 Jan. 24, 2014 Doc. # 1038 HCATEMC

FCC ID: PY7-57325M		HAC (T-COIL) TEST REPORT	<b>SONY</b>	Approved by: Quality Manager
Filename: 1M2206010068-05-R4.PY7	Test Dates: 3/21/2022 – 6/6/2022	DUT Type: Portable Handset		Page 78 of 88

West Caldwell Calibration Laboratories Inc.

1575 State Route 96, Victor NY 14564  
Tel. (585) 586-3900 FAX (585) 586-4327

**Calibration Data Record**

TEM Consulting LP Axial T Coil Probe  
Company: PCTest Engineering Lab

for  
Model No.: Axial T Coil Probe

Serial No.: TEM-1123

Test	Function	Tolerance	Measured values		
			Before	Out	Remarks
1.0	Probe Sensitivity at	1000 Hz. dBV/A/m	-60.24		
2.0	Probe Level Linearity	Ref. (0 dB)	6	6.03	
			0	0.00	
			-6	-6.03	
			-12	-12.05	
3.0	Probe Frequency Response	Ref. (0 dB)	100	-20.0	
			126	-18.0	
			158	-15.9	
			200	-14.0	
			251	-12.0	
			316	-10.0	
			398	-8.0	
			501	-6.0	
			631	-4.0	
			794	-2.0	
			1000	0.0	
			1259	2.0	
			1585	4.0	
			1995	6.0	
			2512	8.0	
			3162	10.0	
			3981	12.0	
5012	14.0				
6310	16.1				
7943	18.3				
10000	20.7				

Instruments used for calibration:	S/N	Date of Cal.	Traceability No.	Due Date
HP 34401A	US360641	2-Jul-2020	,610119	2-Jul-2021
HP 34401A	US361024	2-Jul-2020	,610119	2-Jul-2021
HP 33120A	US360437	2-Jul-2020	,610119	2-Jul-2021
B&K 2133	1583254	1-Jul-2020	684.07/O-0000001126-20	1-Jul-2021

Cal. Date: 23-Sep-2020  
Calibrated on WCCL system type 9700

Tested by: James Zhu

This document shall not be reproduced, except in full, without the written approval from West Caldwell Cal. Labs. Inc.

Rev. 7.0 Jan. 24, 2014 Doc. # 1038 HCATEMC

FCC ID: PY7-57325M		HAC (T-COIL) TEST REPORT	<b>SONY</b>	Approved by: Quality Manager
Filename: 1M2206010068-05-R4.PY7	Test Dates: 3/21/2022 – 6/6/2022	DUT Type: Portable Handset		Page 79 of 88

West Caldwell Calibration Laboratories Inc.

# Certificate of Conformance

for

RADIAL T COIL PROBE

Manufactured by: TEM CONSULTING  
Model No: RADIAL T COIL PROBE  
Serial No: TEM-1129  
Calibration Recall No: 31288

Submitted By:

Customer: ANDREW HARWELL  
Company: PCTEST ENGINEERING LAB  
Address: 6660-B DOBBIN ROAD  
COLUMBIA MD 21045

The subject instrument was calibrated to the indicated specification using standards traceable to the SI through the National Institute of Standards and Technology or to accepted values of natural physical constants. This document certifies that the instrument met the following specification upon its return to the submitter.

West Caldwell Calibration Laboratories Procedure No. RADIAL T TEM C

Upon receipt for Calibration, the instrument was found to be:

Within ( X )

tolerance of the indicated specification. See attached Report of Calibration.

The information supplied relates to the calibrated item listed above and statement of conformance for ALL given specifications and standards fall under the decision rule:  $A=(L-(U95))$ , where A is acceptance limit, L is manufacturer specifications and U95 is confidence level of 95% at  $k=2$ . This includes but not limited to: 1. Measured value does not meet manufacturer's tolerance, 2. Manufacturer's tolerance is too small compared to calibration and measurement capability uncertainties, 3. Test uncertainty ratio does not meet the 4:1 ratio due to test instrumentation limitations. The decision rule has been communicated and approved by customer during contract

West Caldwell Calibration Laboratories' calibration control system meets the following requirements, ISO 10012-1 MIL STD 45662A, ANSI/NCSL Z540-1, IEC Guide 25, ISO 9001:2015, and ISO 17025

Note: With this Certificate, Report of Calibration is included.

Approved by:

Calibration Date: 23-Sep-20

James Zhu

Certificate No: 31288 - 1

Quality Manager  
ISO/IEC 17025:2017

QA Doc. #1051 Rev. 3.0 5/29/20

Certificate Page 1 of 1

**West Caldwell Calibration Laboratories, Inc.**  
uncompromised calibration  
1575 State Route 96, Victor, NY 14564, U.S.A.



Calibration Lab. Cert. # 1533.01

FCC ID: PY7-57325M		HAC (T-COIL) TEST REPORT	<b>SONY</b>	Approved by: Quality Manager
Filename: 1M2206010068-05-R4.PY7	Test Dates: 3/21/2022 – 6/6/2022	DUT Type: Portable Handset		Page 80 of 88





# REPORT OF CALIBRATION

for

TEM Consulting LP Radial T Coil Probe  
Company: PCTest Engineering Lab

Model No.: Radial T Coil Probe

Serial No.: TEM-1129  
I. D. No.: XXXX

Calibration results:			
<b>Probe Sensitivity measured with Helmholtz Coil</b>			
<i>Helmholtz Coil;</i>			
the number of turns on each coil;	10	No.	Before & after data same: ...X...
the radius of each coil, in meters;	0.204	m	
the current in the coils, in amperes.;	0.08	A	
<i>Helmholtz Coil Constant;</i>	7.04	A/m/V	Laboratory Environment:
<i>Helmholtz Coil magnetic field;</i>	5.70	A/m	Ambient Temperature: 20.7 °C
			Ambient Humidity: 42.1 % RH
			Ambient Pressure: 99.094 kPa
			Calibration Date: 23-Sep-2020
			Re-calibration Due:
Probe Sensitivity at 1000 Hz.			Report Number: 31288 -1
was -60.37 dBV/A/m			Control Number: 31288
0.959 mV/A/m			
Probe resistance 897 Ohms			

The above listed instrument meets or exceeds the tested manufacturer's specifications.  
This Calibration is traceable through NIST test numbers: 684.07/O-0000001126-20  
The expanded uncertainty of calibration: 0.30dB at 95% confidence level with a coverage factor of k=2.

Graph represents Probes Frequency Response.

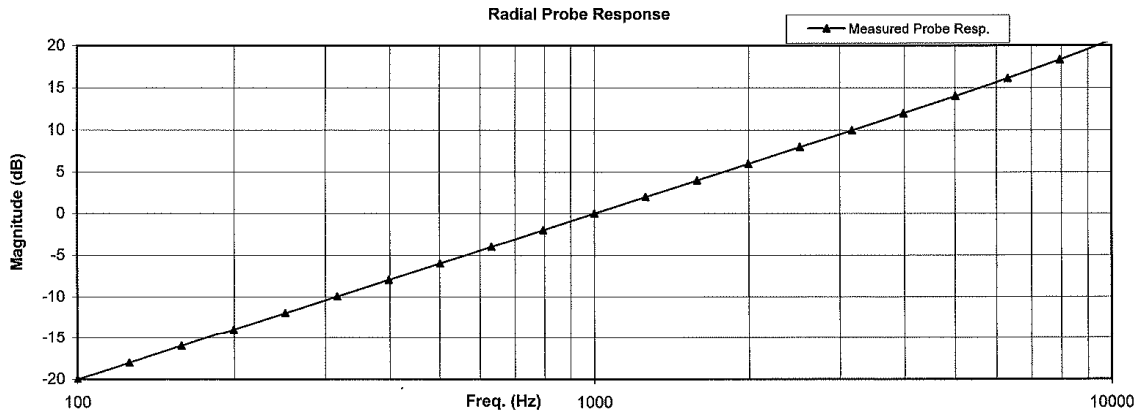

The above listed instrument was checked using calibration procedure documented in West Caldwell Calibration Laboratories Inc. procedure : Rev. 7.0 Jan. 24, 2014 Doc. # 1038 HCRTEMC  
Calibration was performed by West Caldwell Calibration Laboratories Inc. under Operating Procedures intended to implement the requirements of ISO10012-1, IEC Guide 25, ANSI/NC SL Z540-1, (MIL-STD-45662A) and ISO 9001:2015, ISO 17025

Cal. Date: 23-Sep-2020  
Calibrated on WCCL system type 9700

Measurements performed by: *[Signature]*  
**James Zhu**

This document shall not be reproduced, except in full, without the written approval from West Caldwell Cal. Labs. Inc.

Rev. 7.0 Jan. 24, 2014 Doc. # 1038 HCRTEMC

FCC ID: PY7-57325M		HAC (T-COIL) TEST REPORT	<b>SONY</b>	Approved by: Quality Manager
Filename: 1M2206010068-05-R4.PY7	Test Dates: 3/21/2022 – 6/6/2022	DUT Type: Portable Handset		Page 81 of 88

HCRTEM\_Cal-1129\_Sep-23-2020

West Caldwell Calibration Laboratories Inc.

1575 State Route 96, Victor NY 14564  
Tel. (585) 586-3900 FAX (585) 586-4327

Calibration Data Record

TEM Consulting LP Radial T Coil Probe  
Company: PCTest Engineering Lab

for  
Model No.: Radial T Coil Probe

Serial No.: TEM-1129

Test	Function	Tolerance	Measured values		
			Before	Out	Remarks
1.0	Probe Sensitivity at	1000 Hz. dBV/A/m	-60.37		
2.0	Probe Level Linearity	Ref. (0 dB)	dB		
			6	6.04	
			0	0.00	
			-6	-6.03	
			-12	-12.05	
3.0	Probe Frequency Response	Ref. (0 dB)	Hz		
			100	-20.0	
			126	-18.0	
			158	-16.0	
			200	-14.0	
			251	-12.0	
			316	-10.0	
			398	-8.0	
			501	-6.0	
			631	-4.0	
			794	-2.0	
			1000	0.0	
			1259	2.0	
			1585	4.0	
			1995	6.0	
			2512	8.0	
3162	10.0				
3981	12.0				
5012	14.0				
6310	16.1				
7943	18.3				
10000	20.7				

Instruments used for calibration:			Date of Cal.	Traceability No.	Due Date
HP	34401A	S/N US360641	2-Jul-2020	,610119	2-Jul-2021
HP	34401A	S/N US361024	2-Jul-2020	,610119	2-Jul-2021
HP	33120A	S/N US360437	2-Jul-2020	,610119	2-Jul-2021
B&K	2133	S/N 1583254	1-Jul-2020	684.07/O-0000001126-20	1-Jul-2021

Cal. Date: 23-Sep-2020  
Calibrated on WCCL system type 9700

Tested by: James Zhu

This document shall not be reproduced, except in full, without the written approval from West Caldwell Cal. Labs, Inc.

Rev. 7.0 Jan. 24, 2014 Doc. # 1038 HCRTEM\_C

FCC ID: PY7-57325M		HAC (T-COIL) TEST REPORT	<b>SONY</b>	Approved by: Quality Manager
Filename: 1M2206010068-05-R4.PY7	Test Dates: 3/21/2022 – 6/6/2022	DUT Type: Portable Handset		Page 82 of 88

## 13. CONCLUSION

The measurements indicate that the wireless communications device complies with the HAC limits specified in accordance with the ANSI C63.19 Standard and FCC WT Docket No. 01-309 RM-8658. Precise laboratory measures were taken to assure repeatability of the tests. The tested device complies with the requirements in respect to all parameters specific to the test. The test results and statements relate only to the item(s) tested.

The measurement system and techniques presented in this evaluation are proposed in the ANSI standard as a means of best approximating wireless device compatibility with a hearing-aid. The literature is under continual re-construction.

FCC ID: PY7-57325M		HAC (T-COIL) TEST REPORT	<b>SONY</b>	Approved by: Quality Manager
Filename: 1M2206010068-05-R4.PY7	Test Dates: 3/21/2022 – 6/6/2022	DUT Type: Portable Handset		Page 83 of 88

© 2022 ELEMENT

REV 3.5.M  
8/18/2020

© 2022 ELEMENT All rights reserved. Unless otherwise specified, no part of this report may be reproduced or utilized in any part, form or by any means, electronic or mechanical, including photocopying and microfilm, without permission in writing from ELEMENT. If you have any questions about this international copyright or have an enquiry about obtaining additional rights to this report or assembly of contents thereof, please contact CT.INFO@ELEMENT.COM.

## 14. REFERENCES

1. ANSI C63.19-2011, American National Standard for Methods of Measurement of Compatibility between Wireless communication devices and Hearing Aids.", New York, NY, IEEE, May 2011
2. FCC Office of Engineering and Technology KDB, "285076 D01 HAC Guidance v05," September 13, 2017
3. FCC Office of Engineering and Technology KDB, "285076 D02 T-Coil Testing for CMRS IP v03," September 13, 2017
4. FCC Public Notice DA 06-1215, *Wireless Telecommunications Bureau and Office of Engineering and Technology Clarify Use of Revised Wireless Phone Hearing Aid Compatibility Standard*, June 6, 2006
5. FCC 3G Review Guidance, Laboratory Division OET FCC, May/June 2006
6. Berger, H. S., "Compatibility Between Hearing Aids and Wireless Devices," Electronic Industries Forum, Boston, MA, May, 1997
7. Berger, H. S., "Hearing Aid and Cellular Phone Compatibility: Working Toward Solutions," *Wireless Telephones and Hearing Aids: New Challenges for Audiology*, Gallaudet University, Washington, D.C., May, 1997 (To be reprinted in the *American Journal of Audiology*).
8. Berger, H. S., "Hearing Aid Compatibility with Wireless Communications Devices," IEEE International Symposium on Electromagnetic Compatibility, Austin, TX, August, 1997.
9. Bronaugh, E. L., "Simplifying EMI Immunity (Susceptibility) Tests in TEM Cells," in the 1990 IEEE International Symposium on Electromagnetic Compatibility Symposium Record, Washington, D.C., August 1990, pp. 488-491
10. Byrne, D. and Dillon, H., The National Acoustics Laboratory (NAL) New Procedure for Selecting the Gain and Frequency Response of a Hearing Aid, *Ear and Hearing* 7:257-265, 1986.
11. Crawford, M. L., "Measurement of Electromagnetic Radiation from Electronic Equipment using TEM Transmission Cells," U.S. Department of Commerce, National Bureau of Standards, NBSIR 73-306, Feb. 1973.
12. Crawford, M. L., and Workman, J. L., "Using a TEM Cell for EMC Measurements of Electronic Equipment," U.S. Department of Commerce, National Bureau of Standards. Technical Note 1013, July 1981.
13. EHIMA GSM Project, Development phase, Project Report (1<sup>st</sup> part) Revision A. Technical-Audiological Laboratory and Telecom Denmark, October 1993.
14. EHIMA GSM Project, Development phase, Part II Project Report. Technical-Audiological Laboratory and Telecom Denmark, June 1994.
15. EHIMA GSM Project Final Report, Hearing Aids and GSM Mobile Telephones: Interference Problems, Methods of Measurement and Levels of Immunity. Technical-Audiological Laboratory and Telecom Denmark, 1995.
16. HAMPIS Report, Comparison of Mobile phone electromagnetic near field with an upscaled electromagnetic far field, using hearing aid as reference, 21 October 1999.

FCC ID: PY7-57325M		HAC (T-COIL) TEST REPORT	<b>SONY</b>	Approved by: Quality Manager
Filename: 1M2206010068-05-R4.PY7	Test Dates: 3/21/2022 – 6/6/2022	DUT Type: Portable Handset		Page 84 of 88

17. Hearing Aids/GSM, Report from OTWIDAM, Technical-Audiological Laboratory and Telecom Denmark, April 1993.
18. IEEE 100, The Authoritative Dictionary of IEEE Standards Terms, Seventh Edition.
19. Joyner, K. H., et. al., Interference to Hearing Aids by the New Digital Mobile Telephone System, Global System for Mobile (GSM) Communication Standard, National Acoustic Laboratory, Australian Hearing Series, Sydney 1993.
20. Joyner, K. H., et. al., Interference to Hearing Aids by the Digital Mobile Telephone System, Global System for Mobile Communications (GSM), NAL Report #131, National Acoustic Laboratory, Australian Hearing Series, Sydney, 1995.
21. Kecker, W. T., Crawford, M. L., and Wilson, W. A., "Construction of a Transverse Electromagnetic Cell", U.S. Department of Commerce, National Bureau of Standards, Technical Note 1011, Nov. 1978.
22. Konigstein, D., and Hansen, D., "A New Family of TEM Cells with enlarged bandwidth and Optimized working Volume," in the Proceedings of the 7<sup>th</sup> International Symposium on EMC, Zurich, Switzerland, March 1987; 50:9, pp. 127-132.
23. Kuk, F., and Hjorstgaard, N. K., "Factors affecting interference from digital cellular telephones," Hearing Journal, 1997; 50:9, pp 32-34.
24. Ma, M. A., and Kanda, M., "Electromagnetic Compatibility and Interference Metrology," U.S. Department of Commerce, National Bureau of Standards, Technical Note 1099, July 1986, pp. 17-43.
25. Ma, M. A., Sreenivashiah, I. , and Chang, D. C., "A Method of Determining the Emission and Susceptibility Levels of Electrically Small Objects Using a TEM Cell," U.S. Department of Commerce, National Bureau of Standards, Technial Note 1040, July 1981.
26. McCandless, G. A., and Lyregaard, P. E., Prescription of Gain/Output (POGO) for Hearing Aids, Hearing Instruments 1:16-21, 1983
27. Skopec, M., "Hearing Aid Electromagnetic Interference from Digital Wireless Telephones," IEEE Transactions on Rehabilitation Engineering, vol. 6, no. 2, pp. 235-239, June 1998.
28. Technical Report, GSM 05.90, GSM EMC Considerations, European Telecommunications Standards Institute, January 1993.
29. Victorian, T. A., "Digital Cellular Telephone Interference and Hearing Aid Compatibility—an Update," Hearing Journal 1998; 51:10, pp. 53-60
30. Wong, G. S. K., and Embleton, T. F. W., eds., AIP Handbook of Condenser Microphones: Theory, Calibration and Measurements, AIP Press.

FCC ID: PY7-57325M		HAC (T-COIL) TEST REPORT	<b>SONY</b>	Approved by: Quality Manager
Filename: 1M2206010068-05-R4.PY7	Test Dates: 3/21/2022 – 6/6/2022	DUT Type: Portable Handset		Page 85 of 88