



FCC RF Test Report

APPLICANT : Sony Mobile Communications Inc.
EQUIPMENT : GSM/WCDMA/LTE Phone+Bluetooth,
DTS/UNII a/b/g/n and NFC
BRAND NAME : Sony
FCC ID : PY7-02885J
STANDARD : FCC Part 15 Subpart C §15.247
CLASSIFICATION : (DSS) Spread Spectrum Transmitter

The product was received on Apr. 28, 2017 and testing was completed on May 31, 2017. We, SPORTON INTERNATIONAL INC., would like to declare that the tested sample has been evaluated in accordance with the test procedures and has been in compliance with the applicable technical standards.

The test results in this report apply exclusively to the tested model / sample. Without written approval of SPORTON INTERNATIONAL INC., the test report shall not be reproduced except in full.

Reviewed by: Joseph Lin / Supervisor

Approved by: Jones Tsai / Manager



SPORTON INTERNATIONAL INC.

No. 52, Hwa Ya 1st Rd., Hwa Ya Technology Park, Kwei-Shan District, Tao Yuan City, Taiwan, R.O.C.

SPORTON INTERNATIONAL INC.

TEL : 886-3-327-3456

FAX : 886-3-328-4978

FCC ID : PY7-02885J

Page Number : 1 of 71

Report Issued Date : Jul. 10, 2017

Report Version : Rev. 02

Report Template No.: BU5-FR15CBT Version 1.1



TABLE OF CONTENTS

REVISION HISTORY..... 3

SUMMARY OF TEST RESULT 4

1 GENERAL DESCRIPTION..... 5

 1.1 Applicant 5

 1.2 Manufacturer..... 5

 1.3 Product Feature of Equipment Under Test..... 5

 1.4 Modification of EUT 6

 1.5 Testing Location 7

 1.6 Applicable Standards..... 7

2 TEST CONFIGURATION OF EQUIPMENT UNDER TEST..... 8

 2.1 Carrier Frequency Channel 8

 2.2 Descriptions of Test Mode 9

 2.3 Test Mode..... 10

 2.4 Connection Diagram of Test System..... 11

 2.5 Support Unit used in test configuration and system 12

 2.6 EUT Operation Test Setup 12

 2.7 Measurement Results Explanation Example..... 12

3 TEST RESULT 13

 3.1 Number of Channel Measurement 13

 3.2 Hopping Channel Separation Measurement 15

 3.3 Dwell Time Measurement..... 22

 3.4 20dB and 99% Bandwidth Measurement 24

 3.5 Peak Output Power Measurement 37

 3.6 Conducted Band Edges Measurement..... 39

 3.7 Conducted Spurious Emission Measurement 46

 3.8 Radiated Band Edges and Spurious Emission Measurement 56

 3.9 AC Conducted Emission Measurement..... 64

 3.10 Antenna Requirements..... 68

4 LIST OF MEASURING EQUIPMENT..... 69

5 UNCERTAINTY OF EVALUATION..... 71

APPENDIX A. RADIATED SPURIOUS EMISSION

APPENDIX B. RADIATED SPURIOUS EMISSION PLOTS



SUMMARY OF TEST RESULT

Report Section	FCC Rule	Description	Limit	Result	Remark
3.1	15.247(a)(1)	Number of Channels	≥ 15Chs	Pass	-
3.2	15.247(a)(1)	Hopping Channel Separation	≥ 2/3 of 20dB BW	Pass	-
3.3	15.247(a)(1)	Dwell Time of Each Channel	≤ 0.4sec in 31.6sec period	Pass	-
3.4	15.247(a)(1)	20dB Bandwidth	NA	Pass	-
3.4	-	99% Bandwidth	-	Pass	-
3.5	15.247(b)(1)	Peak Output Power	≤ 125 mW	Pass	-
3.6	15.247(d)	Conducted Band Edges	≤ 20dBc	Pass	-
3.7	15.247(d)	Conducted Spurious Emission	≤ 20dBc	Pass	-
3.8	15.247(d)	Radiated Band Edges and Radiated Spurious Emission	15.209(a) & 15.247(d)	Pass	Under limit 6.90 dB at 139.080 MHz
3.9	15.207	AC Conducted Emission	15.207(a)	Pass	Under limit 15.20 dB at 0.454 MHz
3.10	15.203 & 15.247(b)	Antenna Requirement	N/A	Pass	-



1 General Description

1.1 Applicant

Sony Mobile Communications Inc.

4-12-3 Higashi-Shinagawa, Shinagawa-ku, Tokyo, 140-0002, Japan

1.2 Manufacturer

Sony Mobile Communications Inc.

4-12-3 Higashi-Shinagawa, Shinagawa-ku, Tokyo, 140-0002, Japan

1.3 Product Feature of Equipment Under Test

GSM/WCDMA/LTE, Bluetooth, DTS/UNII a/b/g/n, NFC, and GPS

Standards-related Product Specification	
Antenna Type / Gain	PIFA Antenna type with gain -2.2 dBi

EUT Information List			
HW Version	SW Version	S/N	Performed Test Item
A	0.32	RQ3004QXCU	RF conducted measurement
		RQ3004QXE8	Radiated Spurious Emission
		RQ3004R9RH	Conducted Emission



Accessory List	
AC Adapter 1	Model No. : UCH20
	S/N :
	1215W48600059 (for radiated spurious emission) 1215W48600011 (for conducted emission)
Earphone 1	Model No. : MH410c
	S/N: 1632A86600000E0
USB Cable	Model No. : UCB20
	S/N :
	1625A9110003BFA (for radiated spurious emission) 1625A9100003A98 (for conducted emission)

Note:

1. Above EUT list and accessory list used are electrically identical per declared by manufacturer.
2. Above the accessories list are used to exercise the EUT during test.
3. For other wireless features of this EUT, test report will be issued separately.

1.4 Modification of EUT

No modifications are made to the EUT during all test items.



1.5 Testing Location

Sporton Lab is accredited to ISO 17025 by Taiwan Accreditation Foundation (TAF code : 1190) and the FCC designation No. TW0007 under the FCC 2.948(e) by Mutual Recognition Agreement (MRA) in FCC Test.

Test Site	SPORTON INTERNATIONAL INC.	
Test Site Location	No. 52, Hwa Ya 1 st Rd., Hwa Ya Technology Park, Kwei-Shan District, Tao Yuan City, Taiwan, R.O.C. TEL: +886-3-327-3456 FAX: +886-3-328-4978	
Test Site No.	Sporton Site No.	
	TH05-HY	CO05-HY

Note: The test site complies with ANSI C63.4 2014 requirement.

Test Site	SPORTON INTERNATIONAL INC.	
Test Site Location	No.58, Aly. 75, Ln. 564, Wenhua 3rd Rd. Guishan Dist, Taoyuan City, Taiwan (R.O.C.) TEL: +886-3-327-0868 FAX: +886-3-327-0855	
Test Site No.	Sporton Site No.	
	03CH13-HY	

Note: The test site complies with ANSI C63.4 2014 requirement.

1.6 Applicable Standards

According to the specifications of the manufacturer, the EUT must comply with the requirements of the following standards:

- ♦ FCC Part 15 Subpart C §15.247
- ♦ ANSI C63.10-2013

Remark:

1. All test items were verified and recorded according to the standards and without any deviation during the test.
2. This EUT has also been tested and complied with the requirements of FCC Part 15, Subpart B, recorded in a separate test report.



2 Test Configuration of Equipment Under Test

2.1 Carrier Frequency Channel

Frequency Band	Channel	Freq. (MHz)	Channel	Freq. (MHz)	Channel	Freq. (MHz)
2400-2483.5 MHz	0	2402	27	2429	54	2456
	1	2403	28	2430	55	2457
	2	2404	29	2431	56	2458
	3	2405	30	2432	57	2459
	4	2406	31	2433	58	2460
	5	2407	32	2434	59	2461
	6	2408	33	2435	60	2462
	7	2409	34	2436	61	2463
	8	2410	35	2437	62	2464
	9	2411	36	2438	63	2465
	10	2412	37	2439	64	2466
	11	2413	38	2440	65	2467
	12	2414	39	2441	66	2468
	13	2415	40	2442	67	2469
	14	2416	41	2443	68	2470
	15	2417	42	2444	69	2471
	16	2418	43	2445	70	2472
	17	2419	44	2446	71	2473
	18	2420	45	2447	72	2474
	19	2421	46	2448	73	2475
	20	2422	47	2449	74	2476
	21	2423	48	2450	75	2477
	22	2424	49	2451	76	2478
	23	2425	50	2452	77	2479
	24	2426	51	2453	78	2480
	25	2427	52	2454	-	-
	26	2428	53	2455	-	-



2.2 Descriptions of Test Mode

Preliminary tests were performed in different data rates and recorded the RF output power in the following table:

Channel	Frequency	Bluetooth RF Output Power		
		Data Rate / Modulation		
		GFSK	$\pi/4$ -DQPSK	8-DPSK
		1Mbps	2Mbps	3Mbps
Ch00	2402MHz	6.17 dBm	5.29 dBm	5.56 dBm
Ch39	2441MHz	7.46 dBm	6.72 dBm	6.94 dBm
Ch78	2480MHz	4.58 dBm	3.88 dBm	4.07 dBm

- a. The EUT has been associated with peripherals and configuration operated in a manner tended to maximize its emission characteristics in a typical application. Frequency range investigated: conduction (150 kHz to 30 MHz), radiation (9 kHz to the 10th harmonic of the highest fundamental frequency or to 40 GHz, whichever is lower). Pre-scanned tests, X, Y, Z in three orthogonal panels, and different data rates were conducted to determine the final configuration (X plane as worst plane) from all possible combinations.

- b. AC power line Conducted Emission was tested under maximum output power.



2.3 Test Mode

The following summary table is showing all test modes to demonstrate in compliance with the standard.

Summary table of Test Cases			
Test Item	Data Rate / Modulation		
	Bluetooth BR 1Mbps GFSK	Bluetooth EDR 2Mbps $\pi/4$ -DQPSK	Bluetooth EDR 3Mbps 8-DPSK
Conducted Test Cases	Mode 1: CH00_2402 MHz Mode 2: CH39_2441 MHz Mode 3: CH78_2480 MHz	Mode 4: CH00_2402 MHz Mode 5: CH39_2441 MHz Mode 6: CH78_2480 MHz	Mode 7: CH00_2402 MHz Mode 8: CH39_2441 MHz Mode 9: CH78_2480 MHz
Radiated Test Cases	Bluetooth 1Mbps GFSK / EDR 2Mbps $\pi/4$-DQPSK / EDR 3Mbps 8-DPSK		
	Mode 1: CH00_2402 MHz for 1Mbps Mode 2: CH39_2441 MHz for 1Mbps Mode 3: CH78_2480 MHz for 1Mbps Mode 4: CH00_2402 MHz for 2Mbps Mode 5: CH39_2441 MHz for 2Mbps Mode 6: CH78_2480 MHz for 2Mbps Mode 7: CH00_2402 MHz for 3Mbps Mode 8: CH39_2441 MHz for 3Mbps Mode 9: CH78_2480 MHz for 3Mbps		
AC Conducted Emission	Mode 1 :GSM1900 Idle + Bluetooth Link + WLAN (2.4GHz) Link + MP3 + Earphone 1 + Battery + USB Cable (Charging from Adapter 1)		

2.4 Connection Diagram of Test System

<Bluetooth Tx Mode>

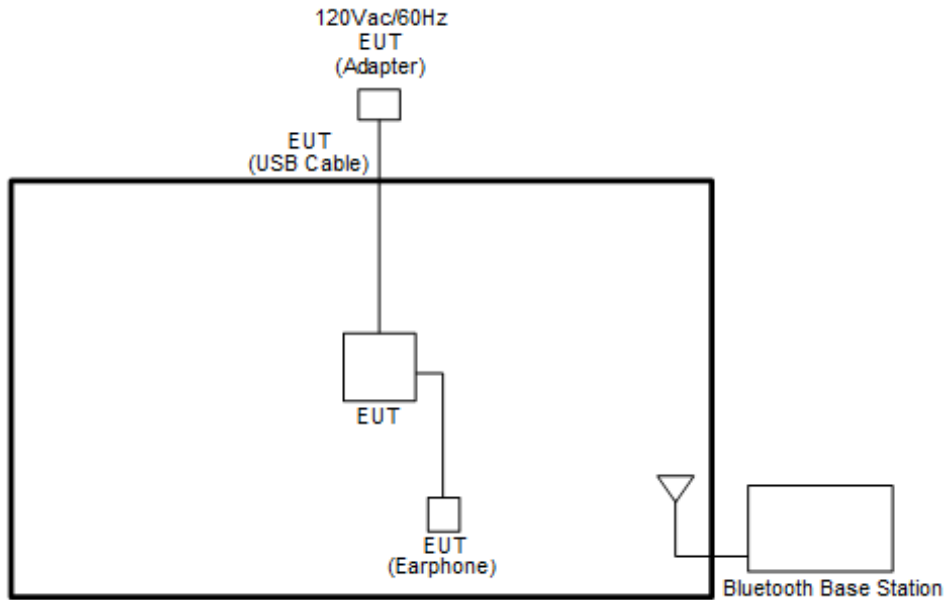

<AC Conducted Emission Mode>

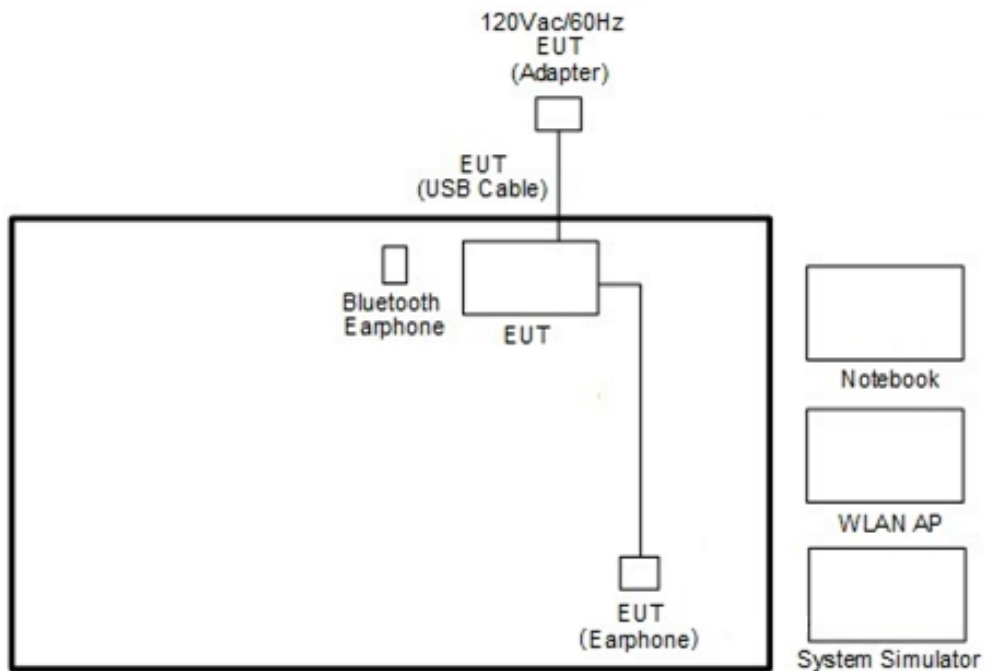



2.5 Support Unit used in test configuration and system

Item	Equipment	Trade Name	Model Name	FCC ID	Data Cable	Power Cord
1.	Bluetooth Base Station	R&S	CBT32	N/A	N/A	Unshielded, 1.8 m
2.	System Simulator	Anritsu	MT8820C	N/A	N/A	Unshielded, 1.8 m
3.	WLAN AP	ASUS	RT-AC66U	MSQ-RTAC66U	N/A	Unshielded, 1.8 m
4.	Notebook	DELL	Latitude E6320	FCC DoC/ Contains FCC ID: QDS-BRCM1054	N/A	AC I/P: Unshielded, 1.2 m DC O/P: Shielded, 1.8 m
5.	Bluetooth Earphone	Sony	SBH20	PY7-RD0010	N/A	N/A
6.	SD Card	SanDisk	MicroSD HC	FCC DoC	N/A	N/A

2.6 EUT Operation Test Setup

For RF test items, an engineering test program was provided and enabled to make EUT transmitting signals.

2.7 Measurement Results Explanation Example

For all conducted test items:

The offset level is set in the spectrum analyzer to compensate the RF cable loss and attenuator factor between EUT conducted output port and spectrum analyzer. With the offset compensation, the spectrum analyzer reading level is exactly the EUT RF output level.

Example:

The spectrum analyzer offset is derived from RF cable loss and attenuator factor.

Offset = RF cable loss + attenuator factor.

Following shows an offset computation example with cable loss 4.2 dB and 10dB attenuator.

$$\begin{aligned} \text{Offset(dB)} &= \text{RF cable loss(dB)} + \text{attenuator factor(dB)}. \\ &= 4.2 + 10 = 14.2 \text{ (dB)} \end{aligned}$$

3 Test Result

3.1 Number of Channel Measurement

3.1.1 Limits of Number of Hopping Frequency

Frequency hopping systems in the 2400-2483.5 MHz band shall use at least 15 channels.

3.1.2 Measuring Instruments

The measuring equipment is listed in the section 4 of this test report.

3.1.3 Test Procedure

1. The testing follows ANSI C63.10-2013 clause 7.8.3.
2. The RF output of EUT was connected to the spectrum analyzer by RF cable and attenuator. The path loss was compensated to the results for each measurement.
3. Set to the maximum power setting and enable the EUT transmit continuously.
4. Enable the EUT hopping function.
5. Use the following spectrum analyzer settings: Span = the frequency band of operation; RBW = 300kHz; VBW \geq RBW; Sweep = auto; Detector function = peak; Trace = max hold.
6. The number of hopping frequency used is defined as the number of total channel.
7. Record the measurement data derived from spectrum analyzer.

3.1.4 Test Setup



3.1.5 Test Result of Number of Hopping Frequency

Test Mode :	1Mbps	Temperature :	24~26°C
Test Engineer :	Kai Liao	Relative Humidity :	48~51%
Number of Hopping (Channel)	Adaptive Frequency Hopping (Channel)	Limits (Channel)	Pass/Fail
79	20	> 15	Pass



Number of Hopping Channel Plot on Channel 00 - 78

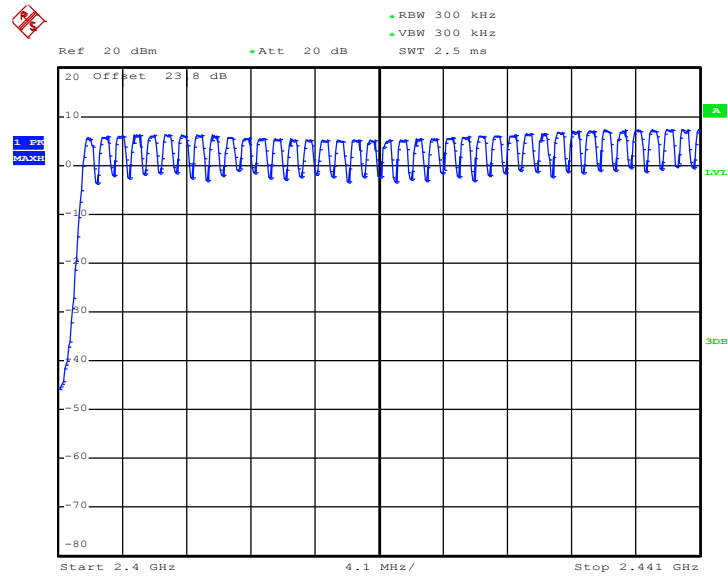

Date: 27.MAY.2017 18:35:58

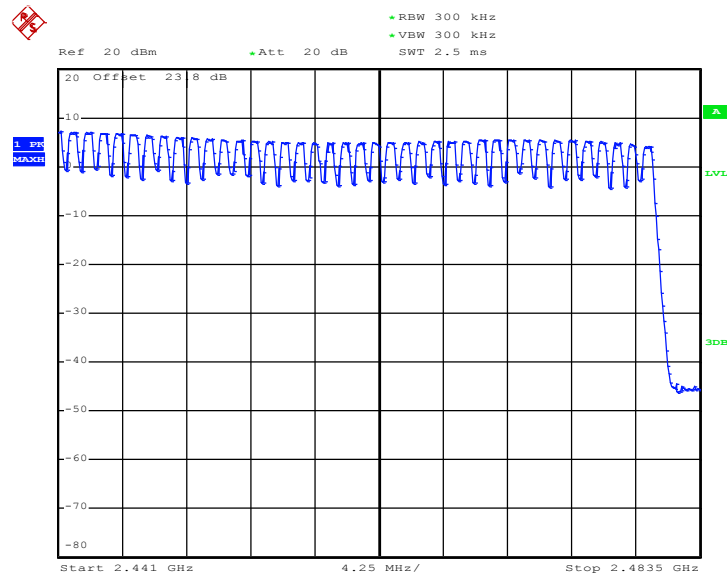

Date: 27.MAY.2017 18:37:03

3.2 Hopping Channel Separation Measurement

3.2.1 Limit of Hopping Channel Separation

Frequency hopping systems operating in the 2400-2483.5 MHz band may have hopping channel carrier frequencies that are separated by 25 kHz or two-thirds of the 20 dB bandwidth of the hopping channel, whichever is greater.

3.2.2 Measuring Instruments

The measuring equipment is listed in the section 4 of this test report.

3.2.3 Test Procedures

1. The testing follows ANSI C63.10-2013 clause 7.8.2.
2. The RF output of EUT was connected to the spectrum analyzer by RF cable and attenuator. The path loss was compensated to the results for each measurement.
3. Set to the maximum power setting and enable the EUT transmit continuously.
4. Enable the EUT hopping function.
5. Use the following spectrum analyzer settings:
Span = wide enough to capture the peaks of two adjacent channels;
RBW = 300kHz; VBW \geq RBW; Sweep = auto; Detector function = peak; Trace = max hold.
6. Measure and record the results in the test report.

3.2.4 Test Setup





3.2.5 Test Result of Hopping Channel Separation

Test Mode :	1Mbps	Temperature :	24~26°C
Test Engineer :	Kai Liao	Relative Humidity :	48~51%

Channel	Frequency (MHz)	Frequency Separation (MHz)	(2/3 of 20dB BW) Limits (MHz)	Pass/Fail
00	2402	1.014	0.6240	Pass
39	2441	1.008	0.6187	Pass
78	2480	0.996	0.6160	Pass

Channel Separation Plot on Channel 00 - 01

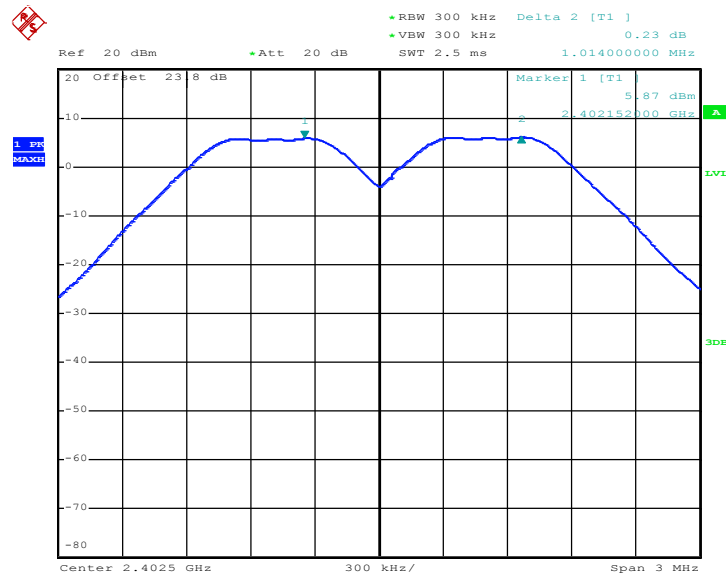

Date: 27.MAY.2017 18:55:00



Channel Separation Plot on Channel 39 - 40

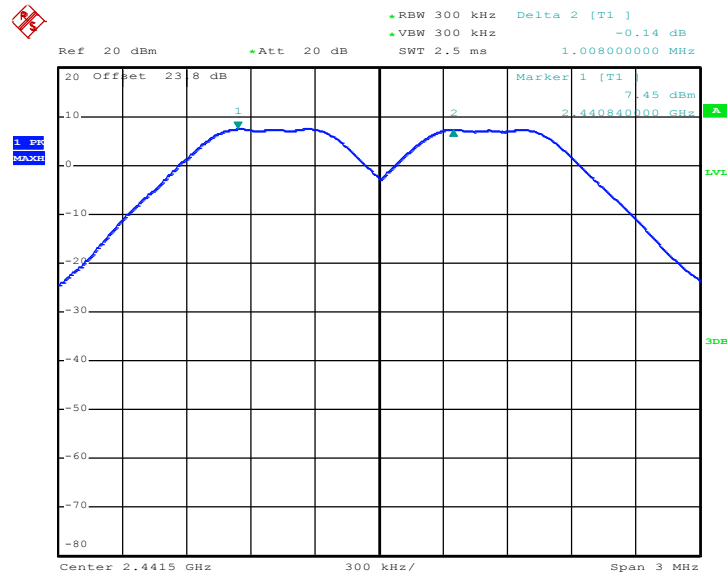

Date: 27.MAY.2017 19:04:56

Channel Separation Plot on Channel 77 - 78

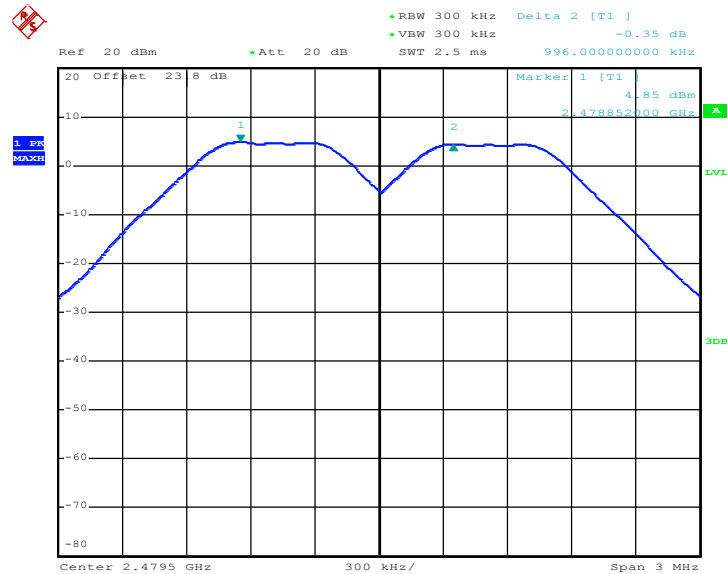

Date: 27.MAY.2017 19:13:00



Test Mode :	2Mbps	Temperature :	24~26°C
Test Engineer :	Kai Liao	Relative Humidity :	48~51%

Channel	Frequency (MHz)	Frequency Separation (MHz)	(2/3 of 20dB BW) Limits (MHz)	Pass/Fail
00	2402	0.996	0.8400	Pass
39	2441	0.990	0.8440	Pass
78	2480	1.002	0.8400	Pass

Channel Separation Plot on Channel 00 - 01

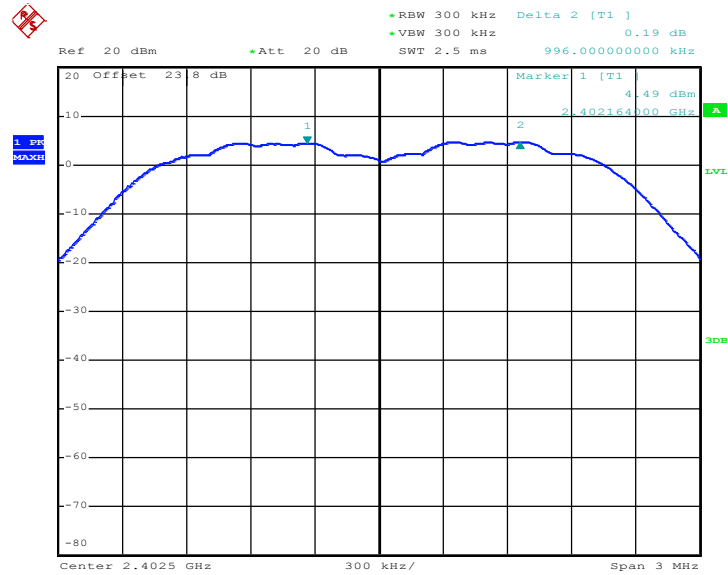

Date: 27.MAY.2017 19:23:06



Channel Separation Plot on Channel 39 - 40

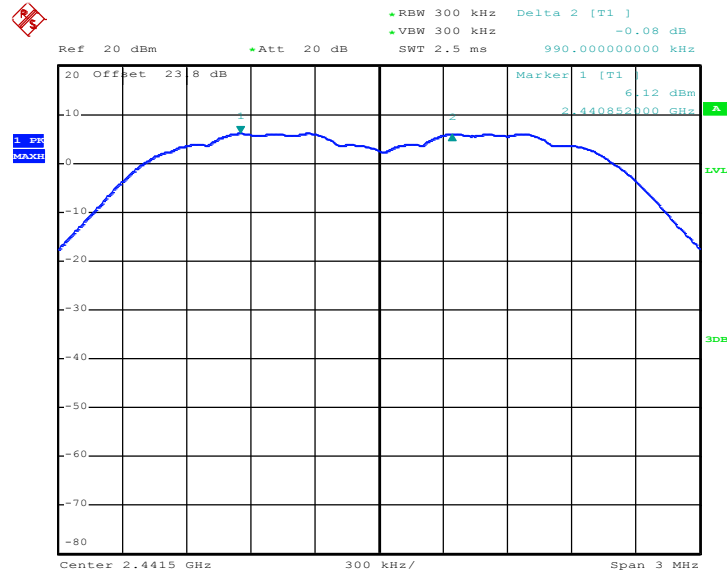

Date: 27.MAY.2017 19:32:20

Channel Separation Plot on Channel 77 - 78

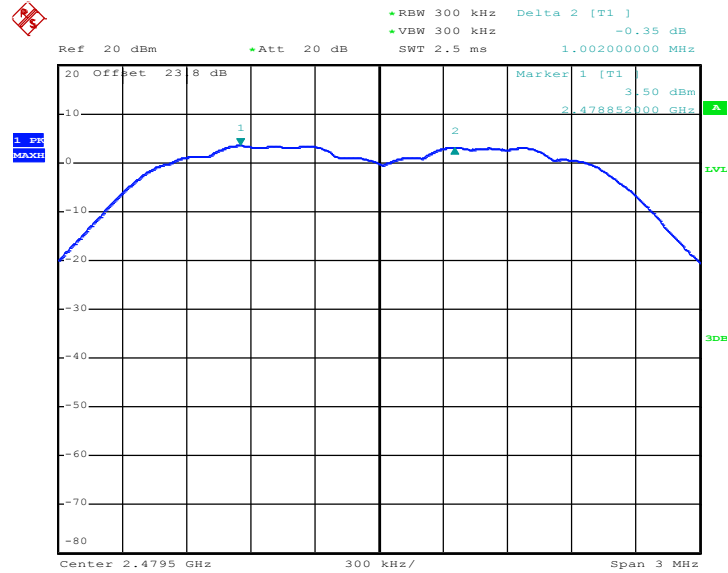

Date: 27.MAY.2017 19:37:47



Test Mode :	3Mbps	Temperature :	24~26°C
Test Engineer :	Kai Liao	Relative Humidity :	48~51%

Channel	Frequency (MHz)	Frequency Separation (MHz)	(2/3 of 20dB BW) Limits (MHz)	Pass/Fail
00	2402	0.990	0.8240	Pass
39	2441	1.008	0.8280	Pass
78	2480	0.990	0.8320	Pass

Channel Separation Plot on Channel 00 - 01

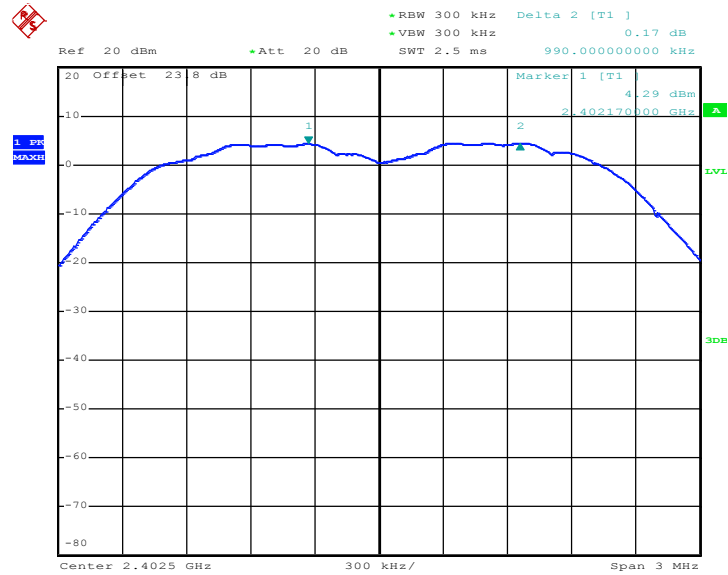

Date: 27.MAY.2017 20:10:48



Channel Separation Plot on Channel 39 - 40

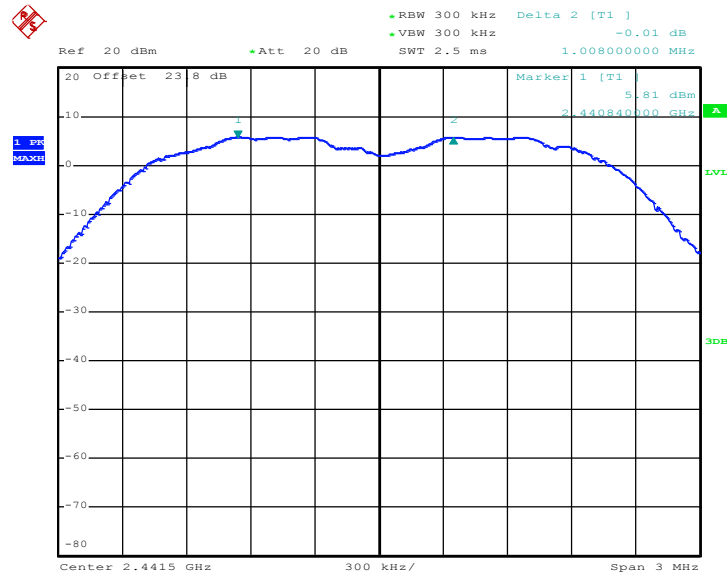

Date: 27.MAY.2017 20:19:58

Channel Separation Plot on Channel 77 - 78

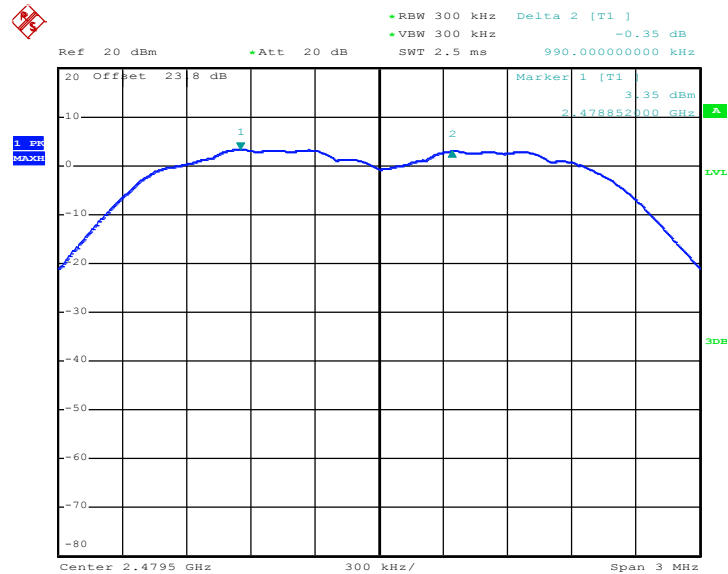

Date: 27.MAY.2017 20:24:39

3.3 Dwell Time Measurement

3.3.1 Limit of Dwell Time

The average time of occupancy on any channel shall not be greater than 0.4 seconds within a period of 0.4 seconds multiplied by the number of hopping channels employed.

3.3.2 Measuring Instruments

The measuring equipment is listed in the section 4 of this test report.

3.3.3 Test Procedures

1. The testing follows ANSI C63.10-2013 clause 7.8.4.
2. The RF output of EUT was connected to the spectrum analyzer by RF cable and attenuator. The path loss was compensated to the results for each measurement.
3. Set to the maximum power setting and enable the EUT transmit continuously.
4. Enable the EUT hopping function.
5. Use the following spectrum analyzer settings: Span = zero span, centered on a hopping channel; RBW = 1 MHz; VBW \geq RBW; Sweep = as necessary to capture the entire dwell time per hopping channel; Detector function = peak; Trace = max hold.
6. Measure and record the results in the test report.

3.3.4 Test Setup





3.3.5 Test Result of Dwell Time

Test Mode :	DH5	Temperature :	24~26°C
Test Engineer :	Kai Liao	Relative Humidity :	48~51%

Mode	Hopping Channel Number	Hops Over Occupancy Time(hops)	Package Transfer Time (msec)	Dwell Time (sec)	Limits (sec)	Pass/Fail
Normal	79	106.67	2.88	0.31	0.4	Pass
AFH	20	53.33	2.88	0.15	0.4	Pass

Remark:

- In normal mode, hopping rate is 1600 hops/s with 6 slots in 79 hopping channels. With channel hopping rate (1600 / 6 / 79) in Occupancy Time Limit (0.4 x 79) (s), Hops Over Occupancy Time comes to (1600 / 6 / 79) x (0.4 x 79) = 106.67 hops.
- In AFH mode, hopping rate is 800 hops/s with 6 slots in 20 hopping channels. With channel hopping rate (800 / 6 / 20) in Occupancy Time Limit (0.4 x 20) (s), Hops Over Occupancy Time comes to (800 / 6 / 20) x (0.4 x 20) = 53.33 hops.
- Dwell Time(s) = Hops Over Occupancy Time (hops) x Package Transfer Time

Package Transfer Time Plot

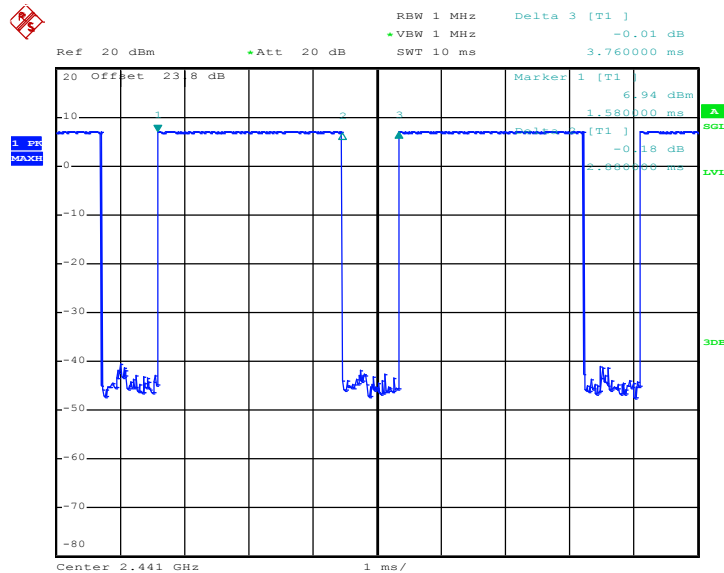

Date: 17.MAY.2017 01:54:34

3.4 20dB and 99% Bandwidth Measurement

3.4.1 Limit of 20dB and 99% Bandwidth

Reporting only

3.4.2 Measuring Instruments

The measuring equipment is listed in the section 4 of this test report.

3.4.3 Test Procedures

1. The testing follows ANSI C63.10-2013 clause 6.9.2 and 6.9.3.
2. The RF output of EUT was connected to the spectrum analyzer by RF cable and attenuator. The path loss was compensated to the results for each measurement.
3. Set to the maximum power setting and enable the EUT transmit continuously.
4. Use the following spectrum analyzer settings for 20dB Bandwidth measurement.
Span = approximately 2 to 5 times the 20 dB bandwidth, centered on a hopping channel;
RBW \geq 1% of the 20 dB bandwidth; VBW \geq RBW; Sweep = auto; Detector function = peak;
Trace = max hold.
5. Use the following spectrum analyzer settings for 99 % Bandwidth measurement.
Span = approximately 1.5 to 5 times the 99% bandwidth, centered on a hopping channel;
RBW \geq 1% of the 99% bandwidth; VBW \geq RBW; Sweep = auto; Detector function = peak;
Trace = max hold.
6. Measure and record the results in the test report.

3.4.4 Test Setup





3.4.5 Test Result of 20dB Bandwidth

Test Mode :	1Mbps	Temperature :	24~26°C
Test Engineer :	Kai Liao	Relative Humidity :	48~51%

Channel	Frequency (MHz)	20dB Bandwidth (MHz)
00	2402	0.936
39	2441	0.928
78	2480	0.924

20 dB Bandwidth Plot on Channel 00

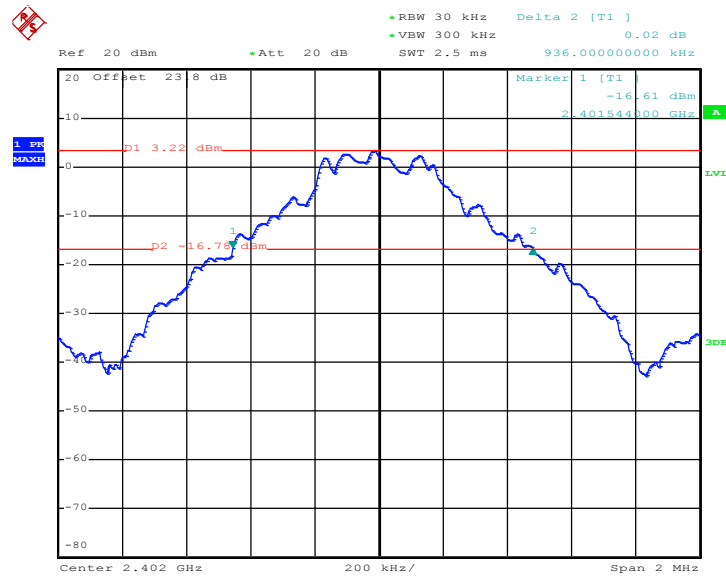

Date: 27.MAY.2017 18:57:40



20 dB Bandwidth Plot on Channel 39

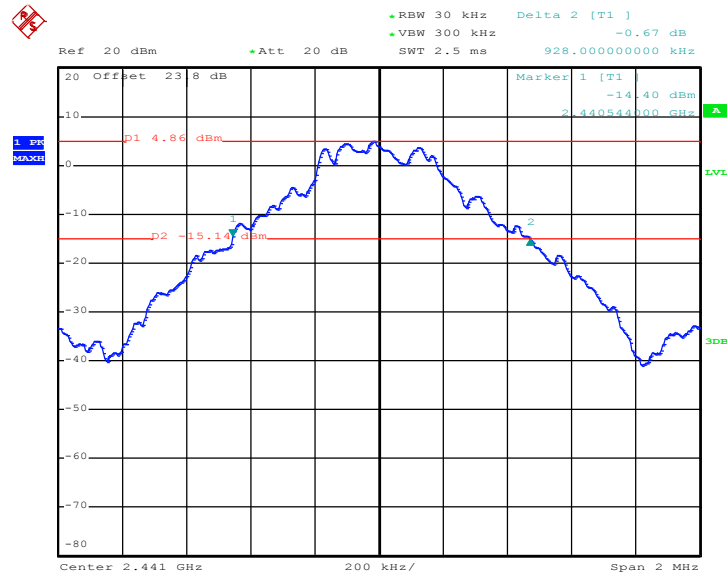

Date: 27.MAY.2017 19:18:40

20 dB Bandwidth Plot on Channel 78

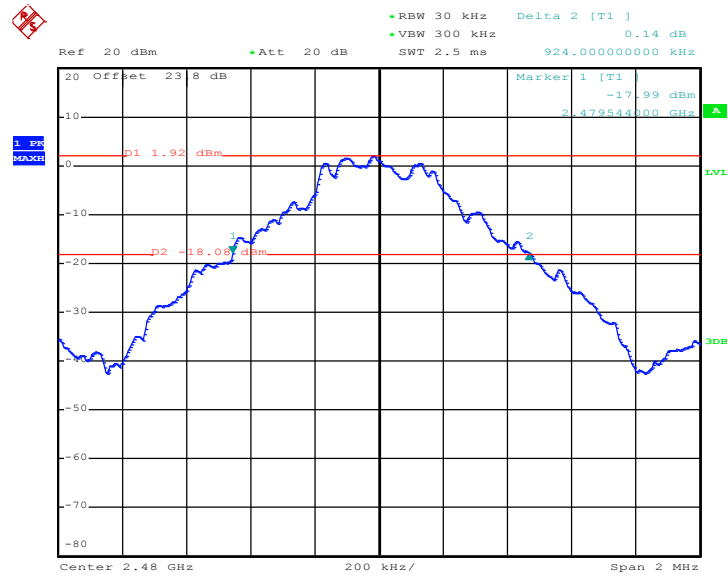

Date: 27.MAY.2017 19:16:20



Test Mode :	2Mbps	Temperature :	24~26°C
Test Engineer :	Kai Liao	Relative Humidity :	48~51%

Channel	Frequency (MHz)	20dB Bandwidth (MHz)
00	2402	1.260
39	2441	1.266
78	2480	1.260

20 dB Bandwidth Plot on Channel 00

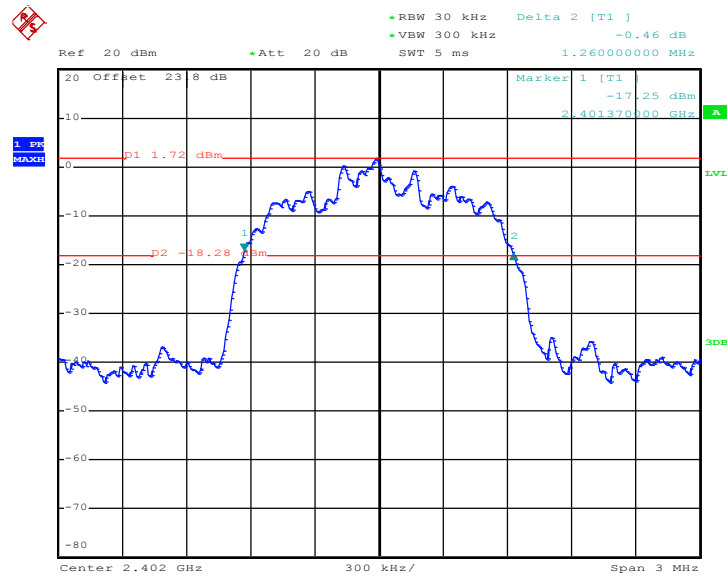

Date: 27.MAY.2017 19:41:26



20 dB Bandwidth Plot on Channel 39

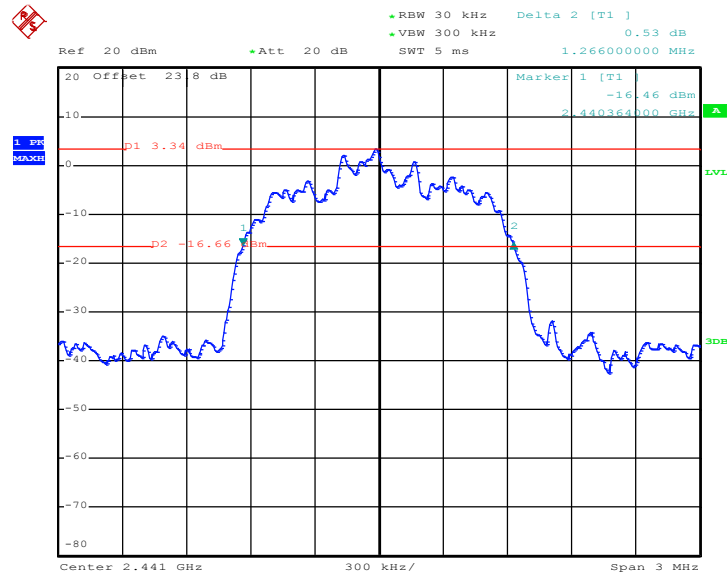

Date: 27.MAY.2017 19:35:13

20 dB Bandwidth Plot on Channel 78

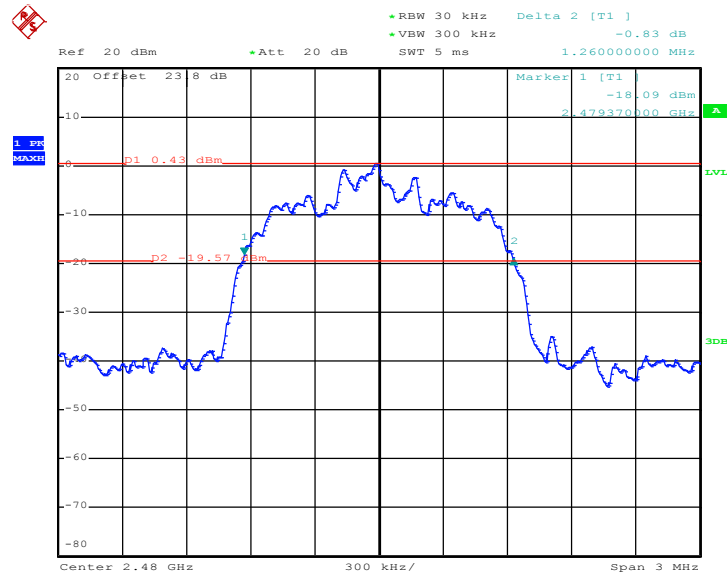

Date: 27.MAY.2017 19:38:57



Test Mode :	3Mbps	Temperature :	24~26°C
Test Engineer :	Kai Liao	Relative Humidity :	48~51%

Channel	Frequency (MHz)	20dB Bandwidth (MHz)
00	2402	1.236
39	2441	1.242
78	2480	1.248

20 dB Bandwidth Plot on Channel 00

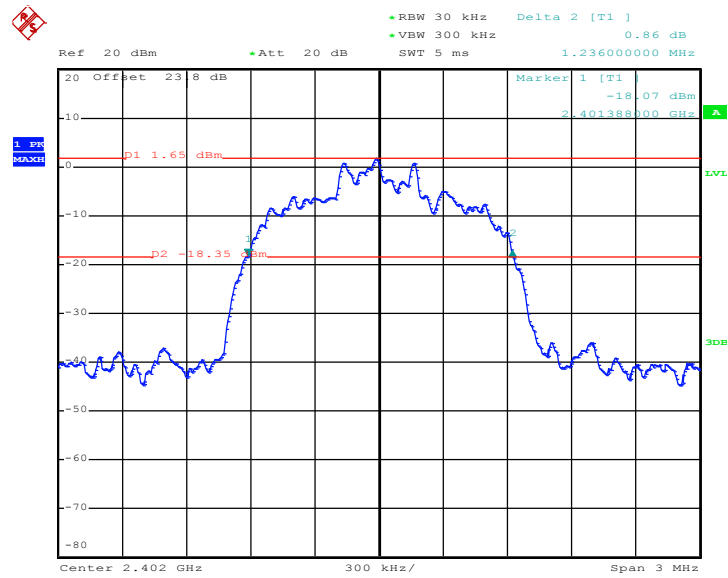

Date: 27.MAY.2017 20:12:26



20 dB Bandwidth Plot on Channel 39

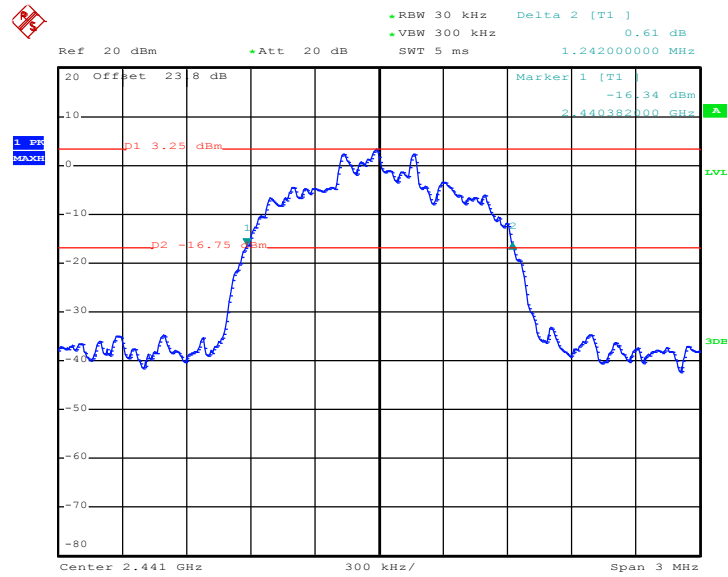

Date: 27.MAY.2017 20:21:14

20 dB Bandwidth Plot on Channel 78

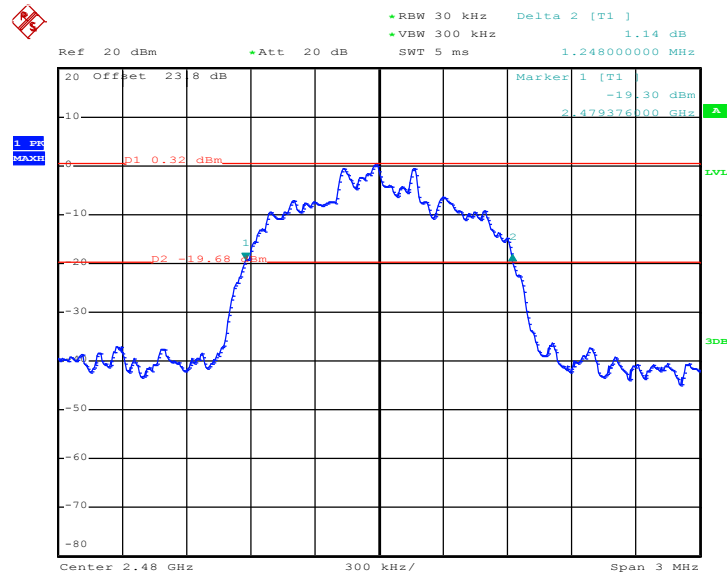

Date: 27.MAY.2017 20:26:31



3.4.6 Test Result of 99% Occupied Bandwidth

Test Mode :	1Mbps	Temperature :	24~26°C
Test Engineer :	Kai Liao	Relative Humidity :	48~51%

Channel	Frequency (MHz)	99% Occupied Bandwidth (MHz)
00	2402	0.860
39	2441	0.860
78	2480	0.860

99% Occupied Bandwidth Plot on Channel 00

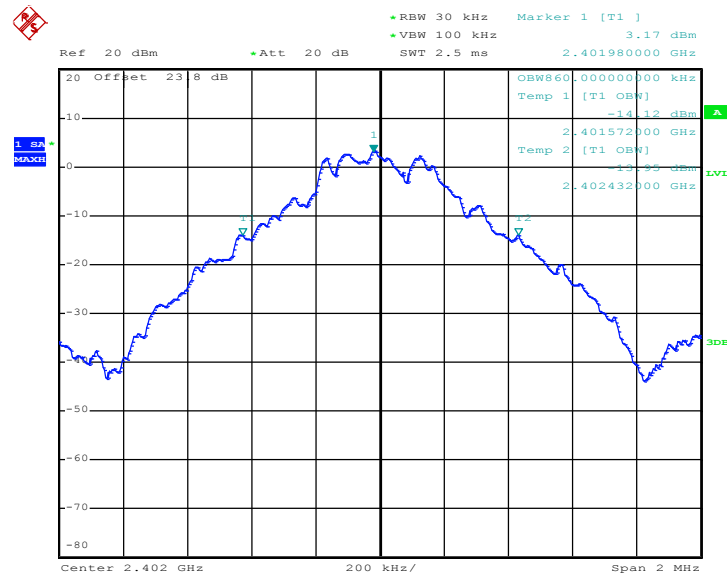

Date: 27.MAY.2017 19:00:28



99% Occupied Bandwidth Plot on Channel 39

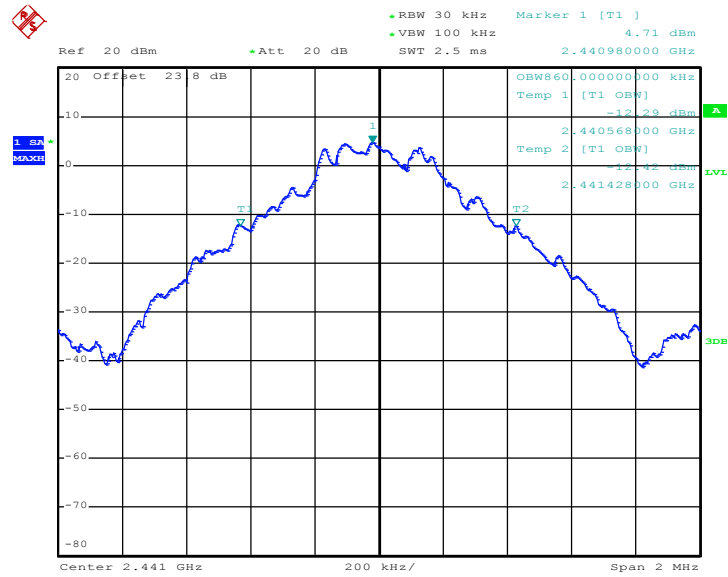

Date: 27.MAY.2017 19:08:45

99% Occupied Bandwidth Plot on Channel 78

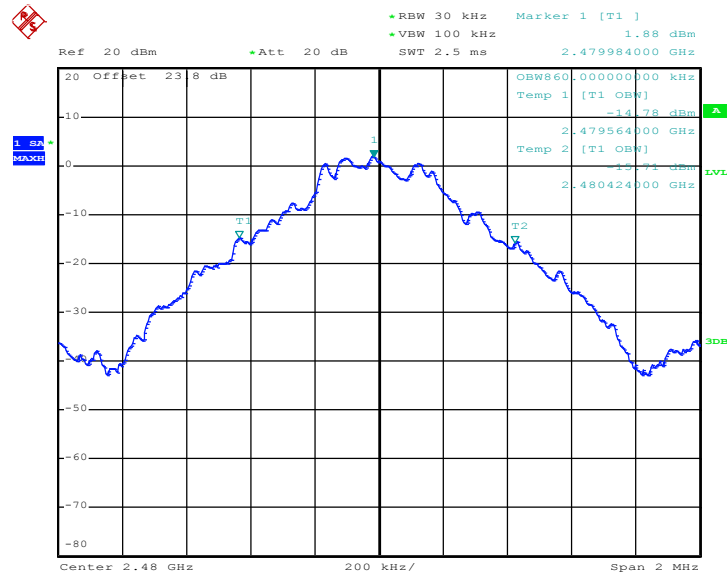

Date: 27.MAY.2017 19:19:59



Test Mode :	2Mbps	Temperature :	24~26°C
Test Engineer :	Kai Liao	Relative Humidity :	48~51%

Channel	Frequency (MHz)	99% Occupied Bandwidth (MHz)
00	2402	1.164
39	2441	1.164
78	2480	1.168

99% Occupied Bandwidth Plot on Channel 00

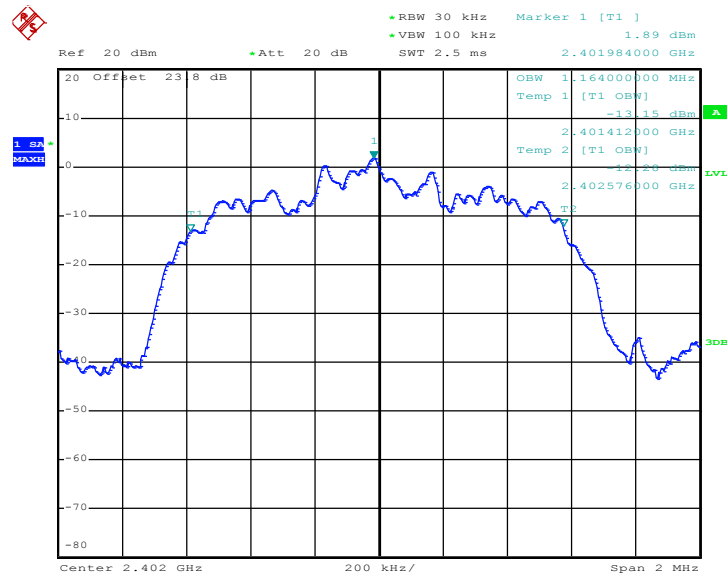

Date: 27.MAY.2017 19:26:19



99% Occupied Bandwidth Plot on Channel 39

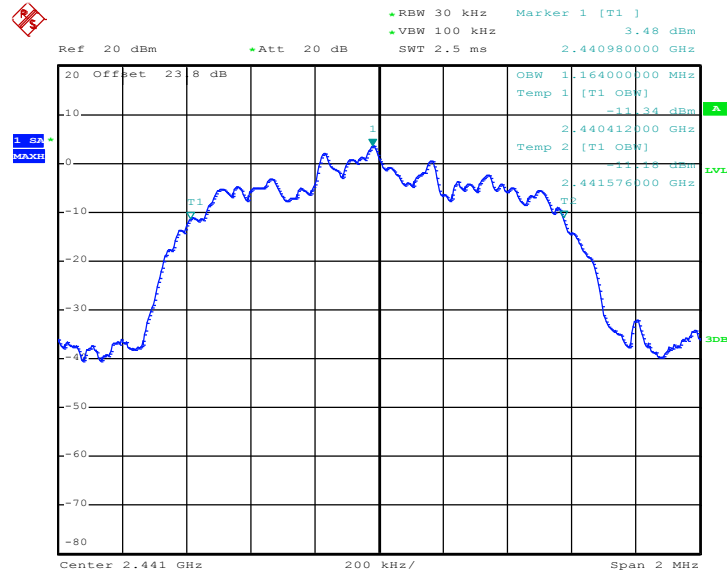

Date: 27.MAY.2017 19:34:13

99% Occupied Bandwidth Plot on Channel 78

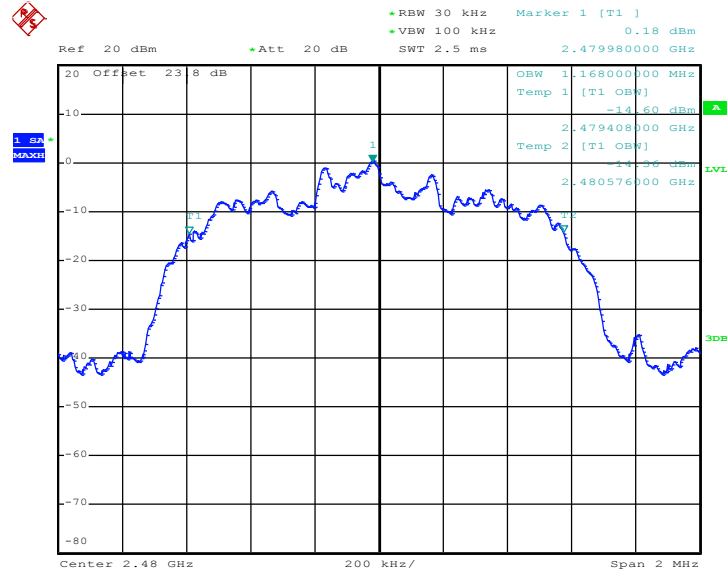

Date: 27.MAY.2017 19:40:02



Test Mode :	3Mbps	Temperature :	24~26°C
Test Engineer :	Kai Liao	Relative Humidity :	48~51%

Channel	Frequency (MHz)	99% Occupied Bandwidth (MHz)
00	2402	1.164
39	2441	1.148
78	2480	1.152

99% Occupied Bandwidth Plot on Channel 00

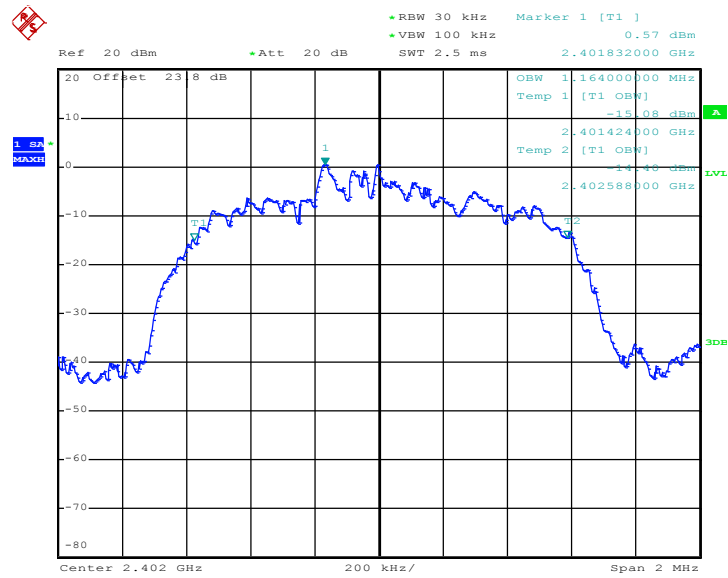

Date: 27.MAY.2017 20:13:01



99% Occupied Bandwidth Plot on Channel 39

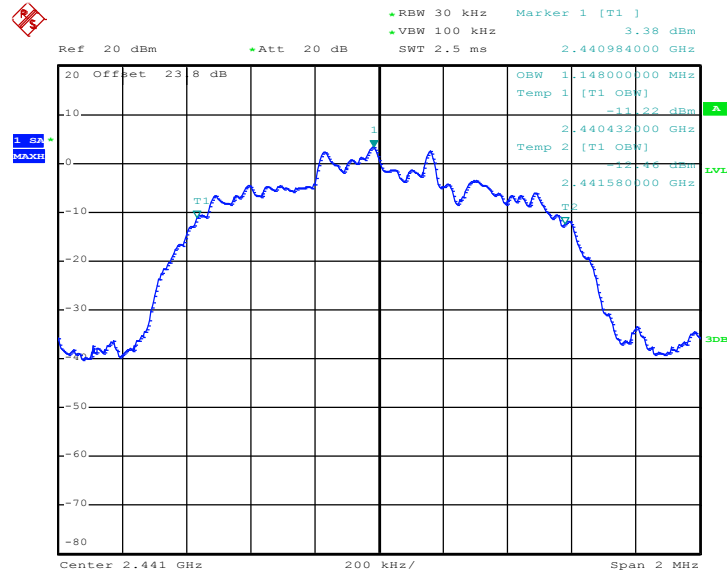

Date: 27.MAY.2017 20:22:14

99% Occupied Bandwidth Plot on Channel 78

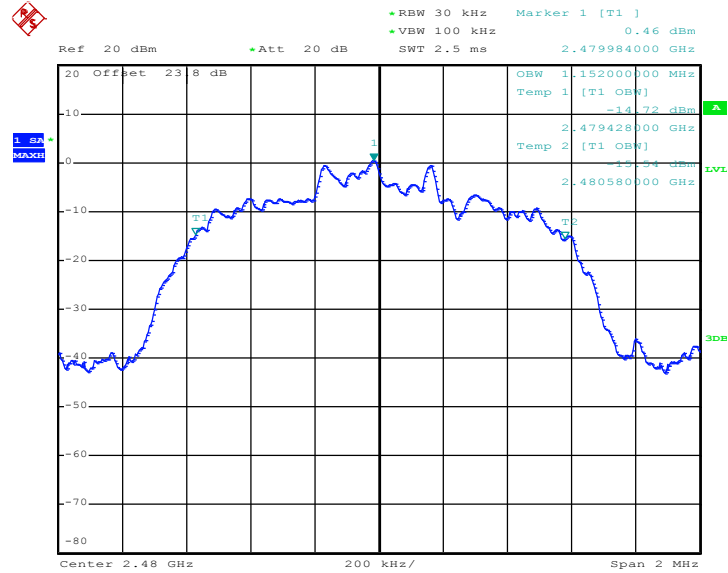

Date: 27.MAY.2017 20:27:19

Note : The occupied channel bandwidth is maintained within the band of operation for all of the modulations.

3.5 Peak Output Power Measurement

3.5.1 Limit of Peak Output Power

The maximum peak conducted output power of the intentional radiator shall not exceed the following:
(1) For frequency hopping systems operating in the 2400-2483.5 MHz band employing at least 75 non-overlapping hopping channels, and all frequency hopping systems in the 5725-5850 MHz band: 1 watt. For all other frequency hopping systems in the 2400-2483.5 MHz band 0.125 watts. The power limit for 1Mbps, 2Mbps, 3Mbps and AFH modes are 0.125 watts.

3.5.2 Measuring Instruments

The measuring equipment is listed in the section 4 of this test report.

3.5.3 Test Procedures

1. The testing follows ANSI C63.10-2013 clause 7.8.5.
2. The RF output of EUT was connected to the power meter by RF cable and attenuator. The path loss was compensated to the results for each measurement.
3. Set to the maximum power setting and enable the EUT transmit continuously.
4. Measure the conducted output power with cable loss and record the results in the test report.
5. Measure and record the results in the test report.

3.5.4 Test Setup

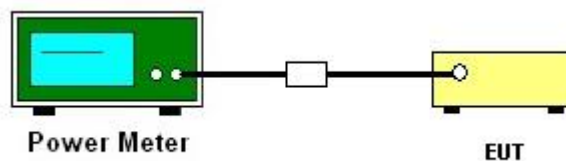



3.5.5 Test Result of Peak Output Power

Test Mode :	1Mbps	Temperature :	24~26°C
Test Engineer :	Kai Liao	Relative Humidity :	48~51%

Channel	Frequency (MHz)	RF Power (dBm)		
		GFSK	Max. Limits (dBm)	Pass/Fail
		1 Mbps		
00	2402	6.17	20.97	Pass
39	2441	7.46	20.97	Pass
78	2480	4.58	20.97	Pass

Note: For AFH mode using 20 hopping channels, the maximum output power limit is 20.97dBm.

Test Mode :	2Mbps	Temperature :	24~26°C
Test Engineer :	Kai Liao	Relative Humidity :	48~51%

Channel	Frequency (MHz)	RF Power (dBm)		
		$\pi/4$ -DQPSK	Max. Limits (dBm)	Pass/Fail
		2 Mbps		
00	2402	5.29	20.97	Pass
39	2441	6.72	20.97	Pass
78	2480	3.88	20.97	Pass

Test Mode :	3Mbps	Temperature :	24~26°C
Test Engineer :	Kai Liao	Relative Humidity :	48~51%

Channel	Frequency (MHz)	RF Power (dBm)		
		8-DPSK	Max. Limits (dBm)	Pass/Fail
		3 Mbps		
00	2402	5.56	20.97	Pass
39	2441	6.94	20.97	Pass
78	2480	4.07	20.97	Pass

3.6 Conducted Band Edges Measurement

3.6.1 Limit of Band Edges

In any 100 kHz bandwidth outside the intentional radiation frequency band, the radio frequency power shall be at least 20 dB below the highest level of the radiated power. In addition, radiated emissions which fall in the restricted bands must also comply with the radiated emission limits.

3.6.2 Measuring Instruments

The measuring equipment is listed in the section 4 of this test report.

3.6.3 Test Procedures

1. The testing follows ANSI C63.10-2013 clause 7.8.6.
2. Set to the maximum power setting and enable the EUT transmit continuously.
3. Set RBW = 100kHz, VBW = 300kHz. Band edge emissions must be at least 20 dB down from the highest emission level within the authorized band as measured with a 100kHz RBW. The attenuation shall be 30 dB instead of 20 dB when RMS conducted output power procedure is used.
4. Enable hopping function of the EUT and then repeat step 2. and 3.
5. Measure and record the results in the test report.

3.6.4 Test Setup





3.6.5 Test Result of Conducted Band Edges

Test Mode :	1Mbps	Temperature :	24~26°C
Test Channel :	00 and 78	Relative Humidity :	48~51%
		Test Engineer :	Kai Liao

Low Band Edge Plot on Channel 00

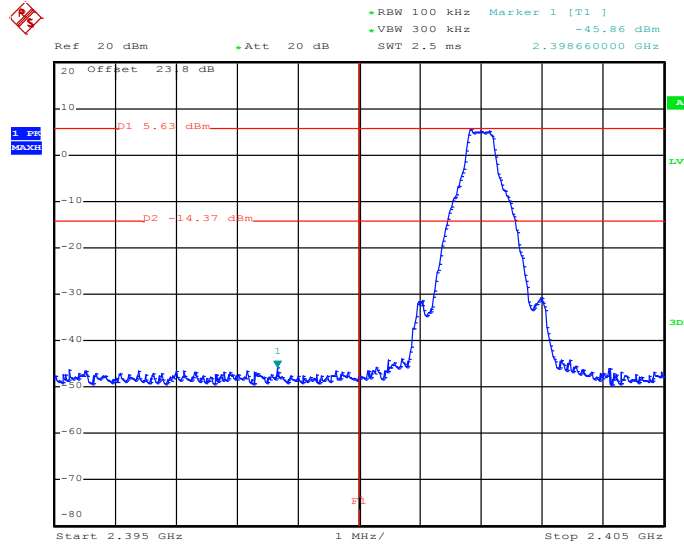

Date: 27.MAY.2017 19:03:31

High Band Edge Plot on Channel 78

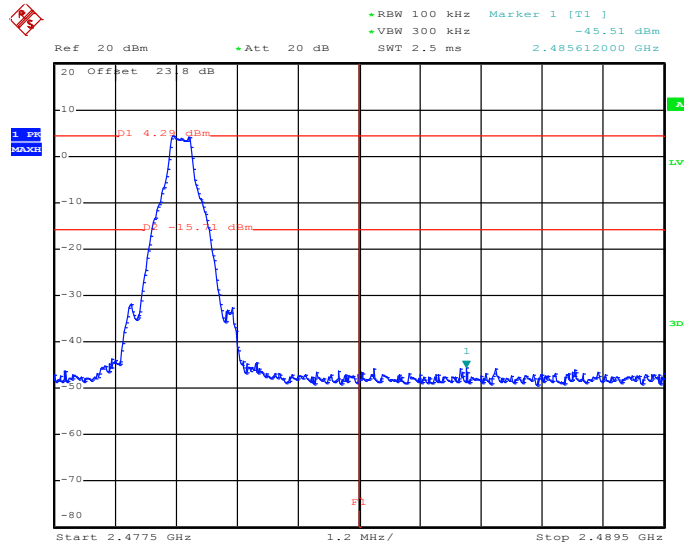

Date: 27.MAY.2017 19:21:52



Test Mode :	2Mbps	Temperature :	24~26°C
Test Channel :	00 and 78	Relative Humidity :	48~51%
		Test Engineer :	Kai Liao

Low Band Edge Plot on Channel 00

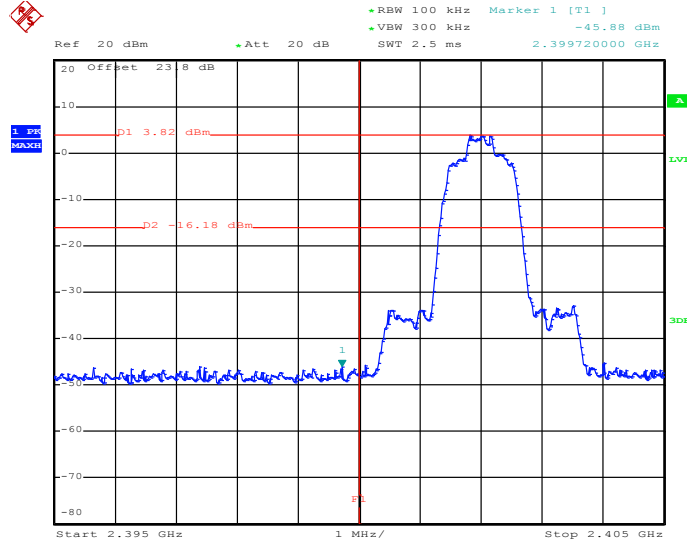

Date: 27.MAY.2017 19:31:09

High Band Edge Plot on Channel 78

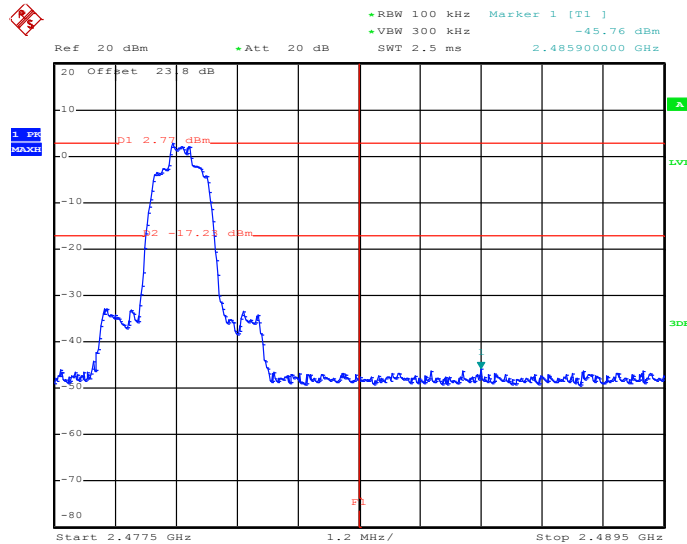

Date: 27.MAY.2017 20:09:30



Test Mode :	3Mbps	Temperature :	24~26°C
Test Channel :	00 and 78	Relative Humidity :	48~51%
		Test Engineer :	Kai Liao

Low Band Edge Plot on Channel 00

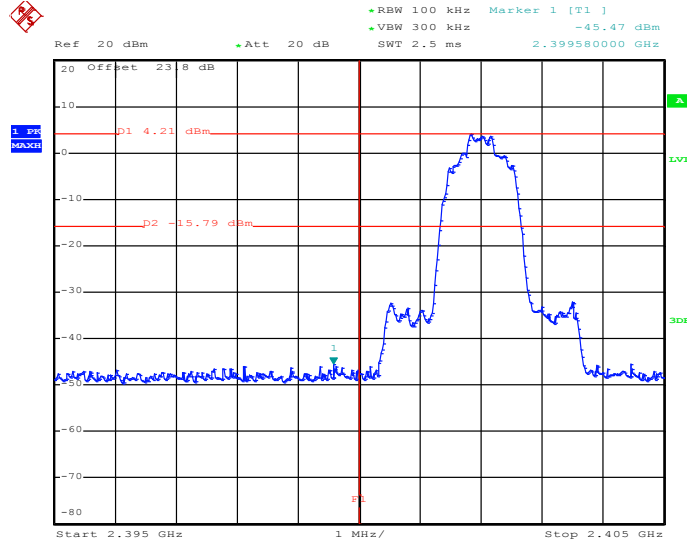

Date: 27.MAY.2017 20:18:38

High Band Edge Plot on Channel 78

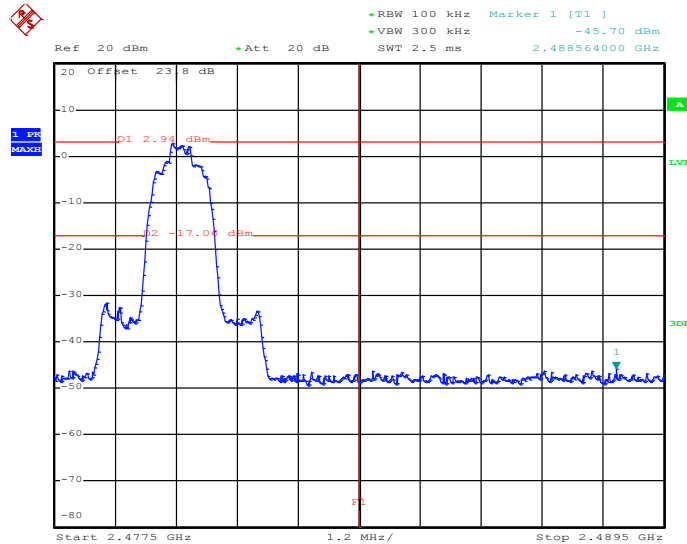

Date: 27.MAY.2017 20:30:18



3.6.6 Test Result of Conducted Hopping Mode Band Edges

Test Mode :	1Mbps	Temperature :	24~26°C
Test Engineer :	Kai Liao	Relative Humidity :	48~51%

1Mbps Hopping Mode Low Band Edge Plot

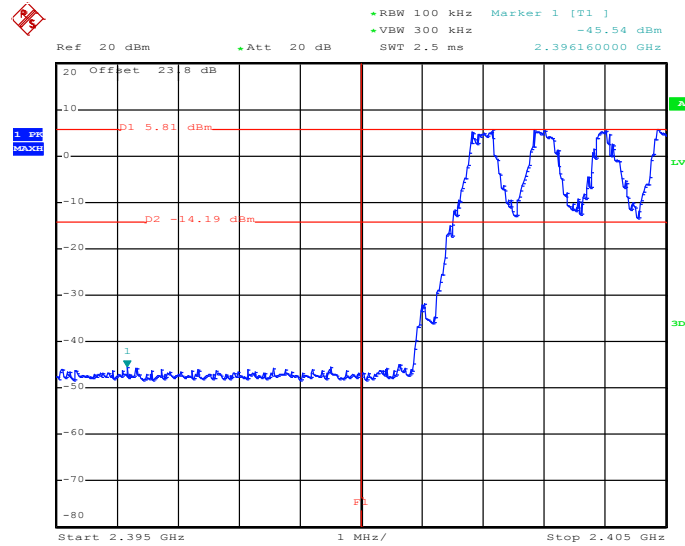

Date: 27.MAY.2017 18:48:42

1Mbps Hopping Mode High Band Edge Plot

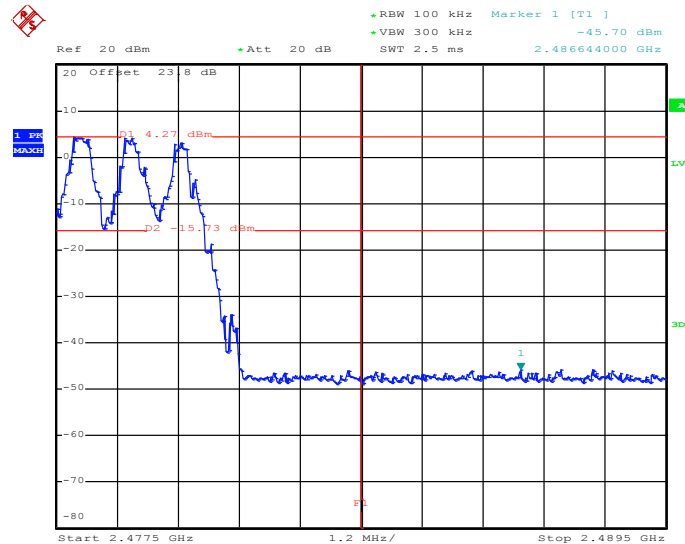

Date: 27.MAY.2017 18:47:10



Test Mode :	2Mbps	Temperature :	24~26°C
Test Engineer :	Kai Liao	Relative Humidity :	48~51%

2Mbps Hopping Mode Low Band Edge Plot

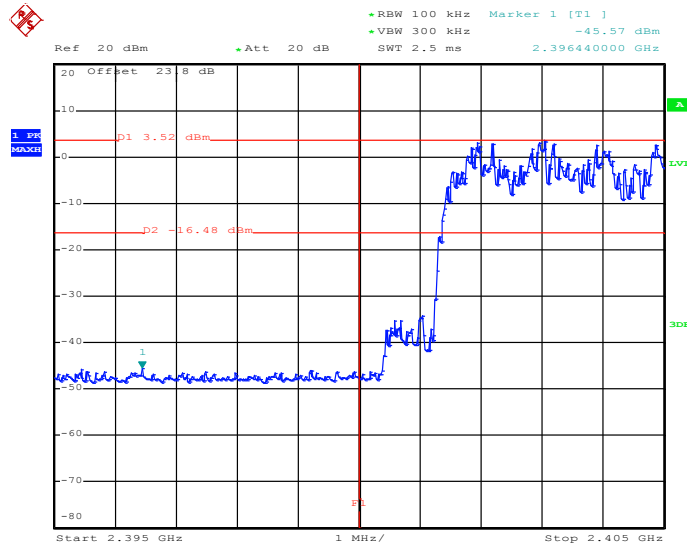

Date: 27.MAY.2017 18:50:18

2Mbps Hopping Mode High Band Edge Plot

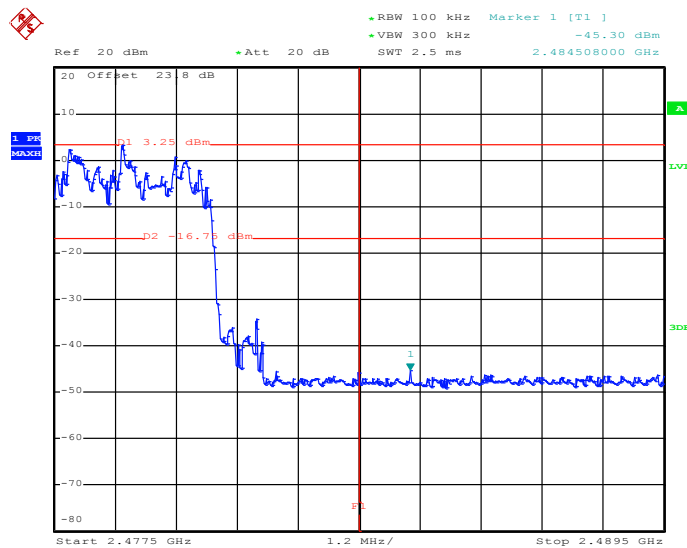

Date: 27.MAY.2017 18:50:54



Test Mode :	3Mbps	Temperature :	24~26°C
Test Engineer :	Kai Liao	Relative Humidity :	48~51%

3Mbps Hopping Mode Low Band Edge Plot

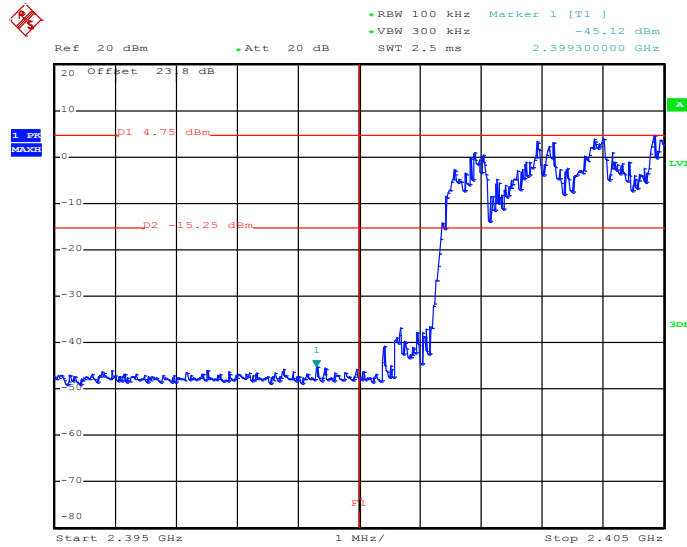

Date: 27.MAY.2017 18:52:16

3Mbps Hopping Mode High Band Edge Plot

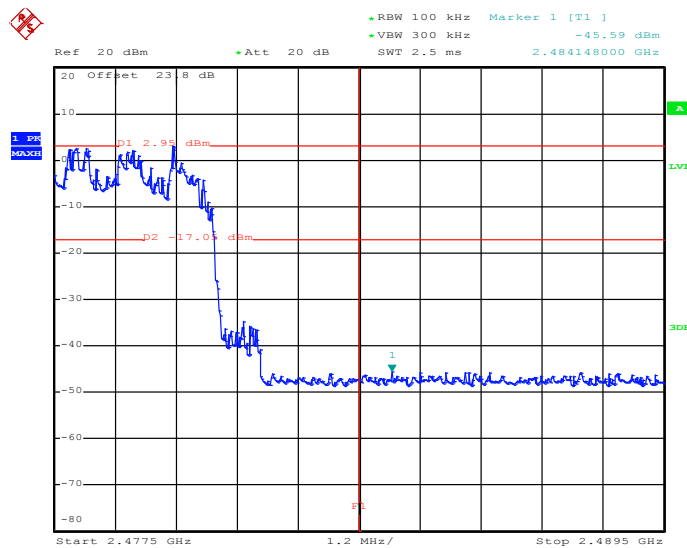

Date: 27.MAY.2017 18:53:03

3.7 Conducted Spurious Emission Measurement

3.7.1 Limit of Spurious Emission Measurement

In any 100 kHz bandwidth outside the intentional radiation frequency band, the radio frequency power shall be at least 20 dB below the highest level of the radiated power. In addition, radiated emissions which fall in the restricted bands must also comply with the radiated emission limits.

3.7.2 Measuring Instruments

The measuring equipment is listed in the section 4 of this test report.

3.7.3 Test Procedure

1. The testing follows ANSI C63.10-2013 clause 7.8.8.
2. The RF output of EUT was connected to the spectrum analyzer by RF cable and attenuator. The path loss was compensated to the results for each measurement.
3. Set to the maximum power setting and enable the EUT transmit continuously.
4. Set RBW = 100 kHz, VBW = 300kHz, scan up through 10th harmonic. All harmonics / spurs must be at least 20 dB down from the highest emission level within the authorized band as measured with a 100 kHz RBW.
5. Measure and record the results in the test report.
6. The RF fundamental frequency should be excluded against the limit line in the operating frequency band.

3.7.4 Test Setup

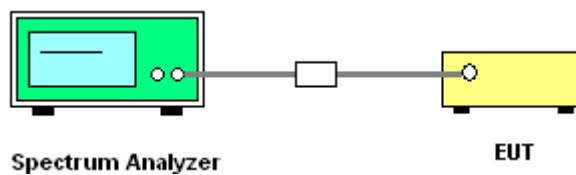



3.7.5 Test Result of Conducted Spurious Emission

Test Mode :	1Mbps	Temperature :	24~26°C
Test Channel :	00	Relative Humidity :	48~51%
		Test Engineer :	Kai Liao

1Mbps CSE Plot on Ch 00 between 30MHz ~ 3 GHz

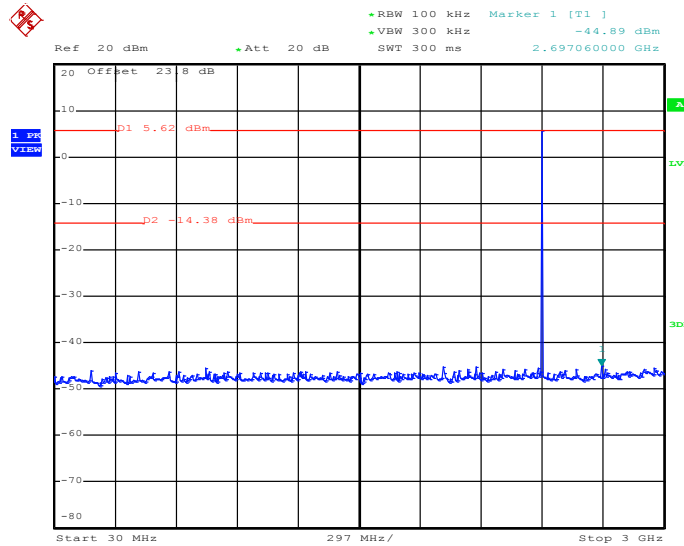

Date: 27.MAY.2017 19:01:34

1Mbps CSE Plot on Ch 00 between 2 GHz ~ 25 GHz

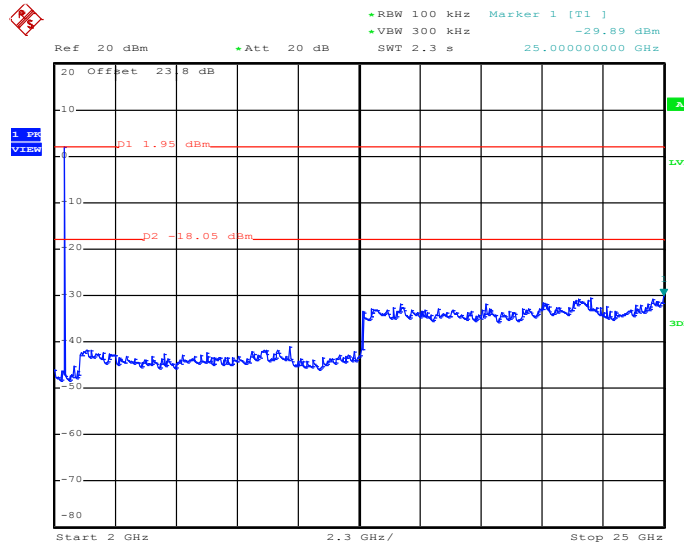

Date: 27.MAY.2017 19:01:55



Test Mode :	1Mbps	Temperature :	24~26°C
Test Channel :	39	Relative Humidity :	48~51%
		Test Engineer :	Kai Liao

1Mbps CSE Plot on Ch 39 between 30MHz ~ 3 GHz

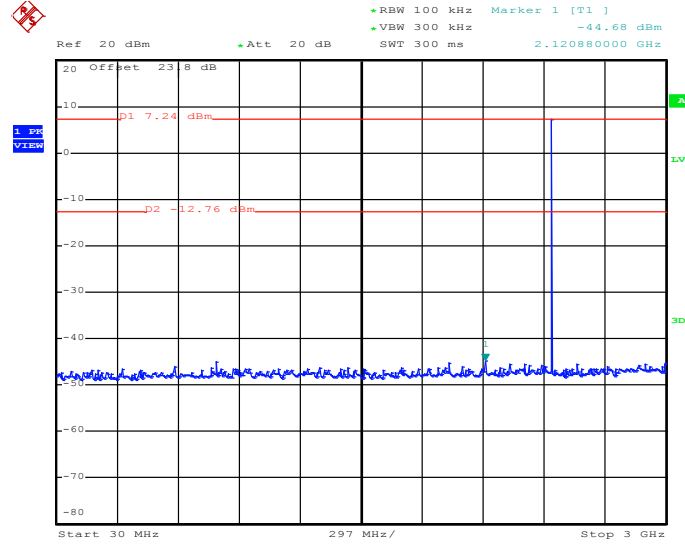

Date: 27.MAY.2017 19:11:00

1Mbps CSE Plot on Ch 39 between 2 GHz ~ 25 GHz

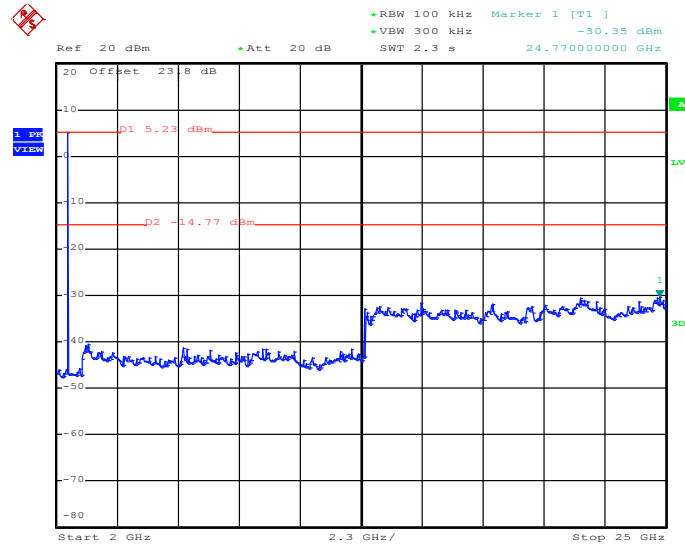

Date: 27.MAY.2017 19:11:22



Test Mode :	1Mbps	Temperature :	24~26°C
Test Channel :	78	Relative Humidity :	48~51%
		Test Engineer :	Kai Liao

1Mbps CSE Plot on Ch 78 between 30MHz ~ 3 GHz

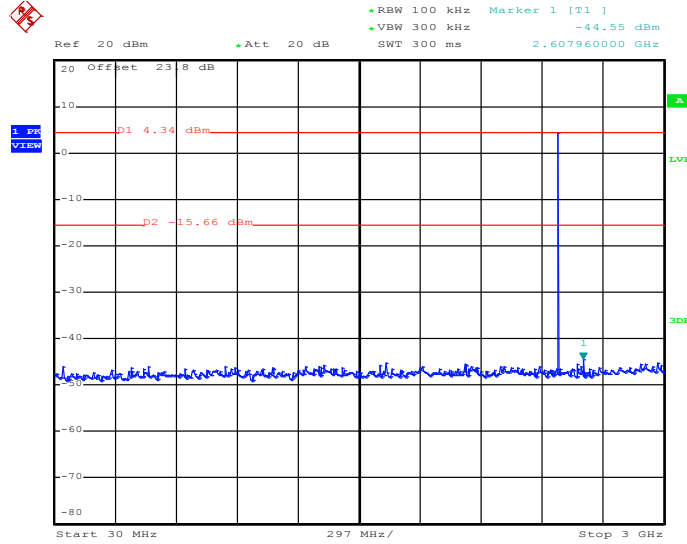

Date: 27.MAY.2017 19:20:37

1Mbps CSE Plot on Ch 78 between 2 GHz ~ 25 GHz

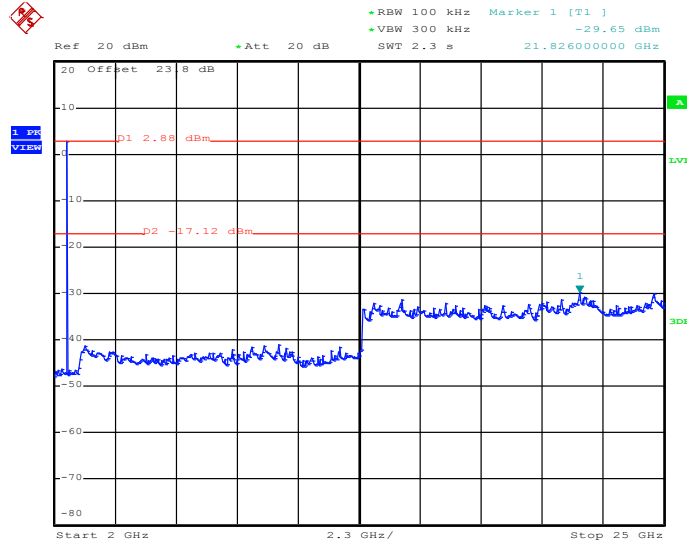

Date: 27.MAY.2017 19:20:59



Test Mode :	2Mbps	Temperature :	24~26°C
Test Channel :	00	Relative Humidity :	48~51%
		Test Engineer :	Kai Liao

2Mbps CSE Plot on Ch 00 between 30MHz ~ 3 GHz

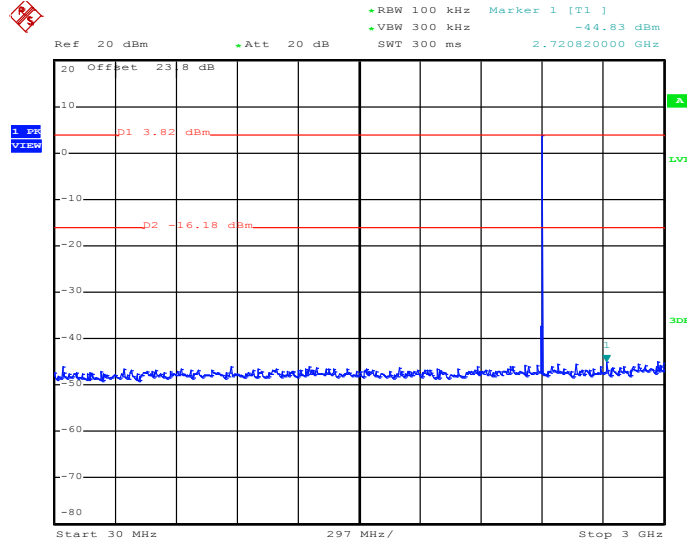

Date: 27.MAY.2017 19:29:58

2Mbps CSE Plot on Ch 00 between 2 GHz ~ 25 GHz

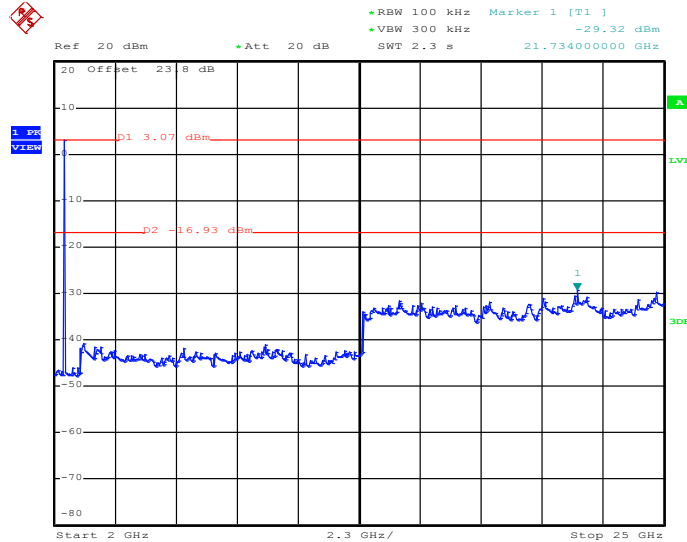

Date: 27.MAY.2017 19:30:20



Test Mode :	2Mbps	Temperature :	24~26°C
Test Channel :	39	Relative Humidity :	48~51%
		Test Engineer :	Kai Liao

2Mbps CSE Plot on Ch 39 between 30MHz ~ 3 GHz

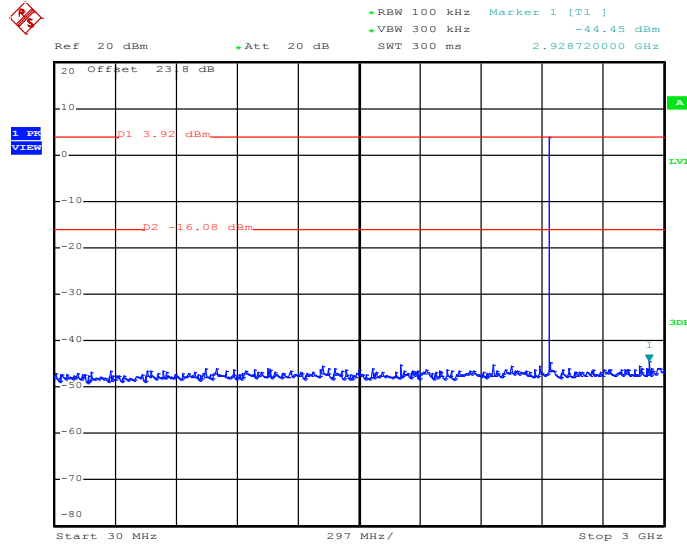

Date: 27.MAY.2017 19:36:06

2Mbps CSE Plot on Ch 39 between 2 GHz ~ 25 GHz

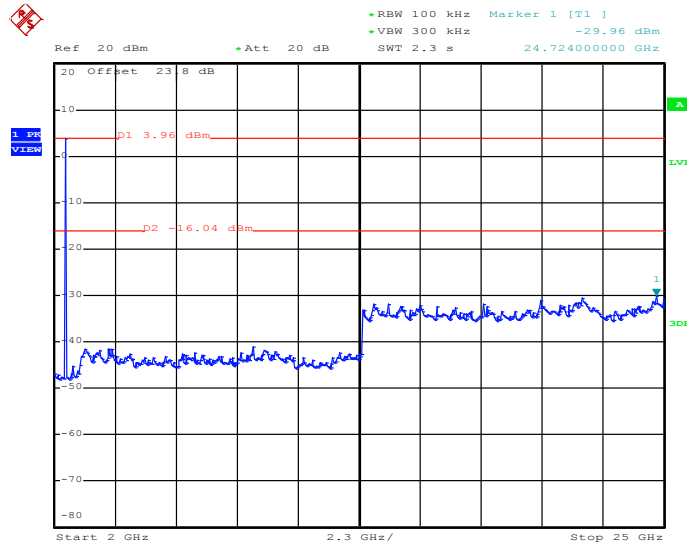

Date: 27.MAY.2017 19:36:27



Test Mode :	2Mbps	Temperature :	24~26°C
Test Channel :	78	Relative Humidity :	48~51%
		Test Engineer :	Kai Liao

2Mbps CSE Plot on Ch 78 between 30MHz ~ 3 GHz

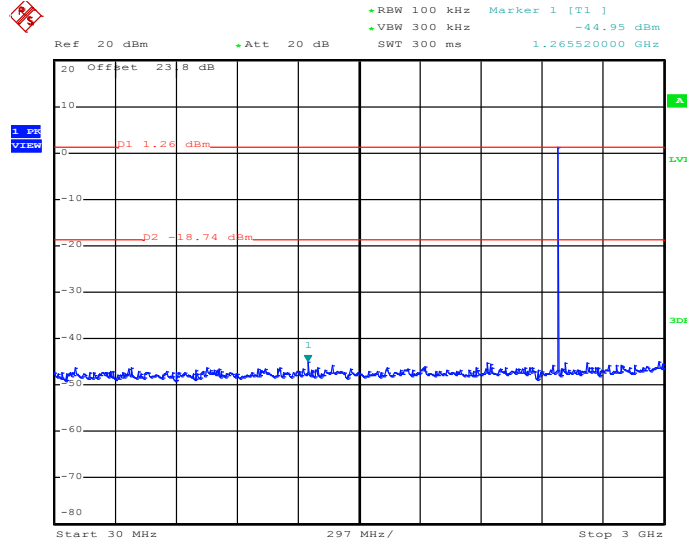

Date: 27.MAY.2017 20:08:10

2Mbps CSE Plot on Ch 78 between 2 GHz ~ 25 GHz

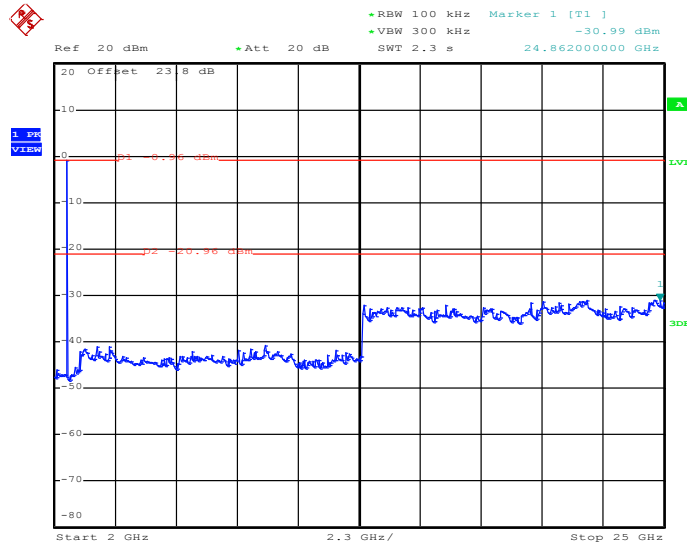

Date: 27.MAY.2017 20:08:31



Test Mode :	3Mbps	Temperature :	24~26°C
Test Channel :	00	Relative Humidity :	48~51%
		Test Engineer :	Kai Liao

3Mbps CSE Plot on Ch 00 between 30MHz ~ 3 GHz

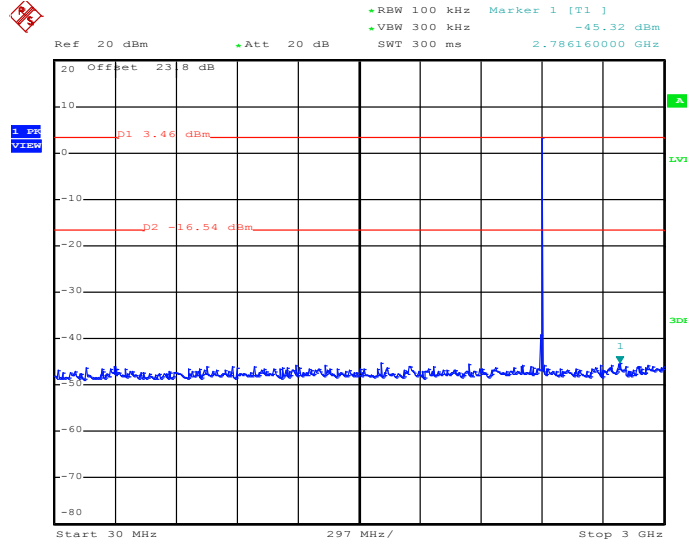

Date: 27.MAY.2017 20:17:45

3Mbps CSE Plot on Ch 00 between 2 GHz ~ 25 GHz

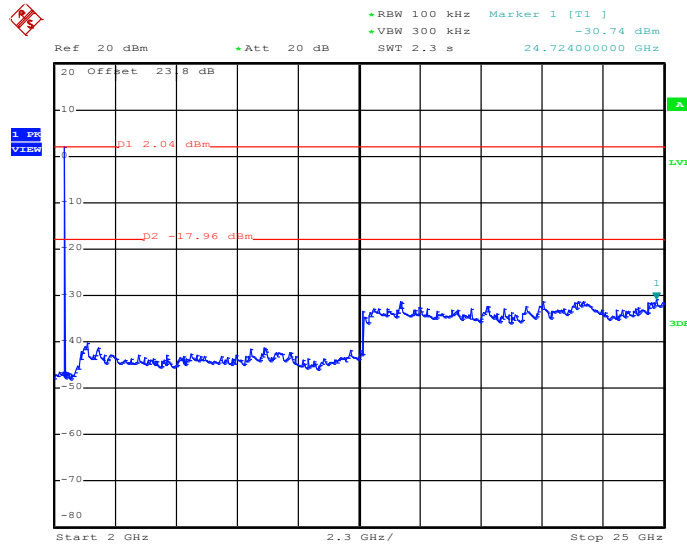

Date: 27.MAY.2017 20:18:07



Test Mode :	3Mbps	Temperature :	24~26°C
Test Channel :	39	Relative Humidity :	48~51%
		Test Engineer :	Kai Liao

3Mbps CSE Plot on Ch 39 between 30MHz ~ 3 GHz

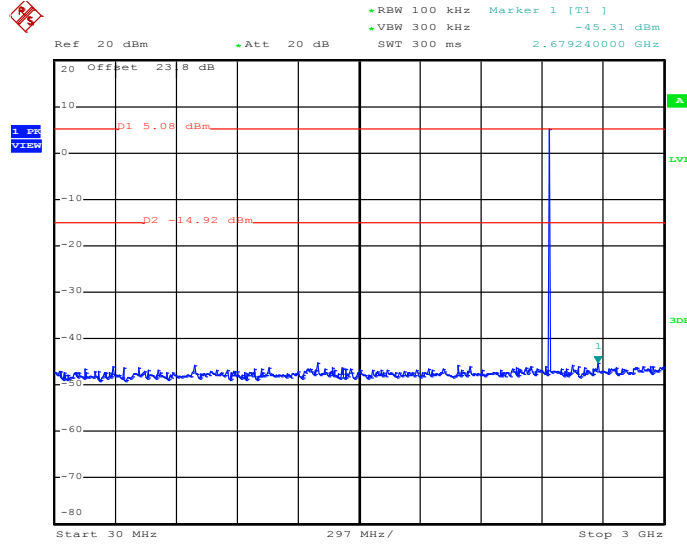

Date: 27.MAY.2017 20:22:50

3Mbps CSE Plot on Ch 39 between 2 GHz ~ 25 GHz

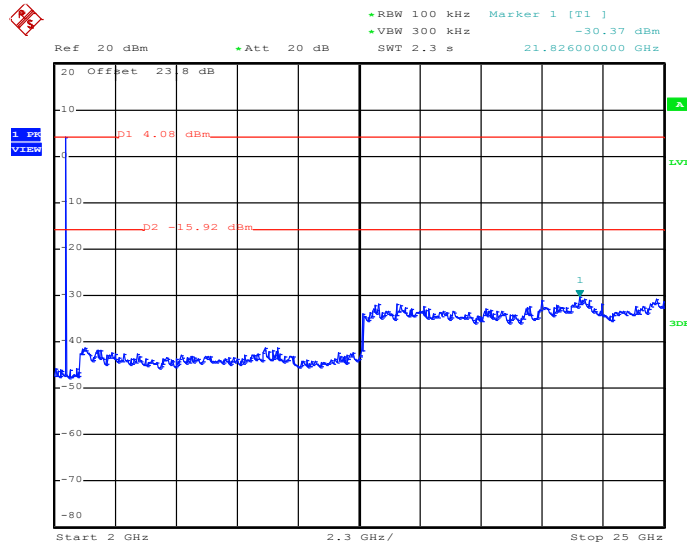

Date: 27.MAY.2017 20:23:12



Test Mode :	3Mbps	Temperature :	24~26°C
Test Channel :	78	Relative Humidity :	48~51%
		Test Engineer :	Kai Liao

3Mbps CSE Plot on Ch 78 between 30MHz ~ 3 GHz

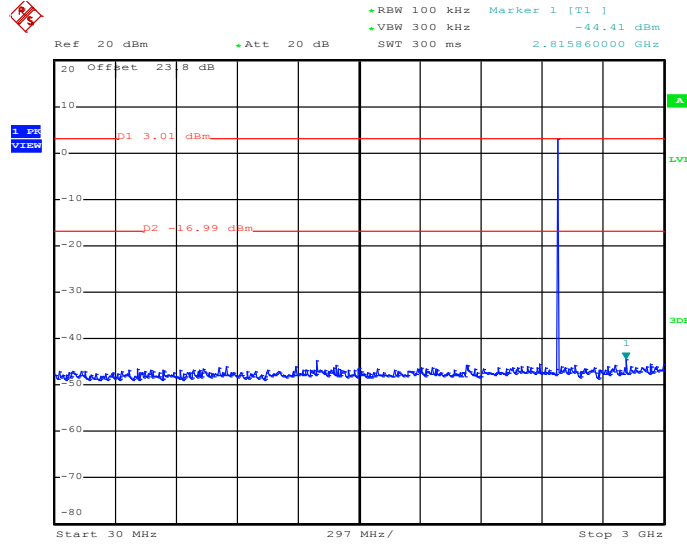

Date: 27.MAY.2017 20:29:23

3Mbps CSE Plot on Ch 78 between 2 GHz ~ 25 GHz

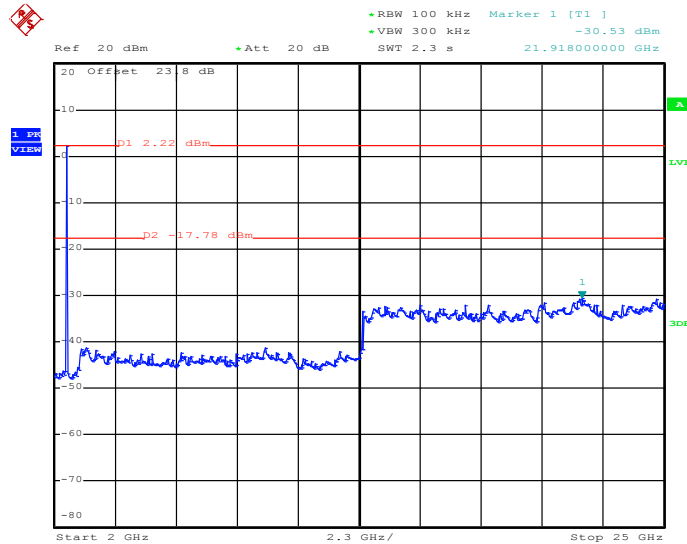

Date: 27.MAY.2017 20:29:45



3.8 Radiated Band Edges and Spurious Emission Measurement

3.8.1 Limit of Radiated Band Edges and Spurious Emission

In any 100 kHz bandwidth outside the intentional radiator frequency band, all harmonics/spurious must be at least 20 dB below the highest emission level within the authorized band. In addition, radiated emissions which fall in the restricted bands must also comply with the limits as below.

Frequency (MHz)	Field Strength (microvolts/meter)	Measurement Distance (meters)
0.009 – 0.490	2400/F(kHz)	300
0.490 – 1.705	24000/F(kHz)	30
1.705 – 30.0	30	30
30 – 88	100	3
88 – 216	150	3
216 - 960	200	3
Above 960	500	3

3.8.2 Measuring Instruments

The measuring equipment is listed in the section 4 of this test report.



3.8.3 Test Procedures

1. The EUT was placed on a turntable with 0.8 meter for frequency below 1GHz and 1.5 meter for frequency above 1GHz respectively above ground.
2. The EUT was set 3 meters from the interference receiving antenna, which was mounted on the top of a variable height antenna tower.
3. For each suspected emission, the EUT was arranged to its worst case and then tune the Antenna tower (from 1 m to 4 m) and turntable (from 0 degree to 360 degrees) to find the maximum reading. A pre-amp and a high pass filter are used for the test in order to get better signal level to comply with the guidelines.
4. Set to the maximum power setting and enable the EUT transmit continuously.
5. Use the following spectrum analyzer settings:
 - (1) Span shall wide enough to fully capture the emission being measured;
 - (2) Set RBW=100 kHz for $f < 1 \text{ GHz}$, RBW=1MHz for $f > 1\text{GHz}$; VBW \geq RBW; Sweep = auto; Detector function = peak; Trace = max hold for peak
 - (3) For average measurement: use duty cycle correction factor method per 15.35(c).
Duty cycle = On time/100 milliseconds
On time = $N_1 * L_1 + N_2 * L_2 + \dots + N_{n-1} * L_{n-1} + N_n * L_n$
Where N_1 is number of type 1 pulses, L_1 is length of type 1 pulses, etc.
Average Emission Level = Peak Emission Level + $20 * \log(\text{Duty cycle})$
6. Corrected Reading: Antenna Factor + Cable Loss + Read Level - Preamp Factor = Level.
7. For testing below 1GHz, if the emission level of the EUT in peak mode was 3 dB lower than the limit specified, then peak values of EUT will be reported, otherwise, the emissions will be repeated one by one using the CISPR quasi-peak method and reported.
8. For testing above 1GHz, the emission level of the EUT in peak mode was 20dB lower than average limit (that means the emission level in average mode also complies with the limit in average mode), then peak values of EUT will be reported, otherwise, the emissions will be measured in average mode again and reported.

Note: The average levels were calculated from the peak level corrected with duty cycle correction factor (24.82dB) derived from $20 \log(\text{dwell time}/100\text{ms})$. This correction is only for signals that hop with the fundamental signal, such as band-edge and harmonic. Other spurious signals that are independent of the hopping signal would not use this correction.

3.8.4 Test Setup

For radiated emissions below 30MHz

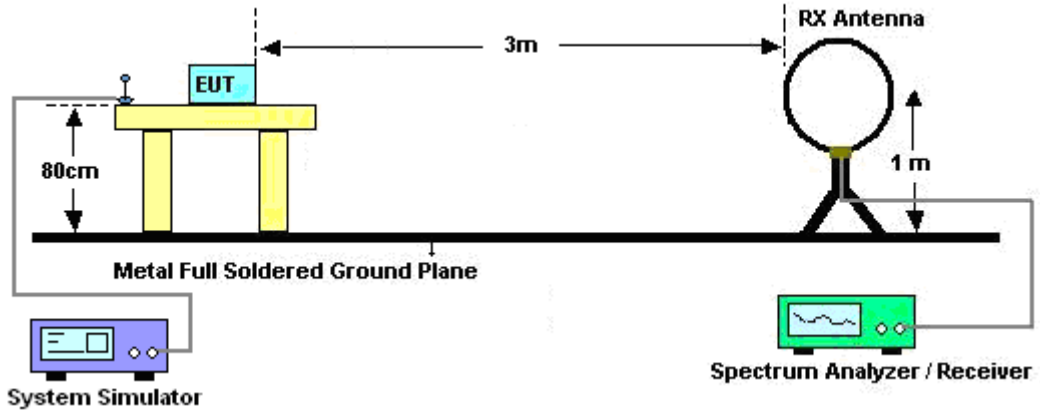

For radiated emissions from 30MHz to 1GHz

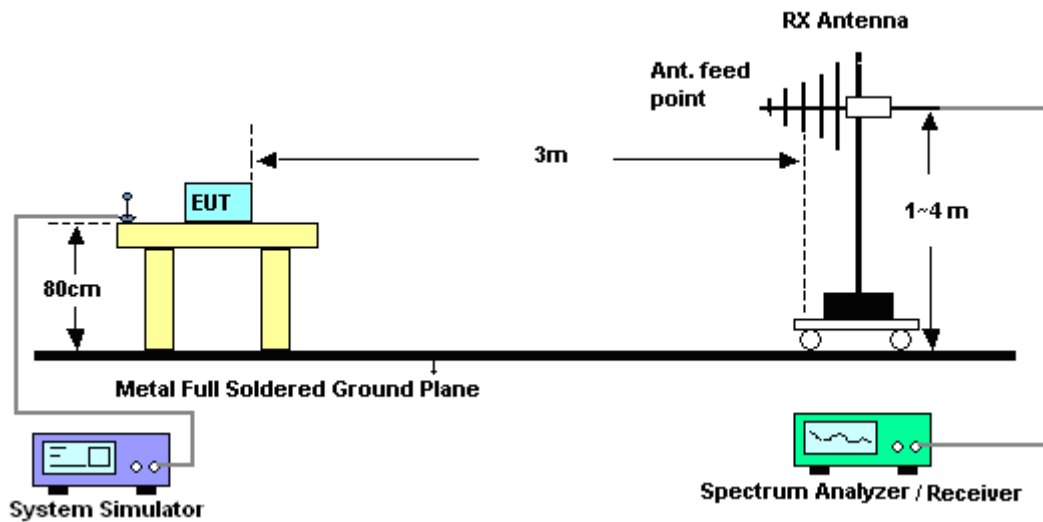

For radiated emissions above 1GHz

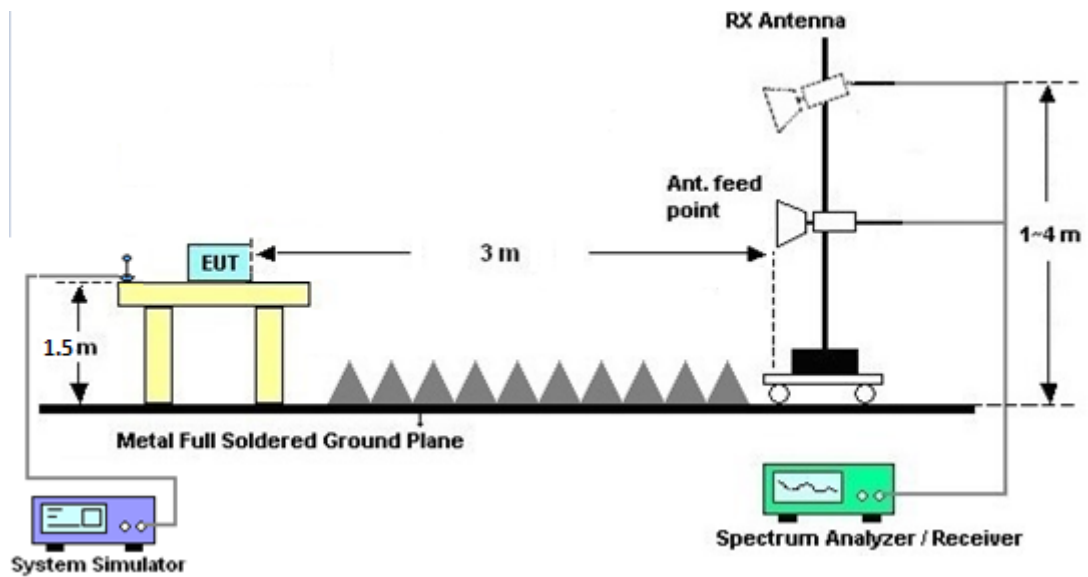

3.8.5 Test Results of Radiated Spurious Emissions (9 kHz ~ 30 MHz)

The low frequency, which started from 9 kHz to 30MHz, was pre-scanned and the result which was 20dB lower than the limit line was not reported.

There is a comparison data of both open-field test site and semi-Anechoic chamber, and the result came out very similar.



3.8.6 Duty cycle correction factor for average measurement

<1Mbps>

DH5 on time (One Pulse) Plot on Channel 39

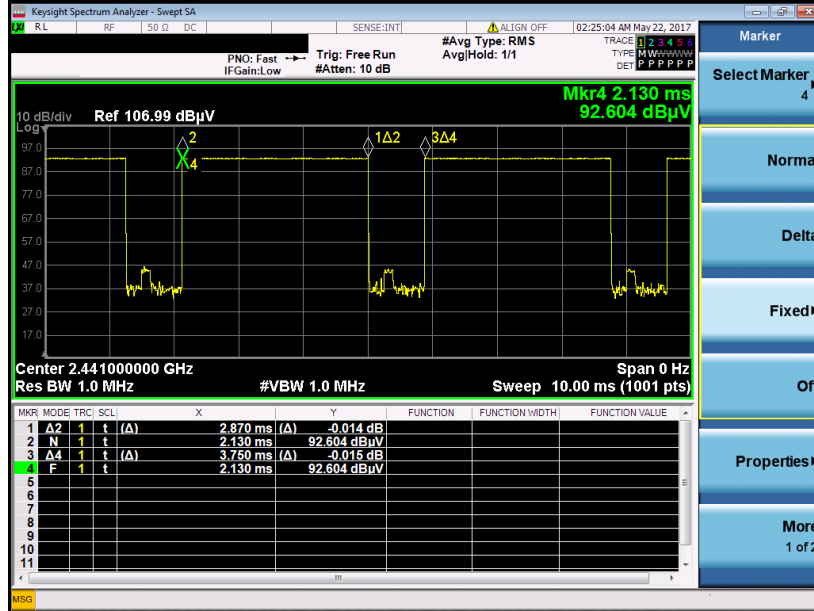

DH5 on time (Count Pulses) Plot on Channel 39

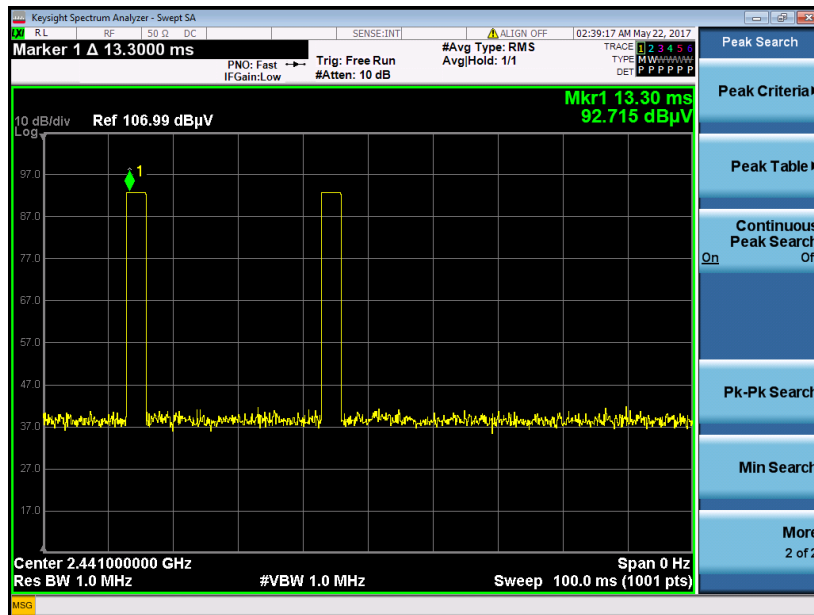

Note:

1. Worst case Duty cycle = on time/100 milliseconds = $2 * 2.87 / 100 = 5.74 \%$
2. Worst case Duty cycle correction factor = $20 * \log(\text{Duty cycle}) = -24.82 \text{ dB}$
3. DH5 has the highest duty cycle worst case and is reported



<2Mbps>

2DH5 on time (One Pulse) Plot on Channel 39

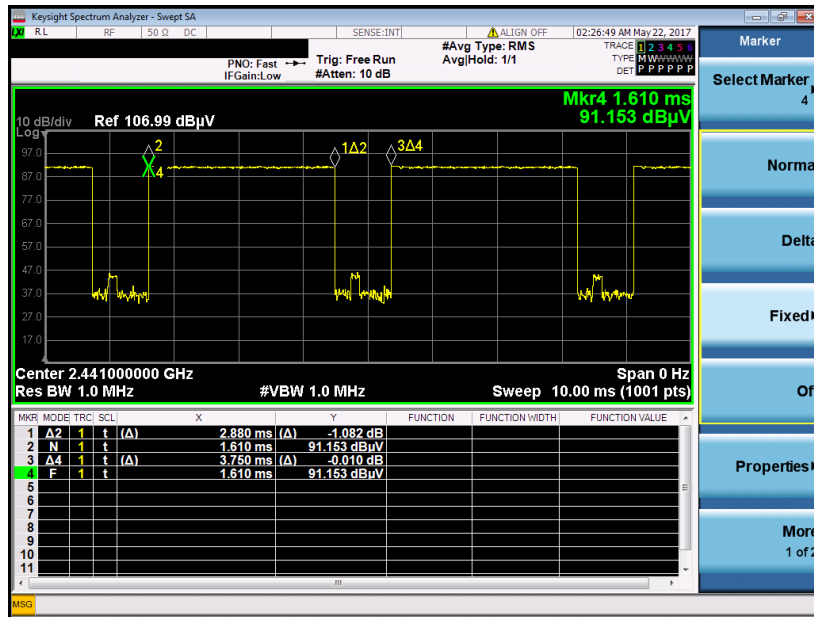

DH5 on time (Count Pulses) Plot on Channel 39

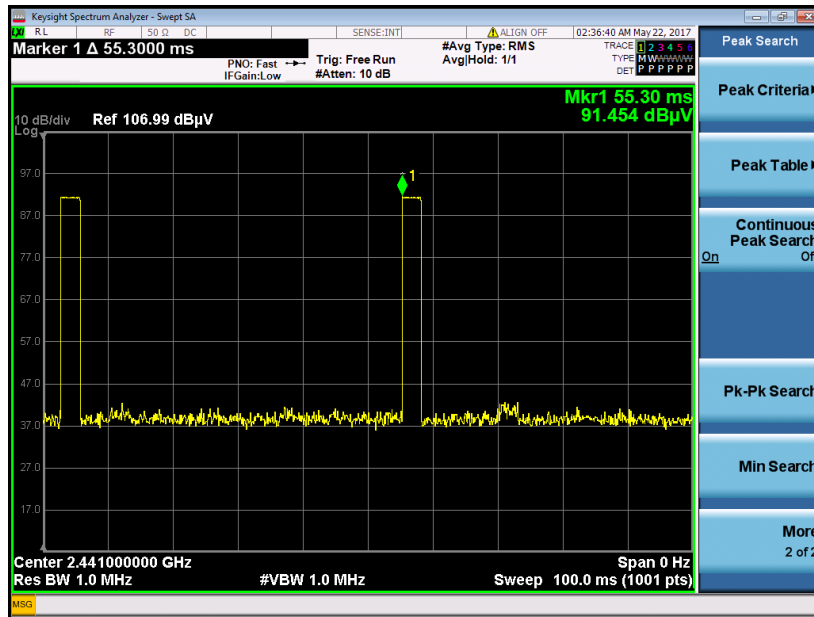



<3Mbps>

3DH5 on time (One Pulse) Plot on Channel 39

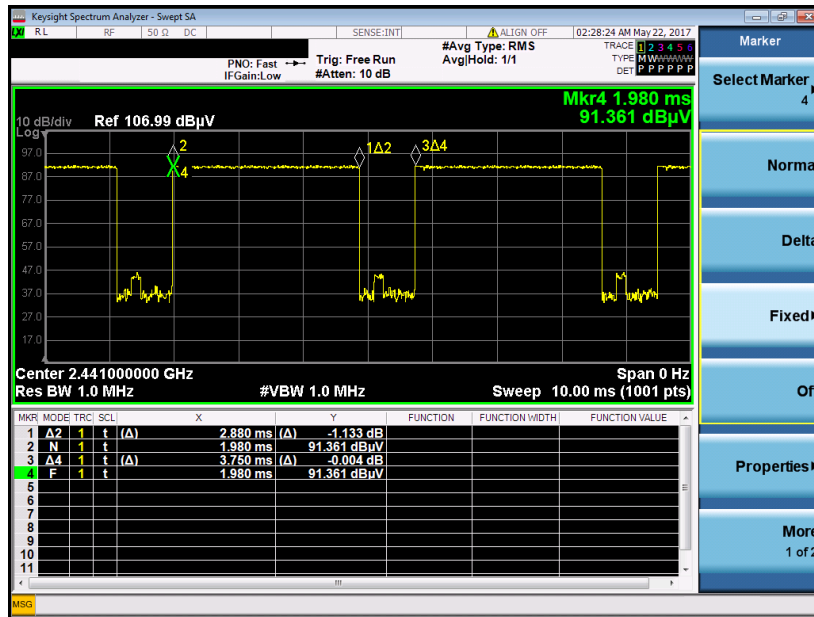

DH5 on time (Count Pulses) Plot on Channel 39

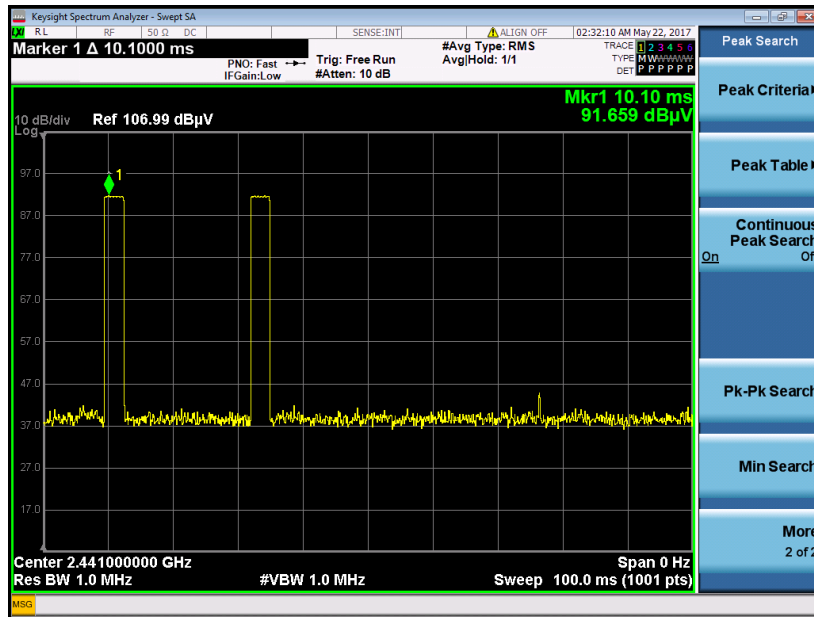



Duty Cycle Correction Factor Consideration for AFH mode:

Bluetooth normal hopping rate is 1600Hz and reduced to 800Hz in AFH mode; due to the reduced number of hopping frequencies, with the same packet configuration the dwell time in each channel frequency within 100msec period is longer in AFH mode than normal mode.

In AFH mode, the minimum hopping frequencies are 20, to get the longest dwell time DH5 packet is observed; the period to have DH5 packet completing one hopping sequence is

$$2.88 \text{ ms} \times 20 \text{ channels} = 57.6 \text{ ms}$$

There cannot be 2 complete hopping sequences within 100ms period, considering the random hopping behavior, maximum 2 hops can be possibly observed within the period. $[100\text{ms} / 57.6\text{ms}] = 2 \text{ hops}$

Thus, the maximum possible ON time:

$$2.88 \text{ ms} \times 2 = 5.76 \text{ ms}$$

Worst case Duty Cycle Correction factor, which is derived from the maximum possible ON time,

$$20 \times \log(5.76 \text{ ms}/100\text{ms}) = -24.79 \text{ dB}$$

3.8.7 Test Result of Radiated Spurious at Band Edges

Please refer to Appendix A and B.

3.8.8 Test Result of Radiated Spurious Emission (30MHz ~ 10th Harmonic)

Please refer to Appendix A and B.



3.9 AC Conducted Emission Measurement

3.9.1 Limit of AC Conducted Emission

For equipment that is designed to be connected to the public utility (AC) power line, the radio frequency voltage that is conducted back onto the AC power line on any frequency or frequencies within the band 150 kHz to 30 MHz shall not exceed the limits in the following table.

Frequency of emission (MHz)	Conducted limit (dBµV)	
	Quasi-peak	Average
0.15-0.5	66 to 56*	56 to 46*
0.5-5	56	46
5-30	60	50

*Decreases with the logarithm of the frequency.

3.9.2 Measuring Instruments

The measuring equipment is listed in the section 4 of this test report.

3.9.3 Test Procedures

1. The EUT was placed 0.4 meter from the conducting wall of the shielding room was kept at least 80 centimeters from any other grounded conducting surface.
2. Connect EUT to the power mains through a line impedance stabilization network (LISN).
3. All the support units are connecting to the other LISN.
4. The LISN provides 50 ohm coupling impedance for the measuring instrument.
5. The FCC states that a 50 ohm, 50 microhenry LISN should be used.
6. Both sides of AC line were checked for maximum conducted interference.
7. The frequency range from 150 kHz to 30 MHz was searched.
8. Set the test-receiver system to Peak Detect Function and specified bandwidth (IF Bandwidth = 9kHz) with Maximum Hold Mode. Then measurement is also conducted by Average Detector and Quasi-Peak Detector Function respectively.

3.9.4 Test Setup

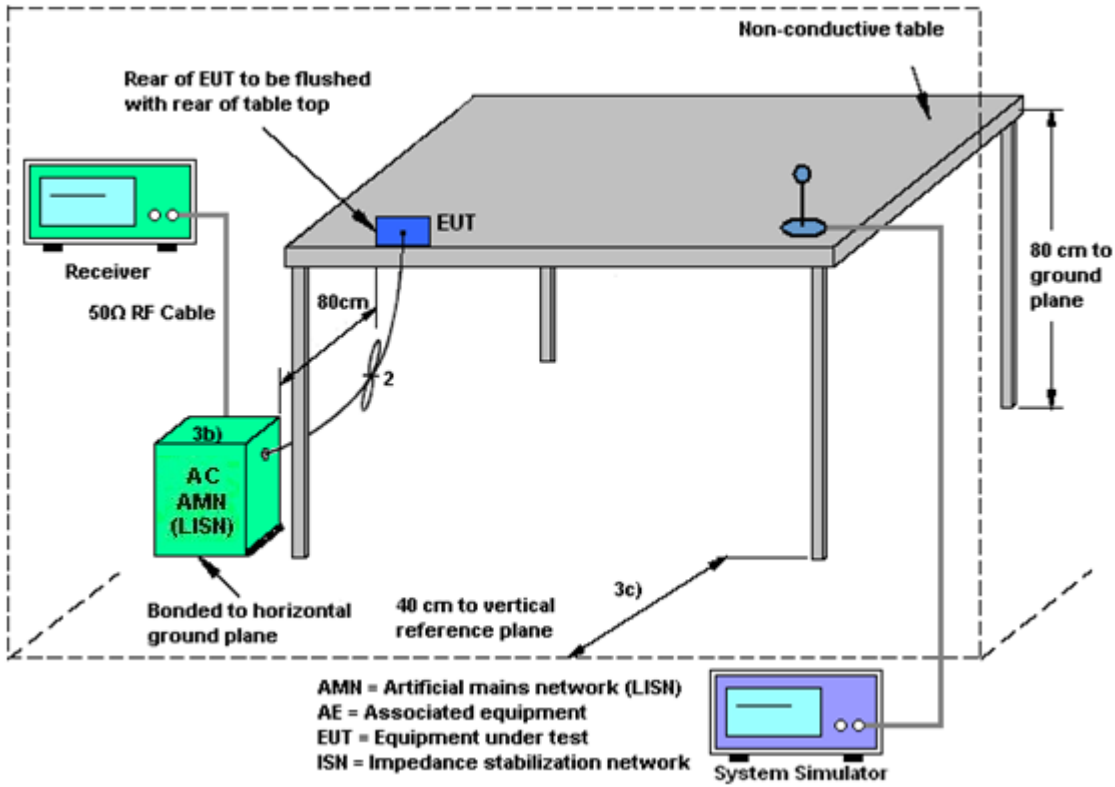

3.9.5 Test Result of AC Conducted Emission

Test Mode :	Mode 1	Temperature :	22~25°C
Test Engineer :	Arthur Hsieh	Relative Humidity :	51~55%
Test Voltage :	120Vac / 60Hz	Phase :	Line
Function Type :	GSM1900 Idle + Bluetooth Link + WLAN (2.4GHz) Link + MP3 + Earphone 1 + Battery + USB Cable (Charging from Adapter 1)		

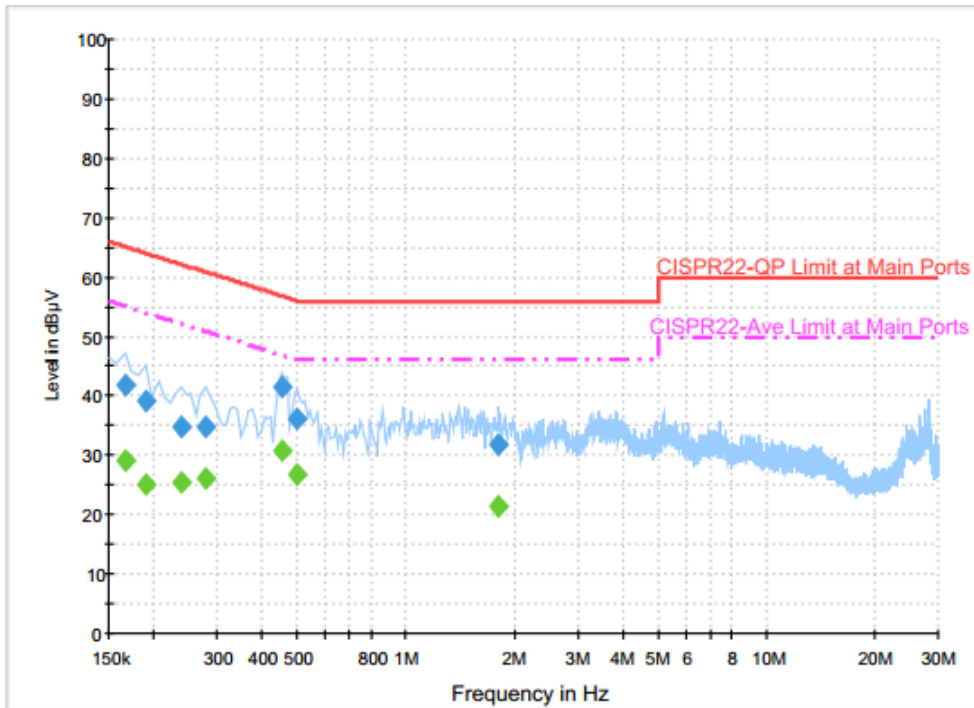

Final Result : Quasi-Peak

Frequency (MHz)	Quasi-Peak (dBµV)	Filter	Line	Corr. (dB)	Margin (dB)	Limit (dBµV)
0.166000	41.9	Off	L1	19.6	23.3	65.2
0.190000	39.2	Off	L1	19.6	24.8	64.0
0.238000	34.7	Off	L1	19.6	27.5	62.2
0.278000	34.9	Off	L1	19.6	26.0	60.9
0.454000	41.6	Off	L1	19.6	15.2	56.8
0.502000	36.1	Off	L1	19.6	19.9	56.0
1.814000	31.9	Off	L1	19.6	24.1	56.0

Final Result : Average

Frequency (MHz)	Average (dBµV)	Filter	Line	Corr. (dB)	Margin (dB)	Limit (dBµV)
0.166000	29.2	Off	L1	19.6	26.0	55.2
0.190000	25.0	Off	L1	19.6	29.0	54.0
0.238000	25.5	Off	L1	19.6	26.7	52.2
0.278000	26.0	Off	L1	19.6	24.9	50.9
0.454000	30.7	Off	L1	19.6	16.1	46.8
0.502000	26.7	Off	L1	19.6	19.3	46.0
1.814000	21.3	Off	L1	19.6	24.7	46.0



Test Mode :	Mode 1	Temperature :	22~25°C
Test Engineer :	Arthur Hsieh	Relative Humidity :	51~55%
Test Voltage :	120Vac / 60Hz	Phase :	Neutral
Function Type :	GSM1900 Idle + Bluetooth Link + WLAN (2.4GHz) Link + MP3 + Earphone 1 + Battery + USB Cable (Charging from Adapter 1)		

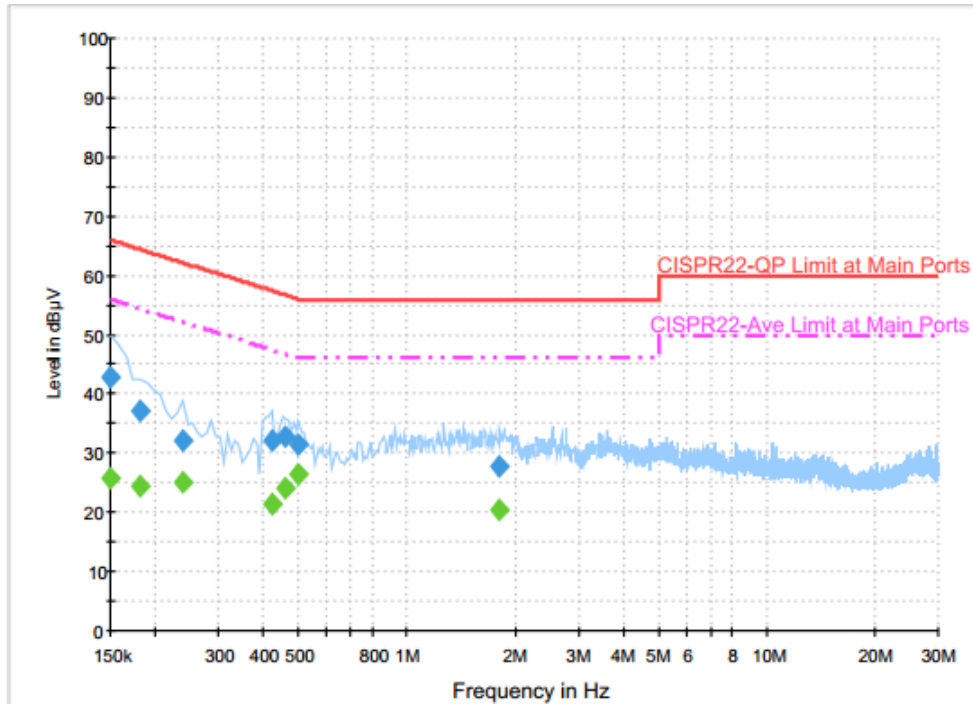

Final Result : Quasi-Peak

Frequency (MHz)	Quasi-Peak (dBµV)	Filter	Line	Corr. (dB)	Margin (dB)	Limit (dBµV)
0.150000	42.9	Off	N	19.5	23.1	66.0
0.182000	37.0	Off	N	19.5	27.4	64.4
0.238000	32.2	Off	N	19.5	30.0	62.2
0.422000	32.2	Off	N	19.5	25.2	57.4
0.462000	32.7	Off	N	19.5	24.0	56.7
0.502000	31.3	Off	N	19.5	24.7	56.0
1.814000	27.9	Off	N	19.6	28.1	56.0

Final Result : Average

Frequency (MHz)	Average (dBµV)	Filter	Line	Corr. (dB)	Margin (dB)	Limit (dBµV)
0.150000	25.8	Off	N	19.5	30.2	56.0
0.182000	24.6	Off	N	19.5	29.8	54.4
0.238000	25.0	Off	N	19.5	27.2	52.2
0.422000	21.6	Off	N	19.5	25.8	47.4
0.462000	24.1	Off	N	19.5	22.6	46.7
0.502000	26.5	Off	N	19.5	19.5	46.0
1.814000	20.4	Off	N	19.6	25.6	46.0



3.10 Antenna Requirements

3.10.1 Standard Applicable

If directional gain of transmitting antennas is greater than 6dBi, the power shall be reduced by the same level in dB comparing to gain minus 6dBi. The use of a permanently attached antenna or of an antenna that uses a unique coupling to the intentional radiator shall be considered sufficient to comply with the rule.

3.10.2 Antenna Anti-Replacement Construction

An embedded-in antenna design is used.

3.10.3 Antenna Gain

The antenna peak gain of EUT is less than 6 dBi. Therefore, it is not necessary to reduce maximum peak output power limit.



4 List of Measuring Equipment

Instrument	Manufacturer	Model No.	Serial No.	Characteristics	Calibration Date	Test Date	Due Date	Remark
Spectrum Analyzer	Rohde & Schwarz	FSP40	100055	9kHz-40GHz	Jul. 17, 2016	May 17. 2017~ May 27. 2017	Jul. 16, 2017	Conducted (TH05-HY)
Power Meter	Agilent	E4416A	GB4129234 4	300MHz~40GHz	Dec. 26, 2016	May 17. 2017~ May 27. 2017	Dec. 25, 2017	Conducted (TH05-HY)
Power Sensor	Agilent	E9327A	US40441548	300MHz~40GHz	Dec. 26, 2016	May 17. 2017~ May 27. 2017	Dec. 25, 2017	Conducted (TH05-HY)
Hygrometer	Testo	608-H2	41410069	N/A	Aug. 28, 2016	May 17. 2017~ May 27. 2017	Aug. 27, 2017	Conducted (TH05-HY)
RF Cable	HUBER + SUHNER	SUCOFLEX 104	MY8420952 1	1GHz~26GHz	Dec. 02, 2016	May 17. 2017~ May 27. 2017	Dec. 01, 2017	Conducted (TH05-HY)
AC Power Source	ChainTek	APC-1000W	N/A	N/A	N/A	May 14, 2017	N/A	Conduction (CO05-HY)
EMI Test Receiver	Rohde & Schwarz	ESCI 7	100724	9kHz~7GHz	Aug. 30, 2016	May 14, 2017	Aug. 29, 2017	Conduction (CO05-HY)
Hygrometer	Testo	608-H1	34913912	N/A	May 02, 2017	May 14, 2017	May 01, 2018	Conduction (CO05-HY)
LISN	Rohde & Schwarz	ENV216	100080	9kHz~30MHz	Nov. 29, 2016	May 14, 2017	Nov. 28, 2017	Conduction (CO05-HY)
LF Cable	HUBER + SUHNER	RG-214/U	LF01	N/A	Jan. 05, 2017	May 14, 2017	Jan. 04, 2018	Conduction (CO05-HY)
Test Software	N/A	EMC32	8.40.0	N/A	N/A	May 14, 2017	N/A	Conduction (CO05-HY)
Loop Antenna	Rohde & Schwarz	HFH2-Z2	100315	9 kHz~30 MHz	May 15, 2017	May 19, 2017~ May 31, 2017	May 14, 2019	Radiation (03CH13-HY)
Bilog Antenna	TESEQ	CBL 6111D&008 00N1D01N- 06	40103&04	30MHz to 1GHz	Jan. 07, 2017	May 19, 2017~ May 31, 2017	Jan. 06, 2018	Radiation (03CH13-HY)
Horn Antenna	SCHWARZBE CK	BBHA 9120 D	9120D-1522	1GHz ~ 18GHz	May 17, 2017	May 19, 2017~ May 31, 2017	May 16, 2018	Radiation (03CH13-HY)
SHF-EHF Horn Antenna	SCHWARZBE CK	BBHA 9170	BBHA91705 84	18GHz- 40GHz	Nov. 08, 2016	May 19, 2017~ May 31, 2017	Nov. 07, 2017	Radiation (03CH13-HY)
Spectrum Analyzer	Keysight	N9010A	MY5537052 6	N/A	Mar. 15, 2017	May 19, 2017~ May 31, 2017	Mar. 14, 2018	Radiation (03CH13-HY)
Amplifier	Sonoma-Instru ment	310 N	187282	9KHz~1GHz	Dec. 21, 2016	May 19, 2017~ May 31, 2017	Dec. 20, 2017	Radiation (03CH13-HY)
Preamplifier	MITEQ	JS44-18004 000-33-8P	1840917	18GHz ~ 40GHz	Jun. 14, 2016	May 19, 2017~ May 31, 2017	Jun. 13, 2017	Radiation (03CH13-HY)
Preamplifier	MITEQ	AMF-7D-00 101800-30- 10P	1590074	1GHz~18GHz	Jun. 27, 2016	May 19, 2017~ May 31, 2017	Jun. 26, 2017	Radiation (03CH13-HY)
Preamplifier	Keysight	83017A	MY5327014 7	1GHz~26.5GHz	Jan. 09, 2017	May 19, 2017~ May 31, 2017	Jan. 08, 2018	Radiation (03CH13-HY)



Instrument	Manufacturer	Model No.	Serial No.	Characteristics	Calibration Date	Test Date	Due Date	Remark
Hygrometer	TECPEL	DTM-303B	TP140349	N/A	Nov. 14, 2016	May 19, 2017~ May 31, 2017	Nov. 13, 2017	Radiation (03CH13-HY)
RF Cable	HUBER + SUHNER	SUCOFLEX 104	MY335041/4 MY9840/4 MY9838/4	26G~40GHz	Mar. 27, 2017	May 19, 2017~ May 31, 2017	Mar. 26, 2018	Radiation (03CH13-HY)
RF Cable	HUBER + SUHNER	SUCOFLEX 104	MY335041/4 MY9840/4 MY9838/4	1G~26GHz	Jan. 27, 2017	May 19, 2017~ May 31, 2017	Jan. 26, 2017	Radiation (03CH13-HY)
RF Cable	HUBER + SUHNER	SUCOFLEX 104	MY335041/4 MY9840/4 MY9838/4	30M~1GHz	Jan. 27, 2017	May 19, 2017~ May 31, 2017	Jan. 26, 2018	Radiation (03CH13-HY)
RF Cable	HUBER + SUHNER	SUCOFLEX 104	MY24958/4, MY28653/4, MY9839/4P E	9K~30MHz	Jan. 10, 2017	May 19, 2017~ May 31, 2017	Jan. 09, 2018	Radiation (03CH13-HY)
Controller	EMEC	EM1000	N/A	Control Turn table & Ant Mast	N/A	May 19, 2017~ May 31, 2017	N/A	Radiation (03CH13-HY)
Antenna Mast	EMEC	AM-BS-450 0-B	N/A	1m~4m	N/A	May 19, 2017~ May 31, 2017	N/A	Radiation (03CH13-HY)
Turn Table	EMEC	TT2000	N/A	0~360 Degree	N/A	May 19, 2017~ May 31, 2017	N/A	Radiation (03CH13-HY)
Test Software	Audix	E3	6.2009-8-24 c	N/A	N/A	May 19, 2017~ May 31, 2017	N/A	Radiation (03CH13-HY)
Filter	Wainwright	WLKS1200- 12SS	SN2	1.2G Low Pass	Sep. 19, 2016	May 19, 2017~ May 31, 2017	Sep. 18, 2017	Radiation (03CH13-HY)
Filter	Wainwright	WHKX12-27 00-3000-18 000-60SS	SN2	3G High Pass	Sep. 20, 2016	May 19, 2017~ May 31, 2017	Sep. 19, 2017	Radiation (03CH13-HY)



5 Uncertainty of Evaluation

Uncertainty of Conducted Emission Measurement (150 kHz ~ 30 MHz)

Measuring Uncertainty for a Level of Confidence of 95% ($U = 2Uc(y)$)	2.70
---	------

Uncertainty of Radiated Emission Measurement (30 MHz ~ 1000 MHz)

Measuring Uncertainty for a Level of Confidence of 95% ($U = 2Uc(y)$)	4.90
---	------

Uncertainty of Radiated Emission Measurement (1000 MHz ~ 18000 MHz)

Measuring Uncertainty for a Level of Confidence of 95% ($U = 2Uc(y)$)	5.40
---	------

Uncertainty of Radiated Emission Measurement (18000 MHz ~ 40000 MHz)

Measuring Uncertainty for a Level of Confidence of 95% ($U = 2Uc(y)$)	4.30
---	------



Appendix A. Radiated Spurious Emission

Test Engineer :	Alex Jheng, Bill Chang, and Wilson Wu	Temperature :	24.5~24.6°C
		Relative Humidity :	55~57%

2.4GHz 2400~2483.5MHz

BT (1M) (Band Edge @ 3m)

BT	Note	Frequency (MHz)	Level (dBμV/m)	Over Limit (dB)	Limit Line (dBμV/m)	Read Level (dBμV)	Antenna Factor (dB/m)	Cable Loss (dB)	Preamp Factor (dB)	Ant Pos (cm)	Table Pos (deg)	Peak Avg. (P/A)	Pol. (H/V)	
BT CH00 2402MHz		2375.73	42.41	-31.59	74	41.26	27.31	4.83	30.99	377	78	P	H	
		2375.73	17.59	-36.41	54	-	-	-	-	-	-	A	H	
	*	2402	97.29	-	-	96.06	27.37	4.85	30.99	377	78	P	H	
	*	2402	72.47	-	-	-	-	-	-	-	-	A	H	
													H	
														H
			2358.405	42.52	-31.48	74	41.46	27.26	4.8	31	390	341	P	V
			2358.405	17.7	-36.3	54	-	-	-	-	-	-	A	V
	*	2402	94.23	-	-	93	27.37	4.85	30.99	390	341	P	V	
	*	2402	69.41	-	-	-	-	-	-	-	-	-	A	V
														V
														V
BT CH 39 2441MHz		2388.12	41.59	-32.41	74	40.38	27.37	4.83	30.99	400	85	P	H	
		2388.12	16.77	-37.23	54	-	-	-	-	-	-	A	H	
	*	2441	100.12	-	-	98.68	27.53	4.88	30.97	400	85	P	H	
	*	2441	75.3	-	-	-	-	-	-	-	-	A	H	
			2492.65	42.34	-31.66	74	40.67	27.7	4.93	30.96	400	85	P	H
			2492.65	17.52	-36.48	54	-	-	-	-	-	-	A	H
			2389.66	41.86	-32.14	74	40.65	27.37	4.83	30.99	374	338	P	V
			2389.66	17.04	-36.96	54	-	-	-	-	-	-	A	V
	*	2441	96.4	-	-	94.96	27.53	4.88	30.97	374	338	P	V	
	*	2441	71.58	-	-	-	-	-	-	-	-	-	A	V
			2485.58	42.98	-31.02	74	41.38	27.64	4.93	30.97	374	338	P	V
			2485.58	18.16	-35.84	54	-	-	-	-	-	-	A	V



BT CH 78 2480MHz	*	2480	97.67	-	-	96.08	27.64	4.92	30.97	392	74	P	H
	*	2480	72.85	-	-	-	-	-	-	-	-	A	H
		2490.72	42.59	-31.41	74	40.92	27.7	4.93	30.96	392	74	P	H
		2490.72	17.77	-36.23	54	-	-	-	-	-	-	A	H
													H
													H
	*	2480	93.97	-	-	92.38	27.64	4.92	30.97	400	360	P	V
	*	2480	69.15	-	-	-	-	-	-	-	-	A	V
		2497.2	42.89	-31.11	74	41.22	27.7	4.93	30.96	400	360	P	V
		2497.2	18.07	-35.93	54	-	-	-	-	-	-	A	V
													V
													V
Remark	<ol style="list-style-type: none"> 1. No other spurious found. 2. All results are PASS against Peak and Average limit line. 												



2.4GHz 2400~2483.5MHz

BT (1M) (Harmonic @ 3m)

BT	Note	Frequency (MHz)	Level (dBμV/m)	Over Limit (dB)	Limit Line (dBμV/m)	Read Level (dBμV)	Antenna Factor (dB/m)	Cable Loss (dB)	Preamp Factor (dB)	Ant Pos (cm)	Table Pos (deg)	Peak Avg. (P/A)	Pol. (H/V)	
BT CH 00 2402MHz		4804	40.22	-33.78	74	65.04	31.76	7.65	64.75	100	0	P	H	
		4804	15.4	-38.6	54	-	-	-	-	-	-	A	H	
													H	
													H	
		4804	39.98	-34.02	74	64.8	31.76	7.65	64.75	100	0	P	V	
		4804	15.16	-38.84	54	-	-	-	-	-	-	-	A	V
														V
														V
BT CH 39 2441MHz		4882	42.55	-31.45	74	67.05	31.88	7.82	64.7	100	0	P	H	
		4882	17.73	-36.27	54	-	-	-	-	-	-	A	H	
		7323	45.63	-28.37	74	63.1	37.22	9.68	64.83	100	0	P	H	
		7323	20.81	-33.19	54	-	-	-	-	-	-	A	H	
		4882	41.02	-32.98	74	65.52	31.88	7.82	64.7	100	0	P	V	
		4882	16.2	-37.8	54	-	-	-	-	-	-	A	V	
		7323	45.85	-28.15	74	63.32	37.22	9.68	64.83	100	0	P	V	
		7323	21.03	-32.97	54	-	-	-	-	-	-	A	V	
BT CH 78 2480MHz		4960	41.05	-32.95	74	65.17	32.04	7.98	64.63	100	0	P	H	
		4960	16.23	-37.77	54	-	-	-	-	-	-	A	H	
		7440	46.56	-27.44	74	63.65	37.56	9.77	64.88	100	0	P	H	
		7440	21.74	-32.26	54	-	-	-	-	-	-	A	H	
		4960	39.71	-34.29	74	63.83	32.04	7.98	64.63	100	0	P	V	
		4960	14.89	-39.11	54	-	-	-	-	-	-	A	V	
		7440	45.07	-28.93	74	62.16	37.56	9.77	64.88	100	0	P	V	
		7440	20.25	-33.75	54	-	-	-	-	-	-	A	V	
Remark	1. No other spurious found. 2. All results are PASS against Peak and Average limit line.													



2.4GHz 2400~2483.5MHz

BT (2M) (Band Edge @ 3m)

BT	Note	Frequency	Level	Over	Limit	Read	Antenna	Cable	Preamp	Ant	Table	Peak	Pol.	
		(MHz)	(dBμV/m)	(dB)	(dBμV/m)	(dBμV)	(dB/m)	(dB)	(dB)	(cm)	(deg)	(P/A)	(H/V)	
BT CH00 2402MHz		2380.455	43	-31	74	41.85	27.31	4.83	30.99	378	71	P	H	
		2380.455	18.21	-35.79	54	-	-	-	-	-	-	A	H	
	*	2402	96.51	-	-	95.28	27.37	4.85	30.99	378	71	P	H	
	*	2402	71.72	-	-	-	-	-	-	-	-	A	H	
													H	
														H
			2358.51	42.52	-31.48	74	41.46	27.26	4.8	31	380	338	P	V
			2358.51	17.73	-36.27	54	-	-	-	-	-	-	A	V
	*	2402	92.8	-	-	-	91.57	27.37	4.85	30.99	380	338	P	V
	*	2402	68.01	-	-	-	-	-	-	-	-	-	A	V
														V
	BT CH 39 2441MHz		2388.54	42.6	-31.4	74	41.39	27.37	4.83	30.99	400	85	P	H
		2388.54	17.81	-36.19	54	-	-	-	-	-	-	A	H	
*		2441	99.35	-	-	97.91	27.53	4.88	30.97	400	85	P	H	
*		2441	74.56	-	-	-	-	-	-	-	-	A	H	
			2495.87	42.52	-31.48	74	40.85	27.7	4.93	30.96	400	85	P	H
			2495.87	17.73	-36.27	54	-	-	-	-	-	-	A	H
			2375.8	42.08	-31.92	74	40.93	27.31	4.83	30.99	376	337	P	V
			2375.8	17.29	-36.71	54	-	-	-	-	-	-	A	V
*		2441	95.78	-	-	-	94.34	27.53	4.88	30.97	376	337	P	V
*		2441	70.99	-	-	-	-	-	-	-	-	-	A	V
			2483.76	42.44	-31.56	74	40.84	27.64	4.93	30.97	376	337	P	V
			2483.76	17.65	-36.35	54	-	-	-	-	-	-	A	V



BT CH 78 2480MHz	*	2480	96.65	-	-	95.06	27.64	4.92	30.97	394	76	P	H
	*	2480	71.86	-	-	-	-	-	-	-	-	A	H
		2484.24	43.33	-30.67	74	41.73	27.64	4.93	30.97	394	76	P	H
		2484.24	18.54	-35.46	54	-	-	-	-	-	-	A	H
													H
													H
	*	2480	92.91	-	-	91.32	27.64	4.92	30.97	400	360	P	V
	*	2480	68.12	-	-	-	-	-	-	-	-	A	V
		2499.32	42.57	-31.43	74	40.9	27.7	4.93	30.96	400	360	P	V
		2499.32	17.78	-36.22	54	-	-	-	-	-	-	A	V
													V
													V
Remark	<ol style="list-style-type: none"> 1. No other spurious found. 2. All results are PASS against Peak and Average limit line. 												



2.4GHz 2400~2483.5MHz

BT (2M) (Harmonic @ 3m)

BT	Note	Frequency (MHz)	Level (dBμV/m)	Over Limit (dB)	Limit Line (dBμV/m)	Read Level (dBμV)	Antenna Factor (dB/m)	Cable Loss (dB)	Preamp Factor (dB)	Ant Pos (cm)	Table Pos (deg)	Peak Avg. (P/A)	Pol. (H/V)
BT CH 00 2402MHz		4804	38.2	-35.8	74	63.02	31.76	7.65	64.75	100	0	P	H
		4804	13.41	-40.59	54	-	-	-	-	-	-	A	H
													H
													H
		4804	38.2	-35.8	74	63.02	31.76	7.65	64.75	100	0	P	V
		4804	13.41	-40.59	54	-	-	-	-	-	-	A	V
													V
													V
BT CH 39 2441MHz		4882	39.81	-34.19	74	64.31	31.88	7.82	64.7	100	0	P	H
		4882	15.02	-38.98	54	-	-	-	-	-	-	A	H
		7323	45.93	-28.07	74	63.4	37.22	9.68	64.83	100	0	P	H
		7323	21.14	-32.86	54	-	-	-	-	-	-	A	H
		4882	39.28	-34.72	74	63.78	31.88	7.82	64.7	100	0	P	V
		4882	14.49	-39.51	54	-	-	-	-	-	-	A	V
		7323	44.5	-29.5	74	61.97	37.22	9.68	64.83	100	0	P	V
		7323	19.71	-34.29	54	-	-	-	-	-	-	A	V
BT CH 78 2480MHz		4960	40.76	-33.24	74	64.88	32.04	7.98	64.63	100	0	P	H
		4960	15.97	-38.03	54	-	-	-	-	-	-	A	H
		7440	44.43	-29.57	74	61.52	37.56	9.77	64.88	100	0	P	H
		7440	19.64	-34.36	54	-	-	-	-	-	-	A	H
		4960	39.92	-34.08	74	64.04	32.04	7.98	64.63	100	0	P	V
		4960	15.13	-38.87	54	-	-	-	-	-	-	A	V
		7440	45.48	-28.52	74	62.57	37.56	9.77	64.88	100	0	P	V
		7440	20.69	-33.31	54	-	-	-	-	-	-	A	V
Remark	1. No other spurious found. 2. All results are PASS against Peak and Average limit line.												



2.4GHz 2400~2483.5MHz

BT (3M) (Band Edge @ 3m)

BT	Note	Frequency	Level	Over	Limit	Read	Antenna	Cable	Preamp	Ant	Table	Peak	Pol.	
		(MHz)	(dBµV/m)	(dB)	(dBµV/m)	(dBµV)	(dB/m)	(dB)	(dB)	(cm)	(deg)	(P/A)	(H/V)	
BT CH00 2402MHz		2311.785	42.09	-31.91	74	41.27	27.09	4.74	31.01	371	76	P	H	
		2311.785	17.3	-36.7	54	-	-	-	-	-	-	A	H	
	*	2402	97.67	-	-	96.44	27.37	4.85	30.99	371	76	P	H	
	*	2402	72.88	-	-	-	-	-	-	-	-	A	H	
													H	
														H
			2388.015	42.38	-31.62	74	41.17	27.37	4.83	30.99	382	349	P	V
			2388.015	17.59	-36.41	54	-	-	-	-	-	-	A	V
	*	2402	94.41	-	-	93.18	27.37	4.85	30.99	382	349	P	V	
	*	2402	69.62	-	-	-	-	-	-	-	-	-	A	V
														V
														V
BT CH 39 2441MHz		2315.6	42.12	-31.88	74	41.3	27.09	4.74	31.01	400	80	P	H	
		2315.6	17.33	-36.67	54	-	-	-	-	-	-	A	H	
	*	2441	98.89	-	-	97.45	27.53	4.88	30.97	400	80	P	H	
	*	2441	74.1	-	-	-	-	-	-	-	-	A	H	
			2485.65	41.72	-32.28	74	40.12	27.64	4.93	30.97	400	80	P	H
			2485.65	16.93	-37.07	54	-	-	-	-	-	-	A	H
			2386.72	41.52	-32.48	74	40.31	27.37	4.83	30.99	400	270	P	V
			2386.72	16.73	-37.27	54	-	-	-	-	-	-	A	V
	*	2441	92.23	-	-	90.79	27.53	4.88	30.97	400	270	P	V	
	*	2441	67.44	-	-	-	-	-	-	-	-	-	A	V
			2498.81	41.95	-32.05	74	40.28	27.7	4.93	30.96	400	270	P	V
			2498.81	17.16	-36.84	54	-	-	-	-	-	-	A	V



BT CH 78 2480MHz	*	2480	97	-	-	95.41	27.64	4.92	30.97	389	76	P	H
	*	2480	72.21	-	-	-	-	-	-	-	-	A	H
		2483.76	42.72	-31.28	74	41.12	27.64	4.93	30.97	389	76	P	H
		2483.76	17.93	-36.07	54	-	-	-	-	-	-	A	H
													H
													H
	*	2480	93.46	-	-	91.87	27.64	4.92	30.97	400	351	P	V
	*	2480	68.67	-	-	-	-	-	-	-	-	A	V
		2485.12	43.23	-30.77	74	41.63	27.64	4.93	30.97	400	351	P	V
		2485.12	18.44	-35.56	54	-	-	-	-	-	-	A	V
													V
													V
Remark	1. No other spurious found. 2. All results are PASS against Peak and Average limit line.												



2.4GHz 2400~2483.5MHz

BT (3M) (Harmonic @ 3m)

BT	Note	Frequency (MHz)	Level (dBμV/m)	Over Limit (dB)	Limit Line (dBμV/m)	Read Level (dBμV)	Antenna Factor (dB/m)	Cable Loss (dB)	Preamp Factor (dB)	Ant Pos (cm)	Table Pos (deg)	Peak Avg. (P/A)	Pol. (H/V)
BT CH 00 2402MHz		4804	38.75	-35.25	74	63.57	31.76	7.65	64.75	100	0	P	H
		4804	13.96	-40.04	54	-	-	-	-	-	-	A	H
													H
													H
		4804	39.49	-34.51	74	64.31	31.76	7.65	64.75	100	0	P	V
		4804	14.7	-39.3	54	-	-	-	-	-	-	A	V
													V
													V
BT CH 39 2441MHz		4882	40.67	-33.33	74	65.17	31.88	7.82	64.7	100	0	P	H
		4882	15.88	-38.12	54	-	-	-	-	-	-	A	H
		7323	46.13	-27.87	74	63.6	37.22	9.68	64.83	100	0	P	H
		7323	21.34	-32.66	54	-	-	-	-	-	-	A	H
		4882	39.33	-34.67	74	63.83	31.88	7.82	64.7	100	0	P	V
		4882	14.54	-39.46	54	-	-	-	-	-	-	A	V
		7323	44.88	-29.12	74	62.35	37.22	9.68	64.83	100	0	P	V
		7323	20.09	-33.91	54	-	-	-	-	-	-	A	V
BT CH 78 2480MHz		4960	39.65	-34.35	74	63.77	32.04	7.98	64.63	100	0	P	H
		4960	14.86	-39.14	54	-	-	-	-	-	-	A	H
		7440	44.04	-29.96	74	61.13	37.56	9.77	64.88	100	0	P	H
		7440	19.25	-34.75	54	-	-	-	-	-	-	A	H
		4960	38.95	-35.05	74	63.07	32.04	7.98	64.63	100	0	P	V
		4960	14.16	-39.84	54	-	-	-	-	-	-	A	V
		7440	44.09	-29.91	74	61.18	37.56	9.77	64.88	100	0	P	V
		7440	19.3	-34.7	54	-	-	-	-	-	-	A	V
Remark	1. No other spurious found. 2. All results are PASS against Peak and Average limit line.												



Emission below 1GHz

2.4GHz BT (LF)

BT	Note	Frequency	Level	Over	Limit	Read	Antenna	Cable	Preamp	Ant	Table	Peak	Pol.	
		(MHz)	(dBμV/m)	(dB)	(dBμV/m)	(dBμV)	(dB/m)	(dB)	(dB)	(cm)	(deg)	(P/A)	(H/V)	
2.4GHz BT LF		30	20.73	-19.27	40	29.87	22.63	0.59	32.34			P	H	
		139.08	36.6	-6.9	43.5	53.22	14.43	1.19	32.28	100	0	P	H	
		221.97	30.89	-15.11	46	49.39	12.14	1.53	32.24			P	H	
		472.9	21.07	-24.93	46	30.75	20.26	2.17	32.19			P	H	
		727	26.28	-19.72	46	31.08	24.56	2.66	32.12			P	H	
		958	30.96	-15.04	46	30.27	28.46	3.07	30.98			P	H	
													H	
													H	
													H	
													H	
													H	
													H	
			44.31	30.77	-9.23	40	50.91	11.42	0.74	32.33	100	0	P	V
			134.76	32.39	-11.11	43.5	49.52	13.91	1.19	32.28			P	V
			221.97	25.46	-20.54	46	43.96	12.14	1.53	32.24			P	V
			451.2	20.79	-25.21	46	30.87	19.92	2.1	32.18			P	V
			843.9	32.46	-13.54	46	34.96	26.31	2.84	31.78			P	V
			946.1	31.34	-14.66	46	31.59	27.64	3.06	31.09			P	V
													V	
													V	
												V		
												V		
												V		
												V		
Remark	1. No other spurious found. 2. All results are PASS against limit line.													



Note symbol

*	Fundamental Frequency which can be ignored. However, the level of any unwanted emissions shall not exceed the level of the fundamental frequency.
!	Test result is over limit line.
P/A	Peak or Average
H/V	Horizontal or Vertical



A calculation example for radiated spurious emission is shown as below:

WIFI	Note	Frequency	Level	Over	Limit	Read	Antenna	Cable	Preamp	Ant	Table	Peak	Pol.
Ant.				Limit	Line	Level	Factor	Loss	Factor	Pos	Pos	Avg.	
1+2		(MHz)	(dBμV/m)	(dB)	(dBμV/m)	(dBμV)	(dB/m)	(dB)	(dB)	(cm)	(deg)	(P/A)	(H/V)
802.11b		2390	55.45	-18.55	74	54.51	32.22	4.58	35.86	103	308	P	H
CH 01													
2412MHz		2390	43.54	-10.46	54	42.6	32.22	4.58	35.86	103	308	A	H

1. Level(dBμV/m) =

Antenna Factor(dB/m) + Cable Loss(dB) + Read Level(dBμV) - Preamp Factor(dB)

2. Over Limit(dB) = Level(dBμV/m) – Limit Line(dBμV/m)

For Peak Limit @ 2390MHz:

1. Level(dBμV/m)

= Antenna Factor(dB/m) + Cable Loss(dB) + Read Level(dBμV) - Preamp Factor(dB)

= 32.22(dB/m) + 4.58(dB) + 54.51(dBμV) – 35.86 (dB)

= 55.45 (dBμV/m)

2. Over Limit(dB)

= Level(dBμV/m) – Limit Line(dBμV/m)

= 55.45(dBμV/m) – 74(dBμV/m)

= -18.55(dB)

For Average Limit @ 2390MHz:

1. Level(dBμV/m)

= Antenna Factor(dB/m) + Cable Loss(dB) + Read Level(dBμV) - Preamp Factor(dB)

= 32.22(dB/m) + 4.58(dB) + 42.6(dBμV) – 35.86 (dB)

= 43.54 (dBμV/m)

2. Over Limit(dB)

= Level(dBμV/m) – Limit Line(dBμV/m)

= 43.54(dBμV/m) – 54(dBμV/m)

= -10.46(dB)

Both peak and average measured complies with the limit line, so test result is “PASS”.



Appendix B. Radiated Spurious Emission Plots

Test Engineer :	Alex Jheng, Bill Chang, and Wilson Wu	Temperature :	24.5~24.6°C
		Relative Humidity :	55~57%

2.4GHz 2400~2483.5MHz

BT (1M) (Band Edge @ 3m)

BT	2.4GHz 2400~2483.5MHz Band Edge @ 3m	
ANT	BT CH00 2402MHz	
1	Horizontal	Fundamental
Peak	<p>Site : 03GH13-HY Condition : PEAK_BE_74 3m HORN_91200_1522 HORIZONTAL</p>	<p>Site : 03GH13-HY Condition : PEAK_74 3m HORN_91200_1522 HORIZONTAL</p>

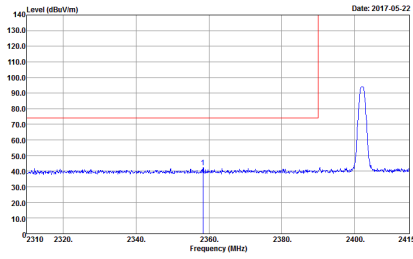
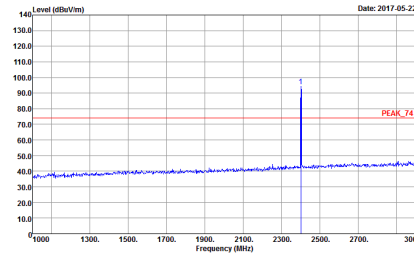

BT	2.4GHz 2400~2483.5MHz Band Edge @ 3m	
ANT	BT CH00 2402MHz	
1	Vertical	Fundamental
Peak	 <p data-bbox="343 795 758 828">Date: 2017-05-22 Site : 03CH13-HY Condition : PEAK_BE_74 3m HORN_91200_1522 VERTICAL</p>	 <p data-bbox="933 795 1348 828">Date: 2017-05-22 Site : 03CH13-HY Condition : PEAK_74 3m HORN_91200_1522 VERTICAL</p>

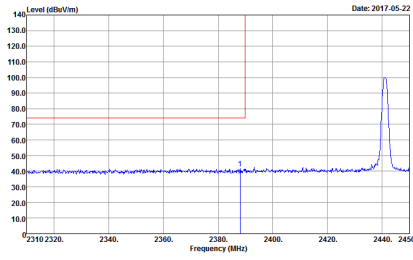
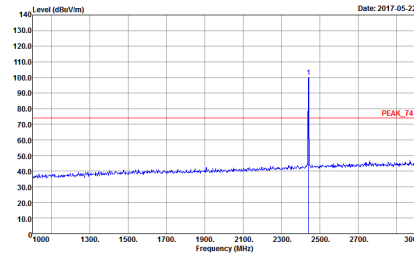
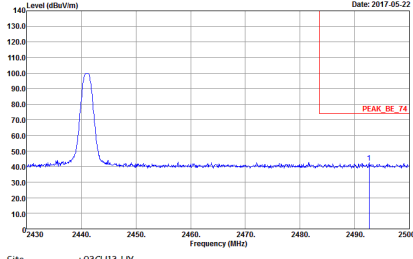

BT	2.4GHz 2400~2483.5MHz Band Edge @ 3m	
ANT	BT CH39 2441MHz	
1	Horizontal	Fundamental
Peak	 <p>Date: 2017-05-22</p> <p>Site : 03CH13-HY Condition : PEAK_BE_74 3m HORN_9120D_1522 HORIZONTAL</p>	 <p>Date: 2017-05-22</p> <p>Site : 03CH13-HY Condition : PEAK_74 3m HORN_9120D_1522 HORIZONTAL</p>
Peak	 <p>Date: 2017-05-22</p> <p>Site : 03CH13-HY Condition : PEAK_BE_74 3m HORN_9120D_1522 HORIZONTAL</p>	Left blank

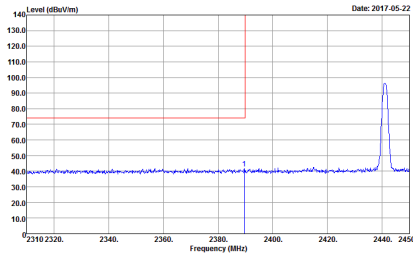
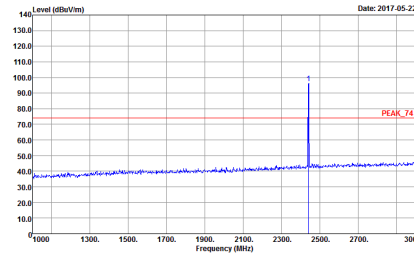
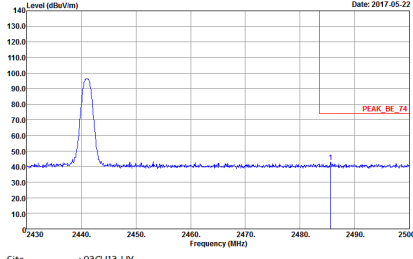

BT	2.4GHz 2400~2483.5MHz Band Edge @ 3m	
ANT	BT CH39 2441MHz	
1	Vertical	Fundamental
Peak	 <p>Date: 2017-05-22</p> <p>Site : 03CH13-HY Condition : PEAK_BE_74 3m HORN_9120D_1522 VERTICAL</p>	 <p>Date: 2017-05-22</p> <p>Site : 03CH13-HY Condition : PEAK_74 3m HORN_9120D_1522 VERTICAL</p>
Peak	 <p>Date: 2017-05-22</p> <p>Site : 03CH13-HY Condition : PEAK_BE_74 3m HORN_9120D_1522 VERTICAL</p>	Left blank

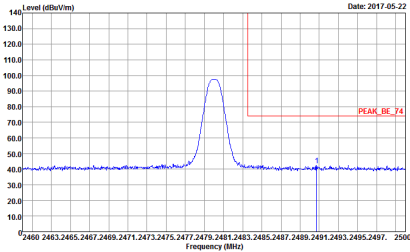
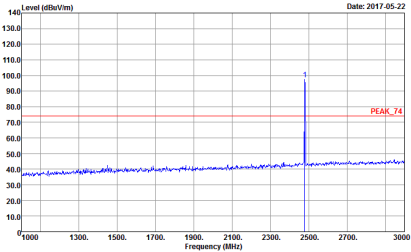

BT	2.4GHz 2400~2483.5MHz Band Edge @ 3m	
ANT	BT CH78 2480MHz	
1	Horizontal	Fundamental
Peak	 <p>Date: 2017-05-22</p> <p>Site : 03CH13-HY Condition : PEAK_BE_74 3m HORN_9120D_1522 HORIZONTAL</p>	 <p>Date: 2017-05-22</p> <p>Site : 03CH13-HY Condition : PEAK_74 3m HORN_9120D_1522 HORIZONTAL</p>

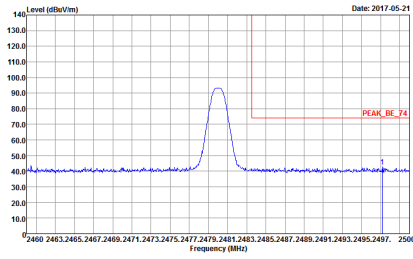
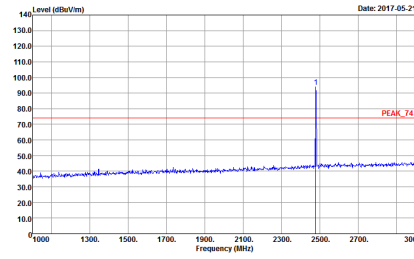

BT	2.4GHz 2400~2483.5MHz Band Edge @ 3m	
ANT	BT CH78 2480MHz	
1	Vertical	Fundamental
Peak	 <p data-bbox="343 795 758 828">Date: 2017-05-21 Site : 03CH13-HY Condition : PEAK_BE_74 3m HORN_9120D_1522 VERTICAL</p>	 <p data-bbox="933 795 1348 828">Date: 2017-05-21 Site : 03CH13-HY Condition : PEAK_74 3m HORN_9120D_1522 VERTICAL</p>



2.4GHz 2400~2483.5MHz

BT (1M) (Harmonic @ 3m)

BT	2.4GHz 2400~2483.5MHz Harmonic @ 3m	
ANT	BT CH00 2402MHz	
1	Horizontal	Vertical
Peak Avg.	<p>Site : 03CH13-1Y Condition : PEAK_74 3m SHF_HORN_584 HORIZONTAL</p>	<p>Site : 03CH13-1Y Condition : PEAK_74 3m SHF_HORN_584 VERTICAL</p>



BT	2.4GHz 2400~2483.5MHz Harmonic @ 3m	
ANT	BT CH39 2441MHz	
1	Horizontal	Vertical
Peak Avg.	<p>Site : 03CH13-HY Condition : PEAK_74 3m SHF_HORN_584 HORIZONTAL</p>	<p>Site : 03CH13-HY Condition : PEAK_74 3m SHF_HORN_584 VERTICAL</p>

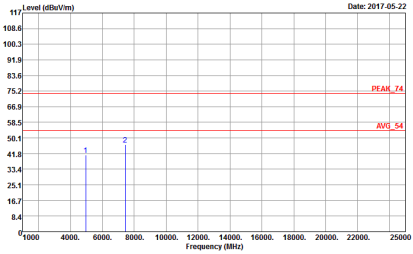
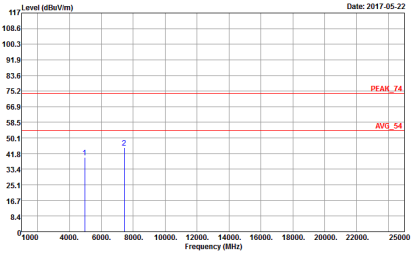

BT	2.4GHz 2400~2483.5MHz Harmonic @ 3m	
ANT	BT CH78 2480MHZ	
1	Horizontal	Vertical
<p>Peak</p> <p>Avg.</p>	 <p>Site : 03CH13-HY Condition : PEAK_74 3m SHF_HORN_584 HORIZONTAL</p>	 <p>Site : 03CH13-HY Condition : PEAK_74 3m SHF_HORN_584 VERTICAL</p>



2.4GHz 2400~2483.5MHz

BT (2M) (Band Edge @ 3m)

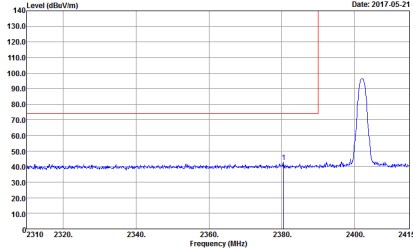
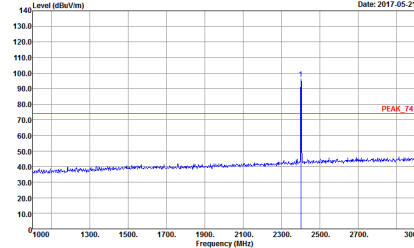
BT	2.4GHz 2400~2483.5MHz Band Edge @ 3m	
ANT	BT CH00 2402MHz	
1	Horizontal	Fundamental
Peak	 <p>Site : 03CH13-1Y Condition : PEAK_BE_74 3m HORN_9120D_1522 HORIZONTAL</p>	 <p>Site : 03CH13-1Y Condition : PEAK_74 3m HORN_9120D_1522 HORIZONTAL</p>

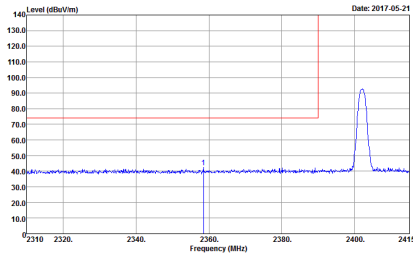
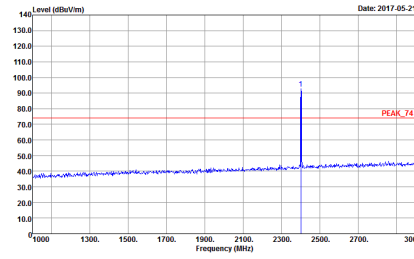

BT	2.4GHz 2400~2483.5MHz Band Edge @ 3m	
ANT	BT CH00 2402MHz	
1	Vertical	Fundamental
Peak	 <p data-bbox="343 795 758 828">Date: 2017-05-21 Site : 03CH13-HY Condition : PEAK_BE_74 3m HORN_91200_1522 VERTICAL</p>	 <p data-bbox="933 795 1348 828">Date: 2017-05-21 Site : 03CH13-HY Condition : PEAK_74 3m HORN_91200_1522 VERTICAL</p>

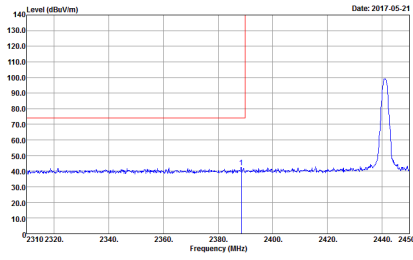
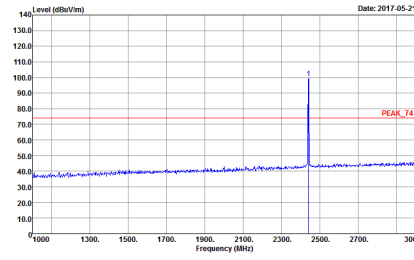
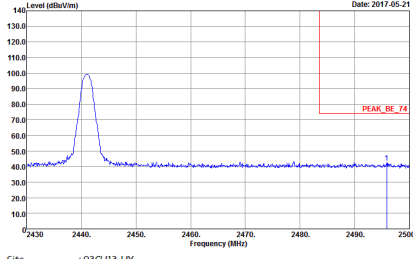

BT	2.4GHz 2400~2483.5MHz Band Edge @ 3m	
ANT	BT CH39 2441MHz	
1	Horizontal	Fundamental
Peak	 <p>Date: 2017-05-21</p> <p>Site : 03CH13-HY Condition : PEAK_BE_74 3m HORN_9120D_1522 HORIZONTAL</p>	 <p>Date: 2017-05-21</p> <p>Site : 03CH13-HY Condition : PEAK_74 3m HORN_9120D_1522 HORIZONTAL</p>
Peak	 <p>Date: 2017-05-21</p> <p>Site : 03CH13-HY Condition : PEAK_BE_74 3m HORN_9120D_1522 HORIZONTAL</p>	Left blank



BT	2.4GHz 2400~2483.5MHz Band Edge @ 3m	
ANT	BT CH39 2441MHz	
1	Vertical	Fundamental
<p>Peak</p>	<p>Site : 03CH13-HY Condition : PEAK_BE_74 3m HORN_9120D_1522 VERTICAL</p>	<p>Site : 03CH13-HY Condition : PEAK_74 3m HORN_9120D_1522 VERTICAL</p>
<p>Peak</p>	<p>Site : 03CH13-HY Condition : PEAK_BE_74 3m HORN_9120D_1522 VERTICAL</p>	<p>Left blank</p>

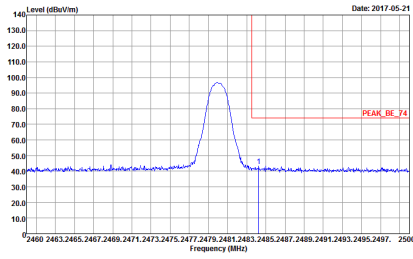
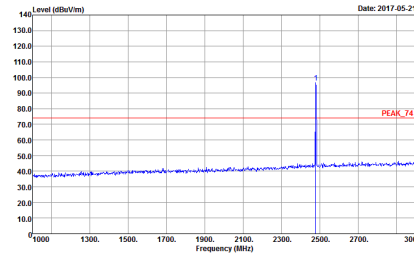

BT	2.4GHz 2400~2483.5MHz Band Edge @ 3m	
ANT	BT CH78 2480MHz	
1	Horizontal	Fundamental
Peak	 <p data-bbox="347 795 654 824">Date: 2017-05-21 Site : 03CH13-HY Condition : PEAK_BE_74 3m HORN_91200_1522 HORIZONTAL</p>	 <p data-bbox="946 795 1236 824">Date: 2017-05-21 Site : 03CH13-HY Condition : PEAK_74 3m HORN_91200_1522 HORIZONTAL</p>

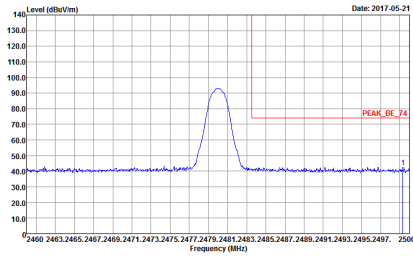
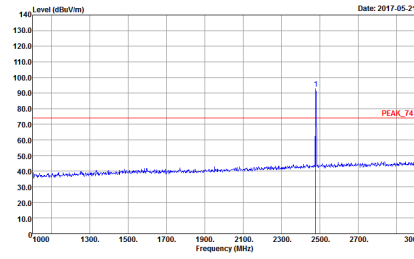

BT	2.4GHz 2400~2483.5MHz Band Edge @ 3m	
ANT	BT CH78 2480MHz	
1	Vertical	Fundamental
Peak	 <p data-bbox="343 795 758 828">Date: 2017-05-21 Site : 03CH13-HY Condition : PEAK_BE_74 3m HORN_9120D_1522 VERTICAL</p>	 <p data-bbox="933 795 1348 828">Date: 2017-05-21 Site : 03CH13-HY Condition : PEAK_74 3m HORN_9120D_1522 VERTICAL</p>



2.4GHz 2400~2483.5MHz

BT (2M) (Harmonic @ 3m)

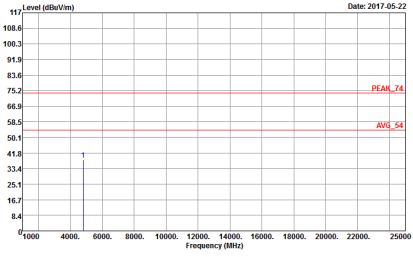
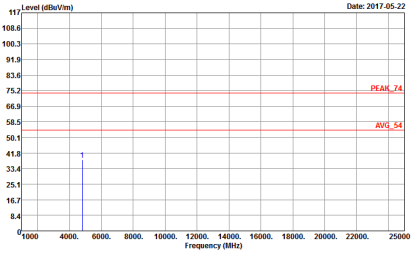
BT	2.4GHz 2400~2483.5MHz Harmonic @ 3m	
ANT	BT CH00 2402MHz	
1	Horizontal	Vertical
Peak Avg.	 <p>Site : 03CH13-1Y Condition : PEAK_74 3m SHF_HORN_584 HORIZONTAL</p>	 <p>Site : 03CH13-1Y Condition : PEAK_74 3m SHF_HORN_584 VERTICAL</p>

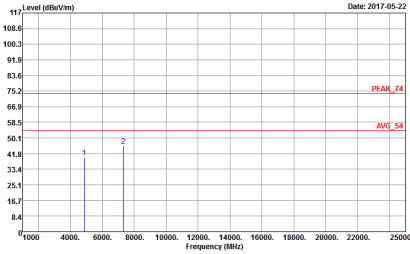
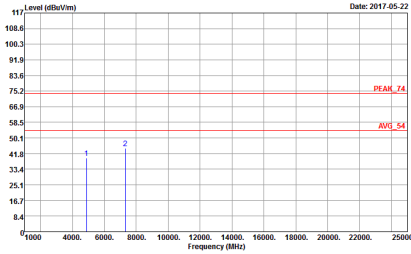

BT	2.4GHz 2400~2483.5MHz Harmonic @ 3m	
ANT	BT CH39 2441MHz	
1	Horizontal	Vertical
Peak Avg.	 <p>Date: 2017-05-22</p> <p>Site : 03CH13-HY Condition : PEAK_74 3m SHF_HORN_584 HORIZONTAL</p>	 <p>Date: 2017-05-22</p> <p>Site : 03CH13-HY Condition : PEAK_74 3m SHF_HORN_584 VERTICAL</p>

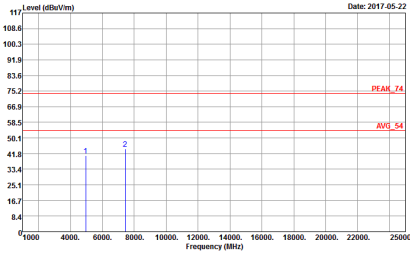
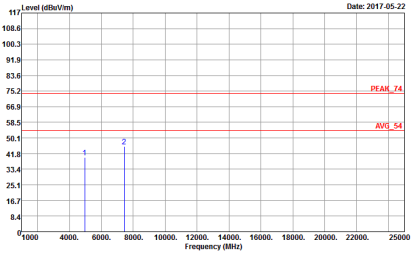

BT	2.4GHz 2400~2483.5MHz Harmonic @ 3m	
ANT	BT CH78 2480MHZ	
1	Horizontal	Vertical
<p>Peak</p> <p>Avg.</p>	 <p>Site : 03CH13-HY Condition : PEAK_74 3m SHF_HORN_584 HORIZONTAL</p>	 <p>Site : 03CH13-HY Condition : PEAK_74 3m SHF_HORN_584 VERTICAL</p>



2.4GHz 2400~2483.5MHz

BT (3M) (Band Edge @ 3m)

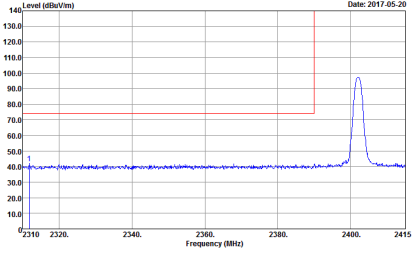
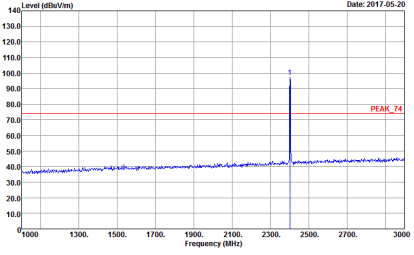
BT	2.4GHz 2400~2483.5MHz Band Edge @ 3m	
ANT	BT CH00 2402MHz	
1	Horizontal	Fundamental
Peak	 <p>Site : 03CH13-1Y Condition : PEAK_BE_74 3m HORN_9120D_1522 HORIZONTAL</p>	 <p>Site : 03CH13-1Y Condition : PEAK_74 3m HORN_9120D_1522 HORIZONTAL</p>

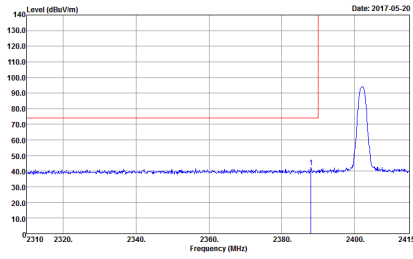
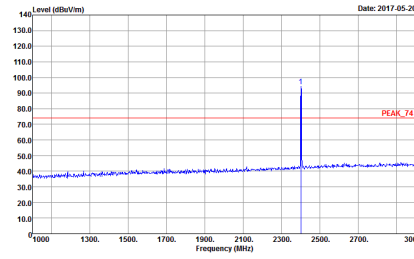

BT	2.4GHz 2400~2483.5MHz Band Edge @ 3m	
ANT	BT CH00 2402MHz	
1	Vertical	Fundamental
Peak	 <p data-bbox="343 795 758 828">Date: 2017-05-20 Site : 03CH13-HY Condition : PEAK_BE_74 3m HORN_9120D_1522 VERTICAL</p>	 <p data-bbox="938 795 1353 828">Date: 2017-05-20 Site : 03CH13-HY Condition : PEAK_74 3m HORN_9120D_1522 VERTICAL</p>

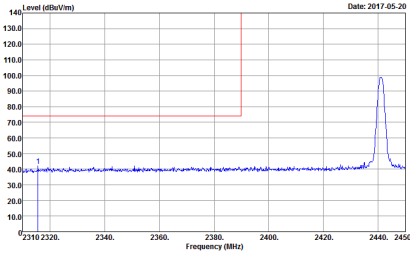
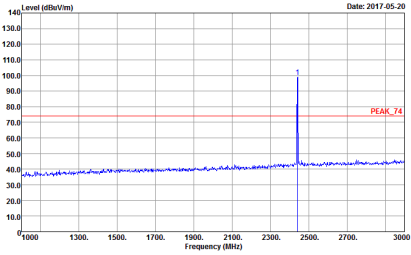
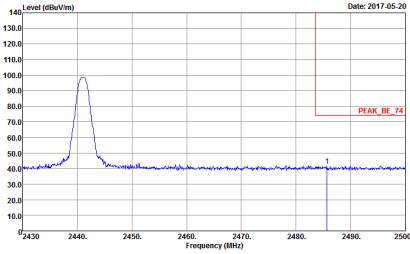

BT	2.4GHz 2400~2483.5MHz Band Edge @ 3m	
ANT	BT CH39 2441MHz	
1	Horizontal	Fundamental
Peak	 <p>Site : 03CH13-HY Condition : PEAK_BE_74 3m HORN_9120D_1522 HORIZONTAL</p>	 <p>Site : 03CH13-HY Condition : PEAK_74 3m HORN_9120D_1522 HORIZONTAL</p>
Peak	 <p>Site : 03CH13-HY Condition : PEAK_BE_74 3m HORN_9120D_1522 HORIZONTAL</p>	Left blank

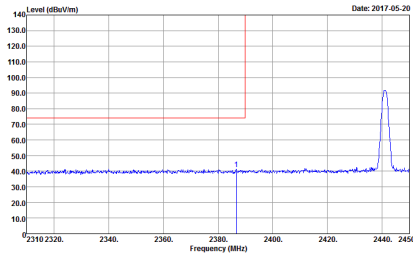
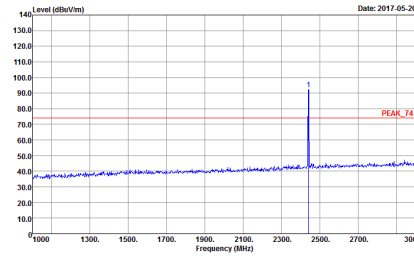
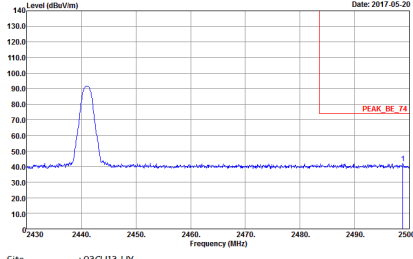

BT	2.4GHz 2400~2483.5MHz Band Edge @ 3m	
ANT	BT CH39 2441MHz	
1	Vertical	Fundamental
Peak	 <p>Date: 2017-05-20</p> <p>Site : 03CH13-HY Condition : PEAK_BE_74 3m HORN_9120D_1522 VERTICAL</p>	 <p>Date: 2017-05-20</p> <p>Site : 03CH13-HY Condition : PEAK_74 3m HORN_9120D_1522 VERTICAL</p>
Peak	 <p>Date: 2017-05-20</p> <p>Site : 03CH13-HY Condition : PEAK_BE_74 3m HORN_9120D_1522 VERTICAL</p>	Left blank

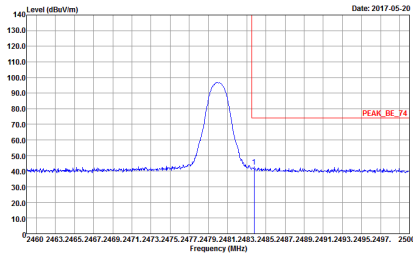
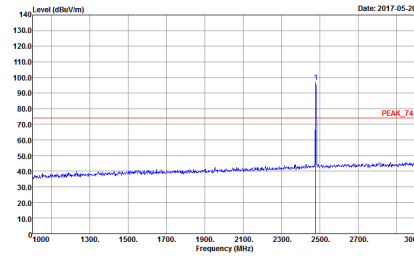

BT	2.4GHz 2400~2483.5MHz Band Edge @ 3m	
ANT	BT CH78 2480MHz	
1	Horizontal	Fundamental
Peak	 <p>Date: 2017-05-20</p> <p>Site : 03CH13-HY Condition : PEAK_BE_74 3m HORN_91200_1522 HORIZONTAL</p>	 <p>Date: 2017-05-20</p> <p>Site : 03CH13-HY Condition : PEAK_74 3m HORN_91200_1522 HORIZONTAL</p>

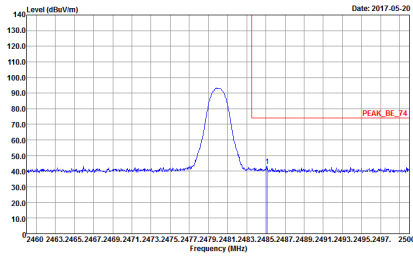
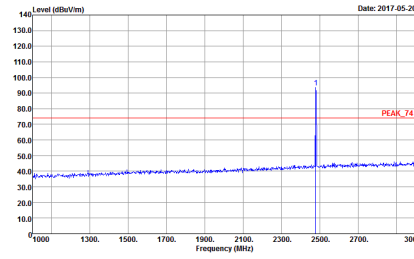

BT	2.4GHz 2400~2483.5MHz Band Edge @ 3m	
ANT	BT CH78 2480MHz	
1	Vertical	Fundamental
Peak	 <p>Date: 2017-05-20</p> <p>Site : 03CH13-HY Condition : PEAK_BE_74 3m HORN_9120D_1522 VERTICAL</p>	 <p>Date: 2017-05-20</p> <p>Site : 03CH13-HY Condition : PEAK_74 3m HORN_9120D_1522 VERTICAL</p>



2.4GHz 2400~2483.5MHz

BT (3M) (Harmonic @ 3m)

BT	2.4GHz 2400~2483.5MHz Harmonic @ 3m	
ANT	BT CH00 2402MHz	
1	Horizontal	Vertical
Peak Avg.	<p>Site : 03CH13-1Y Condition : PEAK_74 3m SHF_HORN_584 HORIZONTAL</p>	<p>Site : 03CH13-1Y Condition : PEAK_74 3m SHF_HORN_584 VERTICAL</p>

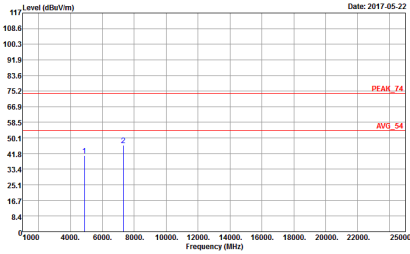
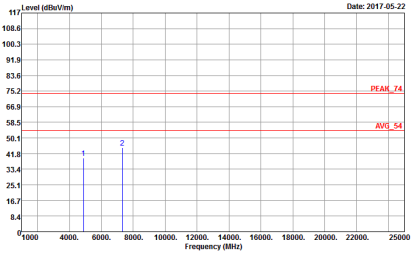

BT	2.4GHz 2400~2483.5MHz Harmonic @ 3m	
ANT	BT CH39 2441MHz	
1	Horizontal	Vertical
Peak Avg.	 <p>Site : 03CH13-HY Condition : PEAK_74 3m SHF_HORN_584 HORIZONTAL</p>	 <p>Site : 03CH13-HY Condition : PEAK_74 3m SHF_HORN_584 VERTICAL</p>

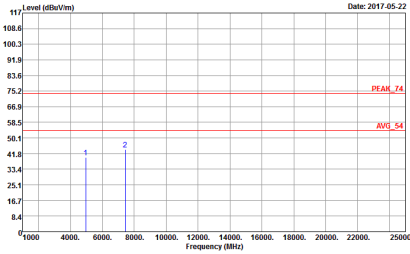
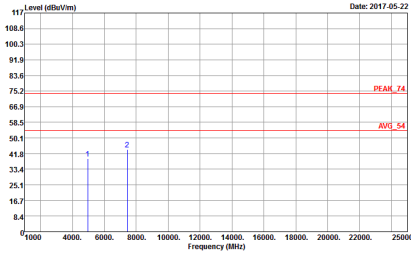

BT	2.4GHz 2400~2483.5MHz Harmonic @ 3m	
ANT	BT CH78 2480MHZ	
1	Horizontal	Vertical
Peak Avg.	 <p>Site : 03CH13-HY Condition : PEAK_74 3m SHF_HORN_584 HORIZONTAL</p>	 <p>Site : 03CH13-HY Condition : PEAK_74 3m SHF_HORN_584 VERTICAL</p>



Emission below 1GHz

2.4GHz BT (LF)

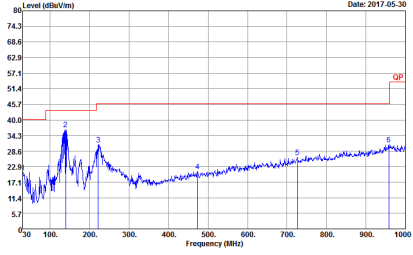
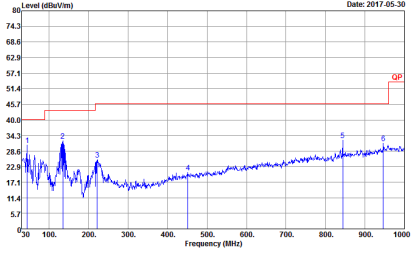
BT	2.4GHz 2400~2483.5MHz	
ANT	BT LF	
1	Horizontal	Vertical
QP / Peak	 <p>Site : 03CH13-14Y Condition : QP 3m BILOG_40103 HORIZONTAL</p>	 <p>Site : 03CH13-14Y Condition : QP 3m BILOG_40103 VERTICAL</p>