



CERTIFICATION TEST REPORT

Report Number. : 11626381H-E1V4

Applicant : SONY MOBILE COMMUNICATIONS INC.
4-12-3 HIGASHI-SHINAGAWA,
SHINAGAWA -KU,TOKYO, 140-0002, JAPAN

FCC ID : PY7-54254H

EUT Description : GSM/WCDMA/LTE Phone with BT,DTS/UNII a/b/g/n/ac, GPS & NFC

Test Standard(s) : FCC CFR47 PART 22 SUBPART H
FCC CFR47 PART 24 SUBPART E
FCC CFR47 PART 27 SUBPART F, H, L, and M

Date Of Issue:

April 17, 2017

Prepared by:

UL Verification Services Inc.
47173 Benicia Street
Fremont, CA 94538, U.S.A.
TEL: (510) 771-1000
FAX: (510) 661-0888

Revision History



NVLAP LAB CODE 200065-0

Rev.	Issue Date	Revisions	Revised By
V1	03/22/17	Initial Issue	C. Vergonio
V2	04/10/17	Deleted Model Number. Updated Test procedure in Section 11.3 (Page 22). Updated Section 11.5 (Page 24). Added LTE 13 Frequency stability results. Updated the reference freq. column and fixed LTE 12 table. Updated LTE7 BW QPSK EIRP table in page 169. Updated Section 17.1.1 (Page 175, 177, 179) test frequencies.	C. Vergonio
V3	04/11/17	Corrected Reference Frequency, Pages 156-157	C. Vergonio
V4	04/17/17	Added note in Section 11.9.	C. Vergonio

TABLE OF CONTENTS

1. ATTESTATION OF TEST RESULTS5

2. TEST METHODOLOGY 6

3. FACILITIES AND ACCREDITATION6

4. CALIBRATION AND UNCERTAINTY 6

 4.1. MEASURING INSTRUMENT CALIBRATION 6

 4.2. SAMPLE CALCULATION 6

 4.3. MEASUREMENT UNCERTAINTY 7

5. EQUIPMENT UNDER TEST 7

 5.1. DESCRIPTION OF EUT 7

6. MAXIMUM OUTPUT POWER8

 6.1. MAXIMUM OUTPUT POWER (GSM/EGPRS)..... 8

 6.2. MAXIMUM OUTPUT POWER (WCDMA)..... 9

 6.3. MAXIMUM OUTPUT POWER (LTE)..... 10

7. DESCRIPTION OF AVAILABLE ANTENNAS 13

8. DESCRIPTION OF TEST SETUP 14

9. TEST AND MEASUREMENT EQUIPMENT 17

10. SUMMARY TABLE..... 18

11. RF POWER OUTPUT VERIFICATION..... 19

 11.1. GSM/GPRS/EDGE 19

 11.2. GSM OUTPUT POWER RESULT 20

 11.3. UMTS REL 99..... 22

 11.4. UMTS REL 99 OUTPUT POWER RESULT 23

 11.5. UMTS HSDPA 24

 11.6. UMTS HSDPA OUTPUT POWER RESULT 25

 11.7. UMTS HSUPA 26

 11.8. UMTS HSUPA OUTPUT POWER RESULT 27

 11.9. LTE OUTPUT POWER RESULT 28

12. PEAK TO AVERAGE RATIO42

 12.1. CONDUCTED PEAK TO AVERAGE RESULT 43

13. OCCUPIED BANDWIDTH57

 13.1. OCCUPIED BANDWIDTH RESULTS AND PLOTS 58

14. BAND EDGE EMISSIONS.....82

14.1.	BAND EDGE PLOTS	83
14.2.	EMISSION MASK PLOTS	118
15.	OUT OF BAND EMISSIONS	130
15.1.	OUT OF BAND EMISSIONS RESULT AND PLOTS.....	131
16.	FREQUENCY STABILITY	155
16.1.	FREQUENCY STABILITY RESULTS.....	156
17.	RADIATED TEST RESULTS.....	159
17.1.	RADIATED POWER (ERP & EIRP).....	159
17.1.1.	ERP/EIRP RESULTS AND TABLE	160
17.2.	FIELD STRENGTH OF SPURIOUS RADIATION.....	183
17.2.1.	SPURIOUS RADIATION PLOTS.....	184
18.	SETUP PHOTOS.....	199

1. ATTESTATION OF TEST RESULTS

COMPANY NAME: SONY MOBILE COMMUNICATIONS, INC.
4-12-3 HIGASHI-SHINAGAWA,
SHINAGAWA –KU, TOKYO, 140-0002, JAPAN

EUT DESCRIPTION: GSM/WCDMA/LTE PHONE with BT, DTS/UNII a/b/g/n/ac & NFC

SERIAL NUMBER: CB512DHRLY, CB512DHRQK, CB512DHRWX, CB512DHRTZ(conducted),
CB512DQZUX, CB512DQZYK(Radiated)

DATE TESTED: March 6-17, 2017

APPLICABLE STANDARDS	
STANDARD	TEST RESULTS
FCC PART 22H, 24E, 27H, 27F, 27L, 27M	PASS

UL Verification Services Inc. tested the above equipment in accordance with the requirements set forth in the above standards. All indications of Pass/Fail in this report are opinions expressed by UL Verification Services Inc. based on interpretations and/or observations of test results. Measurement Uncertainties were not taken into account and are published for informational purposes only. The test results show that the equipment tested is capable of demonstrating compliance with the requirements as documented in this report.

Note: The results documented in this report apply only to the tested sample, under the conditions and modes of operation as described herein. This document may not be altered or revised in any way unless done so by UL Verification Services Inc. and all revisions are duly noted in the revisions section. Any alteration of this document not carried out by UL Verification Services Inc. will constitute fraud and shall nullify the document. This report must not be used by the client to claim product certification, approval, or endorsement by NVLAP, NIST, any agency of the Federal Government, or any agency of any government.

Approved & Released For
UL Verification Services Inc. By:

Prepared By:



CHARLES VERGONIO
CONSUMER TECHNOLOGY DIVISION
WISE PROJECT LEAD
UL VERIFICATION SERVICES INC

KIYA KEDIDA
CONSUMER TECHNOLOGY DIVISION
WISE ENGINEER
UL VERIFICATION SERVICES INC

2. TEST METHODOLOGY

The tests documented in this report were performed in accordance with TIA-603-D, FCC CFR 47 Part 22,24, FCC CFR 47 Part 27.

3. FACILITIES AND ACCREDITATION

The test sites and measurement facilities used to collect data are located at 47173 and 47266 Benicia Street, Fremont, California, USA. Line conducted emissions are measured only at the 47173 address. The following table identifies which facilities were utilized for radiated emission measurements documented in this report. Specific facilities are also identified in the test results sections.

47173 Benicia Street	47266 Benicia Street
<input checked="" type="checkbox"/> Chamber A	<input type="checkbox"/> Chamber D
<input checked="" type="checkbox"/> Chamber B	<input type="checkbox"/> Chamber E
<input checked="" type="checkbox"/> Chamber C	<input type="checkbox"/> Chamber F
	<input type="checkbox"/> Chamber G
	<input type="checkbox"/> Chamber H

The above test sites and facilities are covered under FCC Test Firm Registration # 208313.

UL Verification Services Inc. is accredited by NVLAP, Laboratory Code 200065-0.

Chambers A through H are covered under Industry Canada company address code 2324B with site numbers 2324B -1 through 2324B-8, respectively.

4. CALIBRATION AND UNCERTAINTY

4.1. MEASURING INSTRUMENT CALIBRATION

The measuring equipment utilized to perform the tests documented in this report has been calibrated in accordance with the manufacturer's recommendations, and is traceable to recognized national standards

4.2. SAMPLE CALCULATION

Where relevant, the following sample calculation is provided:

EIRP = PSA reading with EUT worst orientation (dBm) + Path loss (dB) – cable loss(between the SG and substitution antenna) + Substitution Antenna Factor (dBi)

ERP = PSA reading with EUT worst orientation (dBm) + Path loss (dB) – cable loss(between the SG and substitution antenna)

(Path loss = Signal generator output – PSA reading with substitution antenna)

4.3. MEASUREMENT UNCERTAINTY

Where relevant, the following measurement uncertainty levels have been estimated for tests performed on the apparatus:

PARAMETER	UNCERTAINTY
Occupied Channel Bandwidth	±1.1 %
RF output power, conducted	±0.35 dB
Power Spectral Density, conducted	±0.39 dB
Unwanted Emissions, conducted	±2.9 dB
All emissions, radiated	±5.36 dB
Temperature	±0.9 °C
Humidity	±2.26% RH
Supply Voltages	±0.45 %
Time	±0.2 %

Uncertainty figures are valid to a confidence level of 95%.

5. EQUIPMENT UNDER TEST

5.1. DESCRIPTION OF EUT

This EUT is a GSM/WCDMA/LTE PHONE + BLUETOOTH, DTS/UNII a/b/g/n/ac, GPS & NFC.

6. MAXIMUM OUTPUT POWER

6.1. MAXIMUM OUTPUT POWER (GSM/EGPRS)

The transmitter has a maximum peak conducted and radiated ERP / EIRP output powers as follows:

FCC Part 22/24						
Band	Frequency Range(MHz)	Modulation	Conducted		Radiated	
			AVG(dBm)	AVG(mW)	AVG(dBm)	AVG(mW)
GSM850	824~849	GSM	32.7	1862.09		
	824~849	GPRS	32.7	1862.09	28.48	704.69
	824~849	EGPRS	27.1	512.86	24.32	270.40
GSM1900	1850~1910	GSM	29.8	954.99		
	1850~1910	GPRS	29.8	954.99	29.20	831.76
	1850~1910	EGPRS	25.4	346.74	26.70	467.74

6.2. MAXIMUM OUTPUT POWER (WCDMA)

The transmitter has a maximum peak conducted and radiated ERP / EIRP output powers as follows:

FCC Part 22						
Band	Frequency Range(MHz)	Modulation	Conducted		Radiated	
			AVG(dBm)	AVG(mW)	AVG(dBm)	AVG(mW)
Band 5	824~849	REL99	24.2	263.03	18.93	78.16
	824~849	HSDPA	23.1	204.17	17.79	60.12
	824~849	HSUPA	23.1	204.17		

6.3. MAXIMUM OUTPUT POWER (LTE)

The transmitter has a maximum peak conducted and radiated ERP/EIRP output powers as follows:

LTE Band 4

FCC Part 27							
Band	Frequency Range(MHz)	BandWidth (MHz)	Modulation	Conducted		Radiated	
				AVG(dBm)	AVG(mW)	AVG(dBm)	AVG(mW)
LTE4	1710~1755	1.4MHz	QPSK	21.65	146.22	21.20	131.83
			16QAM	20.76	119.12	21.05	127.35
		3MHz	QPSK	21.60	144.54	21.72	148.59
			16QAM	20.78	119.67	20.87	122.18
		5MHz	QPSK	21.95	156.68	21.55	142.89
			16QAM	21.00	125.89	20.87	122.18
		10MHz	QPSK	21.87	153.82	20.56	113.76
			16QAM	21.00	125.89	19.74	94.19
		15MHz	QPSK	21.88	154.17	21.30	134.90
			16QAM	21.00	125.89	20.32	107.65
		20MHz	QPSK	21.80	151.36	21.09	128.53
			16QAM	21.00	125.89	20.51	112.46

LTE Band 5

FCC Part 22							
Band	Frequency Range(MHz)	BandWidth (MHz)	Modulation	Conducted		Radiated	
				AVG(dBm)	AVG(mW)	AVG(dBm)	AVG(mW)
LTE5	824~849	1.4MHz	QPSK	23.77	238.23	19.71	93.54
			16QAM	23.00	199.53	18.61	72.61
		3MHz	QPSK	23.86	243.22	19.46	88.31
			16QAM	23.00	199.53	18.64	73.11
		5MHz	QPSK	23.87	243.78	19.54	89.95
			16QAM	23.00	199.53	18.73	74.64
		10MHz	QPSK	23.82	240.99	19.43	87.70
			16QAM	22.79	190.11	18.57	71.94

LTE Band 7

FCC Part 27							
Band	Frequency Range(MHz)	BandWidth (MHz)	Modulation	Conducted		Radiated	
				AVG(dBm)	AVG(mW)	PEAK(dBm)	PEAK(mW)
LTE7	2500~2570	5MHz	QPSK	19.77	94.84	27.48	559.76
			16QAM	19.00	79.43	27.36	544.50
		10MHz	QPSK	20.00	100.00	25.51	355.63
			16QAM	19.00	79.43	26.79	477.53
		15MHz	QPSK	20.00	100.00	25.38	345.14
			16QAM	19.00	79.43	25.60	363.08
		20MHz	QPSK	19.95	98.86	25.86	385.48
			16QAM	19.00	79.43	25.95	393.55

LTE Band 12

FCC Part 27							
Band	Frequency Range(MHz)	BandWidth (MHz)	Modulation	Conducted		Radiated	
				AVG(dBm)	AVG(mW)	AVG(dBm)	AVG(mW)
LTE12	699~716	1.4MHz	QPSK	24.78	300.61	17.32	53.95
			16QAM	24.00	251.19	16.49	44.57
		3MHz	QPSK	24.89	308.32	17.49	56.10
			16QAM	24.00	251.19	16.73	47.10
		5MHz	QPSK	24.79	301.30	16.68	46.56
			16QAM	24.00	251.19	15.80	38.02
		10MHz	QPSK	24.81	302.69	17.28	53.46
			16QAM	24.00	251.19	16.70	46.77

LTE Band 13

FCC Part 27							
Band	Frequency Range(MHz)	BandWidth (MHz)	Modulation	Conducted		Radiated	
				AVG(dBm)	AVG(mW)	AVG(dBm)	AVG(mW)
LTE13	777~787	5MHz	QPSK	23.75	237.14	20.73	118.30
			16QAM	23.00	199.53	20.02	100.46
		10MHz	QPSK	23.75	237.14	20.41	109.90
			16QAM	23.00	199.53	19.54	89.95

LTE Band 17

FCC Part 27							
Band	Frequency Range(MHz)	BandWidth (MHz)	Modulation	Conducted		Radiated	
				AVG(dBm)	AVG(mW)	AVG(dBm)	AVG(mW)
LTE17	704~716	5MHz	QPSK	24.45	278.61	18.37	68.71
			16QAM	23.58	228.03	17.71	59.02
		10MHz	QPSK	24.46	279.25	17.48	55.98
			16QAM	23.39	218.27	16.60	45.71

LTE Band 41

FCC Part 27							
Band	Frequency Range(MHz)	BandWidth (MHz)	Modulation	Conducted		Radiated	
				AVG(dBm)	AVG(mW)	PEAK(dBm)	PEAK(mW)
LTE41	2496~2690	5MHz	QPSK	19.69	93.11	24.95	312.61
			16QAM	18.59	72.28	24.98	314.77
		10MHz	QPSK	19.68	92.90	24.60	288.40
			16QAM	18.81	76.03	24.68	293.76
		15MHz	QPSK	19.78	95.06	23.29	213.30
			16QAM	18.72	74.47	23.86	243.22
		20MHz	QPSK	19.76	94.62	25.54	358.10
			16QAM	18.65	73.28	25.45	350.75

7. DESCRIPTION OF AVAILABLE ANTENNAS

The radio utilizes a PIFA antenna for the [List the bands supported] with a maximum peak gain as follow:

Frequency (MHz)	Peak Gain (dBi)
GSM850, 824~849MHz	-4.7
GSM1900, 1850~1910MHz	-1.3
WCDMA Band 5, 824~849	-4.7
LTE Band 4, 1710~1755MHz	-2.3
LTE Band 5, 824~849MHz	-4.7
LTE Band 7, 2500~2570MHz	-1.2
LTE Band 12, 699~716MHz	-7.5
LTE Band 13, 777~787MHz	-6.6
LTE Band 17, 704~716MHz	-7.5
LTE Band 41, 2496~2690MHz	-1.9

8. DESCRIPTION OF TEST SETUP

SUPPORT EQUIPMENT

Support Equipment List				
Description	Manufacturer	Model	Serial Number	FCC ID
AC Adapter	SONY	1300-7137.1	4016W40310044	NA
Earphone	SONY	N/A	N/A	N/A

I/O CABLES (CONDUCTED SETUP)

I/O Cable List						
Cable No	Port	# of Identical ports	Connector Type	Serial Type	Cable Length (m)	Remarks
1	RF Out	1	Spectrum Analyzer	Shielded	None	NA
2	Antenna Port	1	EUT	Shielded	0.1m	NA
3	RF In/Out	1	Communication Test Set	Shielded	1m	NA

I/O CABLES (RADIATED SETUP)

I/O Cable List						
Cable No	Port	# of Identical ports	Connector Type	Serial Type	Cable Length (m)	Remarks
1	USB	1	AC Adapter	Un-shielded	1.2m	No
2	Jack	1	Headset	Shielded	1m	No
3	RF In/out	1	Communication Test Set	Un-shielded	2m	Yes

TEST SETUP

The EUT is continuously communicated to the call box during the tests.

SETUP DIAGRAM FOR TESTS (CONDUCTED TEST SETUP)

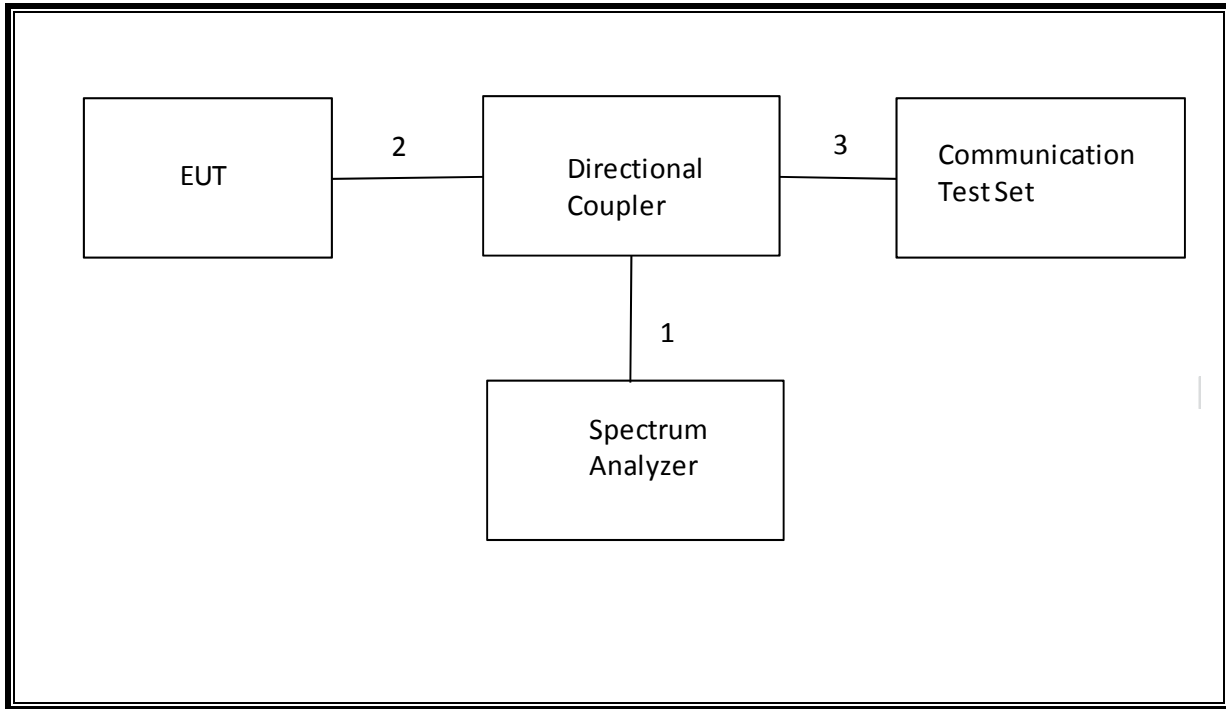

SETUP DIAGRAM FOR TESTS (RADIATED TEST SETUP)

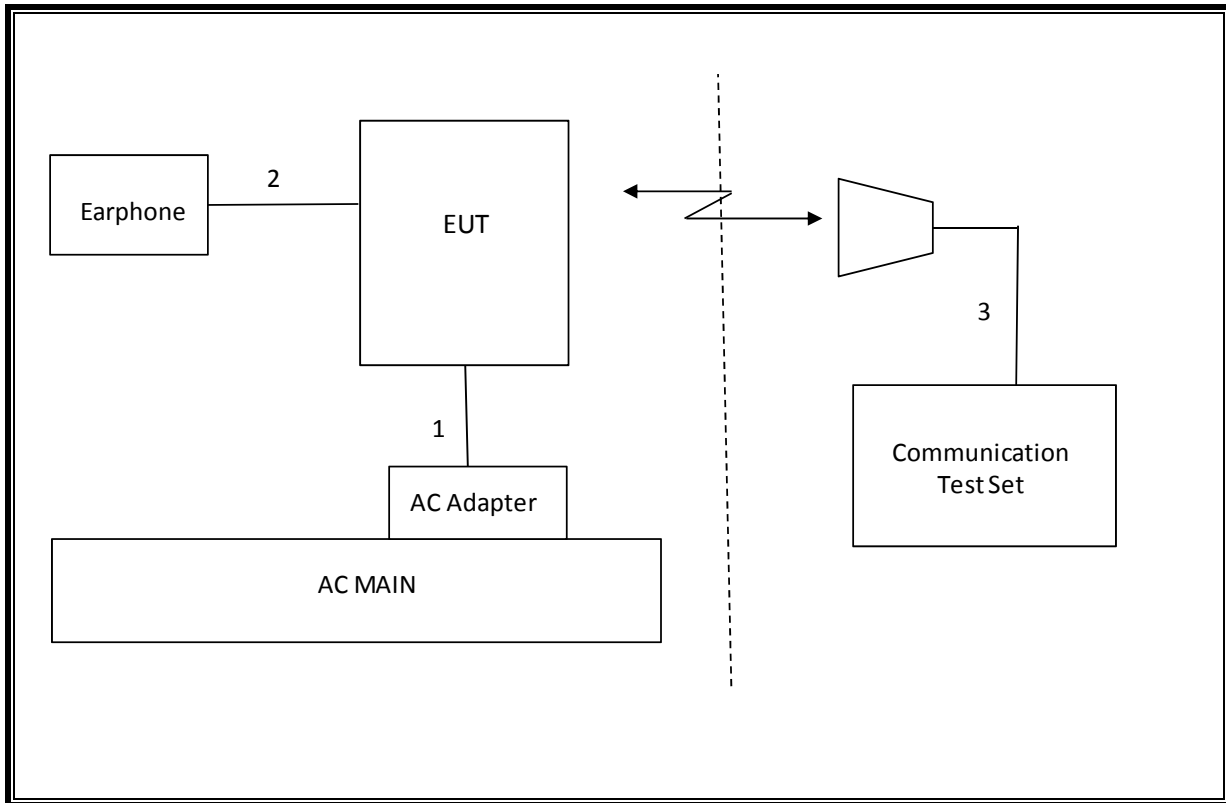

9. TEST AND MEASUREMENT EQUIPMENT

The following test and measurement equipment was utilized for the tests documented in this report:

Test Equipment List					
Description	Manufacturer	Model	T Number	Cal Date	Cal Due
Amplifier, 1 to 18 GHz	Miteq	AFS43-00101800-25-S-42	493	02/15/17	02/15/18
Amplifier, 1 to 8 GHz	Miteq	AMF-4D-01000800-30-29P	1156	02/15/17	02/15/18
Amplifier, 10KHz to 1GHz, 32dB	Keysight	8447D	10	02/15/17	02/15/18
Antenna, Broadband Hybrid, 30MHz to 2000MHz	Sunol Sciences	JB3	477	06/22/16	06/22/17
Spectrum Analyzer, PXA 3Hz to 44GHz	Keysight	N9030A	907	01/23/17	01/23/18
Amplifier, 10KHz to 1GHz, 32dB	Keysight	8447D	10	02/15/17	02/15/18
Antenna, Broadband Hybrid, 30MHz to 2000MHz	Sunol Sciences	JB3	477	06/22/16	06/22/17
Highpass Filter, 2.7 GHz	Micro-Circuits	H2G518G6	T772	7/5/16	7/5/18
Highpass Filter, 1 GHz	Micro-Tronics	HPM18129	T889	2/21/16	2/21/17
Highpass Filter, 4GHz	Micro-Tronics	HPM13351	T1241	7/19/16	7/19/17
Spectrum Analyzer, PXA 3Hz to 44GHz	Keysight	N9030A	907	01/23/17	01/23/18
Amplifier, 1-18GHz	Miteq	AFS42-00101800-25-S-42	931	08/26/16	08/26/17
Amplifier, 1 to 8GHz	Miteq	AMF-4D-01000800-30-29P	1170	04/28/16	04/28/17
Amplifier, 10KHz to 1GHz, 32dB	Keysight	8447D	15	08/26/16	08/26/17
Antenna, Broadband Hybrid 30MHz to 2000MHz	Sunol Sciences	JB3	408	11/10/16	11/10/17
Antenna, Horn 1-18GHz	ETS Lindgren	3117	712	01/30/17	01/30/18
Spectrum Analyzer, PXA, 3Hz to 44GHz	Keysight	N9030A	905	01/11/17	01/11/18
Communications Test Set	R&S	CMW500			
DC power supply, 8 V @ 3 A or 15 V @ 2 A	Agilent / HP	E3610A	None	CNR	None
Antenna, Tuned Dipole 400~1000 MHz	ETS	3121C DB4	T273	5/16/16	5/16/17
Directional Coupler	Mini-Circuits	ZUDC10-183+	T1136	5/25/16	5/25/17

Test Equipment List			
Description	Manufacturer	Model	T Number
Radiated Software	UL	UL EMC	Ver 9.5, June 24, 2015
Conducted Software	UL	UL EMC	Ver 9.5, May 26, 2015
CLT Software	UL	UL RF	Ver 1.0, Feb 2, 2015
Antenna Port Software	UL	UL RF	Ver 3.7, Nov 12, 2015

10. SUMMARY TABLE

FCC Part Section	Test Description	Test Limit	Test Condition	Test Result
2.1049	Occupied Bandwidth (99%)	N/A	Conducted	Pass
22.917(a) 24.238(a) 27.53(g)	Band Edge / Conducted Spurious Emission	-13dBm		Pass
27.53(m)		-25dBm		
2.1046	Conducted output power	N/A		Pass
27.53(m)	Emission Mask			Pass
22.355 24.235 27.54	Frequency Stability	2.5PPM		Pass
22.913(a)(2)	Effective Radiated Power	38dBm	Radiated	Pass
27.50©(10)		34.77dBm		Pass
24.232(c) 27.50(h)(2)	Equivalent Isotropic Radiated Power	33dBm		Pass
27.50(d)(4)		30dBm		Pass
22.917(a) 24.238(a) 27.53(g)	Radiated Spurious Emission	-13dBm		Pass
27.53(m)		-25dBm		Pass

11. RF POWER OUTPUT VERIFICATION

11.1. GSM/GPRS/EDGE

Using CMW500 Communication Test Set

Function: Menu select > GSM Mobile Station > GSM 850/900/1800/1900

Press Connection control to choose the different menus

Press RESET > choose all to reset all settings

Connection Press Signal Off to turn off the signal and change settings
Network Support > GSM+GPRS or GSM+EGPRS
Main Service > Packet Data
Service selection > Test Mode A – Auto Slot Config. off

MS Signal Press Slot Config bottom on the right twice to select and change the number of time slots and power setting
> Slot configuration > Uplink/Gamma
> 33 dBm for GPRS 850/900
> 27 dBm for EGPRS 850/900
> 30 dBm for GPRS1800/1900
> 26 dBm for EGPRS1800/1900

BS Signal Enter the same channel number for TCH channel (test channel) and BCCH channel

Frequency Offset > + 0 Hz
Mode > BCCH and TCH
BCCH Level > -85 dBm (May need to adjust if link is not stable)
BCCH Channel > choose desire test channel [Enter the same channel number for TCH channel (test channel) and BCCH channel]

Channel Type > Off
P0 > 4 dB
Slot Config > Unchanged (if already set under MS Signal)
TCH > choose desired test channel
Hopping > Off
Main Timeslot > 3 (Default)

Network Coding Scheme > CS 4 (GPRS) and MCS5-9 (EGPRS)
Bit Stream > 2E9-1PSR Bit Pattern

AF/RF Enter appropriate offsets for Ext. Att. Output and Ext. Att. Input

Connection Press Signal On to turn on the signal and change settings

11.2. GSM OUTPUT POWER RESULT

Tested By	Coltyce Sanders
Date	3/10/2017

Mode	Coding Scheme	Time Slots	Ch No.	Freq. (MHz)	Burst Pwr (dBm)	Frame Pwr (dBm)
GSM (Voice)	CS4	1	128	824.4	32.5	23.5
			190	836.6	32.7	23.6
			251	848.8	32.6	23.5
GPRS (GMSK)	CS4	1	128	824.4	32.5	23.5
			190	836.6	32.7	23.6
			251	848.8	32.5	23.5
		2	128	824.4	29.6	23.6
			190	836.6	29.6	23.6
			251	848.8	29.5	23.5
		3	128	824.4	27.6	23.3
			190	836.6	27.7	23.5
			251	848.8	27.6	23.4
		4	128	824.4	26.6	23.6
			190	836.6	26.7	23.7
			251	848.8	26.6	23.6
EGPRS (8PSK)	MCS9	1	128	824.4	27.0	18.0
			190	836.6	27.1	18.0
			251	848.8	27.1	18.0
		2	128	824.4	25.5	19.5
			190	836.6	25.5	19.5
			251	848.8	25.5	19.4
		3	128	824.4	23.7	19.5
			190	836.6	23.8	19.5
			251	848.8	23.6	19.3
		4	128	824.4	22.9	19.9
			190	836.6	23.0	20.0
			251	848.8	22.9	19.9

Mode	Coding Scheme	Time Slots	Ch No.	Freq. (MHz)	Burst Pwr (dBm)	Frame Pwr (dBm)
GSM (Voice)	CS4	1	512	1850.2	29.6	20.6
			661	1880.0	29.6	20.6
			810	1909.8	29.8	20.7
GPRS (GMSK)	CS4	1	512	1850.2	29.7	20.6
			661	1880.0	29.6	20.6
			810	1909.8	29.8	20.7
		2	512	1850.2	27.1	21.1
			661	1880.0	27.1	21.1
			810	1909.8	27.2	21.2
		3	512	1850.2	25.0	20.7
			661	1880.0	25.1	20.8
			810	1909.8	25.3	21.0
		4	512	1850.2	24.1	21.1
			661	1880.0	24.1	21.1
			810	1909.8	24.3	21.3
EGPRS (8PSK)	MCS9	1	512	1850.2	25.2	16.2
			661	1880.0	25.2	16.2
			810	1909.8	25.4	16.4
		2	512	1850.2	24.5	18.5
			661	1880.0	24.4	18.4
			810	1909.8	24.6	18.6
		3	512	1850.2	22.1	17.8
			661	1880.0	22.0	17.7
			810	1909.8	22.3	18.0
		4	512	1850.2	21.0	18.0
			661	1880.0	20.9	17.9
			810	1909.8	21.2	18.2

11.3. UMTS REL 99

TEST PROCEDURE

The following summary of these settings are illustrated below:

	Mode	Rel99
	Subtest	-
WCDMA General Settings	Loopback Mode	Test Mode 2
	Rel99 RMC	12.2kbps RMC
	HSDPA FRC	Not Applicable
	HSUPA Test	Not Applicable
	Power Control Algorithm	Algorithm2
	β_c	Not Applicable
	β_d	Not Applicable
	β_{ec}	Not Applicable
	β_c/β_d	8/15
	β_{hs}	Not Applicable
	β_{ed}	Not Applicable

RESULTS

11.4. UMTS REL 99 OUTPUT POWER RESULT

Tested By	Coltyce Sanders
Date	3/10/2017

Mode		UL Ch No.	Freq. (MHz)	MPR	Avg Pwr (dBm)
Release 99	Rel 99 (RMC, 12.2 kbps)	4132	826.4	0	24.2
		4183	836.6	0	24.1
		4233	846.6	0	24.2

11.5. UMTS HSDPA

The following 4 Sub-tests were completed according to Release 5 procedures in section 5.2 of 3GPP TS34.121.

Summary of settings are illustrated below:

	Mode	Rel5 HSDPA			
	Subtest	1	2	3	4
WCDMA General Settings	Loopback Mode	Test Mode 1			
	Rel99 RMC	12.2kbps RMC			
	HSDPA FRC	H-Set1			
	Power Control Algorithm	Algorithm 2			
	β_c	2/15	11/15	15/15	15/15
	β_d	15/15	15/15	8/15	4/15
	Bd (SF)	64			
	β_c/β_d	2/15	11/15	15/8	15/4
	β_{hs}	4/15	24/15	30/15	30/15
MPR (dB)	0	0	0.5	0.5	
HSDPA Specific Settings	D_{ACK}	8			
	D_{NAK}	8			
	DCQI	8			
	Ack-Nack repetition factor	3			
	CQI Feedback (Table 5.2B.4)	4ms			
	CQI Repetition Factor (Table 5.2B.4)	2			
	$A_{hs} = \beta_{hs}/\beta_c$	30/15			

RESULTS

11.6. UMTS HSDPA OUTPUT POWER RESULT

Tested By	Coltyce Sanders
Date	3/10/2017

Mode		UL Ch No.	Freq. (MHz)	MPR	Avg Pwr (dBm)
HSDPA	Subtest 1	4132	826.4	0	23.0
		4183	836.6	0	23.1
		4233	846.6	0	23.1
	Subtest 2	4132	826.4	0	23.0
		4183	836.6	0	23.1
		4233	846.6	0	23.1
	Subtest 3	4132	826.4	0.5	22.5
		4183	836.6	0.5	22.6
		4233	846.6	0.5	22.5
	Subtest 4	4132	826.4	0.5	22.5
		4183	836.6	0.5	22.6
		4233	846.6	0.5	22.5

11.7. UMTS HSUPA

The following 4 Sub-tests were completed according to Release 6 procedures in section 5.2 of 3GPP TS34.121.

Summary of settings are illustrated below:

	Mode	Rel6 HSUPA	Rel6 HSUPA	Rel6 HSUPA	Rel6 HSUPA	Rel6 HSUPA
	Subtest	1	2	3	4	5
WCDMA General Settings	Loopback Mode	Test Mode 1				
	P-CPICH (dB)	-10				
	P-CCPCH (dB)	-12				
	SCH (dB)	-12				
	PICH(dB)	-15				
	DPCH (dB)	-9				
	HS-SCCH_1 (dB)	-8				
	HS-PDSCH (dB)	-3				
	Rel99 RMC	12.2kbps RMC				
	HSDPA FRC	H-Set1				
	HSUPA Test	HSUPA Loopback				
	Power Control Algorithm	Algorithm2				
	Bc	11/15	6/15	15/15	2/15	15/15
	Bd	15/15	15/15	9/15	15/15	15/15
	Bec	209/225	12/15	30/15	2/15	5/15
	β_c/β_d	11/15	6/15	15/9	2/15	15/15
	Bhs	22/15	12/15	30/15	4/15	30/15
β_{ed} (note1)	1309/225	94/75	47/15 47/15	56/75	134/15	
MPR	0	2	1	2	0	
HSDPA Specific Settings	DACK	8				
	DNAK	8				
	DCQI	8				
	Ack-Nack repetition factor	3				
	CQI Feedback (Table 5.2B.4)	4ms				
	CQI Repetition Factor (Table 5.2B.4)	2				
	Ahs = β_{hs}/β_c	30/15				
HSUPA Specific Settings	D E-DPCCH	6	8	8	5	7
	DHARQ	0	0	0	0	0
	AG Index	20	12	15	17	21
	Reference E-TFCIs	5	5	2	5	5
	ETFCI (from 34.121 Table C.11.1.3)	75	67	92	71	81
	Associated Max UL Data Rate kbps	242.1	174.9	482.8	205.8	308.9
	Reference E_TFCIs	E-TFCI 11 E-TFCI PO 4 E-TFCI 67 E-TFCI PO 18 E-TFCI 71 E-TFCI PO 23 E-TFCI 75 E-TFCI PO 26 E-TFCI 81 E-TFCI PO 27		E-TFCI 11 E-TFCI PO 4 E-TFCI 92 E-TFCI PO 18		E-TFCI 11 E-TFCI PO 4 E-TFCI 67 E-TFCI PO 18 E-TFCI 71 E-TFCI PO 23 E-TFCI 75 E-TFCI PO 26 E-TFCI 81 E-TFCI PO 27

Note1: β_{ed} cannot be set directly, it is set by Absolute Grant Value.

RESULT

11.8. UMTS HSUPA OUTPUT POWER RESULT

Mode		UL Ch No.	Freq. (MHz)	MPR	Avg Pwr (dBm)
HSUPA	Subtest 1	4132	826.4	0	23.0
		4183	836.6	0	23.0
		4233	846.6	0	23.1
	Subtest 2	4132	826.4	2	21.0
		4183	836.6	2	21.1
		4233	846.6	2	21.1
	Subtest 3	4132	826.4	1	22.0
		4183	836.6	1	22.1
		4233	846.6	1	22.1
	Subtest 4	4132	826.4	2	21.0
		4183	836.6	2	21.1
		4233	846.6	2	21.1
	Subtest 5	4132	826.4	0	23.0
		4183	836.6	0	23.0
		4233	846.6	0	23.1

11.9. LTE OUTPUT POWER RESULT

Note(s):

LTE Band 38 Measured Results

LTE Band 38 (Frequency range: 2570-2620 MHz) is covered by LTE Band 41 (Frequency range: 2496-2690 MHz) and no testing is necessary due to overlapping frequency range, same maximum tune-up limit and same channel bandwidth and same modulations.

Tested By	Jason/Remi
Date	3/6/2017

LTE Band 4

Band	BW (MHz)	Mode	RB Allocation	RB offset	MPR	Avg Pwr (dBm)		
						19957	20175	20393
						1710.7 MHz	1732.5 MHz	1754.3 MHz
LTE Band 4	1.4	QPSK	1	0	0	21.55	21.24	21.32
			1	3	0	21.60	21.28	21.40
			1	5	0	21.56	21.25	21.29
			3	0	0	21.60	21.26	21.42
			3	1	0	21.65	21.28	21.42
			3	3	0	21.64	21.28	21.54
		16QAM	6	0	1	20.54	20.24	20.44
			1	0	1	20.71	20.60	20.48
			1	3	1	20.76	20.66	20.56
			1	5	1	20.71	20.60	20.50
			3	0	1	20.67	20.46	20.66
			3	1	1	20.68	20.48	20.71
			3	3	1	20.70	20.46	20.70
			6	0	2	19.72	19.17	19.61
Band	BW (MHz)	Mode	RB Allocation	RB offset	MPR	Avg Pwr (dBm)		
						19965	20175	20385
						1711.5 MHz	1732.5 MHz	1753.5 MHz
LTE Band 4	3	QPSK	1	0	0	21.54	21.35	21.47
			1	8	0	21.60	21.39	21.54
			1	14	0	21.50	21.28	21.40
			8	0	1	20.66	20.34	20.44
			8	4	1	20.68	20.35	20.41
			8	7	1	20.68	20.37	20.47
			15	0	1	20.64	20.33	20.46
		16QAM	1	0	1	20.60	20.73	20.52
			1	8	1	20.67	20.78	20.55
			1	14	1	20.54	20.68	20.43
			8	0	2	19.79	19.23	19.63
			8	4	2	19.77	19.25	19.66
			8	7	2	19.75	19.25	19.65
			15	0	2	19.70	19.37	19.40

Band	BW (MHz)	Mode	RB Allocation	RB offset	MPR	Avg Pwr (dBm)		
						19975	20175	20375
						1712.5 MHz	1732.5 MHz	1752.5 MHz
LTE Band 4	5	QPSK	1	0	0	21.95	21.71	21.79
			1	12	0	21.87	21.58	21.68
			1	24	0	21.86	21.50	21.79
			12	0	1	20.87	20.63	20.82
			12	7	1	20.90	20.59	20.81
			12	13	1	20.88	20.56	20.81
			25	0	1	20.91	20.56	20.82
		16QAM	1	0	1	21.00	20.83	21.00
			1	12	1	21.00	20.72	21.00
			1	24	1	20.99	20.75	21.00
			12	0	2	20.00	19.72	19.99
			12	7	2	19.95	19.69	19.97
			12	13	2	19.94	19.65	19.96
			25	0	2	19.87	19.59	19.85
Band	BW (MHz)	Mode	RB Allocation	RB offset	MPR	Avg Pwr (dBm)		
						20000	20175	20350
						1715 MHz	1732.5 MHz	1750 MHz
LTE Band 4	10	QPSK	1	0	0	21.87	21.76	21.78
			1	25	0	21.74	21.57	21.64
			1	49	0	21.68	21.48	21.63
			25	0	1	20.84	20.64	20.74
			25	12	1	20.81	20.64	20.72
			25	25	1	20.79	20.58	20.70
			50	0	1	20.83	20.62	20.72
		16QAM	1	0	1	21.00	20.74	20.74
			1	25	1	21.00	20.59	20.61
			1	49	1	21.00	20.52	20.55
			25	0	2	19.91	19.75	19.80
			25	12	2	19.85	19.74	19.77
			25	25	2	19.82	19.68	19.72
			50	0	2	19.81	19.65	19.75

Band	BW (MHz)	Mode	RB Allocation	RB offset	MPR	Avg Pwr (dBm)		
						20025	20175	20325
						1717.5 MHz	1732.5 MHz	1747.5 MHz
LTE Band 4	15	QPSK	1	0	0	21.68	21.88	21.80
			1	37	0	21.53	21.54	21.56
			1	74	0	21.48	21.52	21.55
			36	0	1	20.66	20.69	20.75
			36	20	1	20.58	20.65	20.67
			36	39	1	20.51	20.62	20.63
			75	0	1	20.59	20.60	20.66
		16QAM	1	0	1	21.00	20.69	21.00
			1	37	1	20.94	20.52	21.00
			1	74	1	20.80	20.44	20.93
			36	0	2	19.64	19.70	19.81
			36	20	2	19.60	19.64	19.75
			36	39	2	19.55	19.61	19.66
			75	0	2	19.59	19.63	19.69
Band	BW (MHz)	Mode	RB Allocation	RB offset	MPR	Avg Pwr (dBm)		
						20050	20175	20300
						1720 MHz	1732.5 MHz	1745 MHz
LTE Band 4	20	QPSK	1	0	0		21.80	
			1	49	0		21.56	
			1	99	0		21.46	
			50	0	1		20.73	
			50	24	1		20.65	
			50	50	1		20.59	
			100	0	1		20.65	
		16QAM	1	0	1		21.00	
			1	49	1		21.00	
			1	99	1		21.00	
			50	0	2		19.77	
			50	24	2		19.67	
			50	50	2		19.57	
			100	0	2		19.67	

Tested By	Florencio Pesigan
Date	3/6/2017

LTE Band 5

Band	BW (MHz)	Mode	RB Allocation	RB offset	MPR	Avg Pwr (dBm)		
						20407	20525	20643
						824.7 MHz	836.5 MHz	848.3 MHz
LTE Band 5	1.4	QPSK	1	0	0	23.63	23.72	23.57
			1	3	0	23.67	23.77	23.64
			1	5	0	23.60	23.70	23.57
			3	0	0	23.66	23.74	23.64
			3	1	0	23.70	23.75	23.68
			3	3	0	23.68	23.77	23.68
		16QAM	6	0	1	22.63	22.68	22.59
			1	0	1	22.79	23.00	22.64
			1	3	1	22.81	23.00	22.68
			1	5	1	22.76	23.00	22.63
			3	0	1	22.70	22.95	22.78
			3	1	1	22.74	22.99	22.82
			3	3	1	22.73	22.96	22.83
			6	0	2	21.80	21.62	21.78
Band	BW (MHz)	Mode	RB Allocation	RB offset	MPR	Avg Pwr (dBm)		
						20415	20525	20635
						825.5 MHz	836.5 MHz	847.5 MHz
LTE Band 5	3	QPSK	1	0	0	23.69	23.81	23.69
			1	8	0	23.73	23.86	23.74
			1	14	0	23.59	23.76	23.60
			8	0	1	22.69	22.76	22.73
			8	4	1	22.69	22.77	22.68
			8	7	1	22.71	22.74	22.69
		16QAM	15	0	1	22.68	22.75	22.69
			1	0	1	22.60	23.00	22.77
			1	8	1	22.66	23.00	22.80
			1	14	1	22.51	23.00	22.67
			8	0	2	21.82	21.69	21.90
			8	4	2	21.82	21.68	21.91
			8	7	2	21.81	21.65	21.90
			15	0	2	21.73	21.80	21.62

Band	BW (MHz)	Mode	RB Allocation	RB offset	MPR	Avg Pwr (dBm)		
						20425	20525	20625
						826.5 MHz	836.5 MHz	846.5 MHz
LTE Band 5	5	QPSK	1	0	0	23.86	23.87	23.76
			1	12	0	23.80	23.77	23.67
			1	24	0	23.75	23.78	23.62
			12	0	1	22.80	22.79	22.73
			12	7	1	22.79	22.74	22.73
			12	13	1	22.75	22.72	22.70
		16QAM	1	0	1	23.00	23.00	22.90
			1	12	1	22.96	23.00	22.80
			1	24	1	22.95	23.00	22.78
			12	0	2	21.89	21.93	21.84
			12	7	2	21.90	21.93	21.80
			12	13	2	21.85	21.90	21.76
			25	0	2	21.79	21.82	21.70
			25	0	2	21.79	21.82	21.70
Band	BW (MHz)	Mode	RB Allocation	RB offset	MPR	Avg Pwr (dBm)		
						20450	20525	20600
						829 MHz	836.5 MHz	844 MHz
LTE Band 5	10	QPSK	1	0	0	23.86	23.82	23.80
			1	25	0	23.75	23.73	23.70
			1	49	0	23.65	23.60	23.57
			25	0	1	22.80	22.79	22.82
			25	12	1	22.79	22.78	22.78
			25	25	1	22.70	22.73	22.68
			50	0	1	22.75	22.75	22.74
		16QAM	1	0	1	22.90	22.79	23.00
			1	25	1	22.79	22.68	23.00
			1	49	1	22.69	22.58	22.97
			25	0	2	21.92	21.84	21.87
			25	12	2	21.87	21.81	21.82
			25	25	2	21.82	21.75	21.74
			50	0	2	21.82	21.75	21.77

Tested By	Florencio Pesigan
Date	3/7/2017

LTE Band 7

Band	BW (MHz)	Mode	RB Allocation	RB offset	MPR	Avg Pwr (dBm)		
						20775	21100	21425
						2502.5 MHz	2535 MHz	2567.5 MHz
	5	QPSK	1	0	0	19.41	19.61	19.72
			1	12	0	19.43	19.52	19.75
			1	24	0	19.40	19.47	19.77
			12	0	1	18.46	18.60	18.83
			12	7	1	18.47	18.57	18.85
			12	13	1	18.46	18.55	18.86
		16QAM	25	0	1	18.44	18.58	18.82
			1	0	1	18.61	19.00	18.90
			1	12	1	18.63	19.00	18.89
			1	24	1	18.62	18.96	18.93
			12	0	2	17.52	17.78	17.88
			12	7	2	17.57	17.76	17.92
			12	13	2	17.54	17.69	17.89
			25	0	2	17.49	17.62	17.78
Band	BW (MHz)	Mode	RB Allocation	RB offset	MPR	Avg Pwr (dBm)		
						20800	21100	21400
						2505 MHz	2535 MHz	2565 MHz
LTE Band 7	10	QPSK	1	0	0	19.94	19.69	19.66
			1	25	0	20.00	19.49	19.67
			1	49	0	19.99	19.37	19.74
			25	0	1	19.00	18.65	18.70
			25	12	1	19.00	18.62	18.76
			25	25	1	19.00	18.53	18.79
		16QAM	50	0	1	19.00	18.58	18.77
			1	0	1	19.00	19.00	18.69
			1	25	1	18.96	18.85	18.72
			1	49	1	18.92	18.74	18.79
			25	0	2	18.00	17.68	17.83
			25	12	2	18.00	17.64	17.86
			25	25	2	18.00	17.56	17.87
			50	0	2	18.00	17.63	17.80

Band	BW (MHz)	Mode	RB Allocation	RB offset	MPR	Avg Pwr (dBm)		
						20825	21100	21375
						2507.5 MHz	2535 MHz	2562.5 MHz
LTE Band 7	15	QPSK	1	0	0	19.99	19.76	19.86
			1	37	0	19.90	19.45	19.88
			1	74	0	19.76	19.29	20.00
			36	0	1	19.00	18.69	18.96
			36	20	1	19.00	18.63	18.97
			36	39	1	18.97	18.52	18.99
			75	0	1	18.98	18.58	18.96
		16QAM	1	0	1	18.96	19.00	19.00
			1	37	1	18.84	18.87	18.92
			1	74	1	18.71	18.69	19.00
			36	0	2	18.00	17.80	17.91
			36	20	2	18.00	17.68	17.97
			36	39	2	17.96	17.52	17.99
			75	0	2	18.00	17.61	17.99
Band	BW (MHz)	Mode	RB Allocation	RB offset	MPR	Avg Pwr (dBm)		
						20850	21100	21350
						2510 MHz	2535 MHz	2560 MHz
LTE Band 7	20	QPSK	1	0	0	19.95	19.93	19.44
			1	49	0	19.77	19.56	19.33
			1	99	0	19.54	19.33	19.53
			50	0	1	18.93	18.79	18.49
			50	24	1	18.87	18.61	18.53
			50	50	1	18.73	18.50	18.58
			100	0	1	18.77	18.63	18.56
		16QAM	1	0	1	19.00	19.00	18.87
			1	49	1	18.89	18.98	18.77
			1	99	1	19.00	18.75	18.96
			50	0	2	17.92	17.79	17.49
			50	24	2	17.86	17.64	17.53
			50	50	2	17.72	17.49	17.56
			100	0	2	17.85	17.62	17.53

Tested By	Florencio Pesigan
Date	3/6/2017

LTE Band 12

Band	BW (MHz)	Mode	RB Allocation	RB offset	MPR	Avg Pwr (dBm)		
						23017	23095	23173
						699.7 MHz	707.5 MHz	715.3 MHz
LTE Band 12	1.4	QPSK	1	0	0	24.76	24.63	24.68
			1	3	0	24.73	24.68	24.61
			1	5	0	24.64	24.61	24.27
			3	0	0	24.73	24.71	24.60
			3	1	0	24.78	24.73	24.58
			3	3	0	24.78	24.74	24.45
		16QAM	6	0	1	23.68	23.69	23.73
			1	0	1	23.69	23.76	24.00
			1	3	1	23.76	23.80	24.00
			1	5	1	23.72	23.74	23.72
			3	0	1	23.87	23.78	23.81
			3	1	1	23.90	23.82	23.80
			3	3	1	23.90	23.80	23.77
			6	0	2	22.88	22.82	22.65
Band	BW (MHz)	Mode	RB Allocation	RB offset	MPR	Avg Pwr (dBm)		
						23025	23095	23165
						700.5 MHz	707.5 MHz	714.5 MHz
LTE Band 12	3	QPSK	1	0	0	24.75	24.75	24.85
			1	8	0	24.83	24.80	24.89
			1	14	0	24.69	24.66	24.29
			8	0	1	23.77	23.76	23.90
			8	4	1	23.78	23.78	23.89
			8	7	1	23.79	23.76	23.89
		16QAM	15	0	1	23.75	23.75	23.86
			1	0	1	23.81	23.64	24.00
			1	8	1	23.87	23.71	24.00
			1	14	1	23.72	23.56	23.84
			8	0	2	22.97	22.88	22.79
			8	4	2	22.97	22.86	22.79
			8	7	2	22.97	22.86	22.78
			15	0	2	22.72	22.80	22.89

Band	BW (MHz)	Mode	RB Allocation	RB offset	MPR	Avg Pwr (dBm)		
						23035	23095	23155
						701.5 MHz	707.5 MHz	713.5 MHz
LTE Band 12	5	QPSK	1	0	0	24.77	24.79	24.78
			1	12	0	24.69	24.70	24.72
			1	24	0	24.63	24.70	24.34
			12	0	1	23.76	23.78	23.79
			12	7	1	23.76	23.79	23.79
			12	13	1	23.73	23.76	23.77
			25	0	1	23.73	23.75	23.76
		16QAM	1	0	1	23.96	24.00	23.94
			1	12	1	23.87	24.00	23.85
			1	24	1	23.87	24.00	23.59
			12	0	2	22.84	22.93	22.87
			12	7	2	22.85	22.92	22.84
			12	13	2	22.81	22.89	22.81
			25	0	2	22.77	22.83	22.74
Band	BW (MHz)	Mode	RB Allocation	RB offset	MPR	Avg Pwr (dBm)		
						23060	23095	23130
						704 MHz	707.5 MHz	711 MHz
LTE Band 12	10	QPSK	1	0	0	24.85	24.81	24.84
			1	25	0	24.74	24.71	24.76
			1	49	0	24.65	24.60	24.47
			25	0	1	23.87	23.81	23.85
			25	12	1	23.83	23.79	23.83
			25	25	1	23.75	23.71	23.77
			50	0	1	23.80	23.76	23.81
		16QAM	1	0	1	23.75	24.00	23.88
			1	25	1	23.66	24.00	23.81
			1	49	1	23.54	23.98	23.56
			25	0	2	22.87	22.84	22.94
			25	12	2	22.84	22.81	22.91
			25	25	2	22.78	22.77	22.84
			50	0	2	22.81	22.79	22.84

Tested By	Florencio Pesigan
Date	3/6/2017

LTE Band 13

Band	BW (MHz)	Mode	RB Allocation	RB offset	MPR	Avg Pwr (dBm)
						23230
						782 MHz
LTE Band 13	5	QPSK	1	0	0	23.75
			1	12	0	23.64
			1	24	0	23.62
			12	0	1	22.70
			12	7	1	22.68
			12	13	1	22.65
			25	0	1	22.66
		16QAM	1	0	1	23.00
			1	12	1	23.00
			1	24	1	23.00
			12	0	2	21.87
			12	7	2	21.84
			12	13	2	21.82
			25	0	2	21.74
Band	BW (MHz)	Mode	RB Allocation	RB offset	MPR	Avg Pwr (dBm)
						23230
						782 MHz
LTE Band 13	10	QPSK	1	0	0	23.75
			1	25	0	23.64
			1	49	0	23.52
			25	0	1	22.75
			25	12	1	22.71
			25	25	1	22.65
			50	0	1	21.43
		16QAM	1	0	1	23.00
			1	25	1	23.00
			1	49	1	22.91
			25	0	2	21.79
			25	12	2	21.74
			25	25	2	21.66
			50	0	2	21.71

Tested By	Vanessa Moestopo
Date	3/14/2017

LTE Band 17

Band	BW (MHz)	Mode	RB Allocation	RB offset	MPR	Avg Pwr (dBm)
						23790
						710 MHz
LTE Band 17	5	QPSK	1	0	0	24.45
			1	12	0	24.39
			1	24	0	24.36
			12	0	1	23.46
			12	7	1	23.46
			12	13	1	23.41
		16QAM	25	0	1	23.45
			1	0	1	23.58
			1	12	1	23.51
			1	24	1	23.51
			12	0	2	22.54
			12	7	2	22.52
			12	13	2	22.49
			25	0	2	22.41
Band	BW (MHz)	Mode	RB Allocation	RB offset	MPR	Avg Pwr (dBm)
						23790
						710 MHz
LTE Band 17	10	QPSK	1	0	0	24.46
			1	25	0	24.35
			1	49	0	24.27
			25	0	1	23.47
			25	12	1	23.45
			25	25	1	23.36
		16QAM	50	0	1	23.43
			1	0	1	23.39
			1	25	1	23.29
			1	49	1	23.19
			25	0	2	22.48
			25	12	2	22.48
			25	25	2	22.42
			50	0	2	22.42

Tested By	Krischelle Aurelio
Date	3/10/2017

LTE Band 41

Band	BW (MHz)	Mode	RB Allocation	RB offset	MPR	Avg Pwr (dBm)				
						39750	40185	40620	41055	41490
						2506 MHz	2549.5 MHz	2593 MHz	2636.5 MHz	2680 MHz
LTE Band 41	5	QPSK	1	0	0	19.65	19.45	19.40	19.69	19.43
			1	12	0	19.62	19.42	19.33	19.66	19.40
			1	24	0	19.54	19.35	19.31	19.62	19.36
			12	0	1	18.61	18.39	18.39	18.64	18.47
			12	7	1	18.62	18.42	18.42	18.68	18.46
			12	13	1	18.58	18.41	18.39	18.67	18.45
			25	0	1	18.53	18.39	18.37	18.64	18.45
		16QAM	1	0	1	18.46	18.29	18.35	18.59	18.50
			1	12	1	18.43	18.24	18.30	18.59	18.51
			1	24	1	18.41	18.22	18.28	18.57	18.47
			12	0	2	17.58	17.40	17.37	17.61	17.51
			12	7	2	17.63	17.42	17.38	17.67	17.54
			12	13	2	17.54	17.39	17.33	17.63	17.47
			25	0	2	17.59	17.41	17.40	17.68	17.46
Band	BW (MHz)	Mode	RB Allocation	RB offset	MPR	Avg Pwr (dBm)				
						39750	40185	40620	41055	41490
						2506 MHz	2549.5 MHz	2593 MHz	2636.5 MHz	2680 MHz
LTE Band 41	10	QPSK	1	0	0	19.63	19.48	19.42	19.68	19.53
			1	25	0	19.55	19.36	19.28	19.62	19.45
			1	49	0	19.52	19.31	19.24	19.63	19.40
			25	0	1	18.65	18.47	18.42	18.69	18.52
			25	12	1	18.62	18.46	18.38	18.67	18.46
			25	25	1	18.57	18.40	18.36	18.63	18.47
			50	0	1	18.60	18.41	18.39	18.63	18.49
		16QAM	1	0	1	18.76	18.44	18.33	18.81	18.52
			1	25	1	18.69	18.34	18.20	18.73	18.39
			1	49	1	18.62	18.28	18.16	18.75	18.34
			25	0	2	17.64	17.45	17.43	17.68	17.51
			25	12	2	17.63	17.43	17.37	17.69	17.48
			25	25	2	17.56	17.38	17.34	17.63	17.45
			50	0	2	17.62	17.43	17.38	17.70	17.51

Band	BW (MHz)	Mode	RB Allocation	RB offset	MPR	Avg Pwr (dBm)				
						39750	40185	40620	41055	41490
						2506 MHz	2549.5 MHz	2593 MHz	2636.5 MHz	2680 MHz
LTE Band 41	15	QPSK	1	0	0	19.67	19.62	19.61	19.78	19.38
			1	37	0	19.47	19.43	19.30	19.61	19.15
			1	74	0	19.41	19.35	19.27	19.62	19.08
			36	0	1	18.62	18.56	18.39	18.72	18.40
			36	20	1	18.57	18.53	18.37	18.66	18.37
			36	39	1	18.50	18.48	18.29	18.64	18.30
			75	0	1	18.54	18.52	18.33	18.64	18.37
		16QAM	1	0	1	18.59	18.55	18.44	18.72	18.51
			1	37	1	18.43	18.39	18.23	18.59	18.31
			1	74	1	18.35	18.31	18.15	18.57	18.23
			36	0	2	17.59	17.56	17.42	17.66	17.42
			36	20	2	17.55	17.52	17.36	17.65	17.38
			36	39	2	17.49	17.45	17.28	17.62	17.30
			75	0	2	17.56	17.50	17.34	17.69	17.37
Band	BW (MHz)	Mode	RB Allocation	RB offset	MPR	Avg Pwr (dBm)				
						39750	40185	40620	41055	41490
						2506 MHz	2549.5 MHz	2593 MHz	2636.5 MHz	2680 MHz
LTE Band 41	20	QPSK	1	0	0	19.73	19.62	19.57	19.76	19.55
			1	49	0	19.50	19.41	19.28	19.55	19.32
			1	99	0	19.40	19.31	19.19	19.55	19.20
			50	0	1	18.62	18.56	18.46	18.71	18.45
			50	24	1	18.54	18.46	18.37	18.65	18.37
			50	50	1	18.43	18.39	18.26	18.57	18.31
			100	0	1	18.56	18.49	18.37	18.62	18.34
		16QAM	1	0	1	18.64	18.58	18.37	18.65	18.64
			1	49	1	18.42	18.33	18.10	18.45	18.40
			1	99	1	18.33	18.23	17.98	18.40	18.31
			50	0	2	17.59	17.52	17.46	17.70	17.50
			50	24	2	17.51	17.42	17.39	17.63	17.43
			50	50	2	17.44	17.36	17.27	17.61	17.30
			100	0	2	17.53	17.41	17.38	17.66	17.38

12. PEAK TO AVERAGE RATIO

TEST PROCEDURE

Per KDB 971168 D01 Power Meas License Digital Systems v02r02

TEST SPEC

In addition, when the transmitter power is measured in terms of average value, the peak-to-average ratio of the power shall not exceed 13 dB.

12.1. CONDUCTED PEAK TO AVERAGE RESULT

GSM

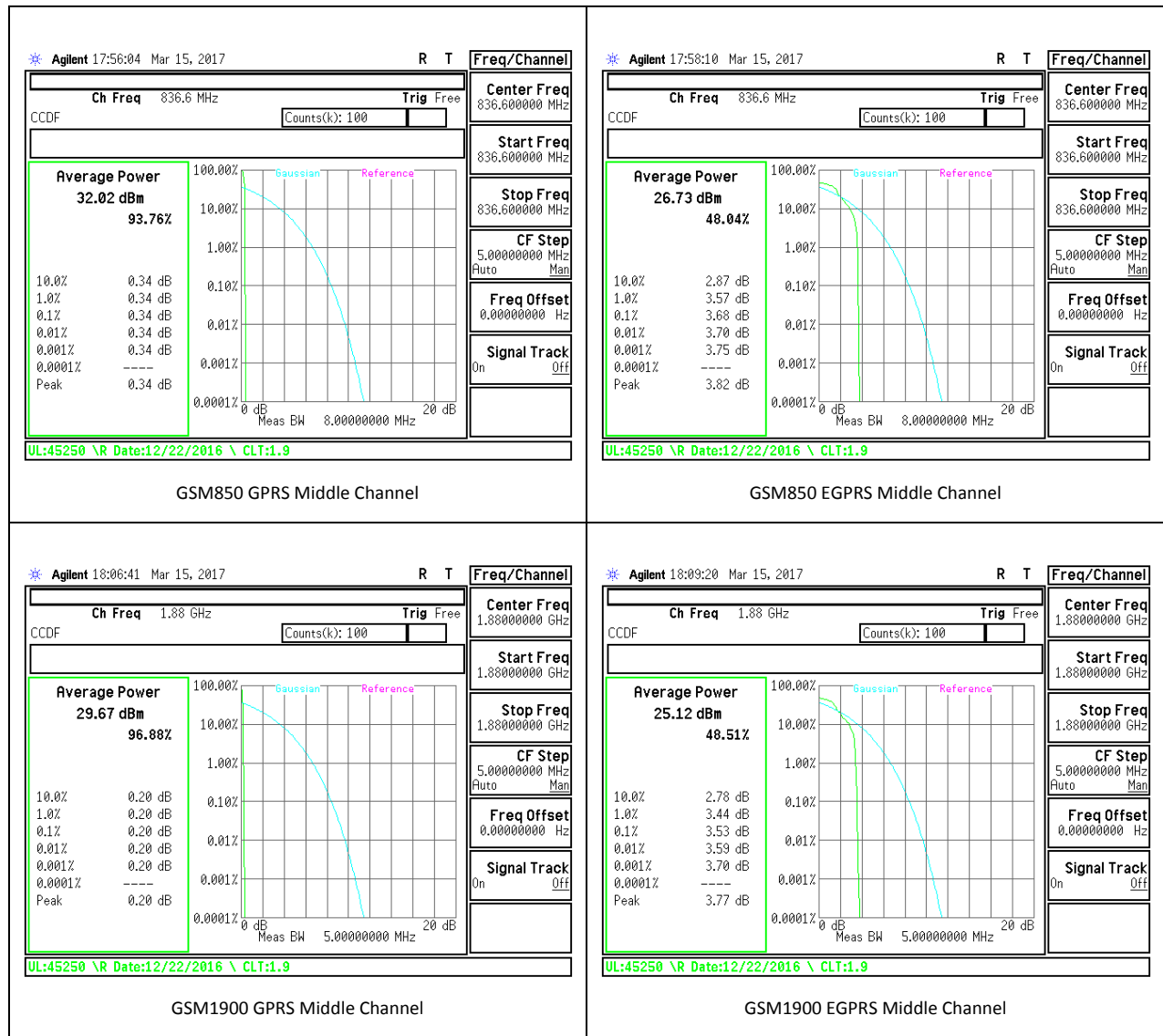

WCDMA

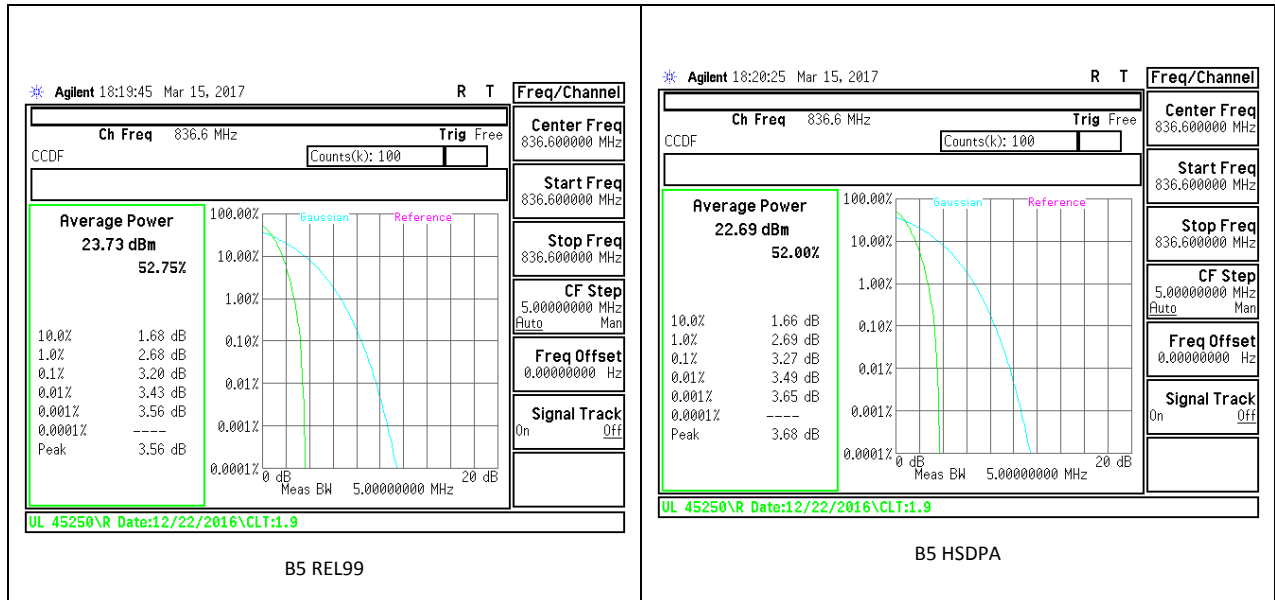

LTE Band 4

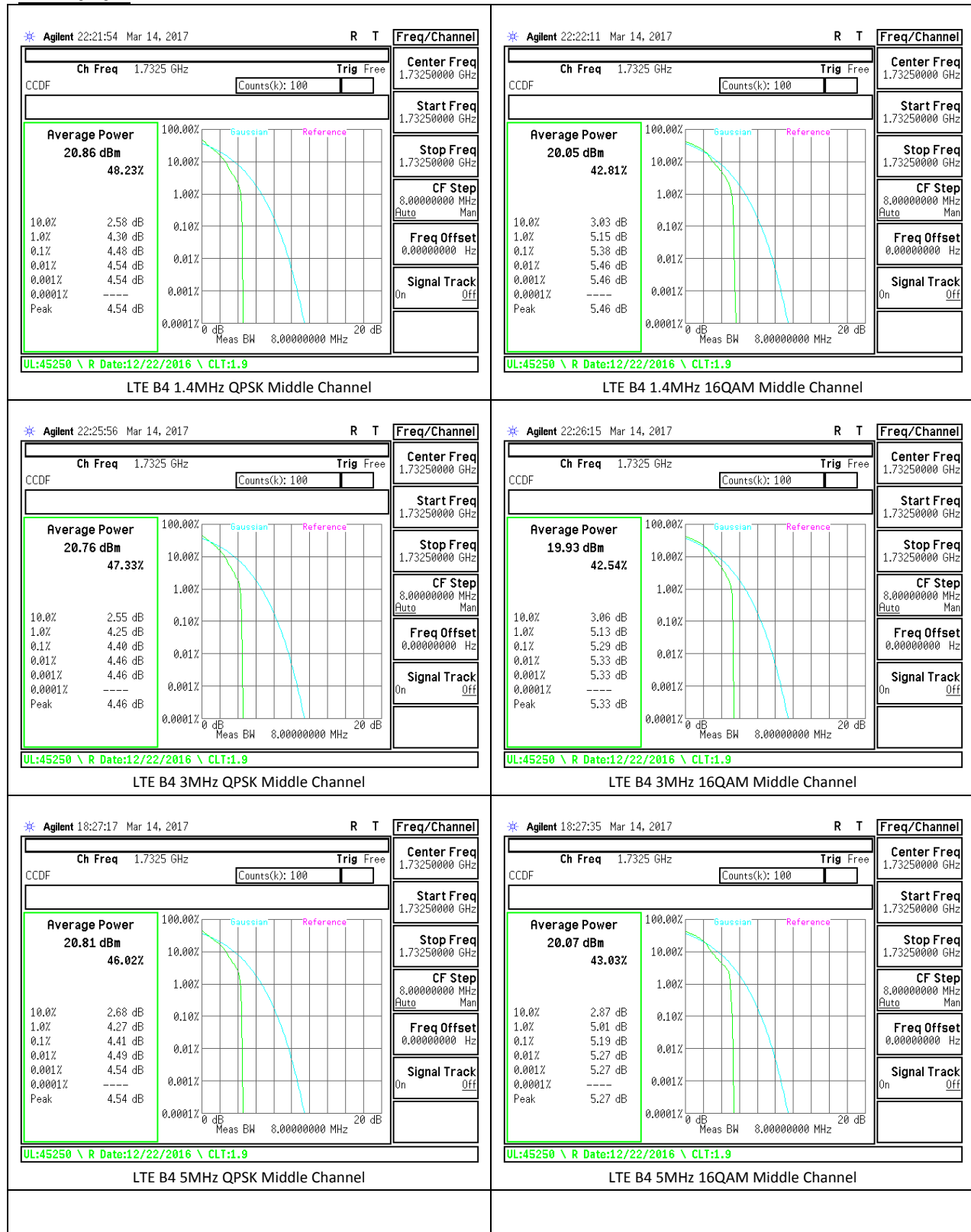

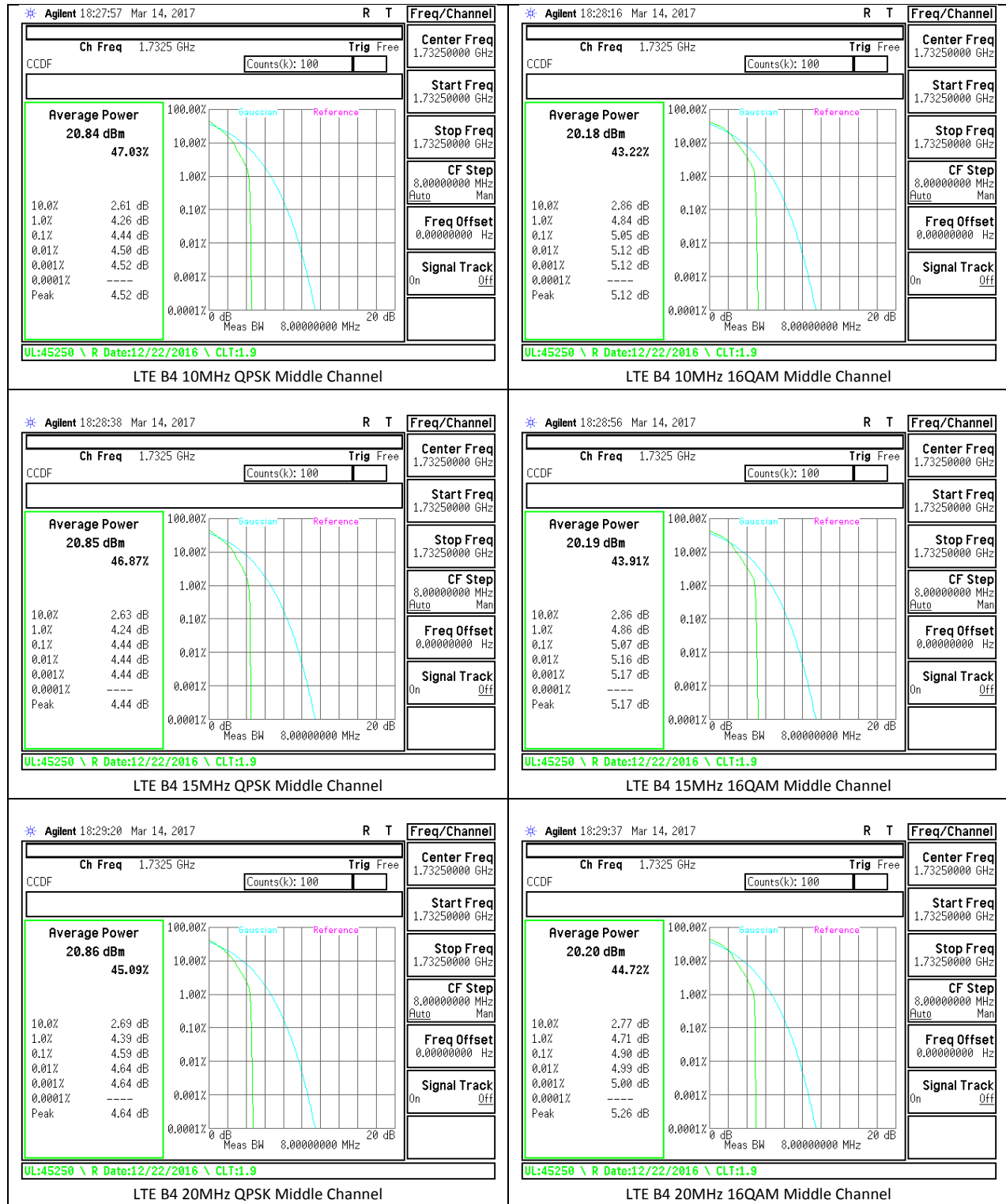

LTE Band 5

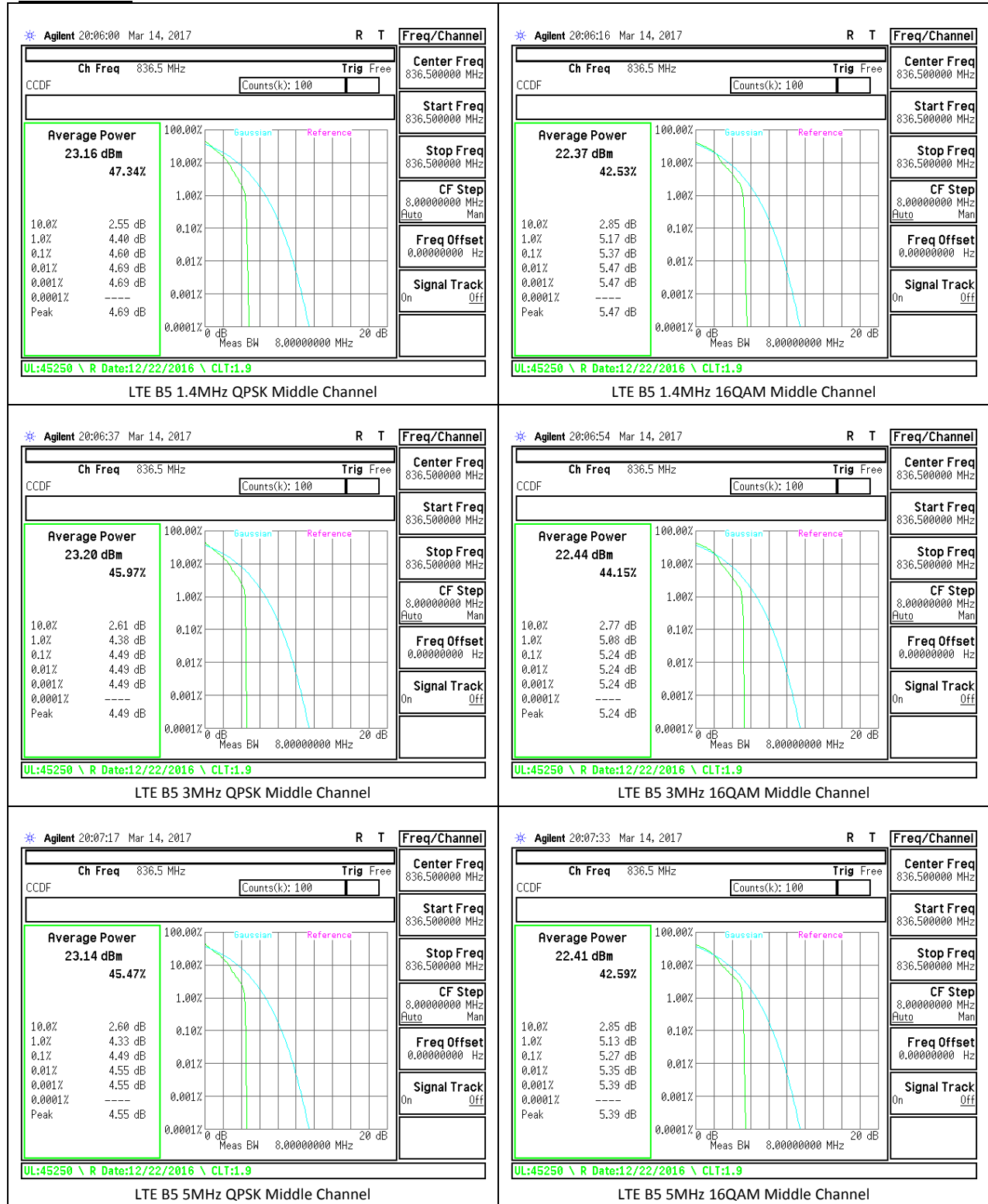

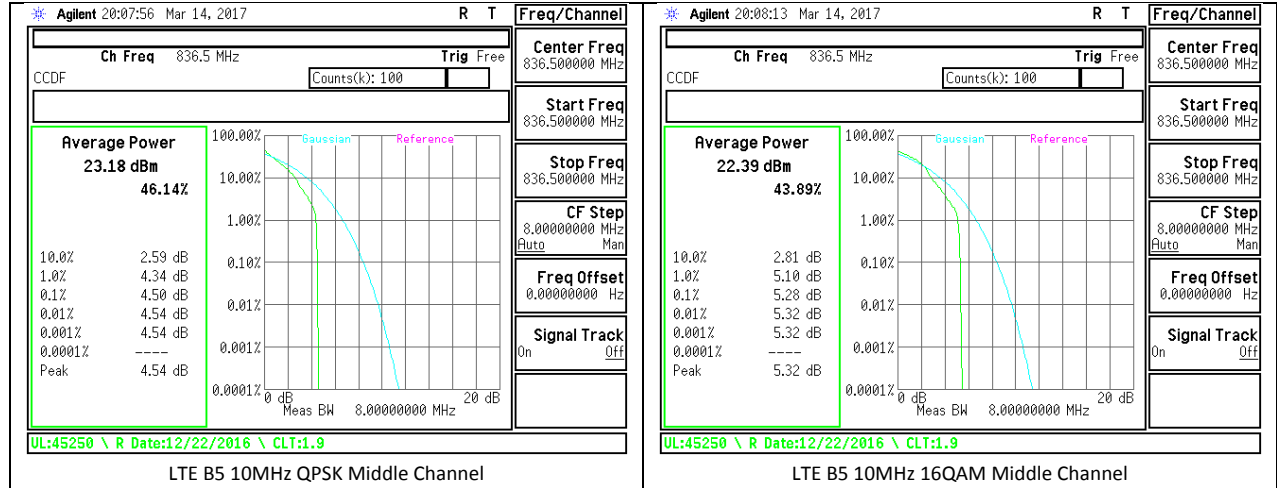

LTE Band 7

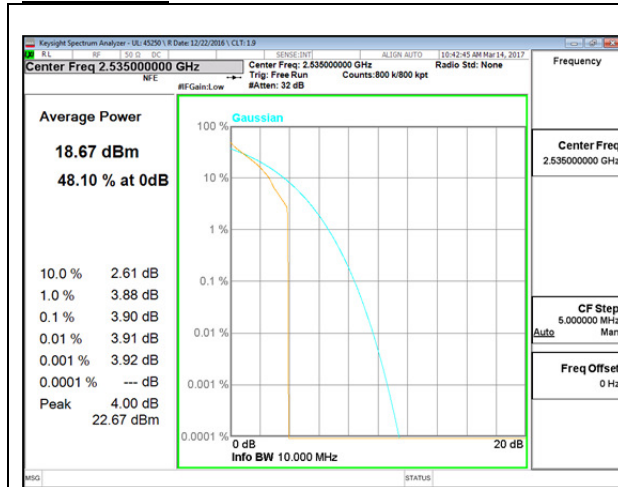

LTE B7 5MHz QPSK Middle Channel

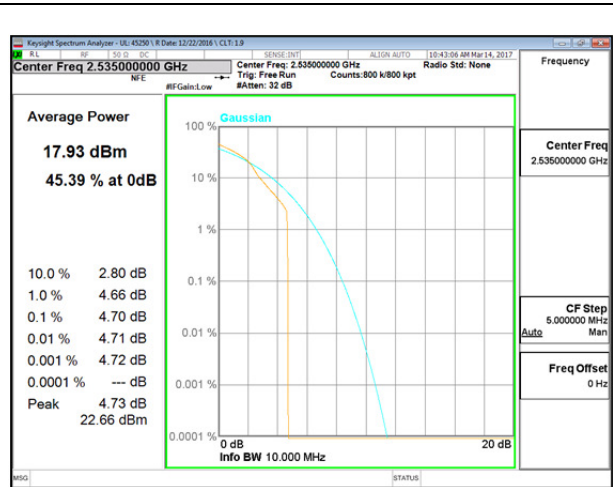

LTE B7 5MHz 16QAM Middle Channel

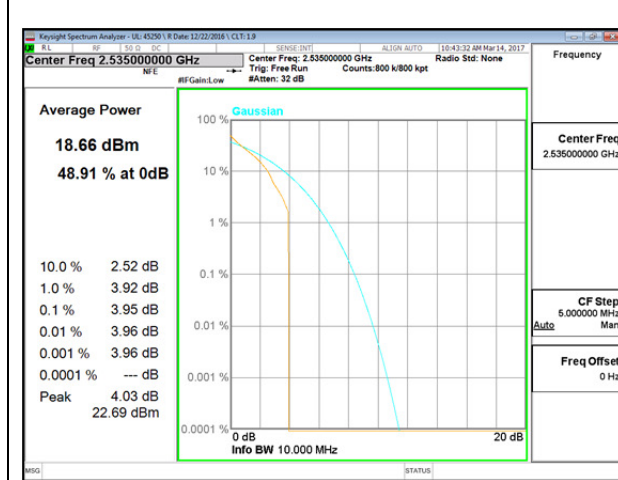

LTE B7 10MHz QPSK Middle Channel

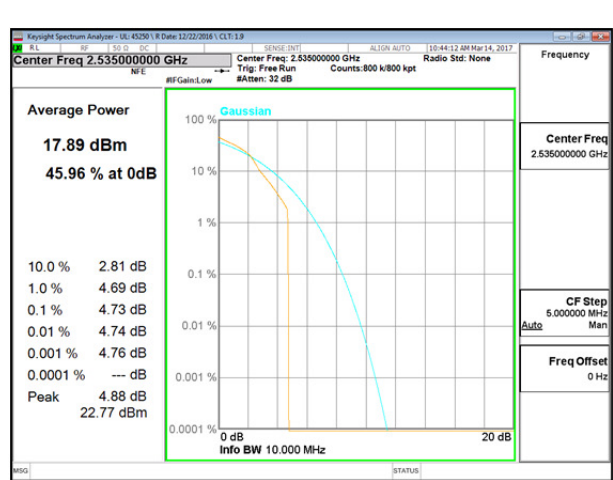

LTE B7 10MHz 16QAM Middle Channel

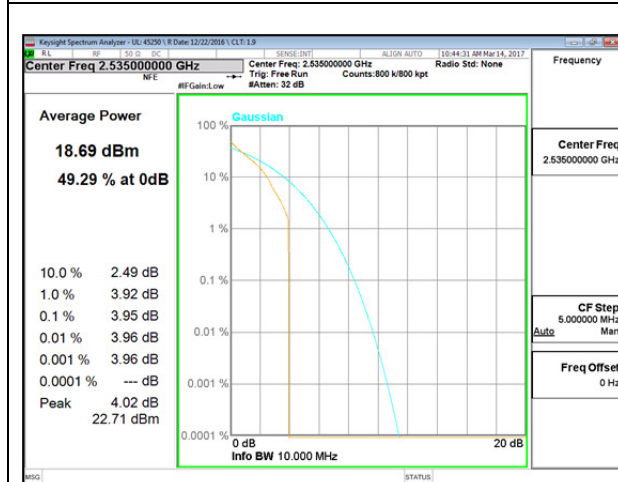

LTE B7 15MHz QPSK Middle Channel

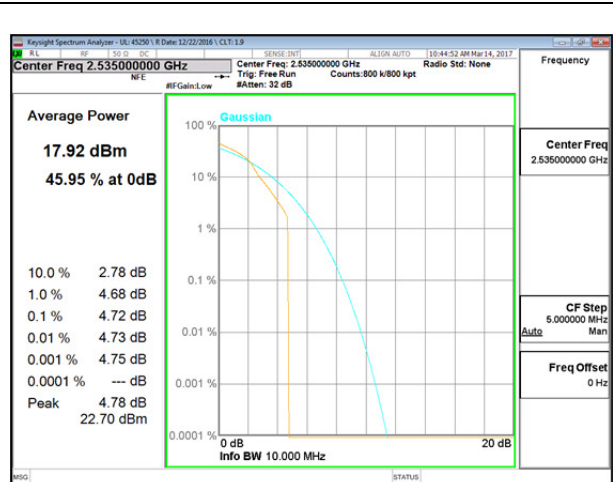

LTE B7 15MHz 16QAM Middle Channel

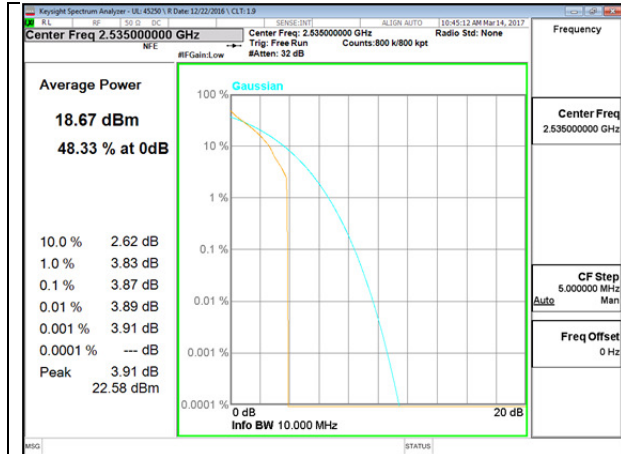

LTE B7 20MHz QPSK Middle Channel

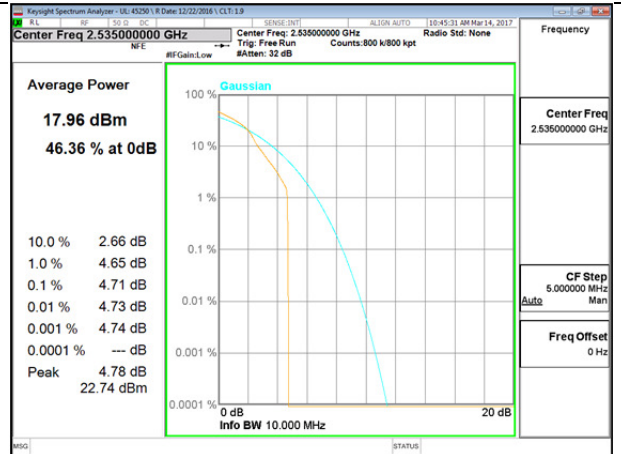

LTE B7 20MHz 16QAM Middle Channel

LTE Band 12

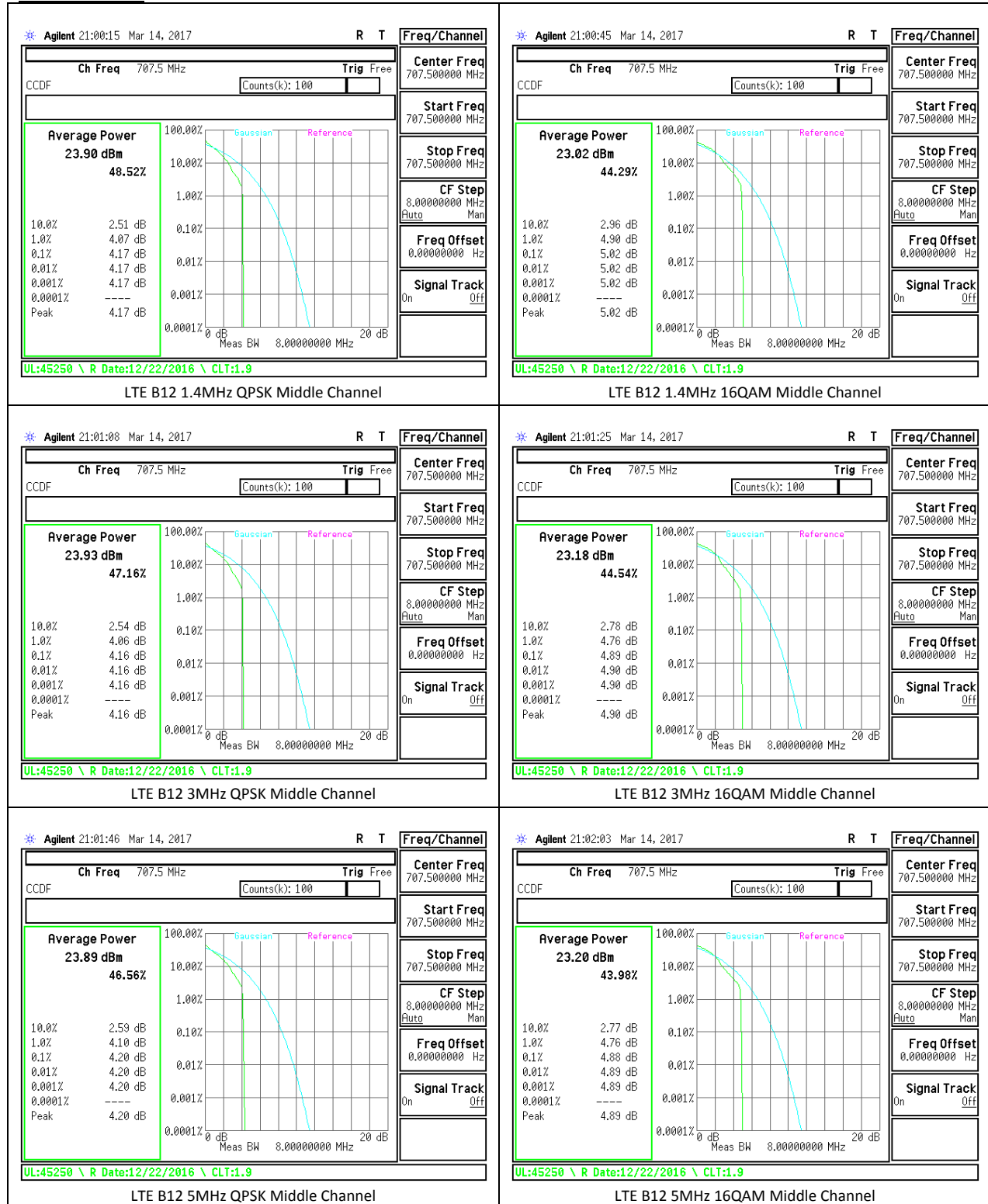

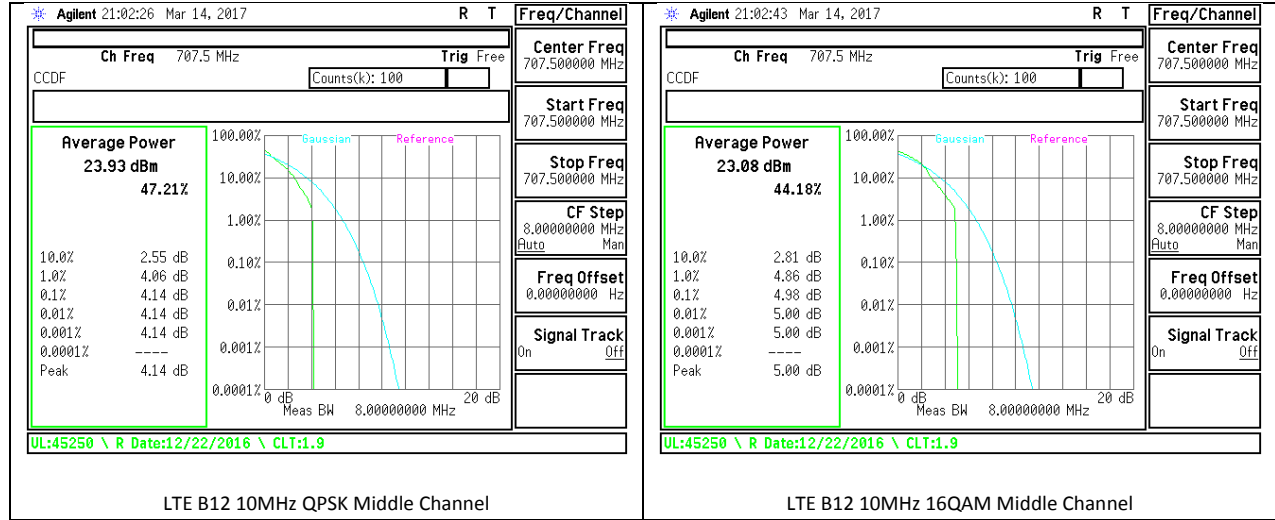

LTE Band 13

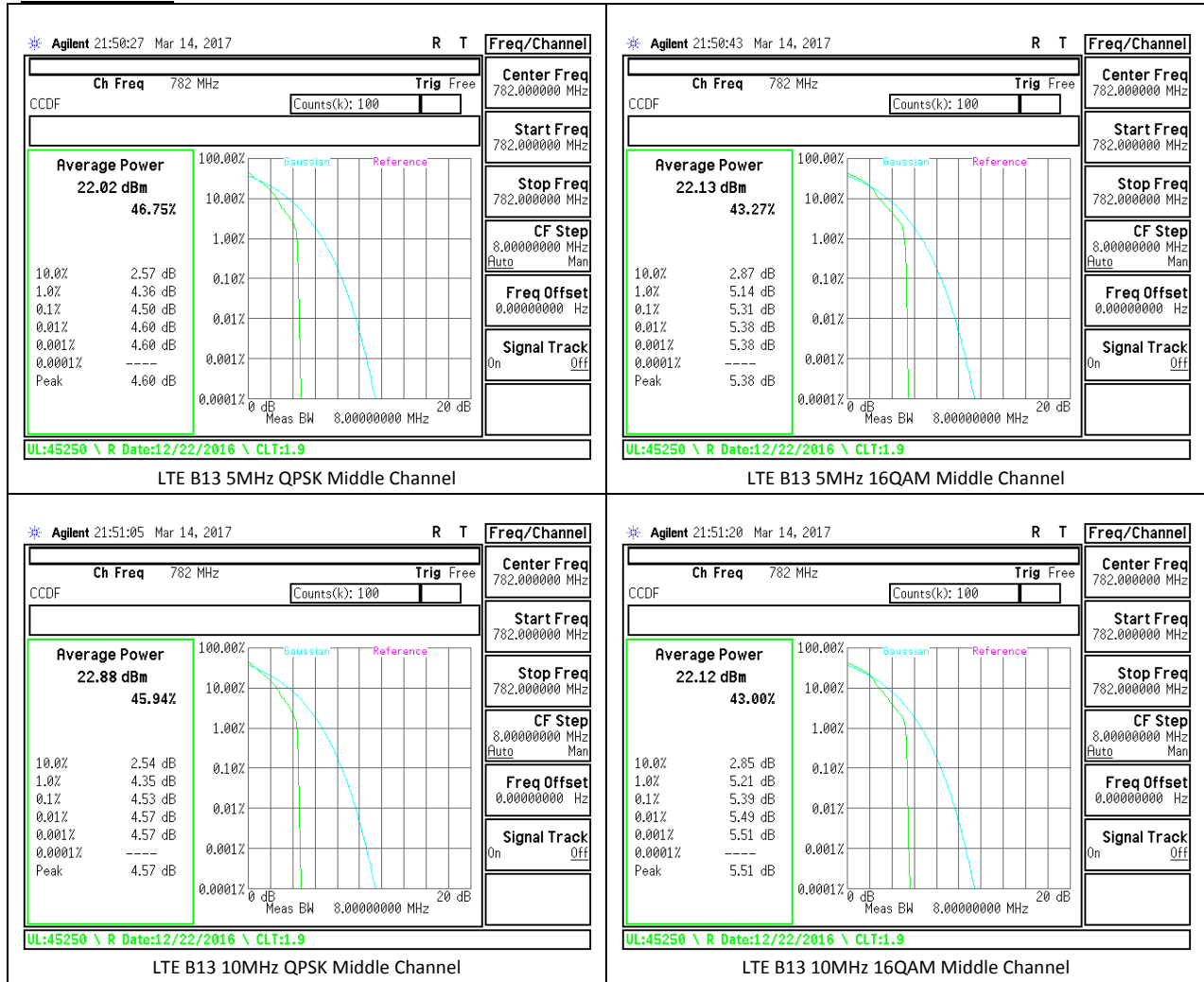

LTE Band 17

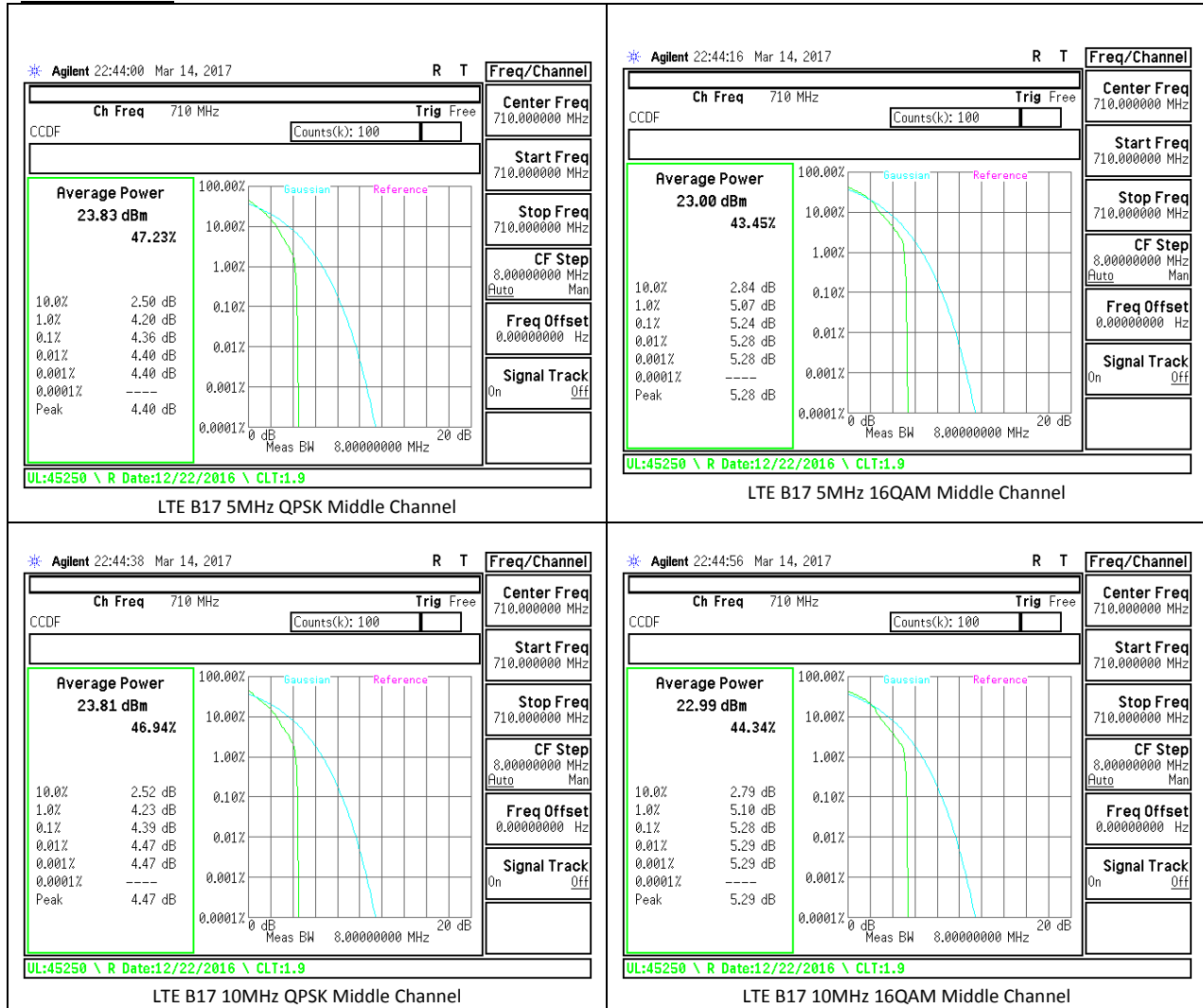

LTE Band 41

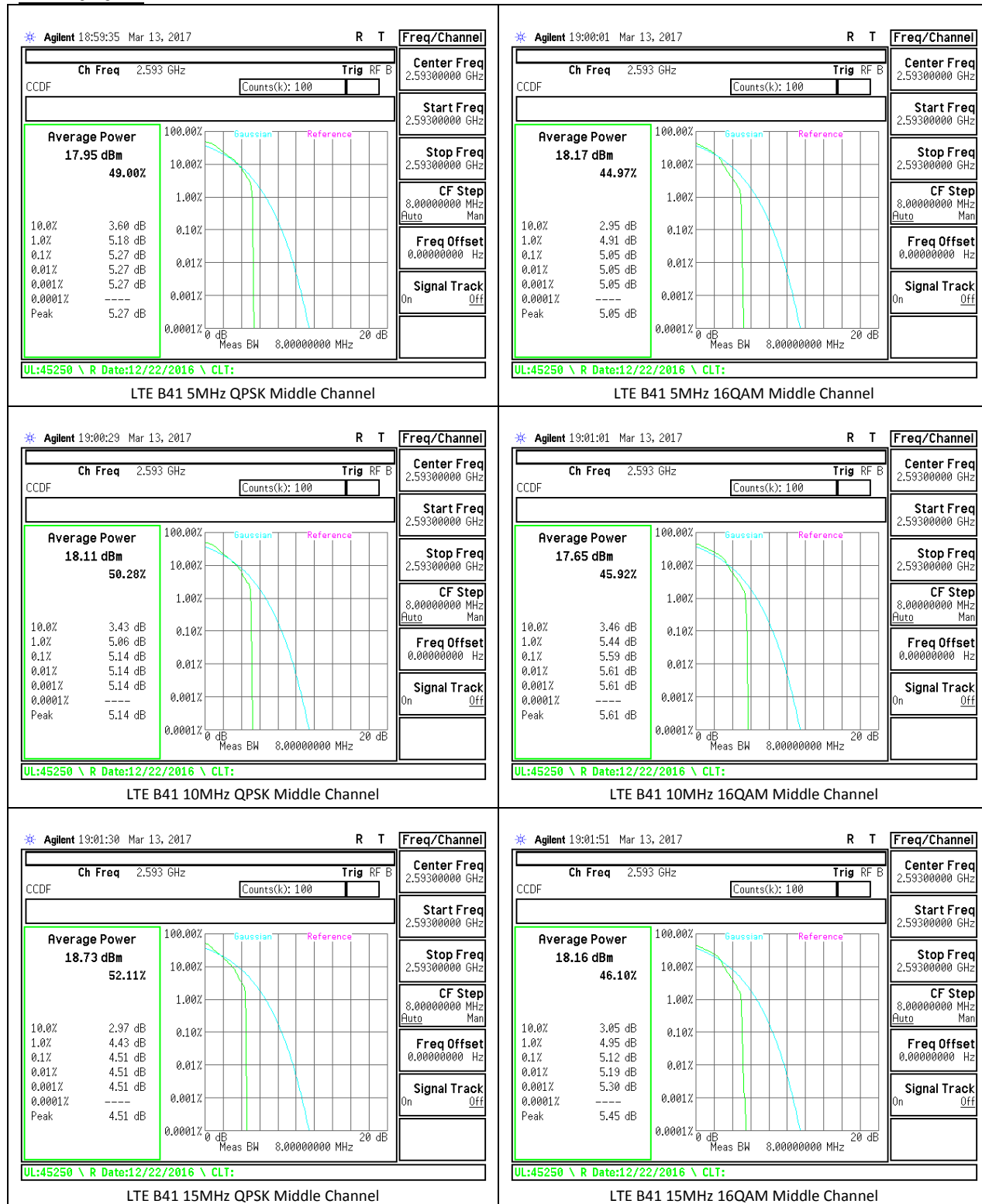

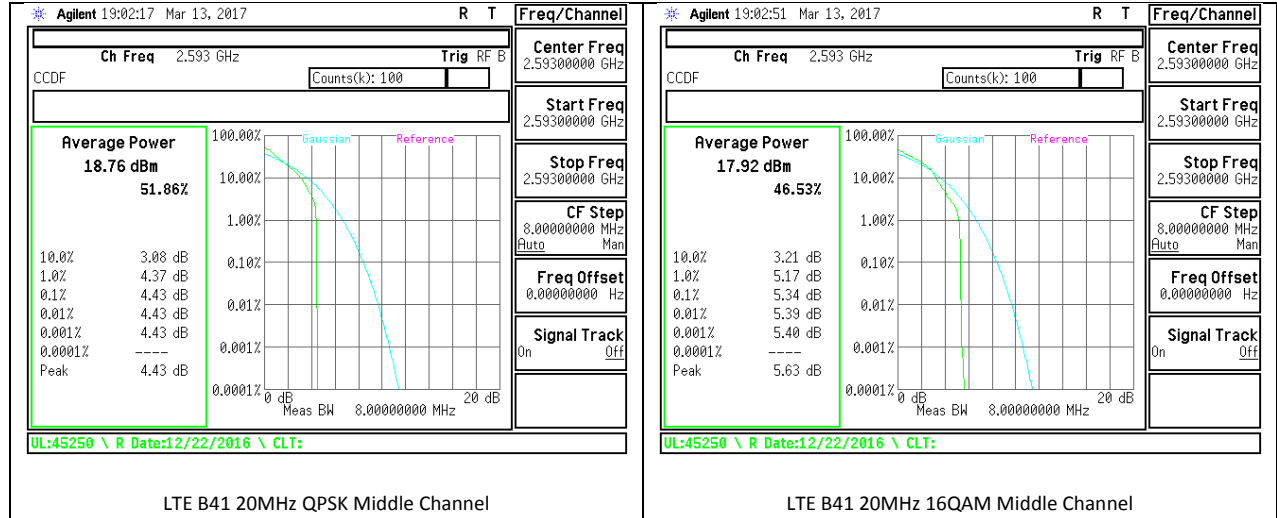

13. OCCUPIED BANDWIDTH

RULE PART(S)

FCC: §2.1049

LIMITS

For reporting purposes only

TEST PROCEDURE

The transmitter output was connected to a calibrated coaxial cable and coupler, the other end of which was connected to a spectrum analyzer. The occupied bandwidth was measured with the spectrum analyzer at the low, middle and high channel in each band. The -26dB bandwidth was also measured and recorded.

(KDB 971168 D01 Power Meas License Digital Systems v02r02)

13.1. OCCUPIED BANDWIDTH RESULTS AND PLOTS

GSM

Band	Mode	Channel	f (MHz)	99% BW (kHz)	-26dB (kHz)
GSM 850	GPRS	128	824.2	248.2	314.8
		190	836.6	244.6	319.5
		251	848.8	243	315.2
	EGPRS	128	824.2	236.2	310.9
		190	836.6	245.6	304.3
		251	848.8	241.6	310.5
GSM 1900	GPRS	512	1850.2	246.7	307
		661	1880	247.2	323.9
		810	1909.8	248.5	310.1
	EGPRS	512	1850.2	244	304.1
		661	1880	248.1	317.4
		810	1909.8	243.8	313.5

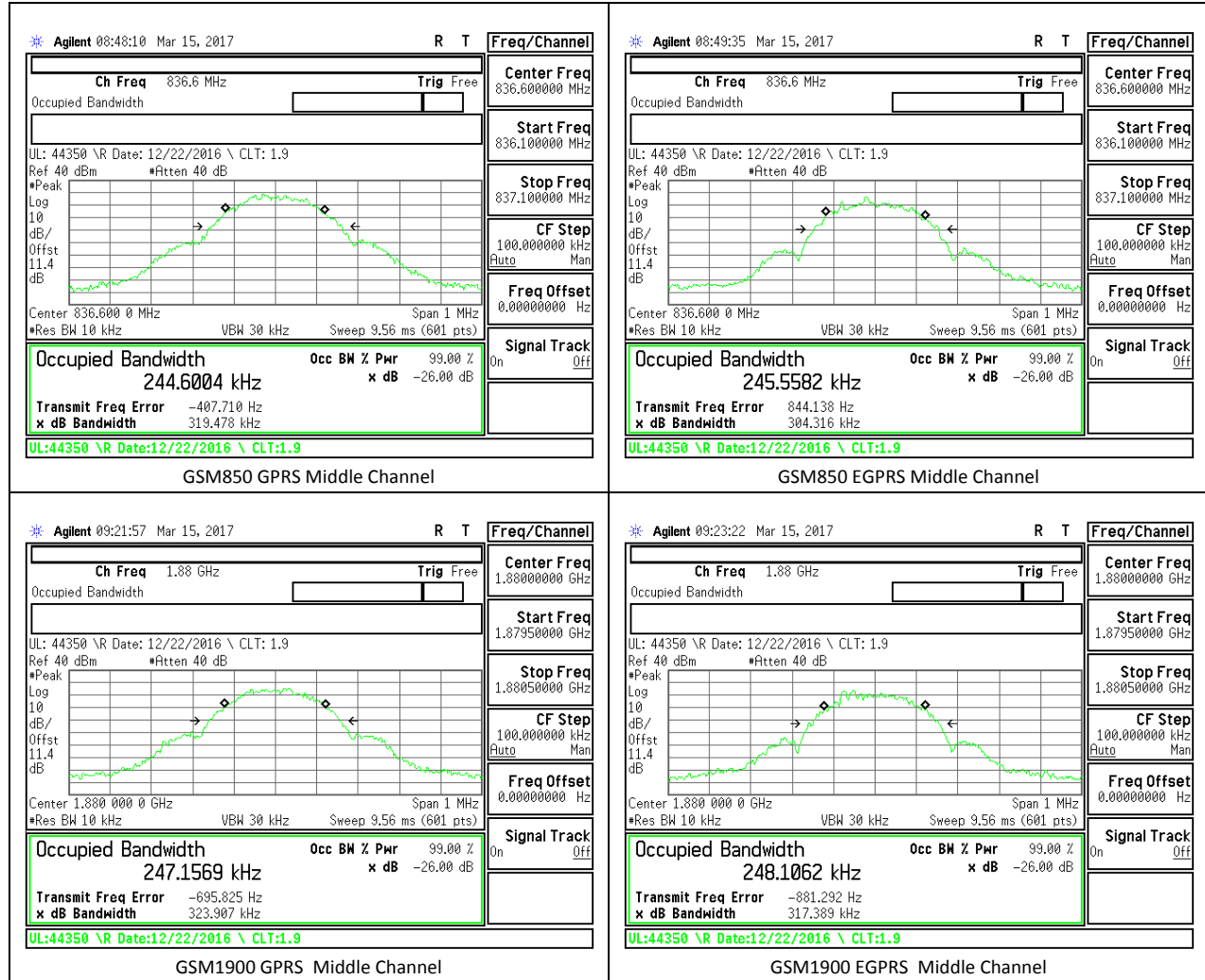

WCDMA

Band	Mode	Channel	f (MHz)	99% BW (MHz)	-26dB (MHz)
Band 5	REL99	4132	826.4	4.13	4.67
		4183	836.6	4.13	4.67
		4233	846.6	4.13	4.68
	HSDPA	4132	826.4	4.1	4.69
		4183	836.6	4.12	4.67
		4233	846.6	4.11	4.66

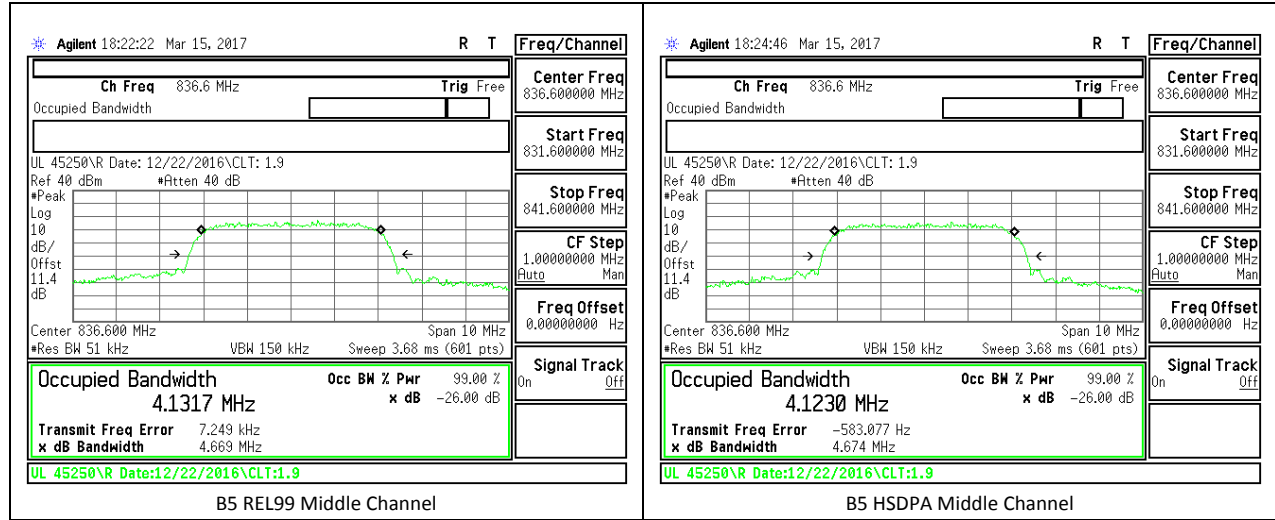

LTE Band 4

Band	BW(MHz)	Mode	RB/RB Size	f (MHz)	99% BW (MHz)	-26dB BW (MHz)
LTE4	20	16QAM	100/0	1720	17.87	19.26
			100/0	1732.5	17.85	19.16
			100/0	1745	17.79	19.19
		QPSK	100/0	1720	17.84	19.22
			100/0	1732.5	17.86	19.35
			100/0	1745	17.87	19.07
	15	16QAM	75/0	1717.5	13.41	14.39
			75/0	1732.5	13.4	14.5
			75/0	1747.5	13.39	14.33
		QPSK	75/0	1717.5	13.41	14.48
			75/0	1732.5	13.4	14.49
			75/0	1747.5	13.43	14.46
	10	16QAM	50/0	1715	8.95	9.68
			50/0	1732.5	8.95	9.72
			50/0	1750	8.92	9.66
		QPSK	50/0	1715	8.94	9.65
			50/0	1732.5	8.96	9.66
			50/0	1750	8.96	9.76
	5	16QAM	25/0	1712.5	4.49	4.82
			25/0	1732.5	4.5	4.91
			25/0	1752.5	4.49	4.87
		QPSK	25/0	1712.5	4.49	4.93
			25/0	1732.5	4.5	4.95
			25/0	1752.5	4.51	4.92

Band	BW(MHz)	Mode	RB/RB Size	f (MHz)	99% BW (MHz)	-26dB BW (MHz)
LTE4	3	16QAM	15/0	1711.5	2.68	3
			15/0	1732.5	2.68	2.95
			15/0	1753.5	2.69	2.99
		QPSK	15/0	1711.5	2.69	2.95
			15/0	1732.5	2.69	2.98
			15/0	1753.5	2.69	2.96
	1.4	16QAM	6/0	1710.7	1.08	1.22
			6/0	1732.5	1.08	1.23
			6/0	1754.3	1.08	1.23
		QPSK	6/0	1710.7	1.08	1.22
			6/0	1732.5	1.08	1.21
			6/0	1754.3	1.08	1.23

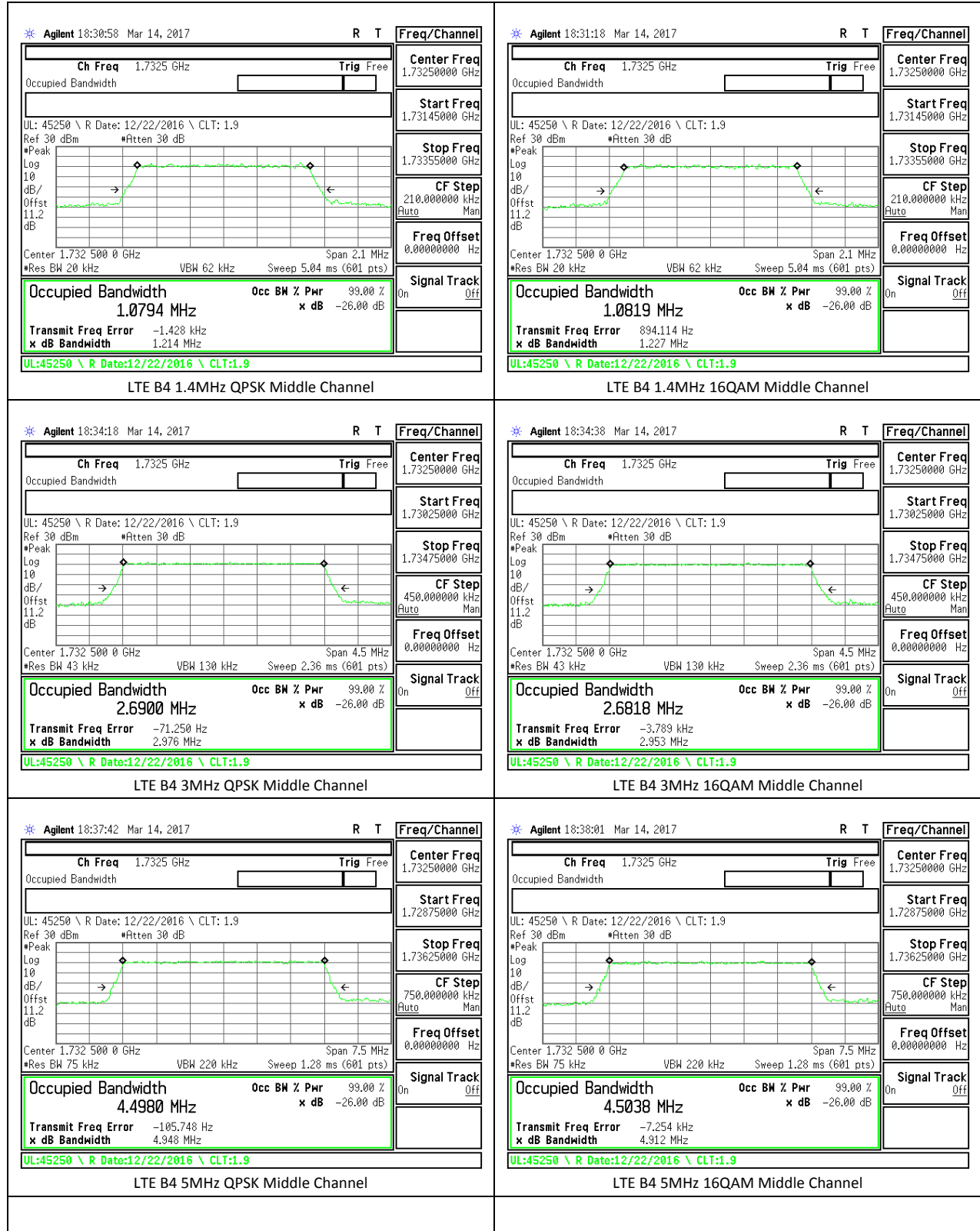

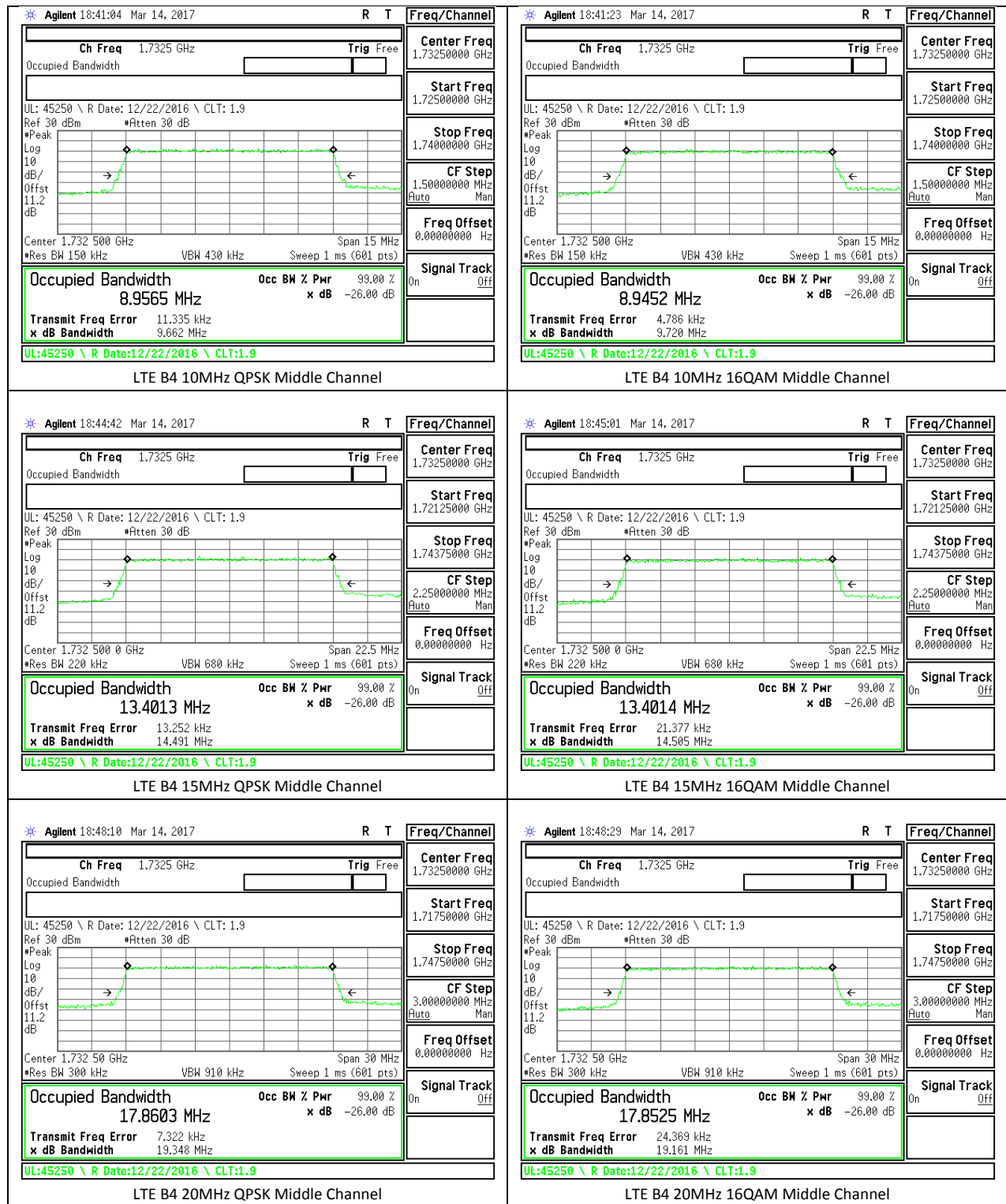

LTE Band 5

Band	BW(MHz)	Mode	RB/RB Size	f (MHz)	99% BW (MHz)	-26dB BW (MHz)
LTE5	10	16QAM	50/0	829	8.98	9.58
			50/0	836.5	8.98	9.67
			50/0	844	8.96	9.69
		QPSK	50/0	829	8.95	9.7
			50/0	836.5	8.97	9.73
			50/0	844	8.95	9.63
	5	16QAM	25/0	826.5	4.49	4.9
			25/0	836.5	4.51	4.99
			25/0	846.5	4.49	4.94
		QPSK	25/0	826.5	4.49	4.96
			25/0	836.5	4.51	4.91
			25/0	846.5	4.51	4.92
	3	16QAM	15/0	825.5	2.69	2.98
			15/0	836.5	2.69	2.94
			15/0	847.5	2.69	2.97
		QPSK	15/0	825.5	2.69	2.99
			15/0	836.5	2.68	2.96
			15/0	847.5	2.69	2.98
	1.4	16QAM	6/0	824.7	1.08	1.23
			6/0	836.5	1.09	1.22
			6/0	848.3	1.08	1.22
		QPSK	6/0	824.7	1.08	1.22
			6/0	836.5	1.08	1.22
			6/0	848.3	1.08	1.22

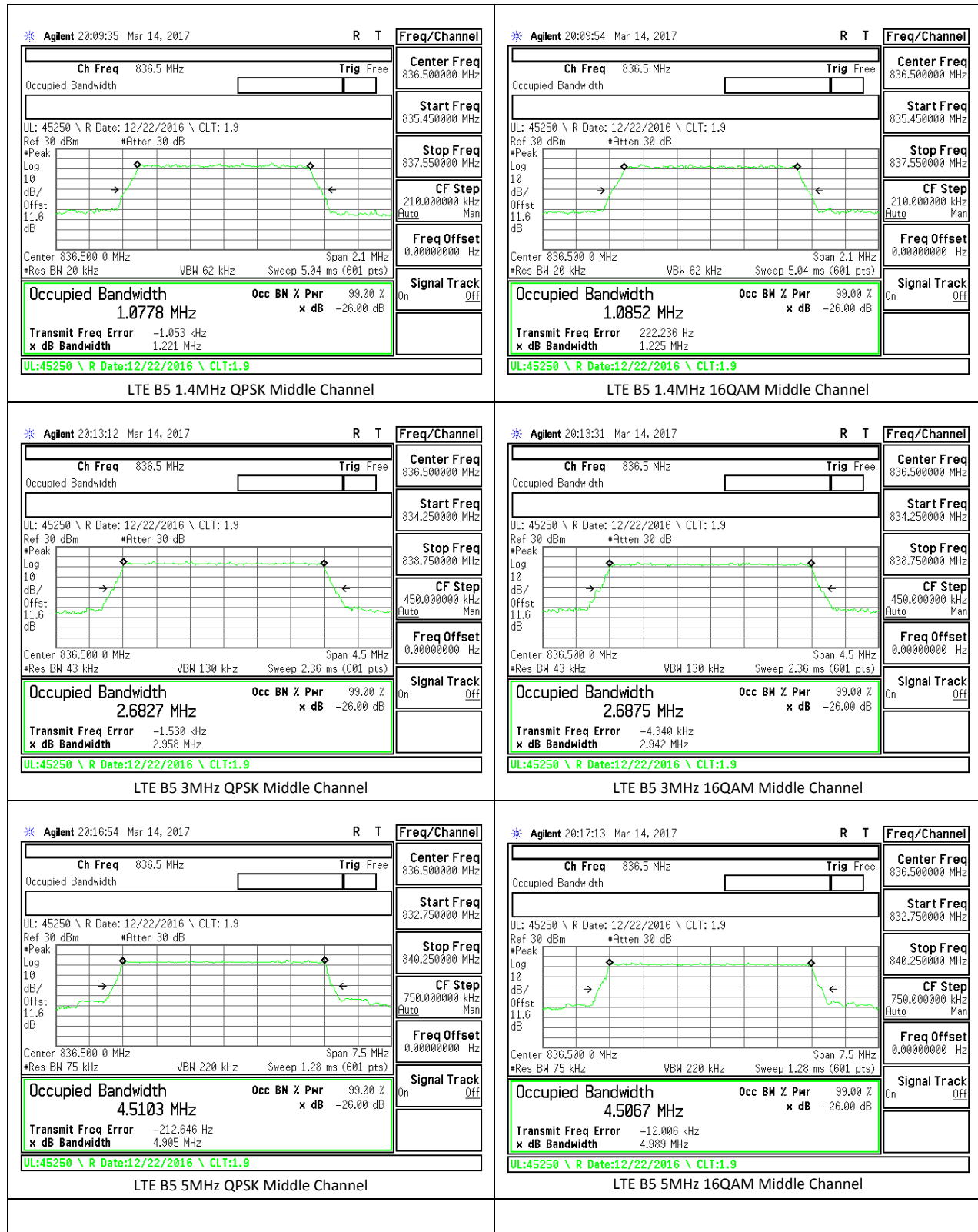

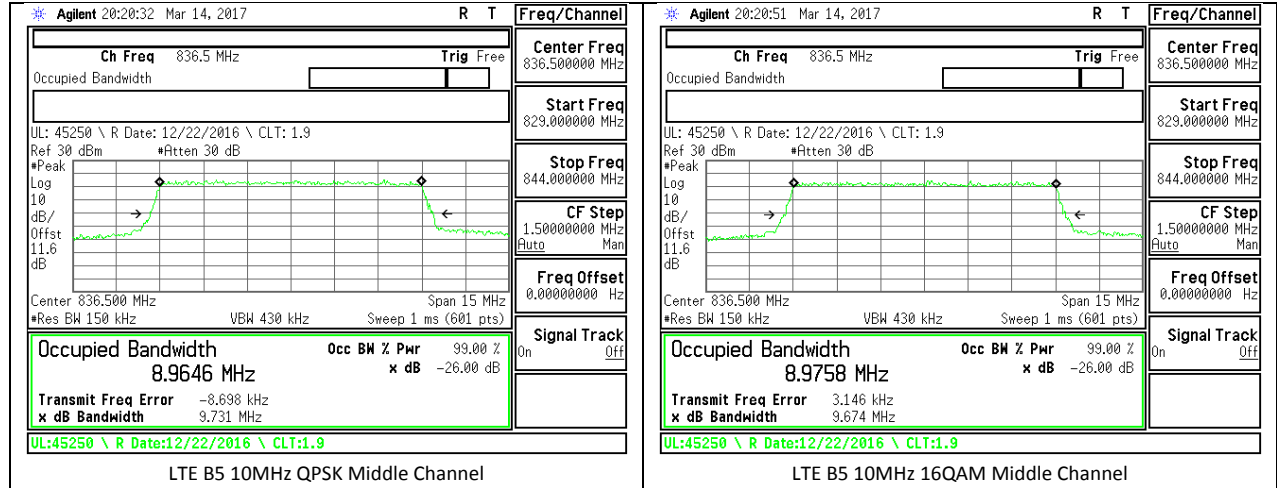

LTE Band 7

Band	BW(MHz)	Mode	RB/RB Size	f (MHz)	99% BW (MHz)	-26dB BW (MHz)
LTE7	20	16QAM	100/0	2510	17.9	19.31
			100/0	2535	17.86	19.35
			100/0	2560	17.84	19.22
		QPSK	100/0	2510	17.93	19.33
			100/0	2535	17.91	19.26
			100/0	2560	17.84	18.83
	15	16QAM	75/0	2507.5	13.42	14.47
			75/0	2535	13.43	14.54
			75/0	2562.5	13.4	14.5
		QPSK	75/0	2507.5	13.4	14.45
			75/0	2535	13.46	14.6
			75/0	2562.5	13.41	14.58
	10	16QAM	50/0	2505	8.97	9.75
			50/0	2535	8.98	9.76
			50/0	2565	8.94	9.75
		QPSK	50/0	2505	8.94	9.72
			50/0	2535	8.97	9.75
			50/0	2565	8.98	9.77
	5	16QAM	25/0	2502.5	4.49	4.94
			25/0	2535	4.48	4.91
			25/0	2567.5	4.5	4.96
		QPSK	25/0	2502.5	4.49	4.95
			25/0	2535	4.49	4.94
			25/0	2567.5	4.51	4.95

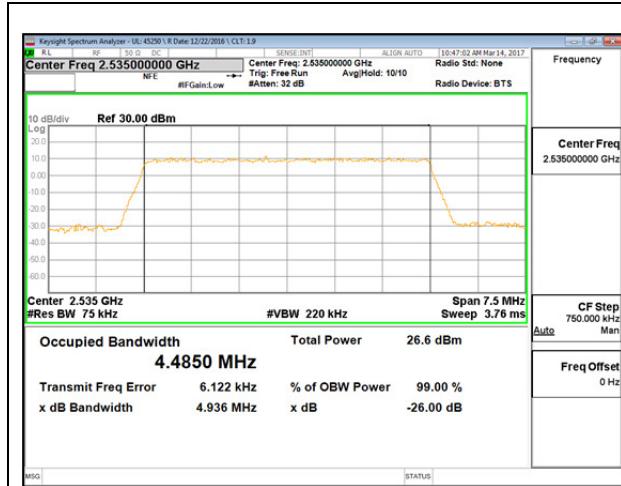

LTE B7 5MHz QPSK Middle Channel

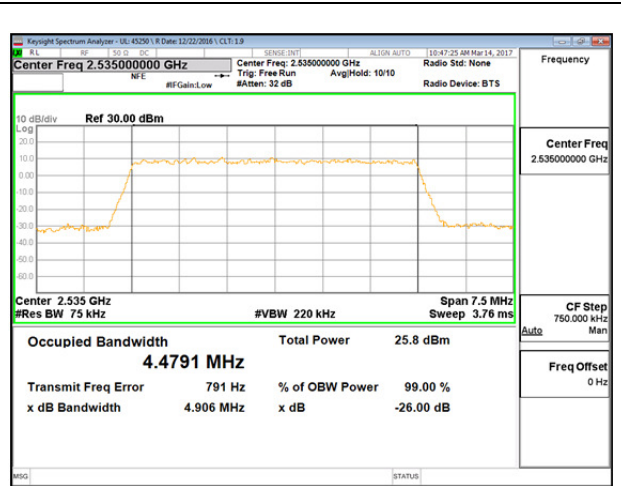

LTE B7 5MHz 16QAM Middle Channel

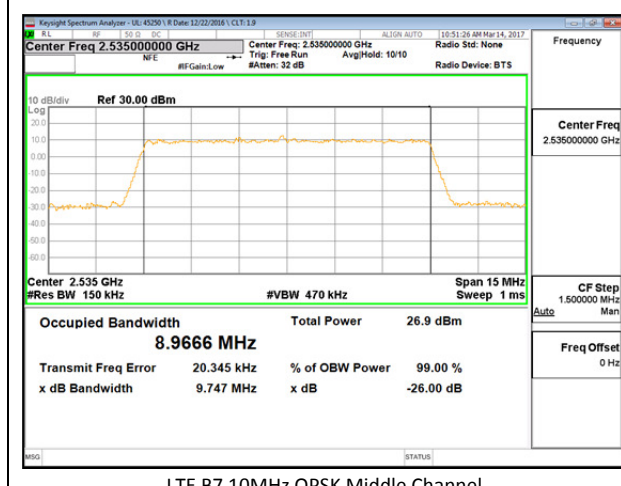

LTE B7 10MHz QPSK Middle Channel

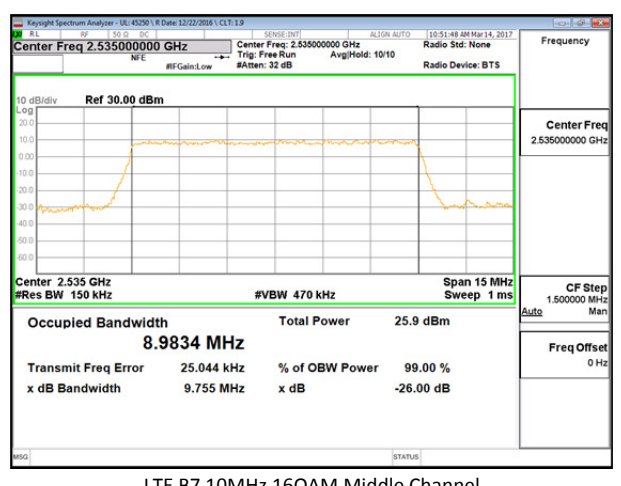

LTE B7 10MHz 16QAM Middle Channel

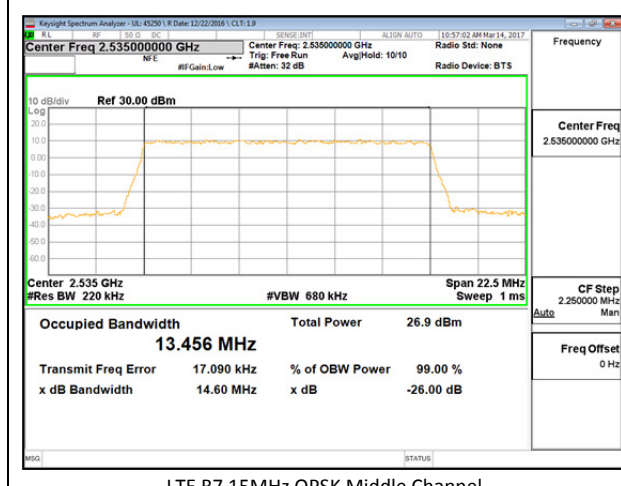

LTE B7 15MHz QPSK Middle Channel

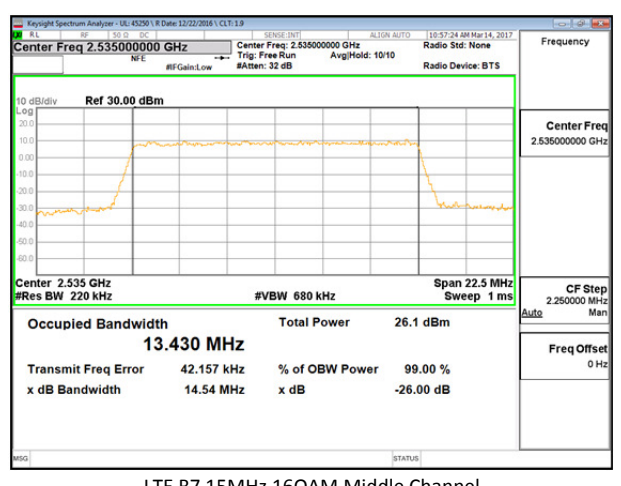

LTE B7 15MHz 16QAM Middle Channel

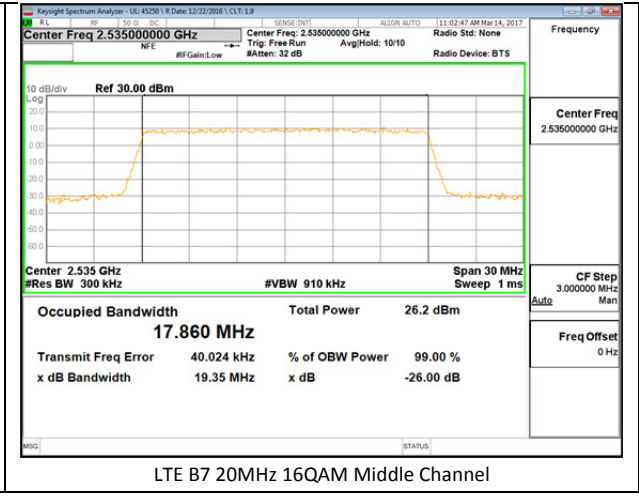
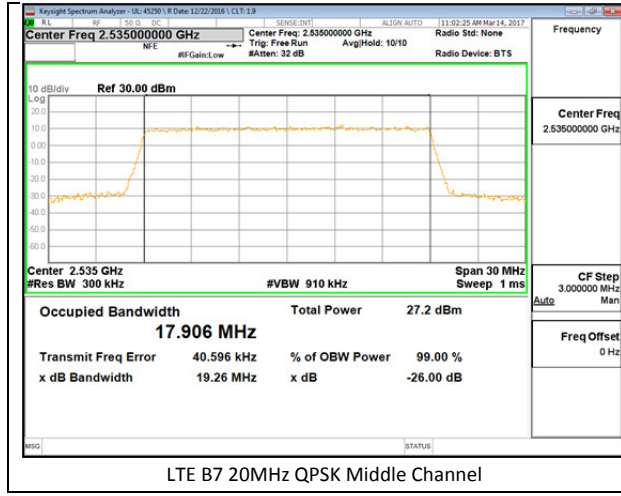

LTE Band 12

Band	BW(MHz)	Mode	RB/RB Size	f (MHz)	99% BW (MHz)	-26dB BW (MHz)
LTE12	10	16QAM	50/0	704	8.98	9.69
			50/0	707.5	8.96	9.74
			50/0	711	8.94	9.61
		QPSK	50/0	704	8.96	9.59
			50/0	707.5	8.93	9.71
			50/0	711	8.97	9.68
	5	16QAM	25/0	701.5	4.48	4.89
			25/0	707.5	4.5	4.93
			25/0	713.5	4.49	4.93
		QPSK	25/0	701.5	4.49	4.94
			25/0	707.5	4.51	4.94
			25/0	713.5	4.5	4.92
	3	16QAM	15/0	700.5	2.69	2.98
			15/0	707.5	2.69	2.99
			15/0	714.5	2.68	2.97
		QPSK	15/0	700.5	2.69	2.98
			15/0	707.5	2.69	2.97
			15/0	714.5	2.68	2.97
	1.4	16QAM	6/0	699.7	1.08	1.23
			6/0	707.5	1.08	1.22
			6/0	715.3	1.09	1.22
		QPSK	6/0	699.7	1.08	1.23
			6/0	707.5	1.08	1.22
			6/0	715.3	1.08	1.21

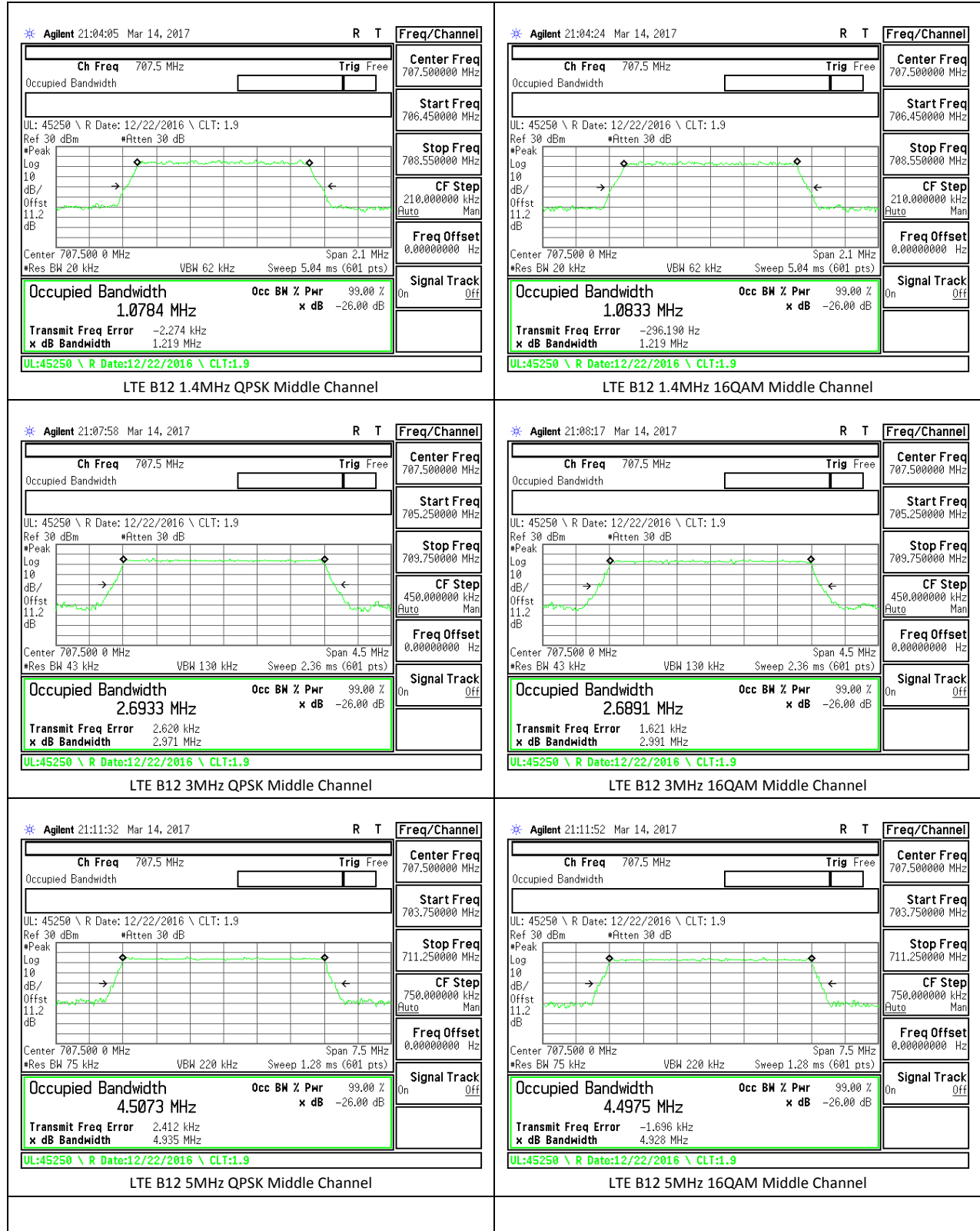

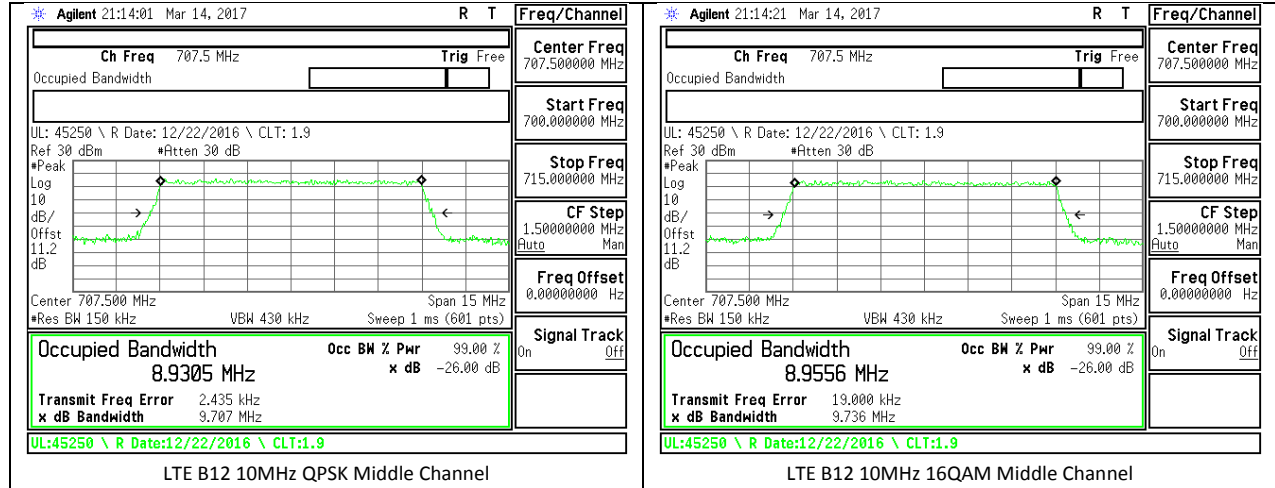

LTE Band 13

Band	BW(MHz)	Mode	RB/RB Size	f (MHz)	99% BW (MHz)	-26dB BW (MHz)
LTE13	10	16QAM	50/0			
			50/0	782	8.95	9.68
			50/0			
		QPSK	50/0			
			50/0	782	8.93	9.63
			50/0			
	5	16QAM	25/0	779.5	4.5	4.92
			25/0	782	4.49	4.88
			25/0	784.5	4.5	4.9
		QPSK	25/0	779.5	4.49	4.88
			25/0	782	4.48	4.94
			25/0	784.5	4.48	4.93



LTE Band 17

Band	BW(MHz)	Mode	RB/RB Size	f (MHz)	99% BW (MHz)	-26dB BW (MHz)
LTE17	10	16QAM	50/0	709	8.95	9.63
			50/0	710	8.94	9.78
			50/0	711	8.93	9.7
		QPSK	50/0	709	8.93	9.55
			50/0	710	8.96	9.72
			50/0	711	8.94	9.64
	5	16QAM	25/0	706.5	4.49	4.9
			25/0	710	4.49	4.84
			25/0	713.5	4.5	4.94
		QPSK	25/0	706.5	4.5	4.93
			25/0	710	4.48	4.92
			25/0	713.5	4.49	4.94

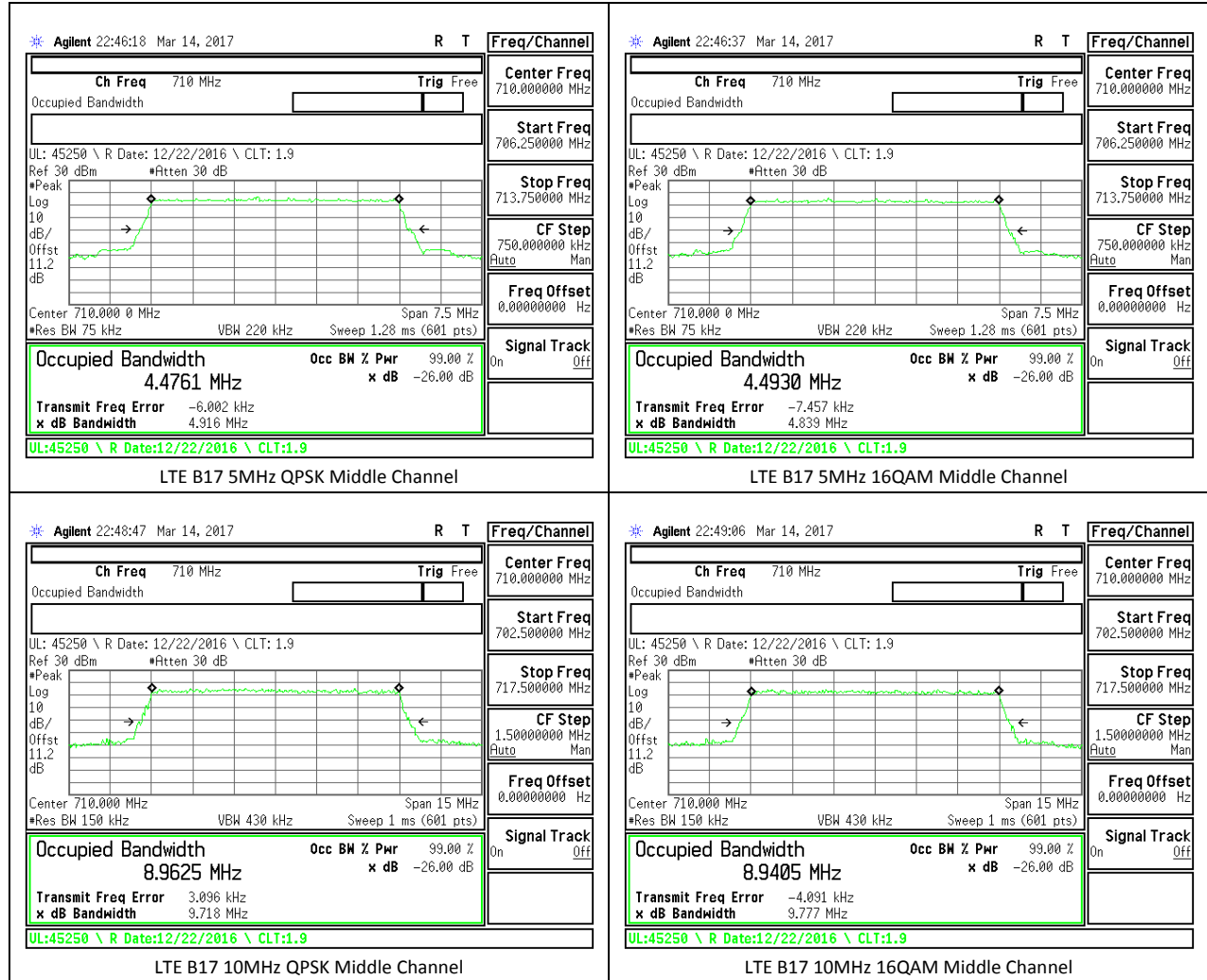

LTE Band 41

Band	BW(MHz)	Mode	RB/RB Size	f (MHz)	99% BW (MHz)	-26dB BW (MHz)
LTE41	20	16QAM	100/0	2506	17.84	18.92
			100/0	2593	17.87	19.11
			100/0	2680	17.81	19.08
		QPSK	100/0	2506	17.88	19.22
			100/0	2593	17.88	19.15
			100/0	2680	17.9	19.06
	15	16QAM	75/0	2503.5	13.39	14.44
			75/0	2593	13.38	14.41
			75/0	2682.5	13.4	14.52
		QPSK	75/0	2503.5	13.38	14.38
			75/0	2593	13.44	14.6
			75/0	2682.5	13.38	14.39
	10	16QAM	50/0	2501	8.96	9.58
			50/0	2593	8.97	9.61
			50/0	2685	8.96	9.74
		QPSK	50/0	2501	8.95	9.82
			50/0	2593	8.94	9.54
			50/0	2685	8.96	9.64
	5	16QAM	25/0	2498.5	4.49	4.83
			25/0	2593	4.49	4.89
			25/0	2687.5	4.48	4.9
		QPSK	25/0	2498.5	4.51	4.88
			25/0	2593	4.49	4.92
			25/0	2687.5	4.5	4.93

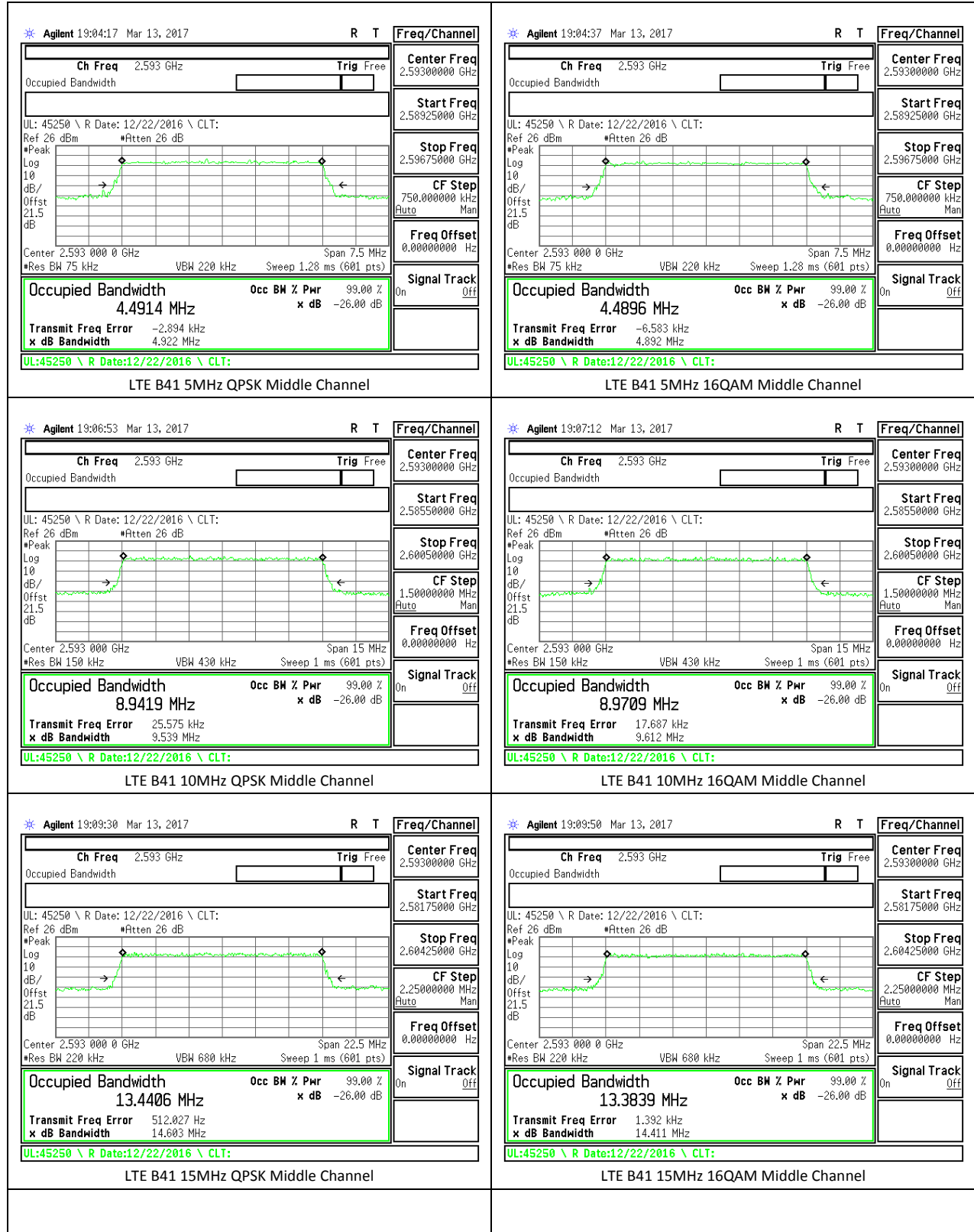

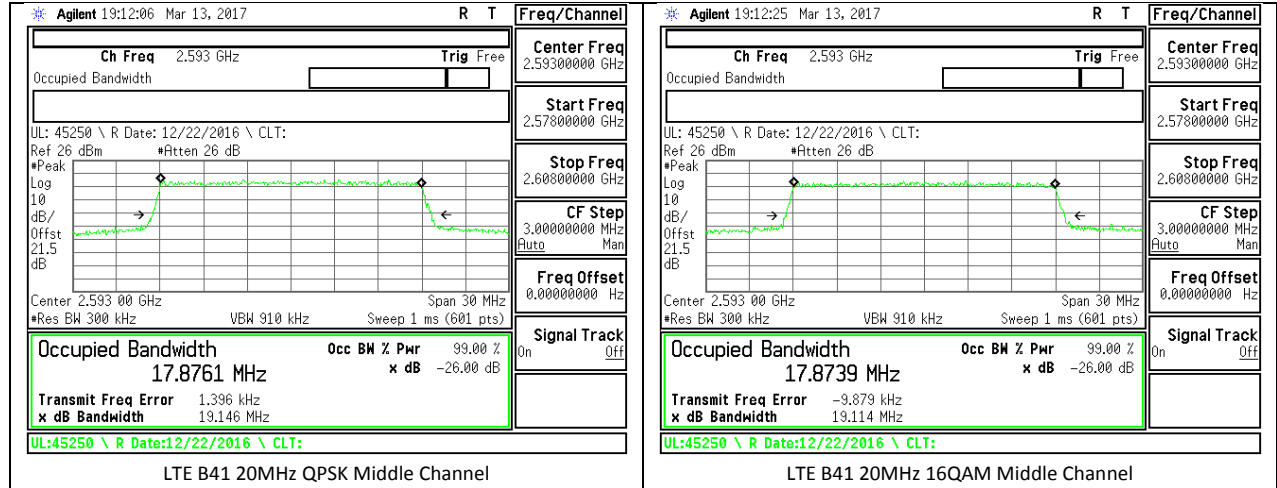

14. BAND EDGE EMISSIONS

RULE PART(S)

FCC: §22.359, §24.238, §27.53

LIMITS

The power of any emission outside of the authorized operating frequency ranges must be attenuated below the transmitting power (P) by a factor of at least $43 + 10 \log (P)$ dB.

Part 27: (m)(4) (4) For mobile digital stations, the attenuation factor shall be not less than $40 + 10 \log (P)$ dB on all frequencies between the channel edge and 5 megahertz from the channel edge, $43 + 10 \log (P)$ dB on all frequencies between 5 megahertz and X megahertz from the channel edge, and $55 + 10 \log (P)$ dB on all frequencies more than X megahertz from the channel edge, where X is the greater of 6 megahertz or the actual emission bandwidth as defined in paragraph (m)(6) of this section. In addition, the attenuation factor shall not be less than $43 + 10 \log (P)$ dB on all frequencies between 2490.5 MHz and 2496 MHz and $55 + 10 \log (P)$ dB at or below 2490.5 MHz. Mobile Satellite Service licensees operating on frequencies below 2495 MHz may also submit a documented interference complaint against BRS licensees operating on channel BRS Channel 1 on the same terms and conditions as adjacent channel BRS or EBS licensees.

TEST PROCEDURE

Per KDB 971168 D01 Power Meas License Digital Systems v02r02

The transmitter output was connected to an Agilent 8960 or a CMW500 Test Set and configured to operate at maximum power. The band edge emissions were measured at the required operating frequencies in each band on the Spectrum Analyzer.

For each band edge measurement:

- Set the spectrum analyzer span to include the block edge frequency.
- Set a marker to point the corresponding band edge frequency in each test case.
- Set display line at -13 dBm
- Set resolution bandwidth to at least 1% of emission bandwidth.

14.1. BAND EDGE PLOTS

GSM

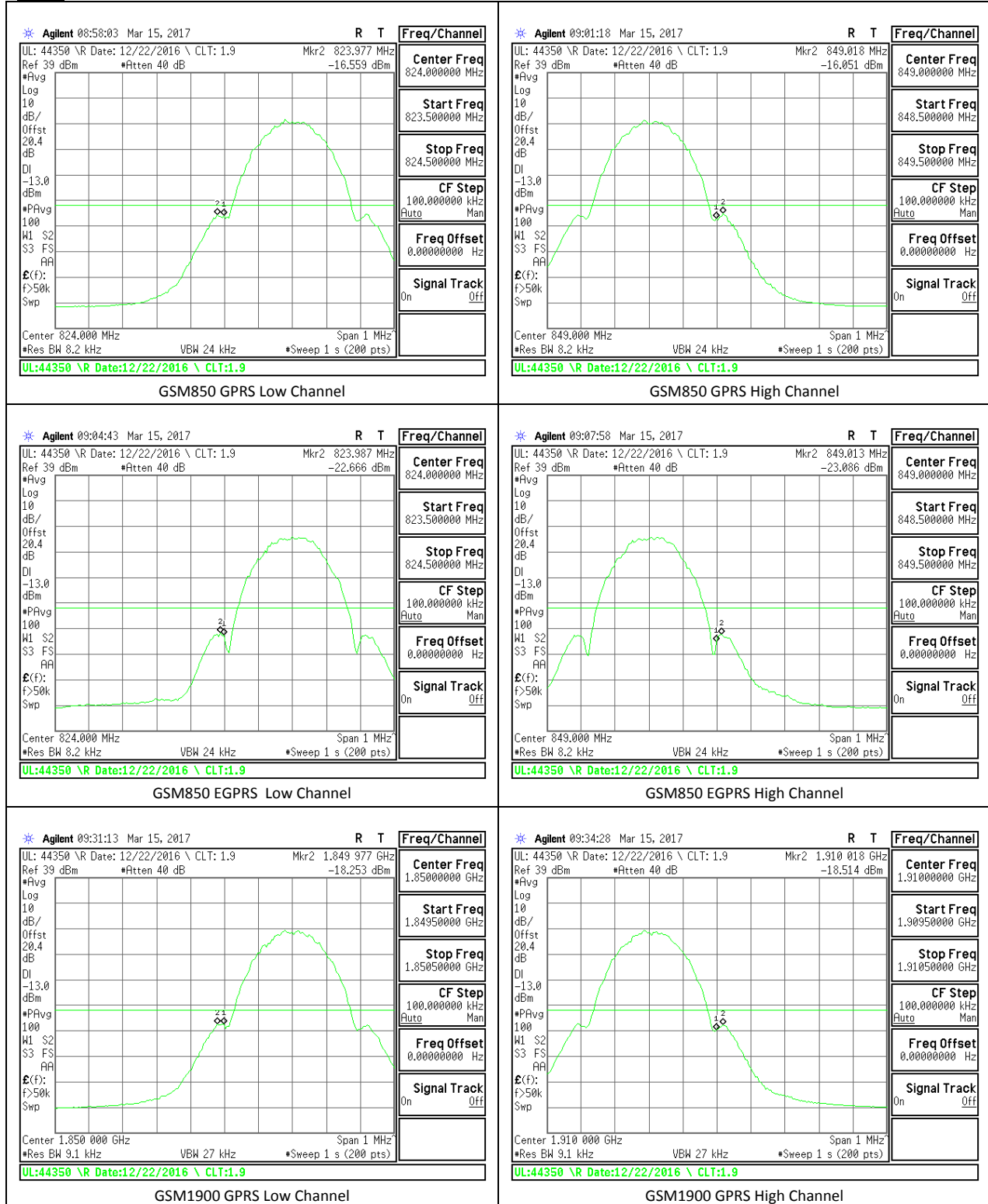

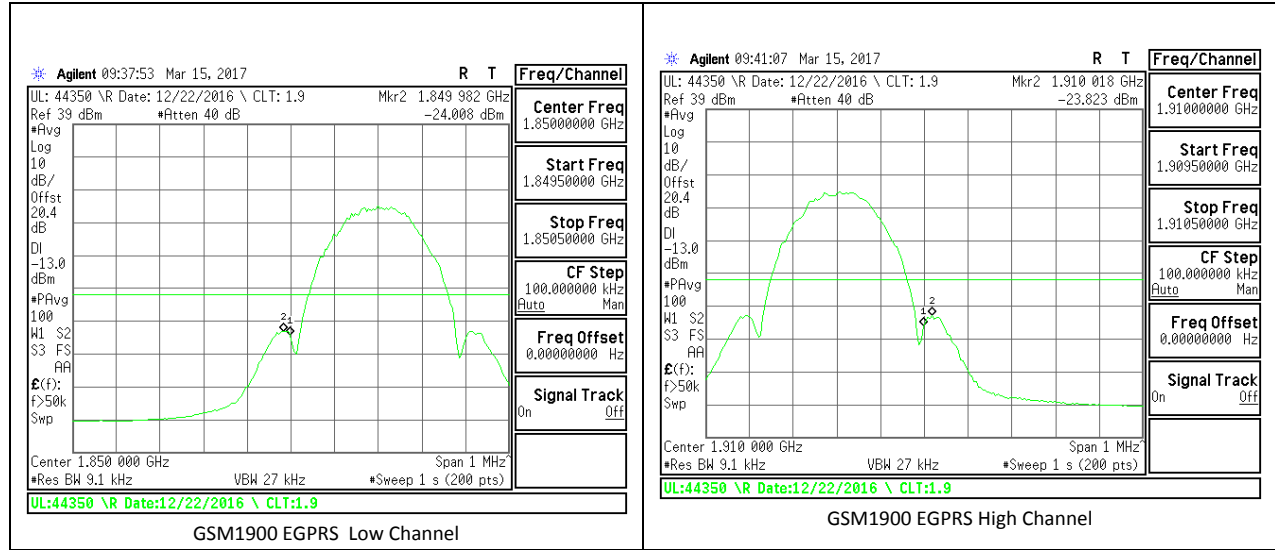

WCDMA

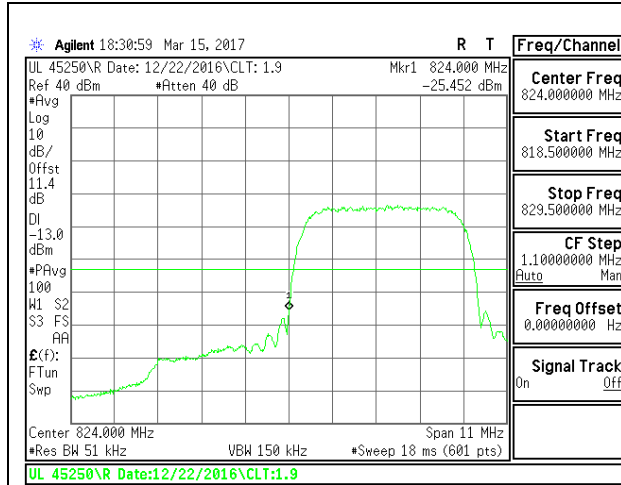

B5 REL99 Low Channel

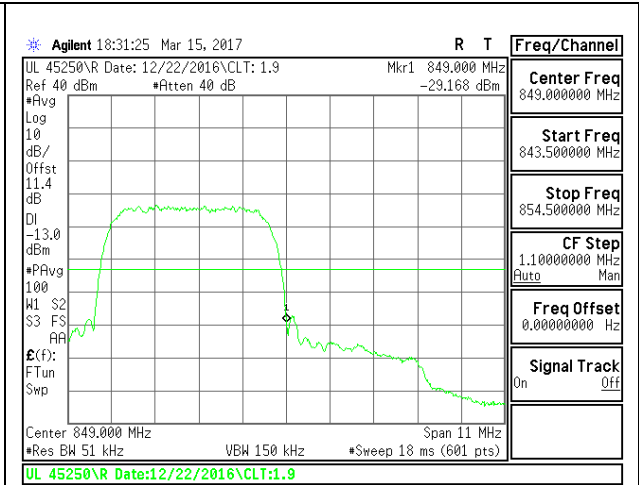

B5 REL99 High Channel

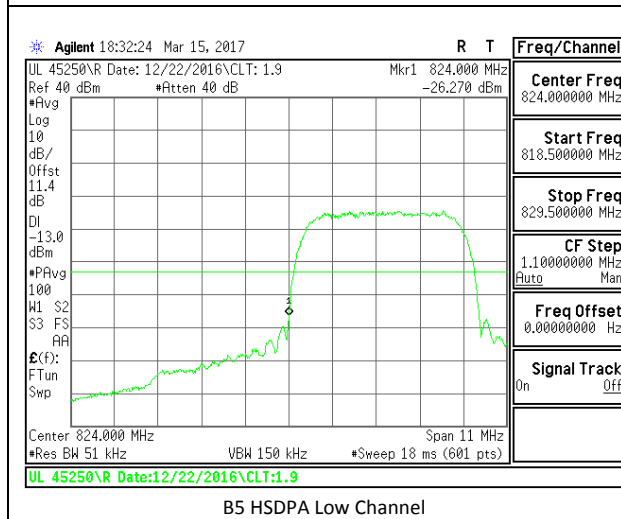

B5 HSDPA Low Channel

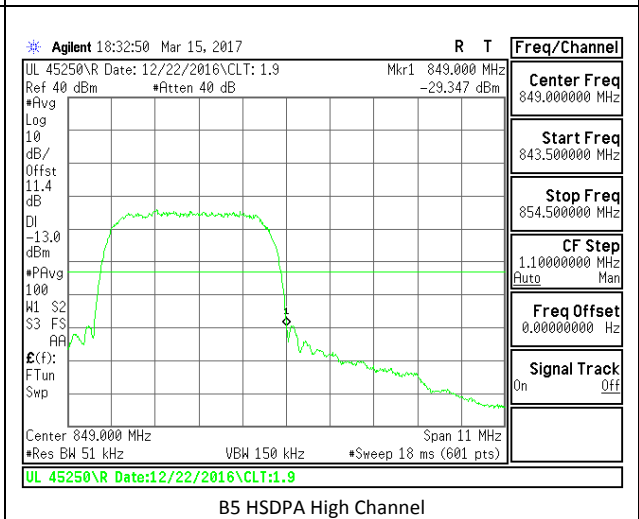

B5 HSDPA High Channel

LTE Band 4

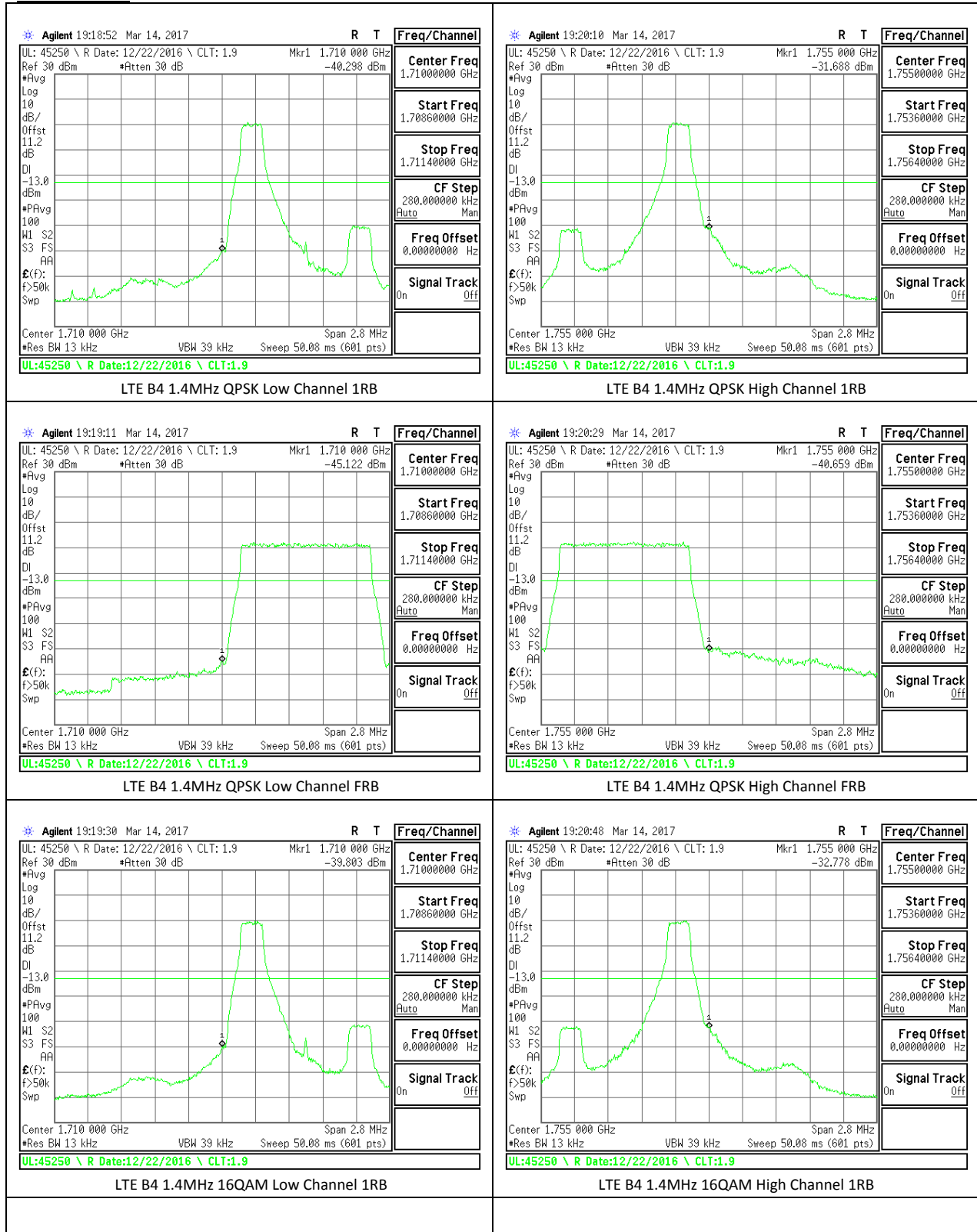

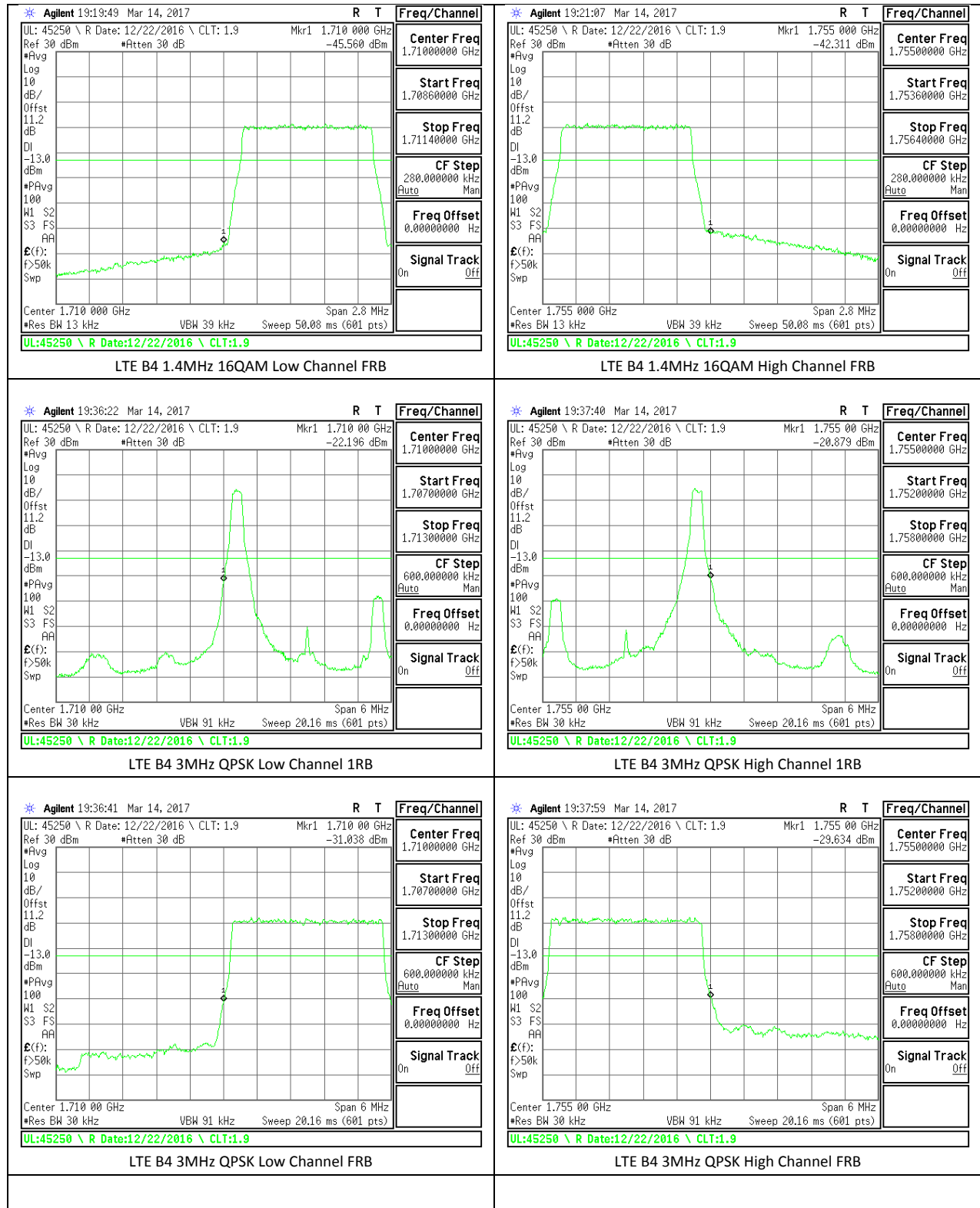

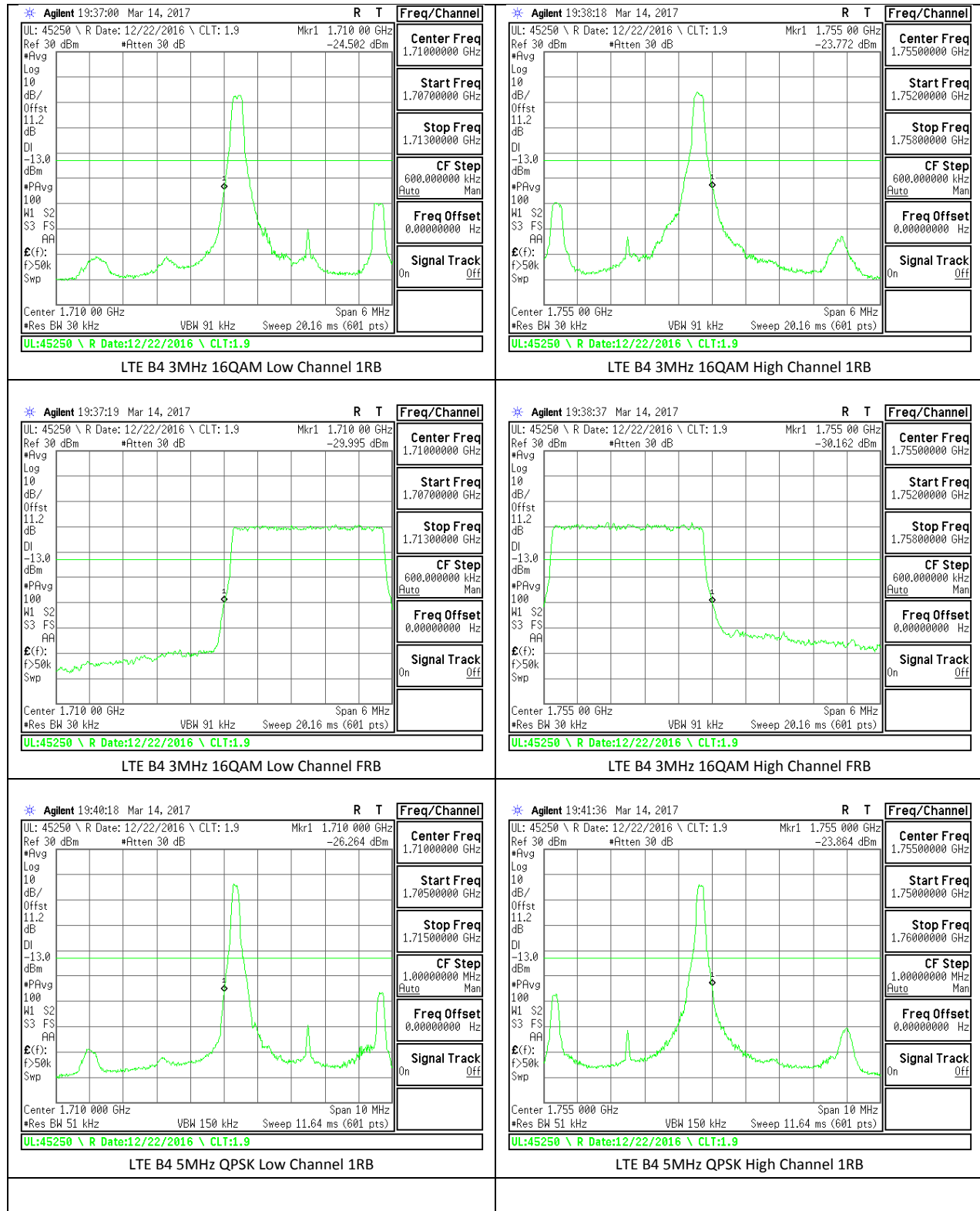

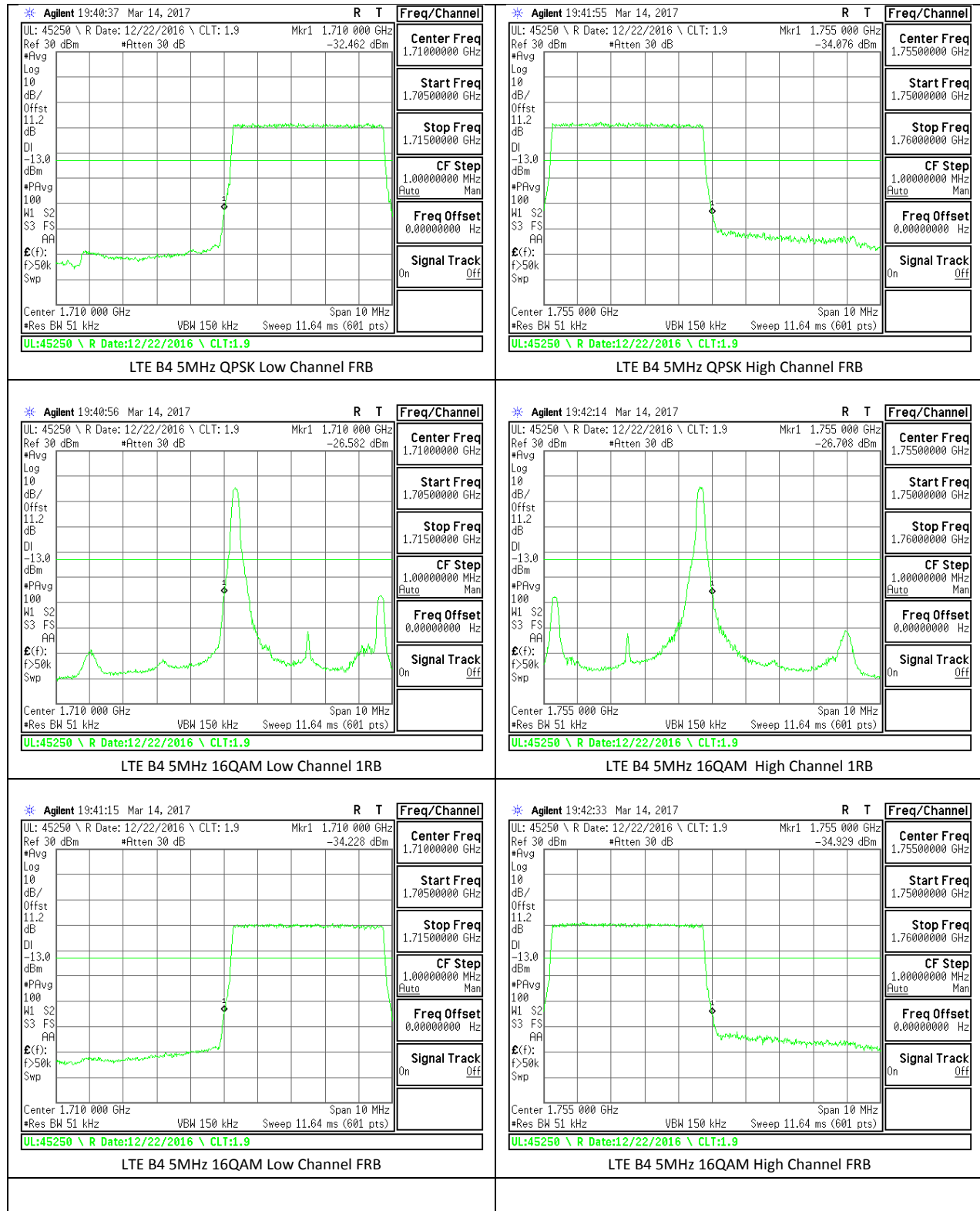

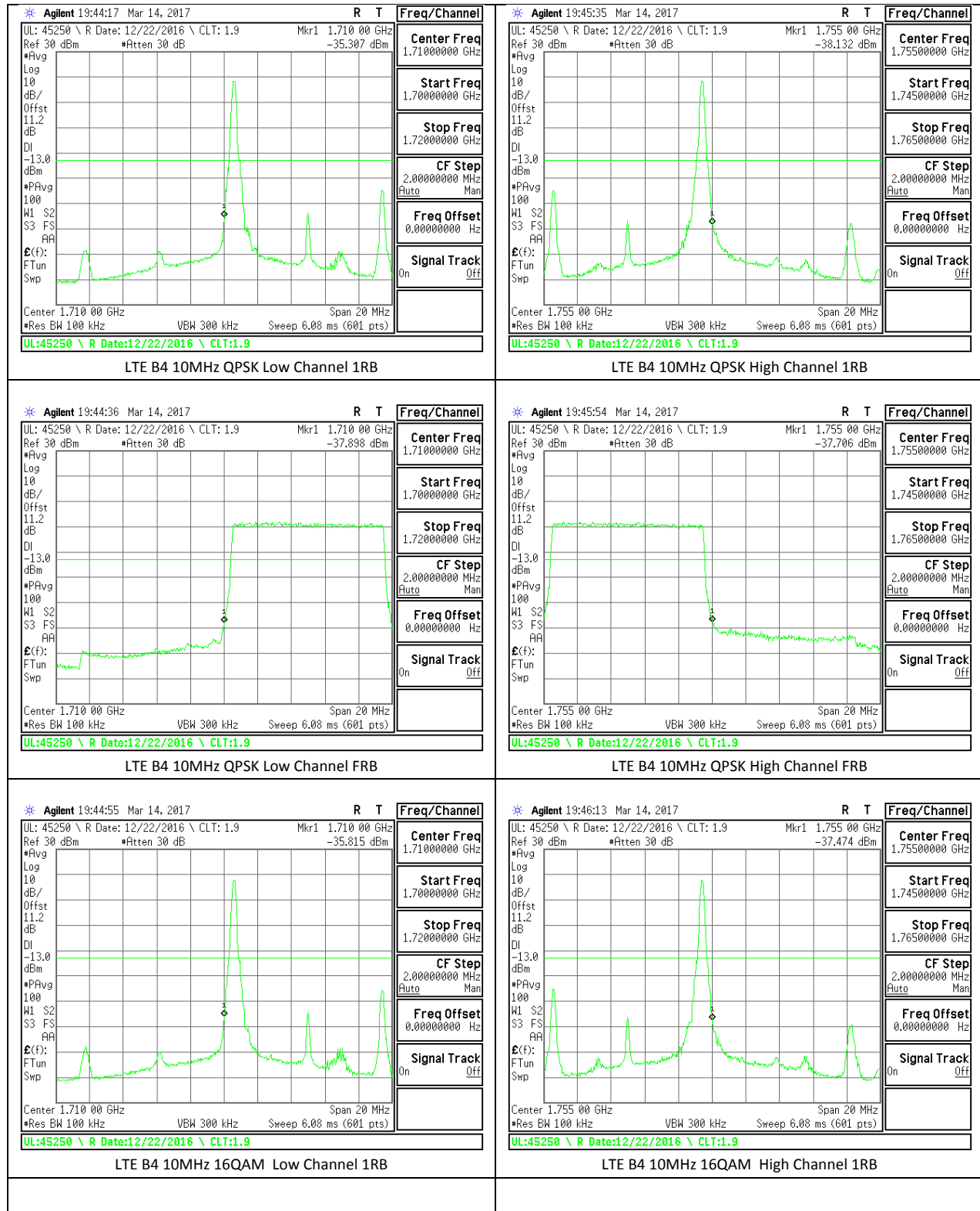

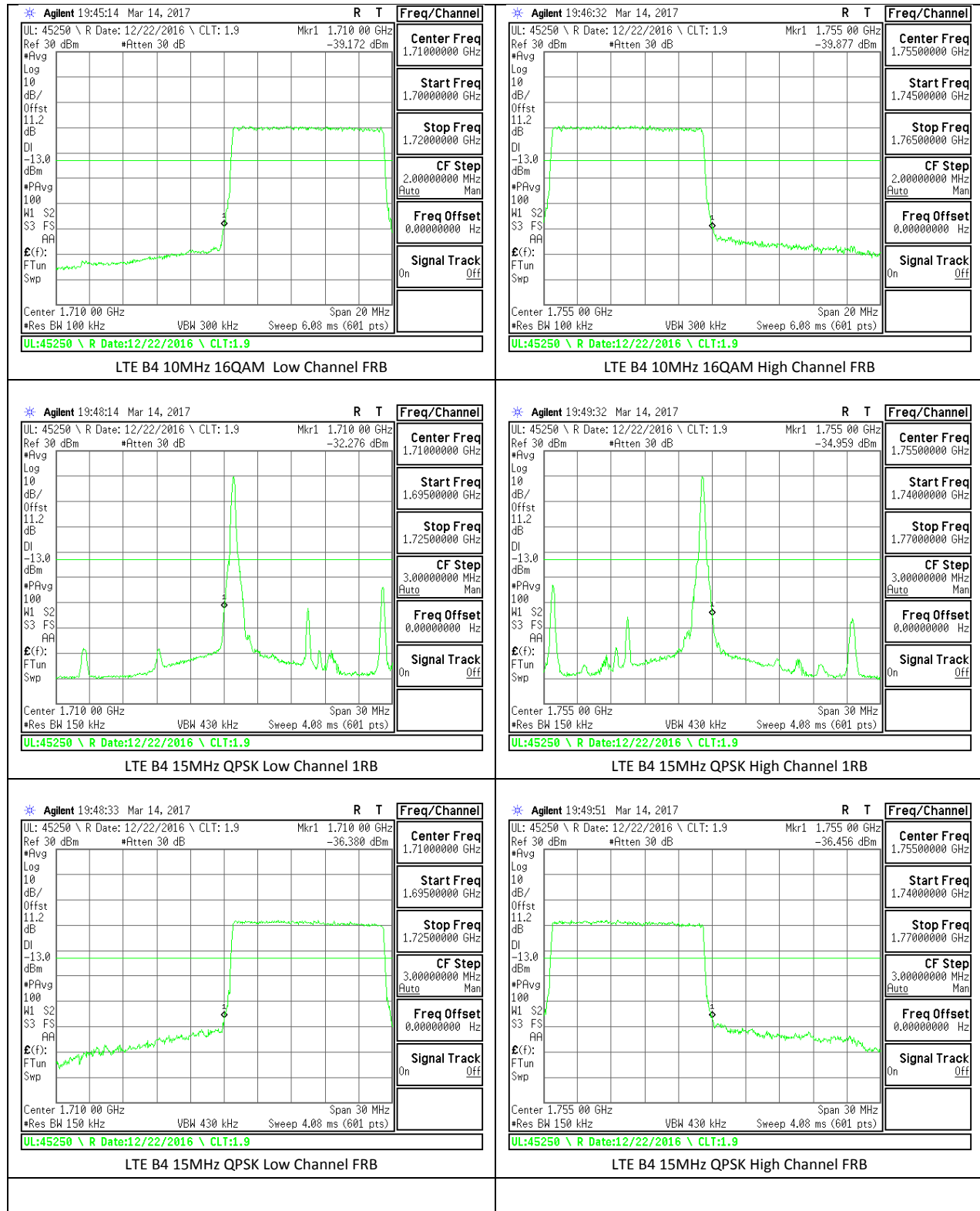

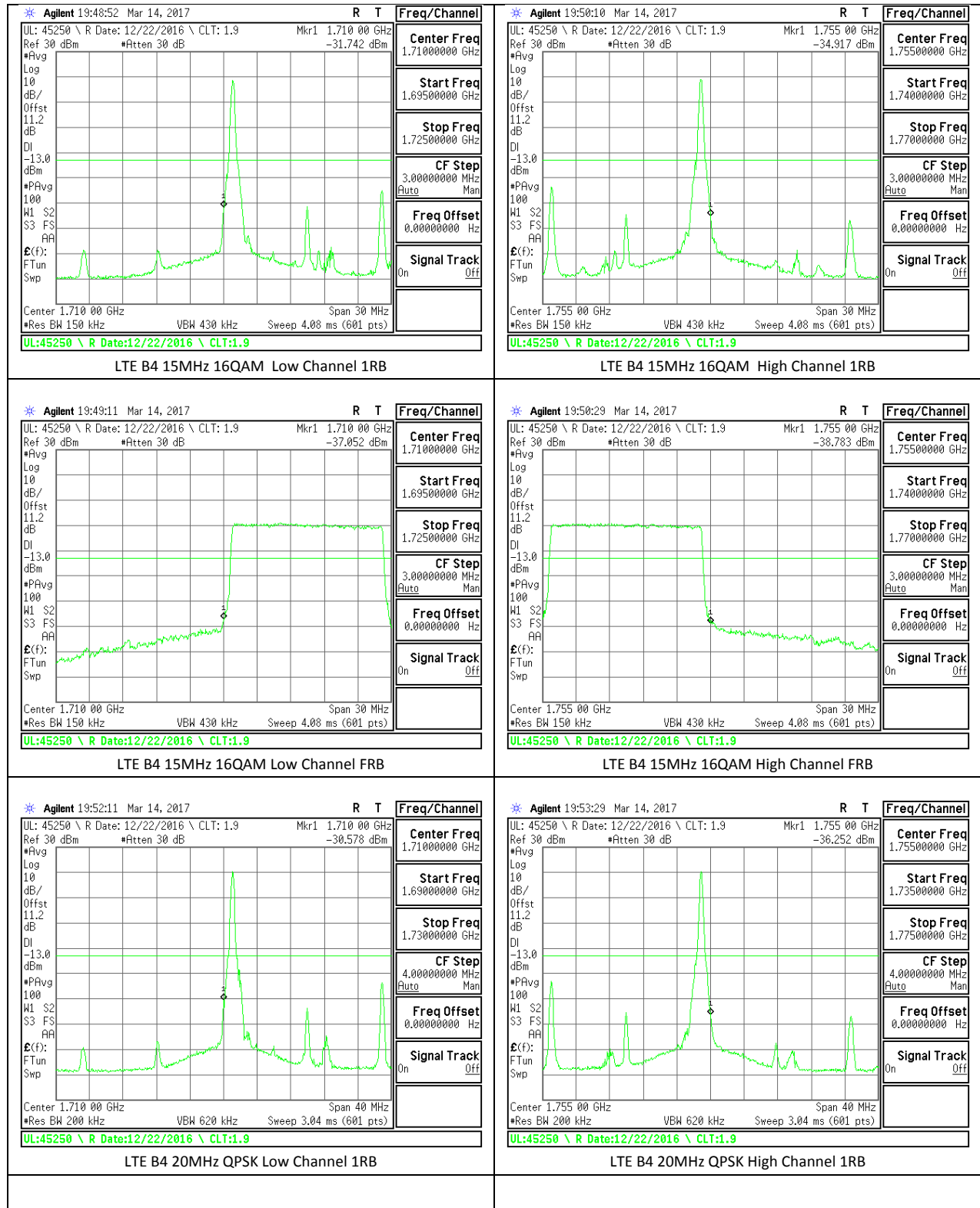

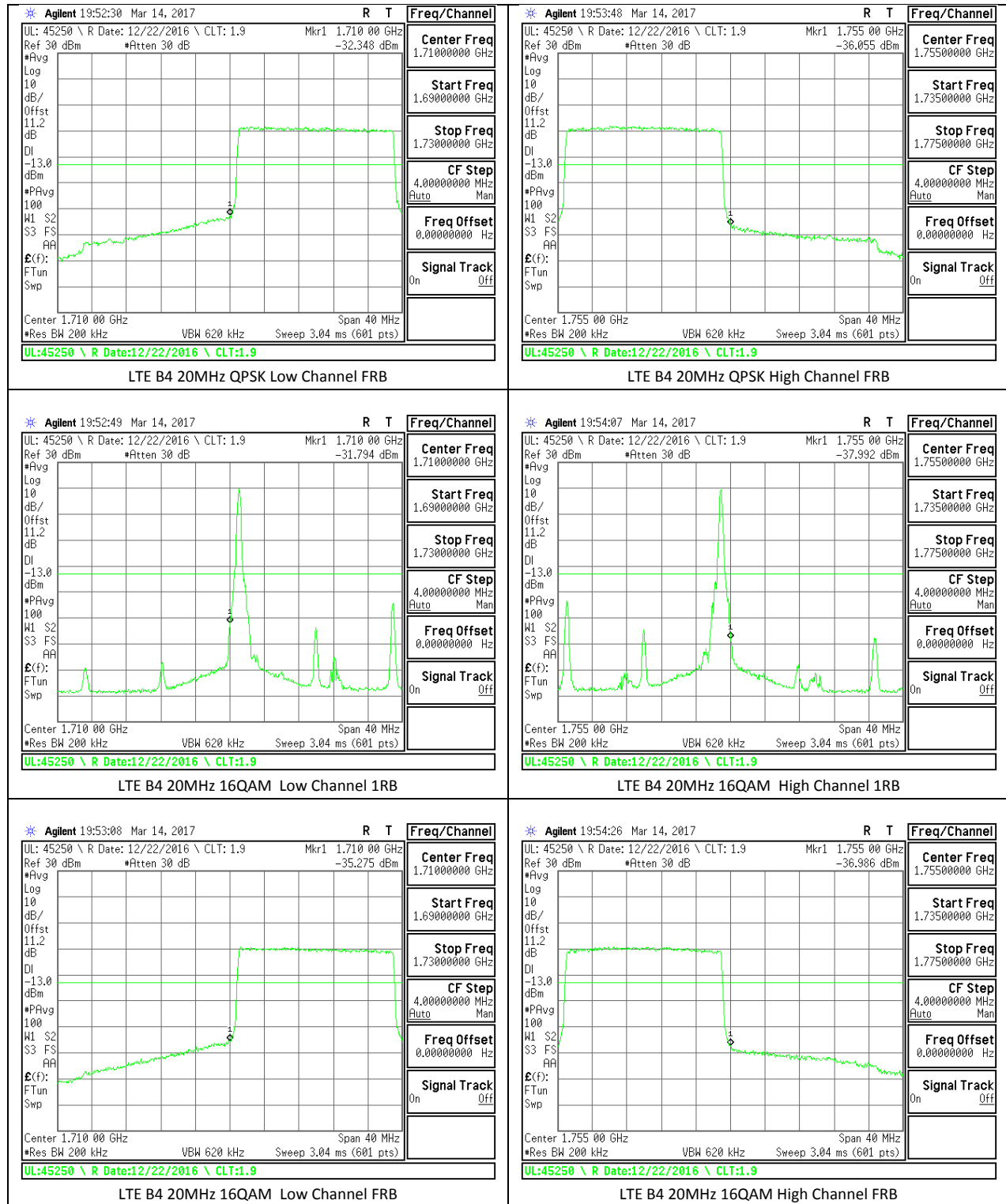

LTE Band 5

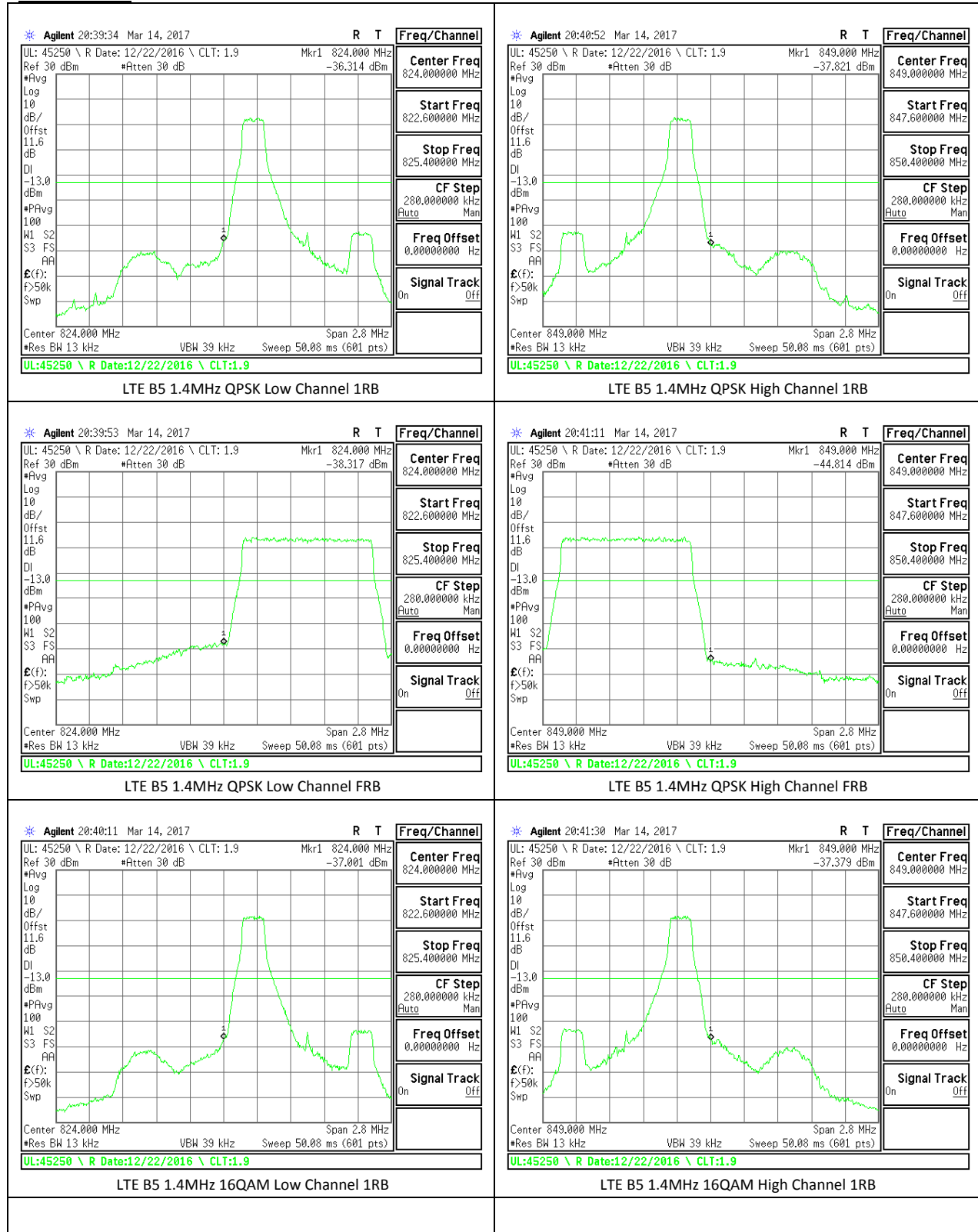

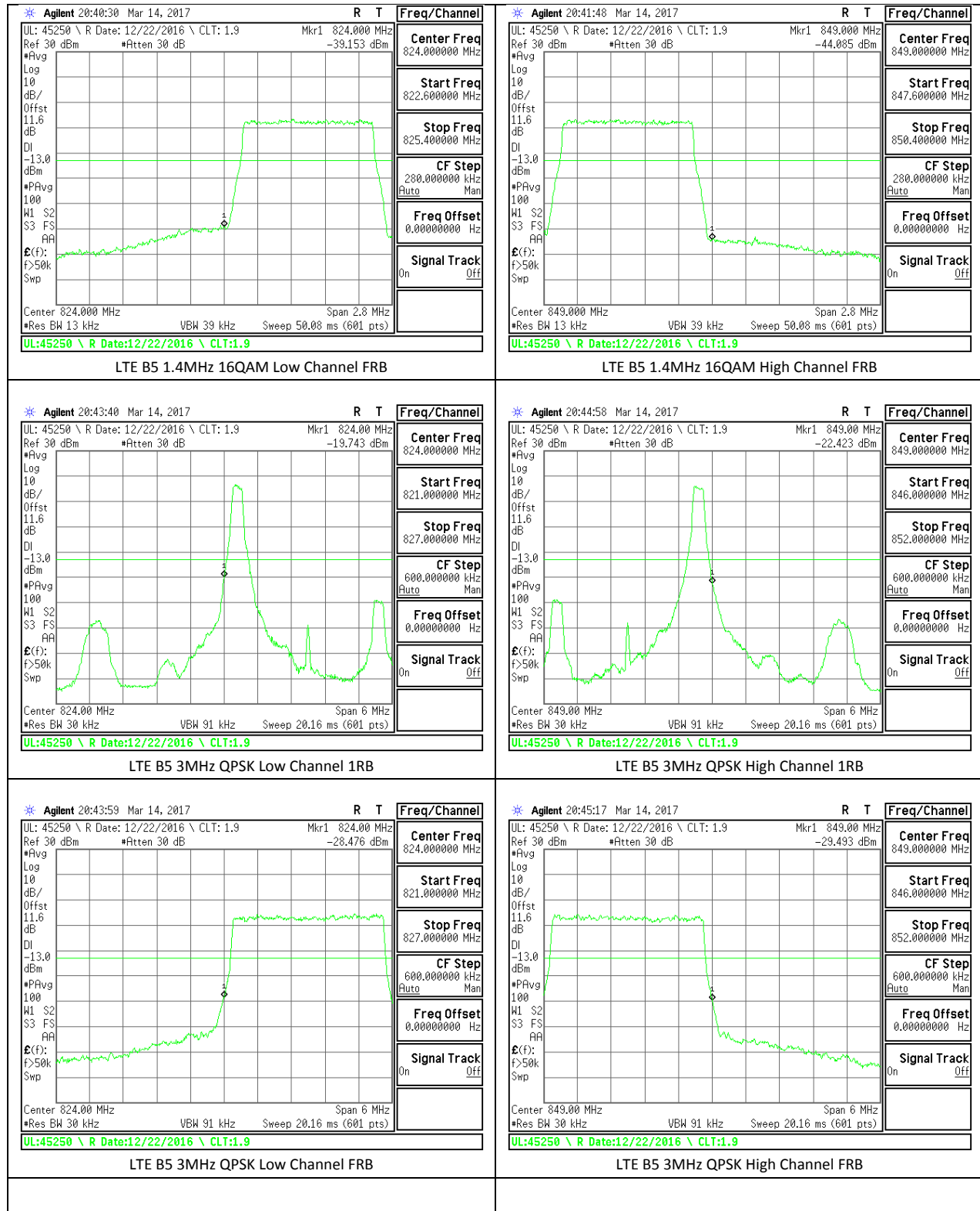

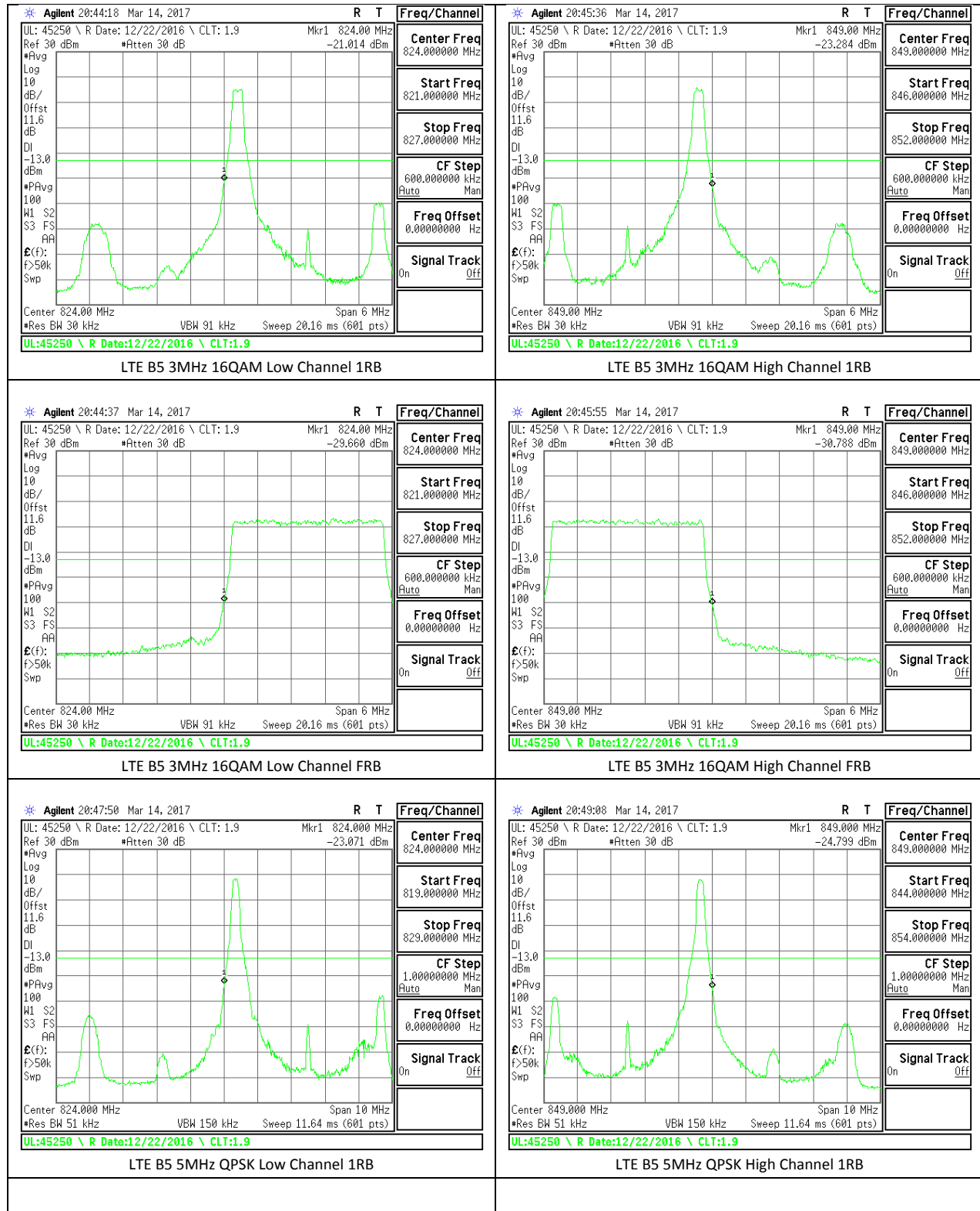

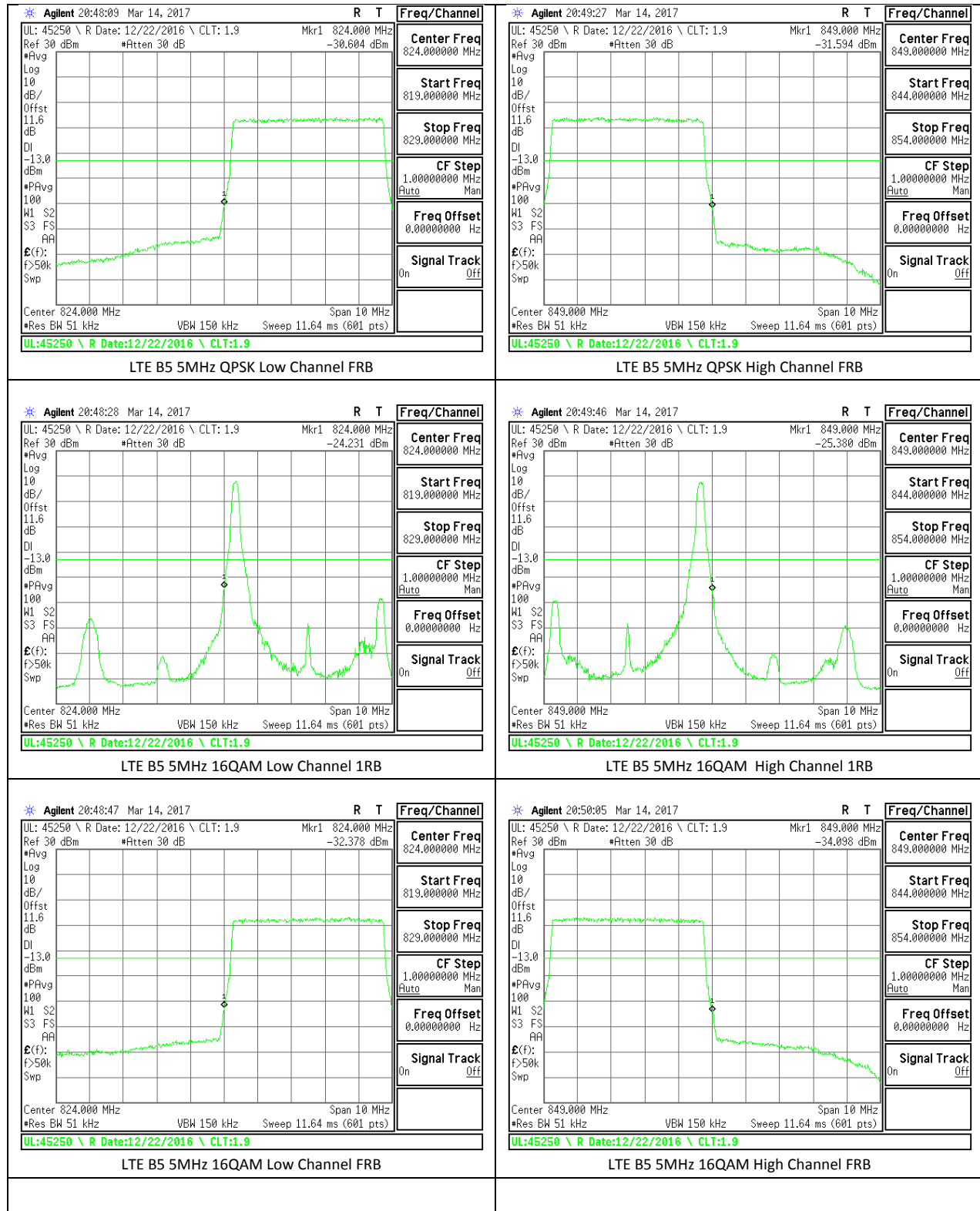

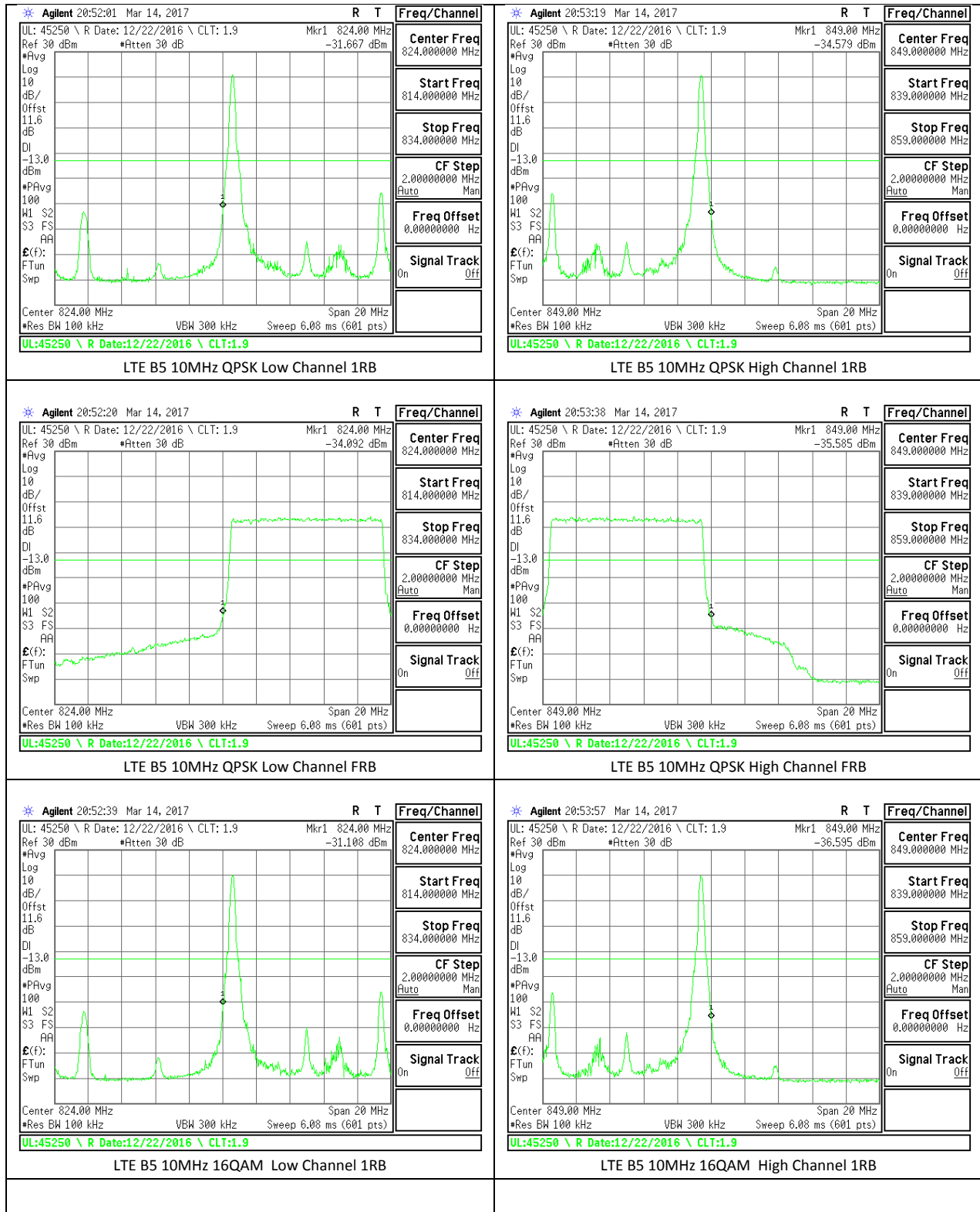

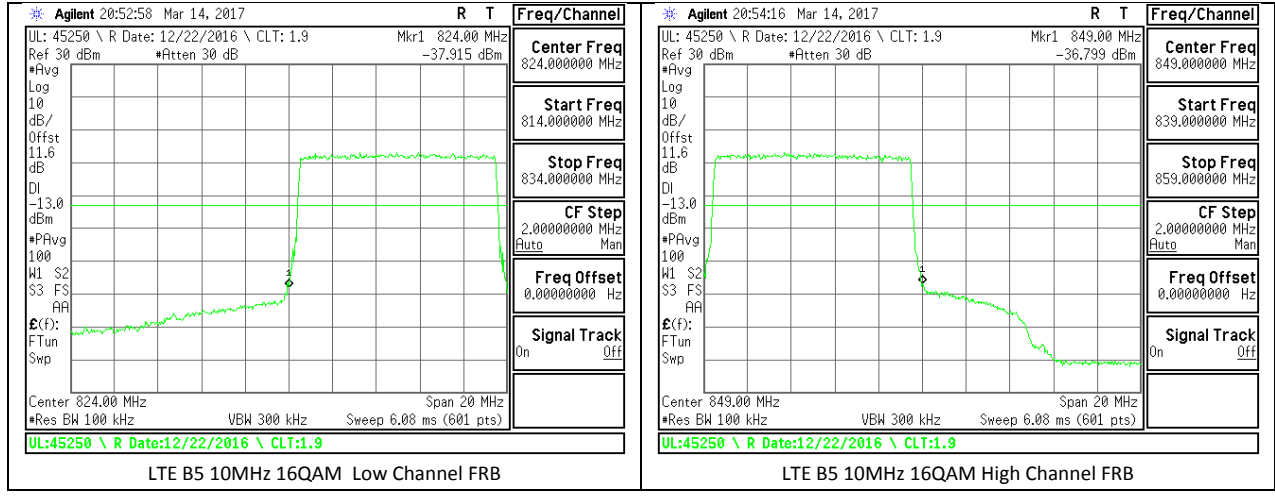

LTE Band 7

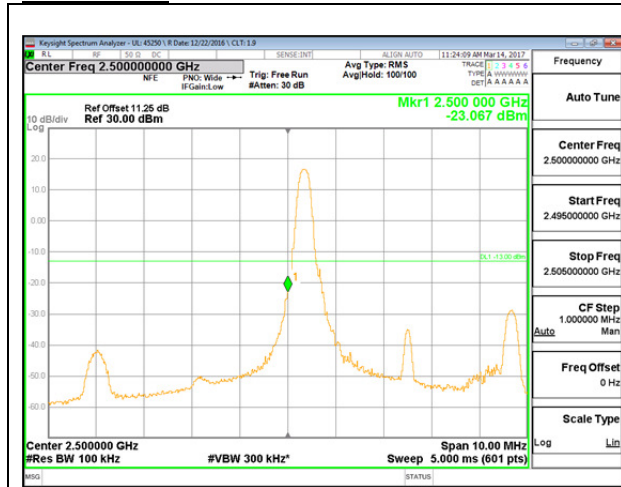

LTE B7 5MHz QPSK Low Channel 1RB

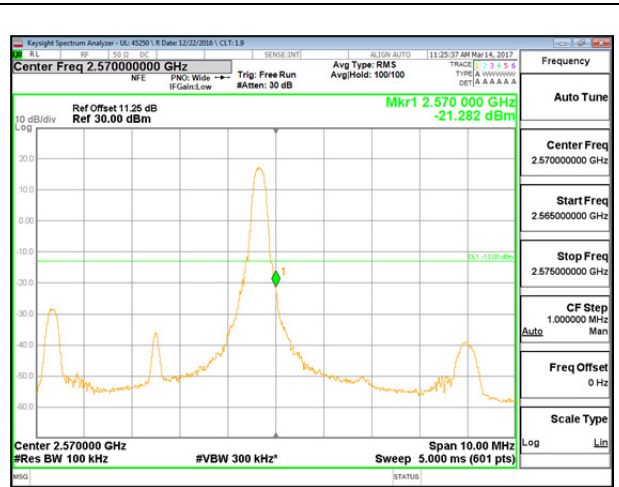

LTE B7 5MHz QPSK High Channel 1RB

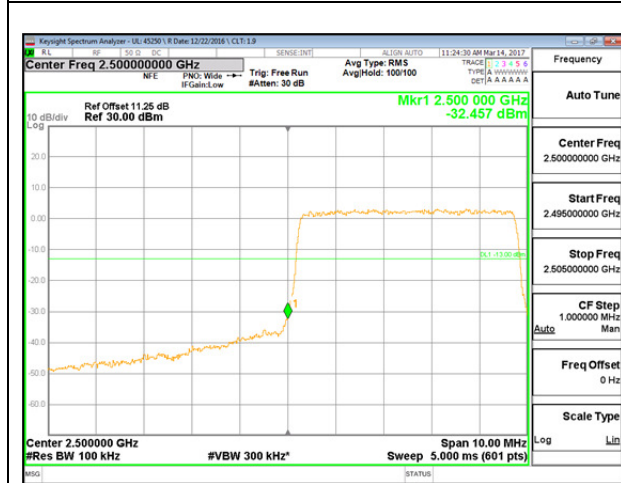

LTE B7 5MHz QPSK Low Channel FRB

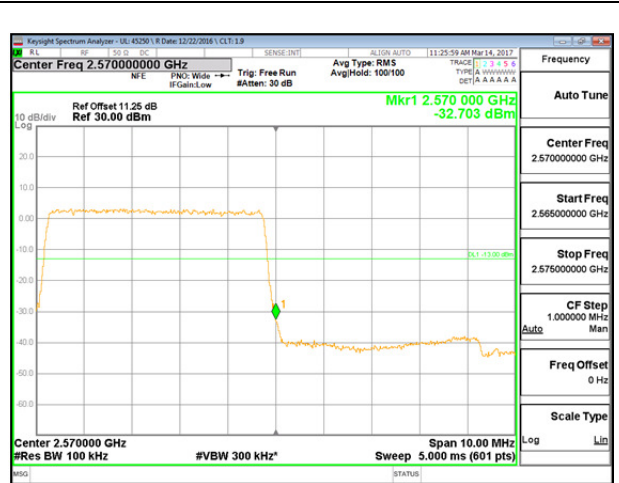

LTE B7 5MHz QPSK High Channel FRB

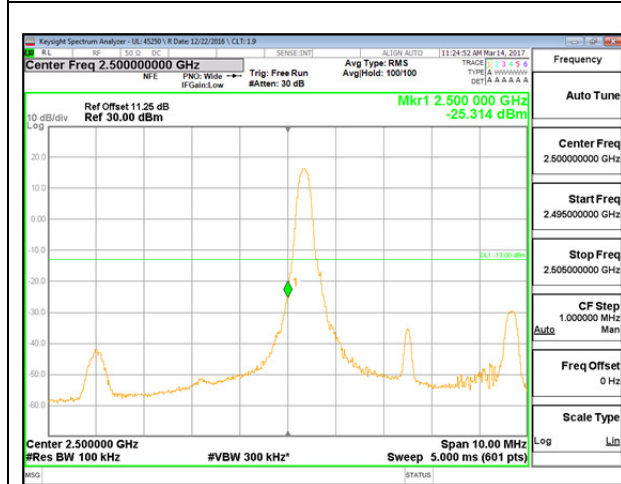

LTE B7 5MHz 16QAM Low Channel 1RB

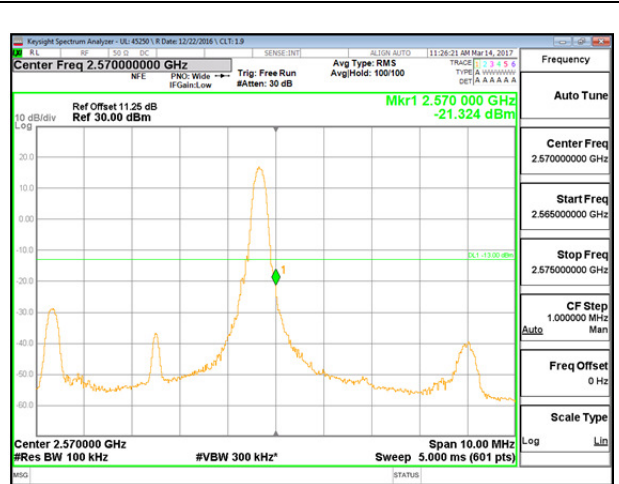

LTE B7 5MHz 16QAM High Channel 1RB

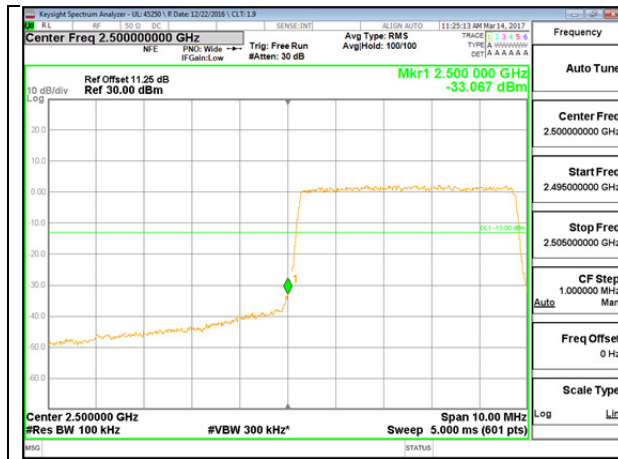

LTE B7 5MHz 16QAM Low Channel FRB

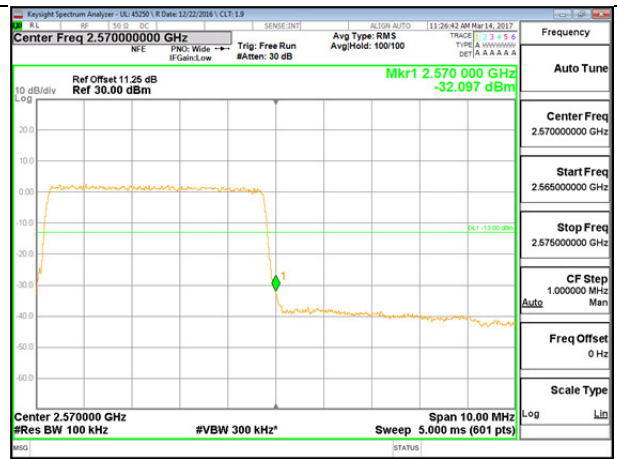

LTE B7 5MHz 16QAM High Channel FRB

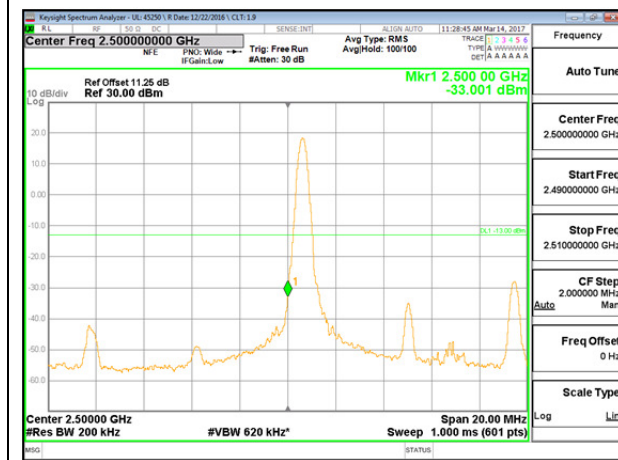

LTE B7 10MHz QPSK Low Channel 1RB

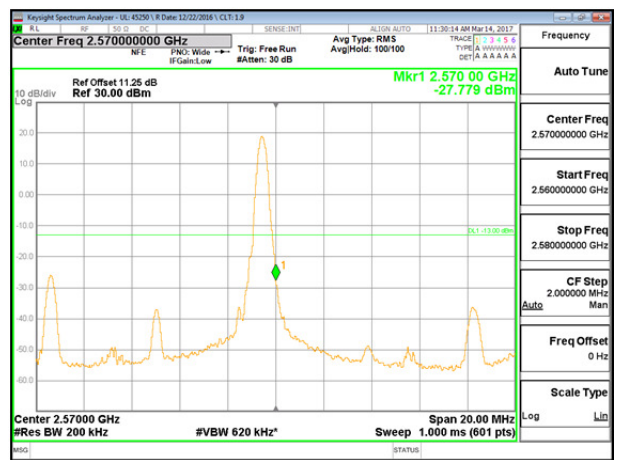

LTE B7 10MHz QPSK High Channel 1RB

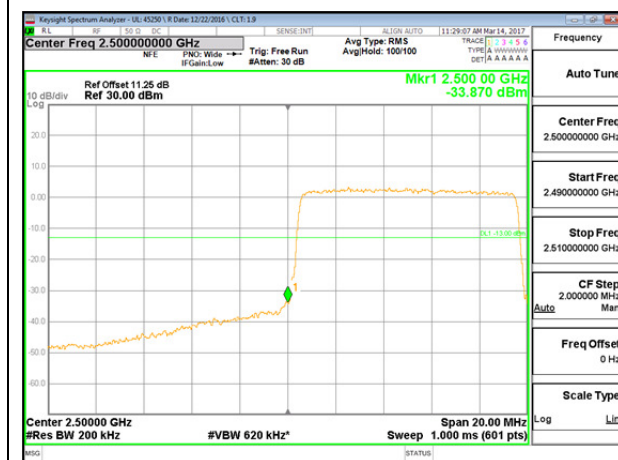

LTE B7 10MHz QPSK Low Channel FRB

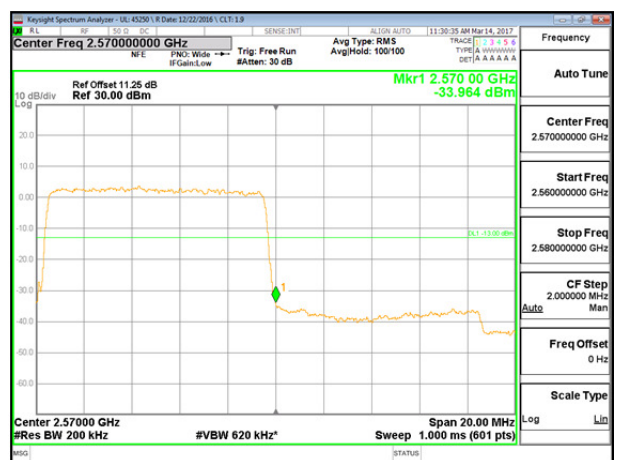

LTE B7 10MHz QPSK High Channel FRB

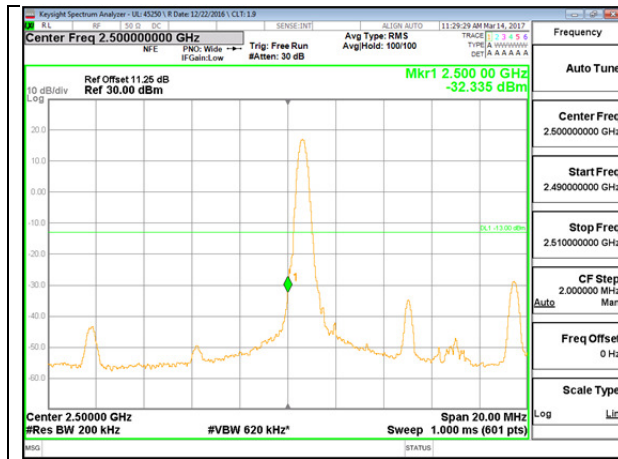

LTE B7 10MHz 16QAM Low Channel 1RB

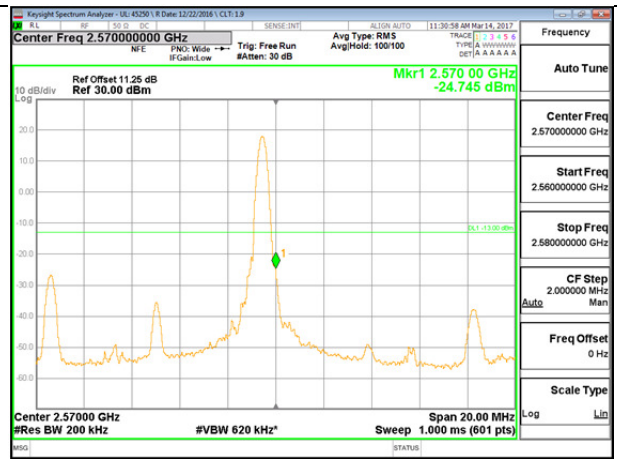

LTE B7 10MHz 16QAM High Channel 1RB

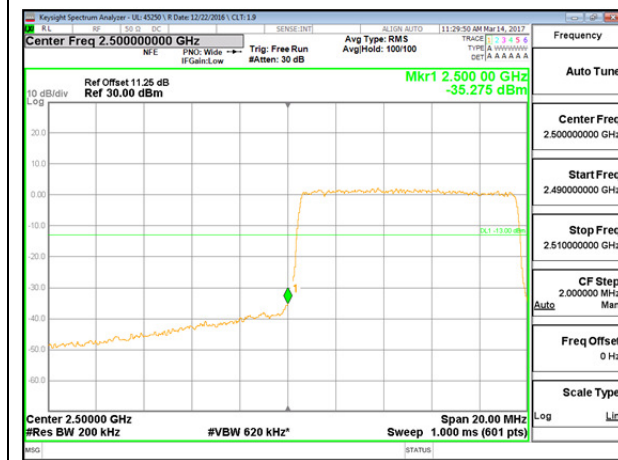

LTE B7 10MHz 16QAM Low Channel FRB

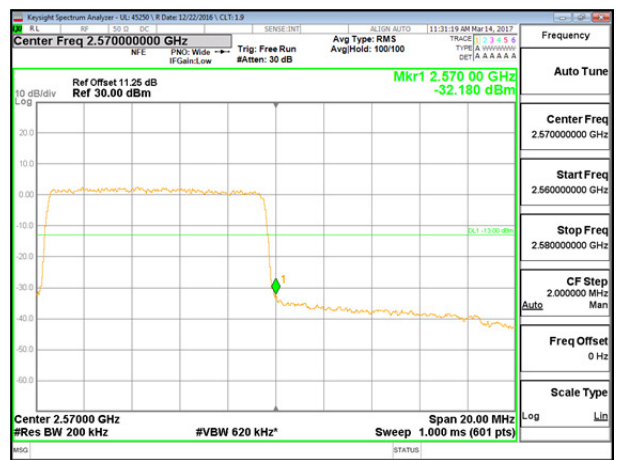

LTE B7 10MHz 16QAM High Channel FRB

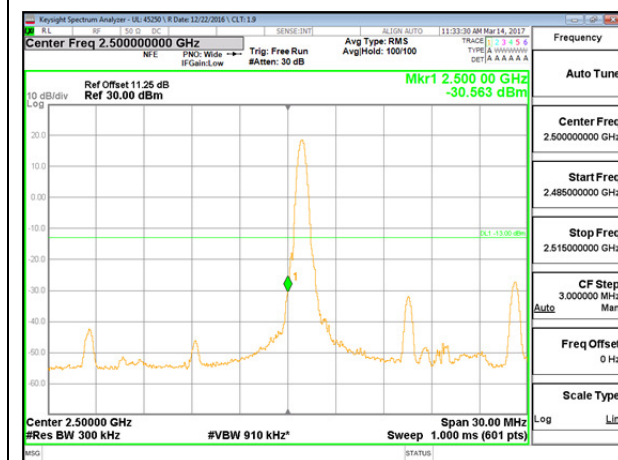

LTE B7 15MHz QPSK Low Channel 1RB

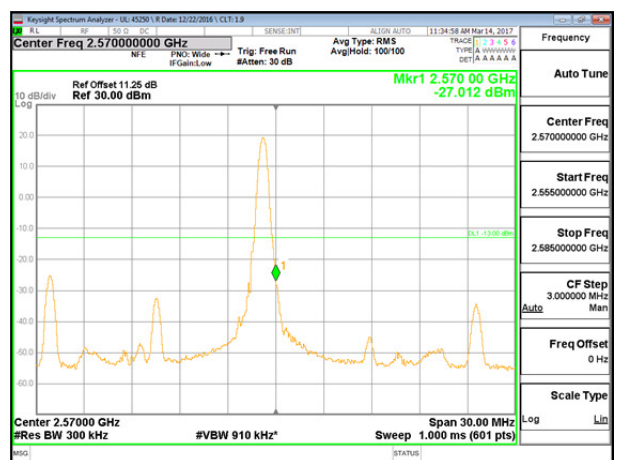

LTE B7 15MHz QPSK High Channel 1RB

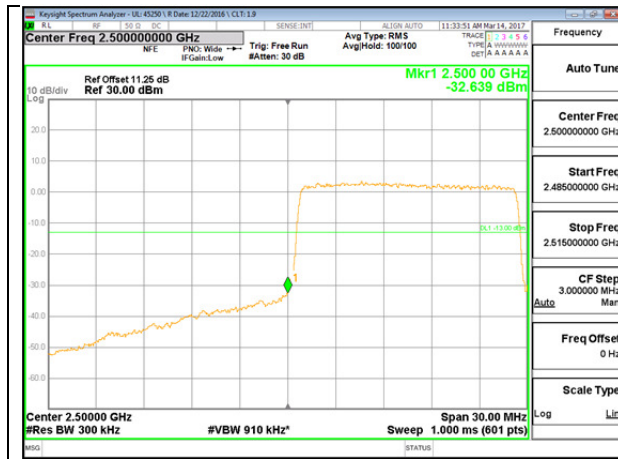

LTE B7 15MHz QPSK Low Channel FRB

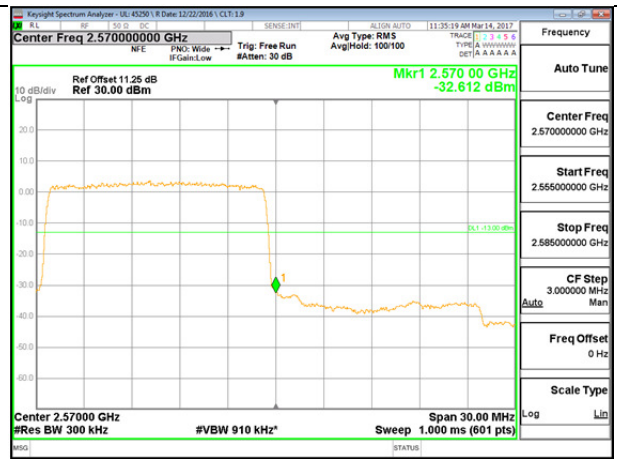

LTE B7 15MHz QPSK High Channel FRB

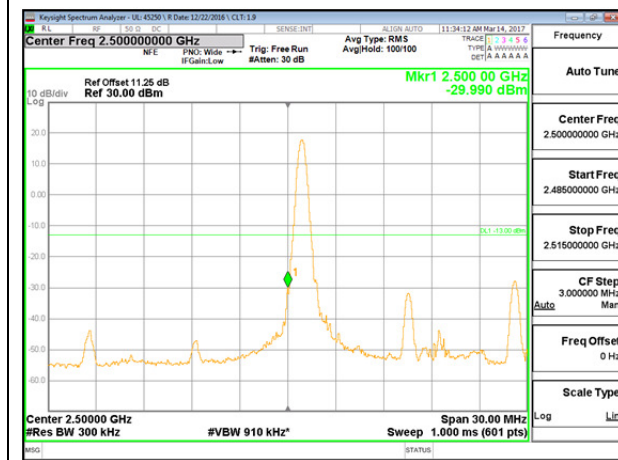

LTE B7 15MHz 16QAM Low Channel 1RB

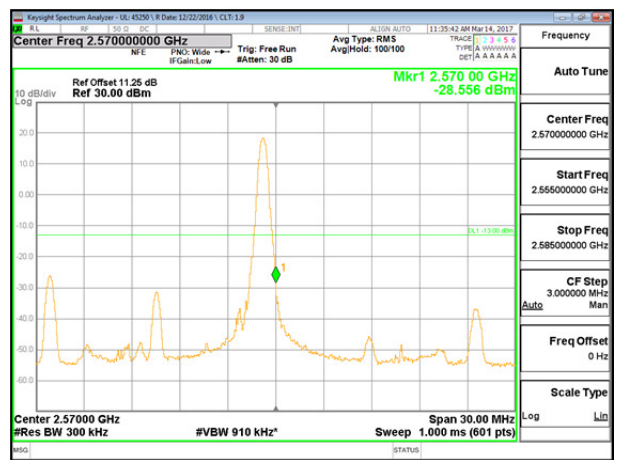

LTE B7 15MHz 16QAM High Channel 1RB

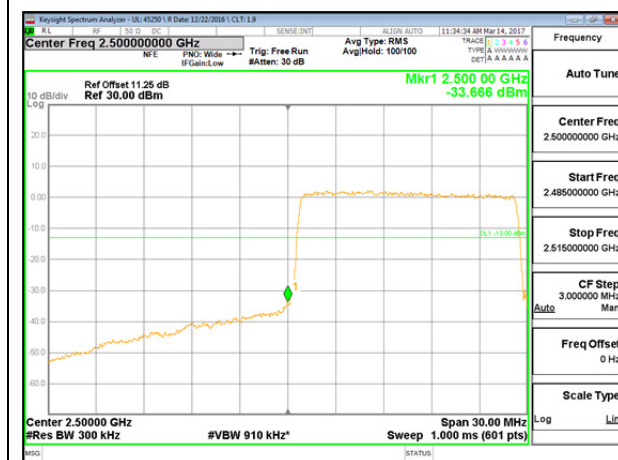

LTE B7 15MHz 16QAM Low Channel FRB

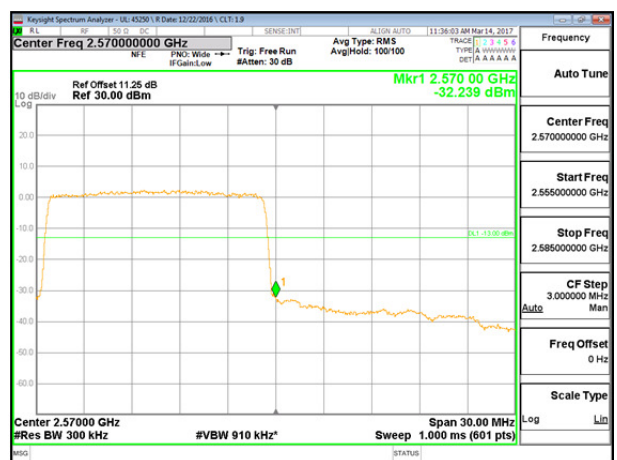

LTE B7 15MHz 16QAM High Channel FRB

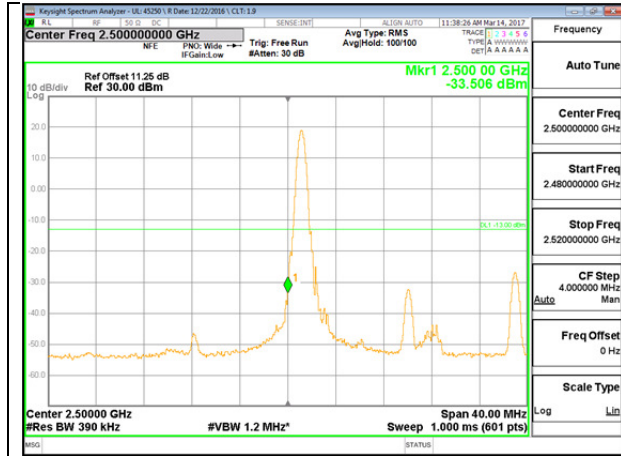

LTE B7 20MHz QPSK Low Channel 1RB

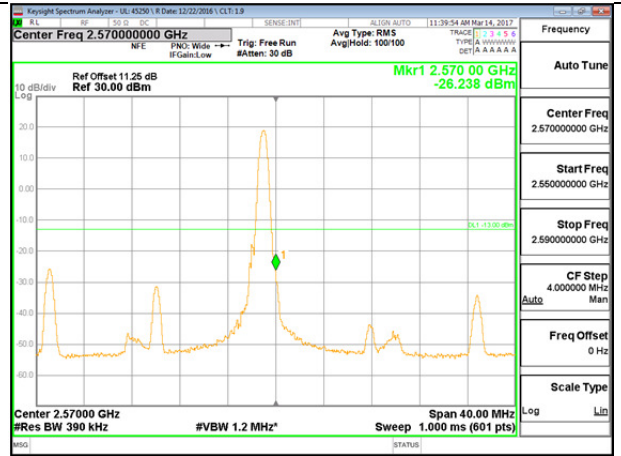

LTE B7 20MHz QPSK High Channel 1RB

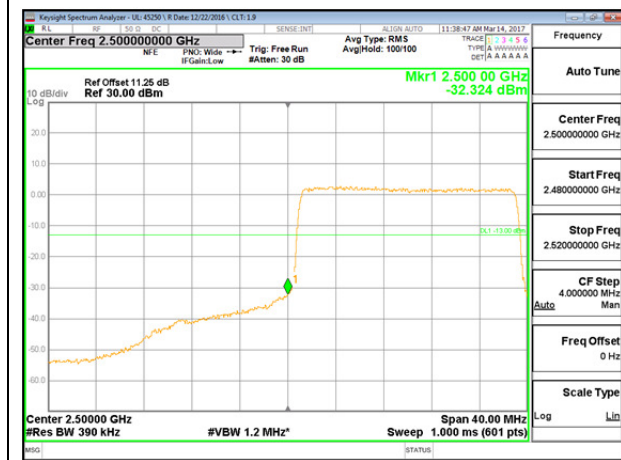

LTE B7 20MHz QPSK Low Channel FRB

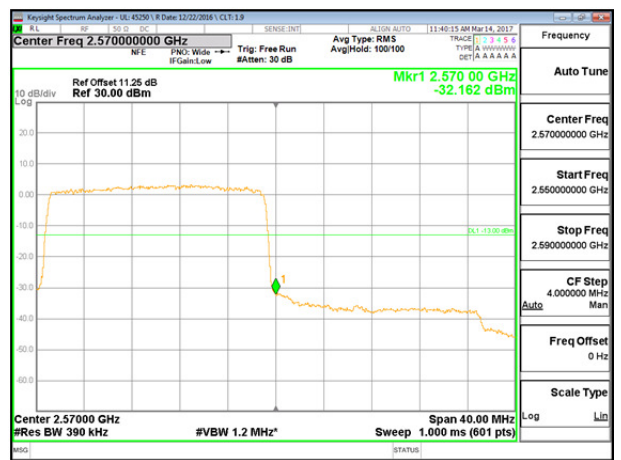

LTE B7 20MHz QPSK High Channel FRB

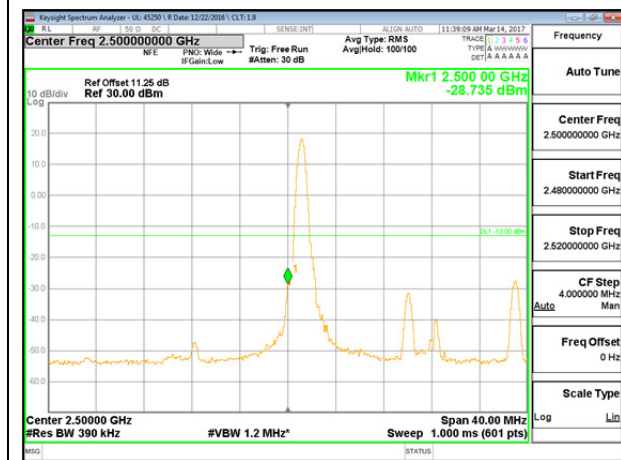

LTE B7 20MHz 16QAM Low Channel 1RB

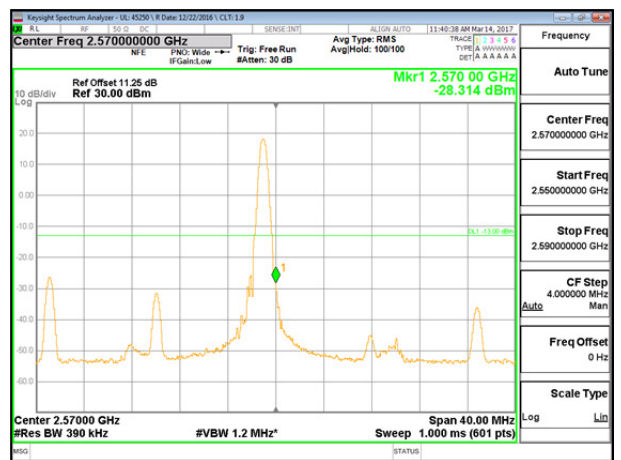

LTE B7 20MHz 16QAM High Channel 1RB

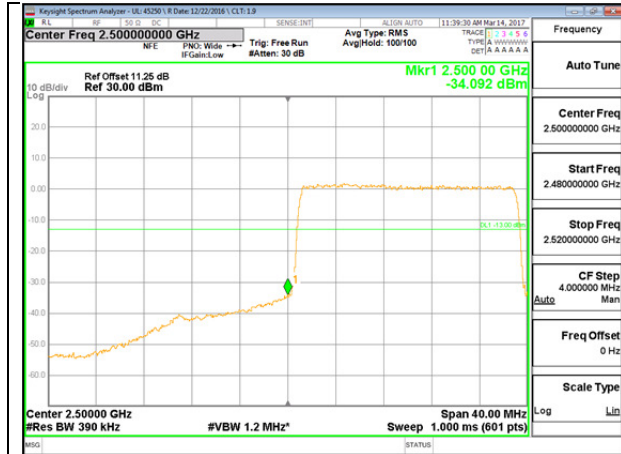

LTE B7 20MHz 16QAM Low Channel FRB

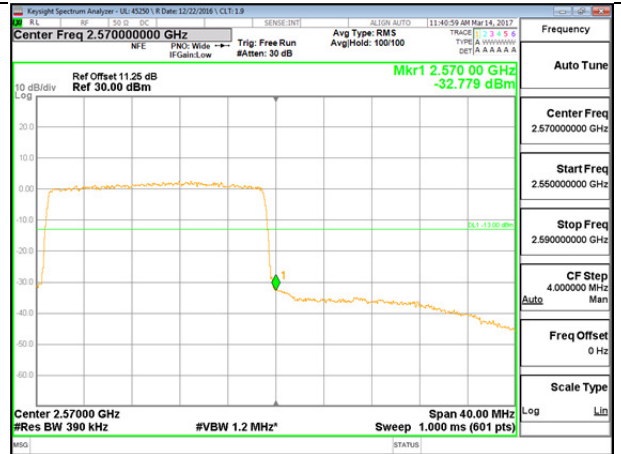

LTE B7 20MHz 16QAM High Channel FRB