



**DFS PORTION of FCC 47 CFR PART 15 SUBPART E
DFS PORTION of INDUSTRY CANADA RSS-247 ISSUE 1**

CERTIFICATION TEST REPORT

FOR

GSM/WCDMA/LTE Phone with BT, BLE, DTS/UNII a/b/g/n/ac & NFC

FCC ID: PY7-54254H

REPORT NUMBER: 11626381H-E6V1

ISSUE DATE: APRIL 06, 2017

Prepared for
**SONY MOBILE COMMUNICATIONS, INC.
4-12-3 HIGASHI-SHINAGAWA,
SHINAGAWA -KU, TOKYO, 140-0002, JAPAN**

Prepared by
**UL VERIFICATION SERVICES INC.
47173 BENICIA STREET
FREMONT, CA 94538, U.S.A.
TEL: (510) 771-1000
FAX: (510) 661-0888**



NVLAP LAB CODE 200065-0

Revision History

| <u>Rev.</u> | <u>Issue Date</u> | <u>Revisions</u> | <u>Revised By</u> |
|-------------|-------------------|------------------|-------------------|
| V1 | 04/06/17 | Initial Issue | Conan Cheung |

TABLE OF CONTENTS

| | |
|---|-----------|
| 1. ATTESTATION OF TEST RESULTS | 4 |
| 2. TEST METHODOLOGY | 5 |
| 3. FACILITIES AND ACCREDITATION | 5 |
| 4. CALIBRATION AND UNCERTAINTY | 5 |
| 4.1. MEASURING INSTRUMENT CALIBRATION | 5 |
| 4.2. SAMPLE CALCULATION | 5 |
| 4.3. MEASUREMENT UNCERTAINTY | 5 |
| 5. DYNAMIC FREQUENCY SELECTION | 6 |
| 5.1. OVERVIEW | 6 |
| 5.1.1. LIMITS | 6 |
| 5.1.2. TEST AND MEASUREMENT SYSTEM | 10 |
| 5.1.3. TEST AND MEASUREMENT SOFTWARE | 12 |
| 5.1.4. SETUP OF EUT | 13 |
| 5.1.5. DESCRIPTION OF EUT | 14 |
| 5.2. RESULTS FOR 20 MHz BANDWIDTH | 16 |
| 5.2.1. TEST CHANNEL | 16 |
| 5.2.2. RADAR WAVEFORM AND TRAFFIC | 16 |
| 5.2.3. OVERLAPPING CHANNEL TESTS | 19 |
| 5.2.4. MOVE AND CLOSING TIME | 19 |
| 5.3. RESULTS FOR 40 MHz BANDWIDTH | 23 |
| 5.3.1. TEST CHANNEL | 23 |
| 5.3.2. RADAR WAVEFORM AND TRAFFIC | 23 |
| 5.3.3. OVERLAPPING CHANNEL TESTS | 26 |
| 5.3.4. MOVE AND CLOSING TIME | 26 |
| 5.4. RESULTS FOR 80 MHz BANDWIDTH | 30 |
| 5.4.1. TEST CHANNEL | 30 |
| 5.4.2. RADAR WAVEFORM AND TRAFFIC | 30 |
| 5.4.3. OVERLAPPING CHANNEL TESTS | 33 |
| 5.4.4. MOVE AND CLOSING TIME | 33 |
| 5.4.1. 10-MINUTE BEACON MONITORING PERIOD | 37 |
| 6. SETUP PHOTOS | 38 |

1. ATTESTATION OF TEST RESULTS

COMPANY NAME: SONY MOBILE COMMUNICATIONS, INC.
4-12-3 HIGASHI-SHINAGAWA,
SHINAGAWA -KU, TOKYO, 140-0002, JAPAN

EUT DESCRIPTION: GSM/WCDMA/LTE Phone with BT, BLE, DTS/UNII a/b/g/n/ac & NFC

SERIAL NUMBER: CB512DQZZA

DATE TESTED: MARCH 21, 2017

| APPLICABLE STANDARDS | |
|---|--------------|
| STANDARD | TEST RESULTS |
| DFS Portion of CFR 47 Part 15 Subpart E | Pass |
| INDUSTRY CANADA RSS-247 Issue 1 | Pass |

UL Verification Services Inc. tested the above equipment in accordance with the requirements set forth in the above standards. All indications of Pass/Fail in this report are opinions expressed by UL Verification Services Inc. based on interpretations and/or observations of test results. Measurement Uncertainties were not taken into account and are published for informational purposes only. The test results show that the equipment tested is capable of demonstrating compliance with the requirements as documented in this report.

Note: The results documented in this report apply only to the tested sample, under the conditions and modes of operation as described herein. This document may not be altered or revised in any way unless done so by UL Verification Services Inc. and all revisions are duly noted in the revisions section. Any alteration of this document not carried out by UL Verification Services Inc. will constitute fraud and shall nullify the document. This report must not be used by the client to claim product certification, approval, or endorsement by NVLAP, NIST, any agency of the Federal Government, or any agency of any government.

Approved & Released For
UL Verification Services Inc. By:

Tested By:



CONAN CHEUNG
PROJECT LEAD
UL Verification Services Inc.

HENRY LAU
EMC ENGINEER
UL Verification Services Inc.

2. TEST METHODOLOGY

The tests documented in this report were performed in accordance with the DFS portion of FCC CFR 47 Part 2, FCC CFR 47 Part 15, FCC 06-96, FCC KDB 789033, KDB 905462 D02 and D03, ANSI C63.10-2013, RSS-247 Issue 1.

3. FACILITIES AND ACCREDITATION

The test sites and measurement facilities used to collect data are located at 47173 Benicia Street, Fremont, California, USA.

UL Verification Services, Inc. is accredited by NVLAP, Laboratory Code 200065-0. The full scope of accreditation can be viewed at <http://ts.nist.gov/standards/scopes/2000650.htm>.

4. CALIBRATION AND UNCERTAINTY

4.1. MEASURING INSTRUMENT CALIBRATION

The measuring equipment utilized to perform the tests documented in this report has been calibrated in accordance with the manufacturer's recommendations, and is traceable to recognized national standards.

4.2. SAMPLE CALCULATION

Where relevant, the following sample calculation is provided:

$$\begin{aligned} \text{Field Strength (dBuV/m)} &= \text{Measured Voltage (dBuV)} + \text{Antenna Factor (dB/m)} + \\ &\text{Cable Loss (dB)} - \text{Preamp Gain (dB)} \\ 36.5 \text{ dBuV} + 18.7 \text{ dB/m} + 0.6 \text{ dB} - 26.9 \text{ dB} &= 28.9 \text{ dBuV/m} \end{aligned}$$

4.3. MEASUREMENT UNCERTAINTY

Where relevant, the following measurement uncertainty levels have been estimated for tests performed on the apparatus:

| PARAMETER | UNCERTAINTY |
|---------------------------------------|-------------|
| Conducted Disturbance, 0.15 to 30 MHz | ± 3.52 dB |
| Radiated Disturbance, 30 to 1000 MHz | ± 4.94 dB |
| Radiated Disturbance, 1 to 6 GHz | ± 3.86 dB |
| Radiated Disturbance, 6 to 18 GHz | ± 4.23 dB |
| Radiated Disturbance, 18 to 26 GHz | ± 5.30 dB |
| Radiated Disturbance, 26 to 40 GHz | ± 5.23 dB |

Uncertainty figures are valid to a confidence level of 95%.

5. DYNAMIC FREQUENCY SELECTION

5.1. OVERVIEW

5.1.1. LIMITS

INDUSTRY CANADA

IC RSS-247 is closely harmonized with FCC Part 15 DFS rules. The deviations are as follows:

RSS-247 Issue 1

Note: For the band 5600–5650 MHz, no operation is permitted.

Until further notice, devices subject to this annex shall not be capable of transmitting in the band 5600–5650 MHz. This restriction is for the protection of Environment Canada weather radars operating in this band.

FCC

§15.407 (h), FCC KDB 905462 D02 “COMPLIANCE MEASUREMENT PROCEDURES FOR UNLICENSED-NATIONAL INFORMATION INFRASTRUCTURE DEVICES OPERATING IN THE 5250-5350 MHz AND 5470-5725 MHz BANDS INCORPORATING DYNAMIC FREQUENCY SELECTION” and KDB 905462 D03 “U-NII CLIENT DEVICES WITHOUT RADAR DETECTION CAPABILITY”.

Table 1: Applicability of DFS requirements prior to use of a channel

| Requirement | Operational Mode | | |
|---------------------------------|------------------|----------------------------------|-------------------------------|
| | Master | Client (without radar detection) | Client (with radar detection) |
| Non-Occupancy Period | Yes | Not required | Yes |
| DFS Detection Threshold | Yes | Not required | Yes |
| Channel Availability Check Time | Yes | Not required | Not required |
| U-NII Detection Bandwidth | Yes | Not required | Yes |

Table 2: Applicability of DFS requirements during normal operation

| Requirement | Operational Mode | | |
|-----------------------------------|------------------|----------------------|-------------------|
| | Master | Client (without DFS) | Client (with DFS) |
| DFS Detection Threshold | Yes | Not required | Yes |
| Channel Closing Transmission Time | Yes | Yes | Yes |
| Channel Move Time | Yes | Yes | Yes |
| U-NII Detection Bandwidth | Yes | Not required | Yes |

| Additional requirements for devices with multiple bandwidth modes | Master Device or Client with Radar DFS | Client (without DFS) |
|--|--|--|
| <i>U-NII Detection Bandwidth and Statistical Performance Check</i> | All BW modes must be tested | Not required |
| <i>Channel Move Time and Channel Closing Transmission Time</i> | Test using widest BW mode available | Test using the widest BW mode available for the link |
| <i>All other tests</i> | Any single BW mode | Not required |
| Note: Frequencies selected for statistical performance check (Section 7.8.4) should include several frequencies within the radar detection bandwidth and frequencies near the edge of the radar detection bandwidth. For 802.11 devices it is suggested to select frequencies in all 20 MHz channel blocks and a null frequency between the bonded 20 MHz channel blocks. | | |

Table 3: Interference Threshold values, Master or Client incorporating In-Service Monitoring

| | |
|---|----------------------|
| Maximum Transmit Power | Value (see notes) |
| E.I.R.P. \geq 200 mill watt | -64 dBm |
| E.I.R.P. < 200 mill watt and power spectral density < 10 dBm/MHz | -62 dBm |
| E.I.R.P. < 200 mill watt that do not meet power spectral density requirement | -64 dBm |
| <p>Note 1: This is the level at the input of the receiver assuming a 0 dBi receive antenna</p> <p>Note 2: Throughout these test procedures an additional 1 dB has been added to the amplitude of the test transmission waveforms to account for variations in measurement equipment. This will ensure that the test signal is at or above the detection threshold level to trigger a DFS response.</p> <p>Note 3: E.I.R.P. is based on the highest antenna gain. For MIMO devices refer to KDB publication 662911 D01.</p> | |

Table 4: DFS Response requirement values

| Parameter | Value |
|--|--|
| <i>Non-occupancy period</i> | 30 minutes |
| <i>Channel Availability Check Time</i> | 60 seconds |
| <i>Channel Move Time</i> | 10 seconds (See Note 1) |
| <i>Channel Closing Transmission Time</i> | 200 milliseconds + approx. 60 milliseconds over remaining 10 second period. (See Notes 1 and 2) |
| <i>U-NII Detection Bandwidth</i> | Minimum 100% of the U-NII 99% transmission power bandwidth. (See Note 3) |
| <p>Note 1: <i>Channel Move Time</i> and the <i>Channel Closing Transmission Time</i> should be performed with Radar Type 0. The measurement timing begins at the end of the Radar Type 0 burst.</p> <p>Note 2: The <i>Channel Closing Transmission Time</i> is comprised of 200 milliseconds starting at the beginning of the <i>Channel Move Time</i> plus any additional intermittent control signals required to facilitate a <i>Channel</i> move (an aggregate of 60 milliseconds) during the remainder of the 10 second period. The aggregate duration of control signals will not count quiet periods in between transmissions.</p> <p>Note 3: During the <i>U-NII Detection Bandwidth</i> detection test, radar type 0 should be used. For each frequency step the minimum percentage of detection is 90 percent. Measurements are performed with no data traffic.</p> | |

Table 5 – Short Pulse Radar Test Waveforms

| Radar Type | Pulse Width (usec) | PRI (usec) | Pulses | Minimum Percentage of Successful Detection | Minimum Trials |
|---|--------------------|---|---|--|----------------|
| 0 | 1 | 1428 | 18 | See Note 1 | See Note 1 |
| 1 | 1 | Test A: 15 unique PRI values randomly selected from the list of 23 PRI values in table 5a | Roundup: $\{(1/360) \times (19 \times 10^6 \text{ PRI}_{\text{usec}})\}$ | 60% | 30 |
| | | Test B: 15 unique PRI values randomly selected within the range of 518-3066 usec. With a minimum increment of 1 usec, excluding PRI values selected in Test A | | | |
| 2 | 1-5 | 150-230 | 23-29 | 60% | 30 |
| 3 | 6-10 | 200-500 | 16-18 | 60% | 30 |
| 4 | 11-20 | 200-500 | 12-16 | 60% | 30 |
| Aggregate (Radar Types 1-4) | | | | 80% | 120 |
| Note 1: Short Pulse Radar Type 0 should be used for the <i>Detection Bandwidth</i> test, <i>Channel Move Time</i> , and <i>Channel Closing Time</i> tests. | | | | | |

Table 6 – Long Pulse Radar Test Signal

| Radar Waveform Type | Pulse Width (µsec) | Chirp Width (MHz) | PRI (µsec) | Pulses per Burst | Number of Bursts | Minimum Percentage of Successful Detection | Minimum Trials |
|---------------------|--------------------|-------------------|------------|------------------|------------------|--|----------------|
| 5 | 50-100 | 5-20 | 1000-2000 | 1-3 | 8-20 | 80% | 30 |

Table 7 – Frequency Hopping Radar Test Signal

| Radar Waveform Type | Pulse Width (µsec) | PRI (µsec) | Pulses per Hop | Hopping Rate (kHz) | Hopping Sequence Length (msec) | Minimum Percentage of Successful Detection | Minimum Trials |
|---------------------|--------------------|------------|----------------|--------------------|--------------------------------|--|----------------|
| 6 | 1 | 333 | 9 | 0.333 | 300 | 70% | 30 |

5.1.2. TEST AND MEASUREMENT SYSTEM

RADIATED METHOD SYSTEM BLOCK DIAGRAM

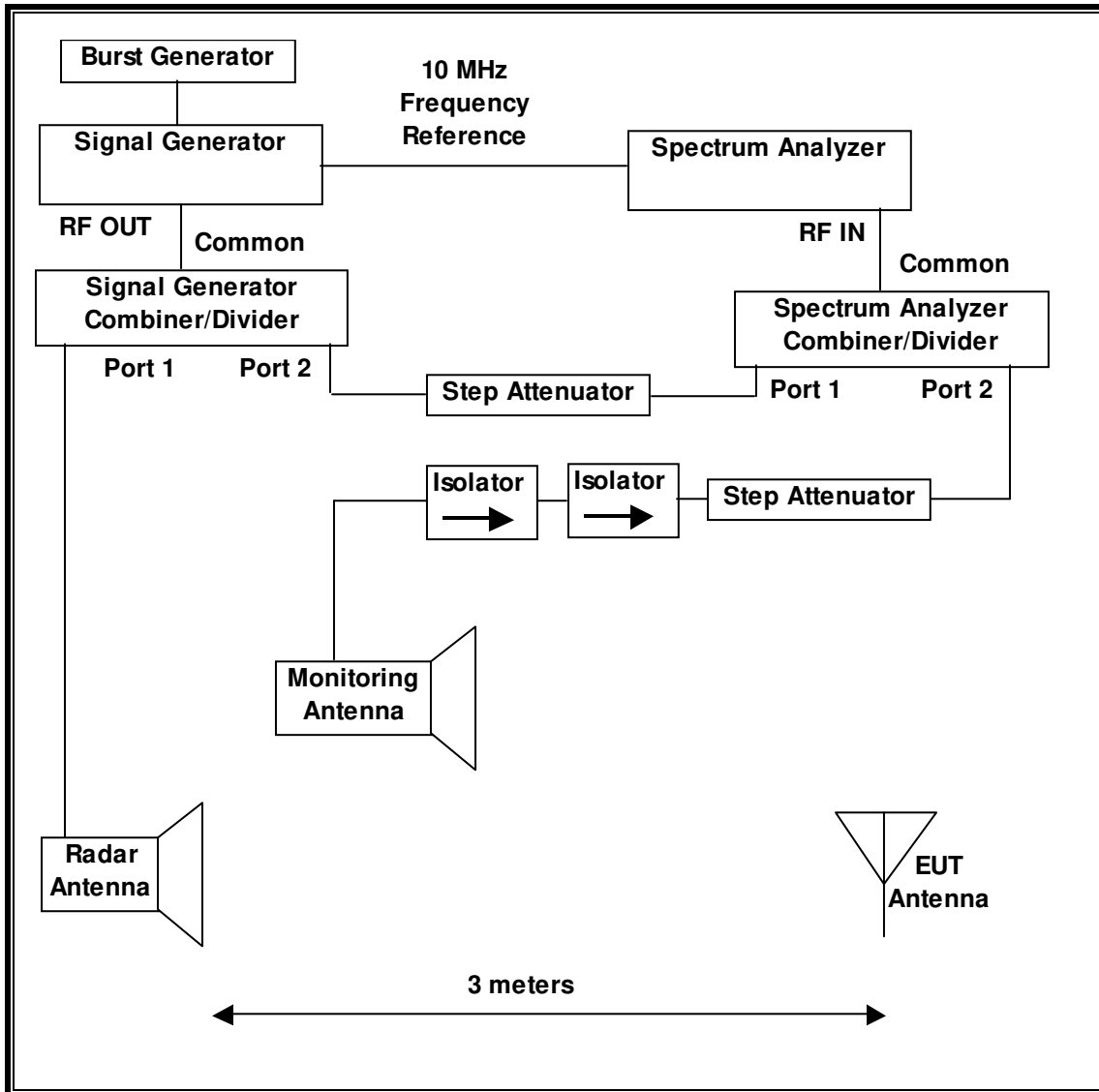

SYSTEM OVERVIEW

The short pulse and long pulse signal generating system utilizes the NTIA software. The Vector Signal Generator has been validated by the NTIA. The hopping signal generating system utilizes the CCS simulated hopping method and system, which has been validated by the DoD, FCC and NTIA. The software selects waveform parameters from within the bounds of the signal type on a random basis using uniform distribution.

The short pulse types 1, 2, 3 and 4, and the long pulse type 5 parameters are randomized at run-time.

The hopping type 6 pulse parameters are fixed while the hopping sequence is based on the August 2005 NTIA Hopping Frequency List. The initial starting point randomized at run-time and each subsequent starting point is incremented by 475. Each frequency in the 100-length segment is compared to the boundaries of the EUT Detection Bandwidth and the software creates a hopping burst pattern in accordance with Section 7.4.1.3 Method #2 Simulated Frequency Hopping Radar Waveform Generating Subsystem of KDB 905462 D02. The frequency of the signal generator is incremented in 1 MHz steps from F_L to F_H for each successive trial. This incremental sequence is repeated as required to generate a minimum of 30 total trials and to maintain a uniform frequency distribution over the entire Detection Bandwidth.

The signal monitoring equipment consists of a spectrum analyzer. The aggregate ON time is calculated by multiplying the number of bins above a threshold during a particular observation period by the dwell time per bin, with the analyzer set to peak detection and max hold.

SYSTEM CALIBRATION

A 50-ohm load is connected in place of the spectrum analyzer, and the spectrum analyzer is connected to a horn antenna via a coaxial cable, with the reference level offset set to (horn antenna gain – coaxial cable loss). The signal generator is set to CW mode. The amplitude of the signal generator is adjusted to yield a level of –64 dBm as measured on the spectrum analyzer.

Without changing any of the instrument settings, the spectrum analyzer is reconnected to the Common port of the Spectrum Analyzer Combiner/Divider. The Reference Level Offset of the spectrum analyzer is adjusted so that the displayed amplitude of the signal is –64 dBm.

The spectrum analyzer displays the level of the signal generator as received at the antenna ports of the Master Device. The interference detection threshold may be varied from the calibrated value of –64 dBm and the spectrum analyzer will still indicate the level as received by the Master Device.

ADJUSTMENT OF DISPLAYED TRAFFIC LEVEL

A link is established between the Master and Slave and the distance between the units is adjusted as needed to provide a suitable received level at the Master and Slave devices. The video test file is streamed to generate WLAN traffic. The monitoring antenna is adjusted so that the WLAN traffic level, as displayed on the spectrum analyzer, is at lower amplitude than the radar detection threshold.

TEST AND MEASUREMENT EQUIPMENT

The following test and measurement equipment was utilized for the DFS tests documented in this report:

| TEST EQUIPMENT LIST | | | | |
|--|--------------|--------|---------------|----------|
| Description | Manufacturer | Model | Serial Number | Cal Due |
| Spectrum Analyzer, PXA, 3Hz to 44GHz | Keysight | N9030A | US51350187 | 06/13/17 |
| Signal Generator, MXG X-Series RF Vector | Agilent | N5182B | MY51350128 | 04/30/17 |

5.1.3. TEST AND MEASUREMENT SOFTWARE

The following test and measurement software was utilized for the tests documented in this report:

| TEST SOFTWARE LIST | | |
|--------------------|---------|--|
| Name | Version | Test / Function |
| Aggregate Time-PXA | 3.0 | Channel Loading and Aggregate Closing Time |
| PXA Read | 3.0.0.9 | Signal Generator Screen Capture |
| SGXProject.exe | 1.7 | Radar Waveform Generation and Download |

5.1.4. SETUP OF EUT

RADIATED METHOD EUT TEST SETUP

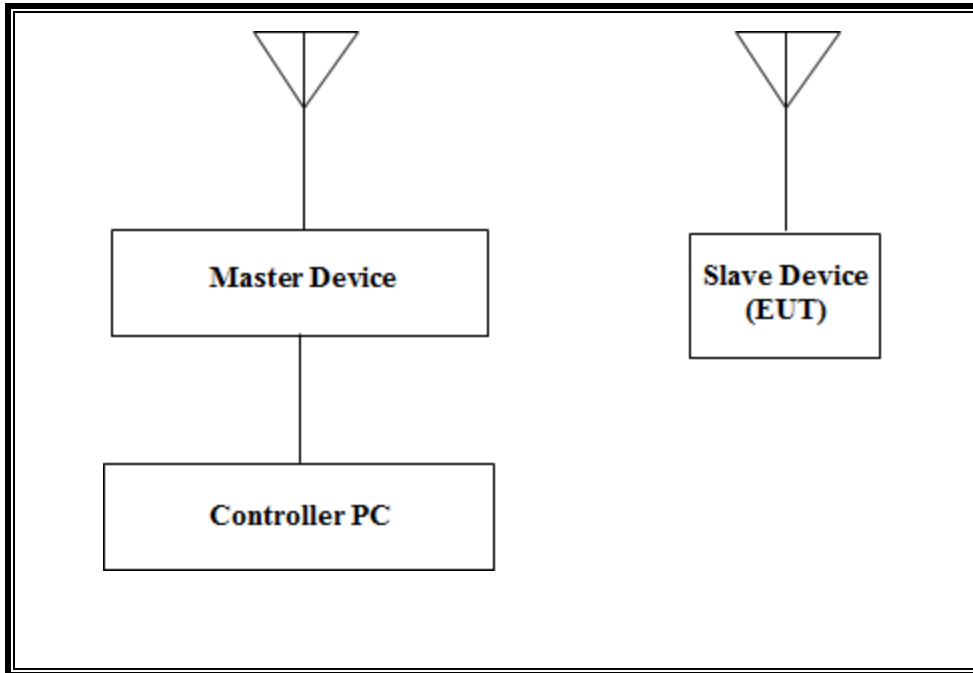

SUPPORT EQUIPMENT

The following support equipment was utilized for the DFS tests documented in this report:

| PERIPHERAL SUPPORT EQUIPMENT LIST | | | | |
|--|--------------|-------------------|------------------------|-----------|
| Description | Manufacturer | Model | Serial Number | FCC ID |
| 802.11ac Dual Band Wireless Access Point (Master Device) | Cisco | AIR-CAP3702E-A-K9 | FTX181570A6 | LDK102087 |
| P.O.E. Injector (Master AP) | Phihong | POE30U-560(G) | PHI170102N2 | DoC |
| Notebook PC (Controller) | Lenovo | Type 4236-B92 | PB-HEX04 12/05 | DoC |
| AC Adapter (Controller PC) | Lenovo | 42T4418 | 11S42T4418Z1ZGWG08R90M | DoC |

5.1.5. DESCRIPTION OF EUT

For FCC the EUT operates over the 5250-5350 MHz and 5470-5725 MHz ranges.

For IC the EUT operates over the 5250-5350 MHz and 5470-5725 MHz ranges, excluding the 5600-5650 MHz range.

The EUT is a Slave Device without Radar Detection.

The highest power level within these bands is 13.42 dBm EIRP in the 5250-5350 MHz band and 14.48 dBm EIRP in the 5470-5725 MHz band.

The antenna assembly utilized with the EUT has a gain of -2.4 dBi for chain 0, and -0.1 dBi for chain 1 for frequency range 5250-5350 MHz, and has a gain of -0.4 dBi for chain 0, and -1.0 dBi for chain 1 for frequency range 5470-5725 MHz.

Two identical antennas are utilized to meet the diversity and MIMO operational requirements.

The rated output power of the Master unit is > 23dBm (EIRP). Therefore the required interference threshold level is -64 dBm. After correction for procedural adjustments, the required radiated threshold at the antenna port is $-64 + 1 = -63$ dBm.

The calibrated radiated DFS Detection Threshold level is set to -64 dBm. The tested level is lower than the required level hence it provides a margin to the limit.

The EUT uses two transmitter/receiver chains, each connected to an antenna to perform radiated tests.

WLAN traffic that meets or exceeds the minimum required loading was generated by transferring a data stream from the Master Device to the Slave Device using iPerf version 2.0.5 software package.

TPC is not required since the maximum EIRP is less than 500 mW (27 dBm).

The EUT utilizes the 802.11ac architecture. Three nominal channel bandwidths are implemented: 20 MHz, 40 MHz and 80 MHz.

The software installed in the EUT is Android version 7.1.1, Build number x.0.200.

The software installed in the access point is AP3G2-K9W7-M Version 15.2(4)JB4.

UNIFORM CHANNEL SPREADING

This is requirement not applicable to Slave Devices.

OVERVIEW OF MASTER DEVICE WITH RESPECT TO §15.407 (h) REQUIREMENTS

The Master Device is a Cisco Access Point, FCC ID: LDK102087. The minimum antenna gain for the Master Device is 6 dBi.

The rated output power of the Master unit is $> 23\text{dBm}$ (EIRP). Therefore the required interference threshold level is -64 dBm . After correction for procedural adjustments, the required radiated threshold at the antenna port is $-64 + 1 = -63\text{ dBm}$.

The calibrated radiated DFS Detection Threshold level is set to -64 dBm . The tested level is lower than the required level hence it provides a margin to the limit.

5.2. RESULTS FOR 20 MHz BANDWIDTH

5.2.1. TEST CHANNEL

All tests were performed at a channel center frequency of 5500 MHz.

5.2.2. RADAR WAVEFORM AND TRAFFIC

RADAR WAVEFORM

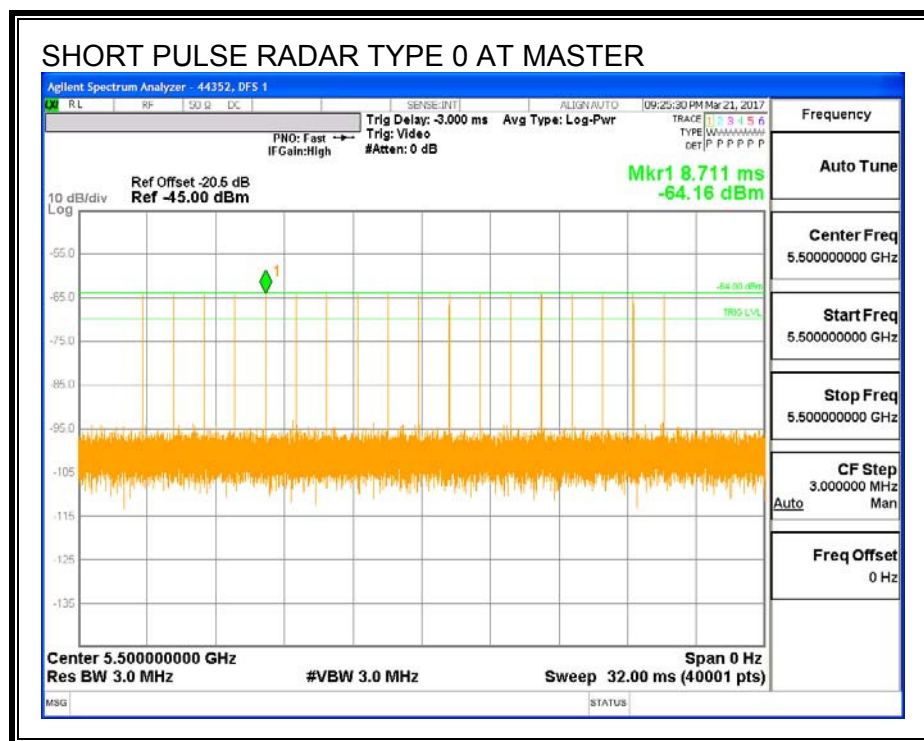

TRAFFIC

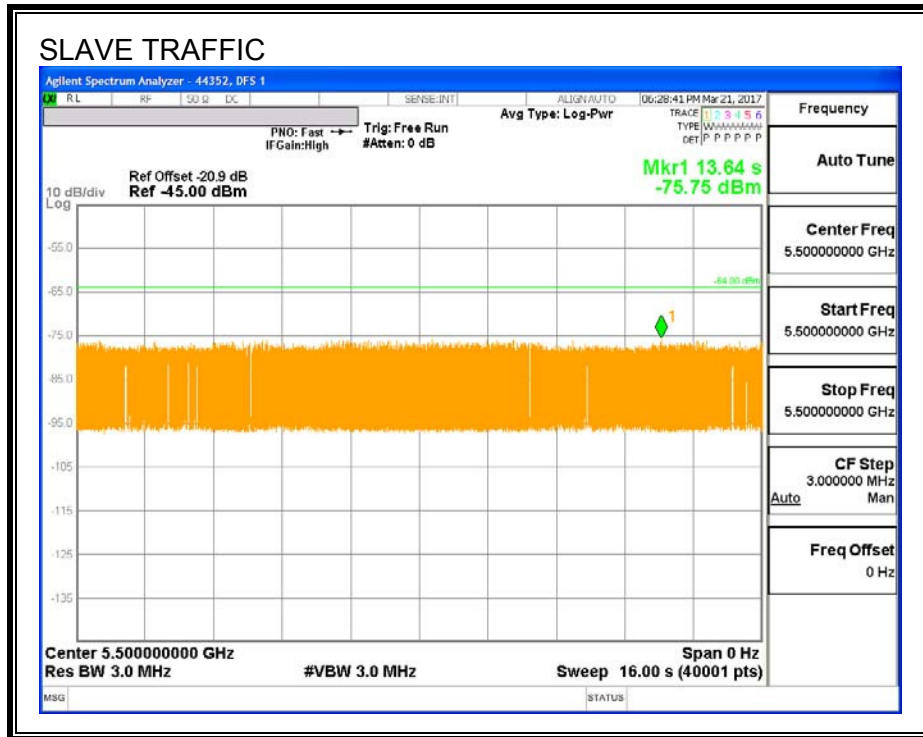

CHANNEL LOADING

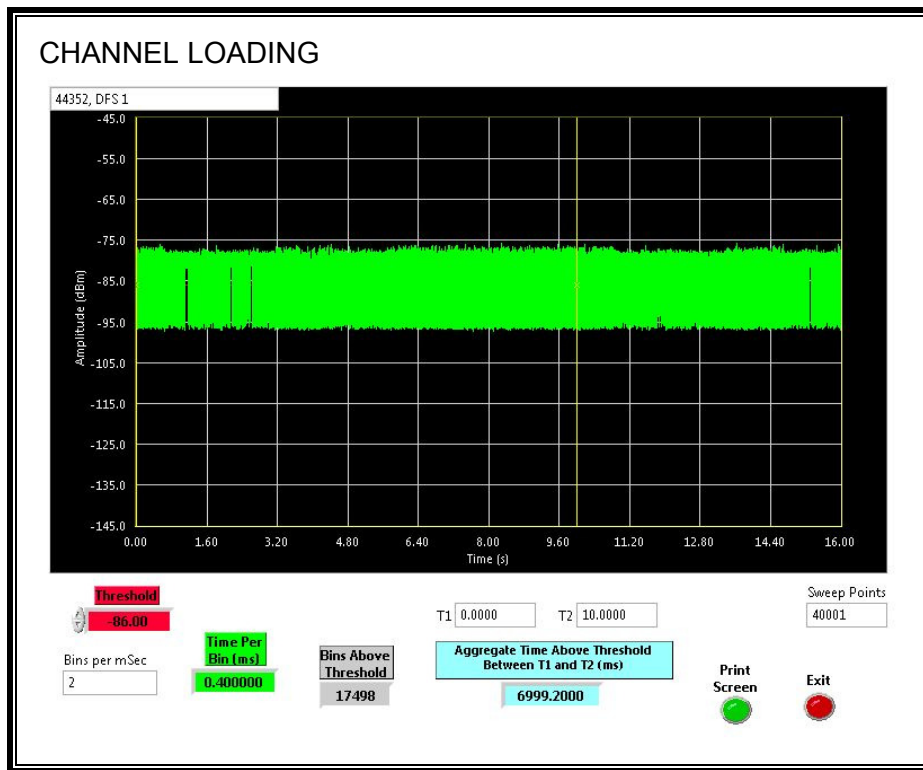

The level of traffic loading on the channel by the EUT is 69.992%.

5.2.3. OVERLAPPING CHANNEL TESTS

RESULTS

These tests are not applicable.

5.2.4. MOVE AND CLOSING TIME

REPORTING NOTES

The reference marker is set at the end of last radar pulse.

The delta marker is set at the end of the last WLAN transmission following the radar pulse. This delta is the channel move time.

The aggregate channel closing transmission time is calculated as follows:

Aggregate Transmission Time =
(Number of analyzer bins showing transmission) * (dwell time per bin)

The observation period over which the aggregate time is calculated begins at (Reference Marker + 200 msec) and ends no earlier than (Reference Marker + 10 sec).

RESULTS

| Channel Move Time (sec) | Limit (sec) |
|----------------------------|----------------|
| 0.277 | 10 |

| Aggregate Channel Closing Transmission Time (msec) | Limit (msec) |
|---|-----------------|
| 1.2 | 60 |

MOVE TIME

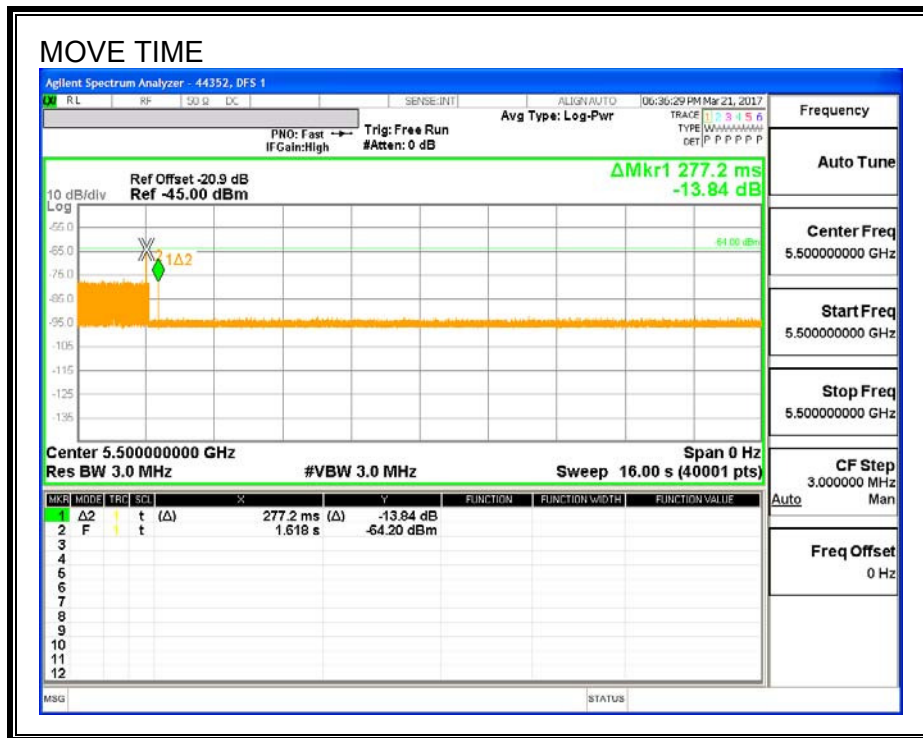

CHANNEL CLOSING TIME

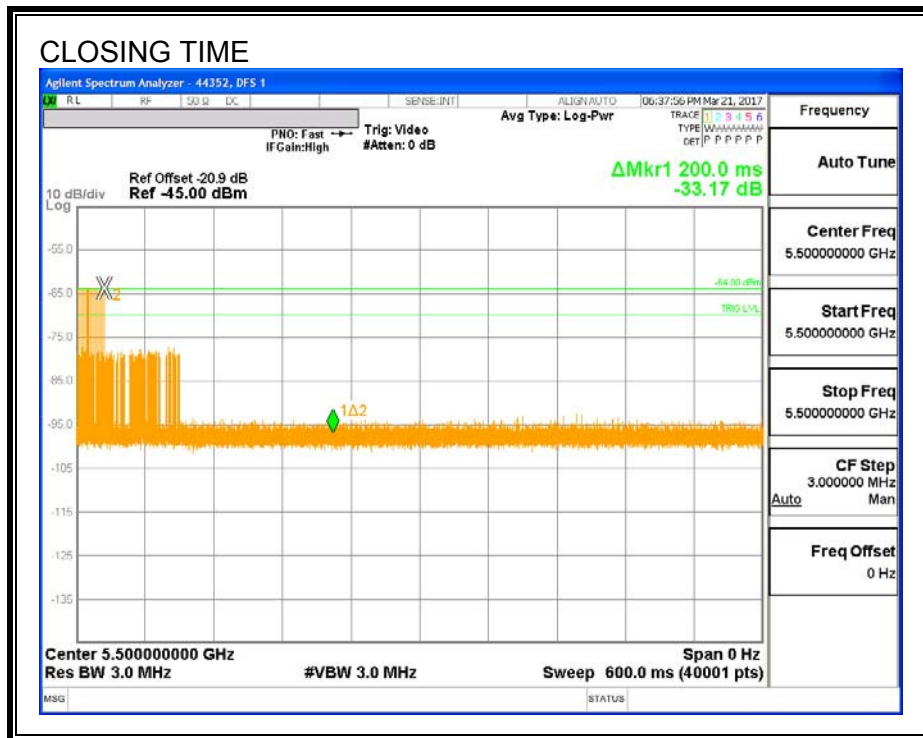

AGGREGATE CHANNEL CLOSING TRANSMISSION TIME

Only intermittent transmissions are observed during the aggregate monitoring period.

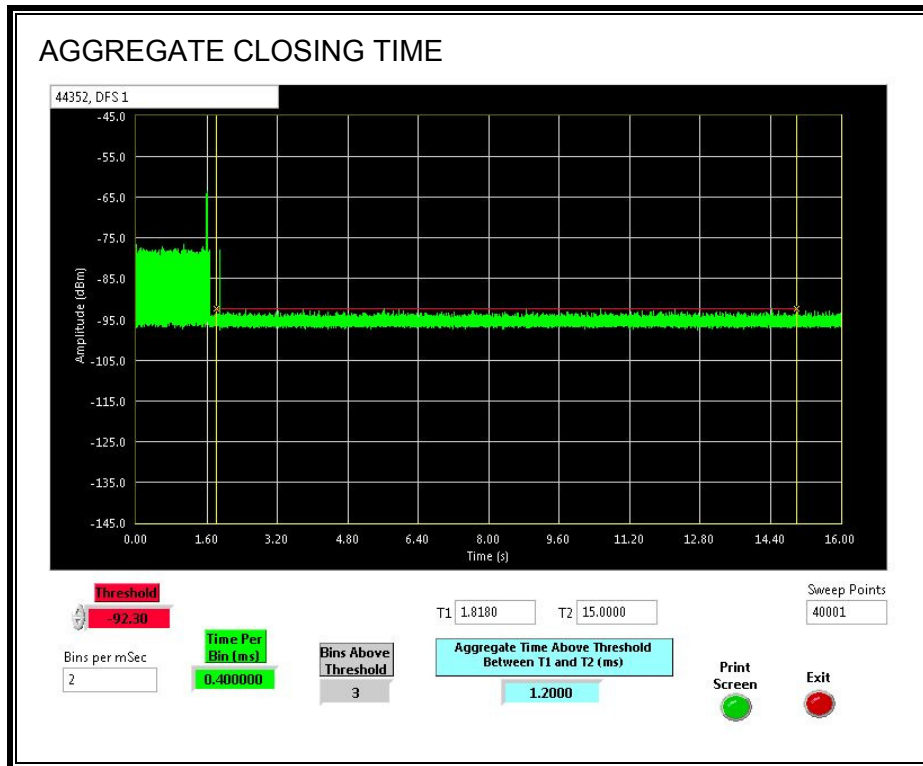

5.3. RESULTS FOR 40 MHz BANDWIDTH

5.3.1. TEST CHANNEL

All tests were performed at a channel center frequency of 5510 MHz.

5.3.2. RADAR WAVEFORM AND TRAFFIC

RADAR WAVEFORM

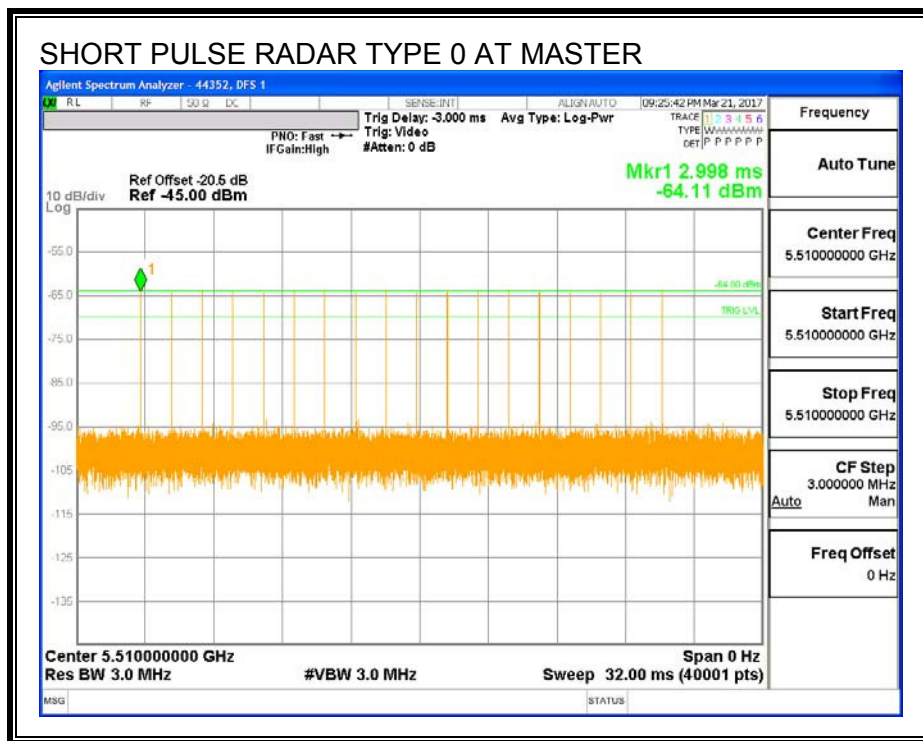

TRAFFIC

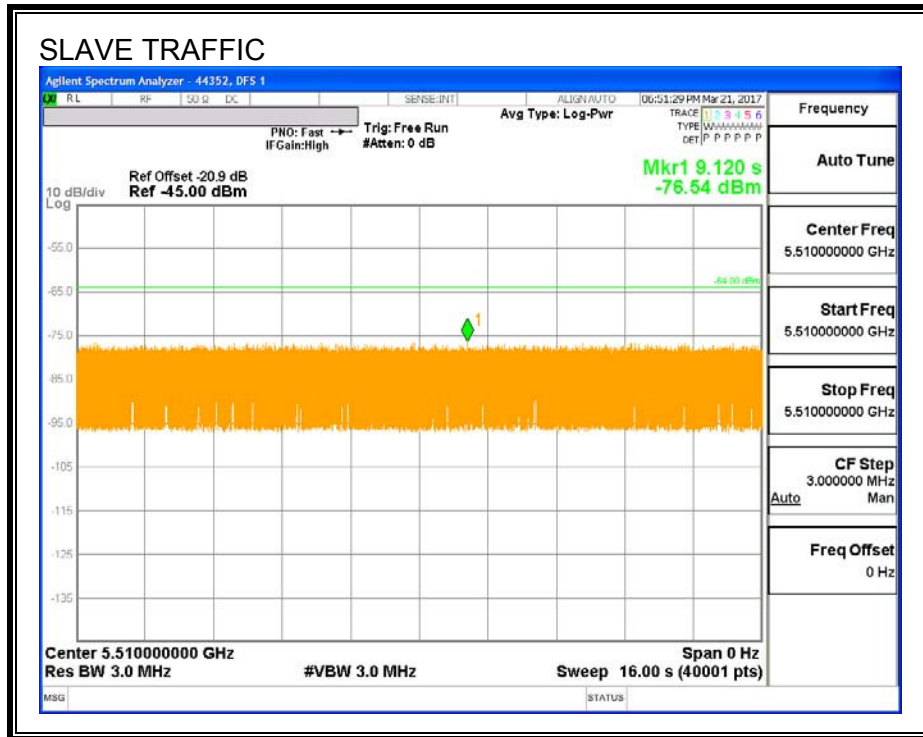

CHANNEL LOADING

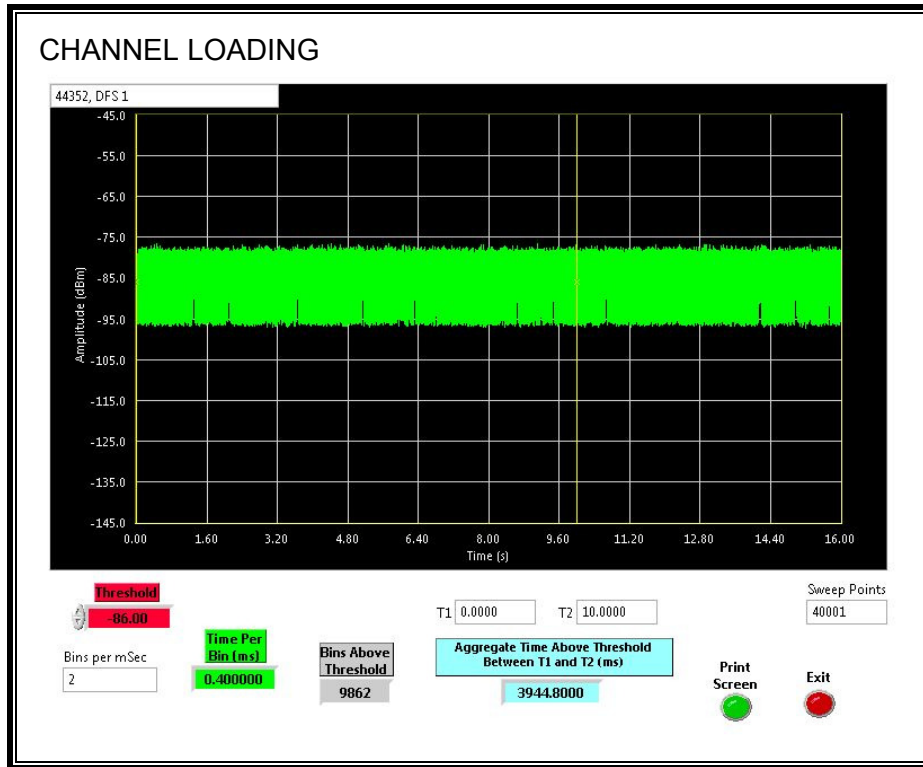

The level of traffic loading on the channel by the EUT is 39.448%.

5.3.3. OVERLAPPING CHANNEL TESTS

RESULTS

These tests are not applicable.

5.3.4. MOVE AND CLOSING TIME

REPORTING NOTES

The reference marker is set at the end of last radar pulse.

The delta marker is set at the end of the last WLAN transmission following the radar pulse. This delta is the channel move time.

The aggregate channel closing transmission time is calculated as follows:

Aggregate Transmission Time =
(Number of analyzer bins showing transmission) * (dwell time per bin)

The observation period over which the aggregate time is calculated begins at (Reference Marker + 200 msec) and ends no earlier than (Reference Marker + 10 sec).

RESULTS

| Channel Move Time (sec) | Limit (sec) |
|----------------------------|----------------|
| 0.388 | 10 |

| Aggregate Channel Closing Transmission Time (msec) | Limit (msec) |
|---|-----------------|
| 1.6 | 60 |

MOVE TIME

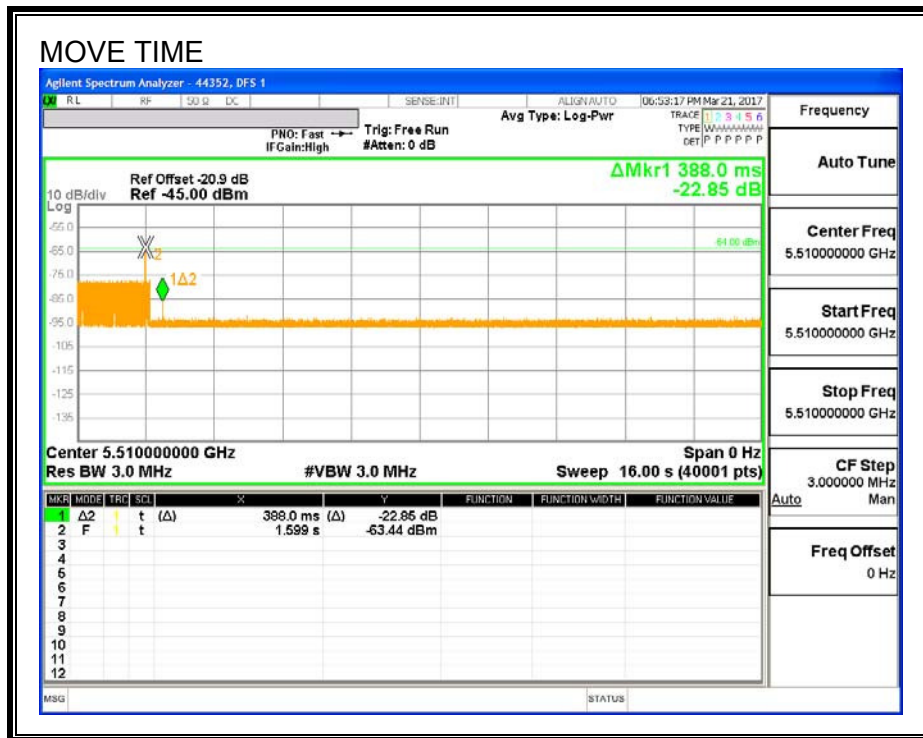

CHANNEL CLOSING TIME

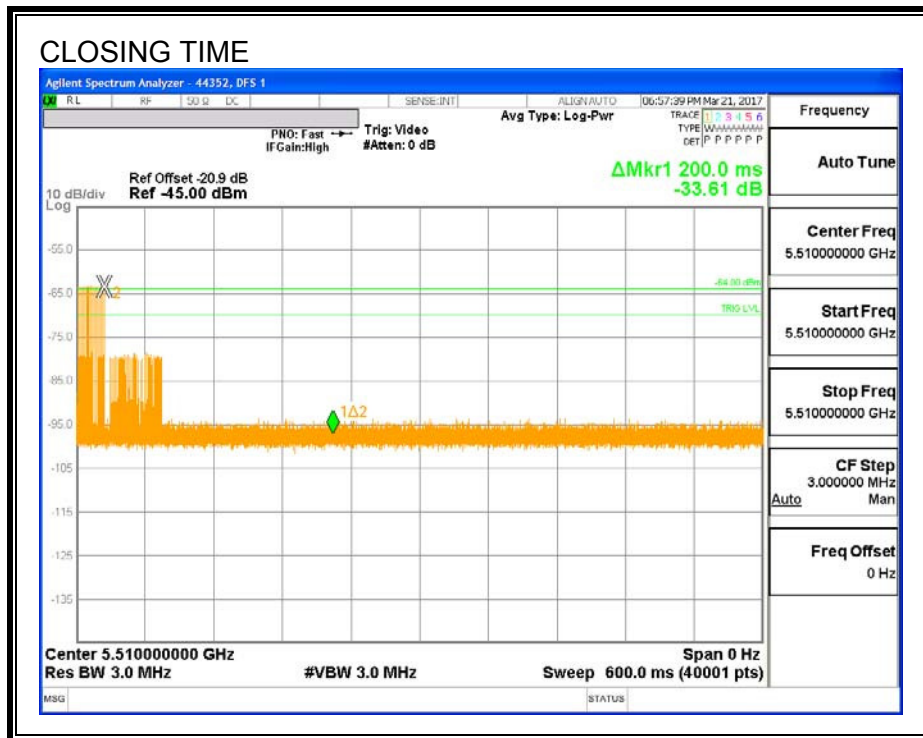

AGGREGATE CHANNEL CLOSING TRANSMISSION TIME

Only intermittent transmissions are observed during the aggregate monitoring period.

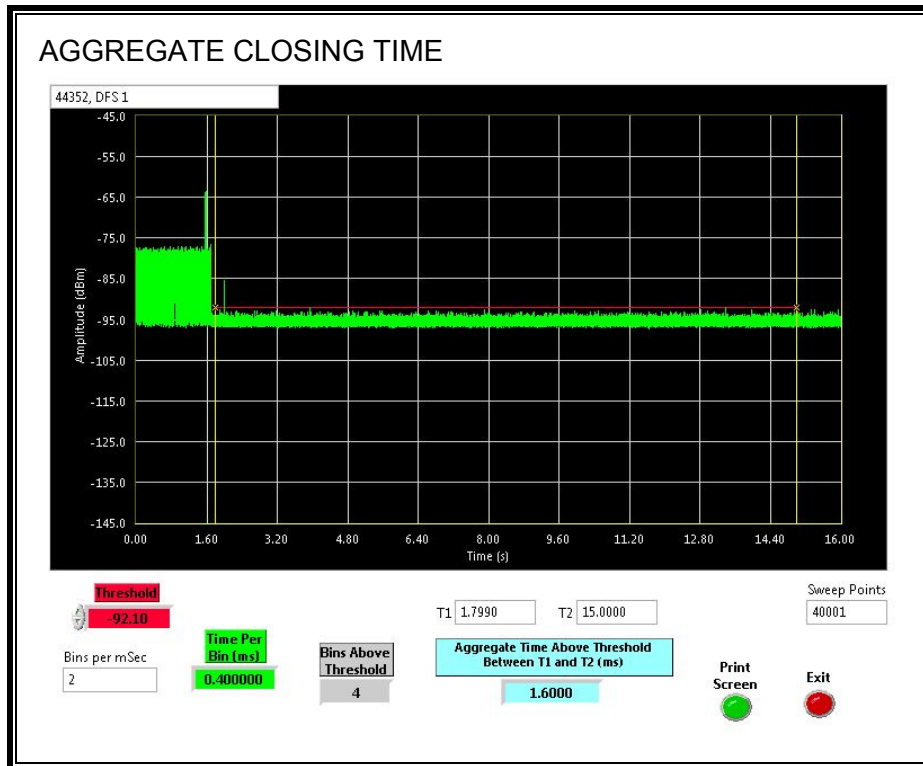

5.4. RESULTS FOR 80 MHz BANDWIDTH

5.4.1. TEST CHANNEL

All tests were performed at a channel center frequency of 5530 MHz.

5.4.2. RADAR WAVEFORM AND TRAFFIC

RADAR WAVEFORM

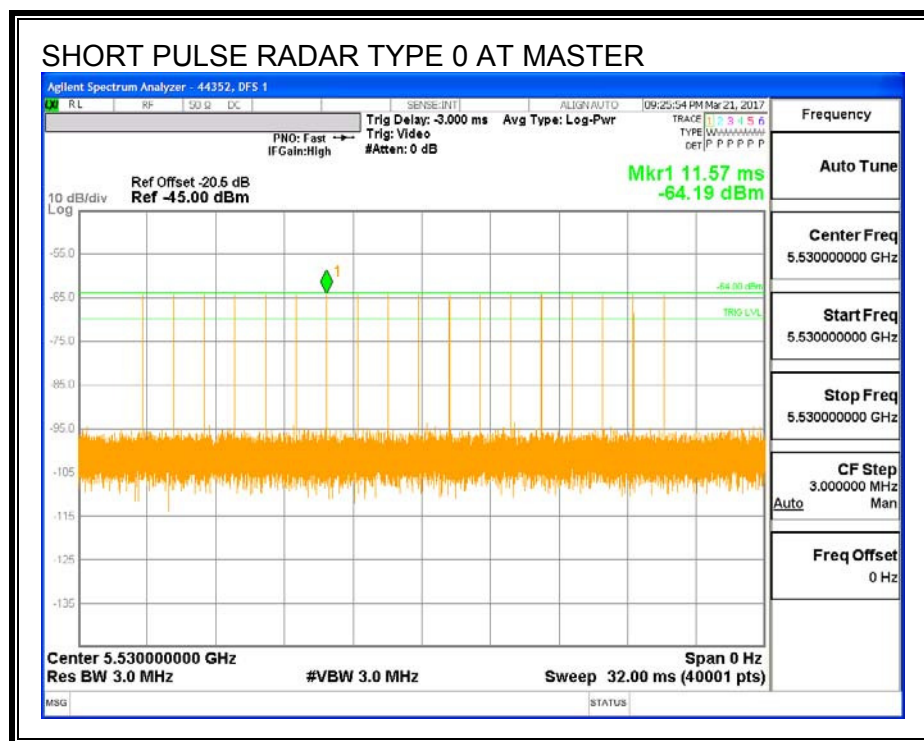

TRAFFIC

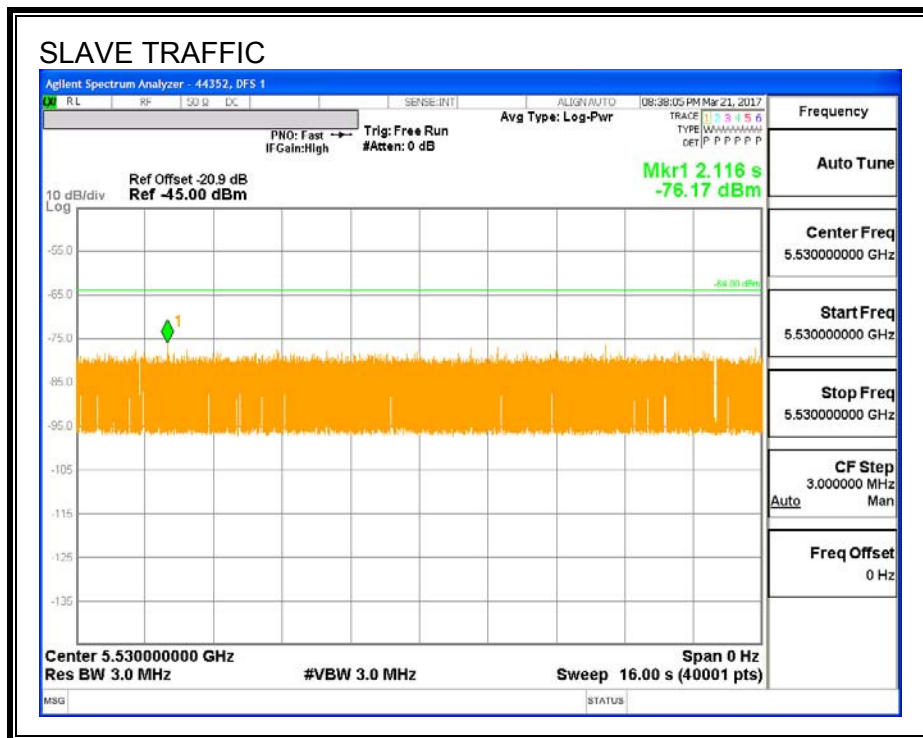

CHANNEL LOADING

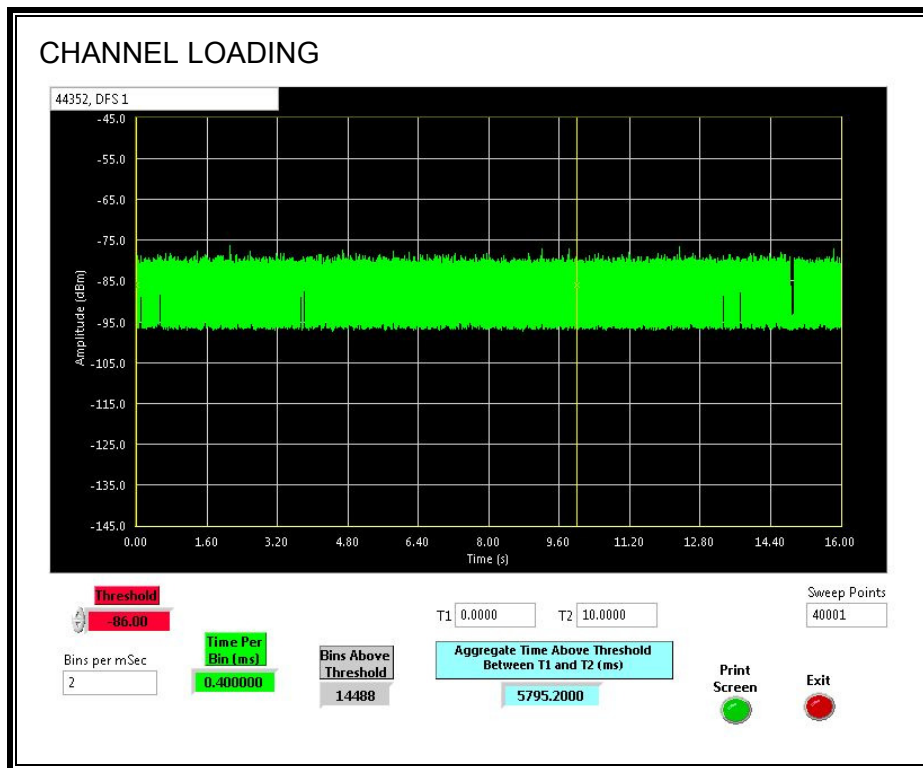

The level of traffic loading on the channel by the EUT is 57.952%.

5.4.3. OVERLAPPING CHANNEL TESTS

RESULTS

These tests are not applicable.

5.4.4. MOVE AND CLOSING TIME

REPORTING NOTES

The reference marker is set at the end of last radar pulse.

The delta marker is set at the end of the last WLAN transmission following the radar pulse. This delta is the channel move time.

The aggregate channel closing transmission time is calculated as follows:

Aggregate Transmission Time =
(Number of analyzer bins showing transmission) * (dwell time per bin)

The observation period over which the aggregate time is calculated begins at (Reference Marker + 200 msec) and ends no earlier than (Reference Marker + 10 sec).

RESULTS

| Channel Move Time (sec) | Limit (sec) |
|----------------------------|----------------|
| 0.343 | 10 |

| Aggregate Channel Closing Transmission Time (msec) | Limit (msec) |
|---|-----------------|
| 0.4 | 60 |

MOVE TIME

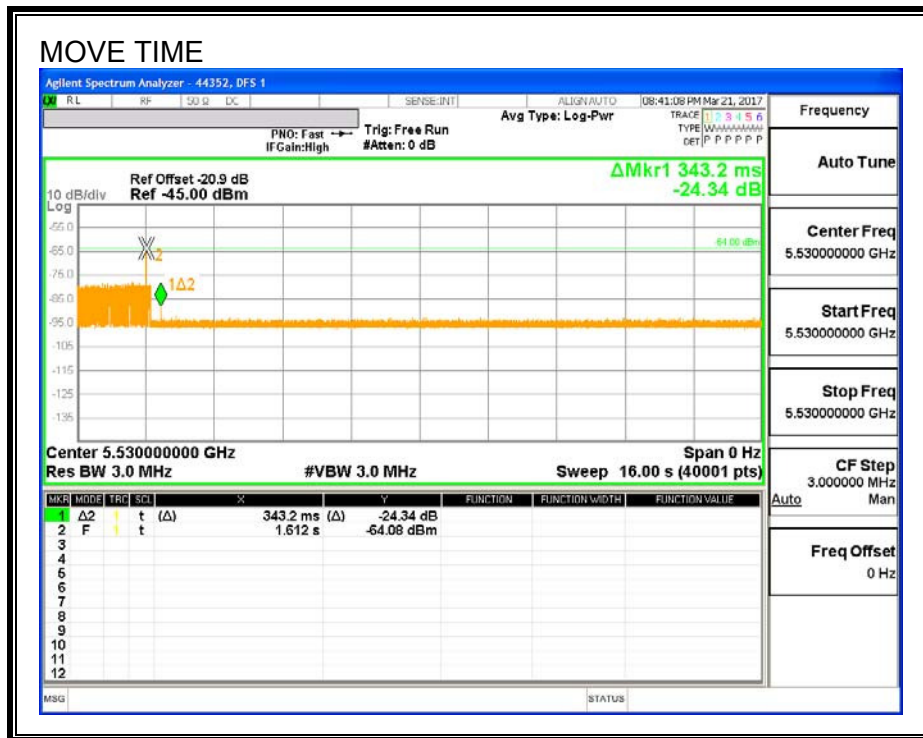

CHANNEL CLOSING TIME

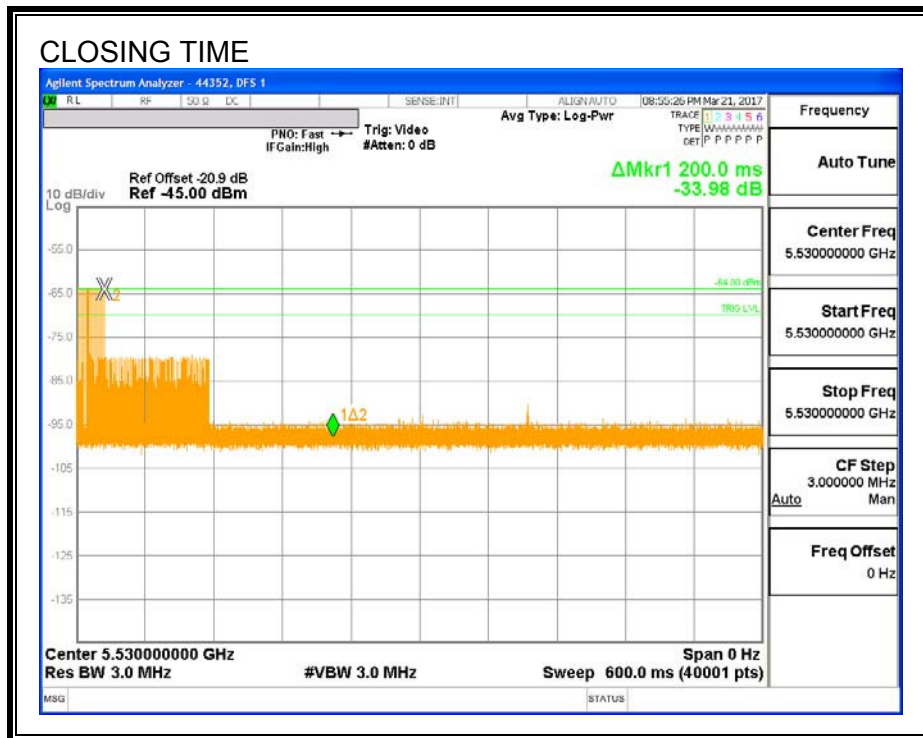

AGGREGATE CHANNEL CLOSING TRANSMISSION TIME

Only intermittent transmissions are observed during the aggregate monitoring period.

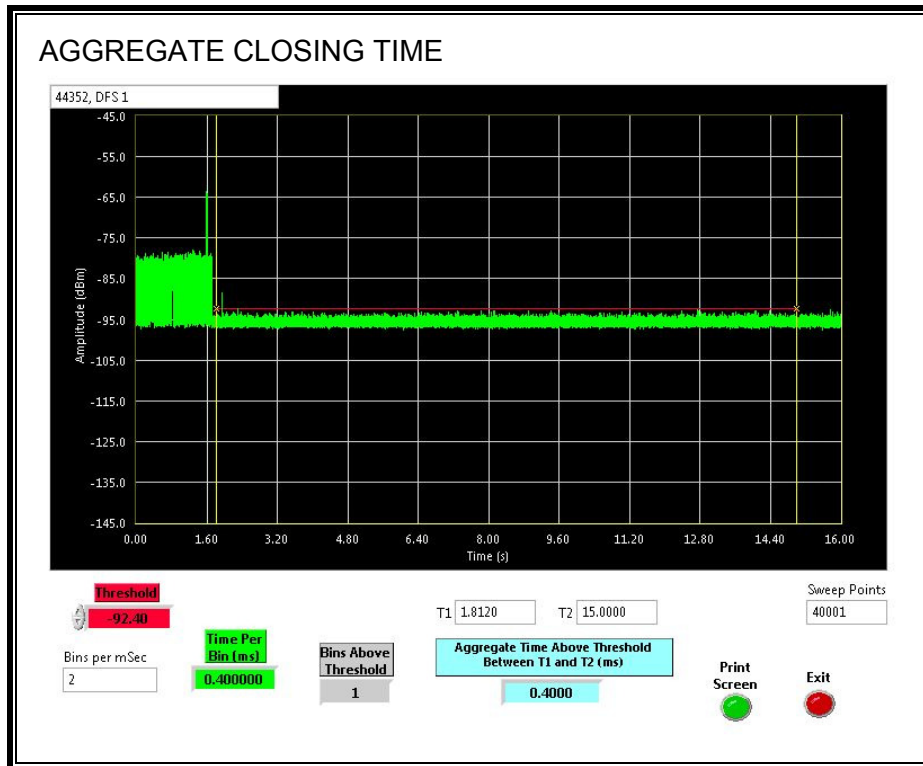

5.4.1. 10-MINUTE BEACON MONITORING PERIOD

RESULTS

No EUT transmissions were observed on the test channel during the 10-minute observation time.

