



CERTIFICATION TEST REPORT

Report Number. : 11626381H-E5V2

Applicant : SONY MOBILE COMMUNICATIONS INC.
4-12-3 HIGASHI-SHINAGAWA, SHINAGAWA-KU
TOKYO, 140-0002, JAPAN

FCC ID : PY7-54254H

EUT Description : GSM/WCDMA/LTE PHONE with BT, DTS/UNII a/b/g/n/ac, GPS & NFC

Test Standard(s) : FCC 47 CFR PART 15 SUBPART E (EXCEPT DFS)
INDUSTRY CANADA RSS - 247 ISSUE 1 (EXCEPT DFS)
INDUSTRY CANADA RSS-GEN Issue 4

Date Of Issue:

April 10, 2017

Prepared by:

UL Verification Services Inc.
47173 Benicia Street
Fremont, CA 94538, U.S.A.
TEL: (510) 771-1000
FAX: (510) 661-0888



NVLAP LAB CODE 200065-0

Revision History

<u>Rev.</u>	<u>Issue Date</u>	<u>Revisions</u>	<u>Revised By</u>
V1	03/23/17	Initial Issue	C. Vergonio
V2	04/10/17	Updated Section 7.2 to the correct method. Updated page 127 table with the min 99% BW data. Updated Page 144 and re-measured output power. Updated Page 186 and re-measured output power.	C. Vergonio

TABLE OF CONTENTS

1. ATTESTATION OF TEST RESULTS	6
2. TEST METHODOLOGY.....	7
3. FACILITIES AND ACCREDITATION	7
4. CALIBRATION AND UNCERTAINTY	8
4.1. MEASURING INSTRUMENT CALIBRATION.....	8
4.2. SAMPLE CALCULATION.....	8
4.3. MEASUREMENT UNCERTAINTY.....	8
5. EQUIPMENT UNDER TEST	9
5.1. DESCRIPTION OF EUT.....	9
5.2. MAXIMUM OUTPUT POWER.....	9
5.3. DESCRIPTION OF AVAILABLE ANTENNAS.....	10
5.4. SOFTWARE AND FIRMWARE.....	10
5.5. LIST OF TEST REDUCTION AND MODES	10
5.6. WORST-CASE CONFIGURATION AND MODE	11
5.7. DESCRIPTION OF TEST SETUP.....	12
6. TEST AND MEASUREMENT EQUIPMENT	15
7. ON TIME, DUTY CYCLE AND MEASUREMENT METHODS.....	16
7.1. ON TIME AND DUTY CYCLE.....	16
7.2. MEASUREMENT METHODS	19
8. SUMMARY TABLE.....	20
9. ANTENNA PORT TEST RESULTS	21
9.1. 11a 2TX CDD MIMO MODE IN THE 5.2GHz BAND	21
9.1.1. 26 dB BANDWIDTH.....	21
9.1.2. 99% BANDWIDTH	25
9.1.3. OUTPUT POWER AND PPSD	29
9.2. 11n HT20 2TX CDD MIMO MODE IN THE 5.2GHz BAND.....	35
9.2.1. 26 dB BANDWIDTH.....	35
9.2.2. 99% BANDWIDTH	39
9.2.3. OUTPUT POWER AND PPSD	43
9.3. 11n HT40 2TX CDD MIMO MODE IN THE 5.2GHz BAND.....	49
9.3.1. 26 dB BANDWIDTH.....	49
9.3.2. 99% BANDWIDTH	52

9.3.3. OUTPUT POWER AND PPSD55

9.4. 11ac HT80 2TX CDD MIMO MODE IN THE 5.2GHz BAND.....60

9.4.1. 26 dB BANDWIDTH60

9.4.2. 99% BANDWIDTH62

9.4.3. OUTPUT POWER AND PPSD64

9.5. 11a 2TX CDD MIMO MODE IN THE 5.3GHz BAND68

9.5.1. 26 dB BANDWIDTH68

9.5.2. 99% BANDWIDTH72

9.5.3. OUTPUT POWER AND PPSD76

9.6. 11n HT20 2TX CDD MIMO MODE IN THE 5.3GHz BAND.....82

9.6.1. 26 dB BANDWIDTH82

9.6.2. 99% BANDWIDTH86

9.6.3. OUTPUT POWER AND PPSD90

9.7. 11n HT40 2TX CDD MIMO MODE IN THE 5.3GHz BAND.....96

9.7.1. 26 dB BANDWIDTH96

9.7.2. 99% BANDWIDTH99

9.7.3. OUTPUT POWER AND PPSD102

9.8. 11ac HT80 2TX CDD MIMO MODE IN THE 5.3GHz BAND.....107

9.8.1. 26 dB BANDWIDTH107

9.8.2. 99% BANDWIDTH109

9.8.3. OUTPUT POWER AND PPSD111

9.9. 11a 2TX CDD MIMO MODE IN THE 5.6GHz BAND115

9.9.1. 26 dB BANDWIDTH115

9.9.2. 99% BANDWIDTH120

9.9.3. OUTPUT POWER AND PPSD125

9.10. 11n HT20 2TX CDD MIMO MODE IN THE 5.6GHz BAND132

9.10.1. 26 dB BANDWIDTH132

9.10.2. 99% BANDWIDTH.....137

9.10.3. OUTPUT POWER AND PPSD.....142

9.11. 11n HT40 2TX CDD MIMO MODE IN THE 5.6GHz BAND149

9.11.1. 26 dB BANDWIDTH149

9.11.2. 99% BANDWIDTH.....154

9.11.3. OUTPUT POWER AND PPSD.....159

9.12. 11ac HT80 2TX CDD MIMO MODE IN THE 5.6GHz BAND166

9.12.1. 26 dB BANDWIDTH166

9.12.2. 99% BANDWIDTH.....169

9.12.3. OUTPUT POWER AND PPSD172

9.13. 11a 2TX CDD MIMO MODE IN THE 5.8GHz BAND.....177

9.13.1. 6 dB BANDWIDTH177

9.13.2. 99% BANDWIDTH.....181

9.13.3. OUTPUT POWER AND PSD185

9.14. 11n HT20 2TX CDD MIMO MODE IN THE 5.8GHz BAND190

9.14.1. 6 dB BANDWIDTH190

9.14.2. 99% BANDWIDTH.....194

9.14.3. OUTPUT POWER AND PSD198

9.15. 11n HT40 2TX CDD MIMO MODE IN THE 5.8GHz BAND203

9.15.1.	6 dB BANDWIDTH	203
9.15.2.	99% BANDWIDTH.....	206
9.15.3.	OUTPUT POWER AND PSD	209
9.16.	<i>11ac HT80 2TX CDD MIMO MODE IN THE 5.8GHz BAND</i>	213
9.16.1.	6 dB BANDWIDTH	213
9.16.2.	99% BANDWIDTH.....	215
9.16.3.	OUTPUT POWER AND PSD	217
10.	RADIATED TEST RESULTS	220
10.1.	<i>LIMITS AND PROCEDURE</i>	220
10.1.1.	11a 2TX CDD MIMO MODE IN THE 5.2GHz BAND.....	221
10.1.2.	11n HT20 2TX CDD MIMO MODE IN THE 5.2GHz BAND	229
10.1.3.	11n HT40 2TX CDD MIMO MODE IN THE 5.2GHz BAND	237
10.1.4.	11ac HT80 2TX CDD MIMO MODE IN THE 5.2GHz BAND	243
10.1.5.	11a 2TX CDD MIMO MODE IN THE 5.3GHz BAND.....	247
10.1.6.	11n HT20 2TX CDD MIMO MODE IN THE 5.3GHz BAND	255
10.1.7.	11n HT40 2TX CDD MIMO MODE IN THE 5.3GHz BAND	263
10.1.8.	11ac HT80 2TX CDD MIMO MODE IN THE 5.3GHz BAND	269
10.1.9.	11a 2TX CDD MIMO MODE IN THE 5.6GHz BAND.....	273
10.1.10.	11n HT20 2TX CDD MIMO MODE IN THE 5.6GHz BAND	285
10.1.11.	11n HT40 2TX CDD MIMO MODE IN THE 5.6GHz BAND	297
10.1.12.	11ac HT80 2TX CDD MIMO MODE IN THE 5.6GHz BAND	309
10.1.13.	11a 2TX CDD MIMO MODE IN THE 5.8GHz BAND.....	317
10.1.14.	11n HT20 2TX CDD MIMO MODE IN THE 5.8GHz BAND.....	331
10.1.15.	11n HT40 2TX CDD MIMO MODE IN THE 5.8GHz BAND.....	345
10.1.16.	11ac HT80 2TX CDD MIMO MODE IN THE 5.8GHz BAND	357
10.2.	<i>WORST CASE BELOW 30 MHz</i>	367
10.1.	<i>WORST-CASE BELOW 1 GHz</i>	369
10.2.	<i>WORST-CASE 18 to 26 GHz</i>	371
10.3.	<i>WORST-CASE 26 to 40 GHz</i>	373
11.	AC POWER LINE CONDUCTED EMISSIONS	375
11.1.	<i>SETUP PHOTOS</i>	379

1. ATTESTATION OF TEST RESULTS

COMPANY NAME: SONY MOBILE COMMUNICATIONS INC.
4-12-3 HIGASHI-SHINAGAWA, SHINAGAWA-KU
TOKYO, 140-0002, JAPAN

EUT DESCRIPTION: GSM/WCDMA/LTE PHONE with BT, DTS/UNII a/b/g/n/ac, GPS & NFC

SERIAL NUMBER: CB512DHRyh & CB512DHRxv (CONDUCTED);
CB512DQZU1 & CB512DQZUN (RADIATED)

DATE TESTED: March 12TH – April 10th , 2017

APPLICABLE STANDARDS	
STANDARD	TEST RESULTS
CFR 47 Part 15 Subpart E	Pass
INDUSTRY CANADA RSS-247 Issue 1	Pass
INDUSTRY CANADA RSS-GEN Issue 4	Pass

UL Verification Services Inc. tested the above equipment in accordance with the requirements set forth in the above standards. All indications of Pass/Fail in this report are opinions expressed by UL Verification Services Inc. based on interpretations and/or observations of test results. Measurement Uncertainties were not taken into account and are published for informational purposes only. The test results show that the equipment tested is capable of demonstrating compliance with the requirements as documented in this report.

Note: The results documented in this report apply only to the tested sample, under the conditions and modes of operation as described herein. This document may not be altered or revised in any way unless done so by UL Verification Services Inc. and all revisions are duly noted in the revisions section. Any alteration of this document not carried out by UL Verification Services Inc. will constitute fraud and shall nullify the document. This report must not be used by the client to claim product certification, approval, or endorsement by NVLAP, NIST, any agency of the Federal Government, or any agency of any government.

Approved & Released For
UL Verification Services Inc. By:

Prepared By:



CHARLES VERGONIO
PROJECT LEAD
UL VERIFICATION SERVICES INC.

GLENN ESCANO
WISE LAB ENGINEER
UL VERIFICATION SERVICES INC.

2. TEST METHODOLOGY

FCC: The tests documented in this report were performed in accordance with FCC CFR 47 Part 2, FCC CFR 47 Part 15, FCC 14-30, FCC KDB 662911 D01 v02r01, FCC KDB 905462 D02 v01r02/D03 v01r01/D06 v01, FCC KDB 789033 D02 v01r01, FCC KDB 644545 D03 v01, ANSI C63.10-2013.

IC: The tests documented in this report were performed in accordance with FCC CFR 47 Part 2, FCC CFR 47 Part 15, FCC 14-30, FCC KDB 662911 D01 v02r01, FCC KDB 905462 D02 v01r02/D03 v01r01/D06 v01, FCC KDB 789033 D02 v01r01, FCC KDB 644545 D03 v01, ANSI C63.10-2013, RSS-GEN Issue 4, and RSS-247 Issue 1.

3. FACILITIES AND ACCREDITATION

The test sites and measurement facilities used to collect data are located at 47173 and 47266 Benicia Street, Fremont, California, USA. Line conducted emissions are measured only at the 47173 address. The following table identifies which facilities were utilized for radiated emission measurements documented in this report. Specific facilities are also identified in the test results sections.

47173 Benicia Street		47266 Benicia Street	
<input checked="" type="checkbox"/>	Chamber A (IC:2324B-1)	<input type="checkbox"/>	Chamber D (IC:2324B-4)
<input checked="" type="checkbox"/>	Chamber B (IC:2324B-2)	<input type="checkbox"/>	Chamber E (IC:2324B-5)
<input checked="" type="checkbox"/>	Chamber C (IC:2324B-3)	<input type="checkbox"/>	Chamber F (IC:2324B-6)
		<input type="checkbox"/>	Chamber G (IC:2324B-7)
		<input type="checkbox"/>	Chamber H (IC:2324B-8)

The above test sites and facilities are covered under FCC Test Firm Registration # 208313.

UL Verification Services Inc. is accredited by NVLAP, Laboratory Code 200065-0. The full scope of accreditation can be viewed at <http://ts.nist.gov/standards/scopes/2000650.htm>.

4. CALIBRATION AND UNCERTAINTY

4.1. MEASURING INSTRUMENT CALIBRATION

The measuring equipment utilized to perform the tests documented in this report has been calibrated in accordance with the manufacturer's recommendations, and is traceable to recognized national standards.

4.2. SAMPLE CALCULATION

Where relevant, the following sample calculation is provided:

$$\begin{aligned} \text{Field Strength (dBuV/m)} &= \text{Measured Voltage (dBuV)} + \text{Antenna Factor (dB/m)} + \text{Cable} \\ &\text{Loss (dB)} - \text{Preamp Gain (dB)} \\ 36.5 \text{ dBuV} + 18.7 \text{ dB/m} + 0.6 \text{ dB} - 26.9 \text{ dB} &= 28.9 \text{ dBuV/m} \end{aligned}$$

4.3. MEASUREMENT UNCERTAINTY

Where relevant, the following measurement uncertainty levels have been estimated for tests performed on the apparatus:

Where relevant, the following measurement uncertainty levels have been estimated for tests performed on the apparatus:

Parameter	Uncertainty
Worst Case Conducted Disturbance, 9KHz to 0.15 MHz	3.84 dB
Worst Case Conducted Disturbance, 0.15 to 30 MHz	3.65 dB
Worst Case Radiated Disturbance, 9KHz to 30 MHz	3.15 dB
Worst Case Radiated Disturbance, 30 to 1000 MHz	5.36 dB
Worst Case Radiated Disturbance, 1000 to 18000 MHz	4.32 dB
Worst Case Radiated Disturbance, 18000 to 26000 MHz	4.45 dB
Worst Case Radiated Disturbance, 26000 to 40000 MHz	5.24 dB

Uncertainty figures are valid to a confidence level of 95%.

5. EQUIPMENT UNDER TEST

5.1. DESCRIPTION OF EUT

The EUT is a GSM/WCDMA/LTE Phone with BT, DTS/UNII a/b/g/n/ac, GPS & NFC.

5.2. MAXIMUM OUTPUT POWER

The transmitter has a maximum conducted output power as follows:

5.2GHz Band

Frequency Range (MHz)	Mode	Output Power (dBm)	Output Power (mW)
5180 - 5240	802.11a CDD 2TX	14.82	30.34
	802.11n HT20 CDD 2TX	14.74	29.79
5190 - 5230	802.11n HT40 CDD 2TX	14.83	30.41
5210	802.11ac VHT80 CDD 2TX	14.73	29.72

5.3GHz Band

Frequency Range (MHz)	Mode	Output Power (dBm)	Output Power (mW)
5260 - 5320	802.11a CDD 2TX	14.85	30.55
	802.11n HT20 CDD 2TX	14.59	28.77
5270 - 5310	802.11n HT40 CDD 2TX	14.79	30.13
5290	802.11ac VHT80 CDD 2TX	14.80	30.20

5.6GHz Band

Frequency Range (MHz)	Mode	Output Power (dBm)	Output Power (mW)
5500 - 5700	802.11a CDD 2TX	15.11	32.43
5500 - 5700	802.11n HT20 CDD 2TX	15.13	32.58
5510 - 5670	802.11n HT40 CDD 2TX	15.12	32.51
5530-5610	802.11ac VHT80 CDD 2TX	15.02	31.77

5.8GHz Band

Frequency Range (MHz)	Mode	Output Power (dBm)	Output Power (mW)
5745 - 5825	802.11a CDD 2TX	15.1	32.36
5745 - 5825	802.11n HT20 CDD 2TX	15.13	32.58
5755 - 5795	802.11n HT40 CDD 2TX	15.08	32.21
5775	802.11ac VHT80 CDD 2TX	15.00	31.62

5.3. DESCRIPTION OF AVAILABLE ANTENNAS

The radio utilizes two integrated antennas, with the following maximum gains:

Frequency (GHz)	Peak Antenna Gain (dBi)	
	Main (Chain 0)	Sub (Chain 1)
5180-5320	-2.4	-0.1
5500-5725	-0.4	-1.0
5725-5850	-3.0	-1.9

5.4. SOFTWARE AND FIRMWARE

The firmware installed in the EUT during testing was SONY, s_atp_1_00067_A_9_4.
 The test utility software used during testing was Tera Term Ver 4.79.

5.5. LIST OF TEST REDUCTION AND MODES

Antenna port & Radiated Testing	
Mode	Covered by
802.11a 2TX CDD	802.11a 2TX CDD
802.11HT20 2TX STBC	802.11n HT20 2TX CDD
	802.11n HT20 2TX CDD
802.11ac VHT20 2TX STBC	802.11n HT20 2TX CDD
	802.11n HT20 2TX CDD
802.11n HT40 2TX STBC	802.11n HT40 2TX CDD
	802.11n HT40 2TX CDD
802.11ac VHT40 2TX STBC	802.11n HT40 2TX CDD
	802.11n HT40 2TX CDD
802.11ac VHT80 2TX STBC	802.11ac VHT80 2TX CDD
	802.11ac VHT80 2TX CDD

5.6. WORST-CASE CONFIGURATION AND MODE

Radiated emission below 1GHz and power line conducted emissions were performed with the EUT set to transmit at the channel with highest output power as worst-case scenario.

The fundamental of the EUT was investigated in three orthogonal orientations X (Flatbed), Y (Landscape), Z (Portrait), it was determined that Z (Portrait) was worst-case orientations. Therefore, all final radiated testing was performed with the EUT in Z (Portrait) orientation.

Worst-case data rates as provided by the client were:

802.11a mode: 6 Mbps
802.11n HT20 mode: 13 Mbps (MCS8)
802.11n HT40 mode: 27 Mbps (MCS8)
802.11ac VHT80 mode: 58.5 Mbps (MCS0)

802.11ac VHT20 and VHT40 mode are different from 802.11nHT20 and HT40 only in control messages and have the same power settings.

5.7. DESCRIPTION OF TEST SETUP

SUPPORT EQUIPMENT

Support Equipment List				
Description	Manufacturer	Model	Serial Number	FCC ID
Laptop	Lenovo	20B7S0A200	PC015REW	NA
AC Adapter	SONY	1300-7137.1	4016W40310044	NA
Headphones	SONY	N/A	N/A	N/A

I/O CABLES (CONDUCTED TEST)

I/O Cable List						
Cable No	Port	# of identical ports	Connector Type	Cable Type	Cable Length (m)	Remarks
1	Antenna	1	RF	Shielded	0.2	To spectrum Analyzer
2	USB	1	USB	Shielded	1	N/A
3	DC	1	DC	Shielded	0.3	N/A

I/O CABLES (RADIATED AND CONDUCTED EMISSIONS)

I/O Cable List						
Cable No	Port	# of identical ports	Connector Type	Cable Type	Cable Length (m)	Remarks
1	USB	1	USB	Shielded	3	N/A
2	Audio	1	3.5mm	Shielded	1	N/A

TEST SETUP

CONDCUTED TEST SETUP DIAGRAM

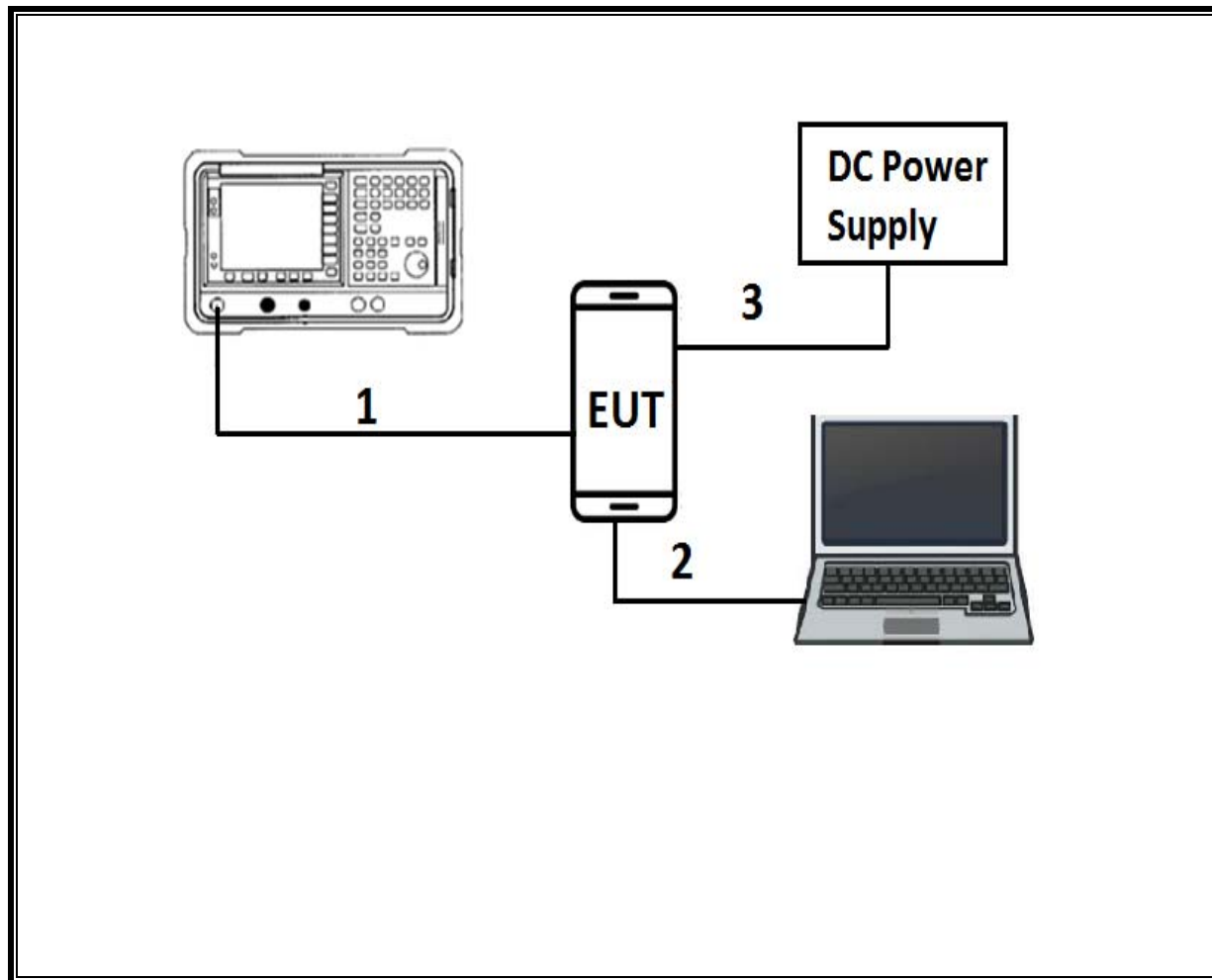

TEST SETUP

RADIATED AND AC LINE CONDUCTED EMISSIONS SETUP DIAGRAM

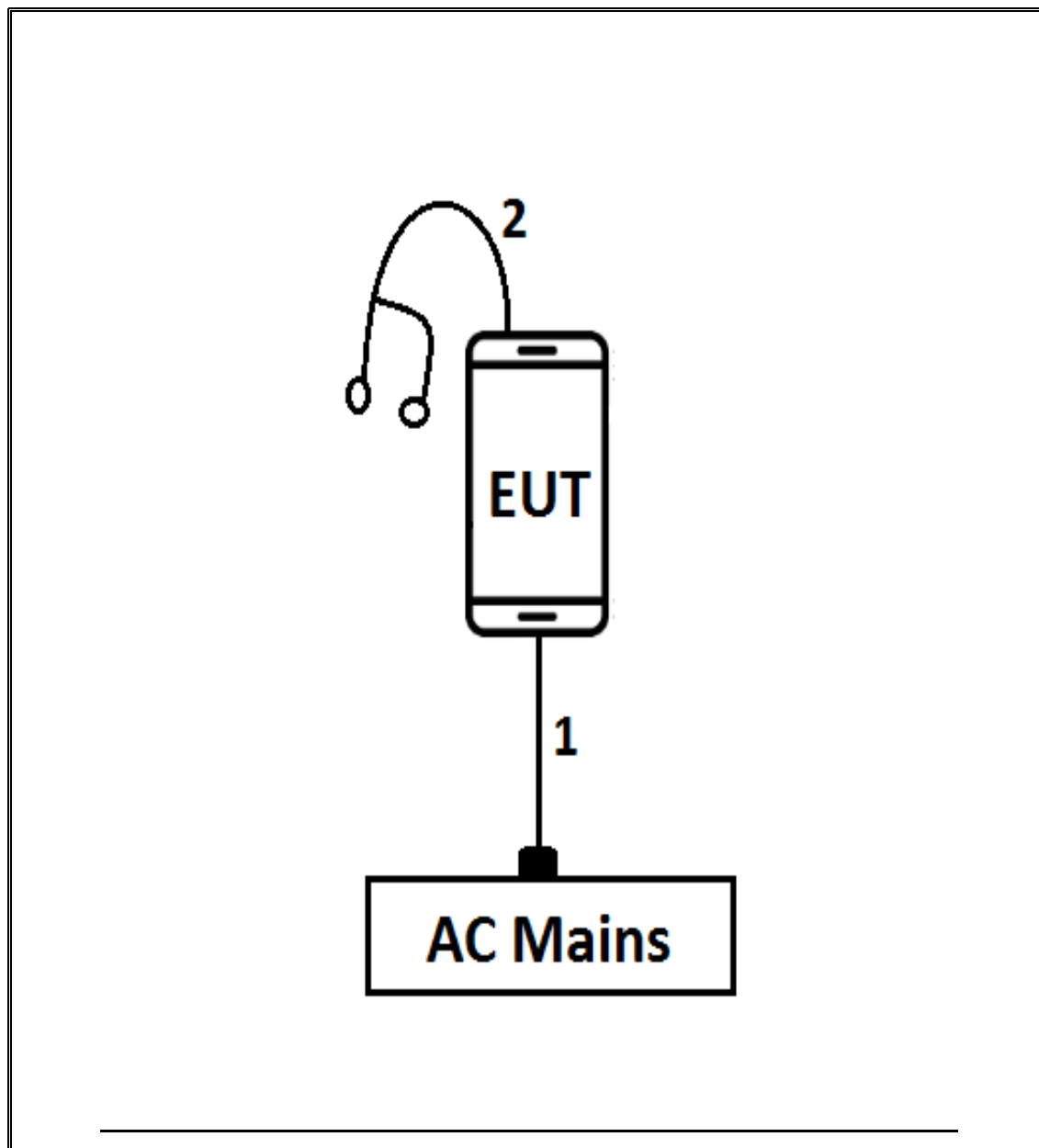

6. TEST AND MEASUREMENT EQUIPMENT

The following test and measurement equipment was utilized for the tests documented in this report:

TEST EQUIPMENT LIST				
Description	Manufacturer	Model	Asset	Cal Due
Antenna, Broadband Hybrid, 30MHz to 2000MHz w/4dB Pad	Sunol Sciences Corp.	JB3	T477	06/22/2017
Antenna, Active Loop 9kHz-30MHz	ETS-Lindgren	6502	T1683	02/17/2018
Antenna, Horn 1-18GHz	ETS-Lindgren	3117	T345	03/07/2018
Antenna, Horn 18-26.5GHz	ARA	MWH-1826/B	T449	05/26/2017
Antenna, Horn 26.5 - 40GHz	ARA	MWH-1826/B	T449	05/26/2017
Power Meter, P-series single channel	Agilent (Keysight) Technologies	N1911A	T1264	07/08/2017
Power Sensor, P – series, 50MHz to 18GHz, Wideband	Agilent (Keysight) Technologies	N1921A	T413	06/20/2017
Amplifier, 1-26.5GHz	Agilent (Keysight) Technologies	8449B	T404	07/05/2017
Amplifier, 10kHz-1GHz	Agilent (Keysight) Technologies	8447D	T15	08/26/2017
RF Amplifier	MITEQ	AFS42-00101800-25-S-42	T493	02/15/2018
Spectrum Analyzer, PSA, 3Hz to 26.5GHz	Agilent (Keysight) Technologies	E4440A	T199	07/22/2017
Spectrum Analyzer, PXA, 3Hz to 44GHz	Agilent (Keysight) Technologies	N9030A	T907	01/23/2018
Spectrum Analyzer, PSA, 3Hz to 26.5GHz	Agilent (Keysight) Technologies	E9030A	T905	01/11/2018
LISN	FISCHER	FCC-LISN-50/250-25-2-01	T1310	06/08/2017

Test Software List			
Description	Manufacturer	Model	Version
Radiated Software	UL	UL EMC	Ver 9.5, Apr 26, 2016
Conducted Software	UL	UL EMC	Ver 9.5, May 26, 2015
Antenna Port Software	UL	UL RF	Ver 5.1.1, July 15, 2016

The following test and measurement equipment was utilized for the tests documented in this report:

NOTE: *testing is completed before equipment calibration expiration date.

7. ON TIME, DUTY CYCLE AND MEASUREMENT METHODS

7.1. ON TIME AND DUTY CYCLE

LIMITS

None; for reporting purposes only.

PROCEDURE

KDB 789033 Zero-Span Spectrum Analyzer Method.

RESULTS

Mode	ON Time B (msec)	Period (msec)	Duty Cycle x (linear)	Duty Cycle (%)	Duty Cycle Correction Factor (dB)	1/T Minimum VBW (kHz)
802.11a	2.030	2.145	0.946	94.6%	0.24	0.493
802.11n HT20	4.968	5.088	0.976	97.6%	0.10	0.201
802.11n HT40	2.395	2.520	0.950	95.0%	0.22	0.418
802.11ac VHT80	1.136	1.250	0.909	90.9%	0.42	0.880

DUTY CYCLE PLOTS

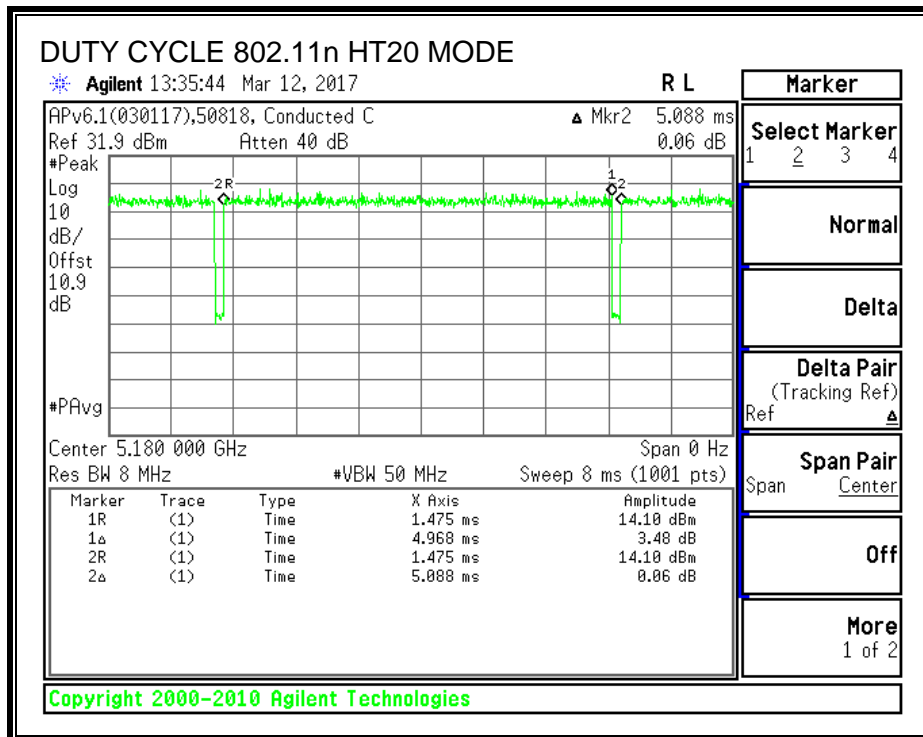
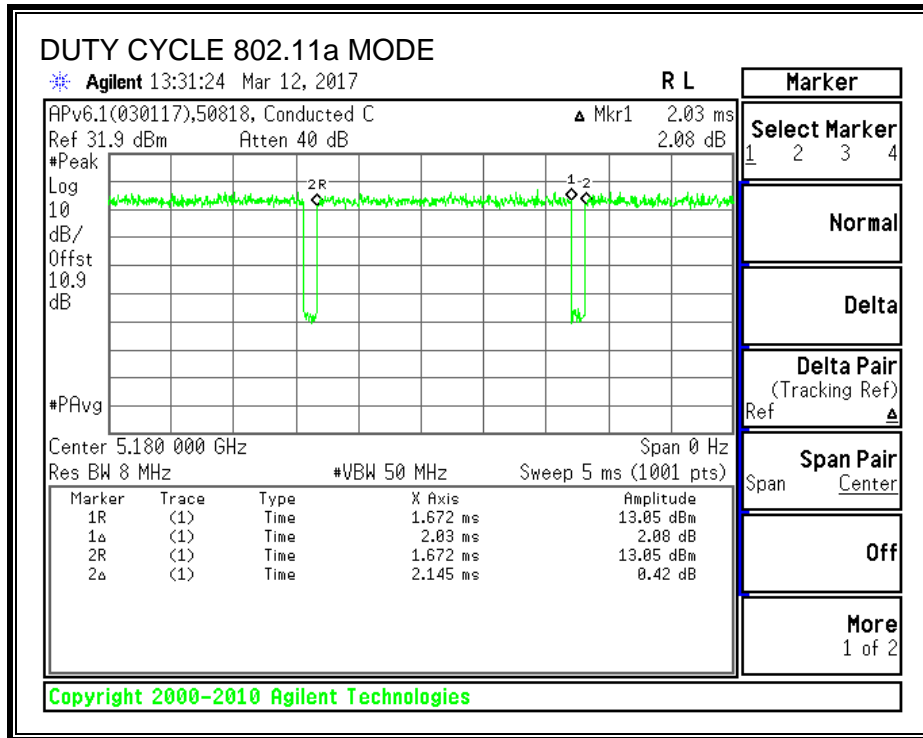

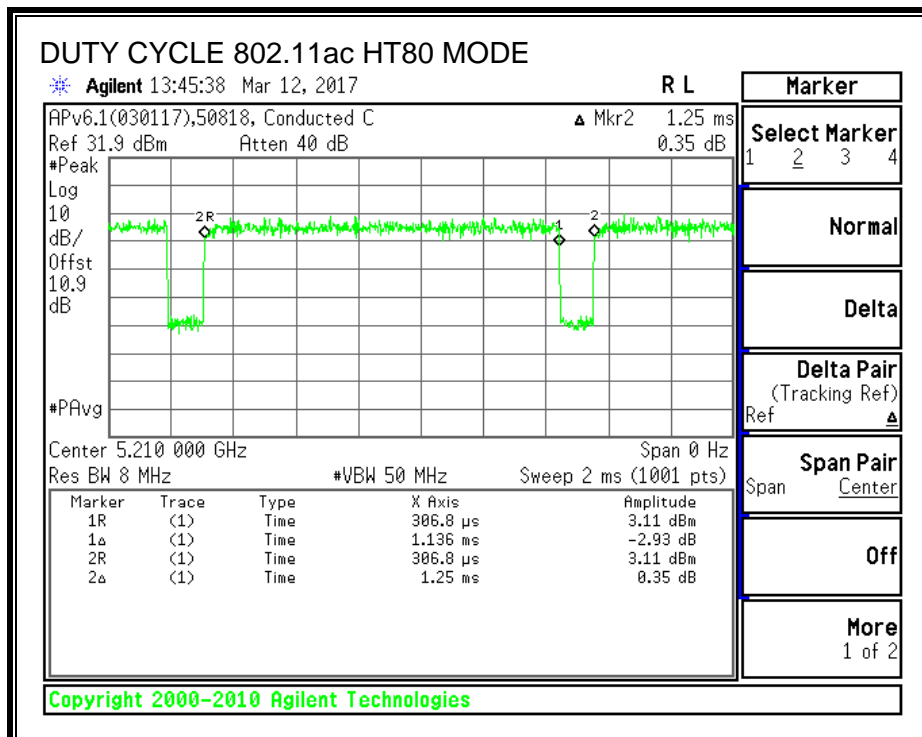
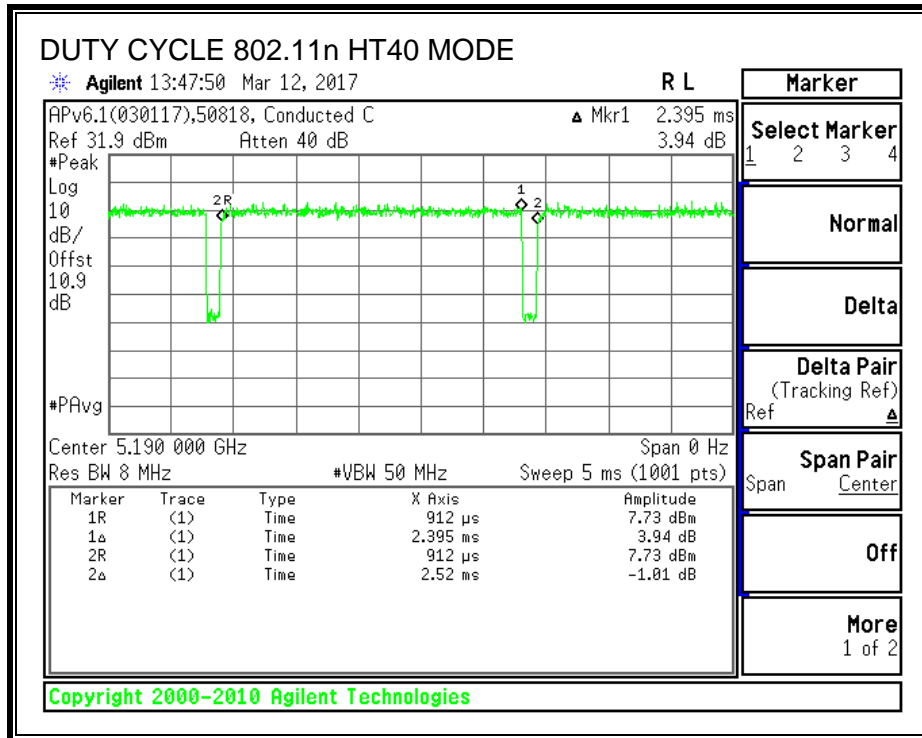

7.2. MEASUREMENT METHODS

On Time and Duty Cycle: KDB 789033 D02 v01r03, Section B.

6 dB Emission BW: KDB 789033 D02 v01r03, Section C.2.

26 dB Emission BW: KDB 789033 D02 v01r03, Section C.2.1.

99% Occupied BW: KDB 789033 D02 v01r03, Section D.

Conducted Output Power: KDB 789033 D02 v01r03, Section E.3.b (Method PM-G) and KDB 662911 D01 v02r01.

Power Spectral Density: KDB 789033 D02 v01r03, Section F and KDB 662911 D01 v02r01.

Unwanted emissions in restricted bands: KDB 789033 D02 v01r03, Sections G.3, G.4, G.5, and G.6, and KDB 662911 D01 v02r01.

Unwanted emissions in non-restricted bands: KDB 789033 D02 v01r03, Sections G.3, G.4, and G.5, and KDB 662911 D01 v02r01.

AC Power Line Conducted Emissions: ANSI C63.10-2013, Section 6.2.

8. SUMMARY TABLE

FCC Part Section	RSS Section	Test Description	Test Limit	Test Condition	Test Result
§15.407 (a)	RSS-247	Occupied Band width (26dB)	N/A	Conducted	Pass
§15.407	RSS-247 6.2.4	6dB Band width (5.8Ghz)	>500KHz		Pass
§15.407 (a)(1)	RSS-247 6.2	TX Cond. Power 5.15-5.25 GHz	<24dBm (FCC) / <23 dBm EIRP or <10+10Log(99% BW) EIRP (IC)		Pass
§15.407 (a)(2)	RSS-247 6.2	TX Cond. Power 5.25-5.35 & 5.47-5.725 GHz	<24dBm or <11+10log (OBW) (FCC) / <24 dBm or <11+10Log(99% BW) (IC)		Pass
§15.407 (a)(3)	RSS-247 6.2.4	TX Cond. Power 5.725-5.850 GHz	<30dBm		Pass
§15.407 (a)(1)	RSS-247 6.2	PSD (5.15-5.25 GHz)	<11dBm/MHz (FCC) <10 dBm/MHz EIRP (IC)		Pass
§15.407 (a)(2)	RSS-247 6.2	PSD (5.3,5.5GHz)	<11dBm/MHz		Pass
§15.407 (a)(3)	RSS-247 6.2.4	PSD (5.8GHz)	<30dBm per 500kHz		Pass
§15.207 (a) §15.407(b) (6)	RSS-GEN 8.8	AC Power Line conducted emissions	Section 10		Pass
§15.407 (b) & 15.209	RSS-GEN 8.9/7	Radiated Spurious Emission	<54dBuV/m	Radiated	Pass

9. ANTENNA PORT TEST RESULTS

9.1. 11a 2TX CDD MIMO MODE IN THE 5.2GHz BAND

9.1.1. 26 dB BANDWIDTH

LIMITS

None; for reporting purposes only.

RESULTS

Channel	Frequency	26 dB BW Chain 0 (MHz)	26 dB BW Chain 1 (MHz)
Low	5180	23.40	23.75
Mid	5200	23.50	23.35
High	5240	23.55	23.75

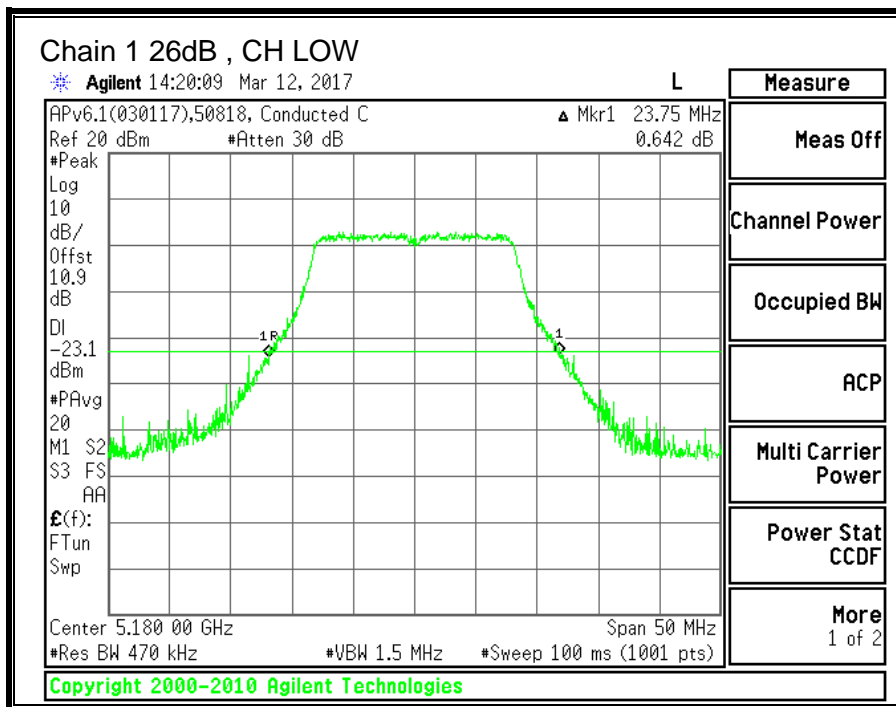
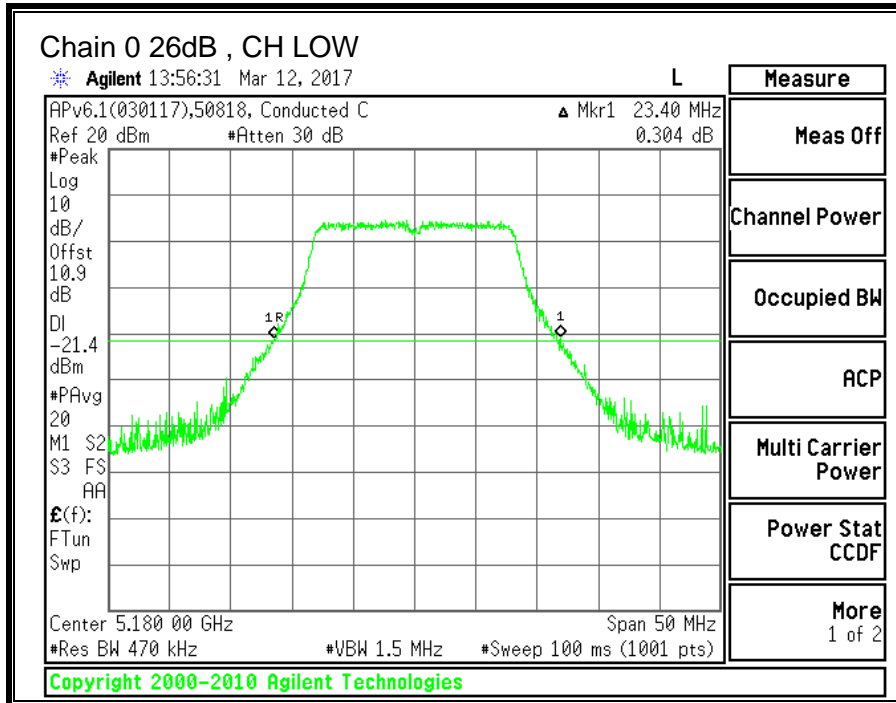

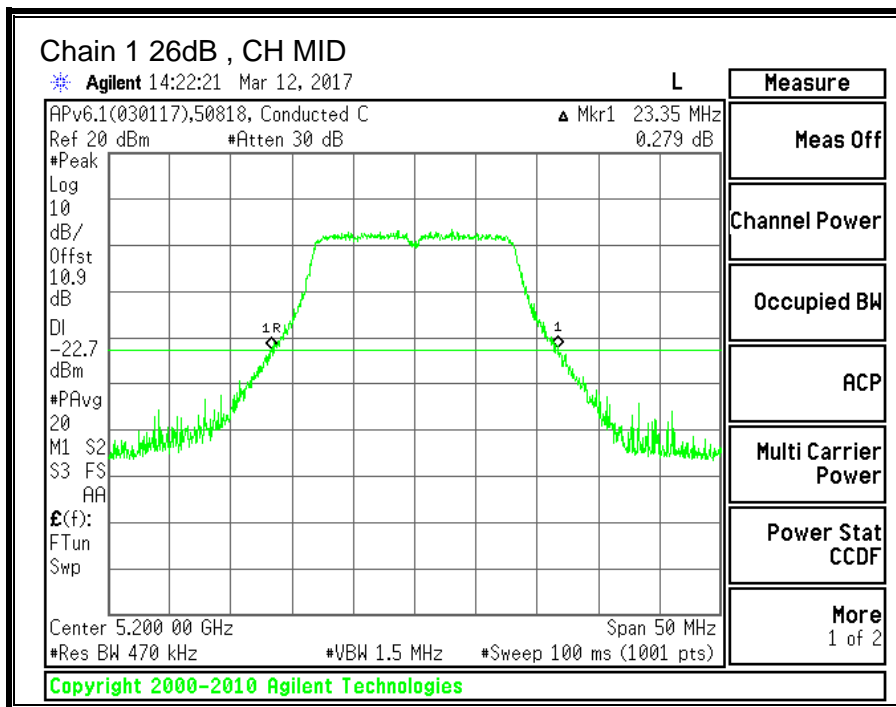
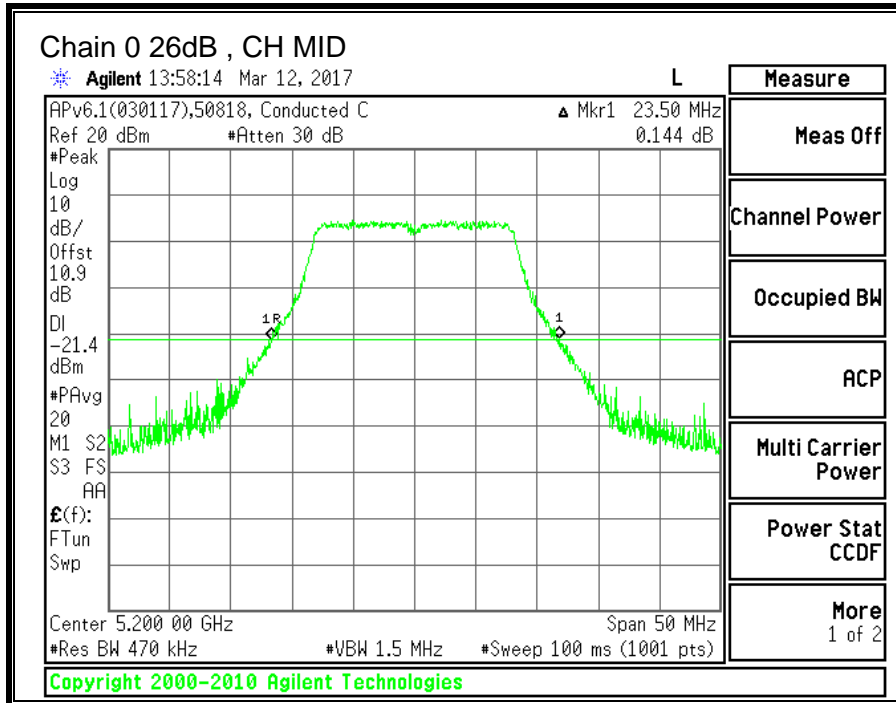

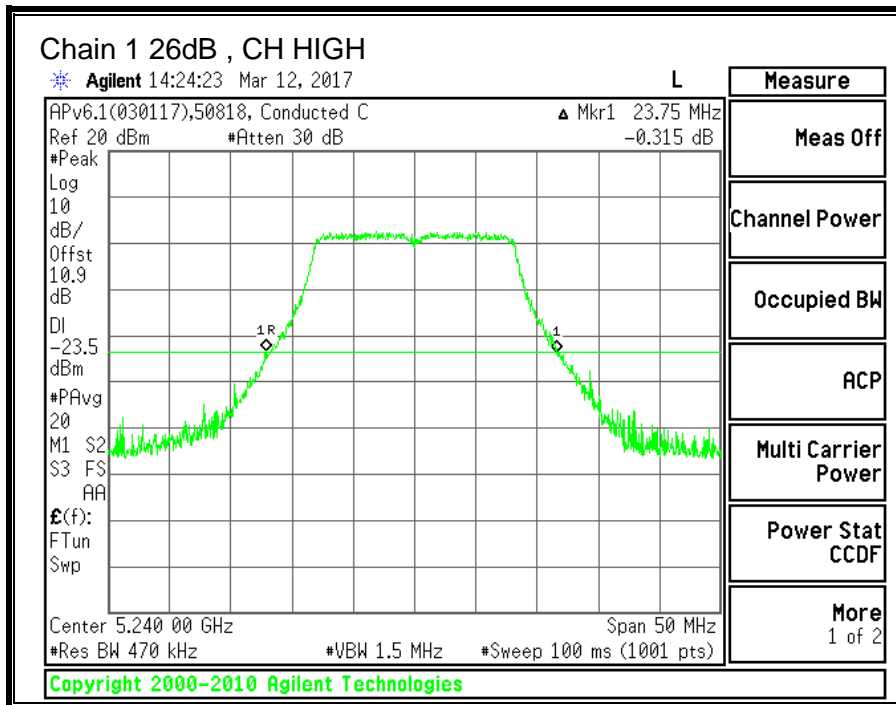
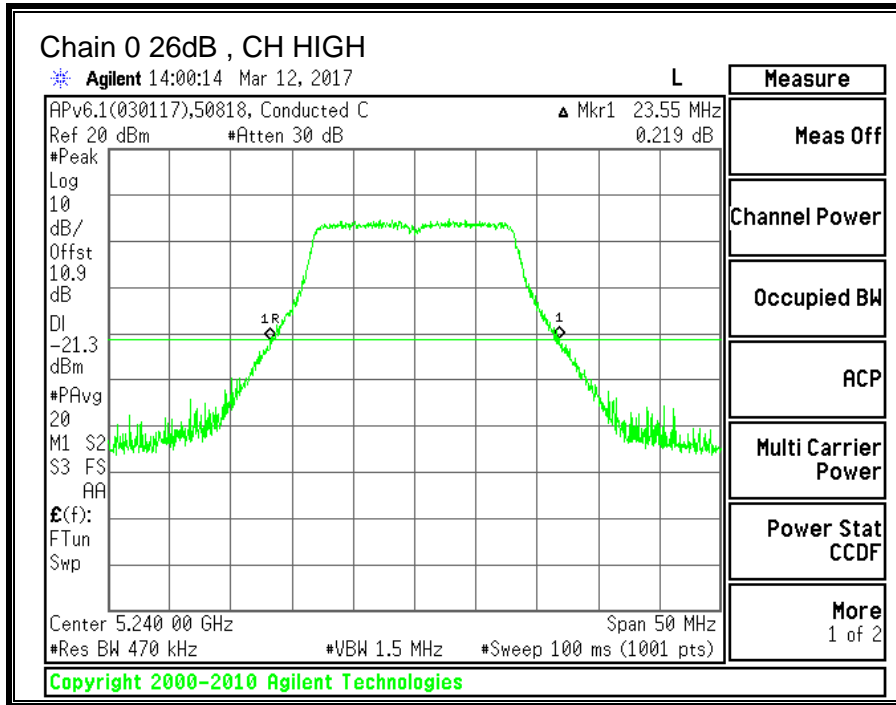

9.1.2. 99% BANDWIDTH

LIMITS

None; for reporting purposes only.

RESULTS

Channel	Frequency	99% BW Chain 0 (MHz)	99% BW Chain 1 (MHz)
Low	5180	16.1728	16.3001
Mid	5200	16.1939	16.3376
High	5240	16.4306	16.0687

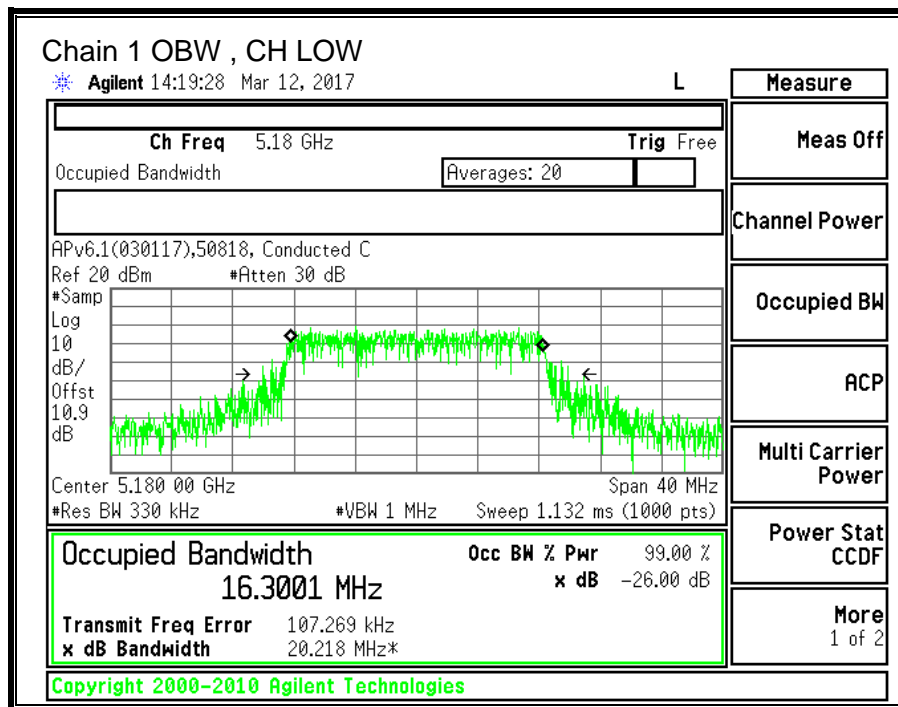
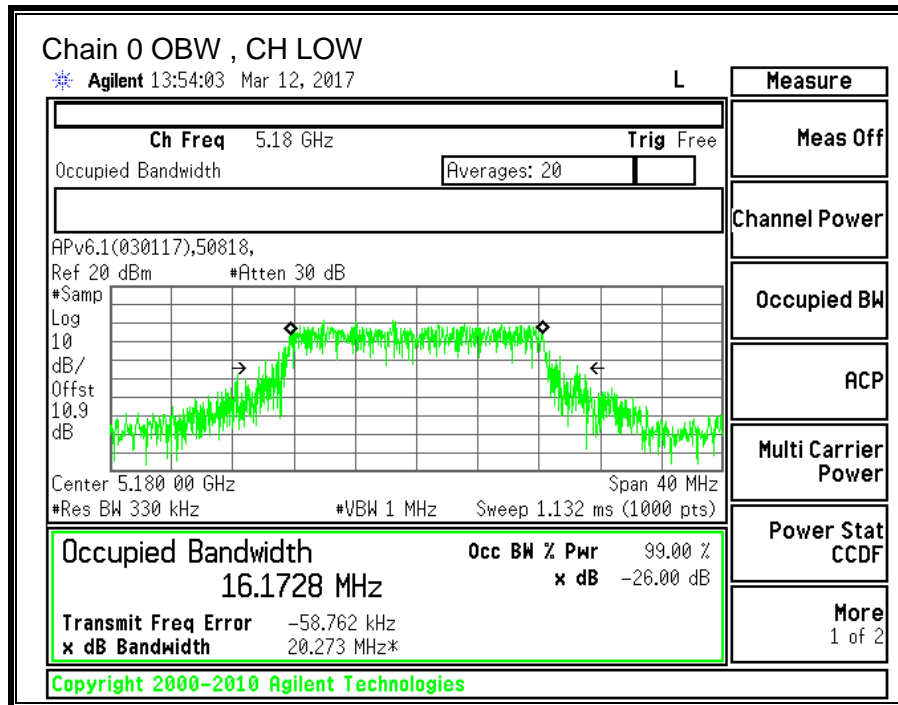

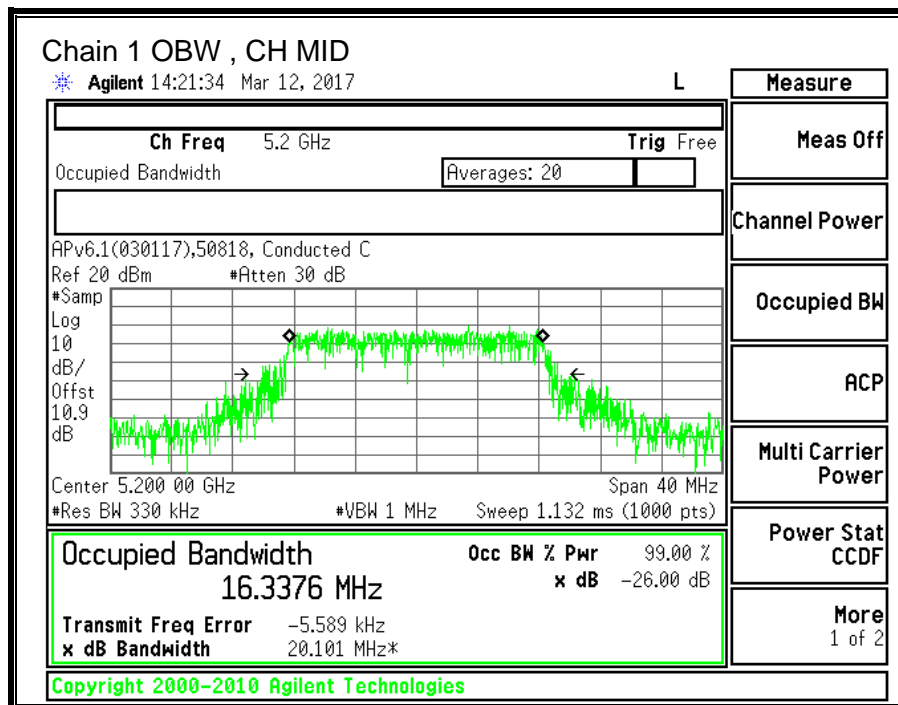
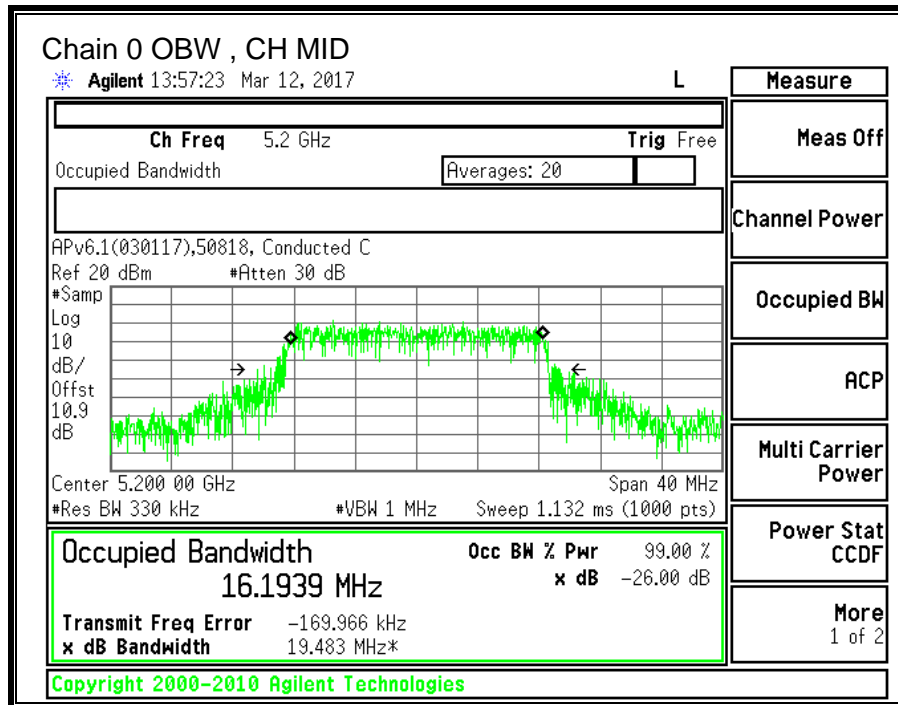

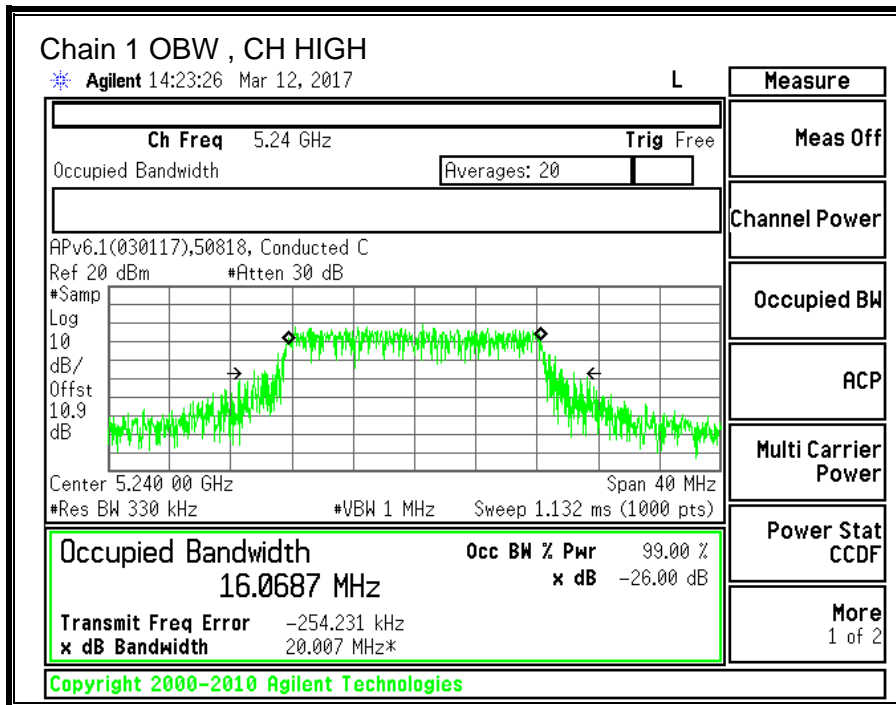
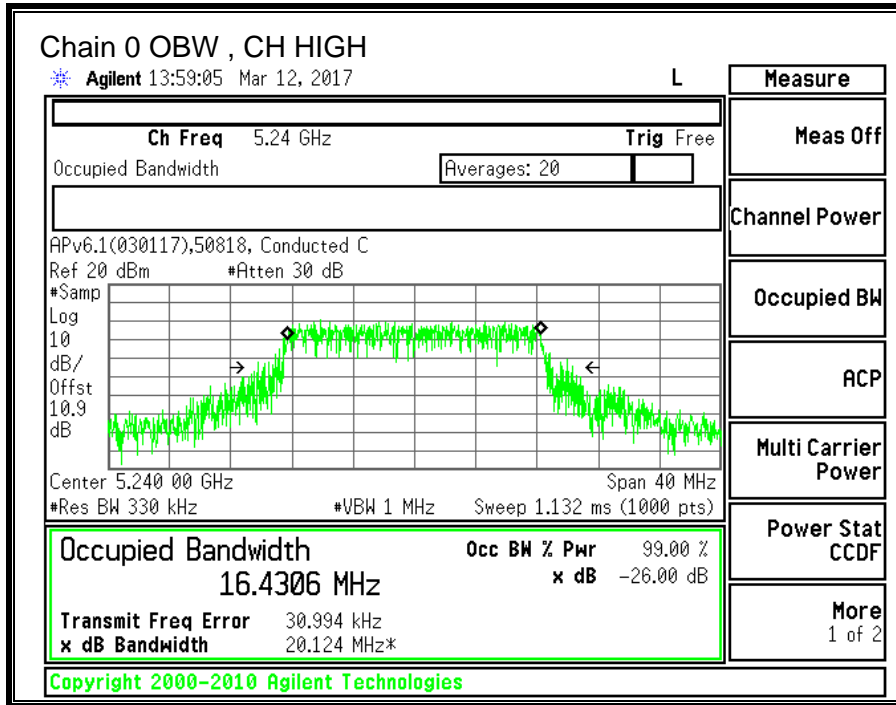

9.1.3. OUTPUT POWER AND PPSD

LIMITS

FCC §15.407 (a) (1)

(i) For an outdoor access point operating in the band 5.15-5.25 GHz, the maximum conducted output power over the frequency band of operation shall not exceed 1 W provided the maximum antenna gain does not exceed 6 dBi. In addition, the maximum power spectral density shall not exceed 17 dBm in any 1 megahertz band. If transmitting antennas of directional gain greater than 6 dBi are used, both the maximum conducted output power and the maximum power spectral density shall be reduced by the amount in dB that the directional gain of the antenna exceeds 6 dBi. The maximum e.i.r.p. at any elevation angle above 30 degrees as measured from the horizon must not exceed 125 mW (21 dBm).

(ii) For an indoor access point operating in the band 5.15-5.25 GHz, the maximum conducted output power over the frequency band of operation shall not exceed 1 W provided the maximum antenna gain does not exceed 6 dBi. In addition, the maximum power spectral density shall not exceed 17 dBm in any 1 megahertz band. If transmitting antennas of directional gain greater than 6 dBi are used, both the maximum conducted output power and the maximum power spectral density shall be reduced by the amount in dB that the directional gain of the antenna exceeds 6 dBi.

(iii) For fixed point-to-point access points operating in the band 5.15-5.25 GHz, the maximum conducted output power over the frequency band of operation shall not exceed 1 W. Fixed point-to-point U-NII devices may employ antennas with directional gain up to 23 dBi without any corresponding reduction in the maximum conducted output power or maximum power spectral density. For fixed point-to-point transmitters that employ a directional antenna gain greater than 23 dBi, a 1 dB reduction in maximum conducted output power and maximum power spectral density is required for each 1 dB of antenna gain in excess of 23 dBi. Fixed, point-to-point operations exclude the use of point-to-multipoint systems, omnidirectional applications, and multiple collocated transmitters transmitting the same information. The operator of the U-NII device, or if the equipment is professionally installed, the installer, is responsible for ensuring that systems employing high gain directional antennas are used exclusively for fixed, point-to-point operations.

(iv) For mobile and portable client devices in the 5.15-5.25 GHz band, the maximum conducted output power over the frequency band of operation shall not exceed 250 mW provided the maximum antenna gain does not exceed 6 dBi. In addition, the maximum power spectral density shall not exceed 11 dBm in any 1 megahertz band. If transmitting antennas of directional gain greater than 6 dBi are used, both the maximum conducted output power and the maximum power spectral density shall be reduced by the amount in dB that the directional gain of the antenna exceeds 6 dBi.

IC RSS-247 (6.2.1) (1)

The maximum EIRP shall not exceed 200 mW or $10 + 10 \log_{10} B$, dBm, whichever power is less. B is the 99% emission bandwidth in MHz. The e.i.r.p. spectral density shall not exceed 10 dBm in any 1.0 MHz band.

TEST PROCEDURE

Measurements perform using a wideband gated RF power meter provided that the gate parameters are adjusted such that the power is measured only when the EUT is transmitting at its maximum power control level. Since the measurement is made only during the ON time of the transmitter, no duty cycle correction factor is required.

DIRECTIONAL ANTENNA GAIN

For power, the TX chains are uncorrelated and the antenna gain is unequal among the chains. The directional gain is:

5150-5250 MHz

Chain 0 Antenna Gain (dBi)	Chain 1 Antenna Gain (dBi)	Uncorrelated Chains Directional Gain (dBi)
-2.40	-0.10	-1.10

For PSD the TX chains are correlated and the antenna gain is unequal among the chains. The directional gain is:

5150-5250 MHz

Chain 0 Antenna Gain (dBi)	Chain 1 Antenna Gain (dBi)	Correlated Chains Directional Gain (dBi)
-2.40	-0.10	1.84

RESULTS

ID:	43578	Date:	3/17/17
------------	-------	--------------	---------

Bandwidth and Antenna Gain

Channel	Frequency (MHz)	Min 26 dB BW (MHz)	Min 99% BW (MHz)	Directional Gain for Power (dBi)	Directional Gain for PPSD (dBi)
Low	5180	23.40	16.1728	-1.10	1.84
Mid	5200	23.35	16.1939	-1.10	1.84
High	5240	23.55	16.0687	-1.10	1.84

Limits

Channel	Frequency (MHz)	FCC Power Limit (dBm)	IC EIRP Limit (dBm)	Max IC Power (dBm)	Power Limit (dBm)	FCC PPSD Limit (dBm)	IC eirp PSD Limit (dBm)	PPSD Limit (dBm)
Low	5180	24.00	22.09	23.19	23.19	11.00	10.00	8.16
Mid	5200	24.00	22.09	23.19	23.19	11.00	10.00	8.16
High	5240	24.00	22.06	23.16	23.16	11.00	10.00	8.16

Duty Cycle CF (dB)	0.24	Included in Calculations of Corr'd PPSD
---------------------------	------	--

Output Power Results

Channel	Frequency (MHz)	Chain 0 Meas Power (dBm)	Chain 1 Meas Power (dBm)	Total Corr'd Power (dBm)	Power Limit (dBm)	Power Margin (dB)
Low	5180	12.76	10.45	14.77	23.19	-8.42
Mid	5200	12.88	10.39	14.82	23.19	-8.37
High	5240	12.74	10.04	14.61	23.16	-8.55

PPSD Results

Channel	Frequency (MHz)	Chain 0 Meas PPSD (dBm)	Chain 1 Meas PPSD (dBm)	Total Corr'd PPSD (dBm)	PPSD Limit (dBm)	PPSD Margin (dB)
Low	5180	1.486	-0.902	3.70	8.16	-4.46
Mid	5200	1.805	-0.729	3.97	8.16	-4.19
High	5240	1.261	-1.084	3.50	8.16	-4.66

Note: the power readings above were measured with gated method, and the measurement was taken only during the ON time. No duty cycle correction was necessary.

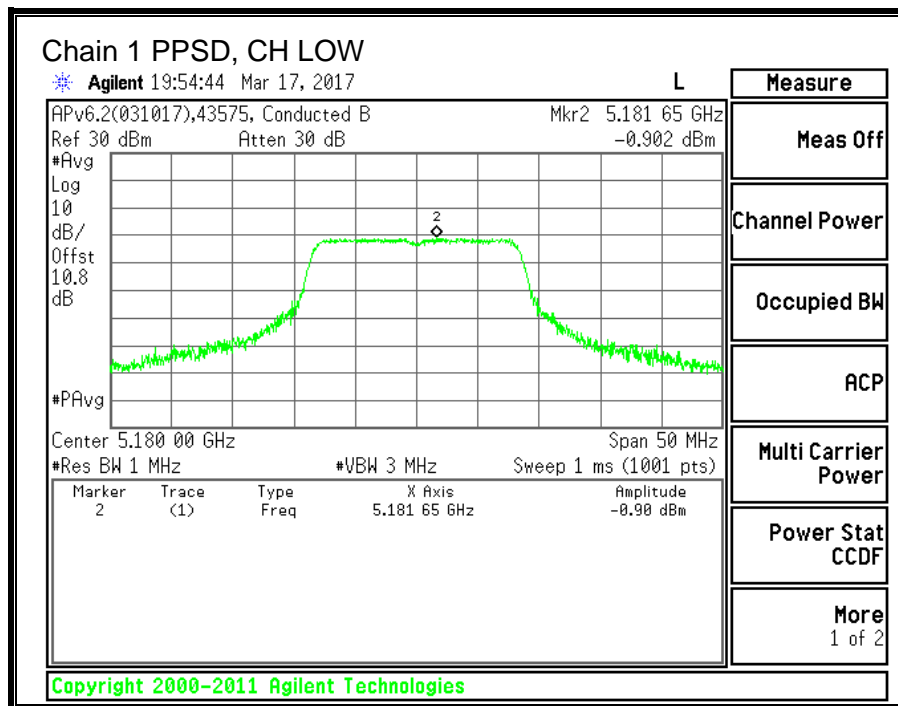
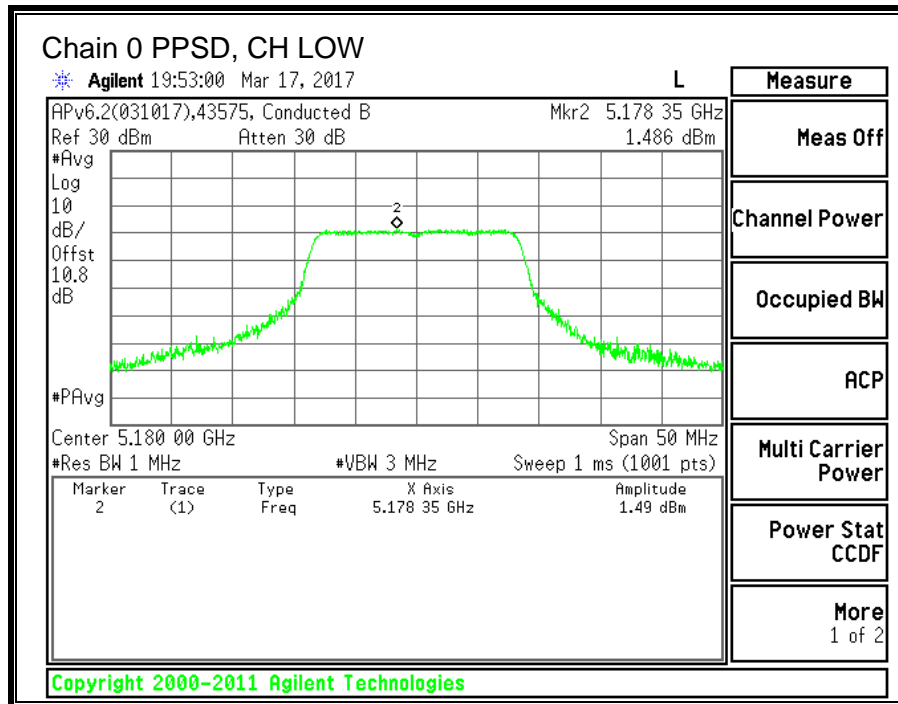

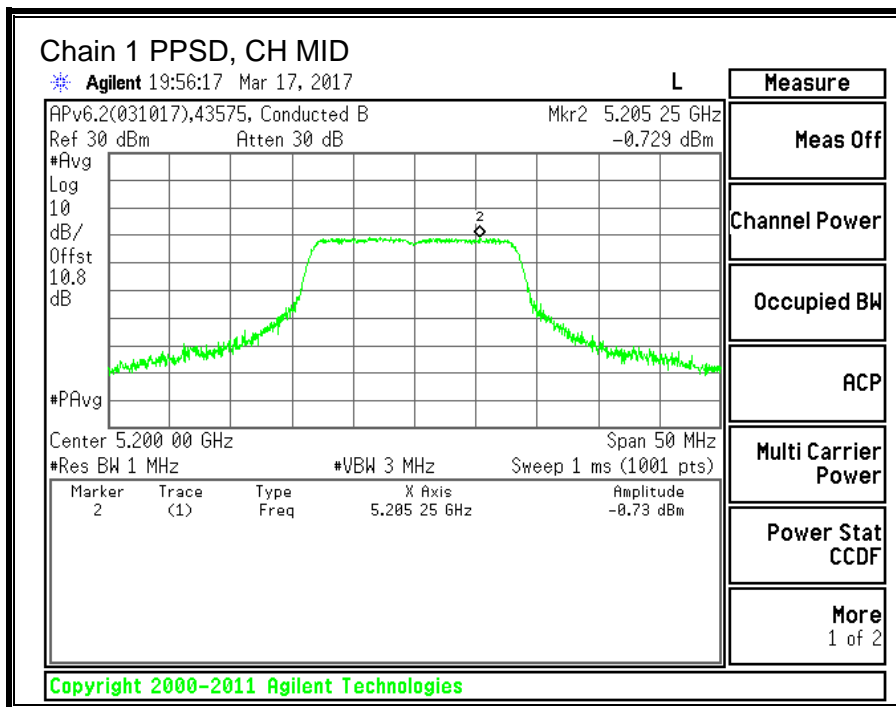
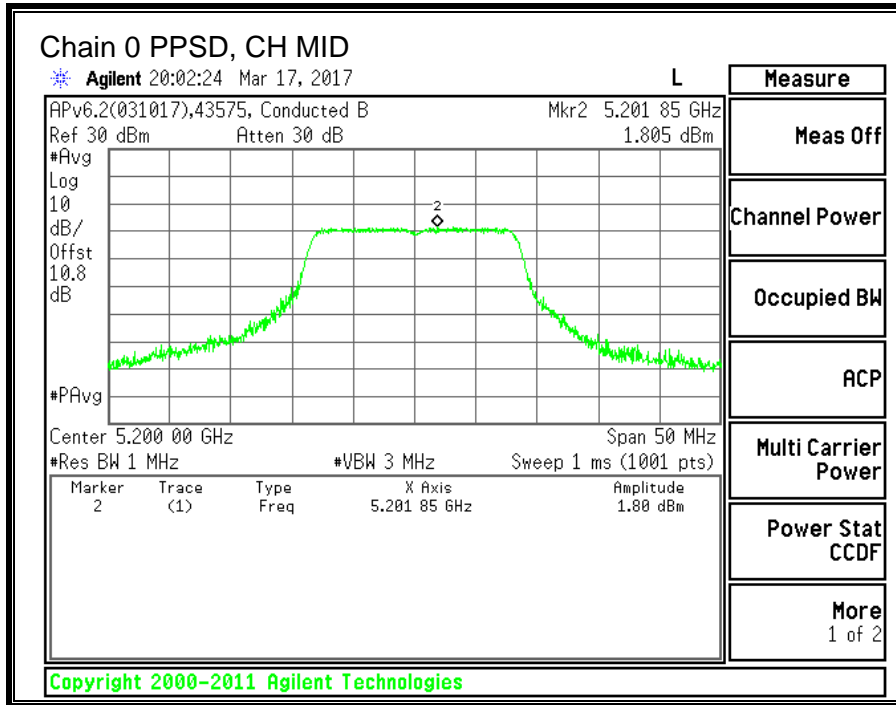

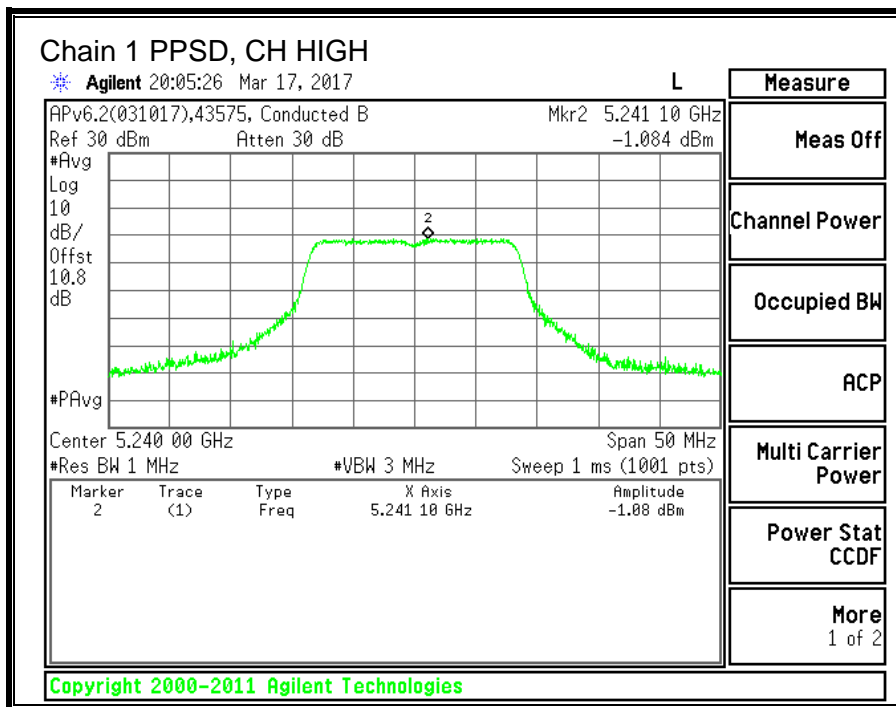
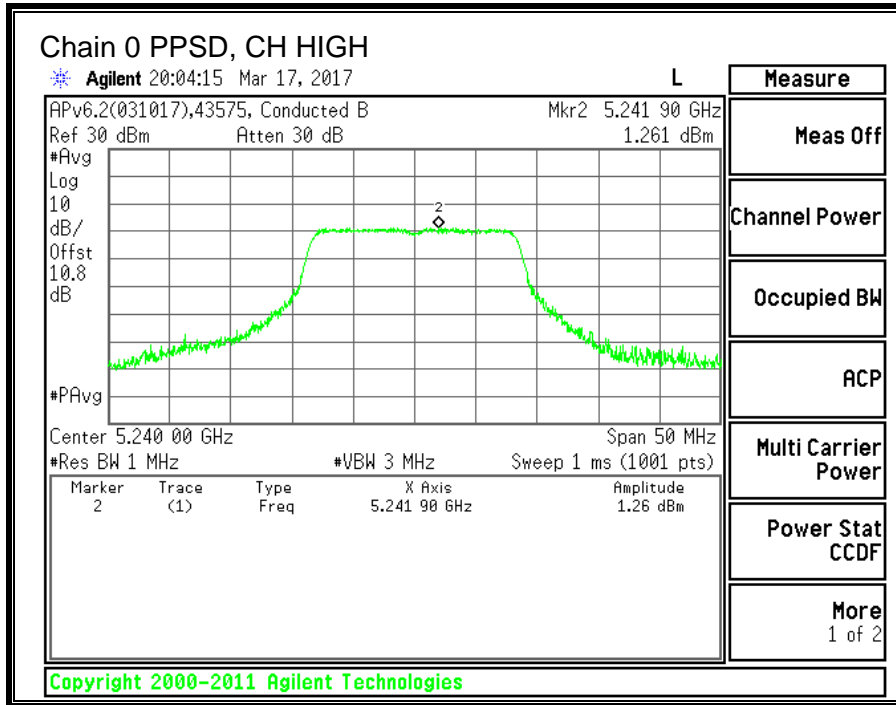

9.2. 11n HT20 2TX CDD MIMO MODE IN THE 5.2GHz BAND

9.2.1. 26 dB BANDWIDTH

LIMITS

None; for reporting purposes only.

RESULTS

Channel	Frequency	26 dB BW Chain 0 (MHz)	26 dB BW Chain 1 (MHz)
Low	5180	24.10	24.30
Mid	5200	24.30	23.60
High	5240	24.25	24.15

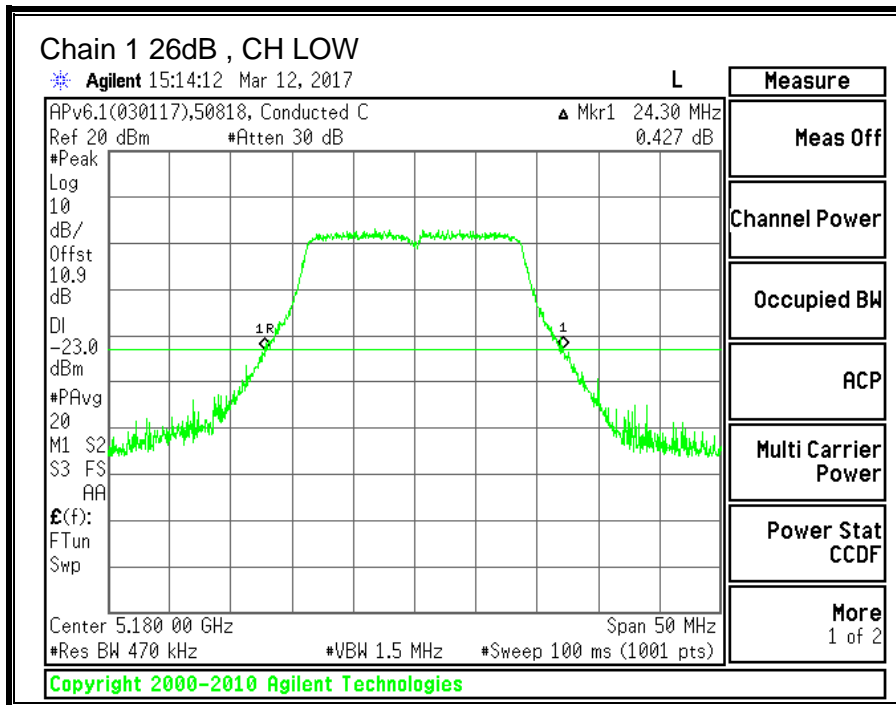
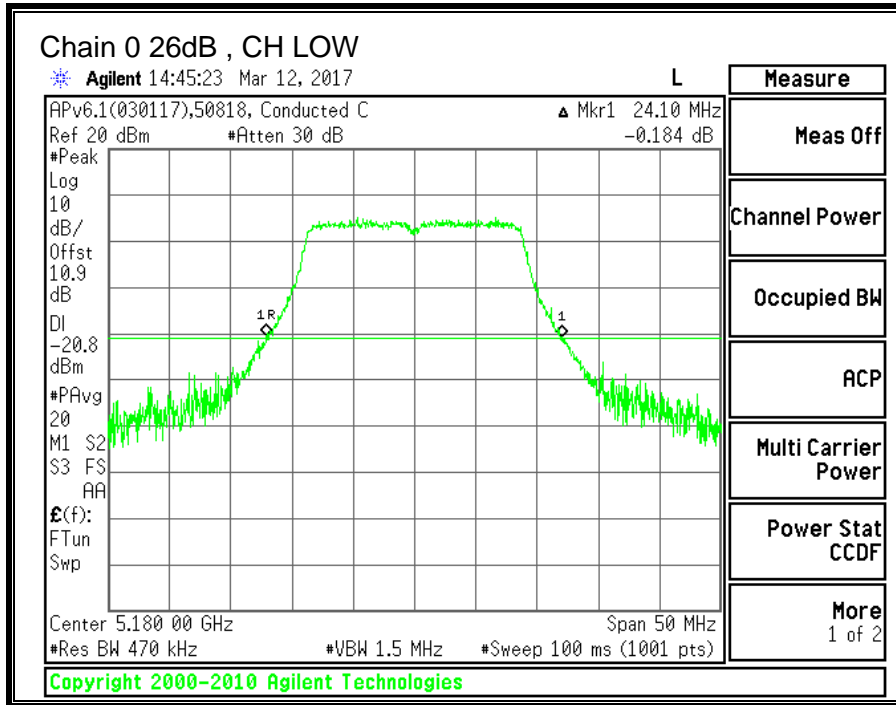

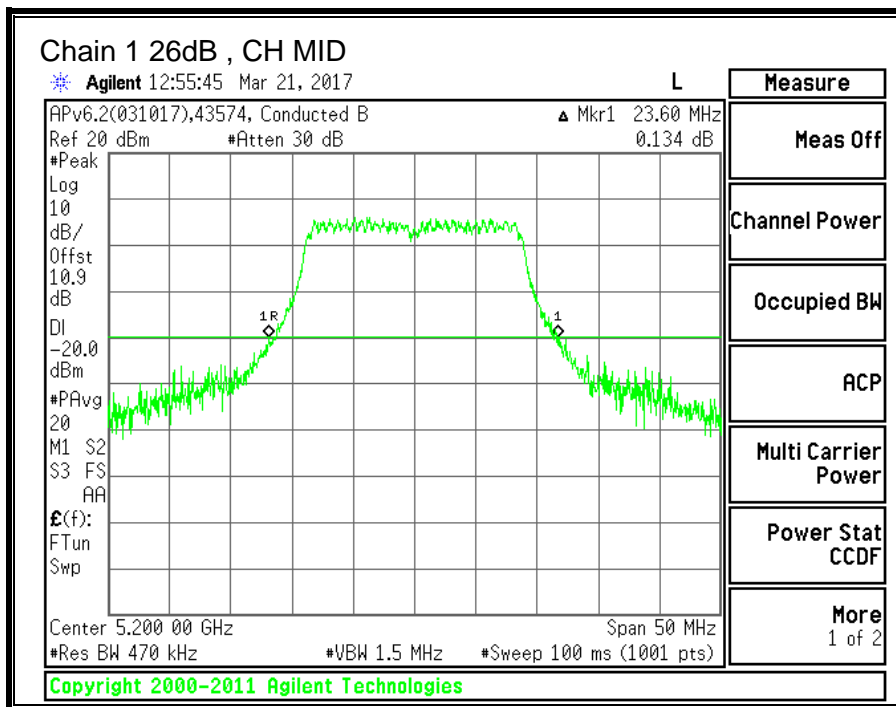
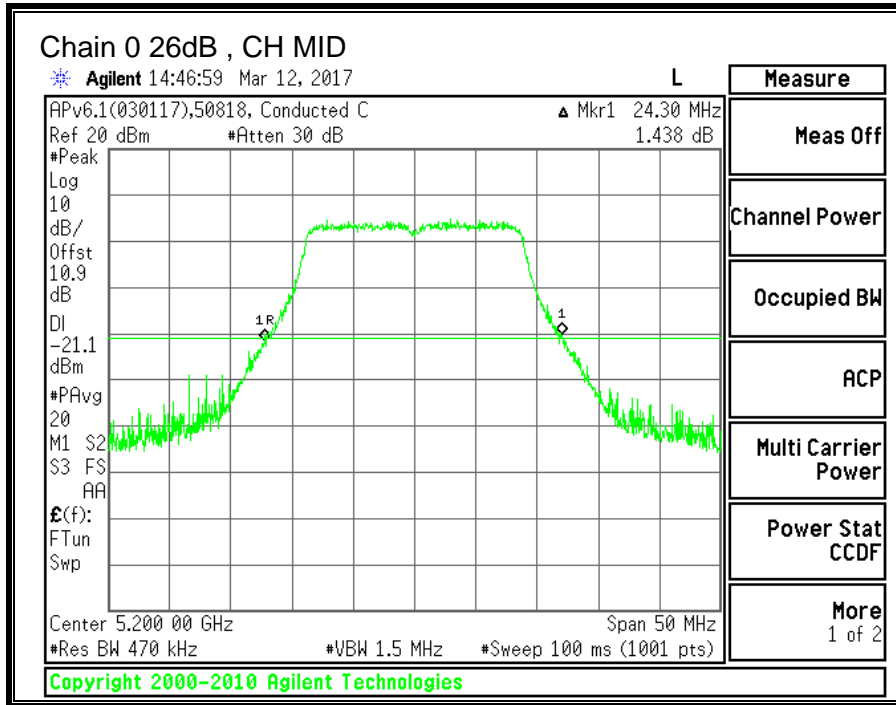

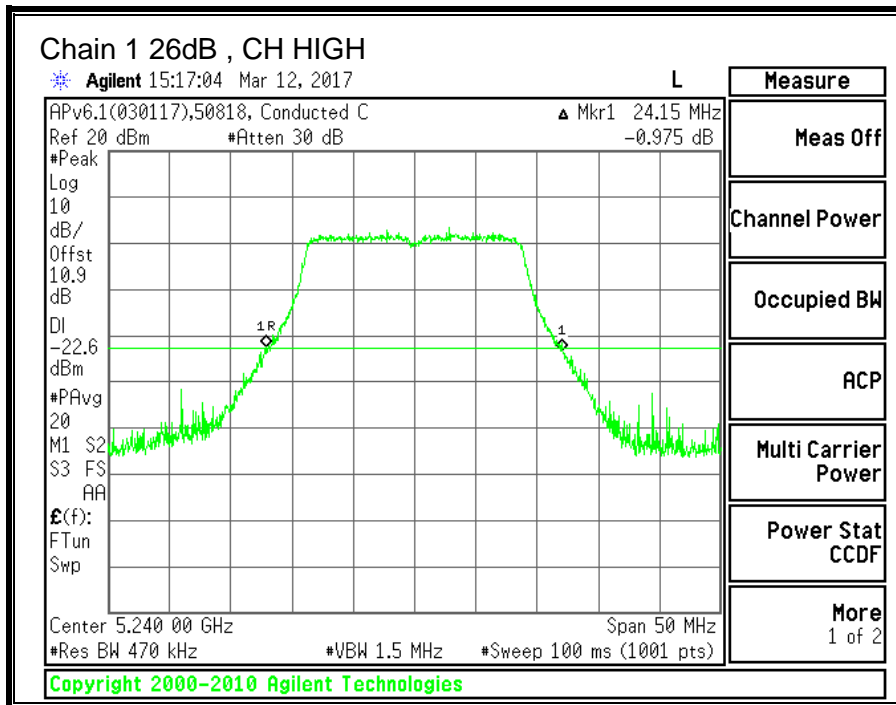
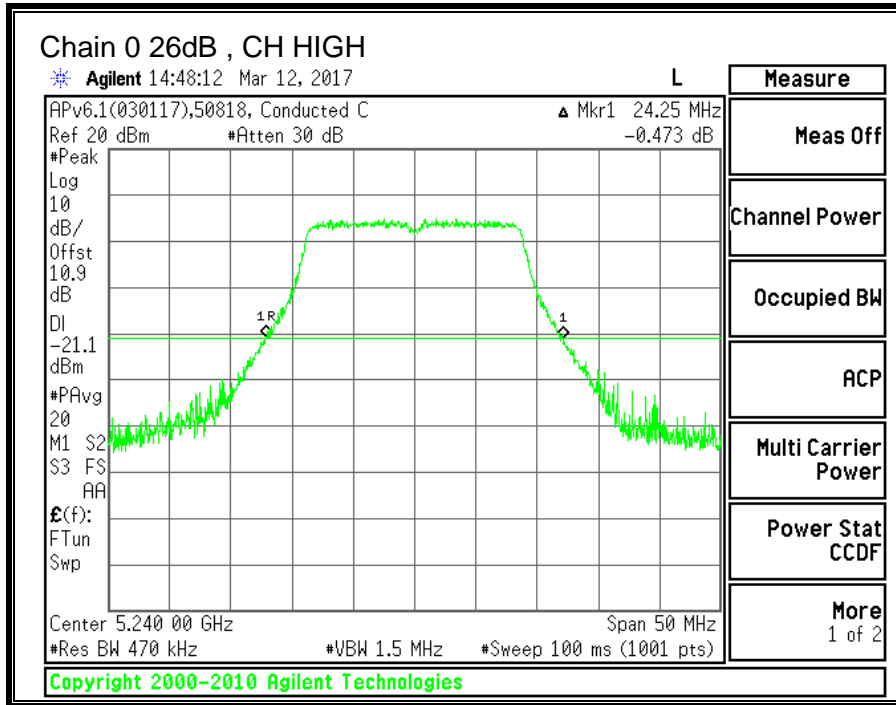

9.2.2. 99% BANDWIDTH

LIMITS

None; for reporting purposes only.

RESULTS

Channel	Frequency	99% BW Chain 0 (MHz)	99% BW Chain 1 (MHz)
Low	5180	17.7543	17.7066
Mid	5200	17.7797	17.7553
High	5240	17.6991	17.7612

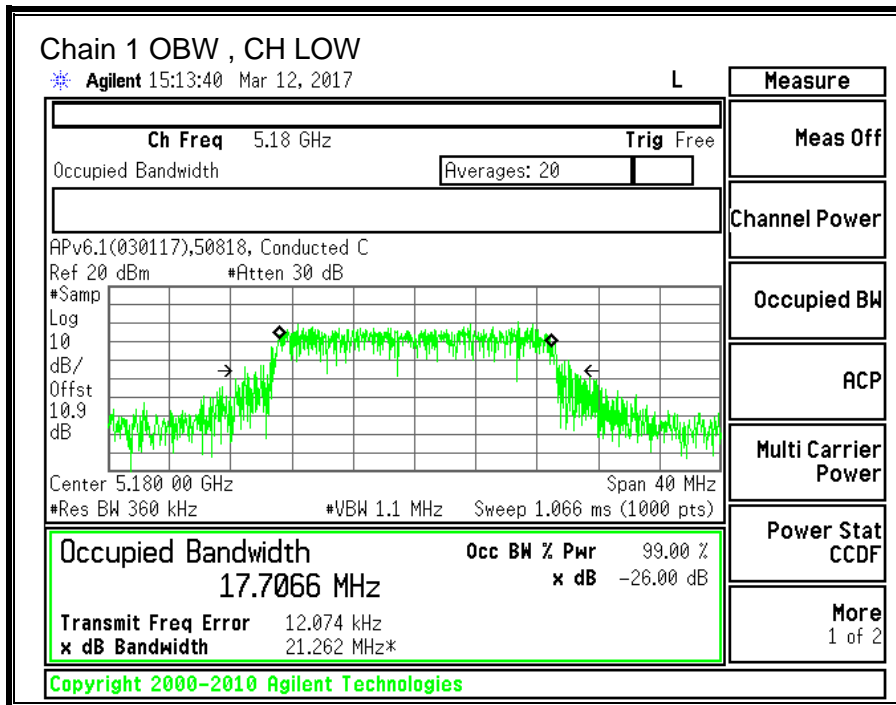
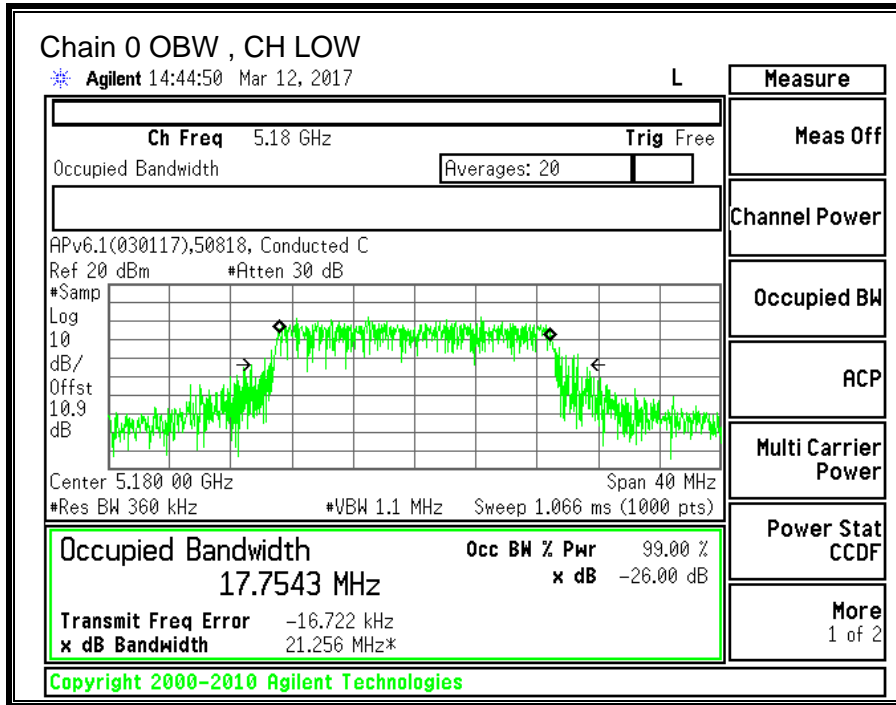

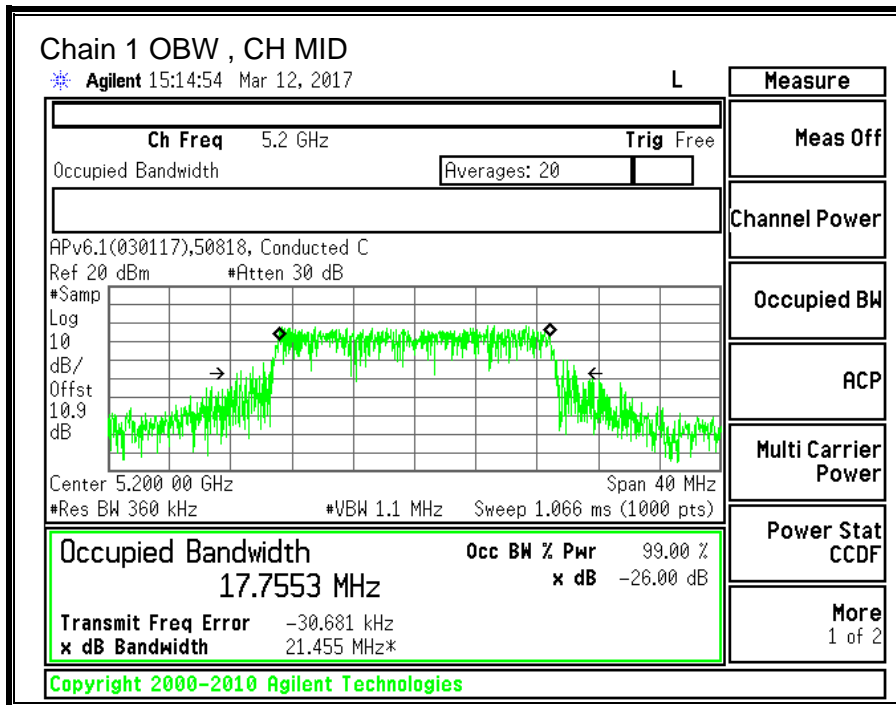
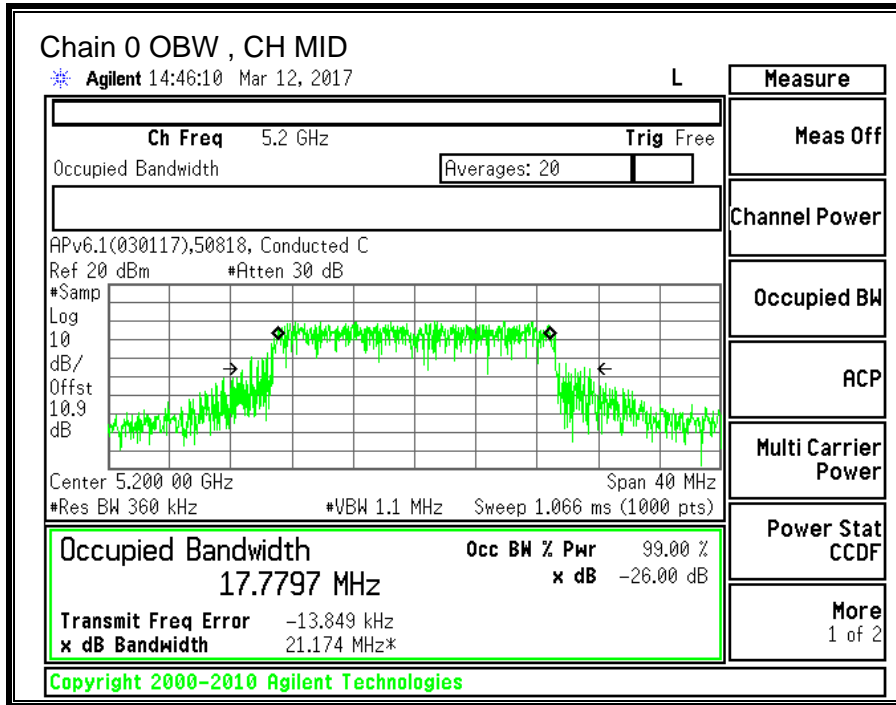

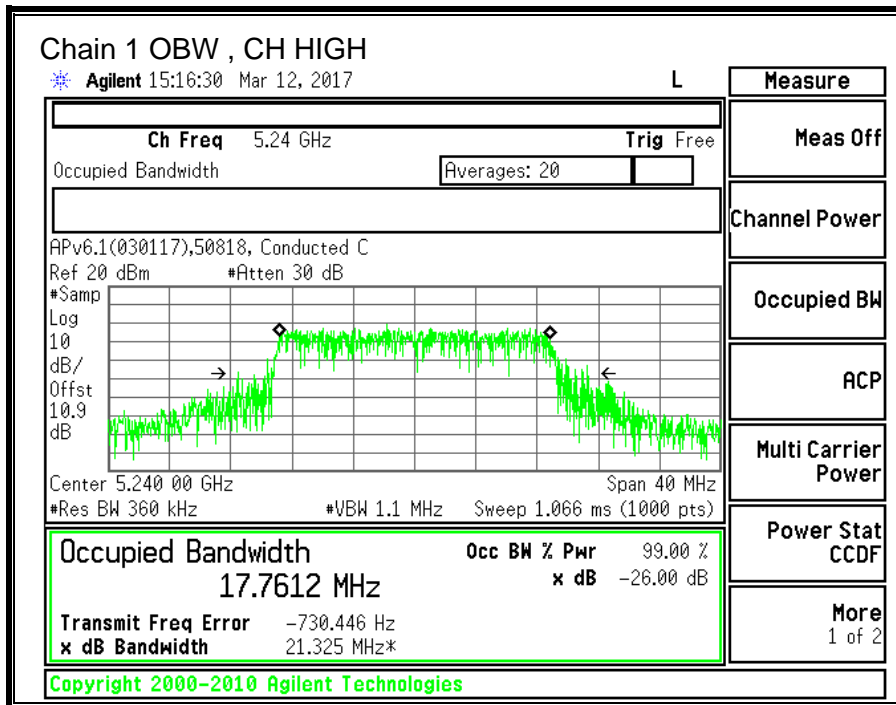
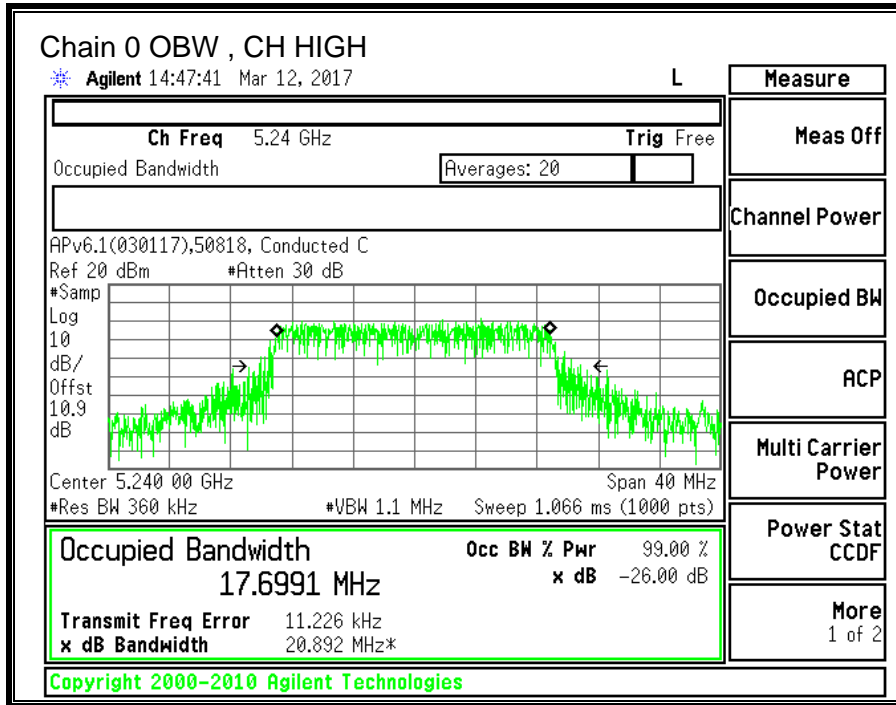

9.2.3. OUTPUT POWER AND PPSD

LIMITS

FCC §15.407 (a) (1)

(i) For an outdoor access point operating in the band 5.15-5.25 GHz, the maximum conducted output power over the frequency band of operation shall not exceed 1 W provided the maximum antenna gain does not exceed 6 dBi. In addition, the maximum power spectral density shall not exceed 17 dBm in any 1 megahertz band. If transmitting antennas of directional gain greater than 6 dBi are used, both the maximum conducted output power and the maximum power spectral density shall be reduced by the amount in dB that the directional gain of the antenna exceeds 6 dBi. The maximum e.i.r.p. at any elevation angle above 30 degrees as measured from the horizon must not exceed 125 mW (21 dBm).

(ii) For an indoor access point operating in the band 5.15-5.25 GHz, the maximum conducted output power over the frequency band of operation shall not exceed 1 W provided the maximum antenna gain does not exceed 6 dBi. In addition, the maximum power spectral density shall not exceed 17 dBm in any 1 megahertz band. If transmitting antennas of directional gain greater than 6 dBi are used, both the maximum conducted output power and the maximum power spectral density shall be reduced by the amount in dB that the directional gain of the antenna exceeds 6 dBi.

(iii) For fixed point-to-point access points operating in the band 5.15-5.25 GHz, the maximum conducted output power over the frequency band of operation shall not exceed 1 W. Fixed point-to-point U-NII devices may employ antennas with directional gain up to 23 dBi without any corresponding reduction in the maximum conducted output power or maximum power spectral density. For fixed point-to-point transmitters that employ a directional antenna gain greater than 23 dBi, a 1 dB reduction in maximum conducted output power and maximum power spectral density is required for each 1 dB of antenna gain in excess of 23 dBi. Fixed, point-to-point operations exclude the use of point-to-multipoint systems, omnidirectional applications, and multiple collocated transmitters transmitting the same information. The operator of the U-NII device, or if the equipment is professionally installed, the installer, is responsible for ensuring that systems employing high gain directional antennas are used exclusively for fixed, point-to-point operations.

(iv) For mobile and portable client devices in the 5.15-5.25 GHz band, the maximum conducted output power over the frequency band of operation shall not exceed 250 mW provided the maximum antenna gain does not exceed 6 dBi. In addition, the maximum power spectral density shall not exceed 11 dBm in any 1 megahertz band. If transmitting antennas of directional gain greater than 6 dBi are used, both the maximum conducted output power and the maximum power spectral density shall be reduced by the amount in dB that the directional gain of the antenna exceeds 6 dBi.

IC RSS-247 (6.2.1) (1)

The maximum EIRP shall not exceed 200 mW or $10 + 10 \log_{10} B$, dBm, whichever power is less. B is the 99% emission bandwidth in MHz. The e.i.r.p. spectral density shall not exceed 10 dBm in any 1.0 MHz band.

TEST PROCEDURE

Measurements perform using a wideband gated RF power meter provided that the gate parameters are adjusted such that the power is measured only when the EUT is transmitting at its maximum power control level. Since the measurement is made only during the ON time of the transmitter, no duty cycle correction factor is required.

DIRECTIONAL ANTENNA GAIN

For power, the TX chains are uncorrelated and the antenna gain is unequal among the chains. The directional gain is:

5150-5250 MHz

Chain 0 Antenna Gain (dBi)	Chain 1 Antenna Gain (dBi)	Uncorrelated Chains Directional Gain (dBi)
-2.40	-0.10	-1.10

For PSD the TX chains are correlated and the antenna gain is unequal among the chains. The directional gain is:

5150-5250 MHz

Chain 0 Antenna Gain (dBi)	Chain 1 Antenna Gain (dBi)	Correlated Chains Directional Gain (dBi)
-2.40	-0.10	1.84

RESULTS

ID:	43578	Date:	3/17/17
------------	-------	--------------	---------

Bandwidth and Antenna Gain

Channel	Frequency (MHz)	Min 26 dB BW (MHz)	Min 99% BW (MHz)	Directional Gain for Power (dBi)	Directional Gain for PPSD (dBi)
Low	5180	24.10	17.7066	-1.10	1.84
Mid	5200	23.60	17.7553	-1.10	1.84
High	5240	24.15	17.6991	-1.10	1.84

Limits

Channel	Frequency (MHz)	FCC Power Limit (dBm)	IC EIRP Limit (dBm)	Max IC Power (dBm)	Power Limit (dBm)	FCC PPSD Limit (dBm)	IC eirp PSD Limit (dBm)	PPSD Limit (dBm)
Low	5180	24.00	22.48	23.58	23.58	11.00	10.00	8.16
Mid	5200	24.00	22.49	23.59	23.59	11.00	10.00	8.16
High	5240	24.00	22.48	23.58	23.58	11.00	10.00	8.16

Duty Cycle CF (dB)	0.10	Included in Calculations of Corr'd PPSD
---------------------------	------	--

Output Power Results

Channel	Frequency (MHz)	Chain 0 Meas Power (dBm)	Chain 1 Meas Power (dBm)	Total Corr'd Power (dBm)	Power Limit (dBm)	Power Margin (dB)
Low	5180	12.71	10.45	14.74	23.58	-8.85
Mid	5200	12.76	10.36	14.73	23.59	-8.86
High	5240	12.60	10.18	14.57	23.58	-9.01

PPSD Results

Channel	Frequency (MHz)	Chain 0 Meas PPSD (dBm)	Chain 1 Meas PPSD (dBm)	Total Corr'd PPSD (dBm)	PPSD Limit (dBm)	PPSD Margin (dB)
Low	5180	1.270	-0.857	3.45	8.16	-4.71
Mid	5200	1.231	-0.779	3.45	8.16	-4.71
High	5240	1.373	-1.095	3.42	8.16	-4.74

Note: the power readings above were measured with gated method, and the measurement was taken only during the ON time. No duty cycle correction was necessary.

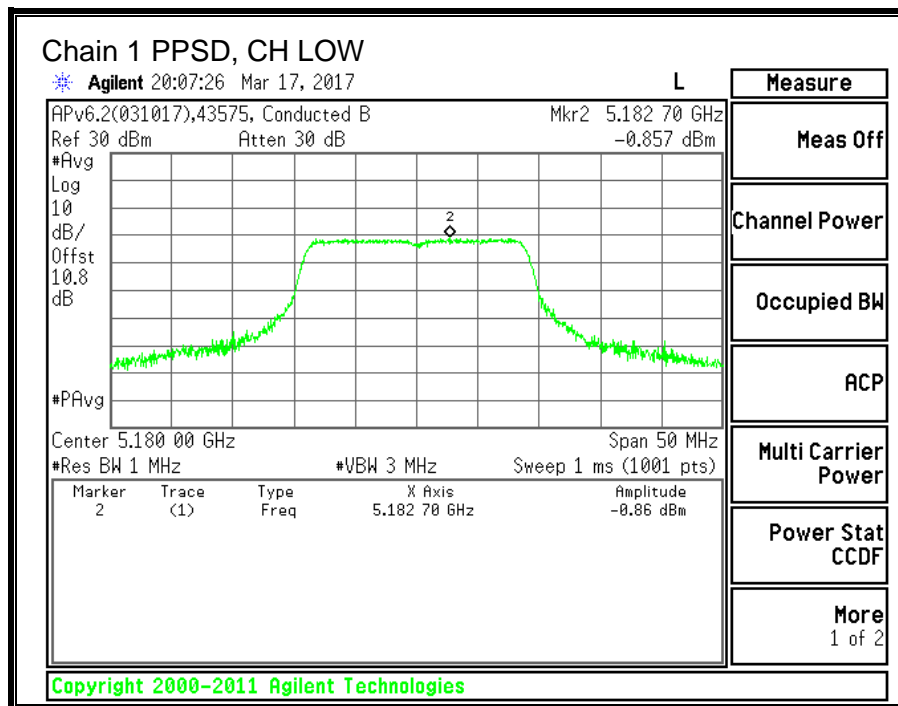
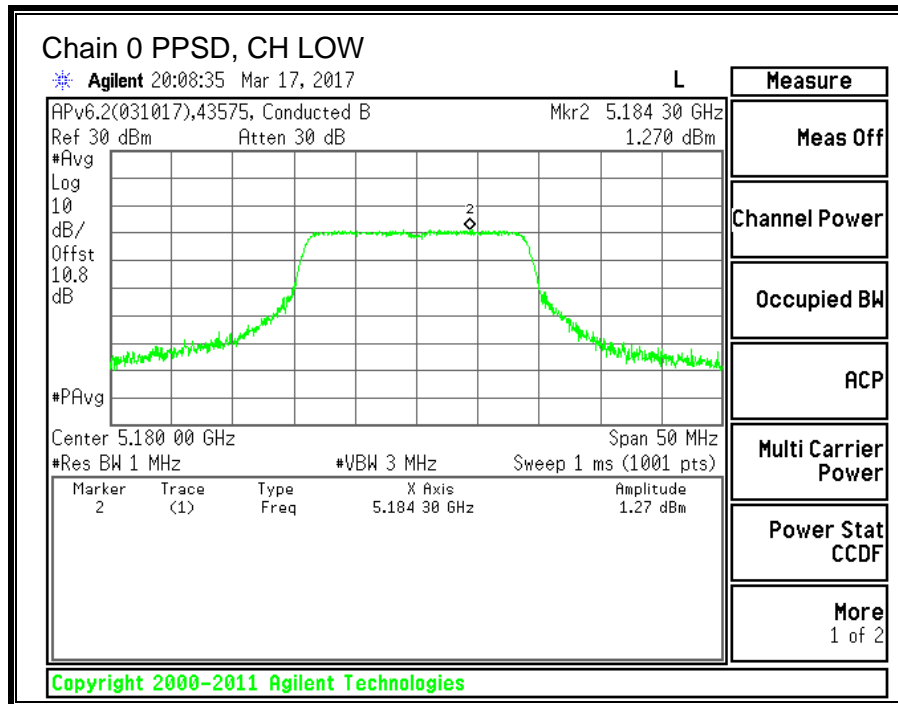

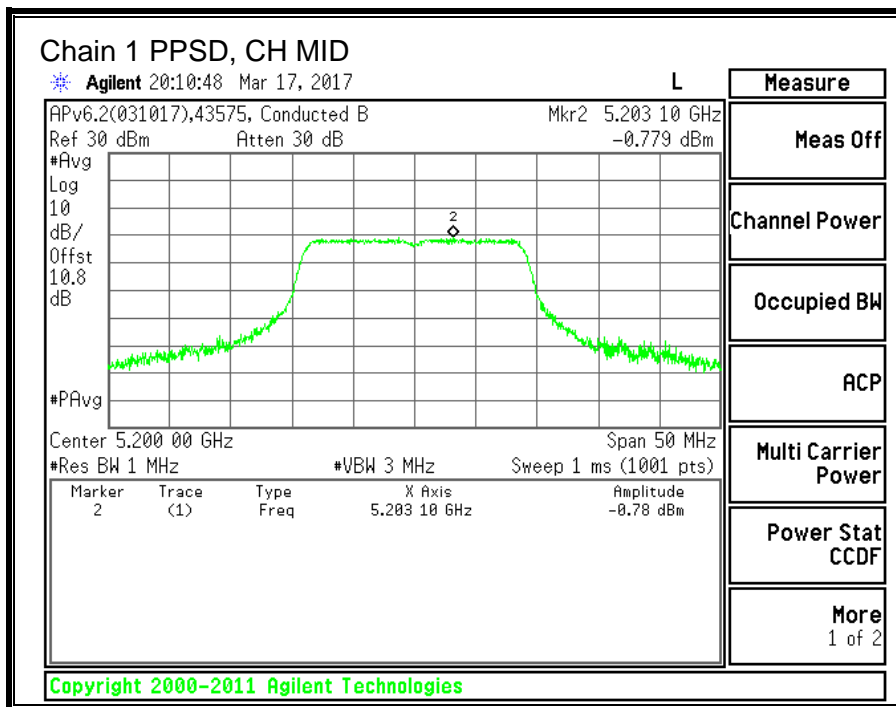
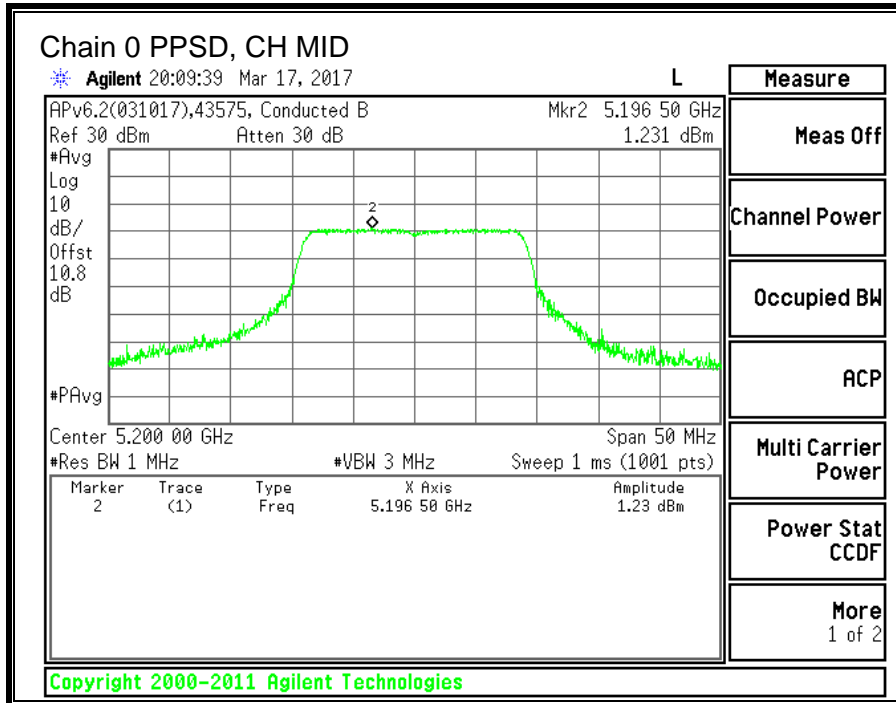

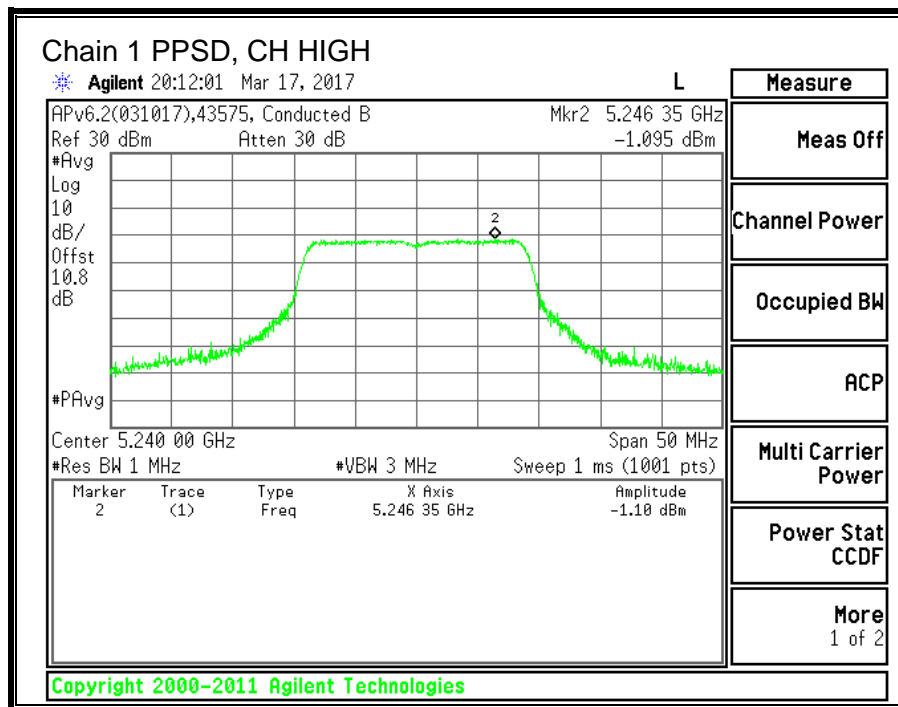
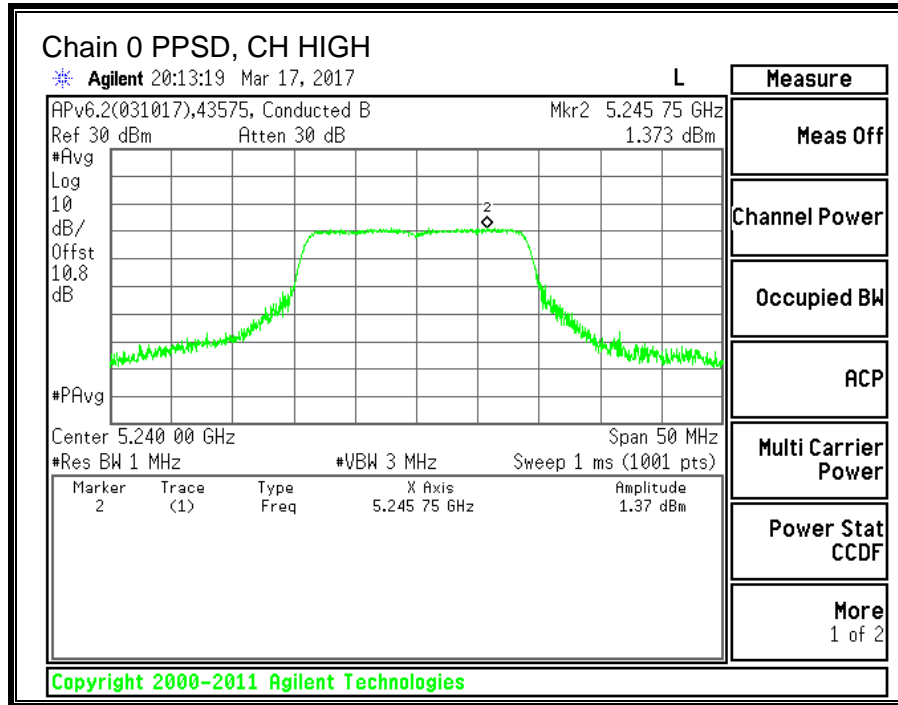

9.3. 11n HT40 2TX CDD MIMO MODE IN THE 5.2GHz BAND

9.3.1. 26 dB BANDWIDTH

LIMITS

None; for reporting purposes only.

RESULTS

Channel	Frequency	26 dB BW Chain 0 (MHz)	26 dB BW Chain 1 (MHz)
Low	5190	43.20	42.80
High	5230	43.50	43.40

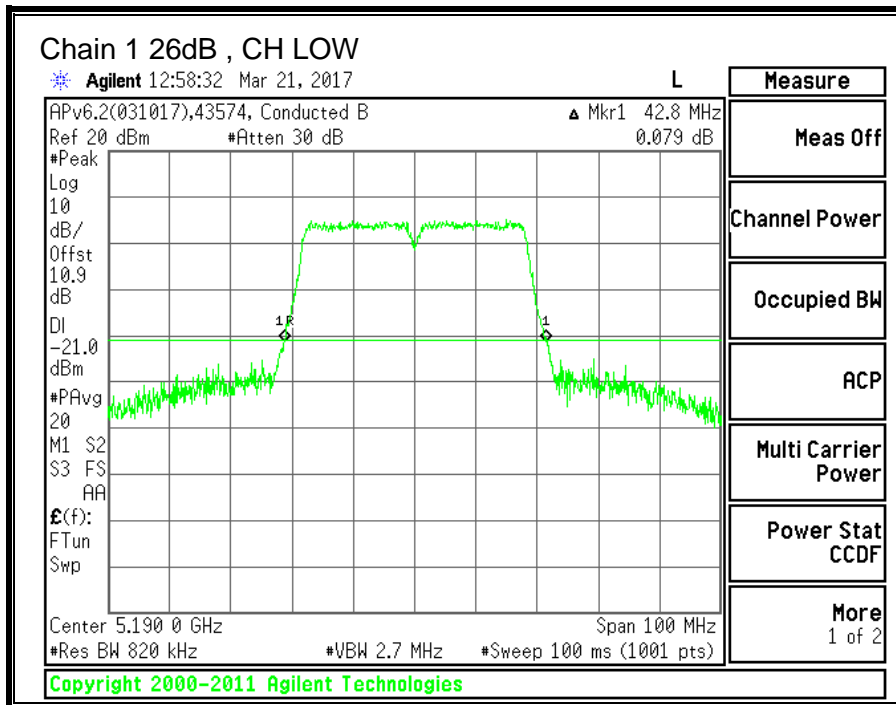
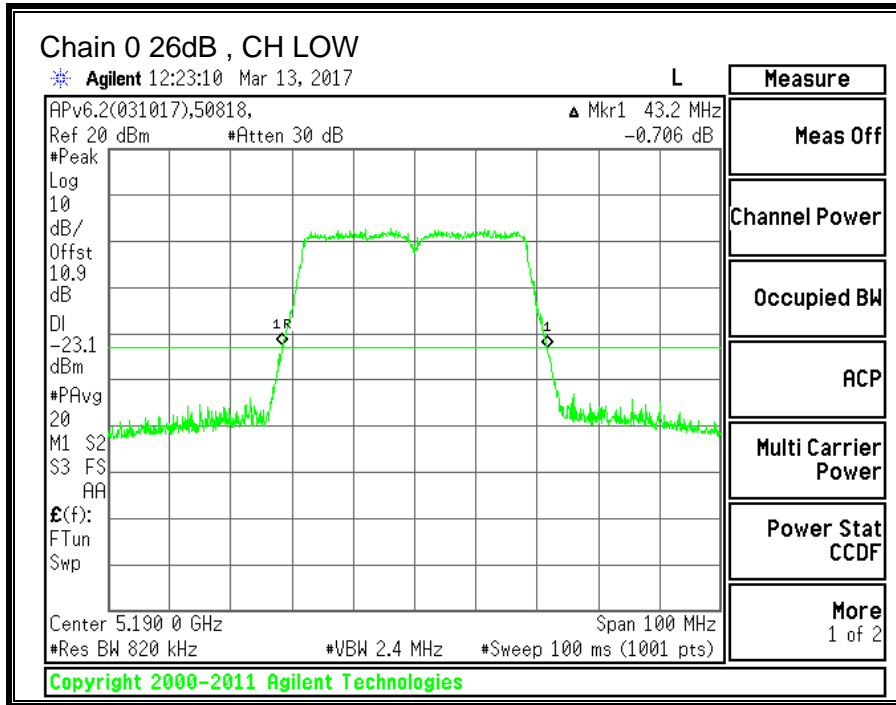

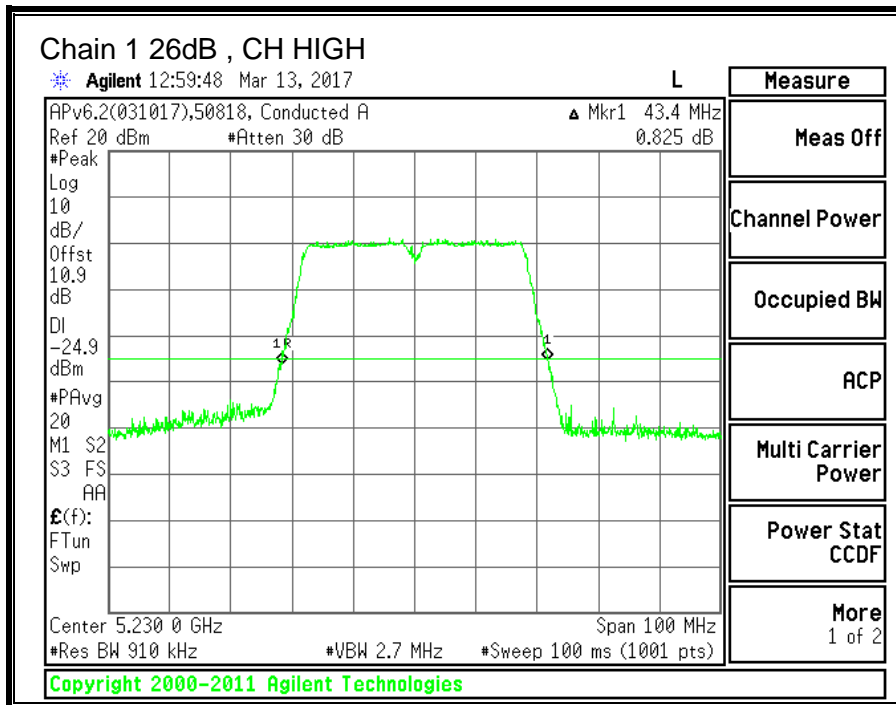
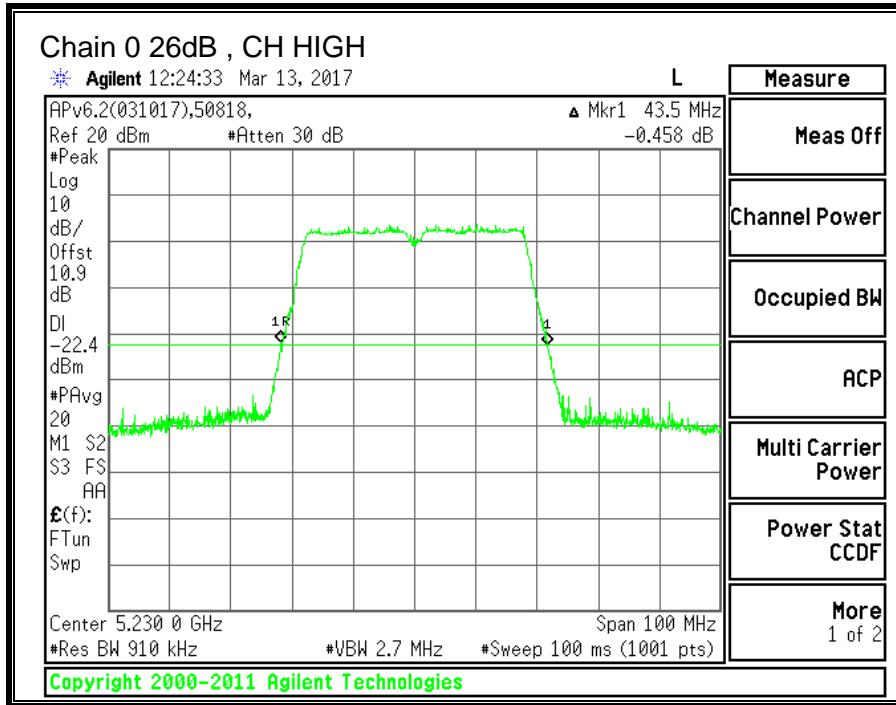

9.3.2. 99% BANDWIDTH

LIMITS

None; for reporting purposes only.

RESULTS

Channel	Frequency	99% BW Chain 0 (MHz)	99% BW Chain 1 (MHz)
Low	5190	36.1643	35.5853
High	5230	36.0942	35.7751

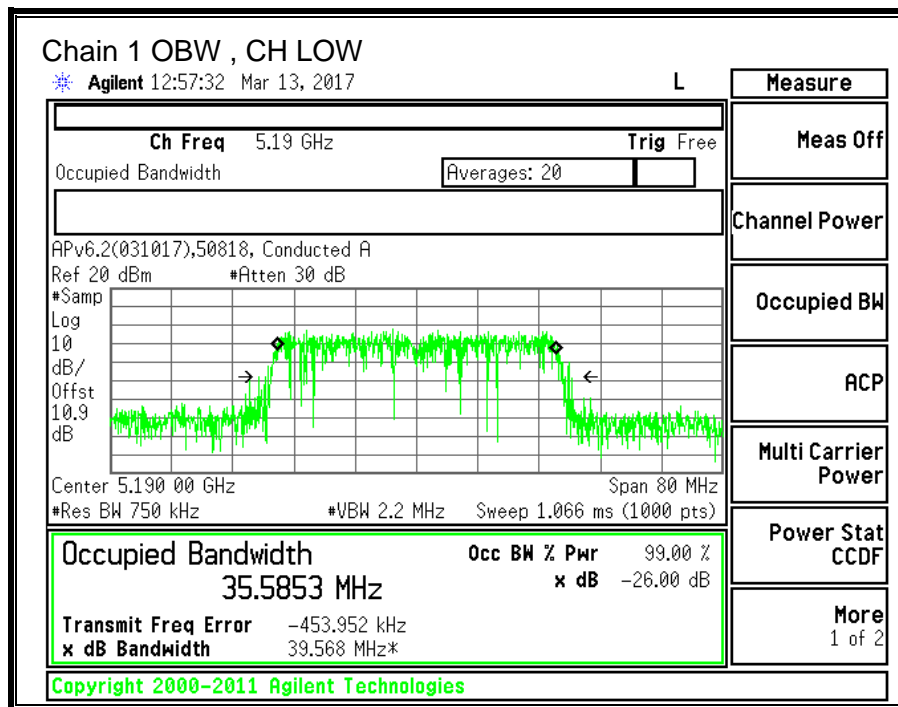
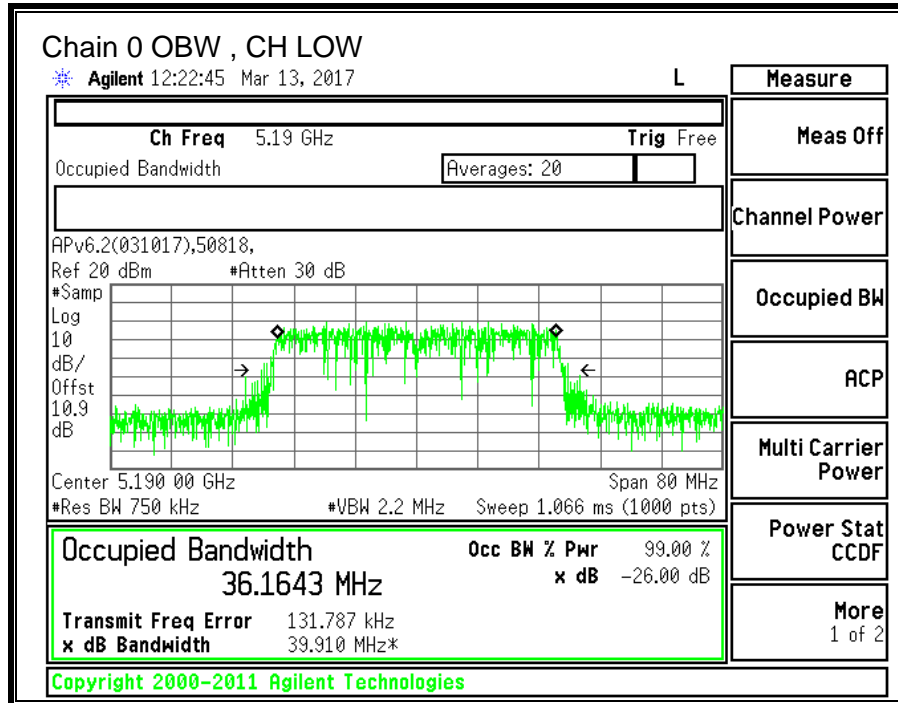

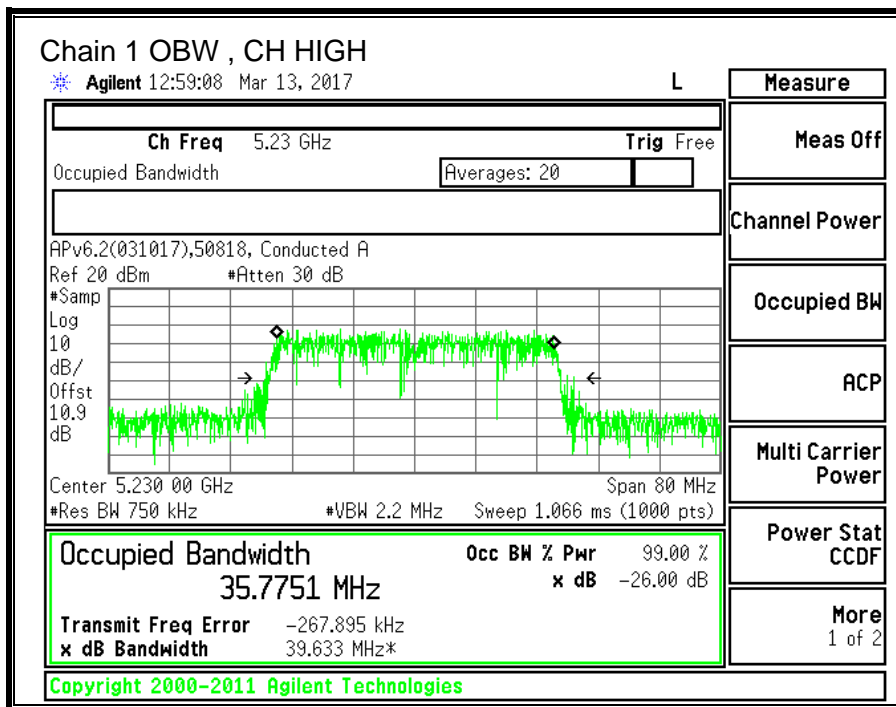
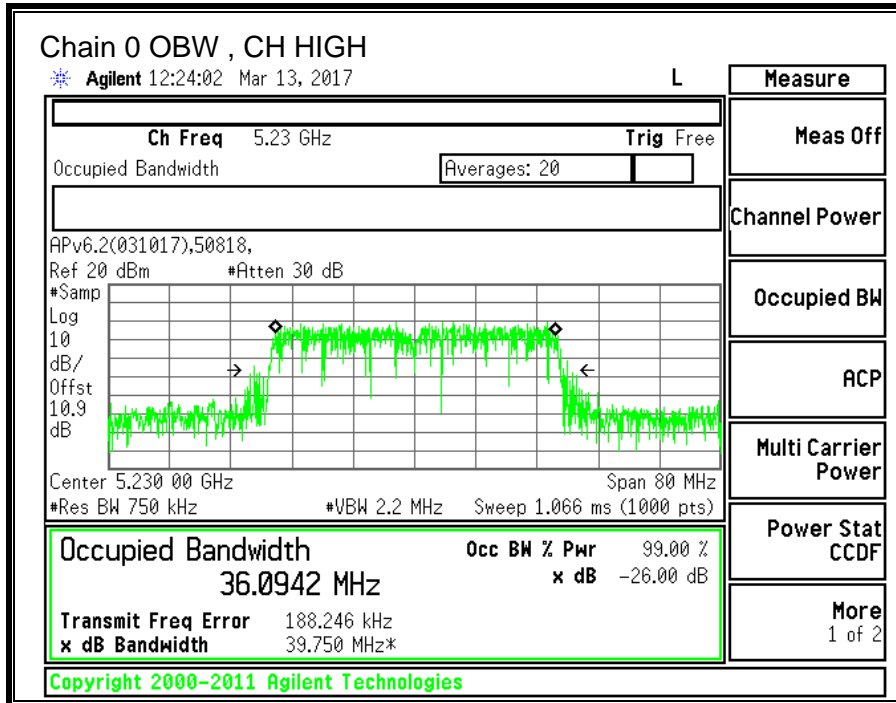

9.3.3. OUTPUT POWER AND PPSD

LIMITS

FCC §15.407 (a) (1)

(i) For an outdoor access point operating in the band 5.15-5.25 GHz, the maximum conducted output power over the frequency band of operation shall not exceed 1 W provided the maximum antenna gain does not exceed 6 dBi. In addition, the maximum power spectral density shall not exceed 17 dBm in any 1 megahertz band. If transmitting antennas of directional gain greater than 6 dBi are used, both the maximum conducted output power and the maximum power spectral density shall be reduced by the amount in dB that the directional gain of the antenna exceeds 6 dBi. The maximum e.i.r.p. at any elevation angle above 30 degrees as measured from the horizon must not exceed 125 mW (21 dBm).

(ii) For an indoor access point operating in the band 5.15-5.25 GHz, the maximum conducted output power over the frequency band of operation shall not exceed 1 W provided the maximum antenna gain does not exceed 6 dBi. In addition, the maximum power spectral density shall not exceed 17 dBm in any 1 megahertz band. If transmitting antennas of directional gain greater than 6 dBi are used, both the maximum conducted output power and the maximum power spectral density shall be reduced by the amount in dB that the directional gain of the antenna exceeds 6 dBi.

(iii) For fixed point-to-point access points operating in the band 5.15-5.25 GHz, the maximum conducted output power over the frequency band of operation shall not exceed 1 W. Fixed point-to-point U-NII devices may employ antennas with directional gain up to 23 dBi without any corresponding reduction in the maximum conducted output power or maximum power spectral density. For fixed point-to-point transmitters that employ a directional antenna gain greater than 23 dBi, a 1 dB reduction in maximum conducted output power and maximum power spectral density is required for each 1 dB of antenna gain in excess of 23 dBi. Fixed, point-to-point operations exclude the use of point-to-multipoint systems, omnidirectional applications, and multiple collocated transmitters transmitting the same information. The operator of the U-NII device, or if the equipment is professionally installed, the installer, is responsible for ensuring that systems employing high gain directional antennas are used exclusively for fixed, point-to-point operations.

(iv) For mobile and portable client devices in the 5.15-5.25 GHz band, the maximum conducted output power over the frequency band of operation shall not exceed 250 mW provided the maximum antenna gain does not exceed 6 dBi. In addition, the maximum power spectral density shall not exceed 11 dBm in any 1 megahertz band. If transmitting antennas of directional gain greater than 6 dBi are used, both the maximum conducted output power and the maximum power spectral density shall be reduced by the amount in dB that the directional gain of the antenna exceeds 6 dBi.

IC RSS-247 (6.2.1) (1)

The maximum EIRP shall not exceed 200 mW or $10 + 10 \log_{10} B$, dBm, whichever power is less. B is the 99% emission bandwidth in MHz. The e.i.r.p. spectral density shall not exceed 10 dBm in any 1.0 MHz band.

TEST PROCEDURE

Measurements perform using a wideband gated RF power meter provided that the gate parameters are adjusted such that the power is measured only when the EUT is transmitting at its maximum power control level. Since the measurement is made only during the ON time of the transmitter, no duty cycle correction factor is required.

DIRECTIONAL ANTENNA GAIN

For power, the TX chains are uncorrelated and the antenna gain is unequal among the chains. The directional gain is:

5150-5250 MHz

Chain 0 Antenna Gain (dBi)	Chain 1 Antenna Gain (dBi)	Uncorrelated Chains Directional Gain (dBi)
-2.40	-0.10	-1.10

For PSD the TX chains are correlated and the antenna gain is unequal among the chains. The directional gain is:

5150-5250 MHz

Chain 0 Antenna Gain (dBi)	Chain 1 Antenna Gain (dBi)	Correlated Chains Directional Gain (dBi)
-2.40	-0.10	1.84

RESULTS

ID:	43578	Date:	3/17/17
------------	-------	--------------	---------

Bandwidth and Antenna Gain

Channel	Frequency (MHz)	Min 26 dB BW (MHz)	Min 99% BW (MHz)	Directional Gain for Power (dBi)	Directional Gain for PPSD (dBi)
Low	5190	42.80	35.585	-1.10	1.84
High	5230	43.40	35.775	-1.10	1.84

Limits

Channel	Frequency (MHz)	FCC Power Limit (dBm)	IC EIRP Limit (dBm)	Max IC Power (dBm)	Power Limit (dBm)	FCC PPSD Limit (dBm)	IC eirp PSD Limit (dBm)	PPSD Limit (dBm)
Low	5190	24.00	23.00	24.10	24.00	11.00	10.00	8.16
High	5230	24.00	23.00	24.10	24.00	11.00	10.00	8.16

Duty Cycle CF (dB)	0.22	Included in Calculations of Corr'd PPSD
---------------------------	------	--

Output Power Results

Channel	Frequency (MHz)	Chain 0 Meas Power (dBm)	Chain 1 Meas Power (dBm)	Total Corr'd Power (dBm)	Power Limit (dBm)	Power Margin (dB)
Low	5190	12.77	10.24	14.70	24.00	-9.30
High	5230	12.90	10.37	14.83	24.00	-9.17

PPSD Results

Channel	Frequency (MHz)	Chain 0 Meas PPSD (dBm)	Chain 1 Meas PPSD (dBm)	Total Corr'd PPSD (dBm)	PPSD Limit (dBm)	PPSD Margin (dB)
Low	5190	-1.807	-4.019	0.46	8.16	-7.70
High	5230	-1.660	-3.837	0.62	8.16	-7.54

Note: the power readings above were measured with gated method, and the measurement was taken only during the ON time. No duty cycle correction was necessary.

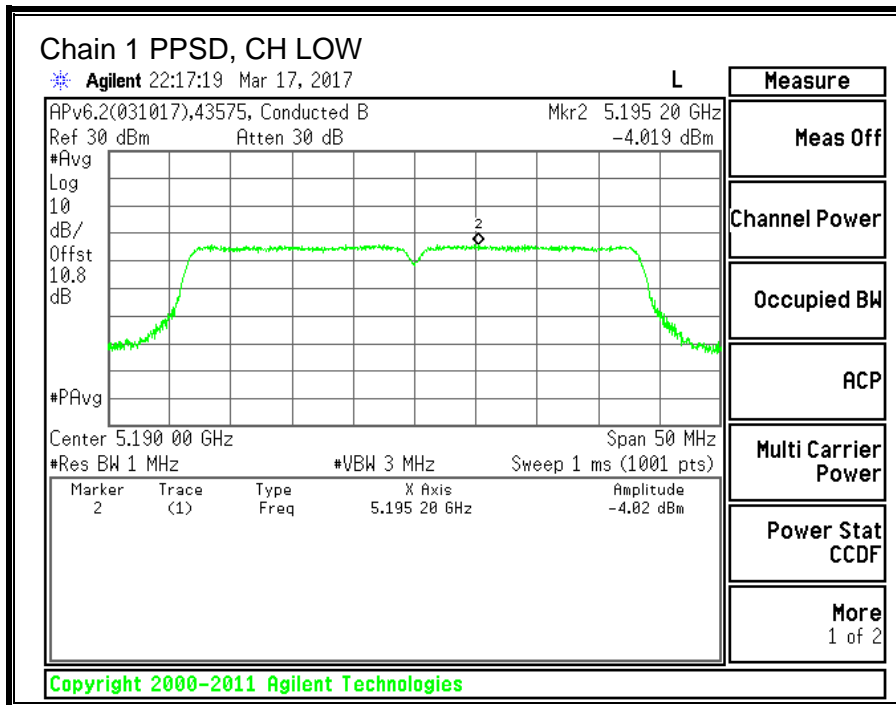
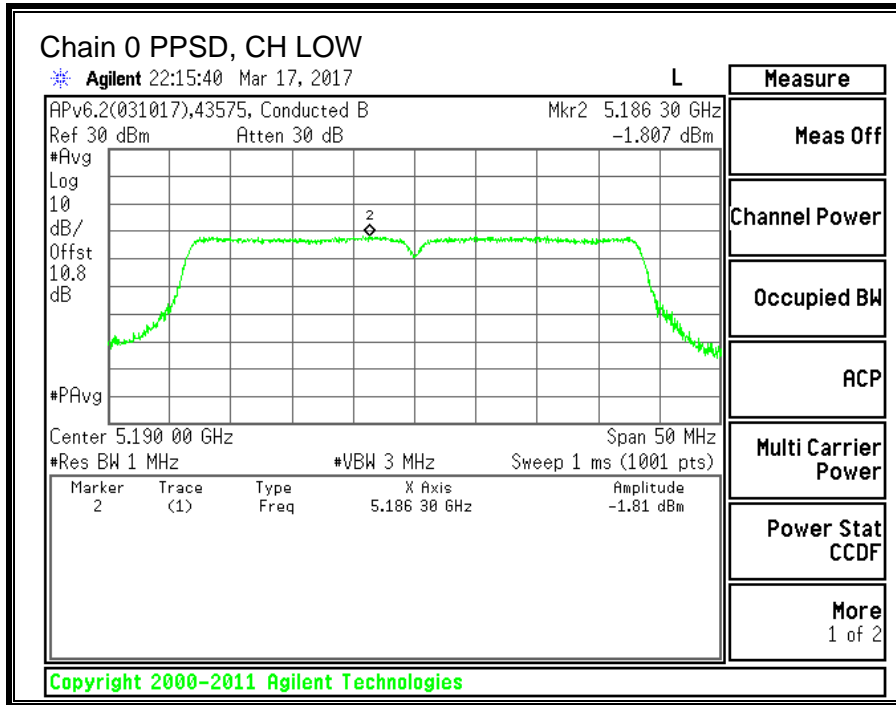

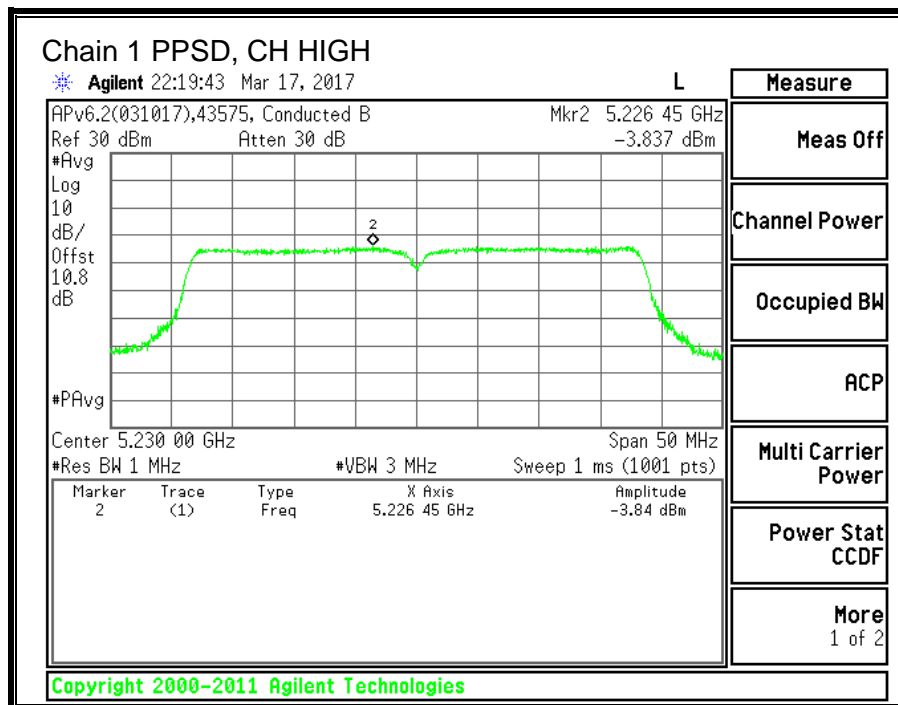
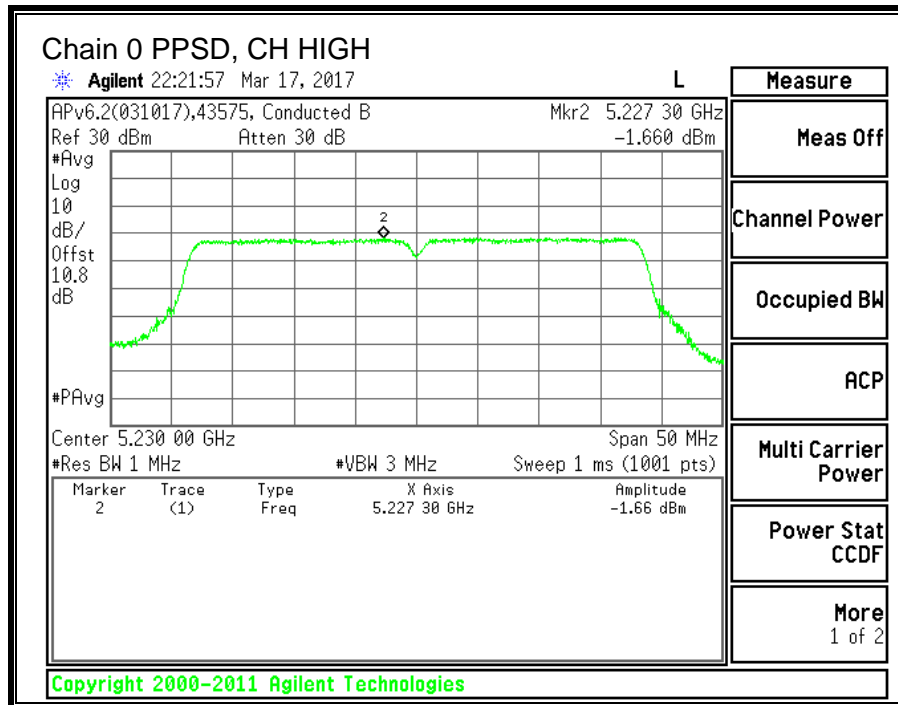

9.4. 11ac HT80 2TX CDD MIMO MODE IN THE 5.2GHz BAND

9.4.1. 26 dB BANDWIDTH

LIMITS

None; for reporting purposes only.

RESULTS

Channel	Frequency	26 dB BW Chain 0 (MHz)	26 dB BW Chain 1 (MHz)
Mid	5210	86.40	87.00

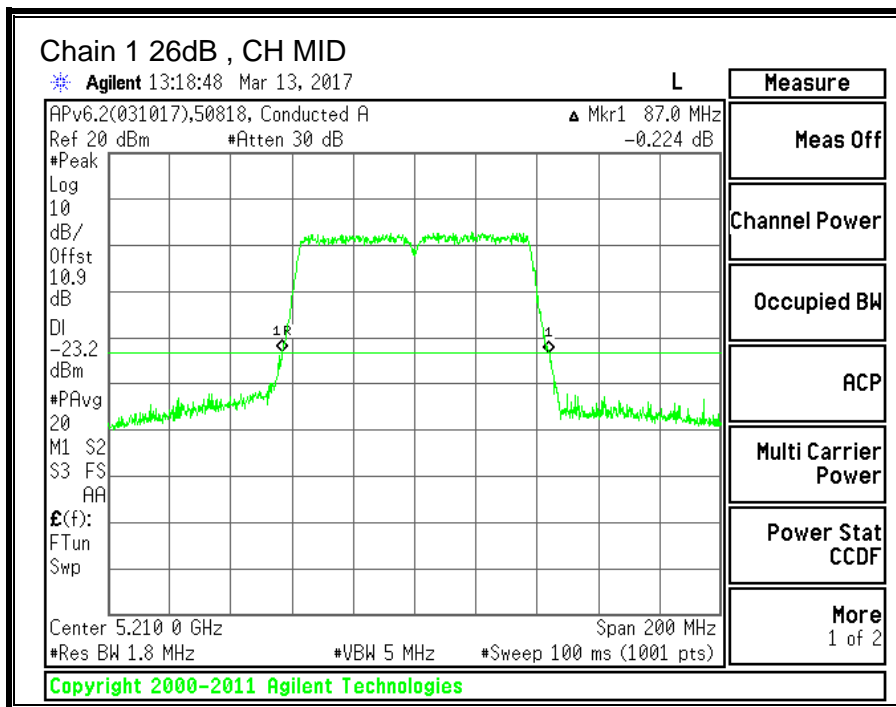
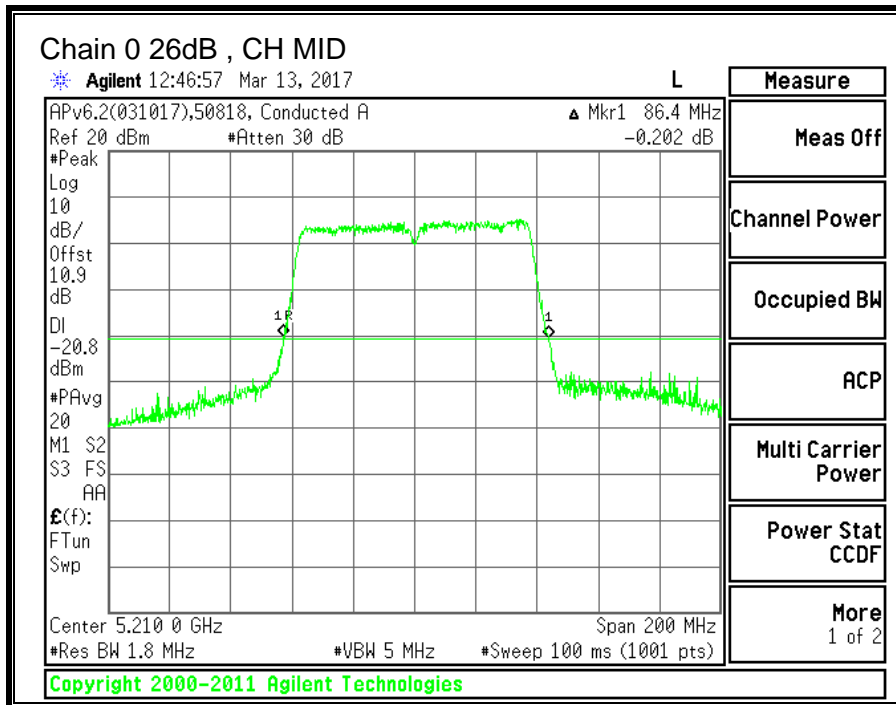

9.4.2. 99% BANDWIDTH

LIMITS

None; for reporting purposes only.

RESULTS

Channel	Frequency	99% BW Chain 0 (MHz)	99% BW Chain 1 (MHz)
Mid	5210	76.0518	74.5846

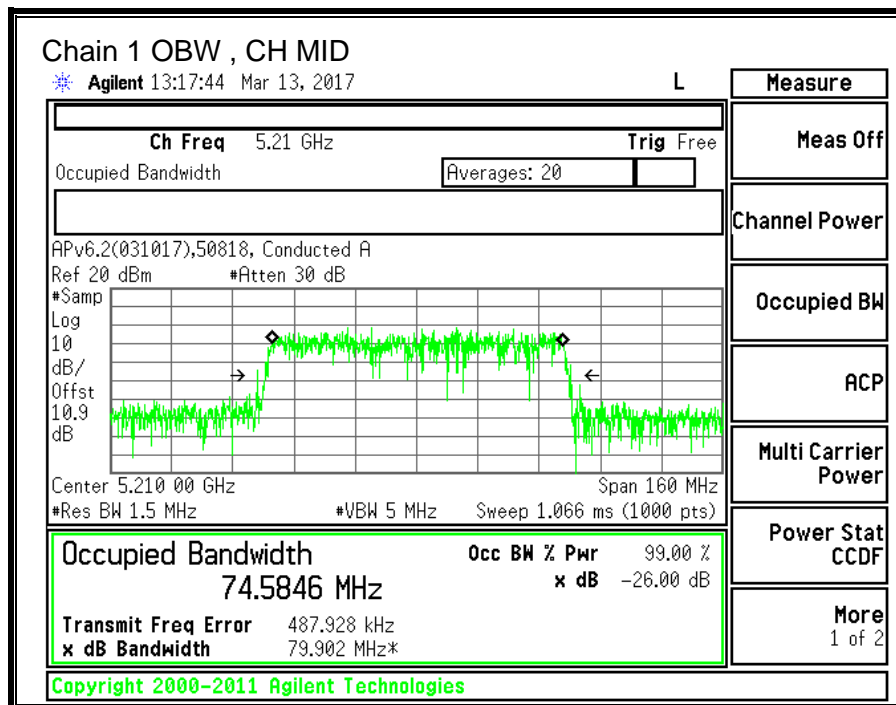
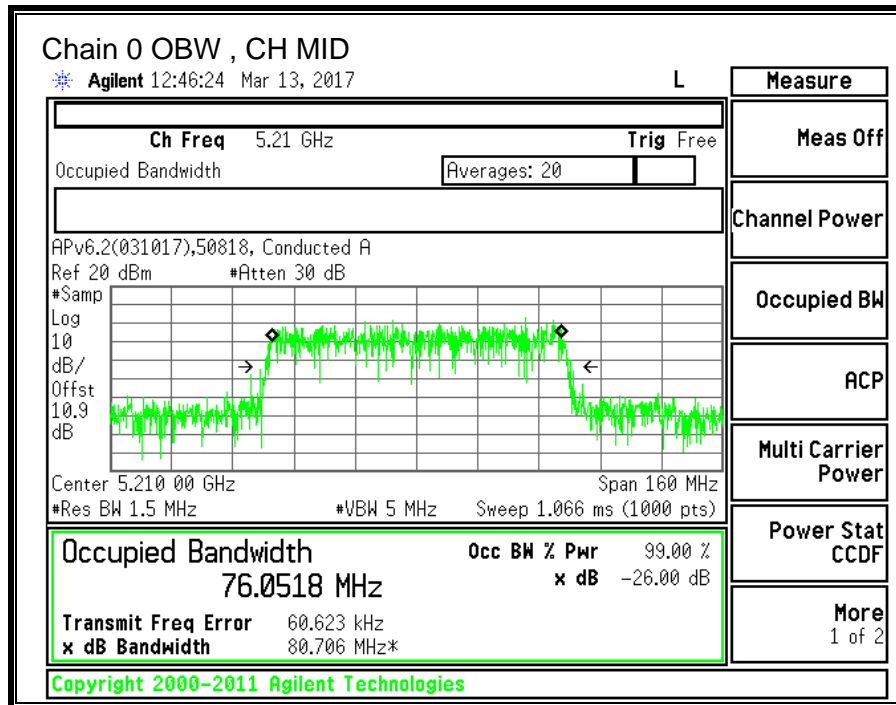

9.4.3. OUTPUT POWER AND PPSD

LIMITS

FCC §15.407 (a) (1)

(i) For an outdoor access point operating in the band 5.15-5.25 GHz, the maximum conducted output power over the frequency band of operation shall not exceed 1 W provided the maximum antenna gain does not exceed 6 dBi. In addition, the maximum power spectral density shall not exceed 17 dBm in any 1 megahertz band. If transmitting antennas of directional gain greater than 6 dBi are used, both the maximum conducted output power and the maximum power spectral density shall be reduced by the amount in dB that the directional gain of the antenna exceeds 6 dBi. The maximum e.i.r.p. at any elevation angle above 30 degrees as measured from the horizon must not exceed 125 mW (21 dBm).

(ii) For an indoor access point operating in the band 5.15-5.25 GHz, the maximum conducted output power over the frequency band of operation shall not exceed 1 W provided the maximum antenna gain does not exceed 6 dBi. In addition, the maximum power spectral density shall not exceed 17 dBm in any 1 megahertz band. If transmitting antennas of directional gain greater than 6 dBi are used, both the maximum conducted output power and the maximum power spectral density shall be reduced by the amount in dB that the directional gain of the antenna exceeds 6 dBi.

(iii) For fixed point-to-point access points operating in the band 5.15-5.25 GHz, the maximum conducted output power over the frequency band of operation shall not exceed 1 W. Fixed point-to-point U-NII devices may employ antennas with directional gain up to 23 dBi without any corresponding reduction in the maximum conducted output power or maximum power spectral density. For fixed point-to-point transmitters that employ a directional antenna gain greater than 23 dBi, a 1 dB reduction in maximum conducted output power and maximum power spectral density is required for each 1 dB of antenna gain in excess of 23 dBi. Fixed, point-to-point operations exclude the use of point-to-multipoint systems, omnidirectional applications, and multiple collocated transmitters transmitting the same information. The operator of the U-NII device, or if the equipment is professionally installed, the installer, is responsible for ensuring that systems employing high gain directional antennas are used exclusively for fixed, point-to-point operations.

(iv) For mobile and portable client devices in the 5.15-5.25 GHz band, the maximum conducted output power over the frequency band of operation shall not exceed 250 mW provided the maximum antenna gain does not exceed 6 dBi. In addition, the maximum power spectral density shall not exceed 11 dBm in any 1 megahertz band. If transmitting antennas of directional gain greater than 6 dBi are used, both the maximum conducted output power and the maximum power spectral density shall be reduced by the amount in dB that the directional gain of the antenna exceeds 6 dBi.

IC RSS-247 (6.2.1) (1)

The maximum EIRP shall not exceed 200 mW or $10 + 10 \log_{10} B$, dBm, whichever power is less. B is the 99% emission bandwidth in MHz. The e.i.r.p. spectral density shall not exceed 10 dBm in any 1.0 MHz band.

TEST PROCEDURE

Measurements perform using a wideband gated RF power meter provided that the gate parameters are adjusted such that the power is measured only when the EUT is transmitting at its maximum power control level. Since the measurement is made only during the ON time of the transmitter, no duty cycle correction factor is required.

DIRECTIONAL ANTENNA GAIN

For power, the TX chains are uncorrelated and the antenna gain is unequal among the chains. The directional gain is:

5150-5250 MHz

Chain 0 Antenna Gain (dBi)	Chain 1 Antenna Gain (dBi)	Uncorrelated Chains Directional Gain (dBi)
-2.40	-0.10	-1.10

For PSD the TX chains are correlated and the antenna gain is unequal among the chains. The directional gain is:

5150-5250 MHz

Chain 0 Antenna Gain (dBi)	Chain 1 Antenna Gain (dBi)	Correlated Chains Directional Gain (dBi)
-2.40	-0.10	1.84

RESULTS

ID:	43578	Date:	3/17/17
------------	-------	--------------	---------

Bandwidth and Antenna Gain

Channel	Frequency (MHz)	Min 26 dB BW (MHz)	Min 99% BW (MHz)	Directional Gain for Power (dBi)	Directional Gain for PPSD (dBi)
Low	5210	86.40	74.585	-1.10	1.84

Limits

Channel	Frequency (MHz)	FCC Power Limit (dBm)	IC EIRP Limit (dBm)	Max IC Power (dBm)	Power Limit (dBm)	FCC PPSD Limit (dBm)	IC eirp PSD Limit (dBm)	PPSD Limit (dBm)
Low	5210	24.00	23.00	24.10	24.00	11.00	10.00	8.16

Duty Cycle CF (dB)	0.42	Included in Calculations of Corr'd PPSD
---------------------------	------	--

Output Power Results

Channel	Frequency (MHz)	Chain 0 Meas Power (dBm)	Chain 1 Meas Power (dBm)	Total Corr'd Power (dBm)	Power Limit (dBm)	Power Margin (dB)
Low	5210	12.72	10.43	14.73	24.00	-9.27

PPSD Results

Channel	Frequency (MHz)	Chain 0 Meas PPSD (dBm)	Chain 1 Meas PPSD (dBm)	Total Corr'd PPSD (dBm)	PPSD Limit (dBm)	PPSD Margin (dB)
Low	5210	-5.843	-8.143	-3.41	8.16	-11.57

Note: the power readings above were measured with gated method, and the measurement was taken only during the ON time. No duty cycle correction was necessary.

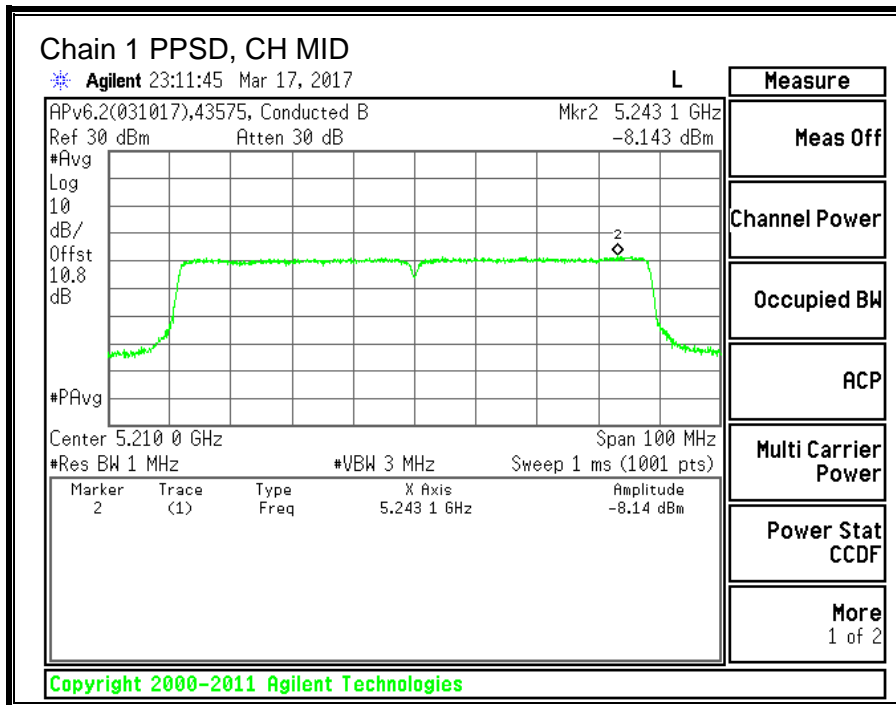
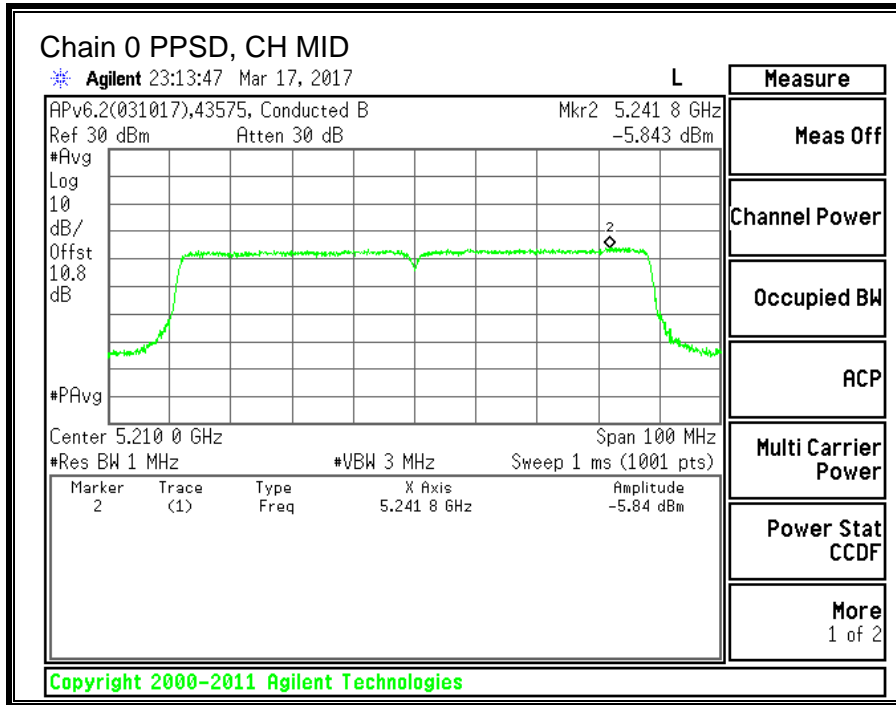

9.5. 11a 2TX CDD MIMO MODE IN THE 5.3GHz BAND

9.5.1. 26 dB BANDWIDTH

LIMITS

None; for reporting purposes only.

RESULTS

Channel	Frequency	26 dB BW Chain 0 (MHz)	26 dB BW Chain 1 (MHz)
Low	5260	23.55	22.20
Mid	5300	23.95	23.50
High	5320	23.75	23.35

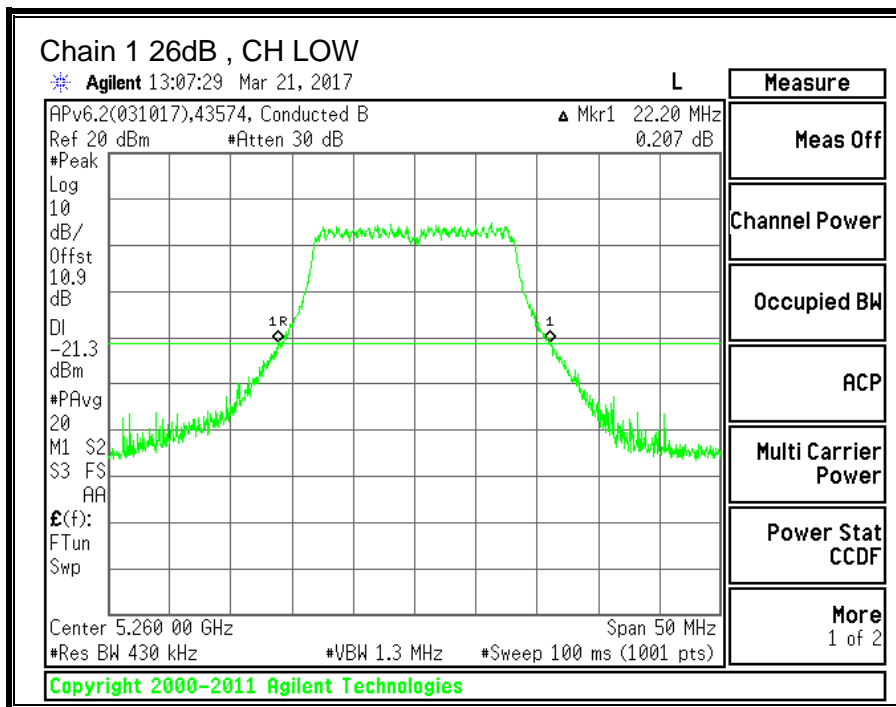
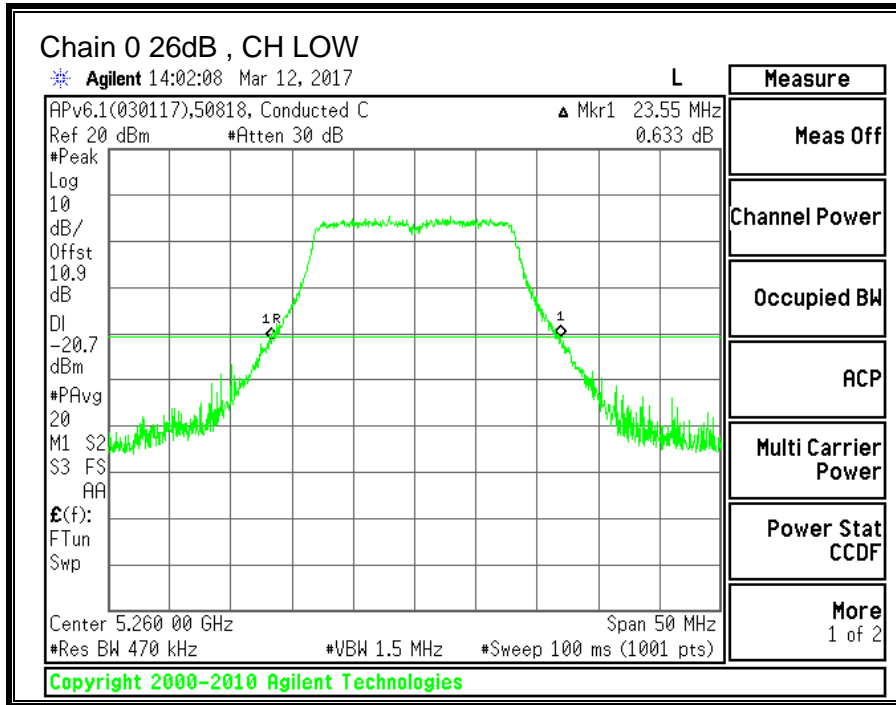

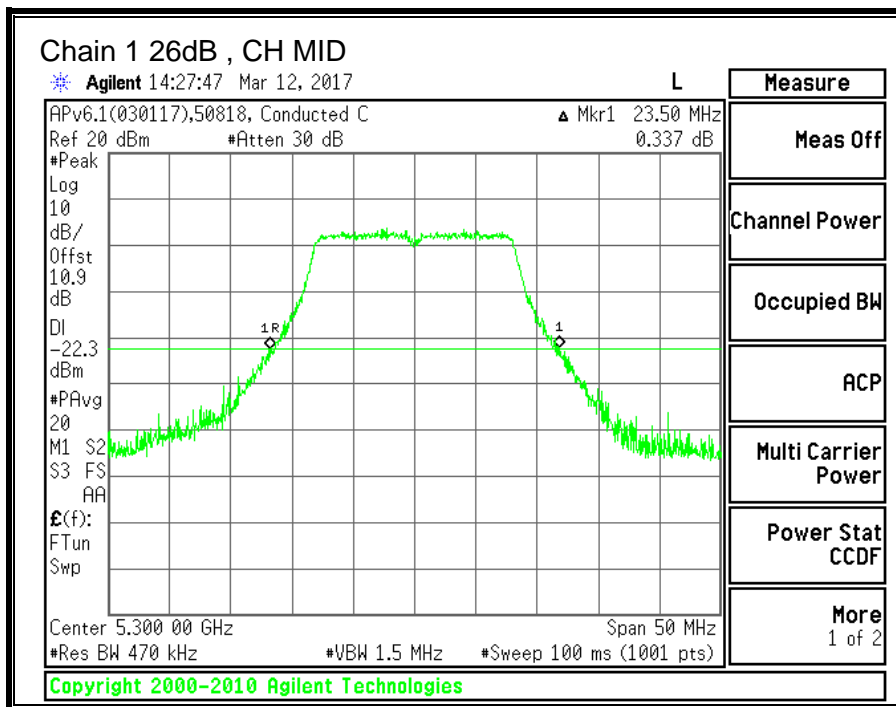
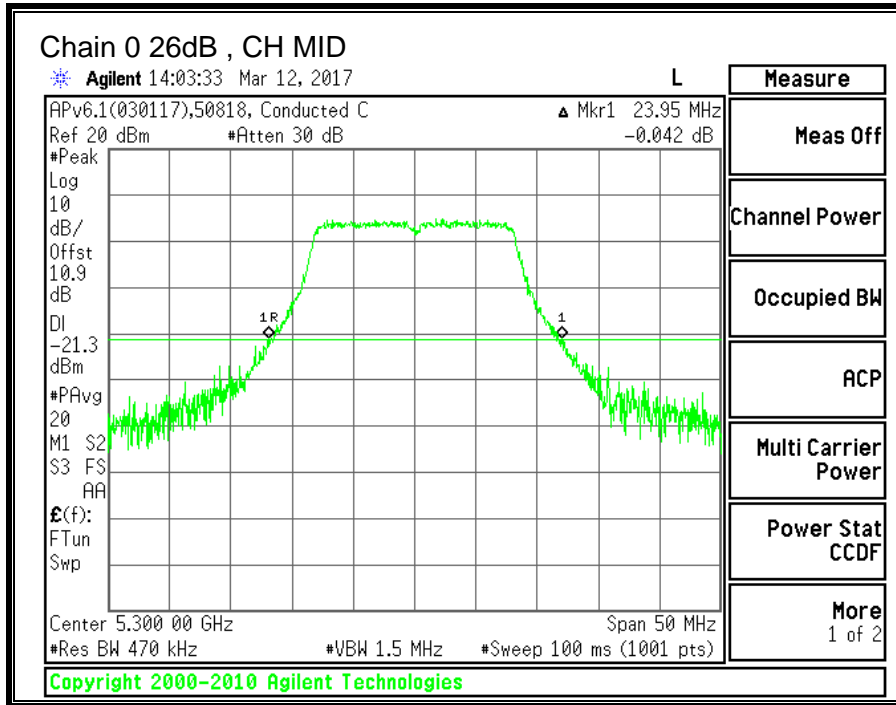

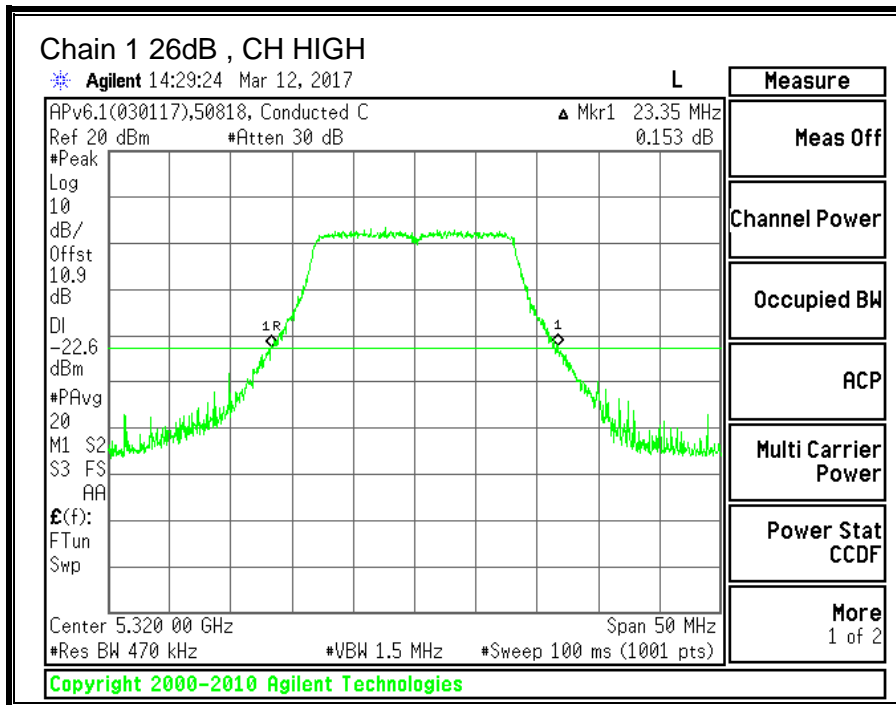
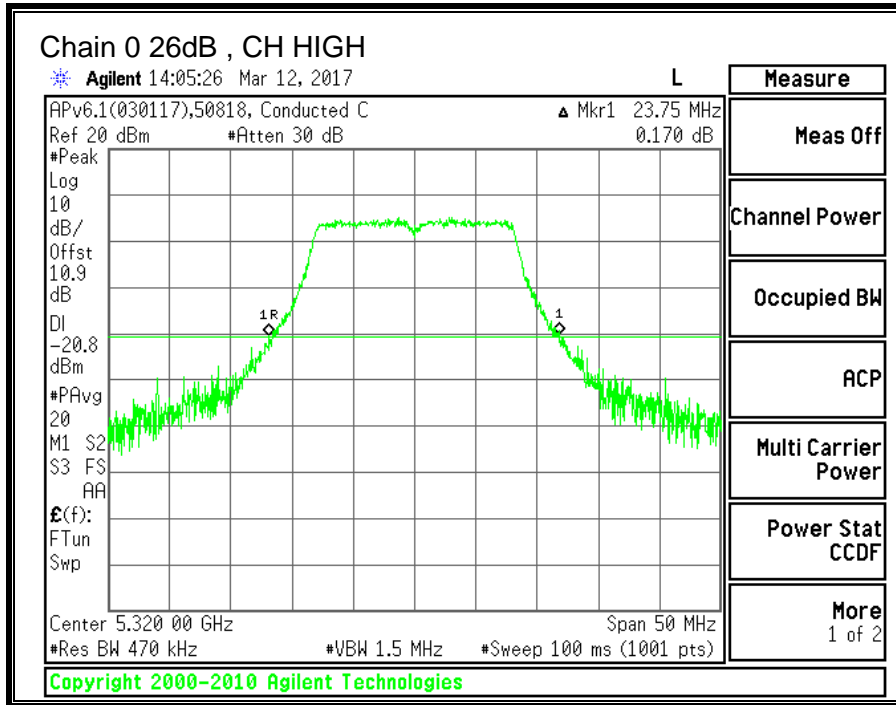

9.5.2. 99% BANDWIDTH

LIMITS

None; for reporting purposes only.

RESULTS

Channel	Frequency	99% BW Chain 0 (MHz)	99% BW Chain 1 (MHz)
Low	5260	16.4565	16.2228
Mid	5300	16.2833	16.3104
High	5320	16.3315	16.4074

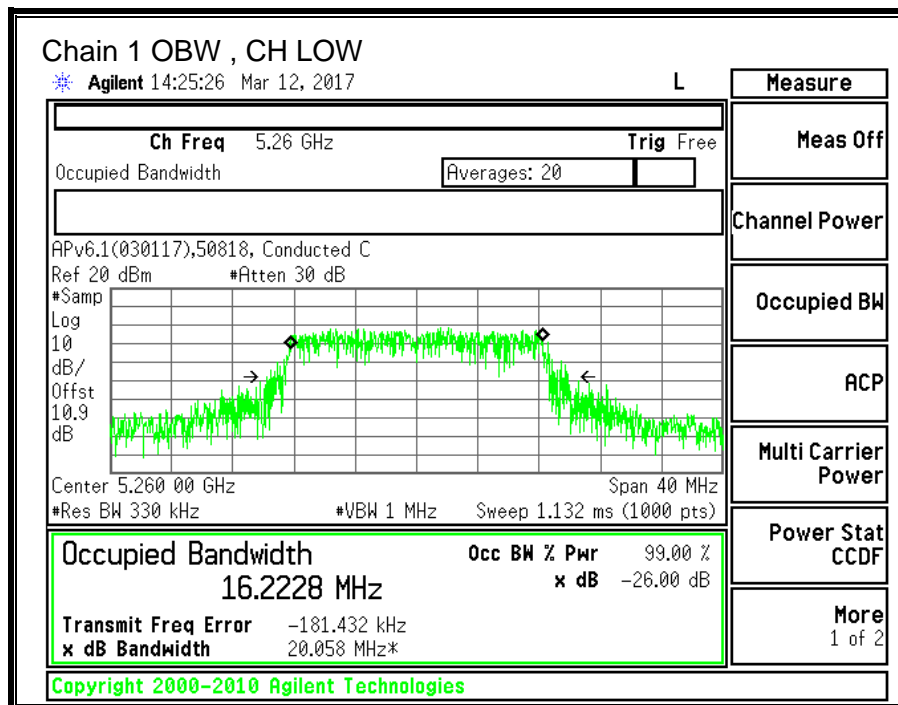
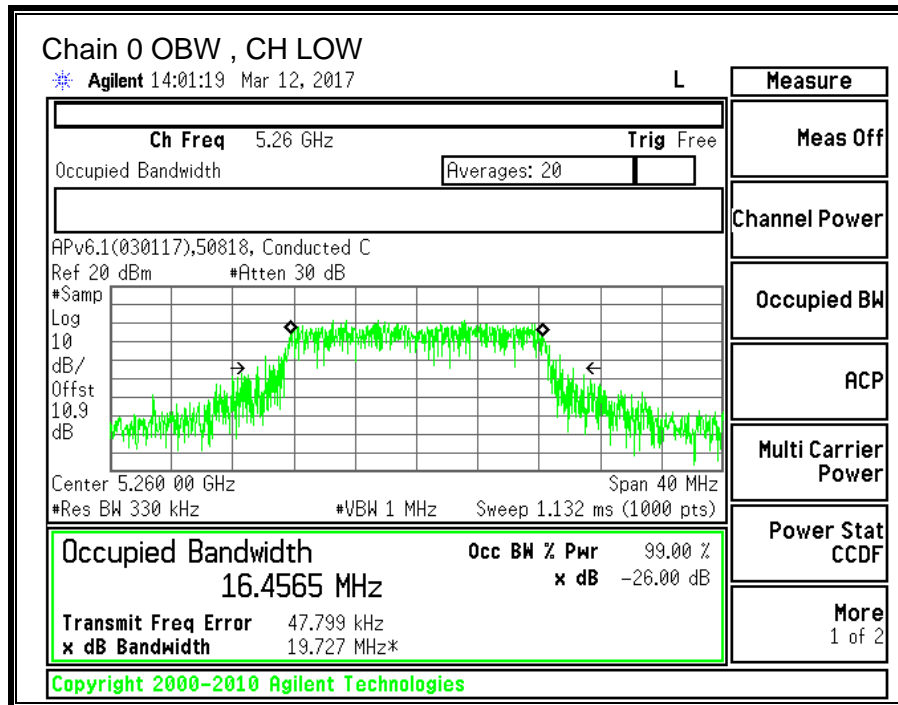

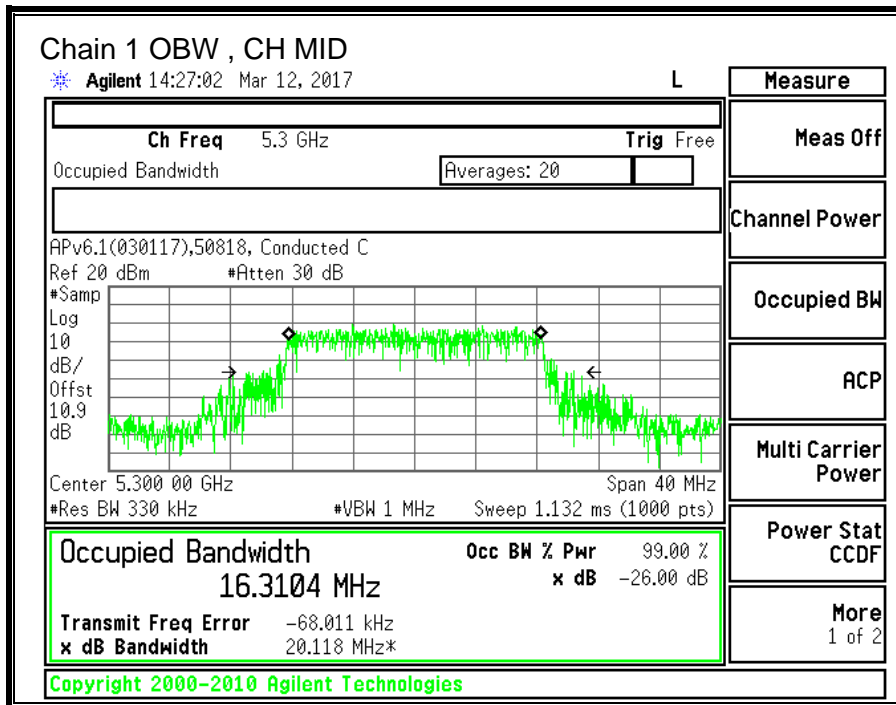
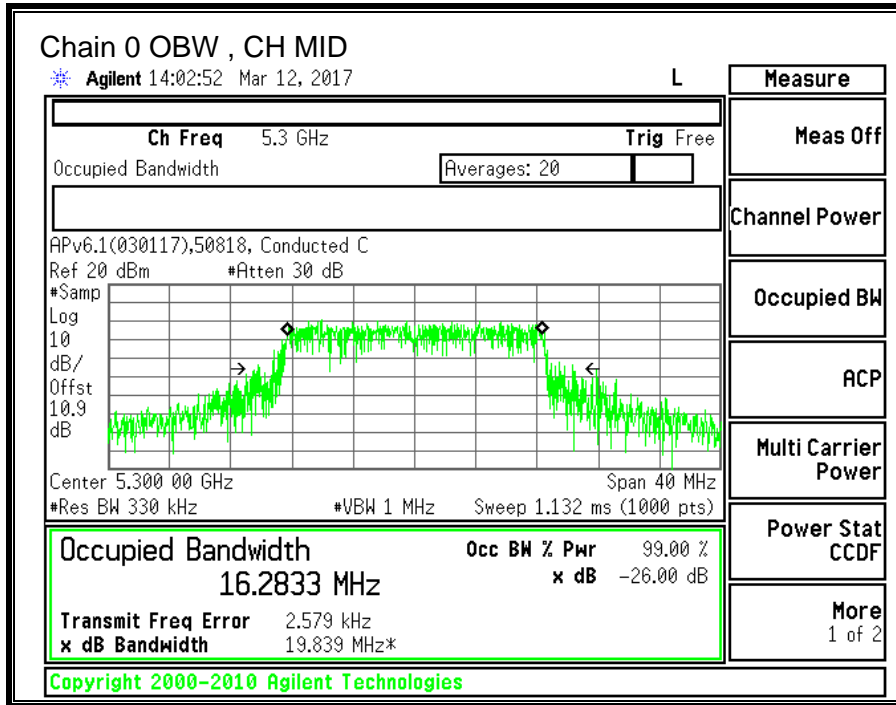

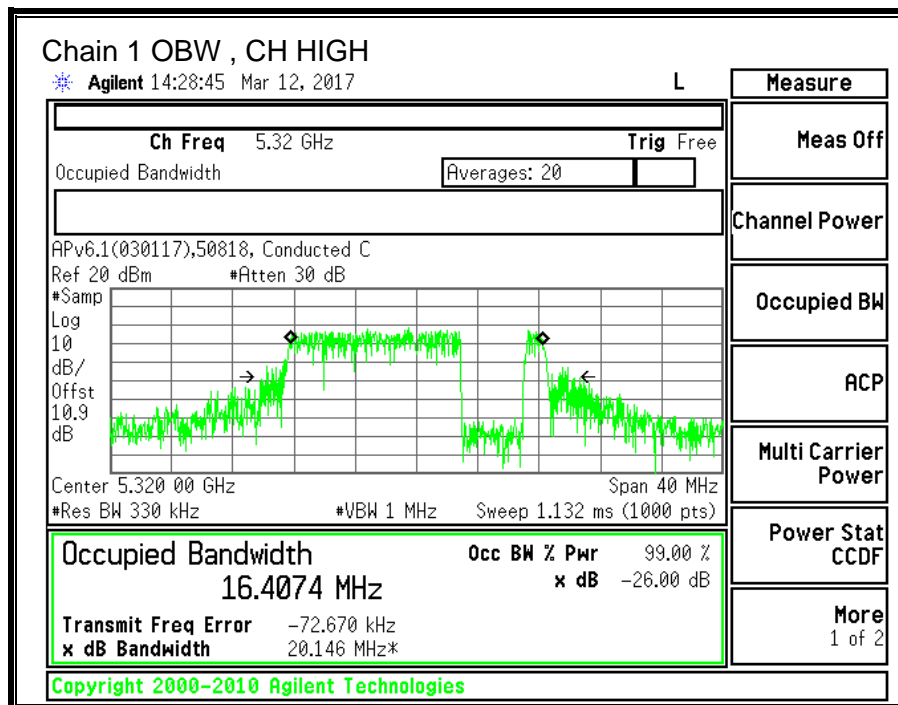
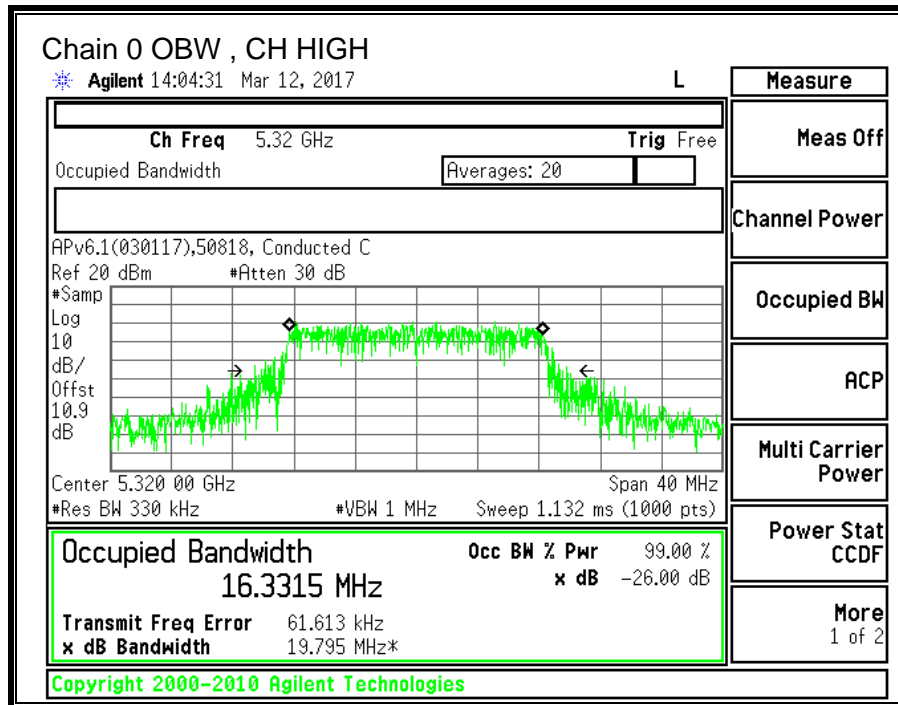

9.5.3. OUTPUT POWER AND PPSD

LIMITS

FCC §15.407 (a) (2)

For the band 5.25–5.35 GHz, the maximum conducted output power over the frequency band of operation shall not exceed the lesser of 250 mW or $11 \text{ dBm} + 10 \log B$, where B is the 26–dB emission bandwidth in MHz. In addition, the maximum power spectral density shall not exceed 11 dBm in any 1–MHz band. If transmitting antennas of directional gain greater than 6 dBi are used, both the maximum conducted output power and the peak power spectral density shall be reduced by the amount in dB that the directional gain of the antenna exceeds 6 dBi.

IC RSS-247 (6.2.2) (1)

The maximum conducted output power shall not exceed 250 mW or $11 + 10 \log_{10} B$, dBm, whichever is less. The power spectral density shall not exceed 11 dBm in any 1.0 MHz band.

The maximum e.i.r.p. shall not exceed 1.0 W or $17 + 10 \log_{10} B$, dBm, whichever is less. B is the 99% emission bandwidth in megahertz. Note that devices with a maximum e.i.r.p. greater than 500 mW shall implement TPC in order to have the capability to operate at least 6 dB below the maximum permitted e.i.r.p. of 1 W.

TEST PROCEDURE

Measurements perform using a wideband gated RF power meter provided that the gate parameters are adjusted such that the power is measured only when the EUT is transmitting at its maximum power control level. Since the measurement is made only during the ON time of the transmitter, no duty cycle correction factor is required.

DIRECTIONAL ANTENNA GAIN

For power, the TX chains are uncorrelated and the antenna gain is unequal among the chains. The directional gain is:

5250-5350 MHz

Chain 0 Antenna Gain (dBi)	Chain 1 Antenna Gain (dBi)	Uncorrelated Chains Directional Gain (dBi)
-2.40	-0.10	-1.10

For PSD the TX chains are correlated and the antenna gain is unequal among the chains. The directional gain is:

5250-5350 MHz

Chain 0 Antenna Gain (dBi)	Chain 1 Antenna Gain (dBi)	Correlated Chains Directional Gain (dBi)
-2.40	-0.10	1.84

RESULTS

ID:	43578	Date:	3/17/17
------------	-------	--------------	---------

Bandwidth and Antenna Gain

Channel	Frequency (MHz)	Min 26 dB BW (MHz)	Min 99% BW (MHz)	Directional Gain for Power (dBi)	Directional Gain for PPSD (dBi)
Low	5260	22.20	16.223	-1.10	1.84
Mid	5300	23.50	16.283	-1.10	1.84
High	5320	23.35	16.332	-1.10	1.84

Limits

Channel	Frequency (MHz)	FCC Power Limit (dBm)	IC Power Limit (dBm)	IC EIRP Limit (dBm)	Power Limit (dBm)	FCC PPSD Limit (dBm)	IC PSD Limit (dBm)	PPSD Limit (dBm)
Low	5260	24.00	23.10	29.10	23.10	11.00	11.00	11.00
Mid	5300	24.00	23.12	29.12	23.12	11.00	11.00	11.00
High	5320	24.00	23.13	29.13	23.13	11.00	11.00	11.00

Duty Cycle CF (dB)	0.24	Included in Calculations of Corr'd PPSD
---------------------------	------	--

Output Power Results

Channel	Frequency (MHz)	Chain 0 Meas Power (dBm)	Chain 1 Meas Power (dBm)	Total Corr'd Power (dBm)	Power Limit (dBm)	Power Margin (dB)
Low	5260	12.77	10.15	14.66	23.10	-8.44
Mid	5300	12.91	10.41	14.85	23.12	-8.27
High	5320	12.75	10.32	14.71	23.13	-8.42

PPSD Results

Channel	Frequency (MHz)	Chain 0 Meas PPSD (dBm)	Chain 1 Meas PPSD (dBm)	Total Corr'd PPSD (dBm)	PPSD Limit (dBm)	PPSD Margin (dB)
Low	5260	1.483	-0.920	3.70	11.00	-7.30
Mid	5300	1.854	-0.611	4.04	11.00	-6.96
High	5320	1.584	-0.827	3.79	11.00	-7.21

Note: the power readings above were measured with gated method, and the measurement was taken only during the ON time. No duty cycle correction was necessary.

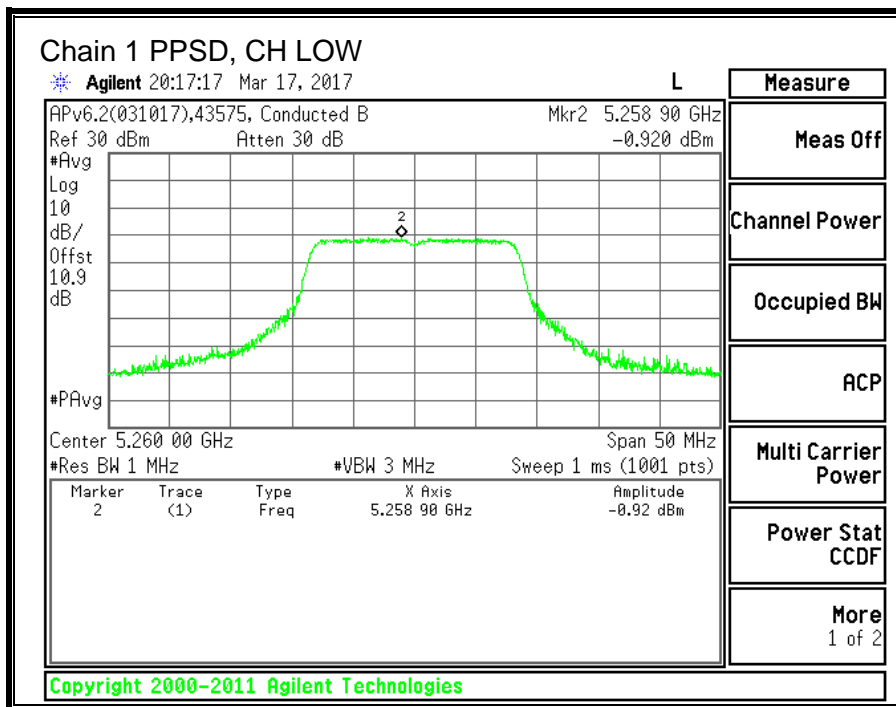
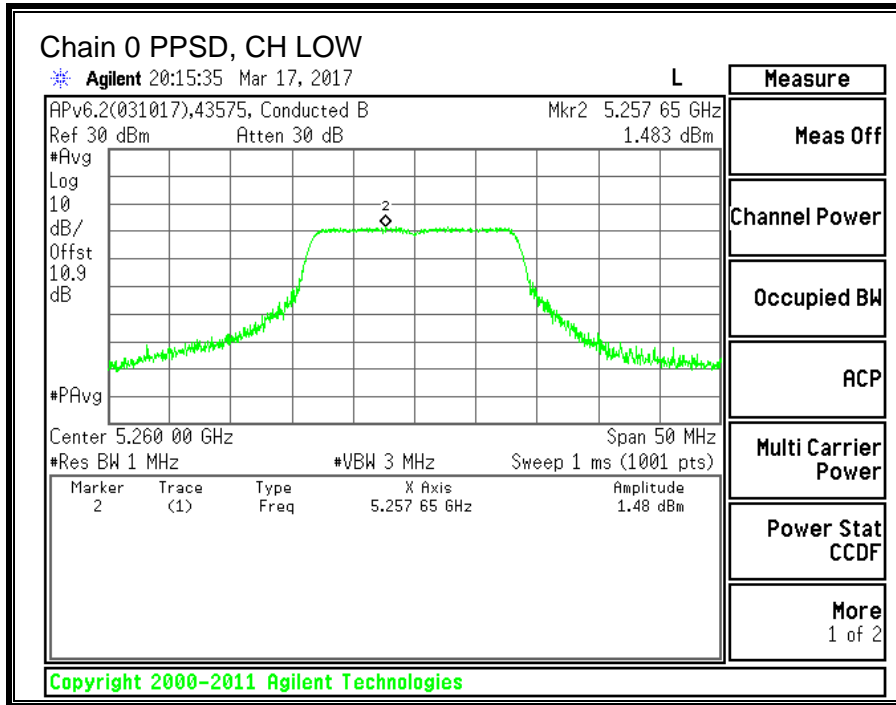

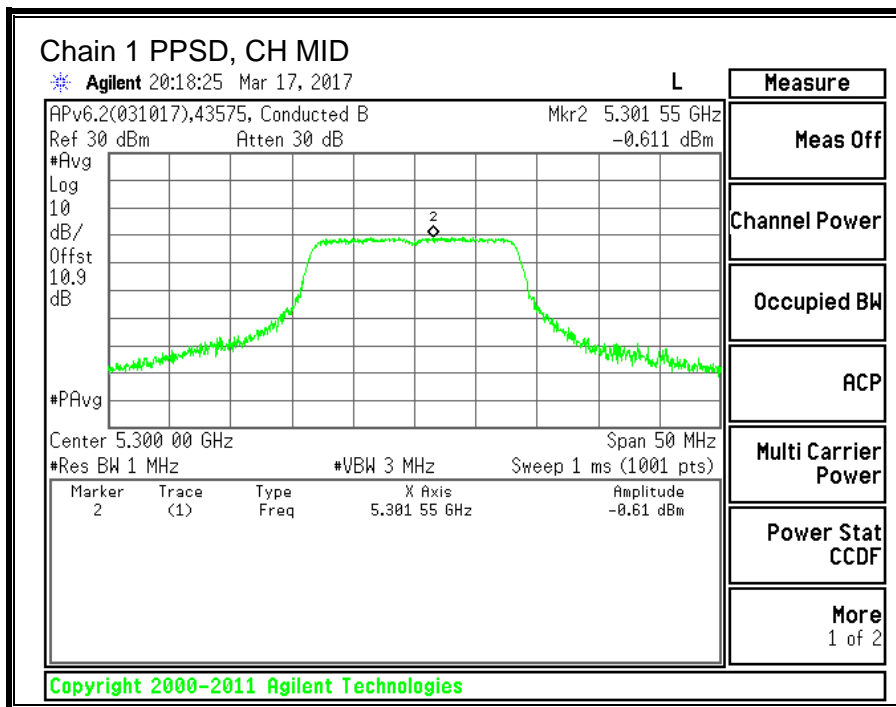
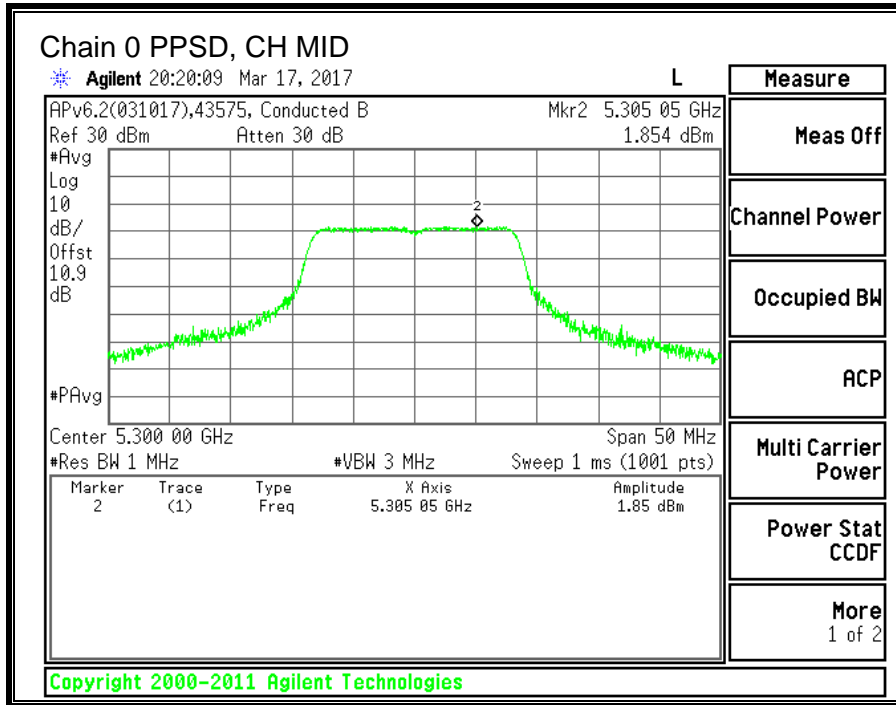

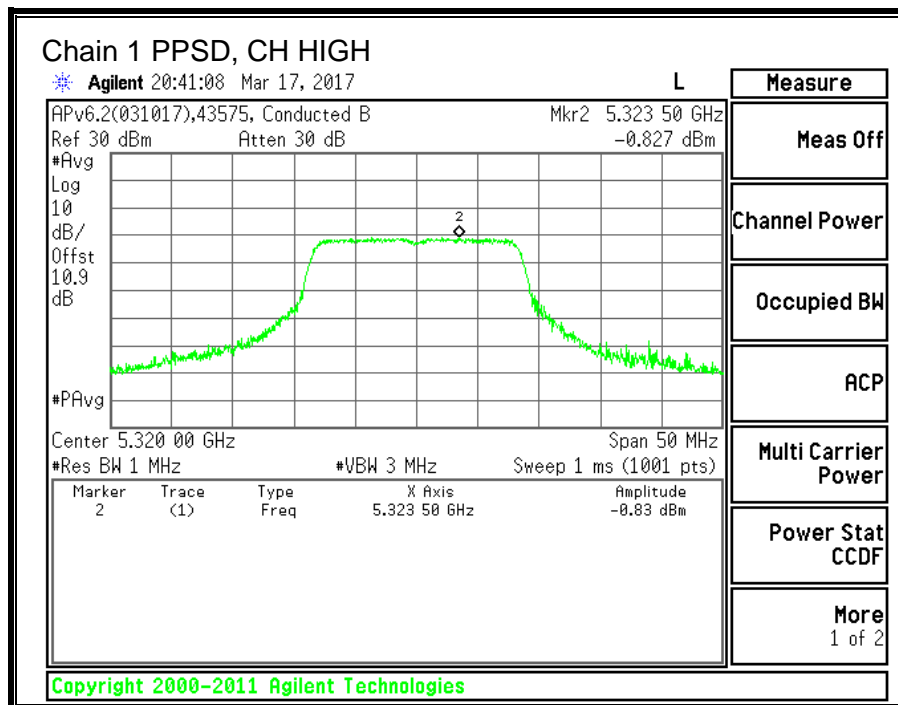
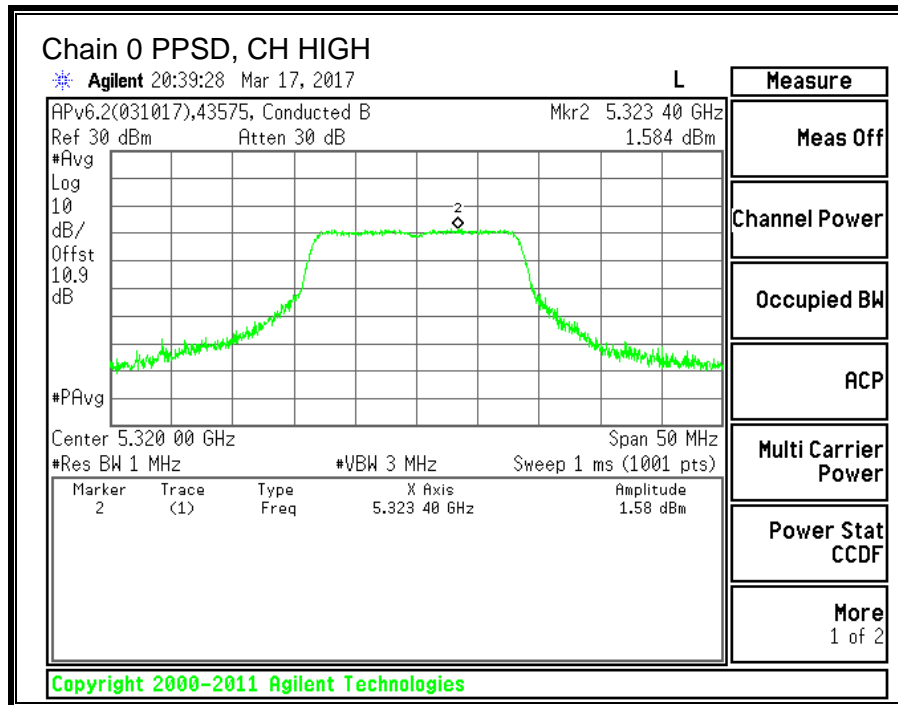

9.6. 11n HT20 2TX CDD MIMO MODE IN THE 5.3GHz BAND

9.6.1. 26 dB BANDWIDTH

LIMITS

None; for reporting purposes only.

RESULTS

Channel	Frequency	26 dB BW Chain 0 (MHz)	26 dB BW Chain 1 (MHz)
Low	5260	24.30	23.15
Mid	5300	25.00	23.00
High	5320	24.55	24.50

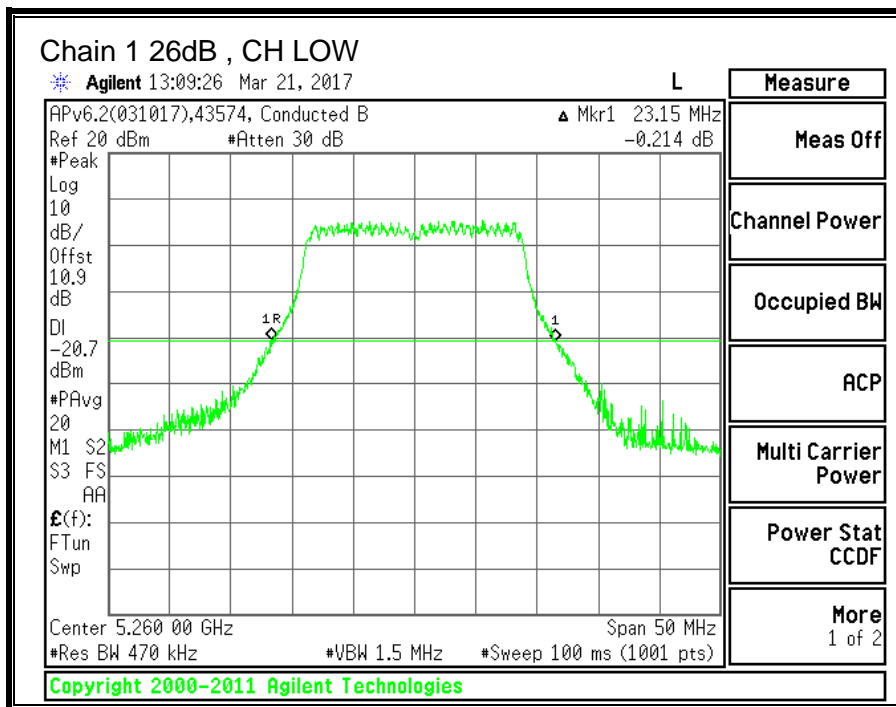
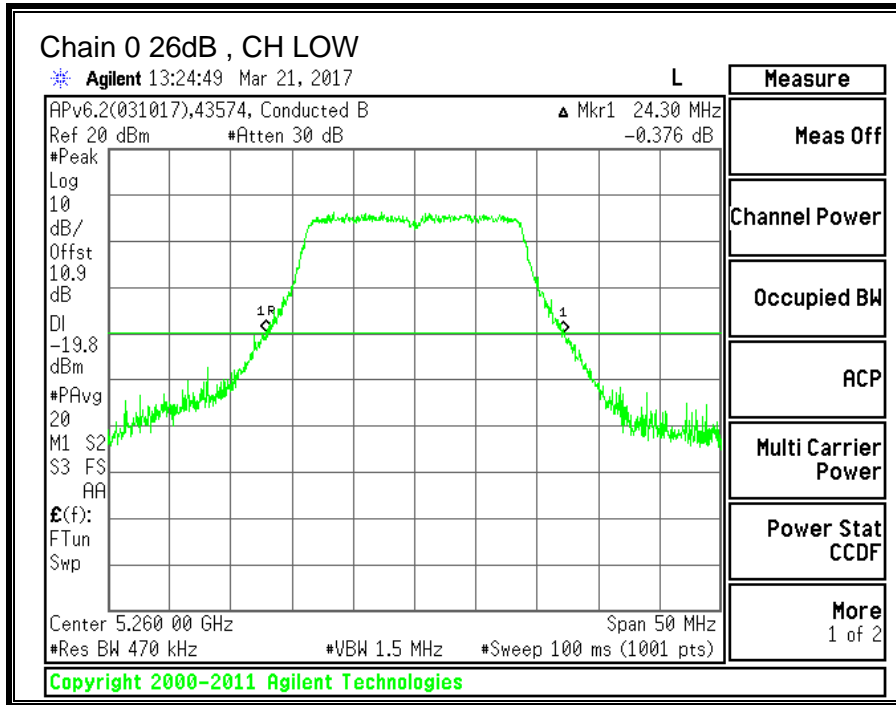

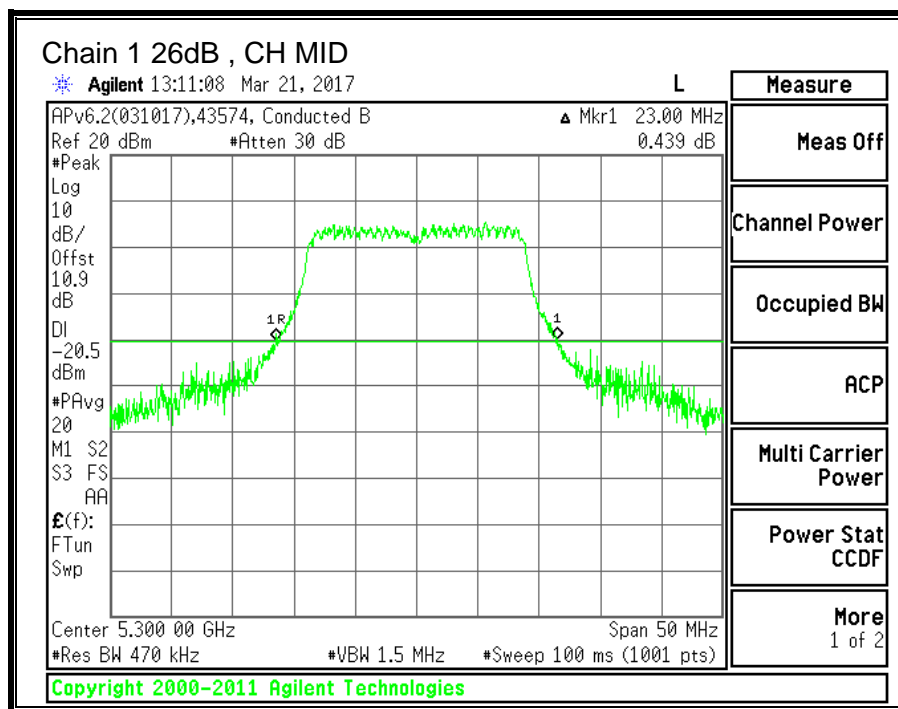
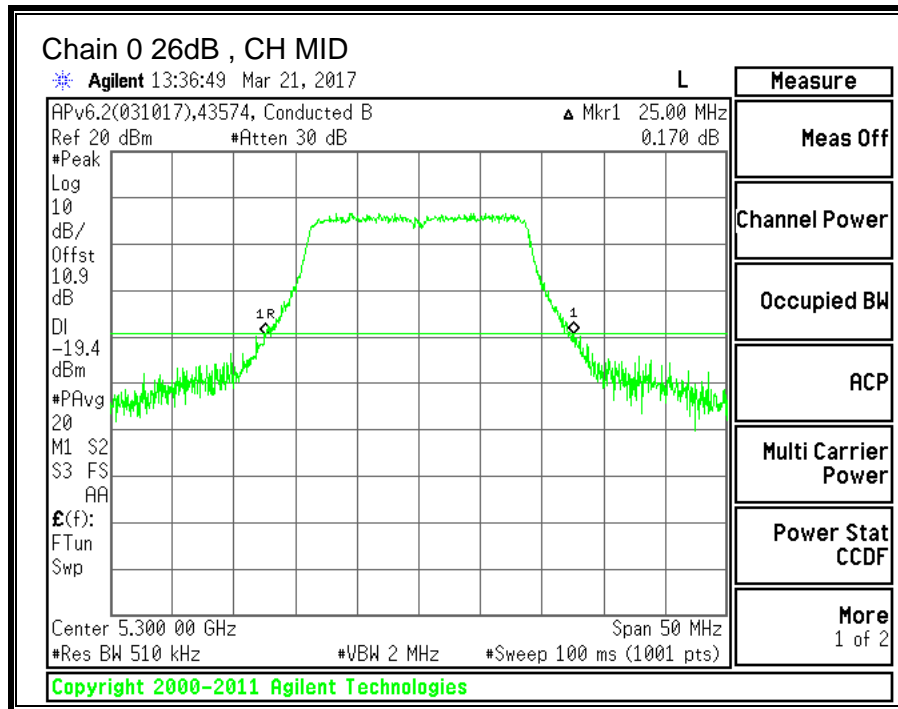

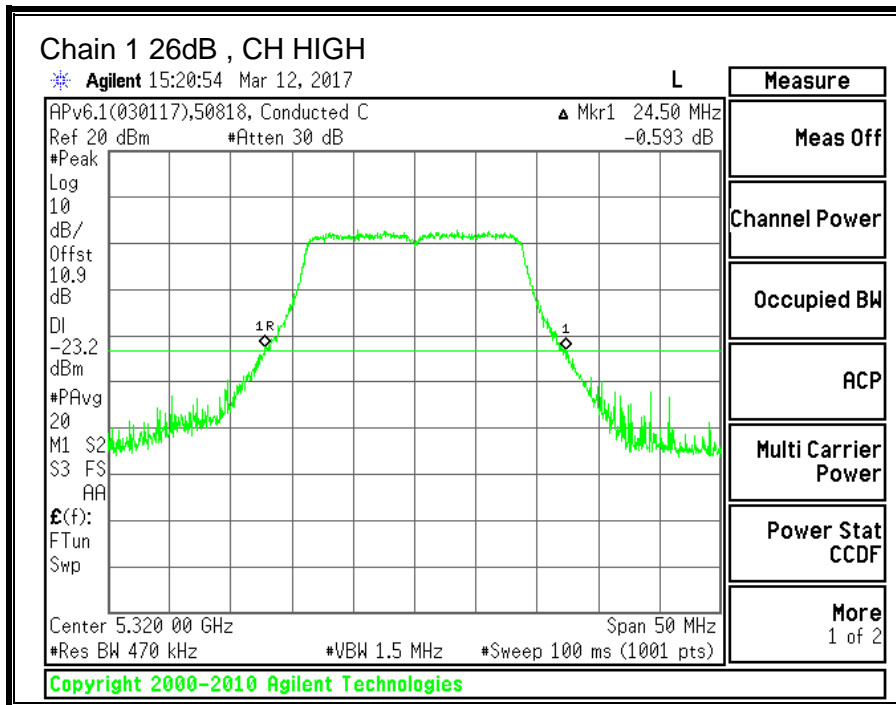
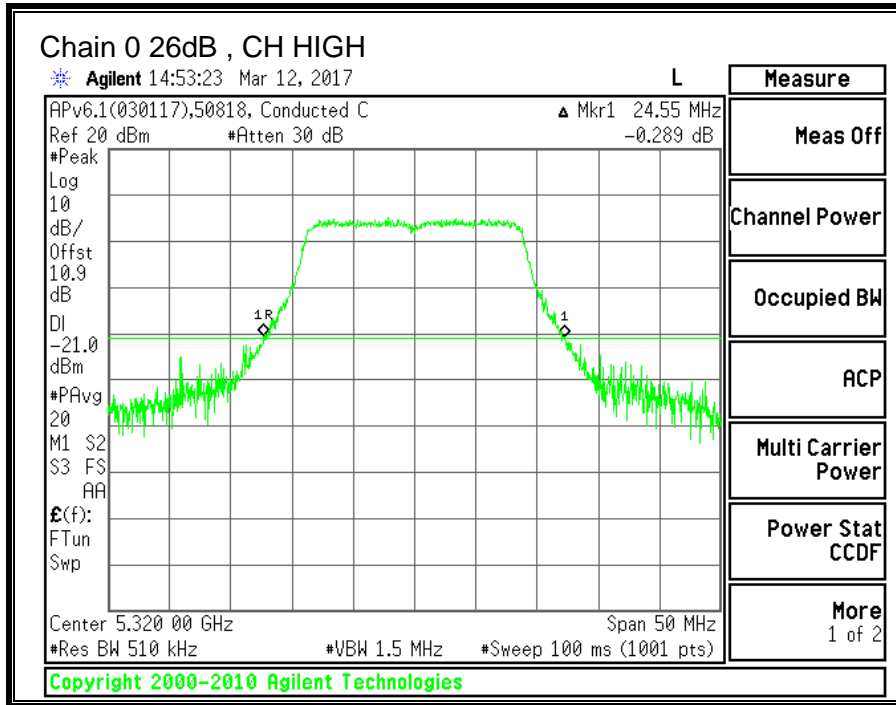

9.6.2. 99% BANDWIDTH

LIMITS

None; for reporting purposes only.

RESULTS

Channel	Frequency	99% BW Chain 0 (MHz)	99% BW Chain 1 (MHz)
Low	5260	17.7304	17.7625
Mid	5300	17.7784	17.6420
High	5320	17.5733	17.7604

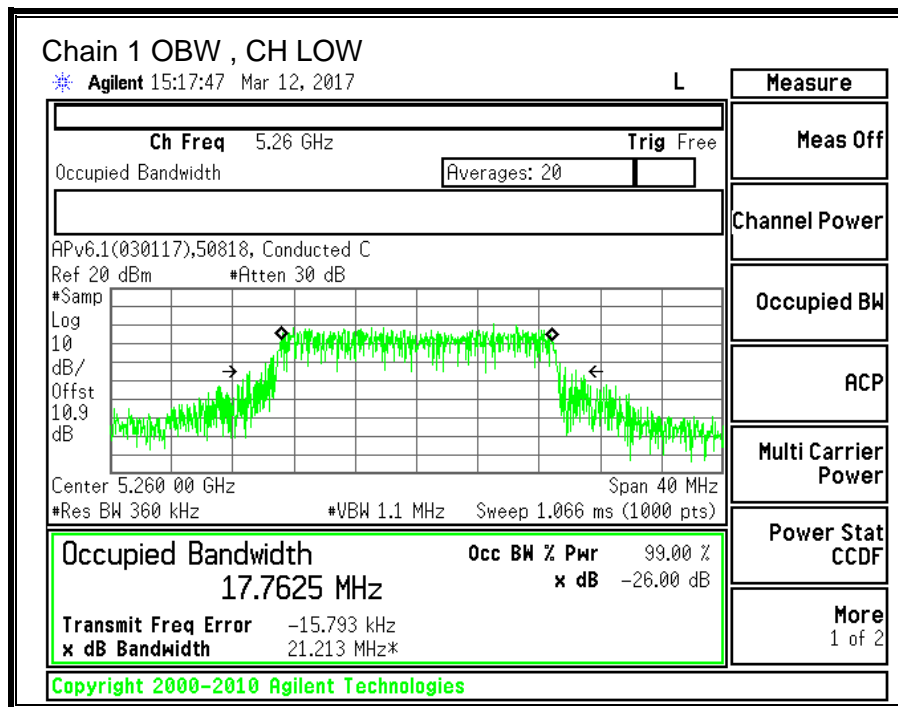
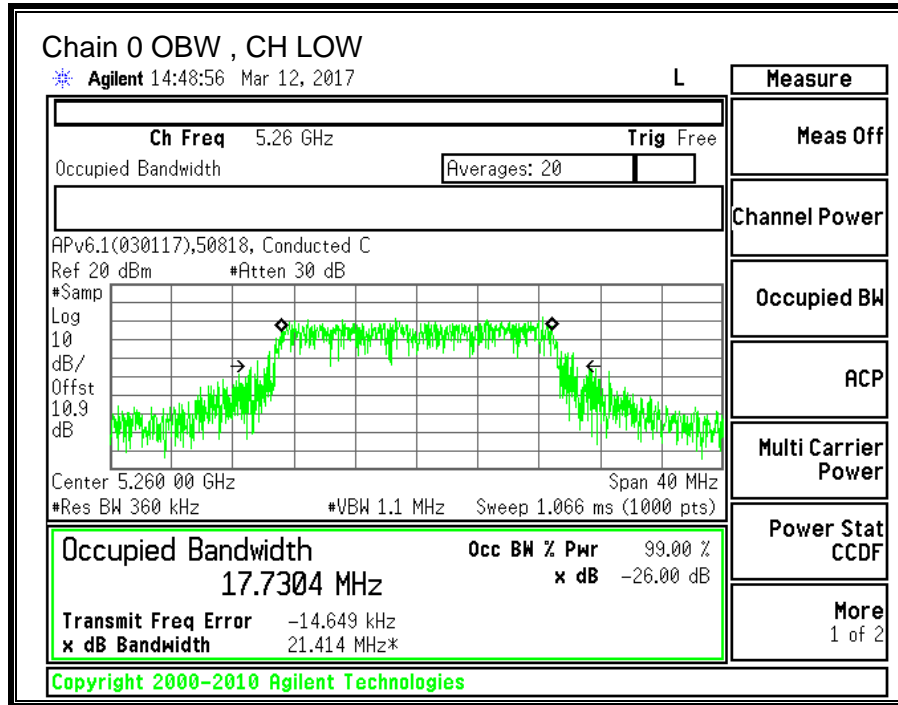

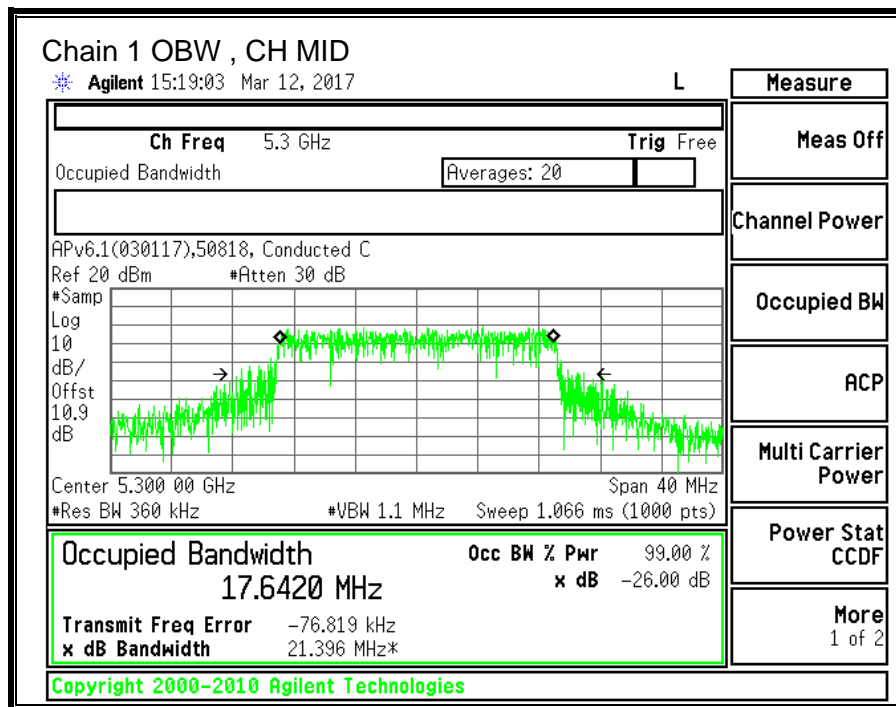
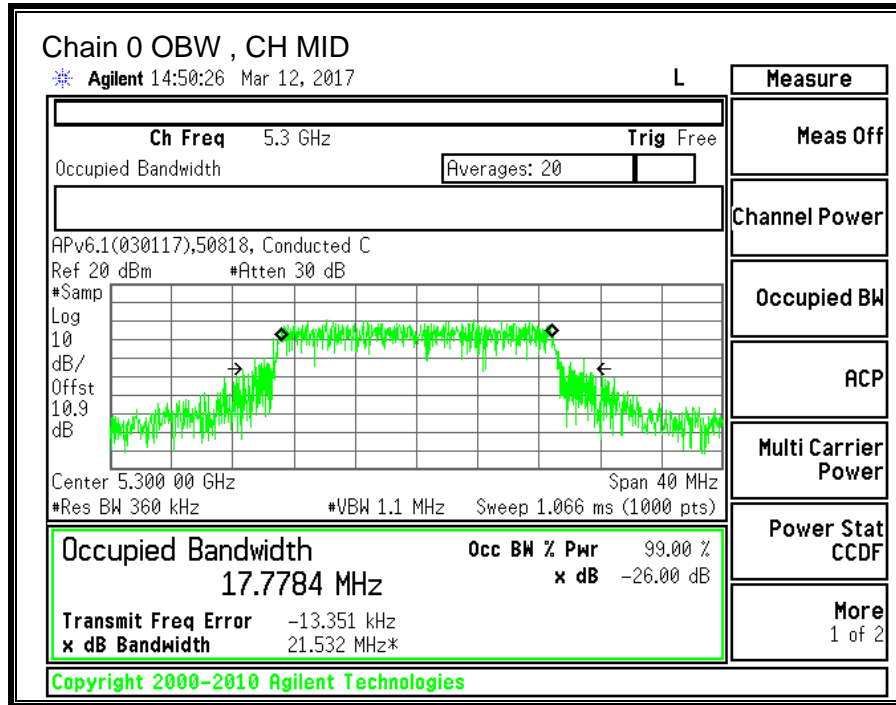

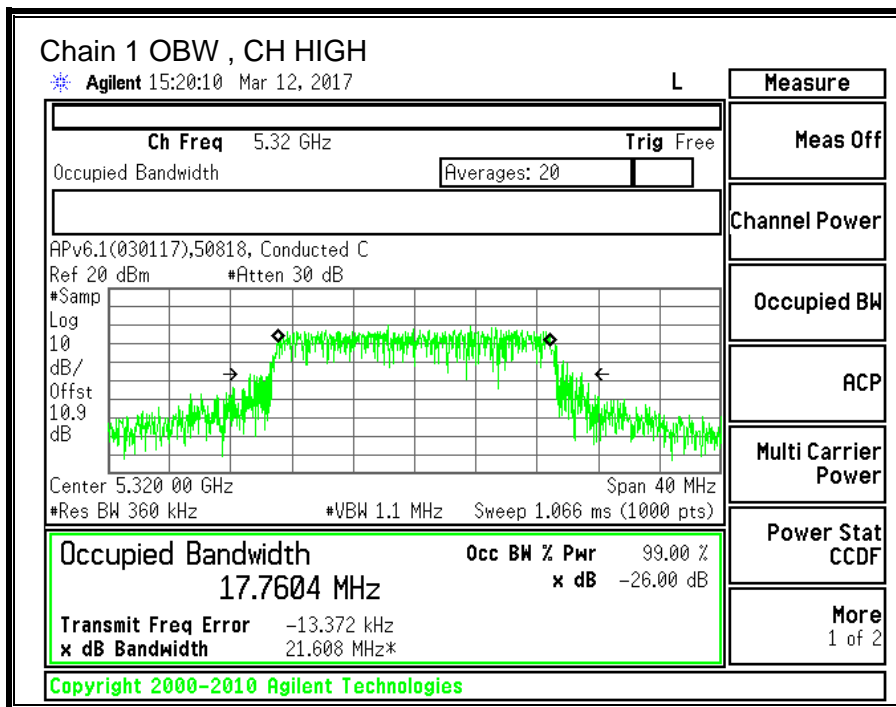
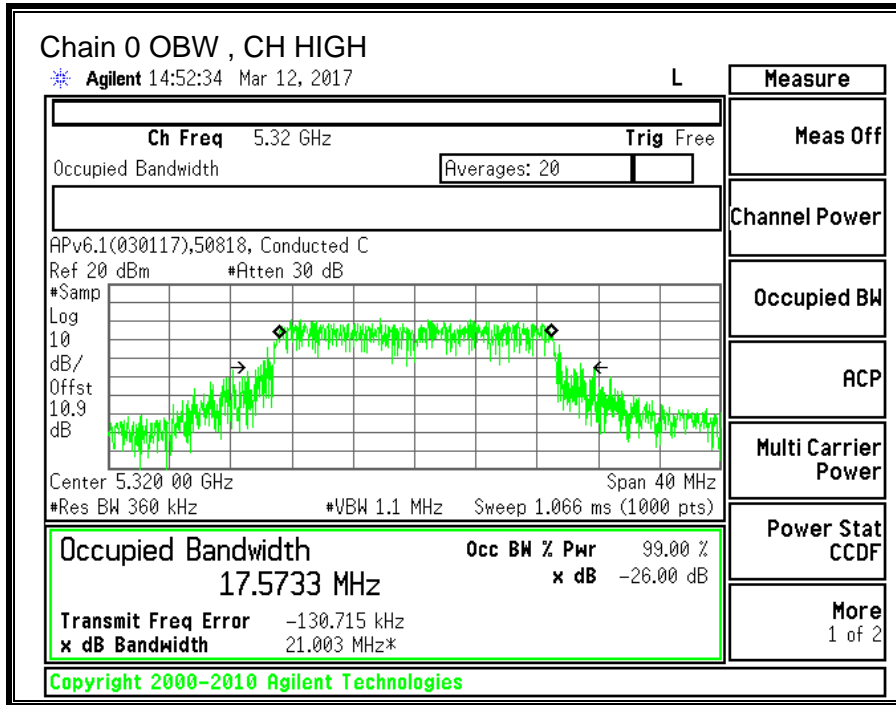

9.6.3. OUTPUT POWER AND PPSD

LIMITS

FCC §15.407 (a) (2)

For the band 5.25–5.35 GHz, the maximum conducted output power over the frequency band of operation shall not exceed the lesser of 250 mW or $11 \text{ dBm} + 10 \log B$, where B is the 26–dB emission bandwidth in MHz. In addition, the maximum power spectral density shall not exceed 11 dBm in any 1–MHz band. If transmitting antennas of directional gain greater than 6 dBi are used, both the maximum conducted output power and the peak power spectral density shall be reduced by the amount in dB that the directional gain of the antenna exceeds 6 dBi.

IC RSS-247 (6.2.2) (1)

The maximum conducted output power shall not exceed 250 mW or $11 + 10 \log_{10} B$, dBm, whichever is less. The power spectral density shall not exceed 11 dBm in any 1.0 MHz band.

The maximum e.i.r.p. shall not exceed 1.0 W or $17 + 10 \log_{10} B$, dBm, whichever is less. B is the 99% emission bandwidth in megahertz. Note that devices with a maximum e.i.r.p. greater than 500 mW shall implement TPC in order to have the capability to operate at least 6 dB below the maximum permitted e.i.r.p. of 1 W.

TEST PROCEDURE

Measurements perform using a wideband gated RF power meter provided that the gate parameters are adjusted such that the power is measured only when the EUT is transmitting at its maximum power control level. Since the measurement is made only during the ON time of the transmitter, no duty cycle correction factor is required.

DIRECTIONAL ANTENNA GAIN

For power, the TX chains are uncorrelated and the antenna gain is unequal among the chains. The directional gain is:

5250-5350 MHz

Chain 0 Antenna Gain (dBi)	Chain 1 Antenna Gain (dBi)	Uncorrelated Chains Directional Gain (dBi)
-2.40	-0.10	-1.10

For PSD the TX chains are correlated and the antenna gain is unequal among the chains. The directional gain is:

5250-5350 MHz

Chain 0 Antenna Gain (dBi)	Chain 1 Antenna Gain (dBi)	Correlated Chains Directional Gain (dBi)
-2.40	-0.10	1.84

RESULTS

ID:	43578	Date:	3/17/17
------------	-------	--------------	---------

Bandwidth and Antenna Gain

Channel	Frequency (MHz)	Min 26 dB BW (MHz)	Min 99% BW (MHz)	Directional Gain for Power (dBi)	Directional Gain for PPSD (dBi)
Low	5260	23.15	17.730	-1.10	1.84
Mid	5300	23.00	17.642	-1.10	1.84
High	5320	24.50	17.573	-1.10	1.84

Limits

Channel	Frequency (MHz)	FCC Power Limit (dBm)	IC Power Limit (dBm)	IC EIRP Limit (dBm)	Power Limit (dBm)	FCC PPSD Limit (dBm)	IC PSD Limit (dBm)	PPSD Limit (dBm)
Low	5260	24.00	23.49	29.49	23.49	11.00	11.00	11.00
Mid	5300	24.00	23.47	29.47	23.47	11.00	11.00	11.00
High	5320	24.00	23.45	29.45	23.45	11.00	11.00	11.00

Duty Cycle CF (dB)	0.10	Included in Calculations of Corr'd PPSD
---------------------------	------	--

Output Power Results

Channel	Frequency (MHz)	Chain 0 Meas Power (dBm)	Chain 1 Meas Power (dBm)	Total Corr'd Power (dBm)	Power Limit (dBm)	Power Margin (dB)
Low	5260	12.62	10.13	14.56	23.49	-8.93
Mid	5300	12.54	10.03	14.47	23.47	-8.99
High	5320	12.60	10.23	14.59	23.45	-8.86

PPSD Results

Channel	Frequency (MHz)	Chain 0 Meas PPSD (dBm)	Chain 1 Meas PPSD (dBm)	Total Corr'd PPSD (dBm)	PPSD Limit (dBm)	PPSD Margin (dB)
Low	5260	1.235	-1.411	3.22	11.00	-7.78
Mid	5300	0.948	-1.354	3.06	11.00	-7.94
High	5320	1.300	-0.948	3.43	11.00	-7.57

Note: the power readings above were measured with gated method, and the measurement was taken only during the ON time. No duty cycle correction was necessary.

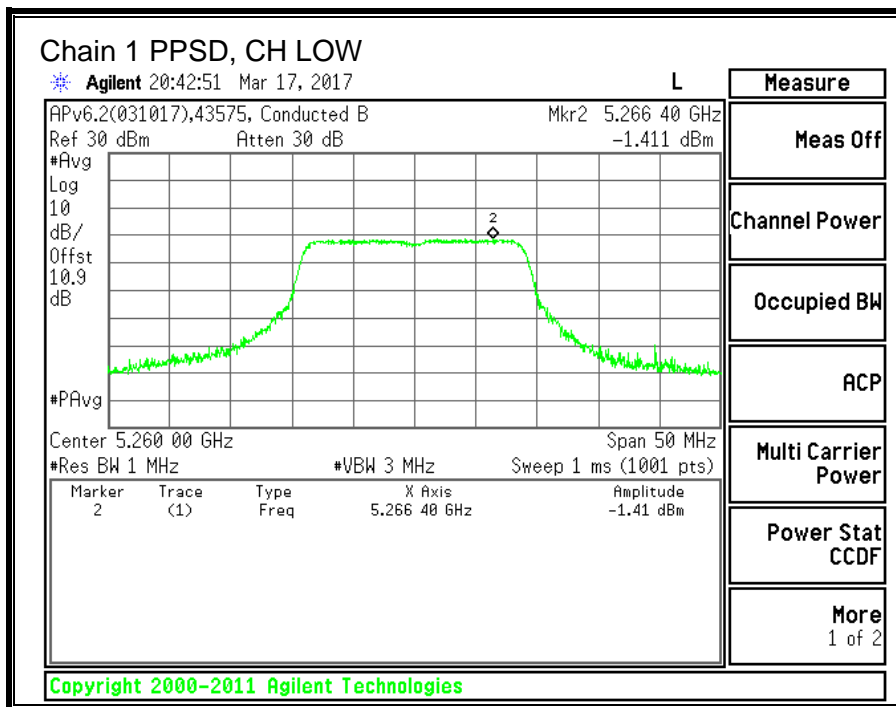
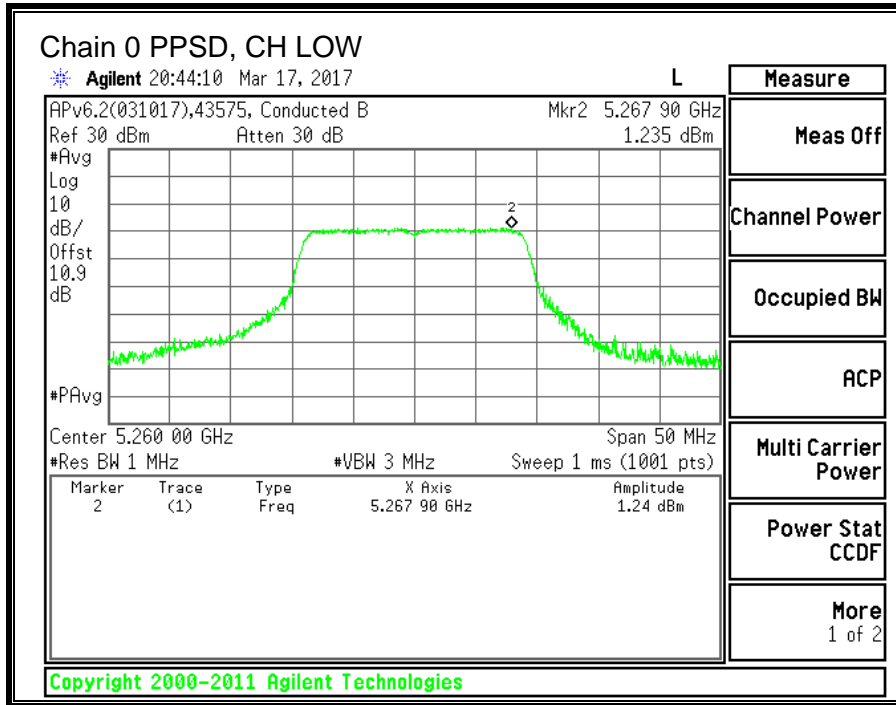

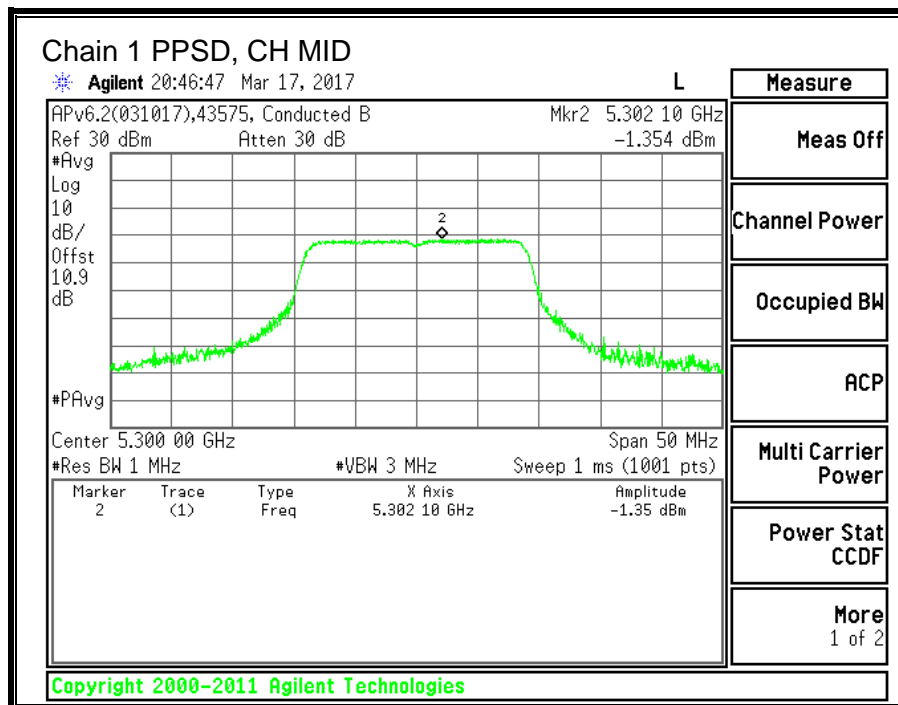
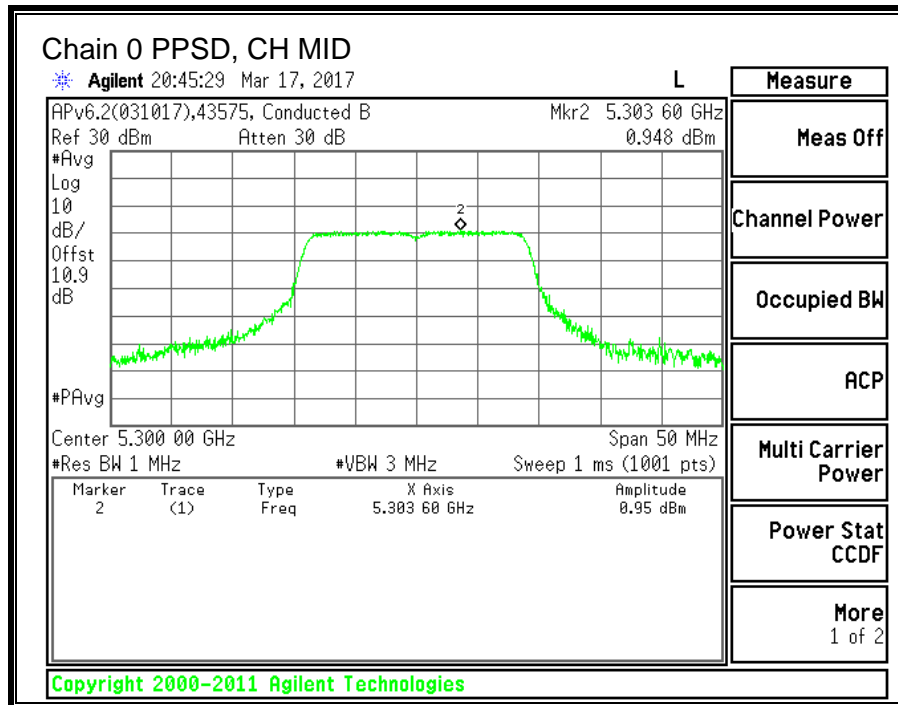

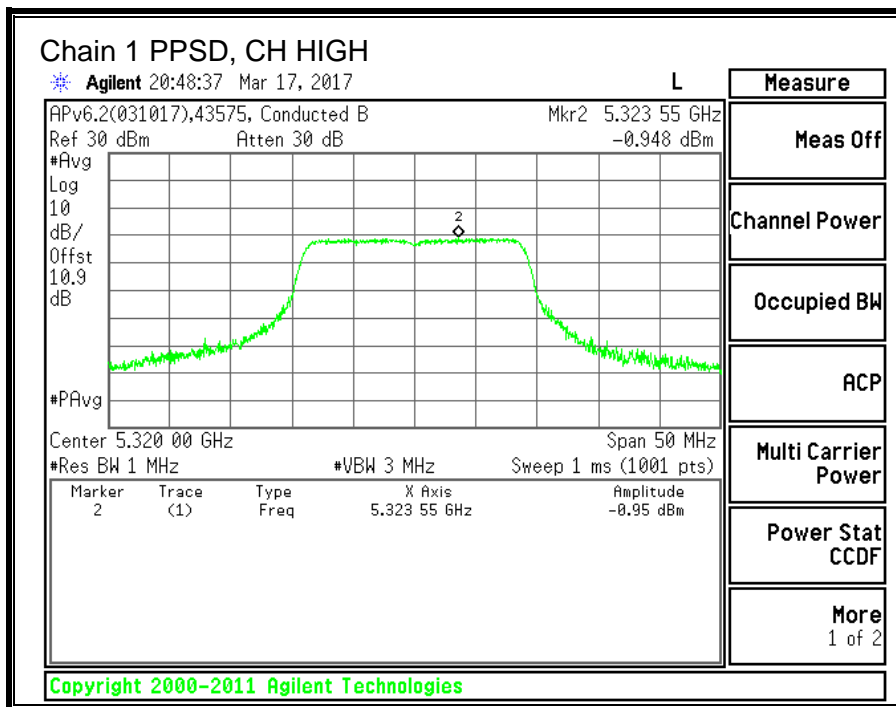
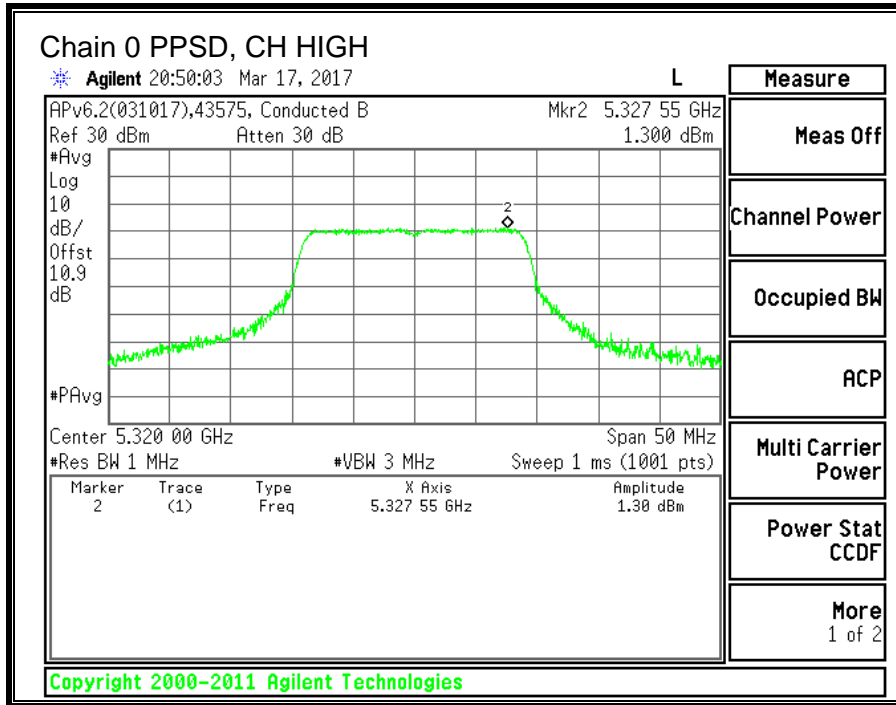

9.7. 11n HT40 2TX CDD MIMO MODE IN THE 5.3GHz BAND

9.7.1. 26 dB BANDWIDTH

LIMITS

None; for reporting purposes only.

RESULTS

Channel	Frequency	26 dB BW Chain 0 (MHz)	26 dB BW Chain 1 (MHz)
Low	5270	43.40	43.30
High	5310	43.40	43.20

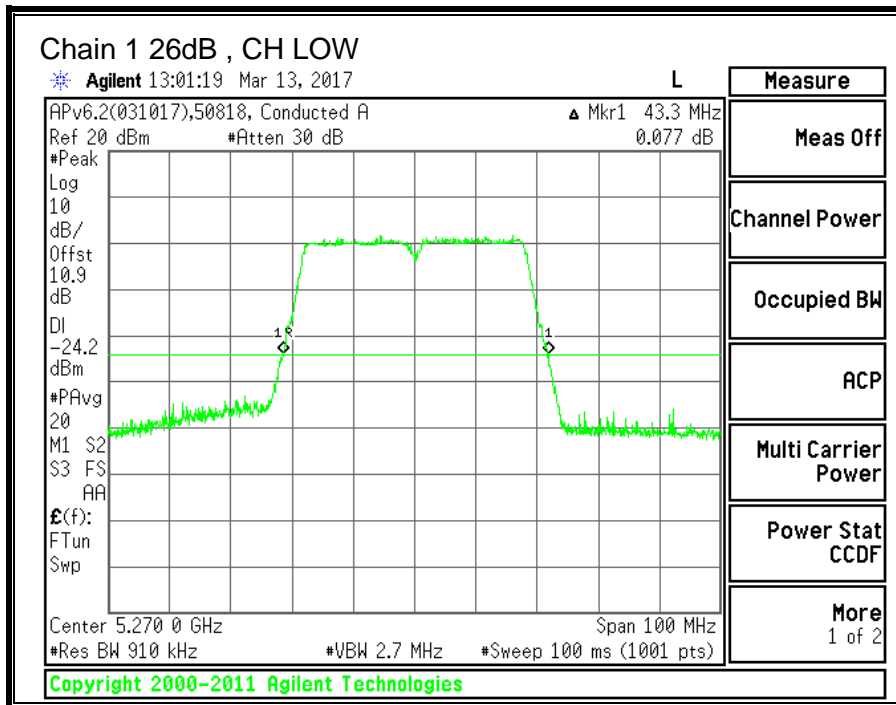
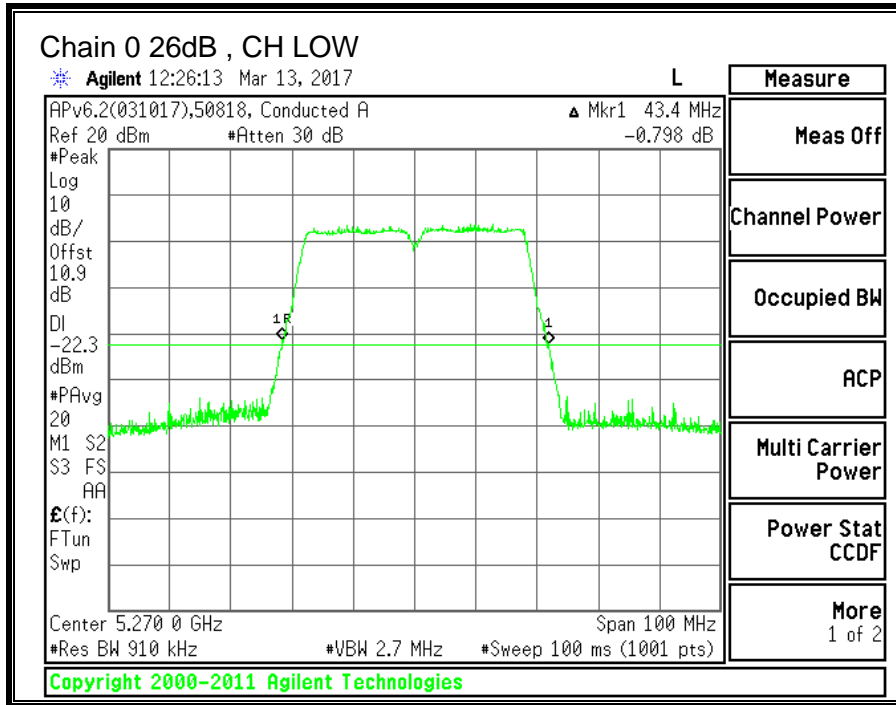

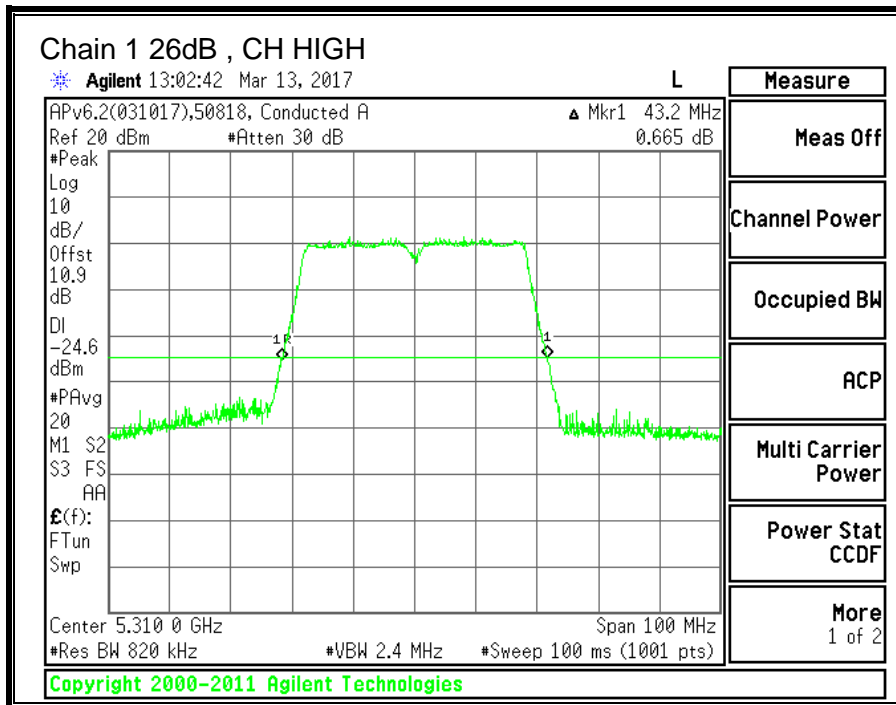
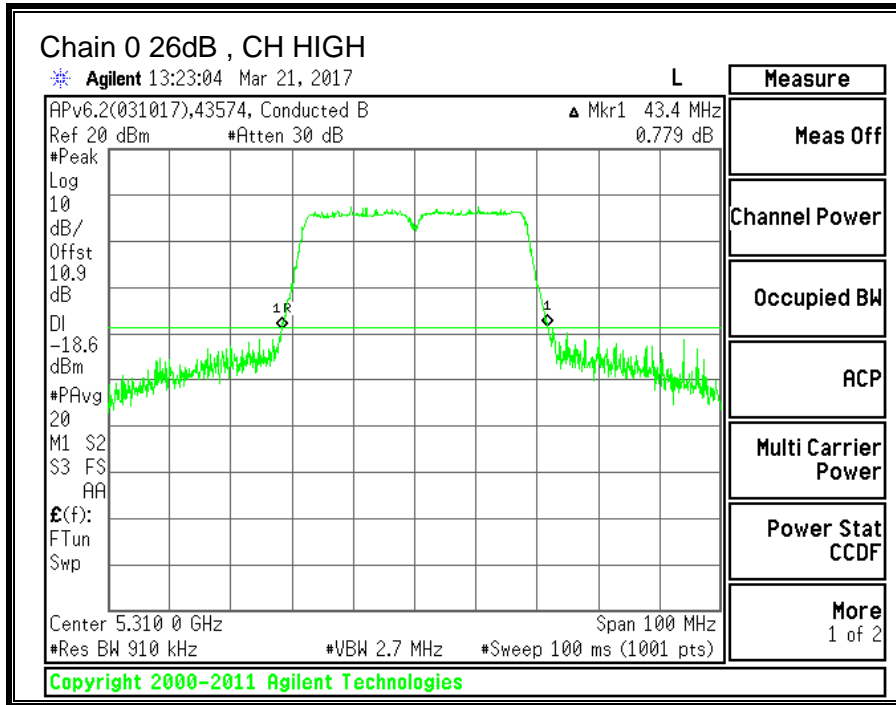

9.7.2. 99% BANDWIDTH

LIMITS

None; for reporting purposes only.

RESULTS

Channel	Frequency	99% BW Chain 0 (MHz)	99% BW Chain 1 (MHz)
Low	5270	36.2130	36.4093
High	5310	36.4349	36.0435

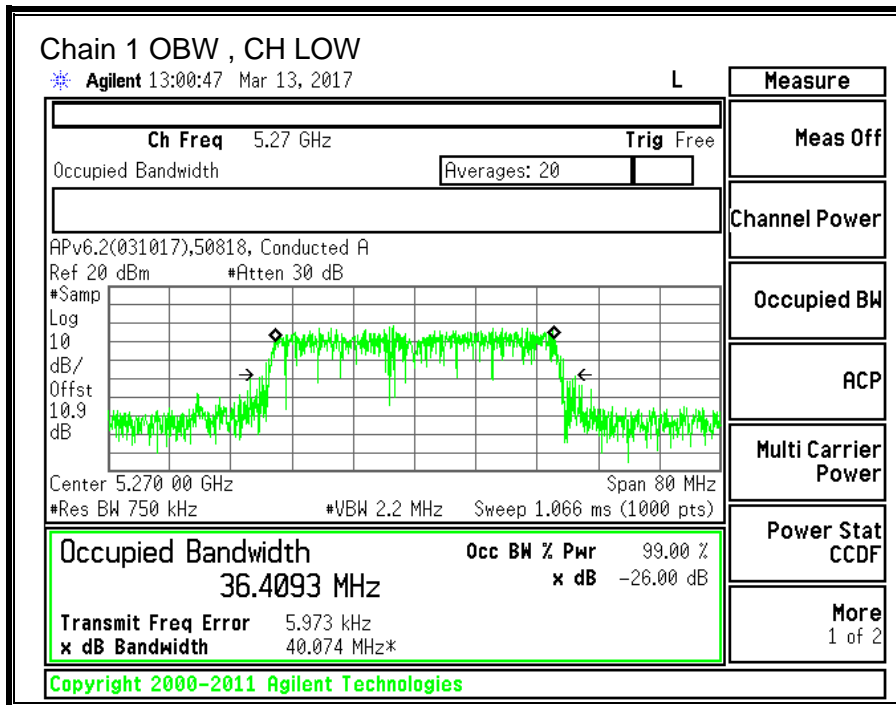
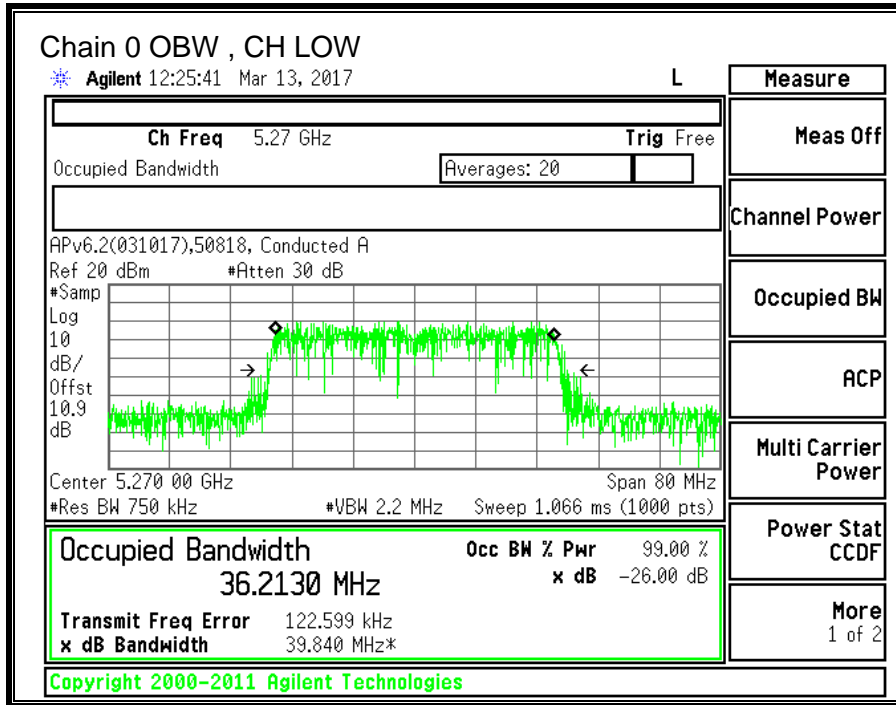

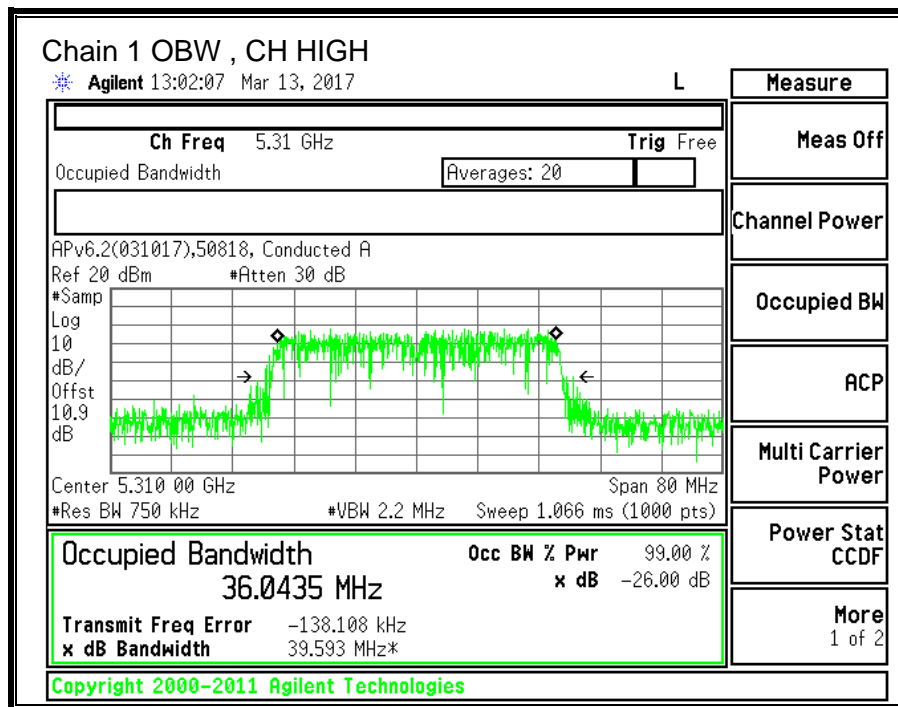
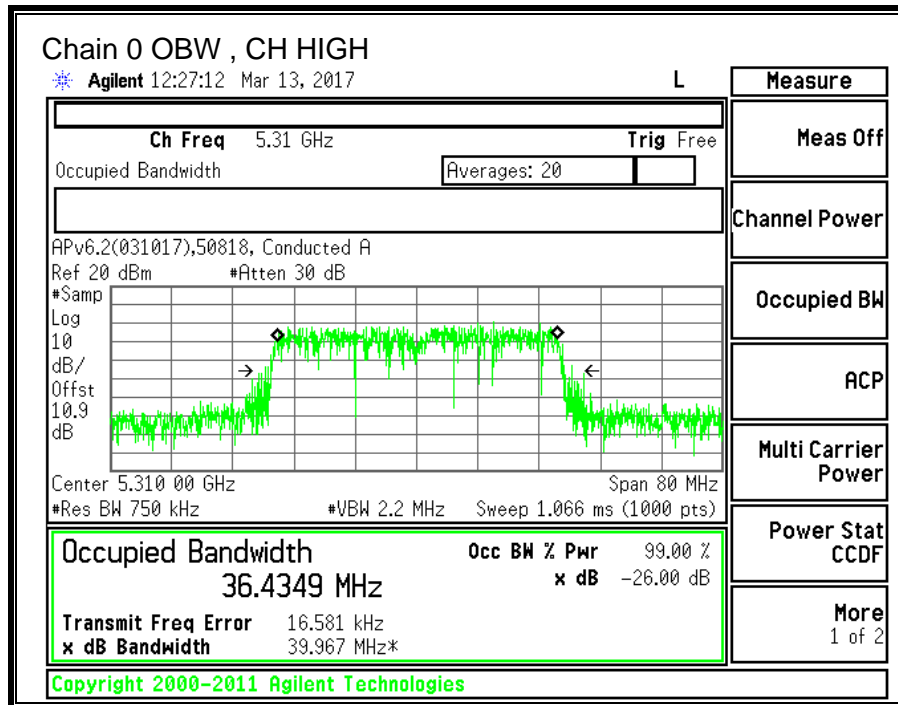

9.7.3. OUTPUT POWER AND PPSD

LIMITS

FCC §15.407 (a) (2)

For the band 5.25–5.35 GHz, the maximum conducted output power over the frequency band of operation shall not exceed the lesser of 250 mW or $11 \text{ dBm} + 10 \log B$, where B is the 26–dB emission bandwidth in MHz. In addition, the maximum power spectral density shall not exceed 11 dBm in any 1–MHz band. If transmitting antennas of directional gain greater than 6 dBi are used, both the maximum conducted output power and the peak power spectral density shall be reduced by the amount in dB that the directional gain of the antenna exceeds 6 dBi.

IC RSS-247 (6.2.2) (1)

The maximum conducted output power shall not exceed 250 mW or $11 + 10 \log_{10} B$, dBm, whichever is less. The power spectral density shall not exceed 11 dBm in any 1.0 MHz band.

The maximum e.i.r.p. shall not exceed 1.0 W or $17 + 10 \log_{10} B$, dBm, whichever is less. B is the 99% emission bandwidth in megahertz. Note that devices with a maximum e.i.r.p. greater than 500 mW shall implement TPC in order to have the capability to operate at least 6 dB below the maximum permitted e.i.r.p. of 1 W.

TEST PROCEDURE

Measurements perform using a wideband gated RF power meter provided that the gate parameters are adjusted such that the power is measured only when the EUT is transmitting at its maximum power control level. Since the measurement is made only during the ON time of the transmitter, no duty cycle correction factor is required.

DIRECTIONAL ANTENNA GAIN

For power, the TX chains are uncorrelated and the antenna gain is unequal among the chains. The directional gain is:

5250-5350 MHz

Chain 0 Antenna Gain (dBi)	Chain 1 Antenna Gain (dBi)	Uncorrelated Chains Directional Gain (dBi)
-2.40	-0.10	-1.10

For PSD the TX chains are correlated and the antenna gain is unequal among the chains. The directional gain is:

5250-5350 MHz

Chain 0 Antenna Gain (dBi)	Chain 1 Antenna Gain (dBi)	Correlated Chains Directional Gain (dBi)
-2.40	-0.10	1.84

RESULTS

ID:	43578	Date:	3/17/17
------------	-------	--------------	---------

Bandwidth and Antenna Gain

Channel	Frequency (MHz)	Min 26 dB BW (MHz)	Min 99% BW (MHz)	Directional Gain for Power (dBi)	Directional Gain for PPSD (dBi)
Low	5270	43.30	36.213	-1.10	1.84
High	5310	43.20	36.044	-1.10	1.84

Limits

Channel	Frequency (MHz)	FCC Power Limit (dBm)	IC Power Limit (dBm)	IC EIRP Limit (dBm)	Power Limit (dBm)	FCC PPSD Limit (dBm)	IC PSD Limit (dBm)	PPSD Limit (dBm)
Low	5270	24.00	24.00	30.00	24.00	11.00	11.00	11.00
High	5310	24.00	24.00	30.00	24.00	11.00	11.00	11.00

Duty Cycle CF (dB)	0.22	Included in Calculations of Corr'd PPSD
---------------------------	------	--

Output Power Results

Channel	Frequency (MHz)	Chain 0 Meas Power (dBm)	Chain 1 Meas Power (dBm)	Total Corr'd Power (dBm)	Power Limit (dBm)	Power Margin (dB)
Low	5270	12.61	10.28	14.61	24.00	-9.39
High	5310	12.86	10.35	14.79	24.00	-9.21

PPSD Results

Channel	Frequency (MHz)	Chain 0 Meas PPSD (dBm)	Chain 1 Meas PPSD (dBm)	Total Corr'd PPSD (dBm)	PPSD Limit (dBm)	PPSD Margin (dB)
Low	5270	-1.913	-4.015	0.39	11.00	-10.61
High	5310	-1.311	-3.397	1.00	11.00	-10.00

Note: the power readings above were measured with gated method, and the measurement was taken only during the ON time. No duty cycle correction was necessary.

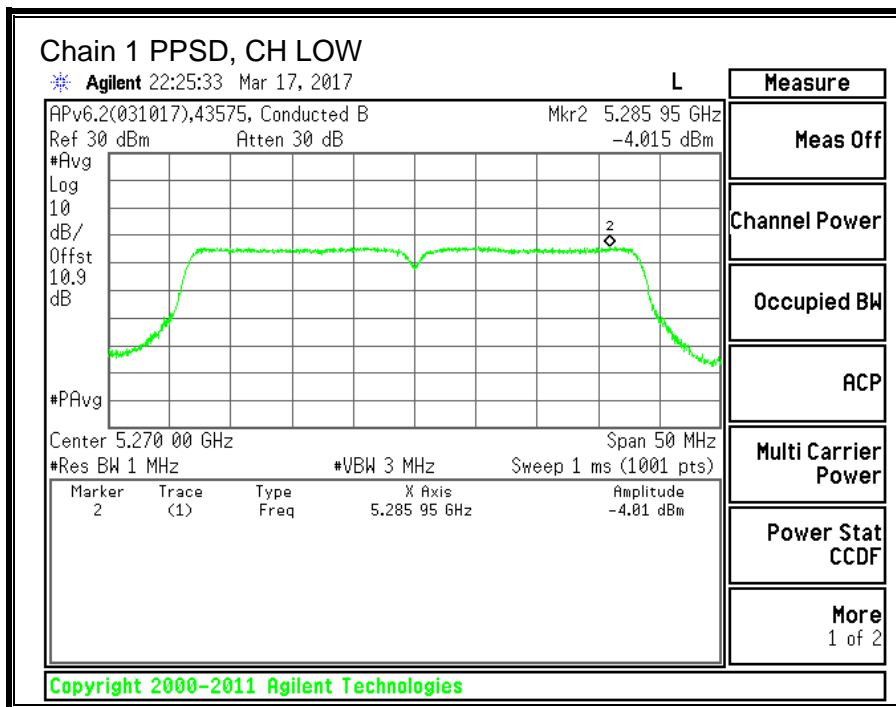
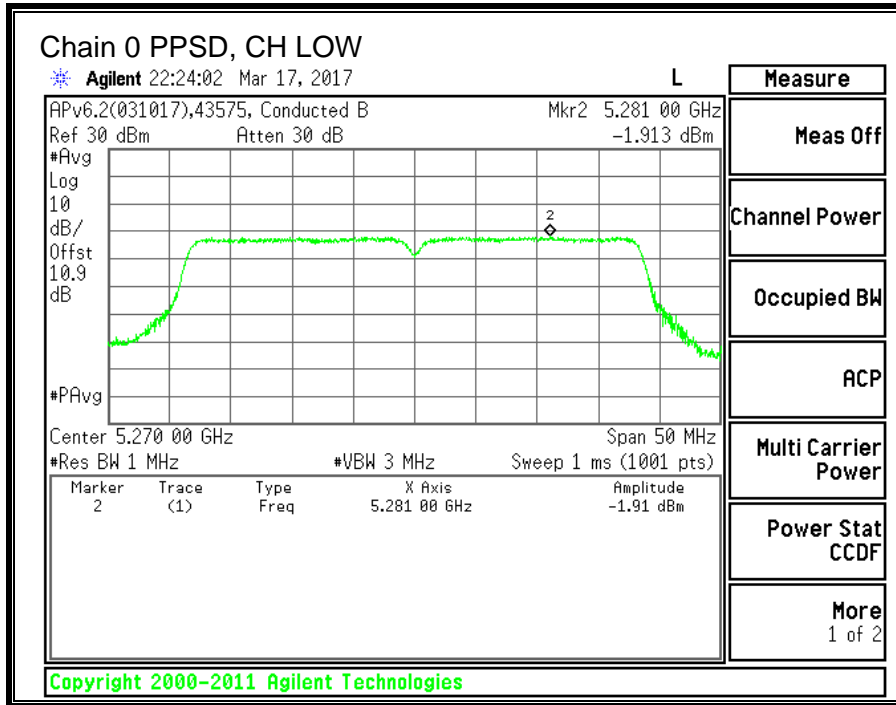

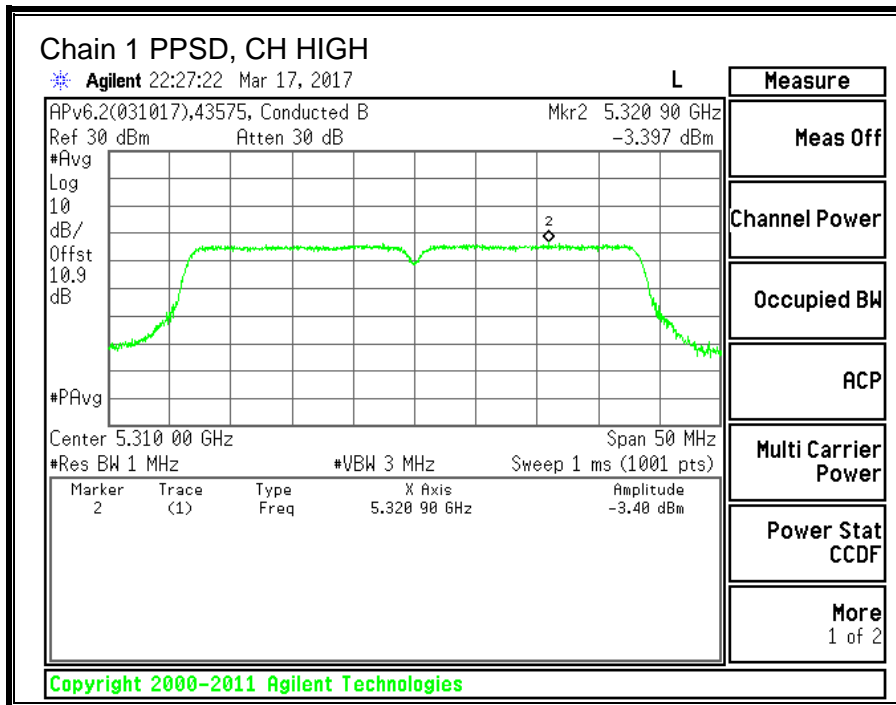
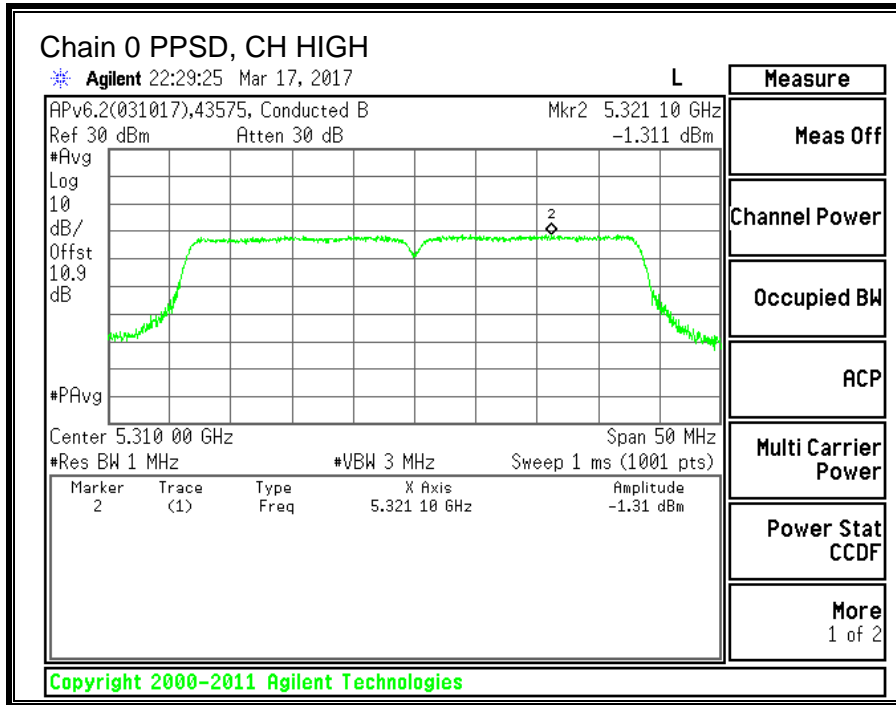

9.8. 11ac HT80 2TX CDD MIMO MODE IN THE 5.3GHz BAND

9.8.1. 26 dB BANDWIDTH

LIMITS

None; for reporting purposes only.

RESULTS

Channel	Frequency	26 dB BW Chain 0 (MHz)	26 dB BW Chain 1 (MHz)
Mid	5290	86.00	87.00

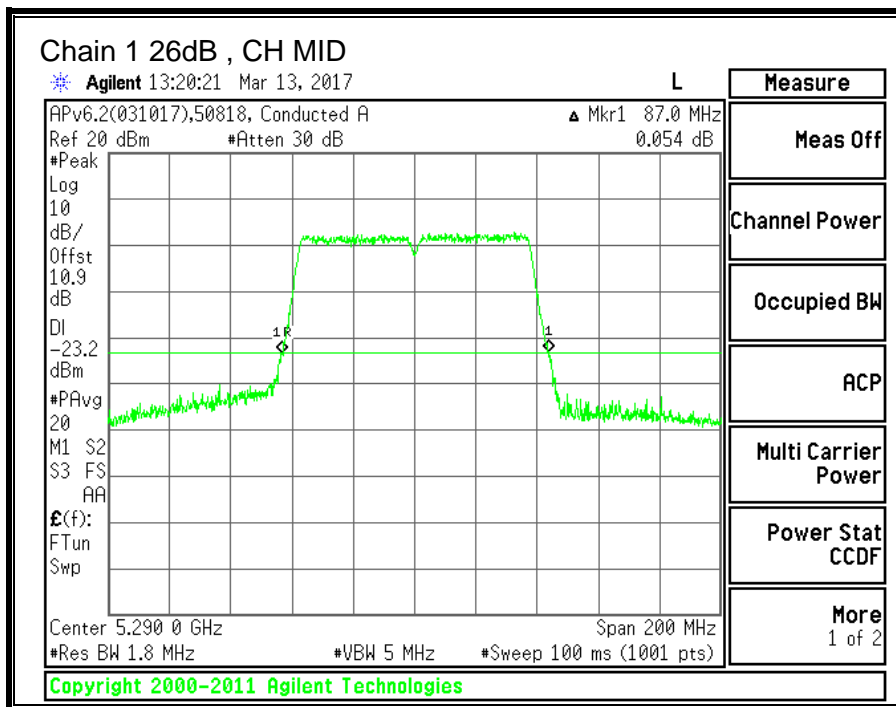
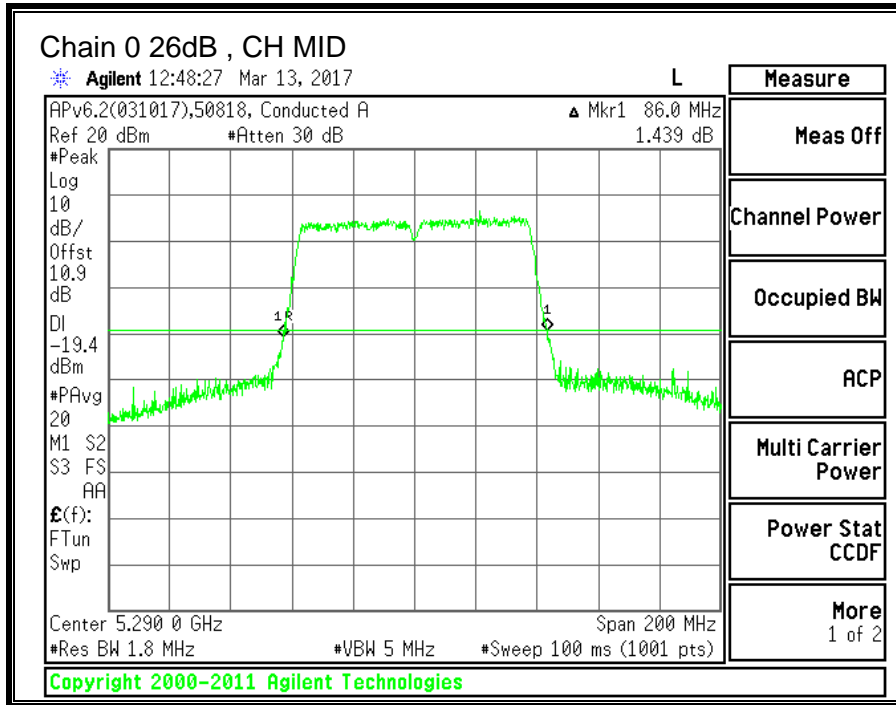

9.8.2. 99% BANDWIDTH

LIMITS

None; for reporting purposes only.

RESULTS

Channel	Frequency	99% BW Chain 0 (MHz)	99% BW Chain 1 (MHz)
Mid	5290	75.0943	74.9020

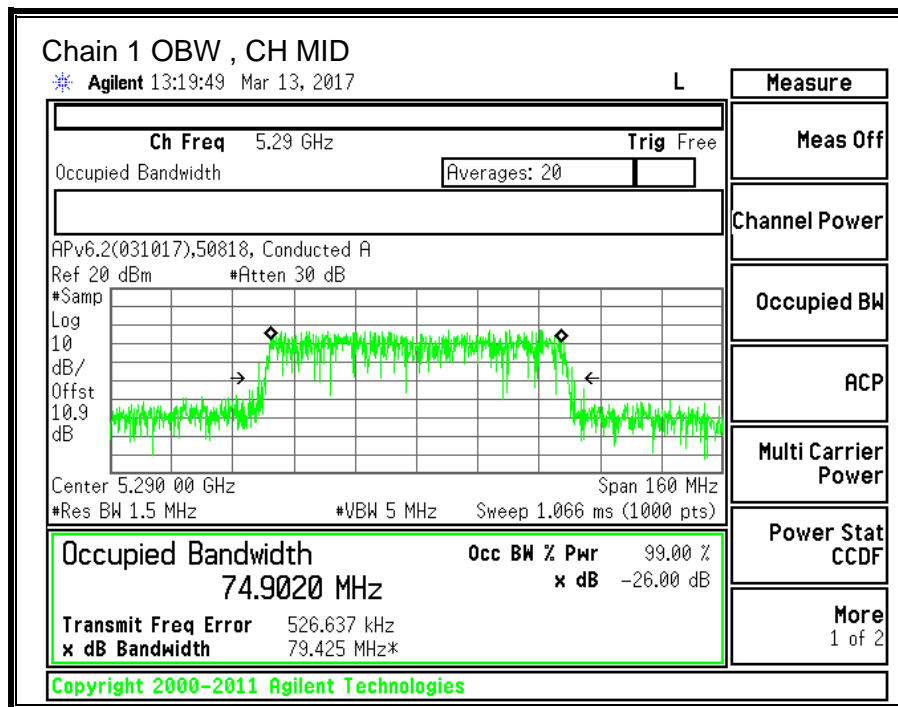
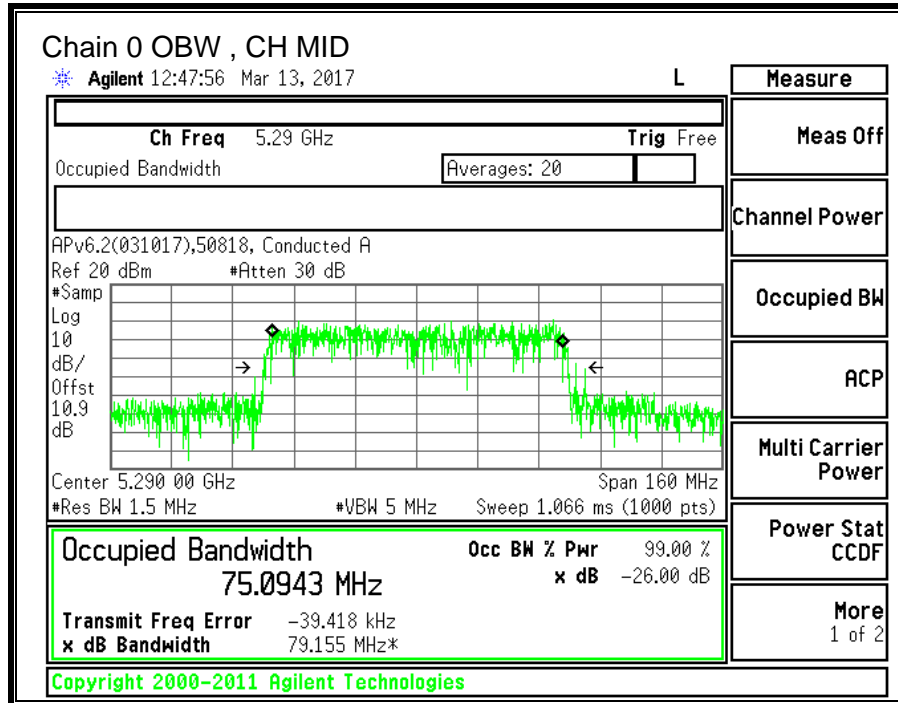

9.8.3. OUTPUT POWER AND PPSD

LIMITS

FCC §15.407 (a) (2)

For the band 5.25–5.35 GHz, the maximum conducted output power over the frequency band of operation shall not exceed the lesser of 250 mW or $11 \text{ dBm} + 10 \log B$, where B is the 26–dB emission bandwidth in MHz. In addition, the maximum power spectral density shall not exceed 11 dBm in any 1–MHz band. If transmitting antennas of directional gain greater than 6 dBi are used, both the maximum conducted output power and the peak power spectral density shall be reduced by the amount in dB that the directional gain of the antenna exceeds 6 dBi.

IC RSS-247 (6.2.2) (1)

The maximum conducted output power shall not exceed 250 mW or $11 + 10 \log_{10} B$, dBm, whichever is less. The power spectral density shall not exceed 11 dBm in any 1.0 MHz band.

The maximum e.i.r.p. shall not exceed 1.0 W or $17 + 10 \log_{10} B$, dBm, whichever is less. B is the 99% emission bandwidth in megahertz. Note that devices with a maximum e.i.r.p. greater than 500 mW shall implement TPC in order to have the capability to operate at least 6 dB below the maximum permitted e.i.r.p. of 1 W.

TEST PROCEDURE

Measurements perform using a wideband gated RF power meter provided that the gate parameters are adjusted such that the power is measured only when the EUT is transmitting at its maximum power control level. Since the measurement is made only during the ON time of the transmitter, no duty cycle correction factor is required.

DIRECTIONAL ANTENNA GAIN

For power, the TX chains are uncorrelated and the antenna gain is unequal among the chains. The directional gain is:

5250-5350 MHz

Chain 0 Antenna Gain (dBi)	Chain 1 Antenna Gain (dBi)	Uncorrelated Chains Directional Gain (dBi)
-2.40	-0.10	-1.10

For PSD the TX chains are correlated and the antenna gain is unequal among the chains. The directional gain is:

5250-5350 MHz

Chain 0 Antenna Gain (dBi)	Chain 1 Antenna Gain (dBi)	Correlated Chains Directional Gain (dBi)
-2.40	-0.10	1.84

RESULTS

ID:	43578	Date:	3/17/17
------------	-------	--------------	---------

Bandwidth and Antenna Gain

Channel	Frequency (MHz)	Min 26 dB BW (MHz)	Min 99% BW (MHz)	Directional Gain for Power (dBi)	Directional Gain for PPSD (dBi)
Low	5290	86.00	74.902	-1.10	1.84

Limits

Channel	Frequency (MHz)	FCC Power Limit (dBm)	IC Power Limit (dBm)	IC EIRP Limit (dBm)	Power Limit (dBm)	FCC PPSD Limit (dBm)	IC PSD Limit (dBm)	PPSD Limit (dBm)
Low	5290	24.00	24.00	30.00	24.00	11.00	11.00	11.00

Duty Cycle CF (dB)	0.42	Included in Calculations of Corr'd PPSD
---------------------------	------	--

Output Power Results

Channel	Frequency (MHz)	Chain 0 Meas Power (dBm)	Chain 1 Meas Power (dBm)	Total Corr'd Power (dBm)	Power Limit (dBm)	Power Margin (dB)
Low	5290	12.81	10.45	14.80	24.00	-9.20

PPSD Results

Channel	Frequency (MHz)	Chain 0 Meas PPSD (dBm)	Chain 1 Meas PPSD (dBm)	Total Corr'd PPSD (dBm)	PPSD Limit (dBm)	PPSD Margin (dB)
Low	5290	-6.037	-7.723	-3.37	11.00	-14.37

Note: the power readings above were measured with gated method, and the measurement was taken only during the ON time. No duty cycle correction was necessary.

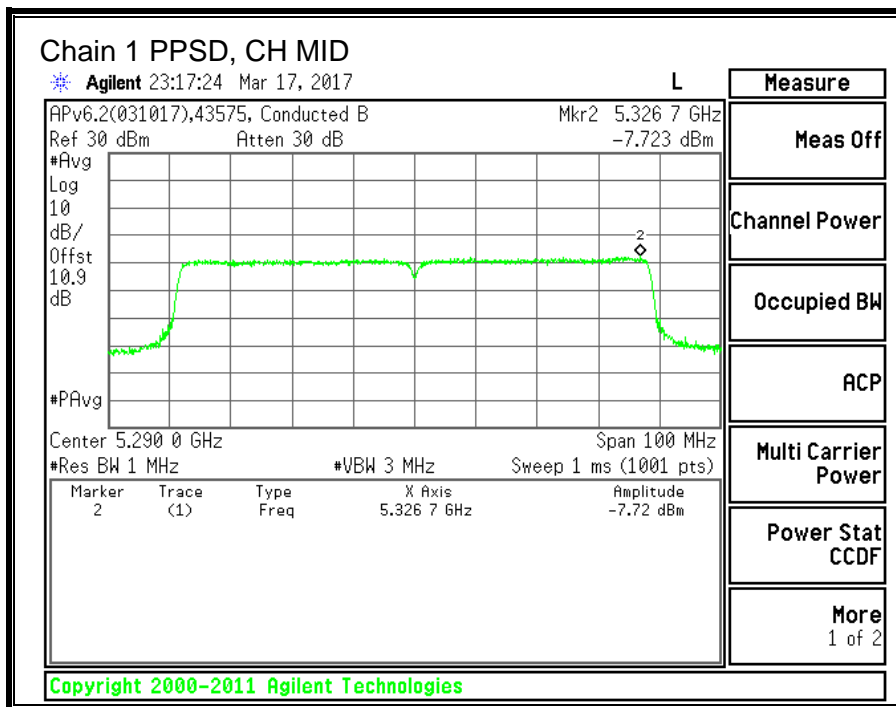
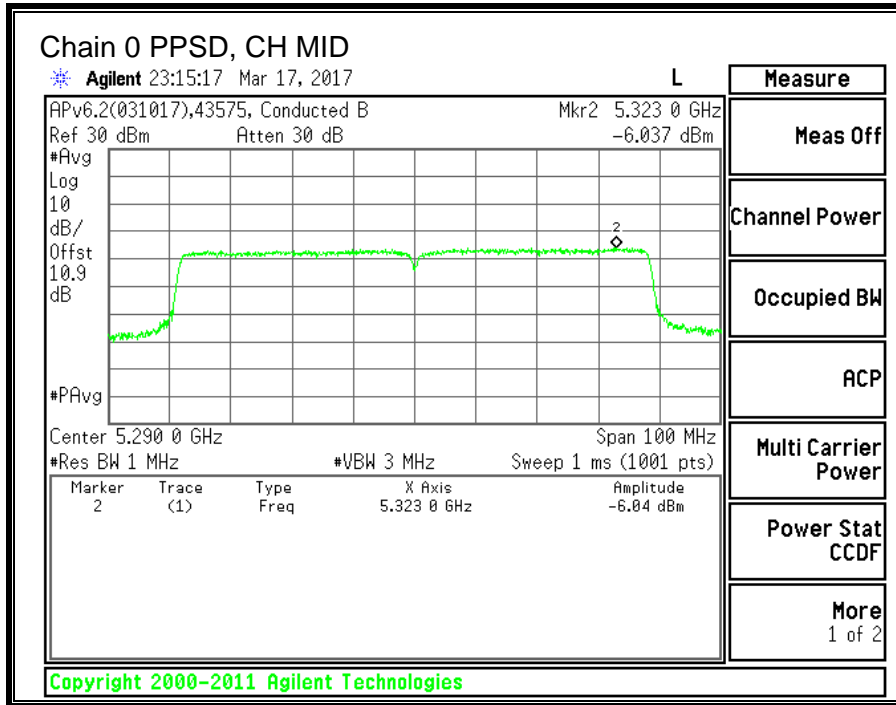

9.9. 11a 2TX CDD MIMO MODE IN THE 5.6GHz BAND

9.9.1. 26 dB BANDWIDTH

LIMITS

None; for reporting purposes only.

RESULTS

Channel	Frequency	26 dB BW Chain 0 (MHz)	26 dB BW Chain 1 (MHz)
Low	5500	23.40	23.50
Mid	5580	24.15	23.60
Mid (FCC)	5640	23.45	26.40
High	5700	23.40	23.80

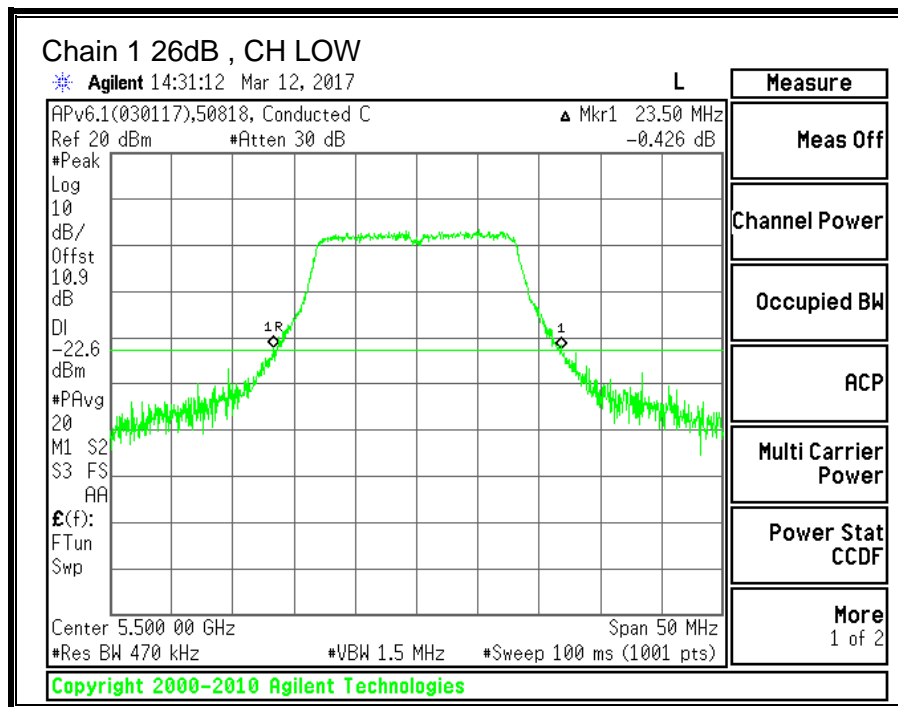
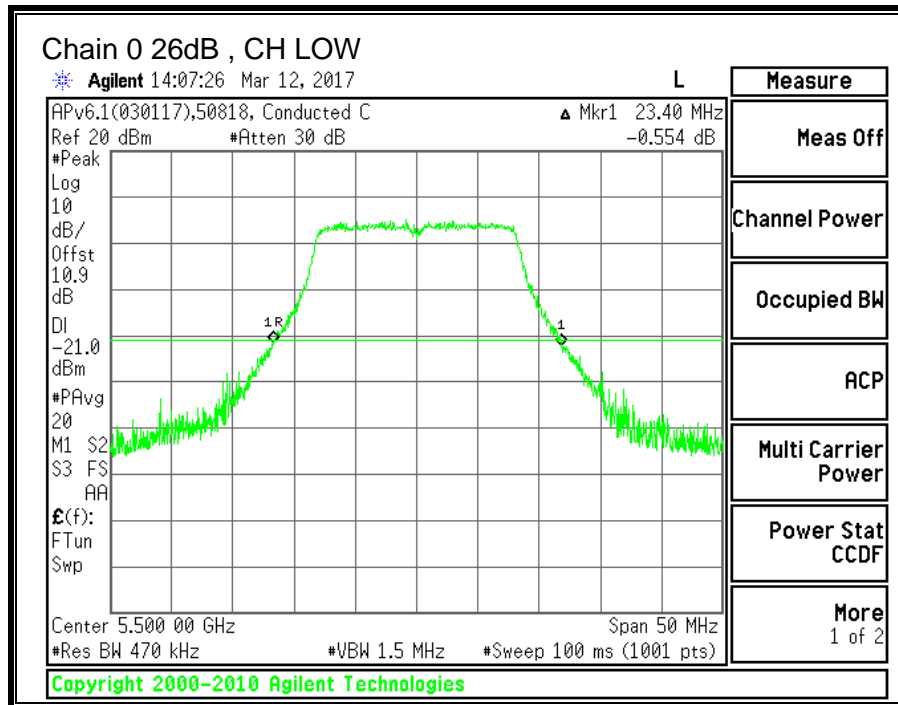

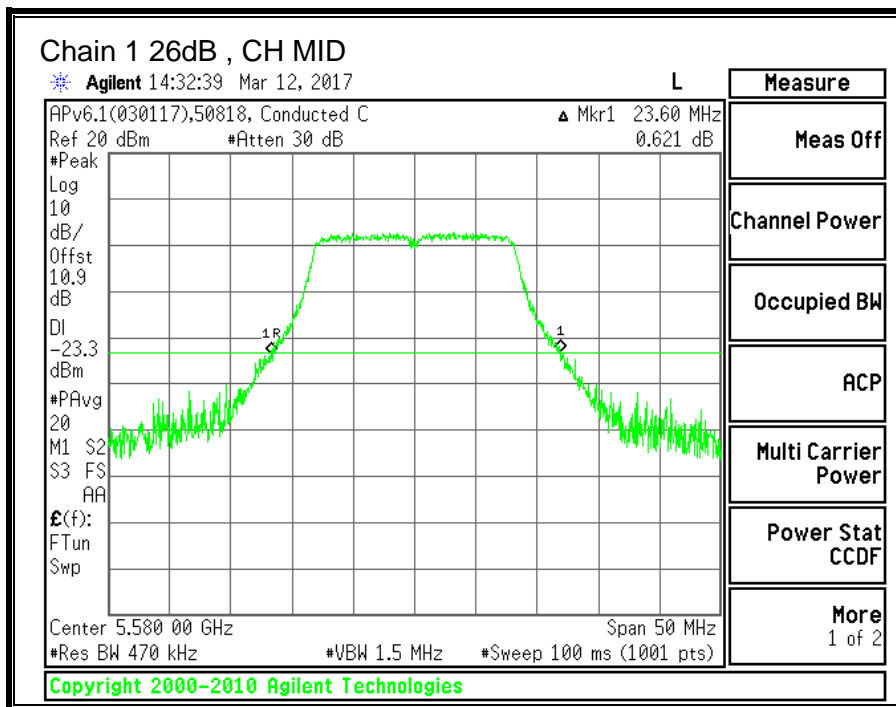
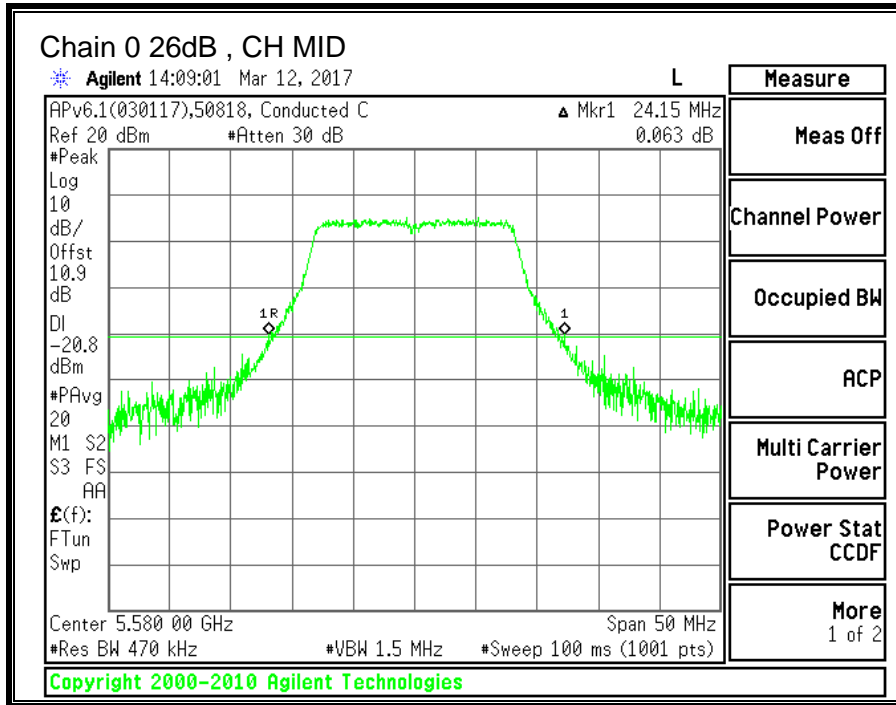

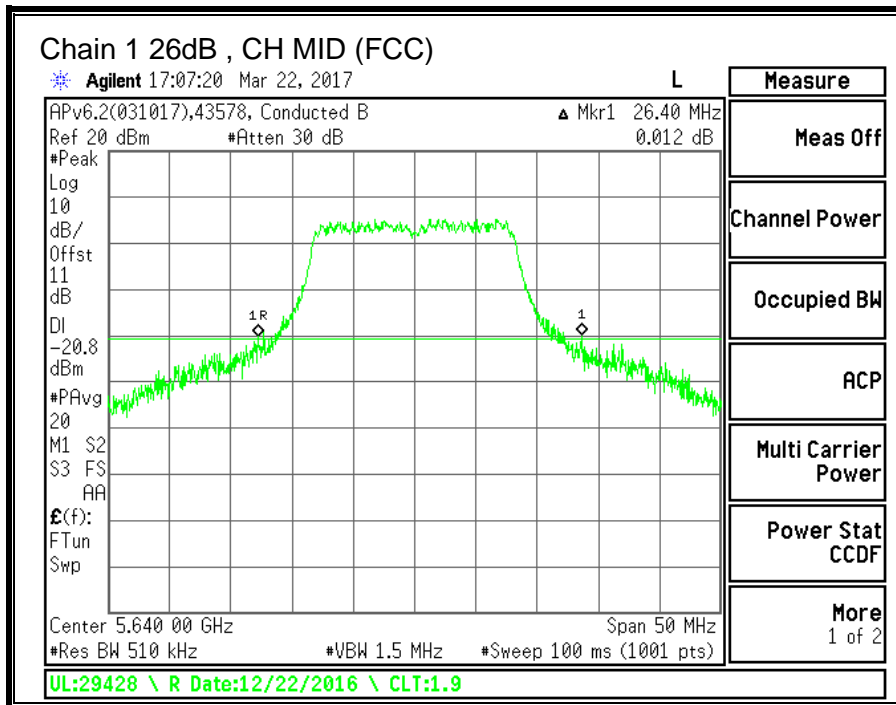
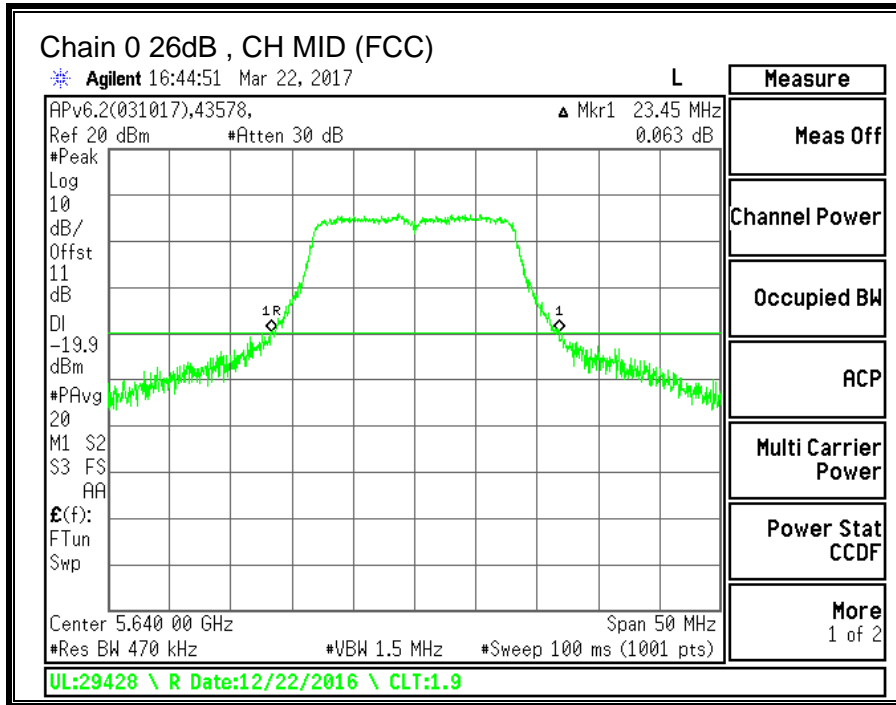

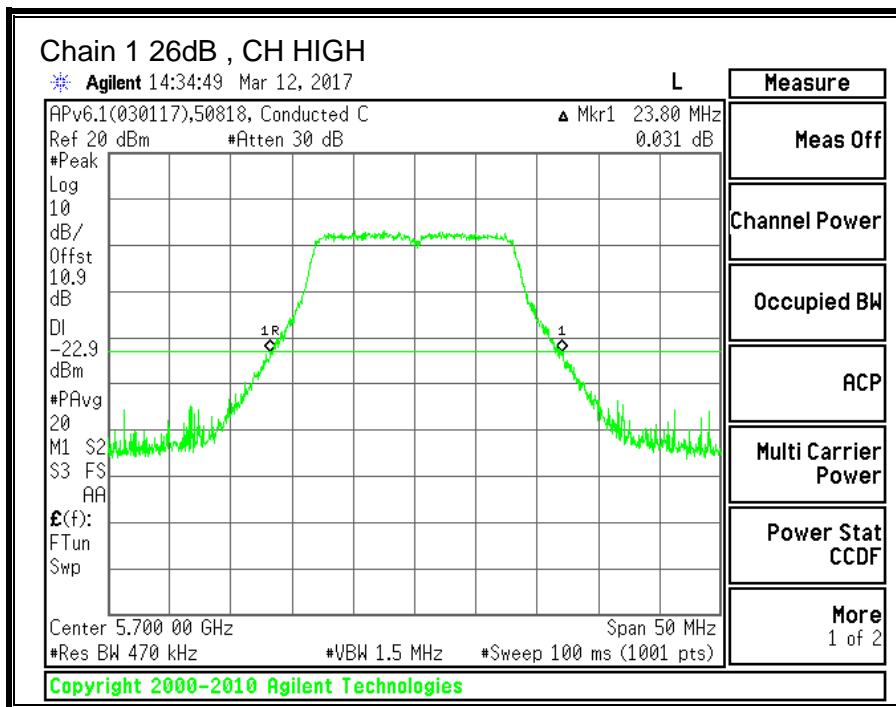
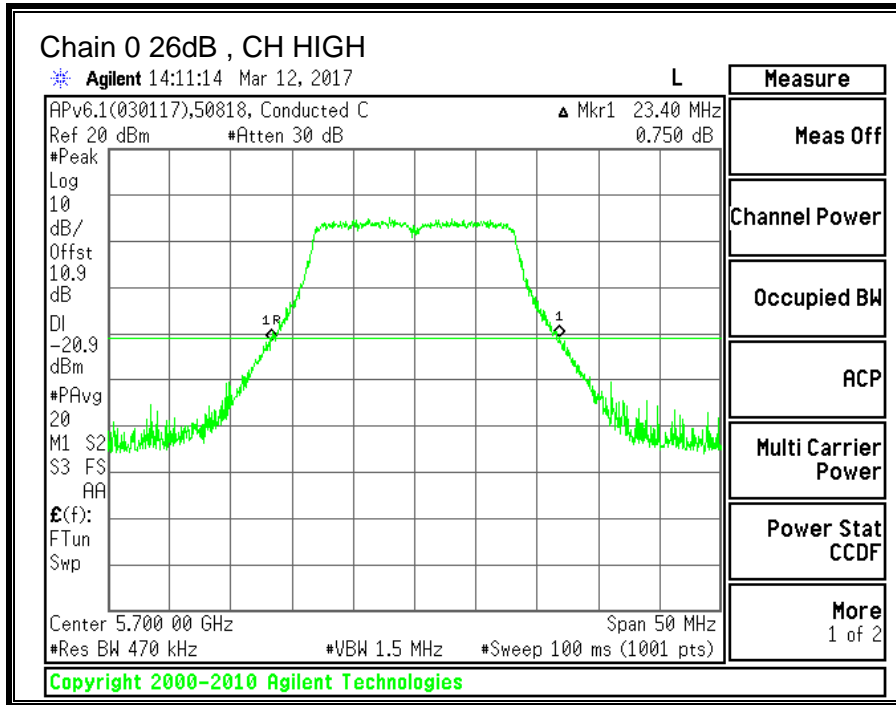

9.9.2. 99% BANDWIDTH

LIMITS

None; for reporting purposes only.

RESULTS

Channel	Frequency	99% BW Chain 0 (MHz)	99% BW Chain 1 (MHz)
Low	5500	16.4992	16.3615
Mid	5580	16.0755	16.4515
Mid (FCC)	5640	16.1919	16.4988
High	5700	16.4392	16.4250

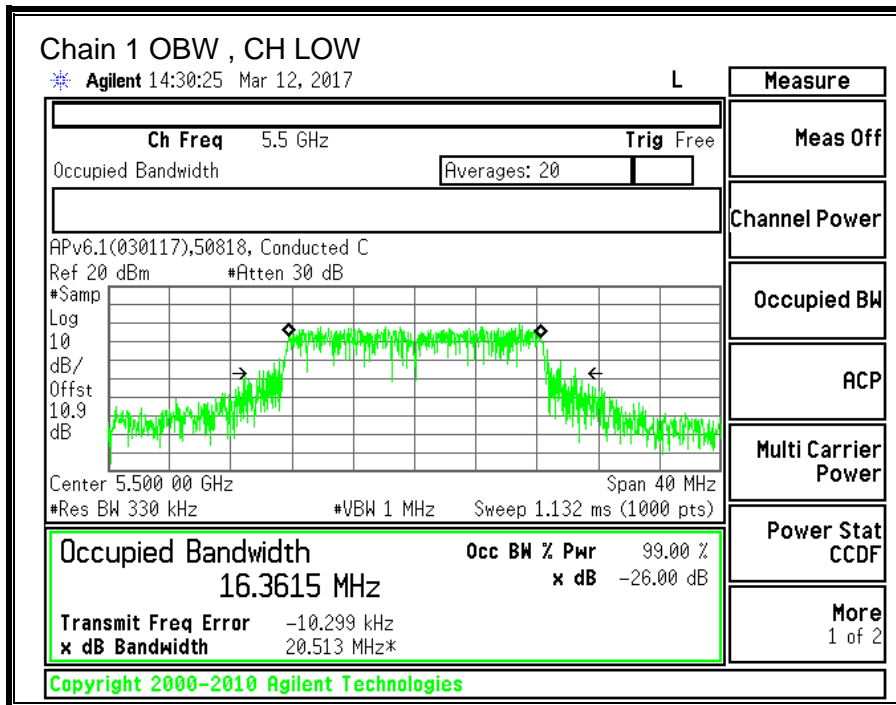
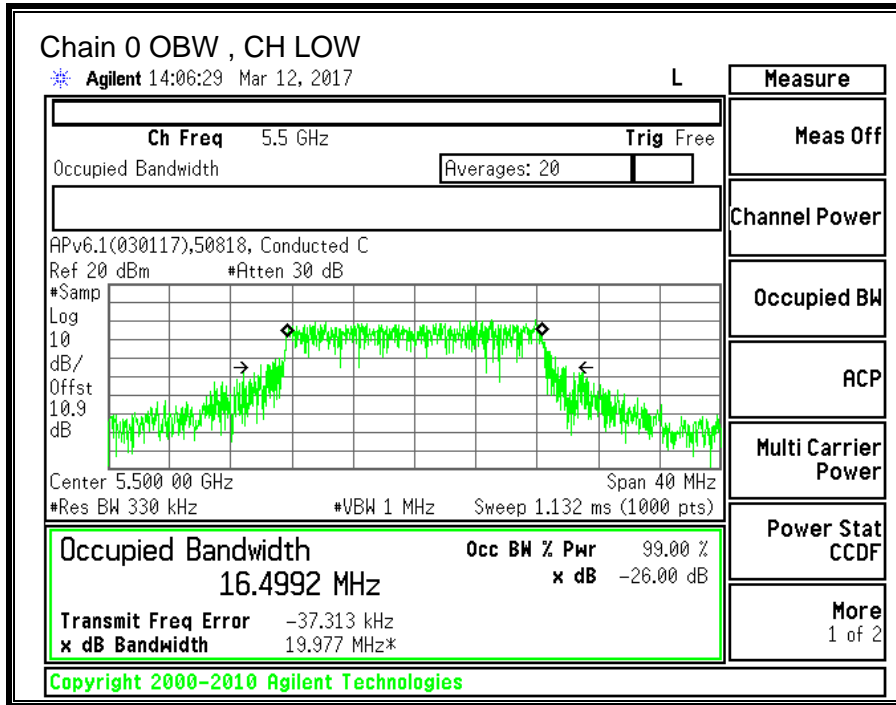

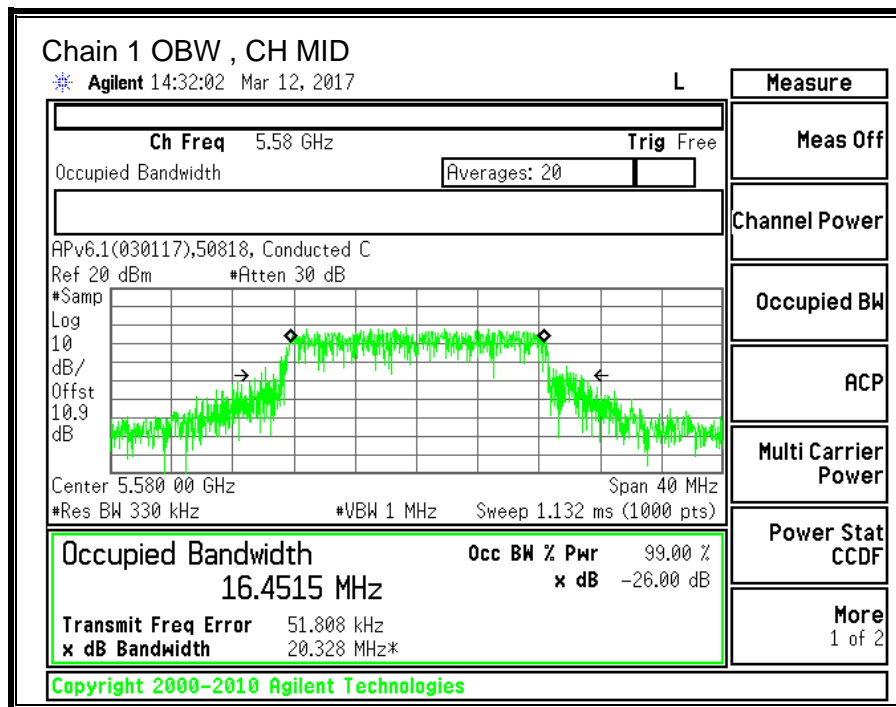
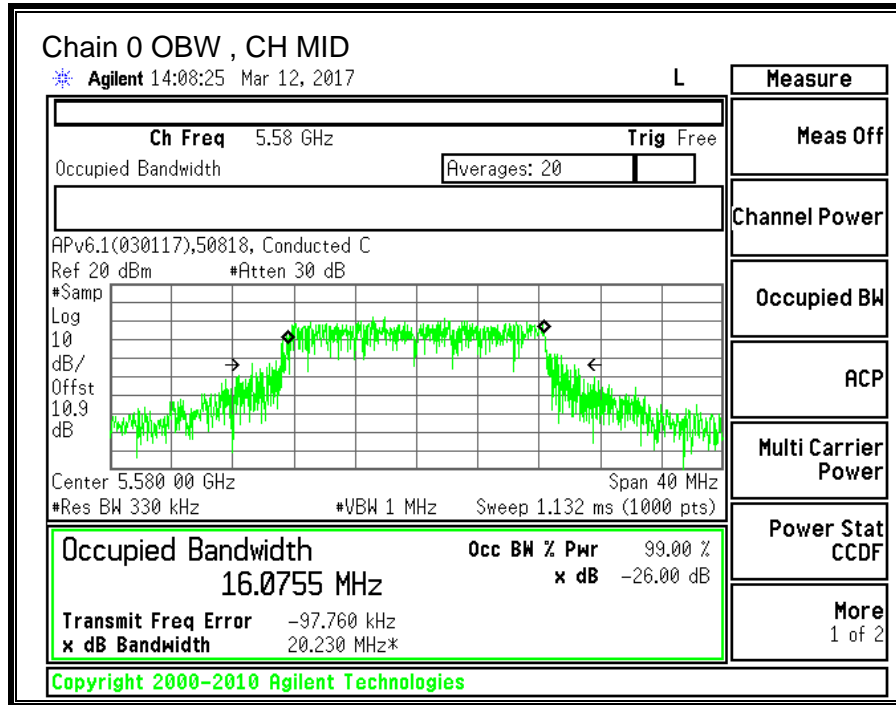

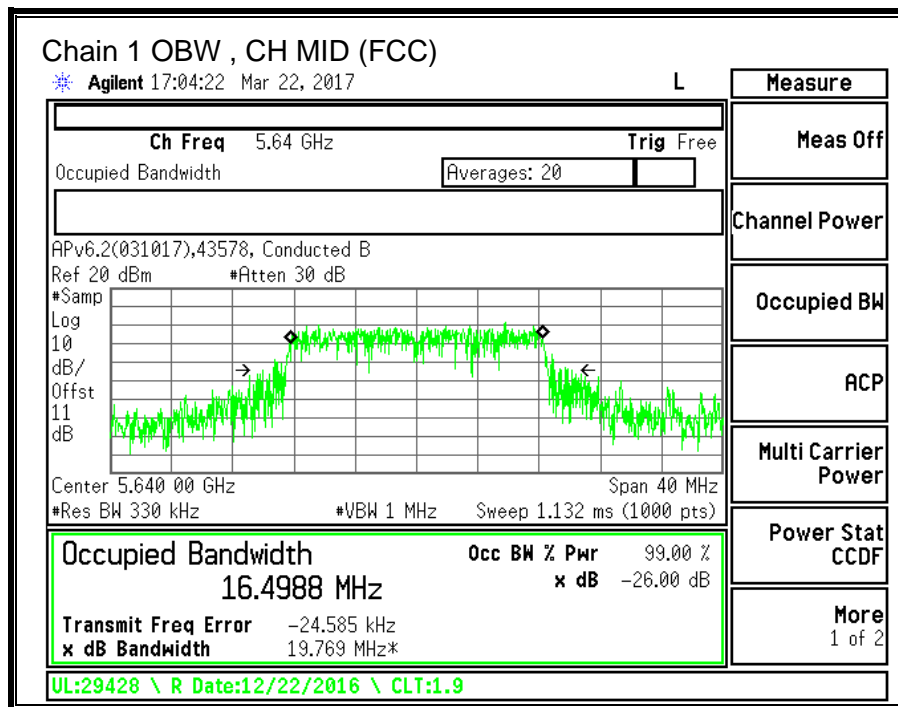
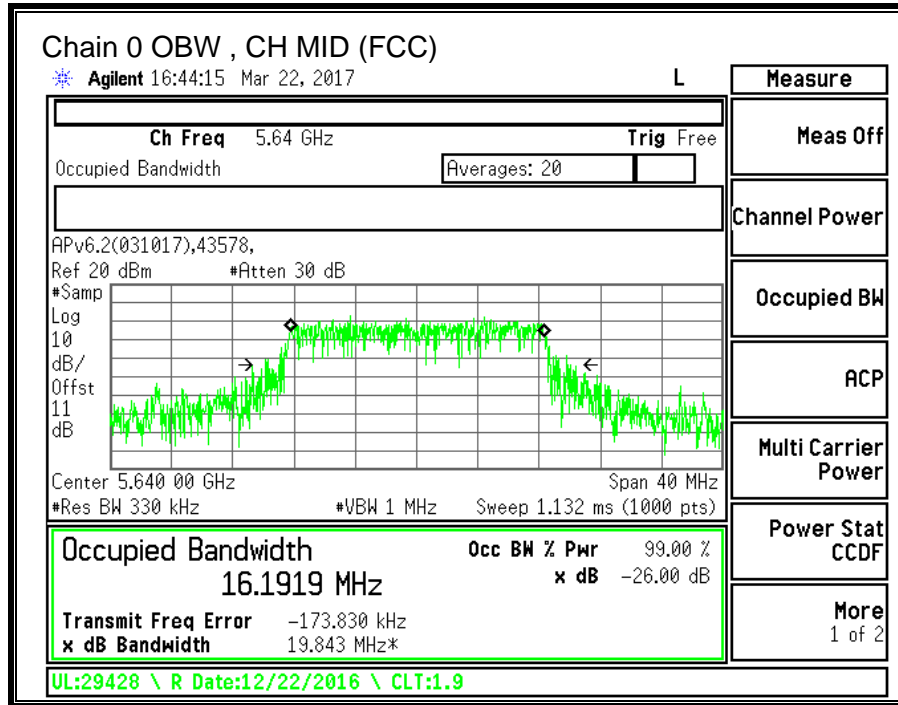

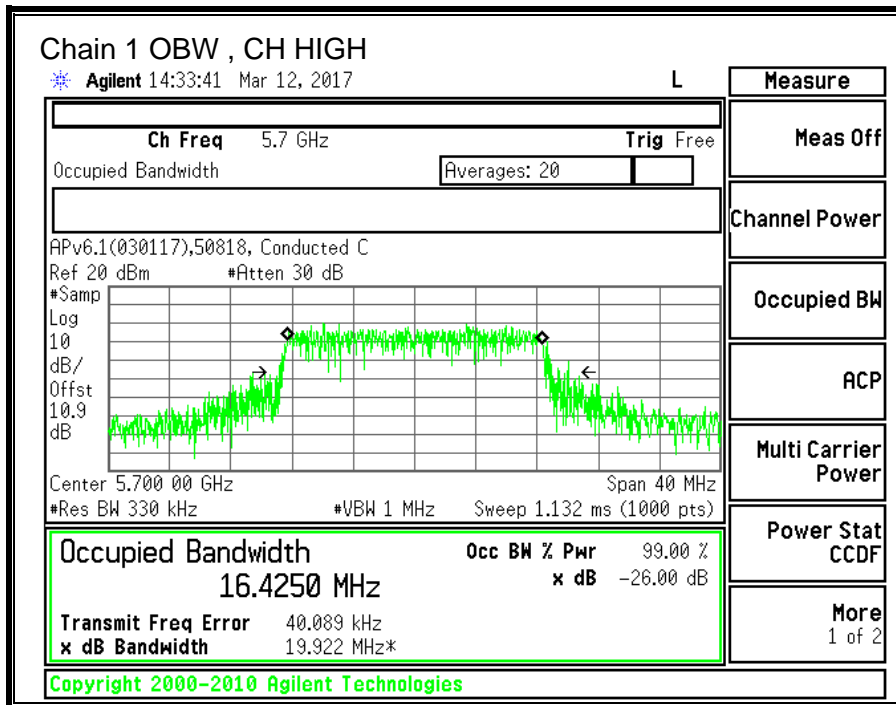
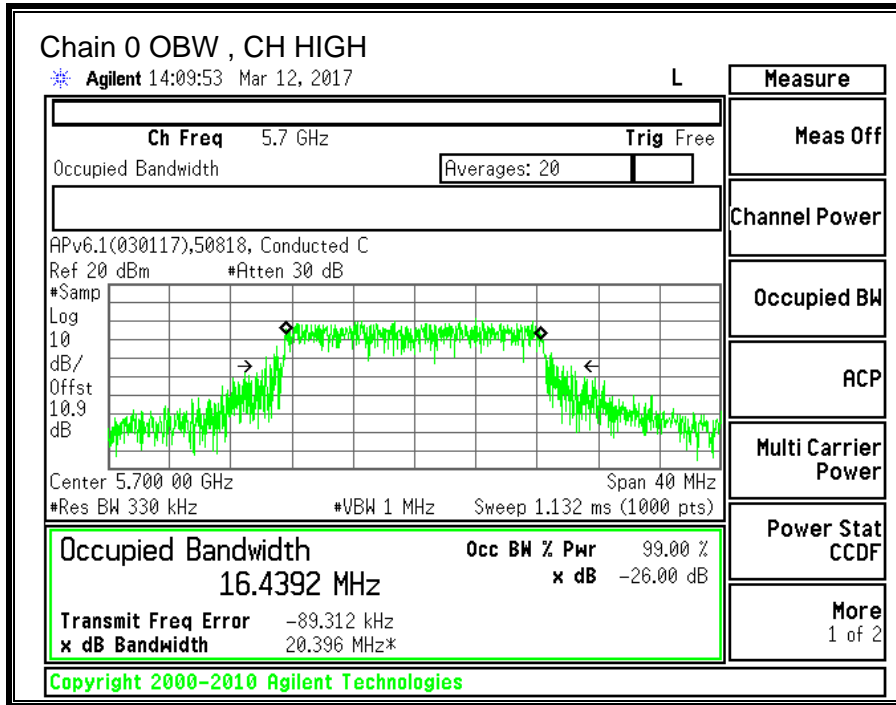

9.9.3. OUTPUT POWER AND PPSD

LIMITS

FCC §15.407 (a) (2)

For the band 5.47–5.725 GHz, the maximum conducted output power over the frequency band of operation shall not exceed the lesser of 250 mW or $11 \text{ dBm} + 10 \log B$, where B is the 26–dB emission bandwidth in MHz. In addition, the maximum power spectral density shall not exceed 11 dBm in any 1–MHz band. If transmitting antennas of directional gain greater than 6 dBi are used, both the maximum conducted output power and the peak power spectral density shall be reduced by the amount in dB that the directional gain of the antenna exceeds 6 dBi.

IC RSS-247 (6.2.3) (1)

The maximum conducted output power shall not exceed 250 mW or $11 + 10 \log_{10} B$, dBm, whichever is less. The power spectral density shall not exceed 11 dBm in any 1.0 MHz band.

The maximum e.i.r.p. shall not exceed 1.0 W or $17 + 10 \log_{10} B$, dBm, whichever is less. B is the 99% emission bandwidth in megahertz. Note that devices with a maximum e.i.r.p. greater than 500 mW shall implement TPC in order to have the capability to operate at least 6 dB below the maximum permitted e.i.r.p. of 1 W.

TEST PROCEDURE

Measurements perform using a wideband gated RF power meter provided that the gate parameters are adjusted such that the power is measured only when the EUT is transmitting at its maximum power control level. Since the measurement is made only during the ON time of the transmitter, no duty cycle correction factor is required.

Straddle channel power is measured using PXA spectrum analyzer, duty cycle correction factor is required.

DIRECTIONAL ANTENNA GAIN

For power, the TX chains are uncorrelated and the antenna gain is unequal among the chains. The directional gain is:

5470-5725 MHz

Chain 0 Antenna Gain (dBi)	Chain 1 Antenna Gain (dBi)	Uncorrelated Chains Directional Gain (dBi)
-0.40	-1.00	-0.69

For PSD the TX chains are correlated and the antenna gain is unequal among the chains. The directional gain is:

5470-5725 MHz

Chain 0 Antenna Gain (dBi)	Chain 1 Antenna Gain (dBi)	Correlated Chains Directional Gain (dBi)
-0.40	-1.00	2.32

RESULTS

ID:	43578	Date:	3/17/17
------------	-------	--------------	---------

Bandwidth and Antenna Gain

Channel	Frequency (MHz)	Min 26 dB BW (MHz)	Min 99% BW (MHz)	Directional Gain for Power (dBi)	Directional Gain for PPSD (dBi)
Low	5500	23.40	16.362	-0.69	2.32
Mid	5580	23.60	16.076	-0.69	2.32
Mid (FCC)	5640	23.45	16.192	-0.69	2.32
High	5700	23.40	16.425	-0.69	2.32

Limits

Channel	Frequency (MHz)	FCC Power Limit (dBm)	IC Power Limit (dBm)	IC EIRP Limit (dBm)	Power Limit (dBm)	FCC PPSD Limit (dBm)	IC PSD Limit (dBm)	PPSD Limit (dBm)
Low	5500	24.00	23.14	29.14	23.14	11.00	11.00	11.00
Mid	5580	24.00	23.06	29.06	23.06	11.00	11.00	11.00
Mid (FCC)	5640	24.00	23.09	29.09	23.09	11.00	11.00	11.00
High	5700	24.00	23.16	29.16	23.16	11.00	11.00	11.00

Duty Cycle CF (dB)	0.24	Included in Calculations of Corr'd PPSD
---------------------------	------	--

Output Power Results

Channel	Frequency (MHz)	Chain 0 Meas Power (dBm)	Chain 1 Meas Power (dBm)	Total Corr'd Power (dBm)	Power Limit (dBm)	Power Margin (dB)
Low	5500	12.69	10.84	14.87	23.14	-8.27
Mid	5580	12.70	11.25	15.05	23.06	-8.02
Mid (FCC)	5640	12.63	11.23	15.00	23.09	-8.10
High	5700	12.84	11.20	15.11	23.16	-8.05

PPSD Results

Channel	Frequency (MHz)	Chain 0 Meas PPSD (dBm)	Chain 1 Meas PPSD (dBm)	Total Corr'd PPSD (dBm)	PPSD Limit (dBm)	PPSD Margin (dB)
Low	5500	1.424	-0.531	3.81	11.00	-7.19
Mid	5580	1.497	-0.279	3.95	11.00	-7.05
Mid (FCC)	5640	1.651	-0.383	4.00	11.00	-7.00
High	5700	1.469	0.009	4.05	11.00	-6.95

Note: the power readings above were measured with gated method, and the measurement was taken only during the ON time. No duty cycle correction was necessary.

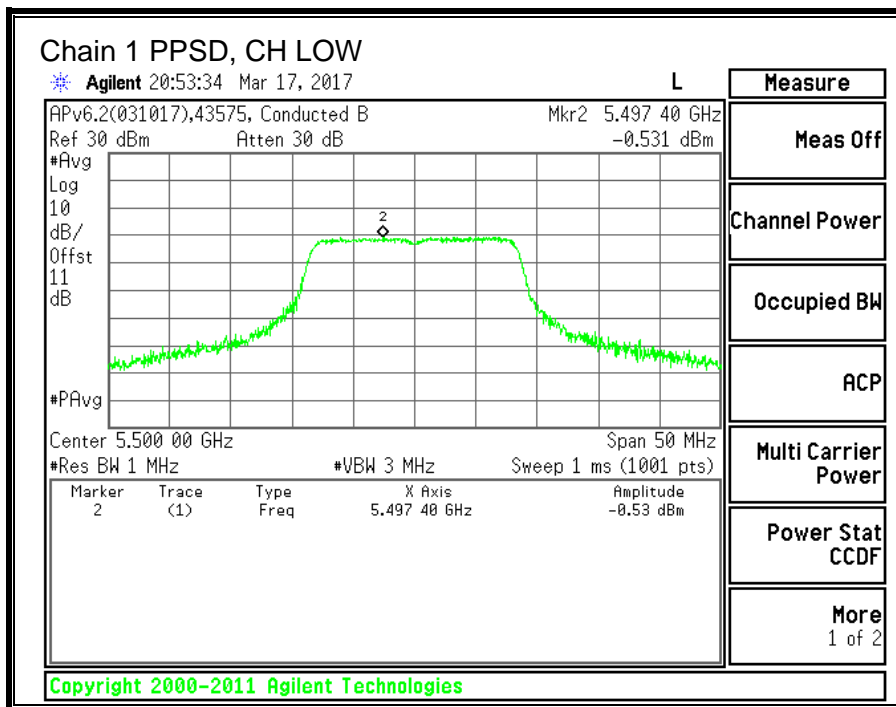
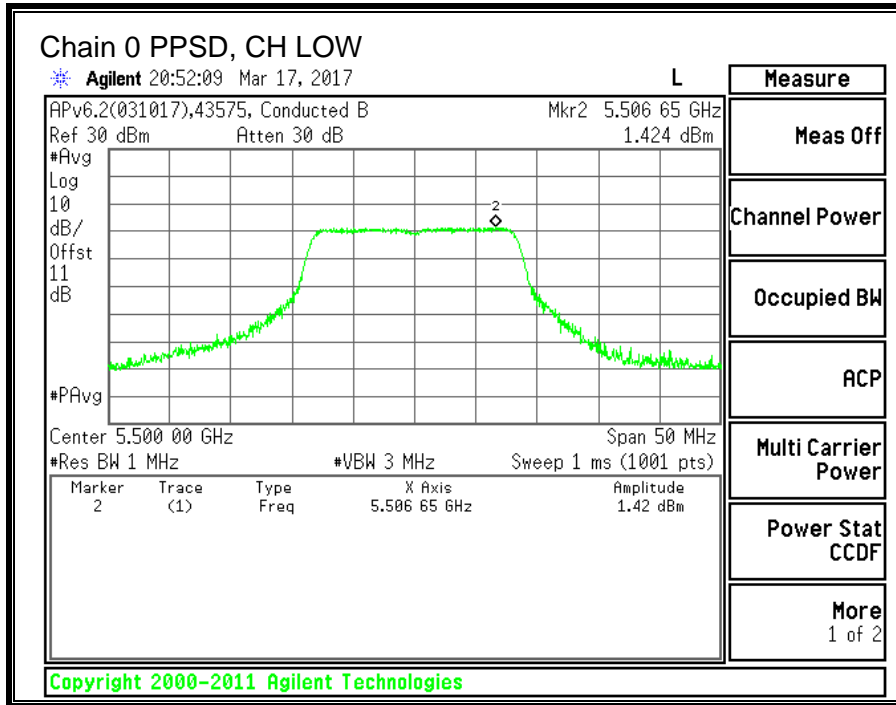

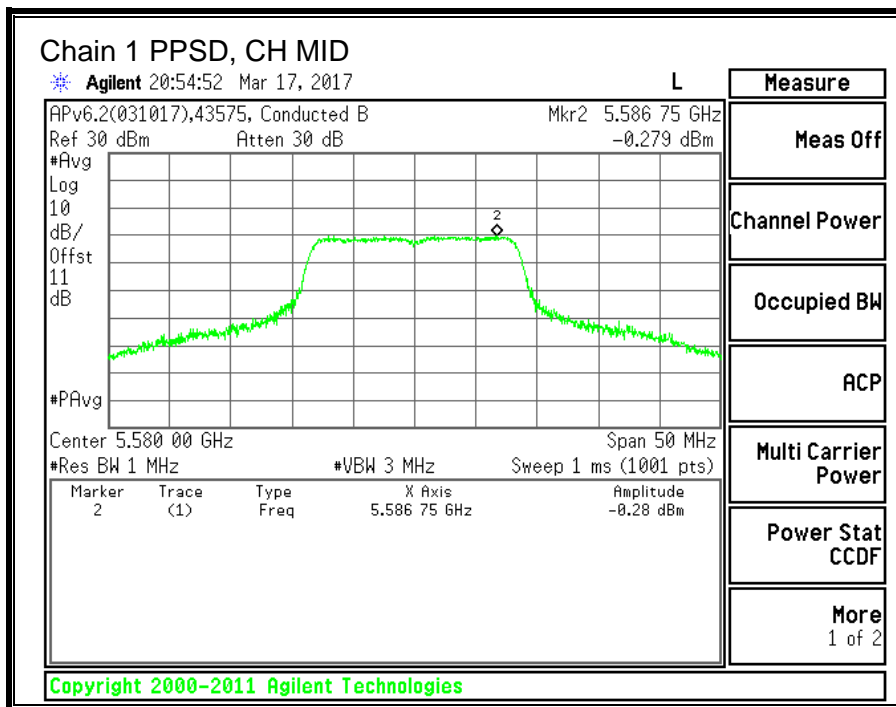
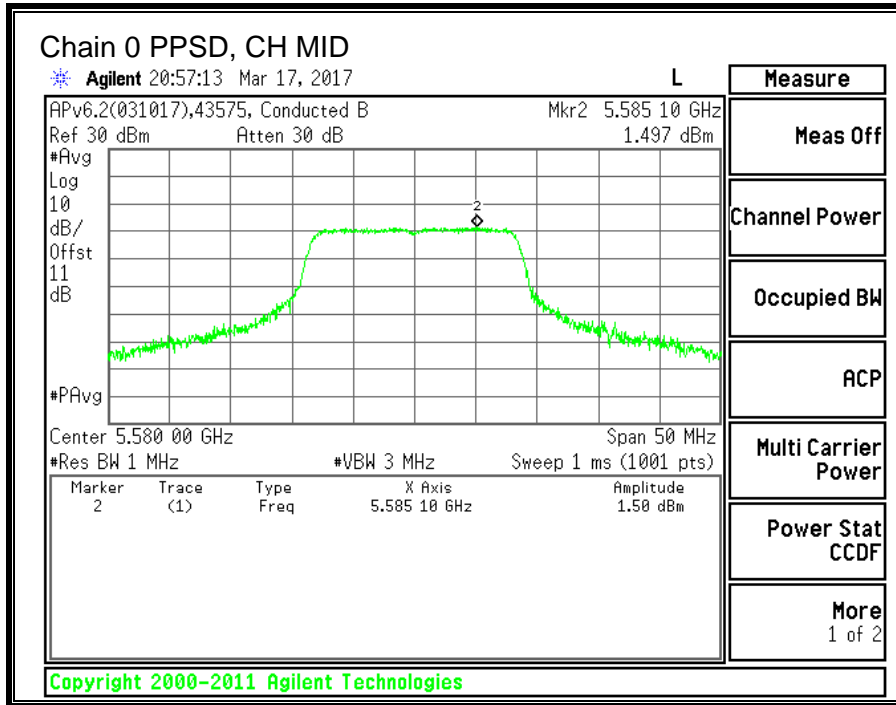

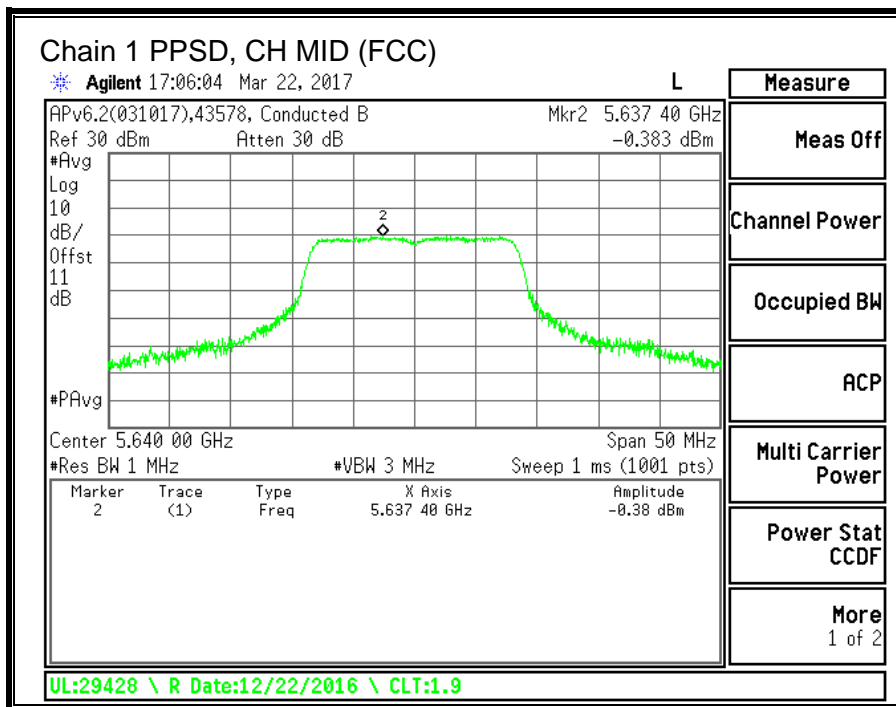
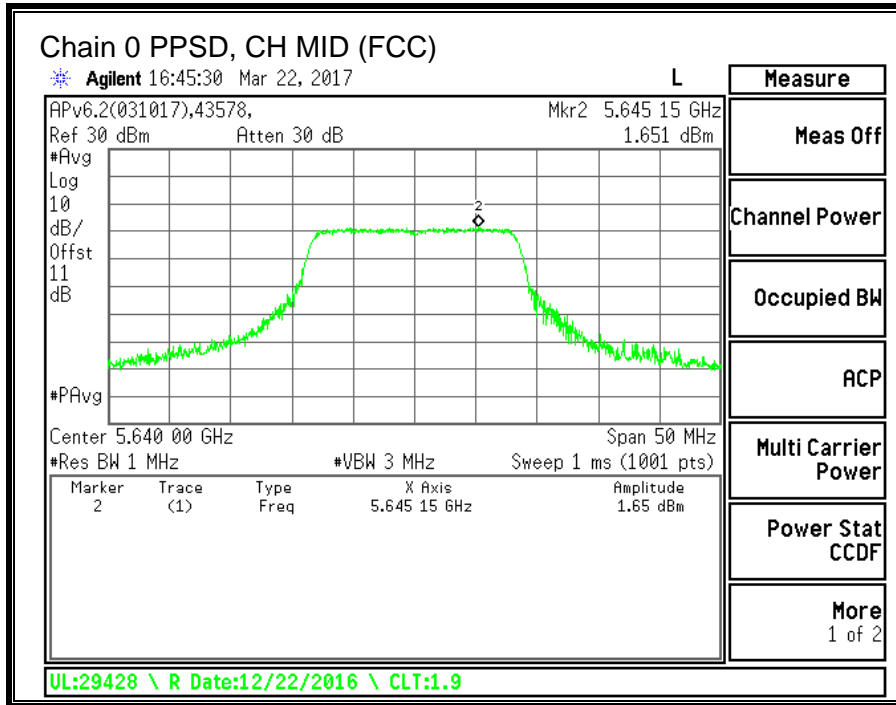

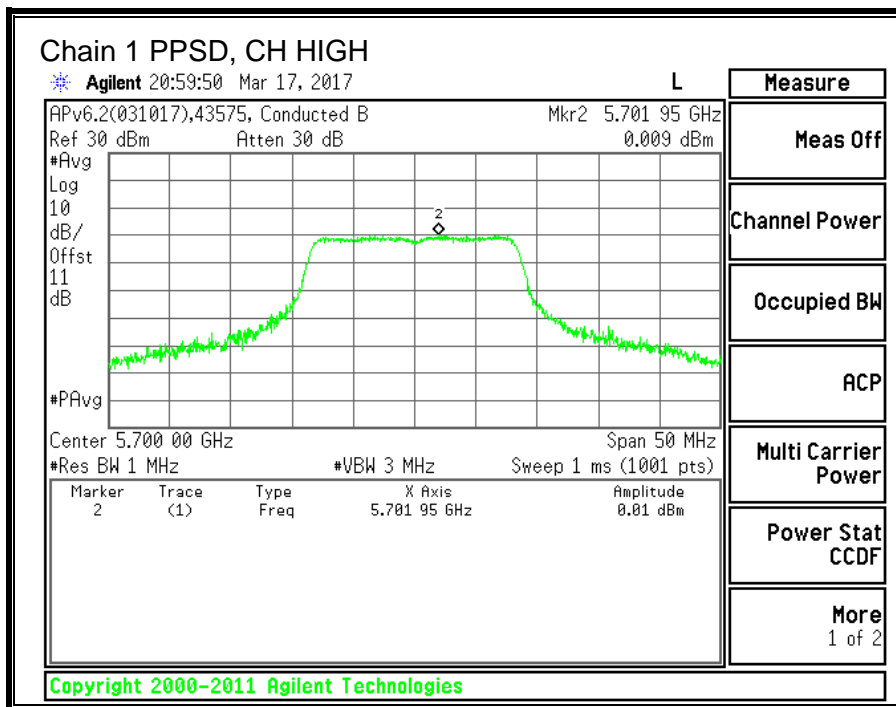
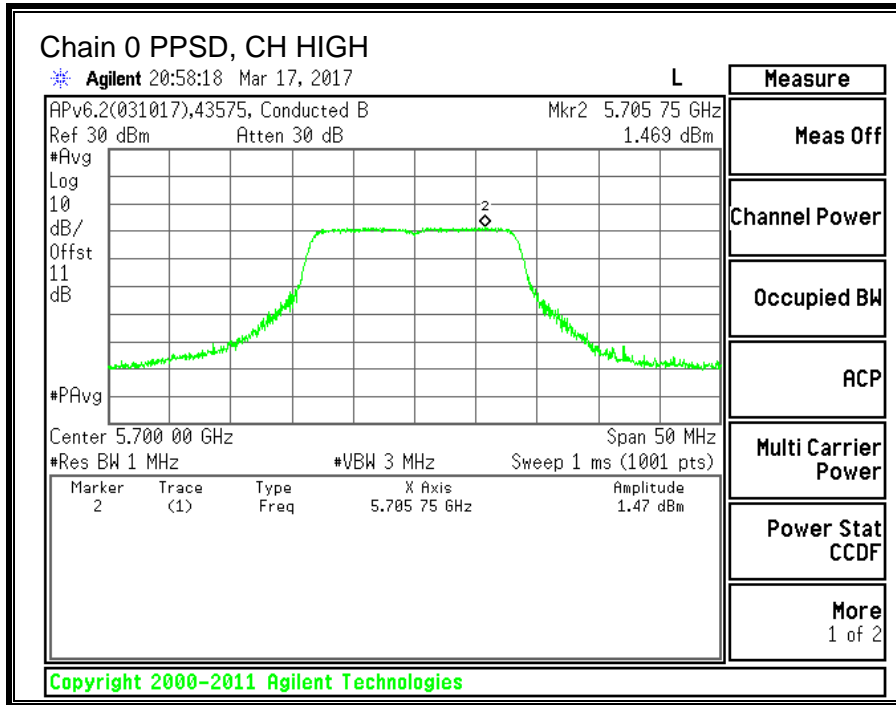

9.10. 11n HT20 2TX CDD MIMO MODE IN THE 5.6GHz BAND

9.10.1. 26 dB BANDWIDTH

LIMITS

None; for reporting purposes only.

RESULTS

Channel	Frequency	26 dB BW Chain 0 (MHz)	26 dB BW Chain 1 (MHz)
Low	5500	24.50	25.85
Mid	5580	24.35	24.50
Mid (FCC)	5640	24.70	24.30
High	5700	24.45	24.50

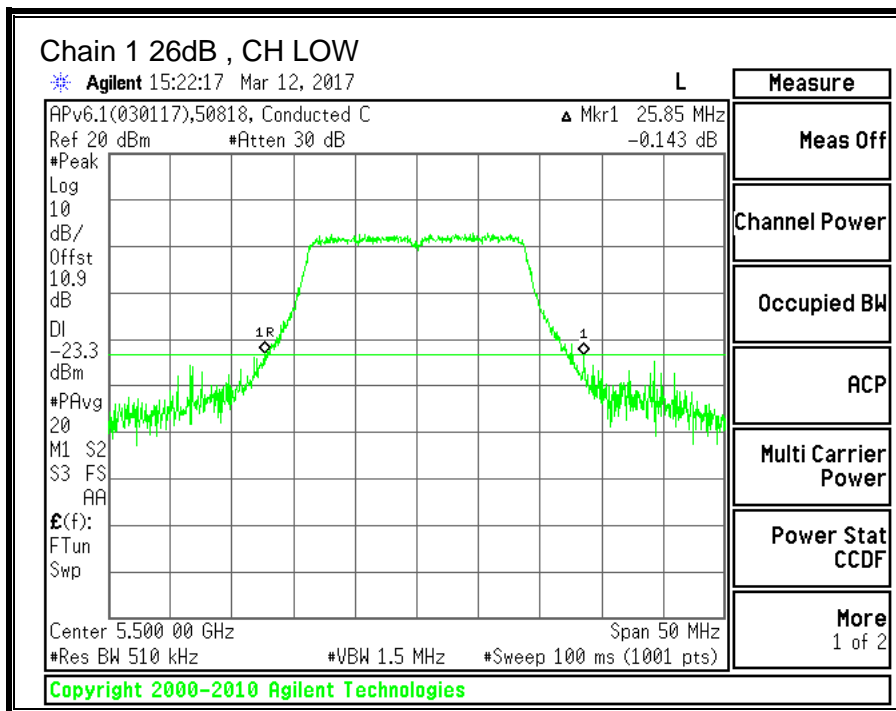
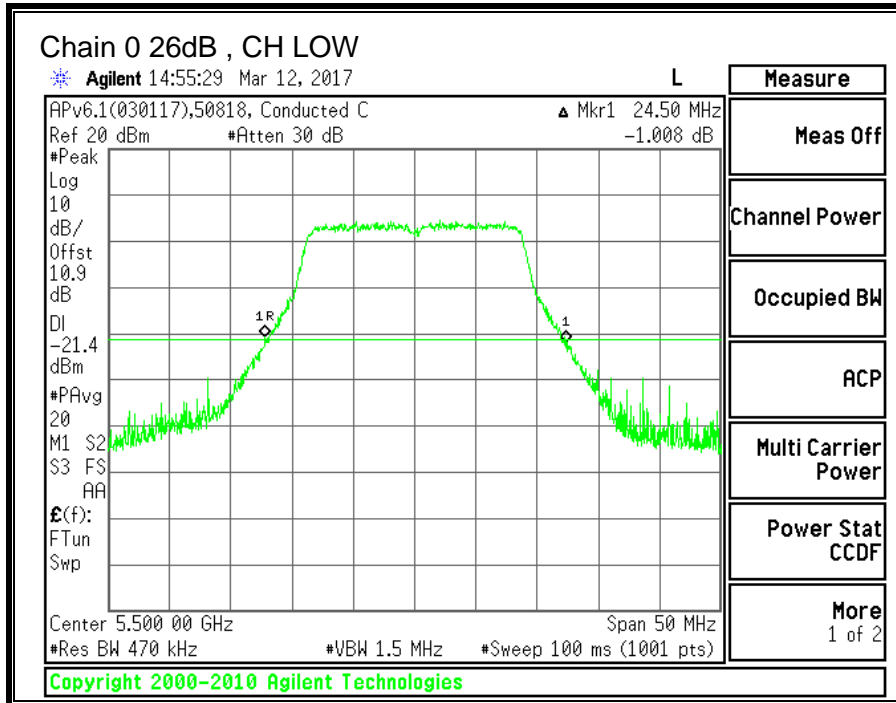

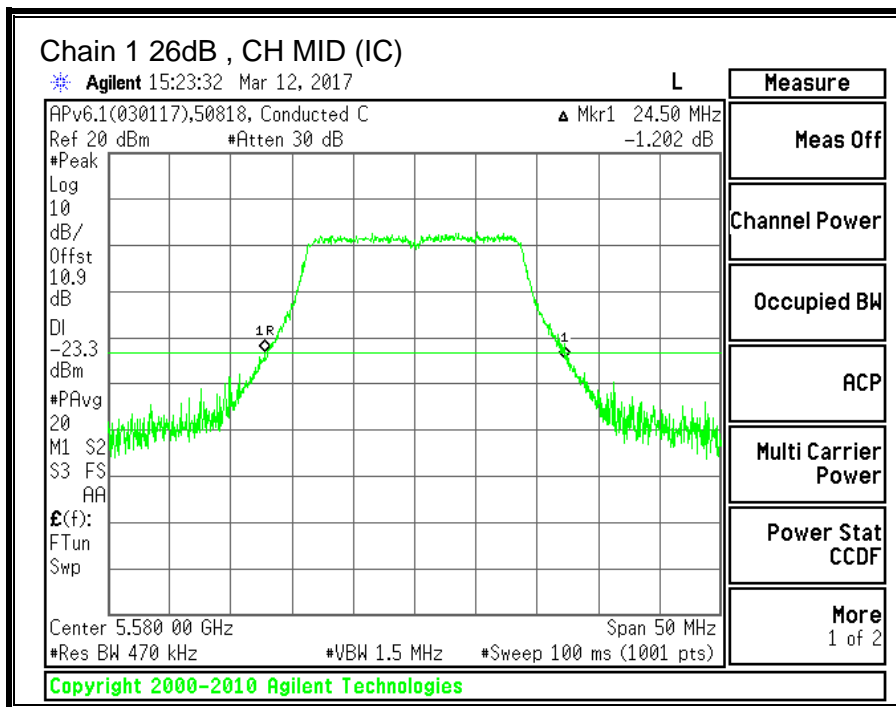
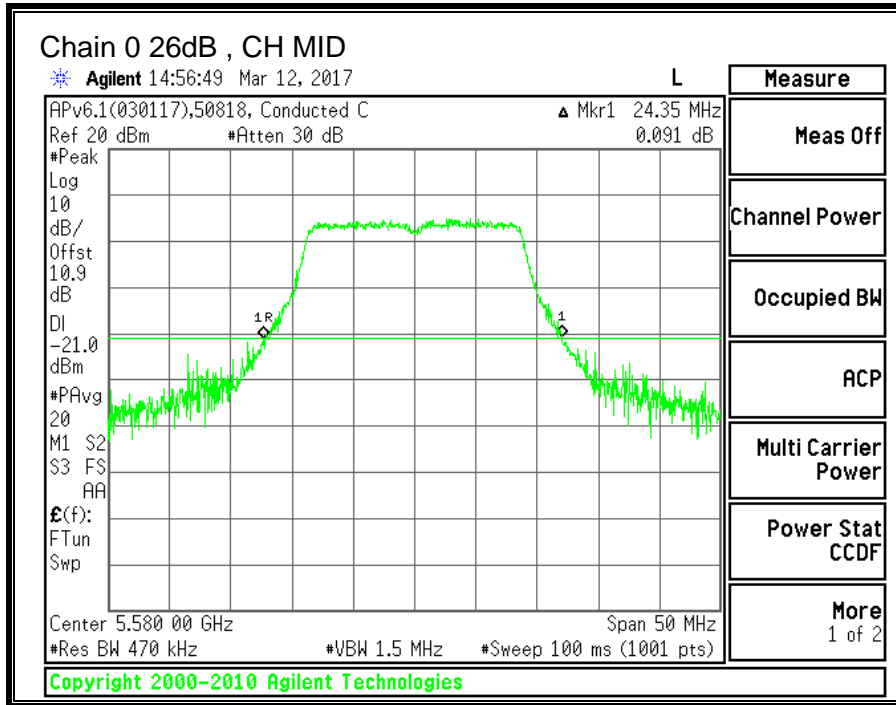

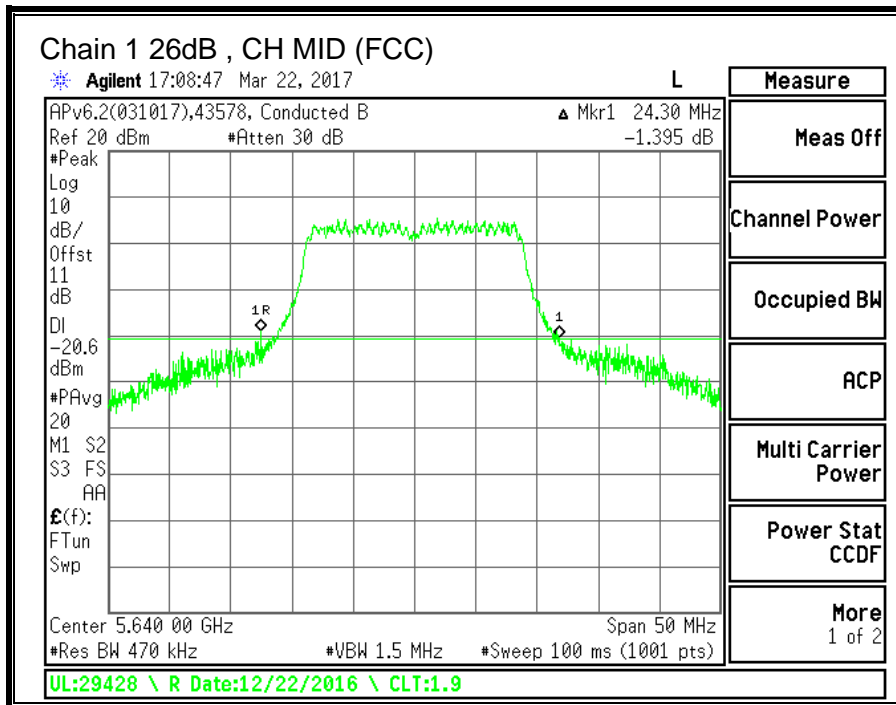
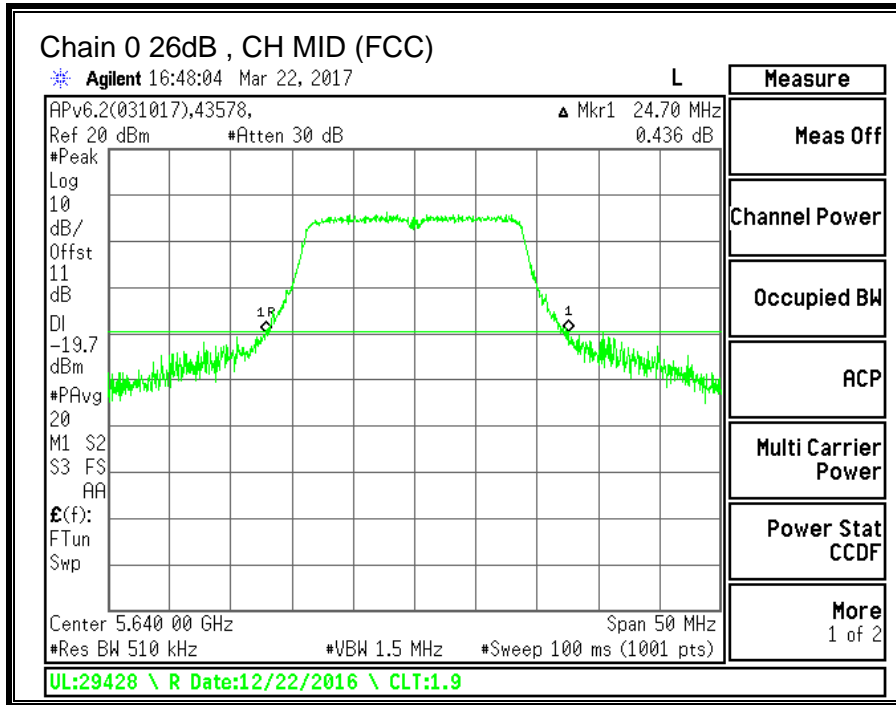

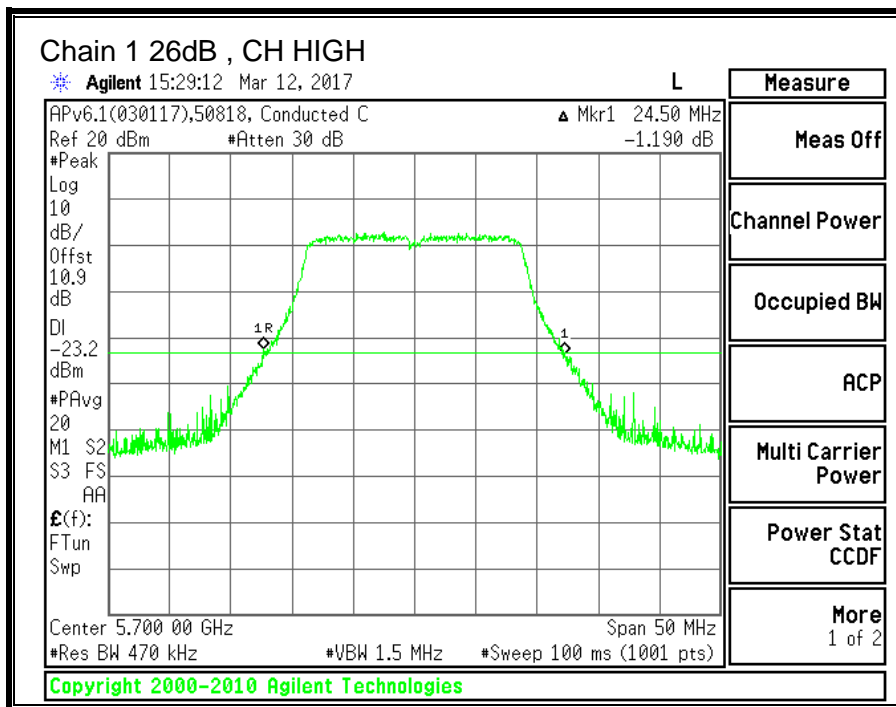
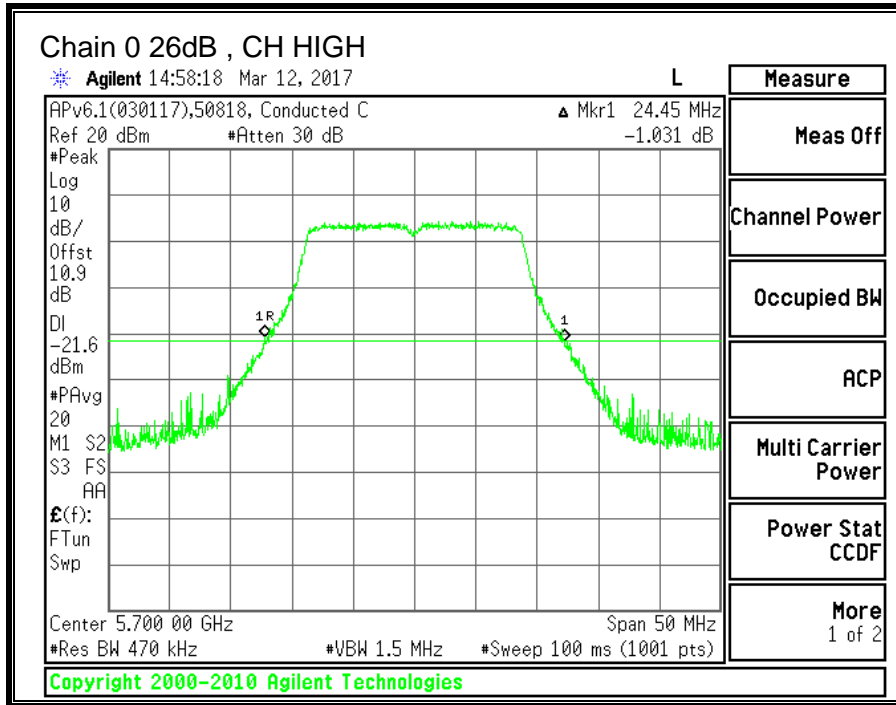

9.10.2. 99% BANDWIDTH

LIMITS

None; for reporting purposes only.

RESULTS

Channel	Frequency	99% BW Chain 0 (MHz)	99% BW Chain 1 (MHz)
Low	5500	17.7746	17.7871
Mid	5580	17.5603	17.7867
Mid (FCC)	5640	17.4313	17.5576
High	5700	17.7285	17.7784

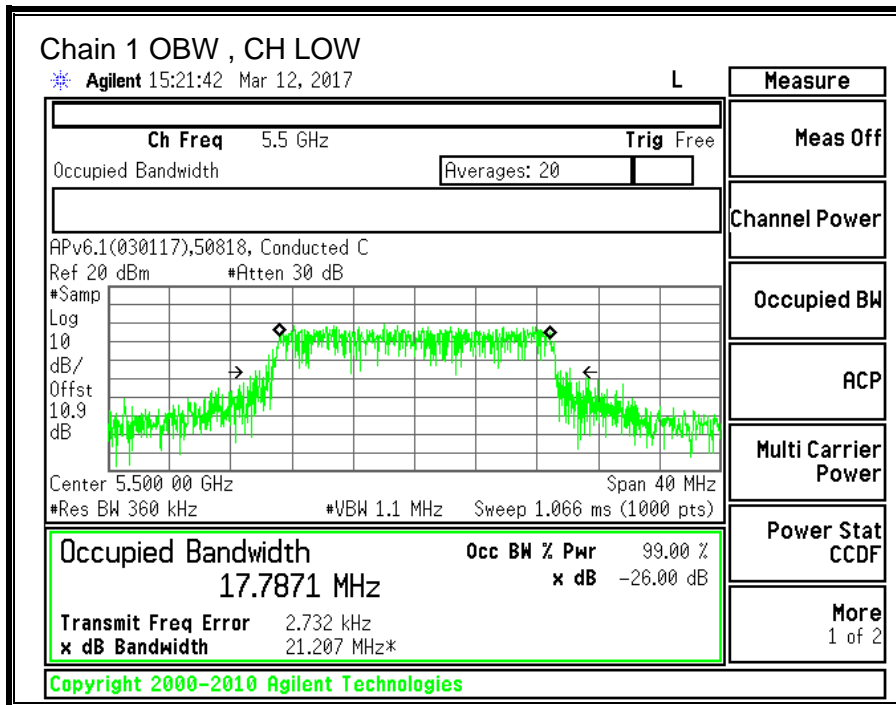
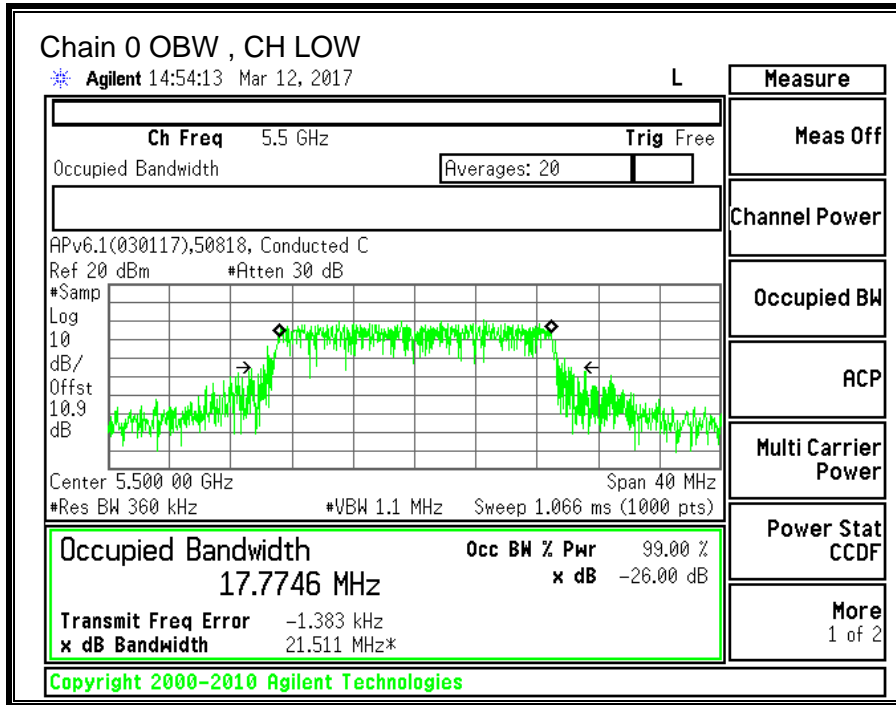

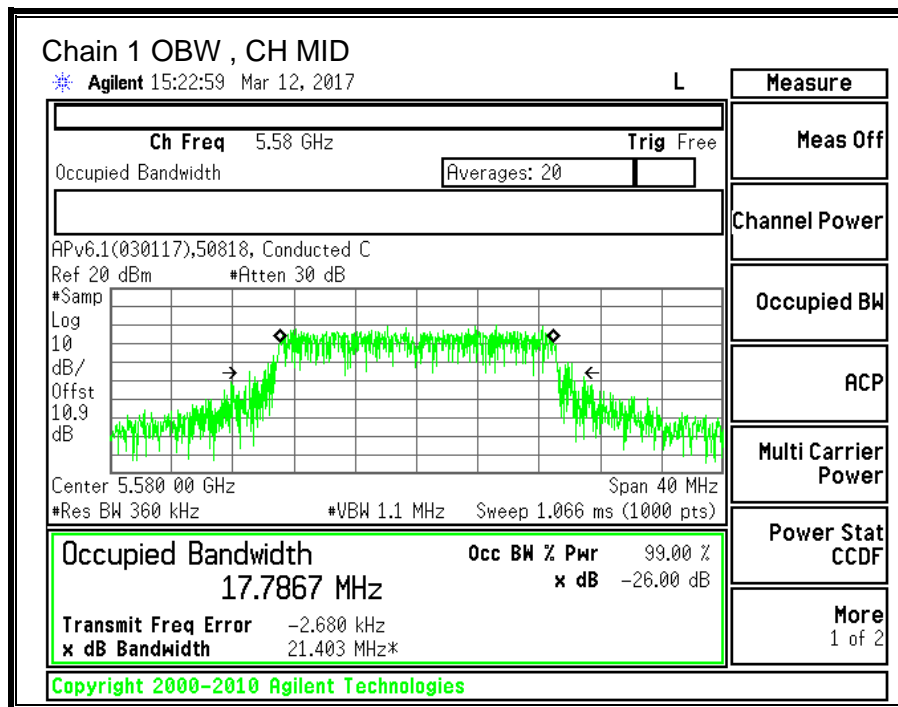
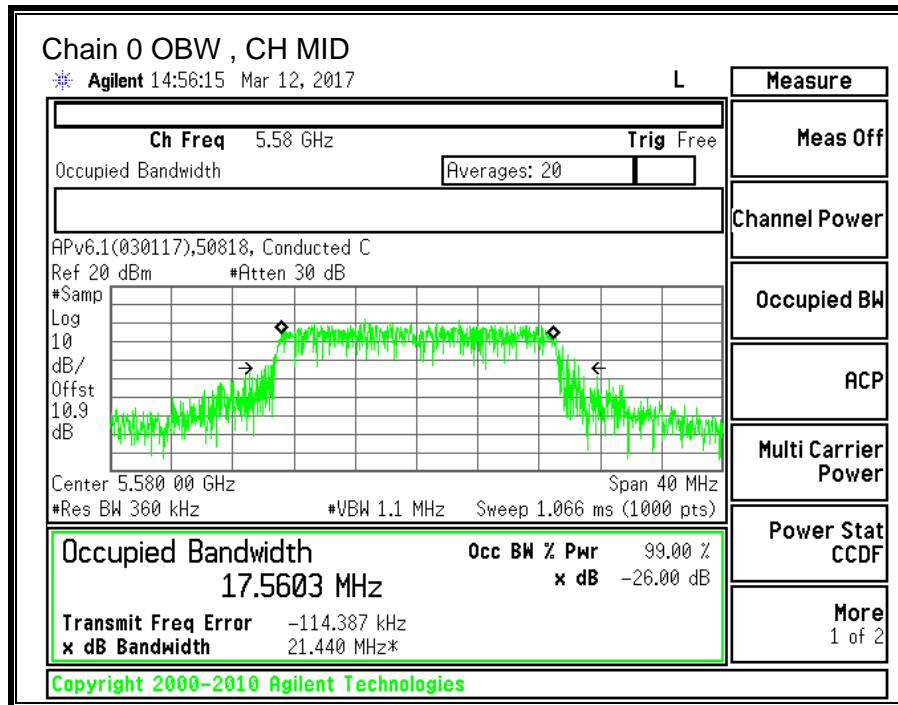

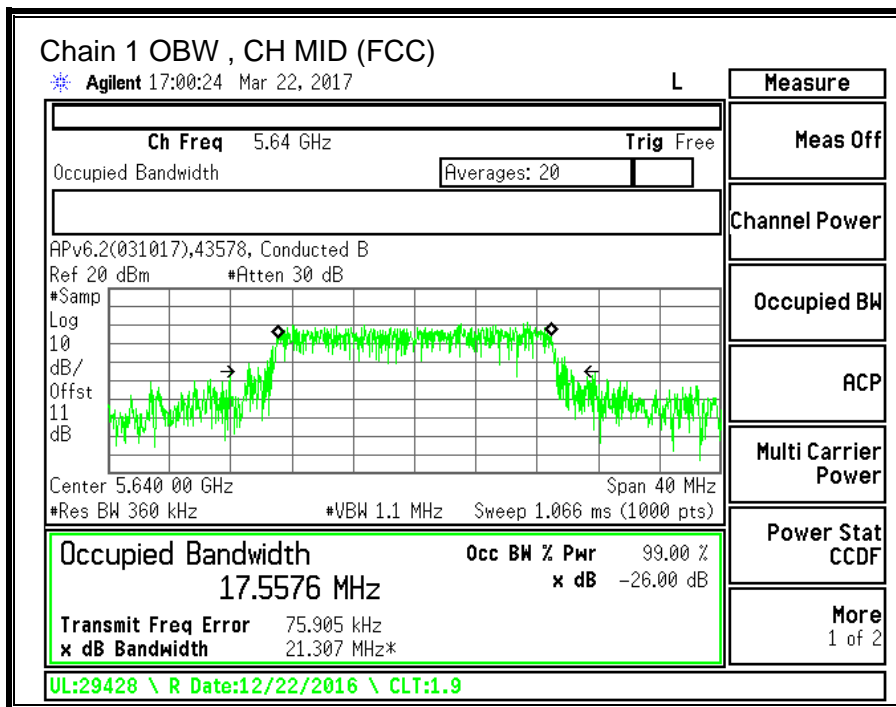
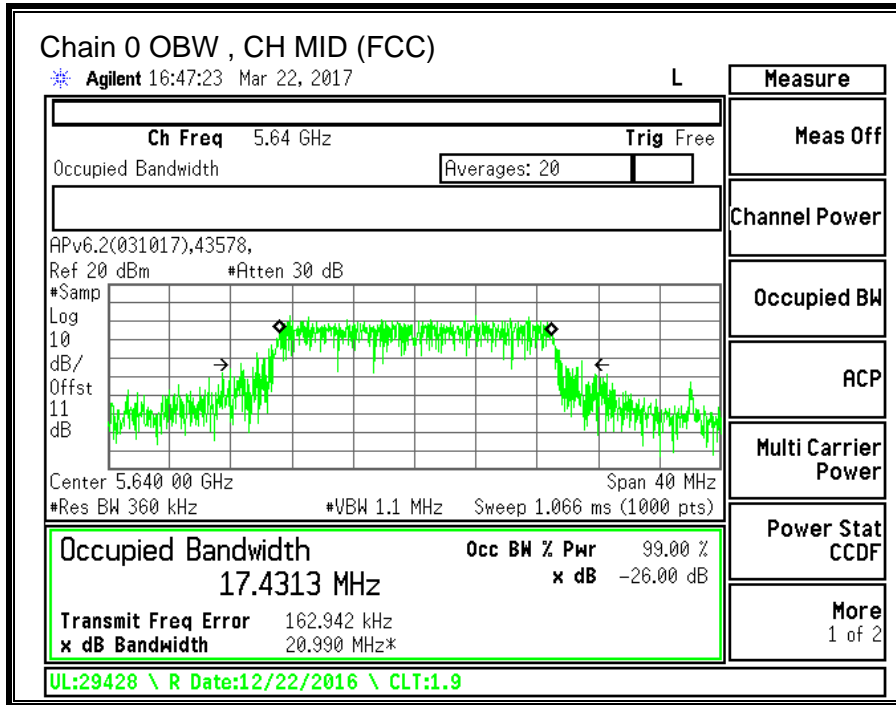

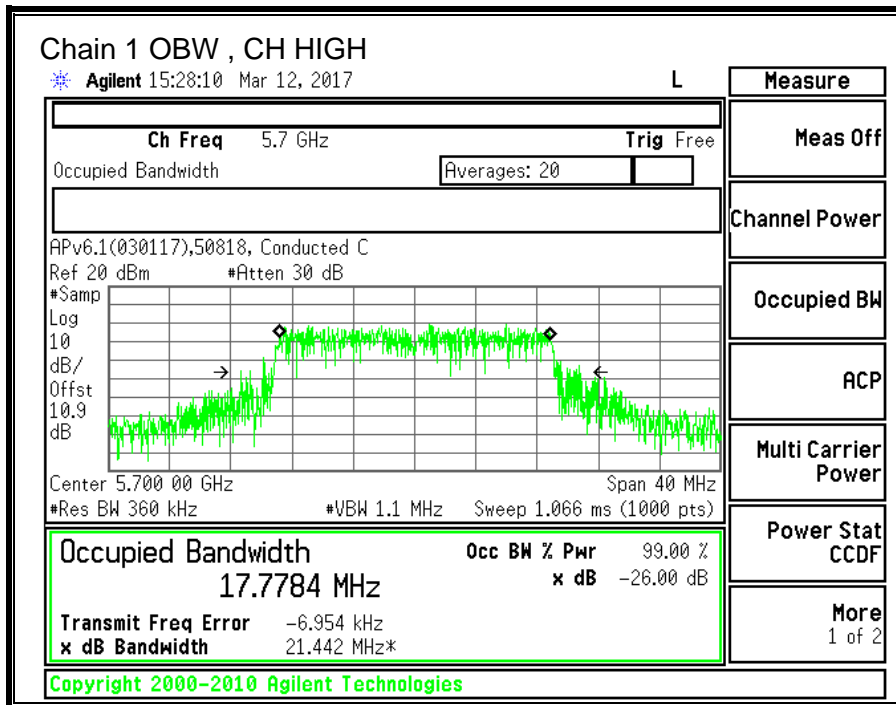
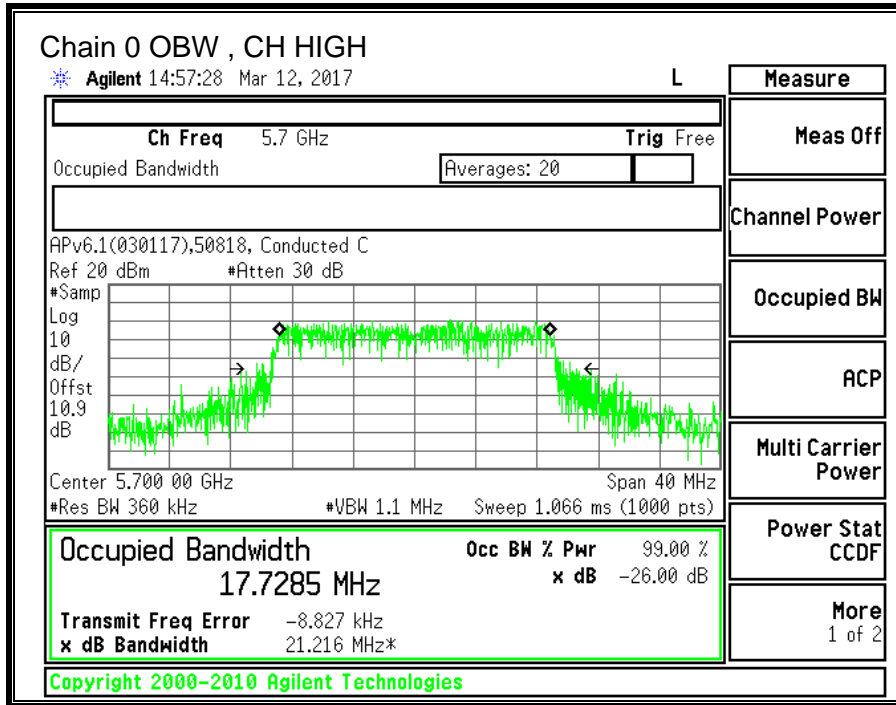

9.10.3. OUTPUT POWER AND PPSD

LIMITS

FCC §15.407 (a) (2)

For the band 5.47–5.725 GHz, the maximum conducted output power over the frequency band of operation shall not exceed the lesser of 250 mW or $11 \text{ dBm} + 10 \log B$, where B is the 26–dB emission bandwidth in MHz. In addition, the maximum power spectral density shall not exceed 11 dBm in any 1–MHz band. If transmitting antennas of directional gain greater than 6 dBi are used, both the maximum conducted output power and the peak power spectral density shall be reduced by the amount in dB that the directional gain of the antenna exceeds 6 dBi.

IC RSS-247 (6.2.3) (1)

The maximum conducted output power shall not exceed 250 mW or $11 + 10 \log_{10} B$, dBm, whichever is less. The power spectral density shall not exceed 11 dBm in any 1.0 MHz band.

The maximum e.i.r.p. shall not exceed 1.0 W or $17 + 10 \log_{10} B$, dBm, whichever is less. B is the 99% emission bandwidth in megahertz. Note that devices with a maximum e.i.r.p. greater than 500 mW shall implement TPC in order to have the capability to operate at least 6 dB below the maximum permitted e.i.r.p. of 1 W.

TEST PROCEDURE

Measurements perform using a wideband gated RF power meter provided that the gate parameters are adjusted such that the power is measured only when the EUT is transmitting at its maximum power control level. Since the measurement is made only during the ON time of the transmitter, no duty cycle correction factor is required.

Straddle channel power is measured using PXA spectrum analyzer, duty cycle correction factor is required.

DIRECTIONAL ANTENNA GAIN

For power, the TX chains are uncorrelated and the antenna gain is unequal among the chains. The directional gain is:

5470-5725 MHz

Chain 0 Antenna Gain (dBi)	Chain 1 Antenna Gain (dBi)	Uncorrelated Chains Directional Gain (dBi)
-0.40	-1.00	-0.69

For PSD the TX chains are correlated and the antenna gain is unequal among the chains. The directional gain is:

5470-5725 MHz

Chain 0 Antenna Gain (dBi)	Chain 1 Antenna Gain (dBi)	Correlated Chains Directional Gain (dBi)
-0.40	-1.00	2.32

RESULTS

ID:	43578	Date:	4/10/17
------------	-------	--------------	---------

Bandwidth and Antenna Gain

Channel	Frequency (MHz)	Min 26 dB BW (MHz)	Min 99% BW (MHz)	Directional Gain for Power (dBi)	Directional Gain for PPSD (dBi)
Low	5500	24.50	17.775	-0.69	2.32
Mid	5580	24.35	17.560	-0.69	2.32
Mid (FCC)	5640	24.30	17.431	-0.69	2.32
High	5700	24.45	17.729	-0.69	2.32

Limits

Channel	Frequency (MHz)	FCC Power Limit (dBm)	IC Power Limit (dBm)	IC EIRP Limit (dBm)	Power Limit (dBm)	FCC PPSD Limit (dBm)	IC PSD Limit (dBm)	PPSD Limit (dBm)
Low	5500	24.00	23.50	29.50	23.50	11.00	11.00	11.00
Mid	5580	24.00	23.45	29.45	23.45	11.00	11.00	11.00
Mid (FCC)	5640	24.00	23.41	29.41	23.41	11.00	11.00	11.00
High	5700	24.00	23.49	29.49	23.49	11.00	11.00	11.00

Duty Cycle CF (dB)	0.10	Included in Calculations of Corr'd PPSD
---------------------------	------	--

Output Power Results

Channel	Frequency (MHz)	Chain 0 Meas Power (dBm)	Chain 1 Meas Power (dBm)	Total Corr'd Power (dBm)	Power Limit (dBm)	Power Margin (dB)
Low	5500	12.86	11.14	15.09	23.50	-8.40
Mid	5580	12.16	10.77	14.53	23.45	-8.91
Mid (FCC)	5640	11.73	10.51	14.17	23.41	-9.24
High	5700	12.86	11.23	15.13	23.49	-8.36

PPSD Results

Channel	Frequency (MHz)	Chain 0 Meas PPSD (dBm)	Chain 1 Meas PPSD (dBm)	Total Corr'd PPSD (dBm)	PPSD Limit (dBm)	PPSD Margin (dB)
Low	5500	1.729	-0.318	3.94	11.00	-7.06
Mid	5580	1.253	-0.419	3.61	11.00	-7.39
Mid (FCC)	5640	0.980	-0.165	3.56	11.00	-7.44
High	5700	1.449	-0.370	3.74	11.00	-7.26

Note: the power readings above were measured with gated method, and the measurement was taken only during the ON time. No duty cycle correction was necessary.

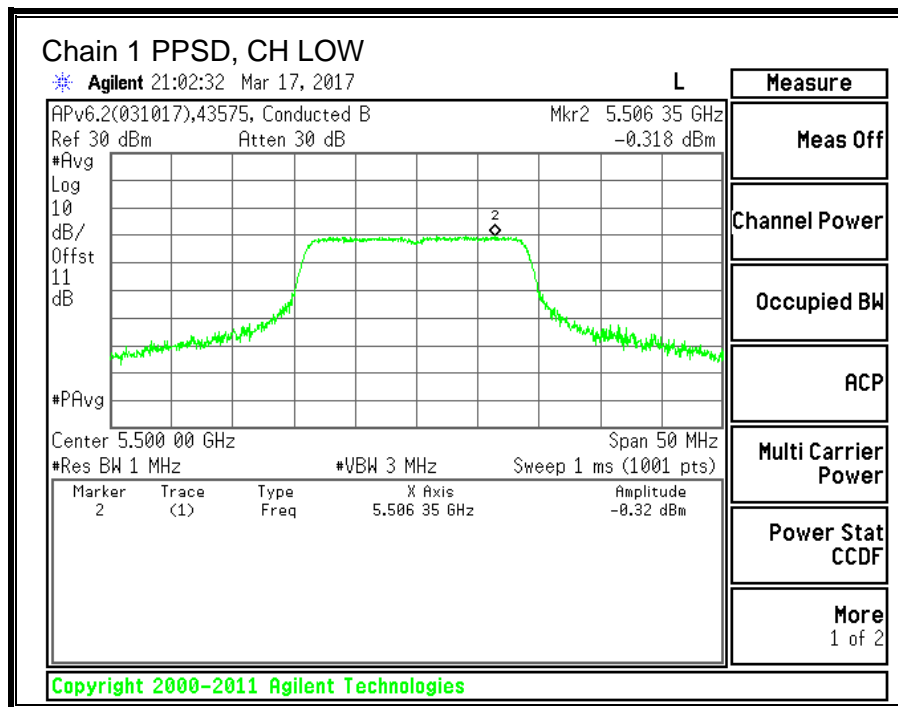
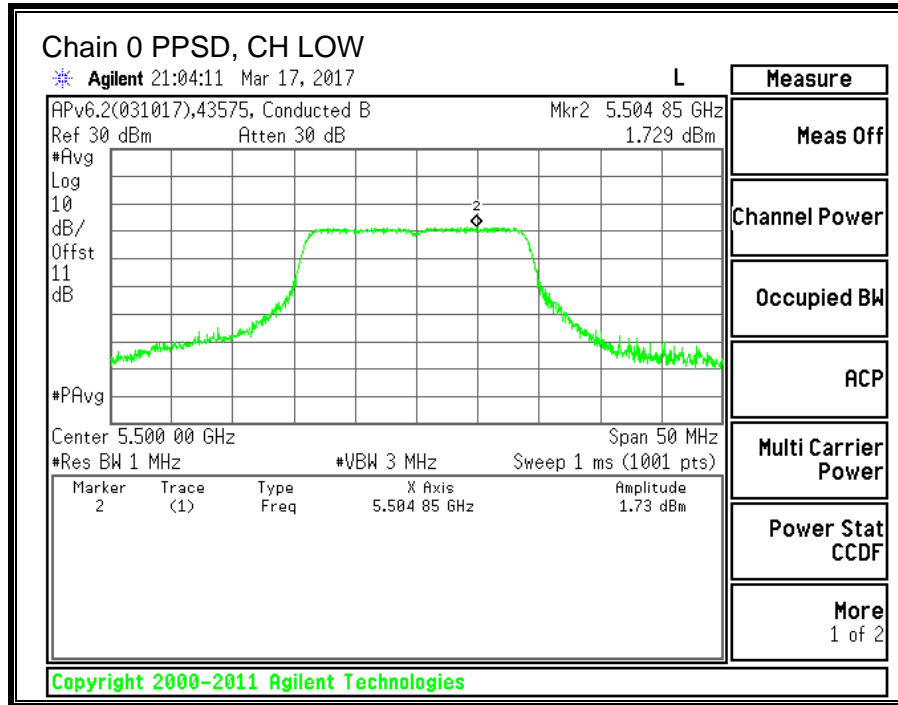

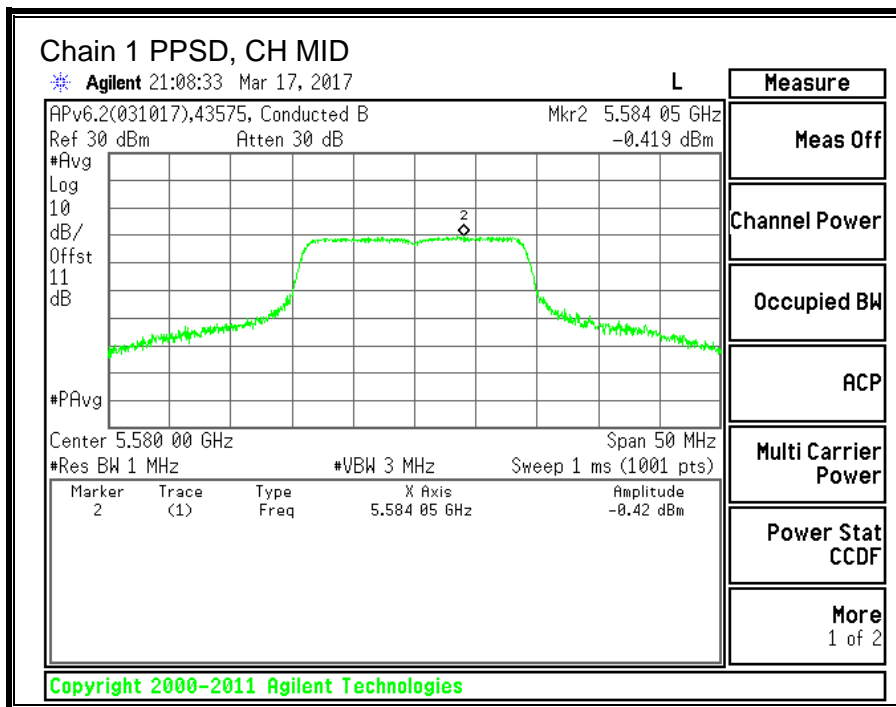
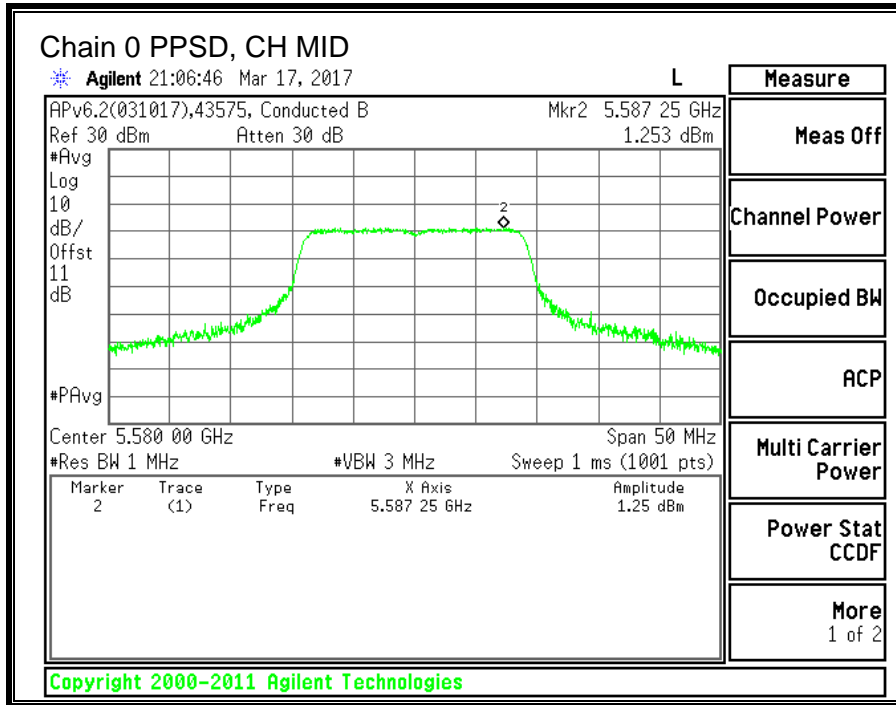

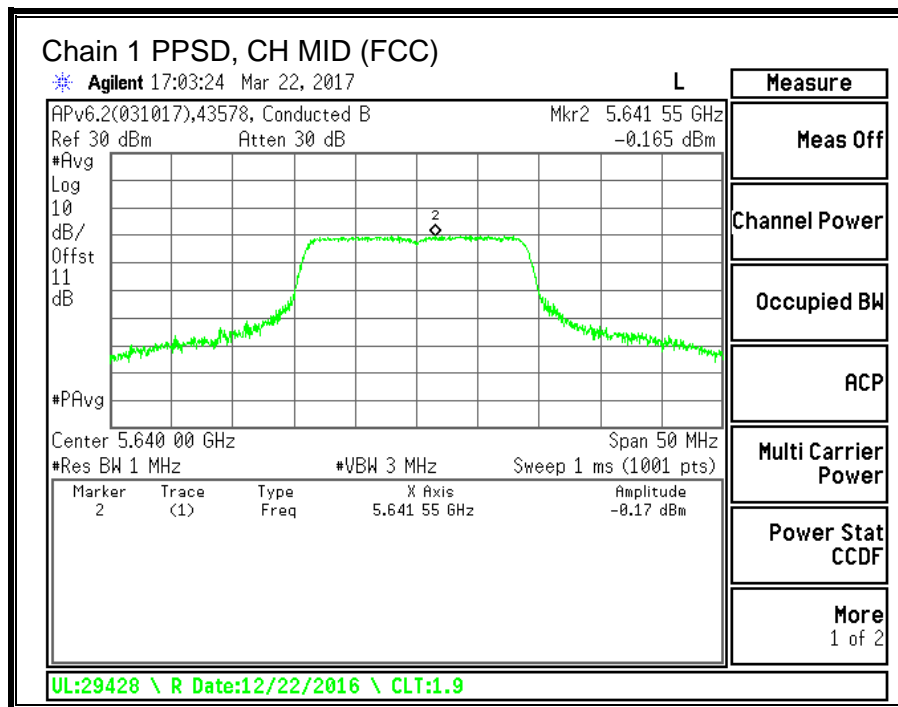
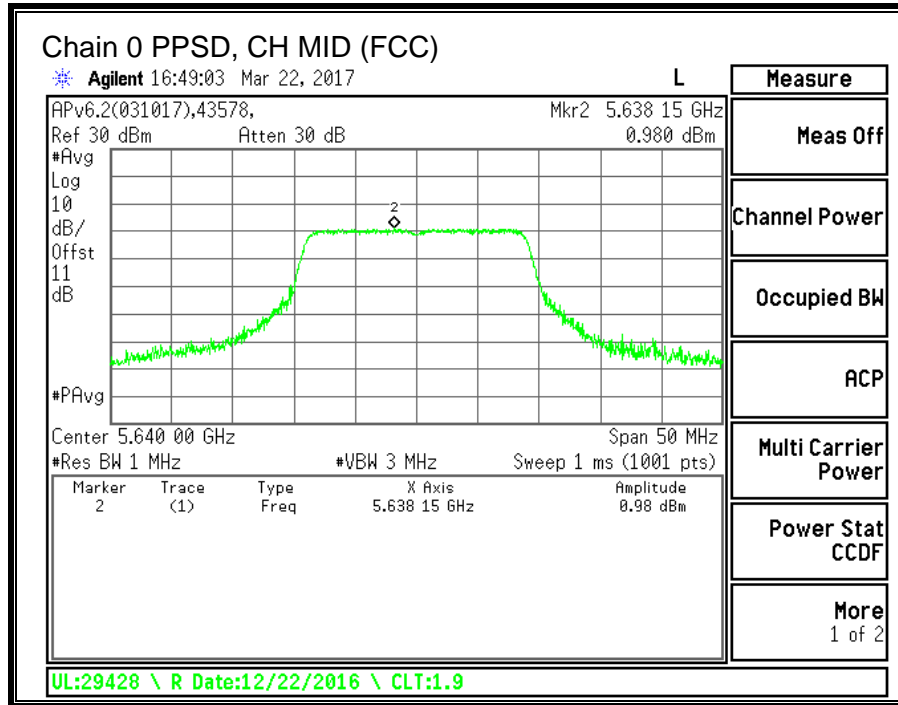

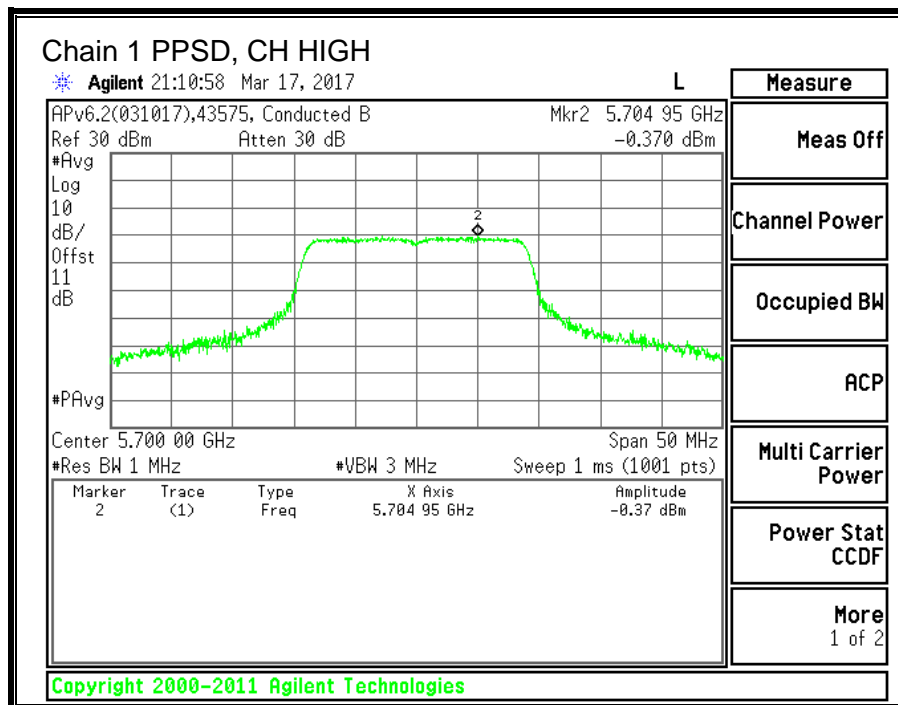
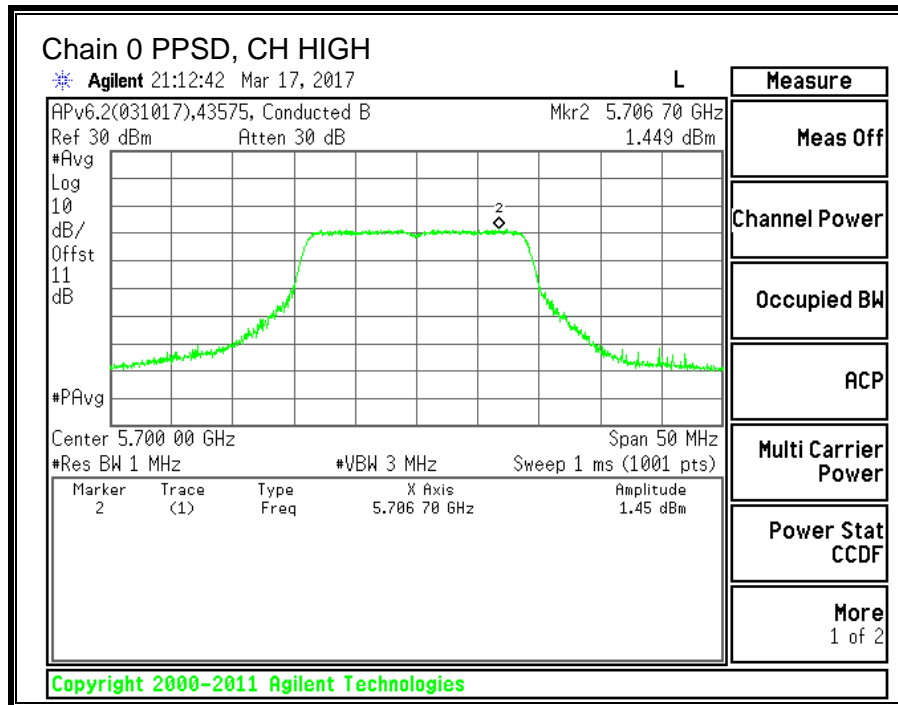

9.11. 11n HT40 2TX CDD MIMO MODE IN THE 5.6GHz BAND

9.11.1. 26 dB BANDWIDTH

LIMITS

None; for reporting purposes only.

RESULTS

Channel	Frequency	26 dB BW Chain 0 (MHz)	26 dB BW Chain 1 (MHz)
Low	5510	43.10	43.20
Mid	5550	43.20	43.10
Mid (FCC)	5630	43.50	42.90
High	5670	43.40	43.20

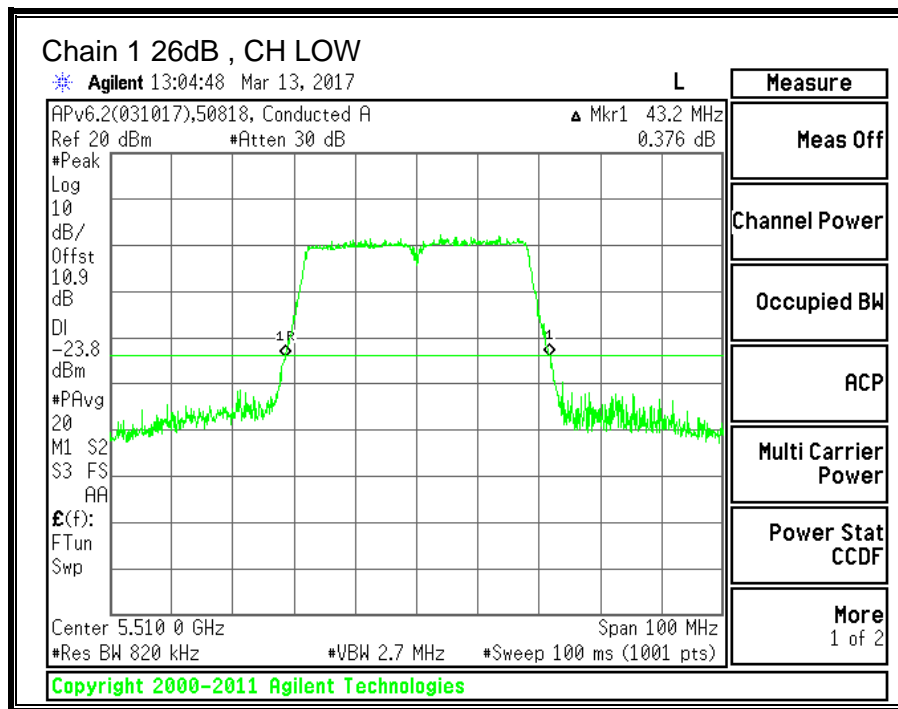
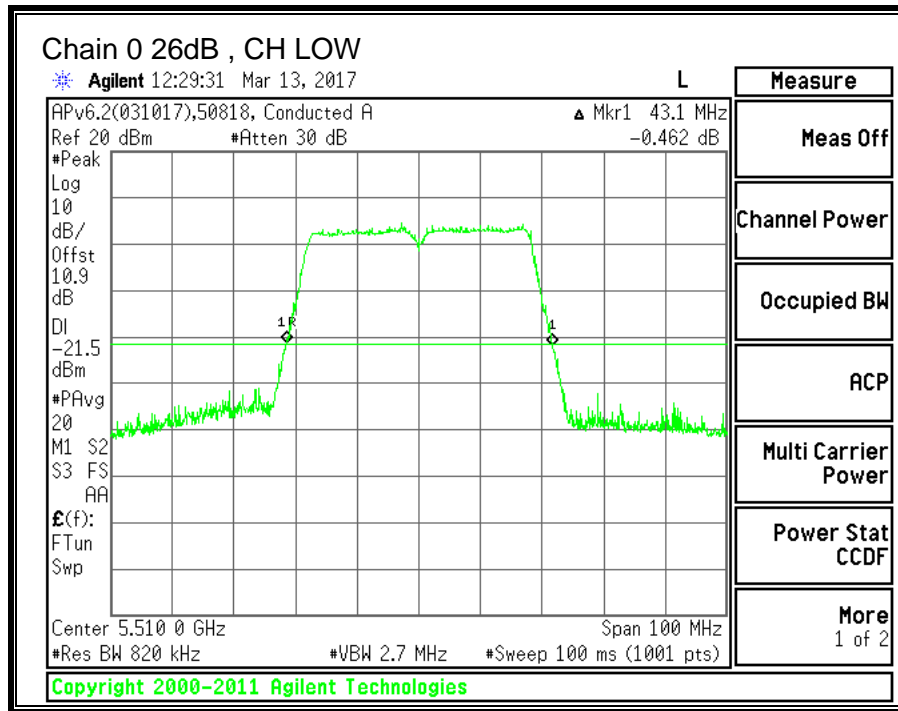

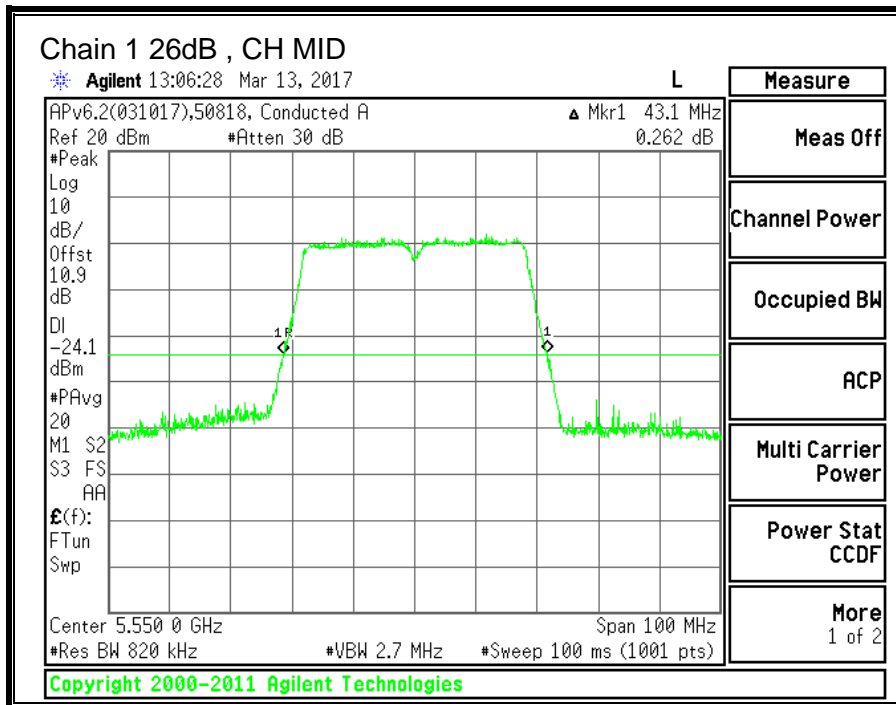
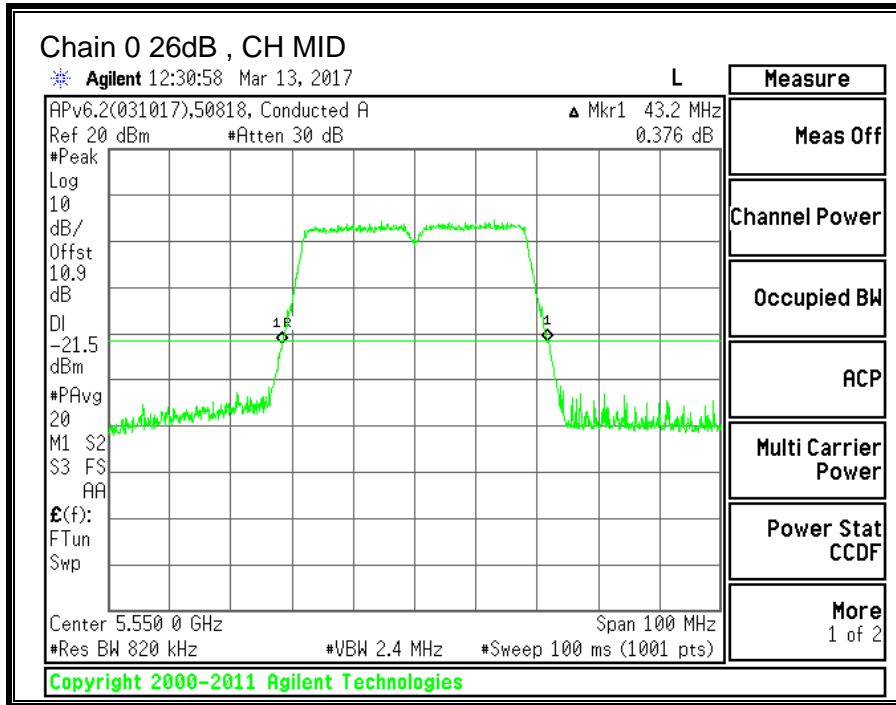

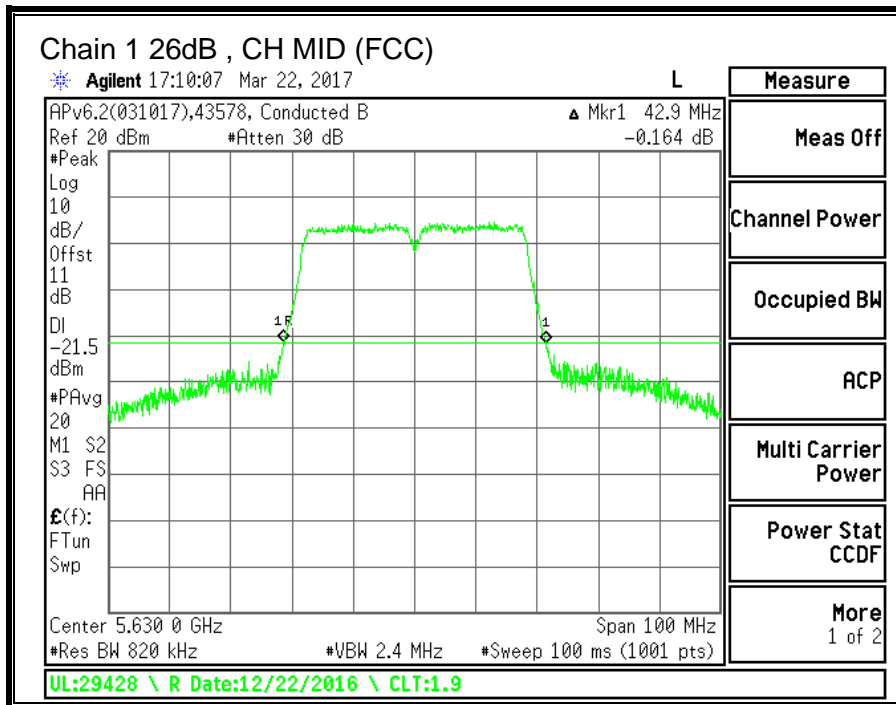
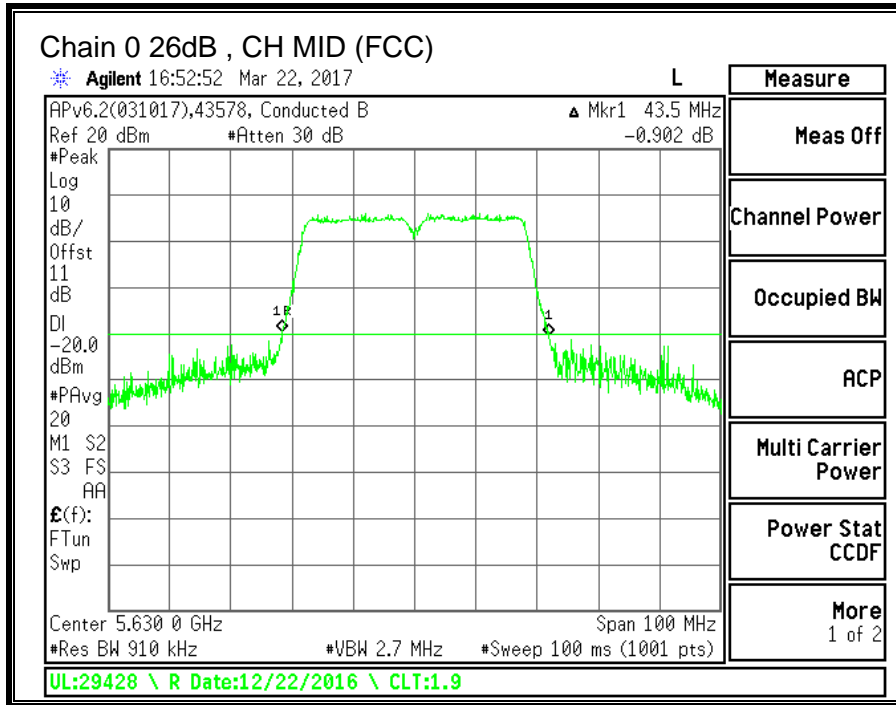

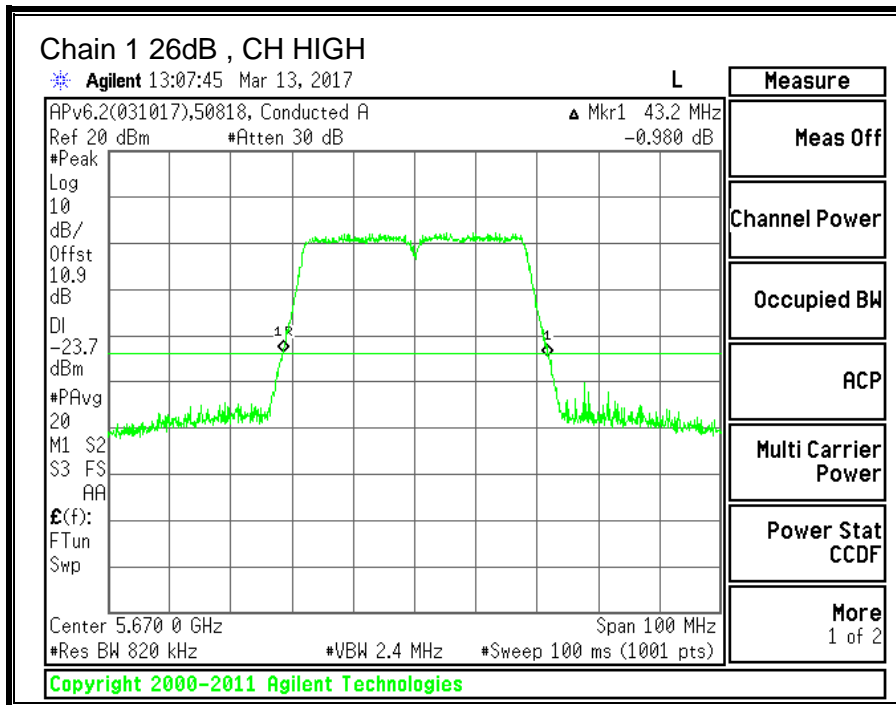
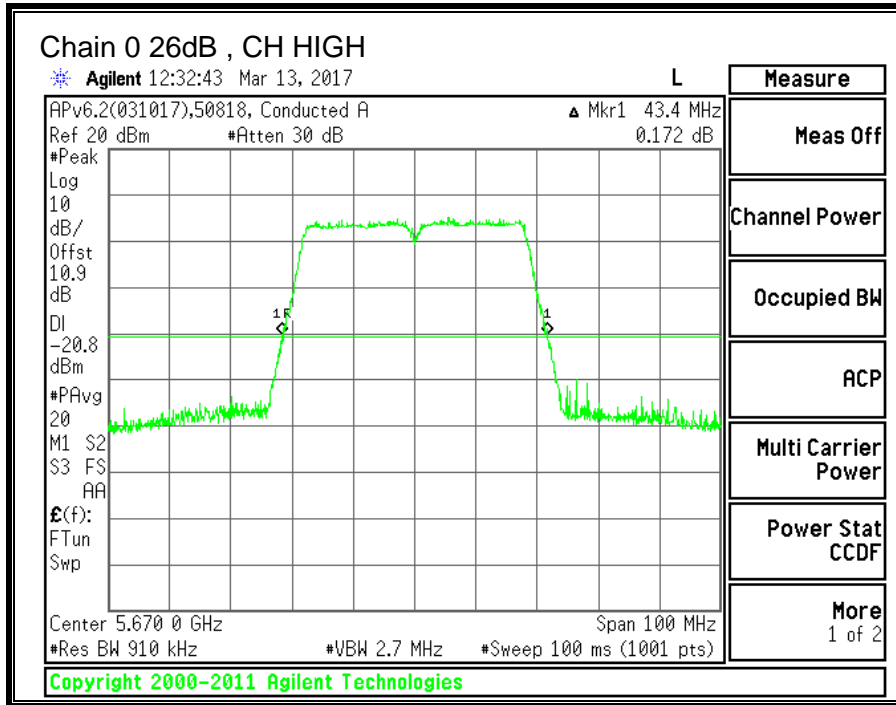

9.11.2. 99% BANDWIDTH

LIMITS

None; for reporting purposes only.

RESULTS

Channel	Frequency	99% BW Chain 0 (MHz)	99% BW Chain 1 (MHz)
Low	5510	36.0478	35.7670
Mid	5550	36.0815	36.0244
Mid (FCC)	5630	35.7205	35.8008
High	5670	36.0722	35.7035

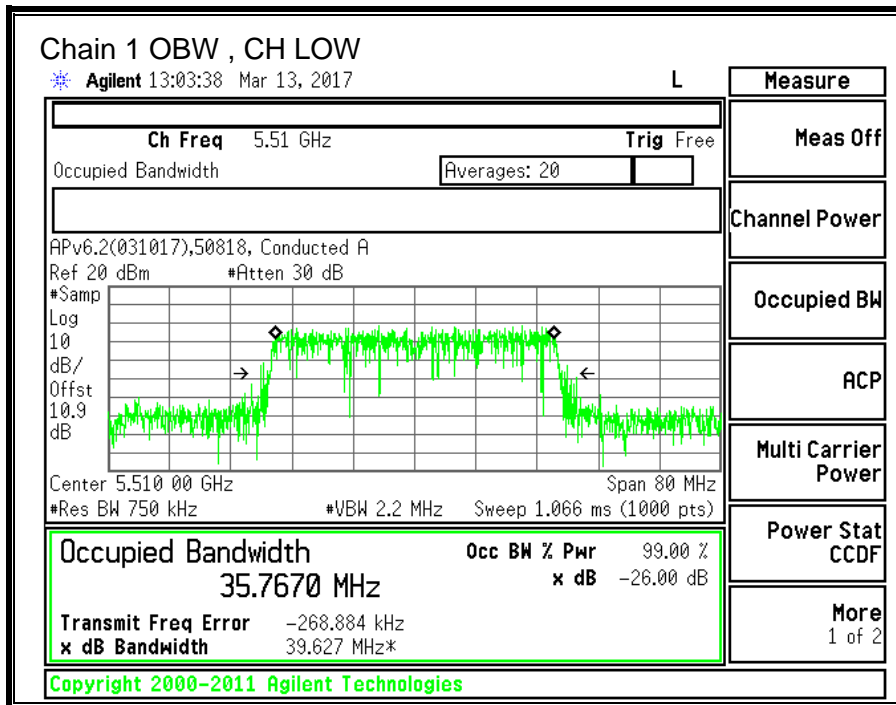
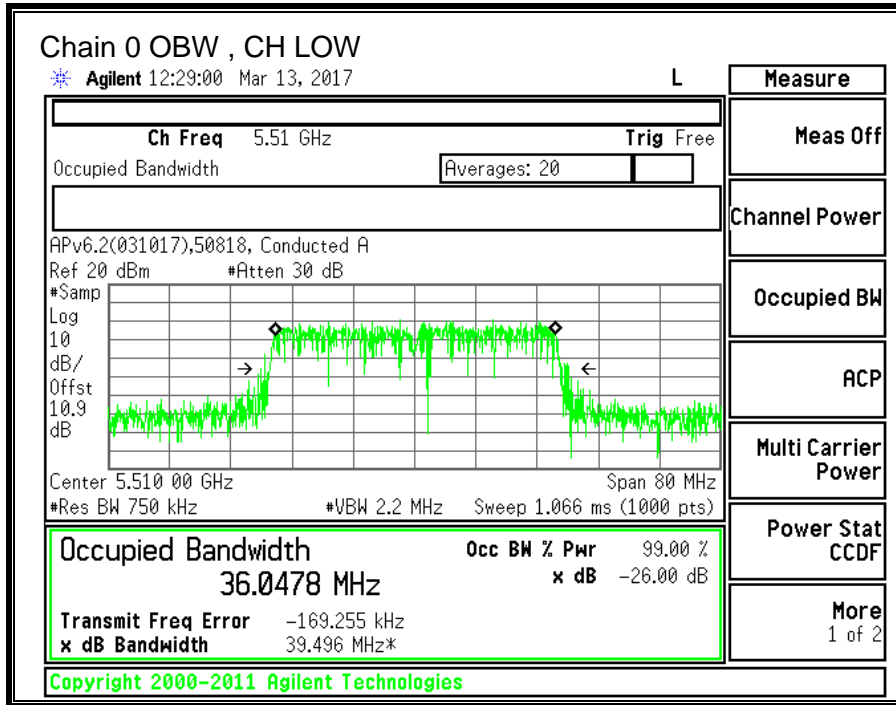

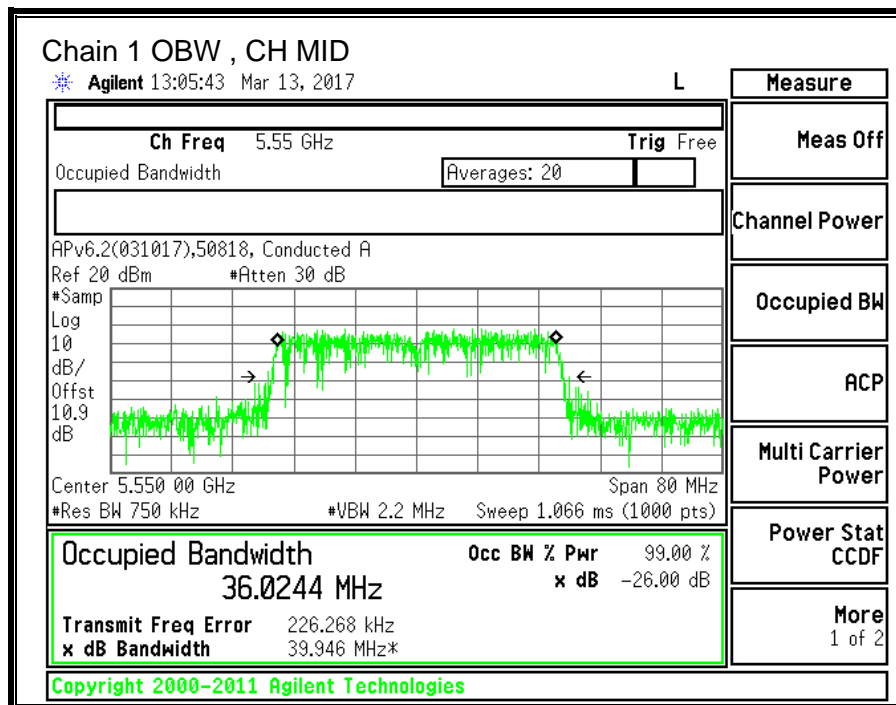
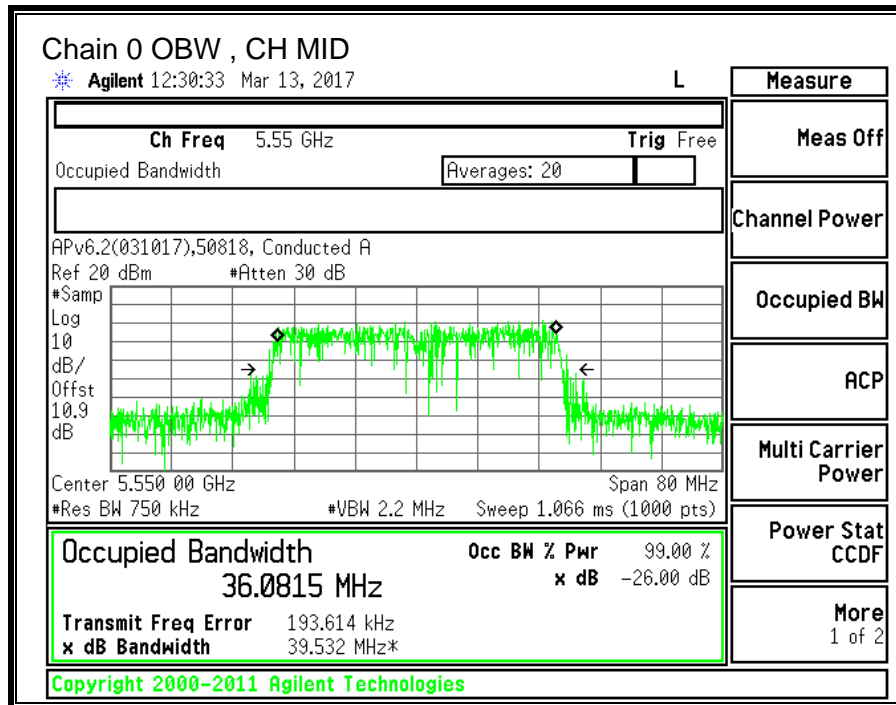

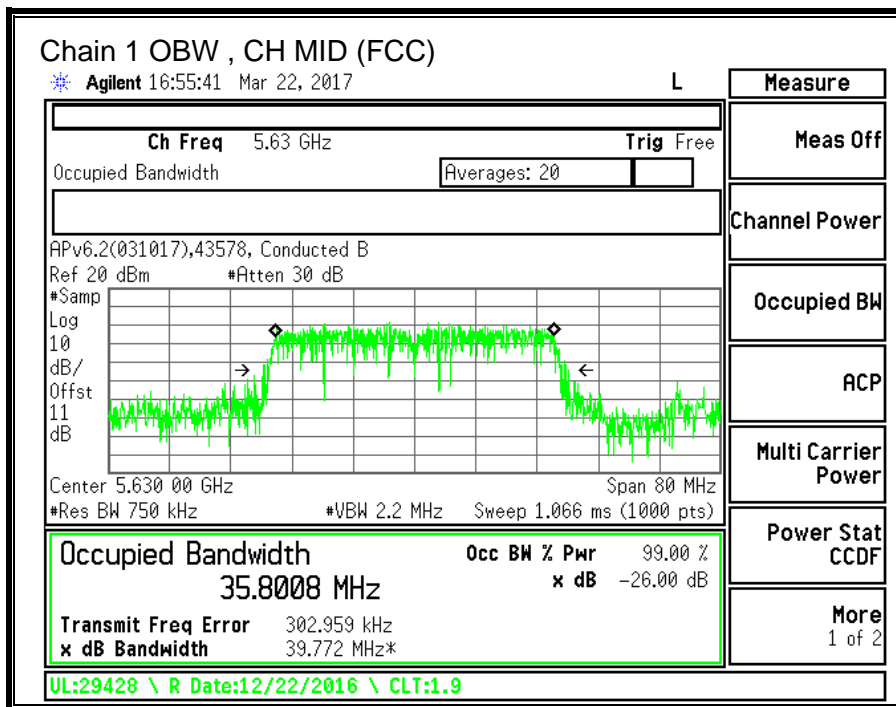
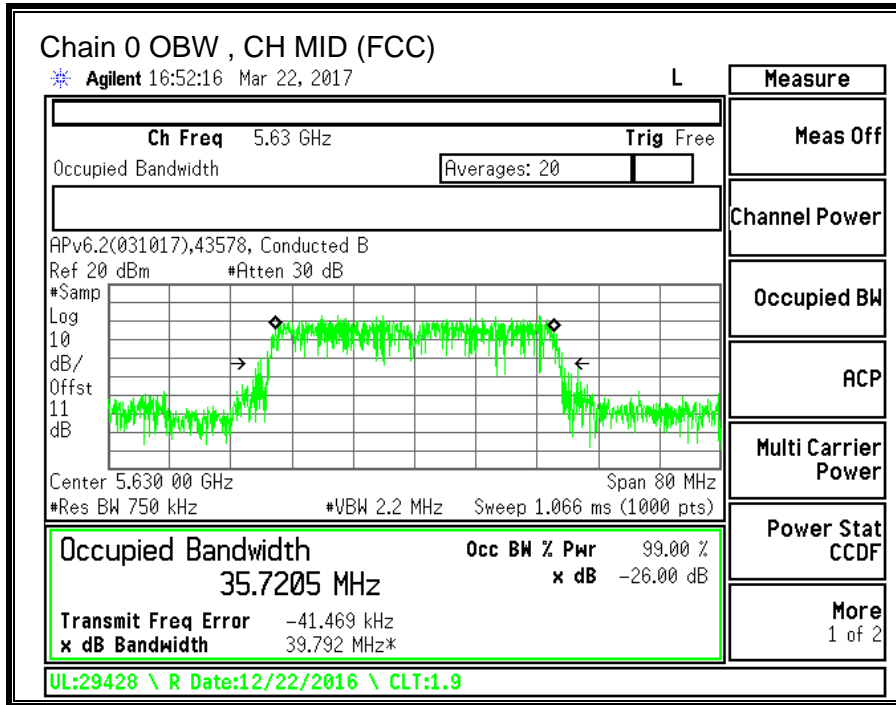

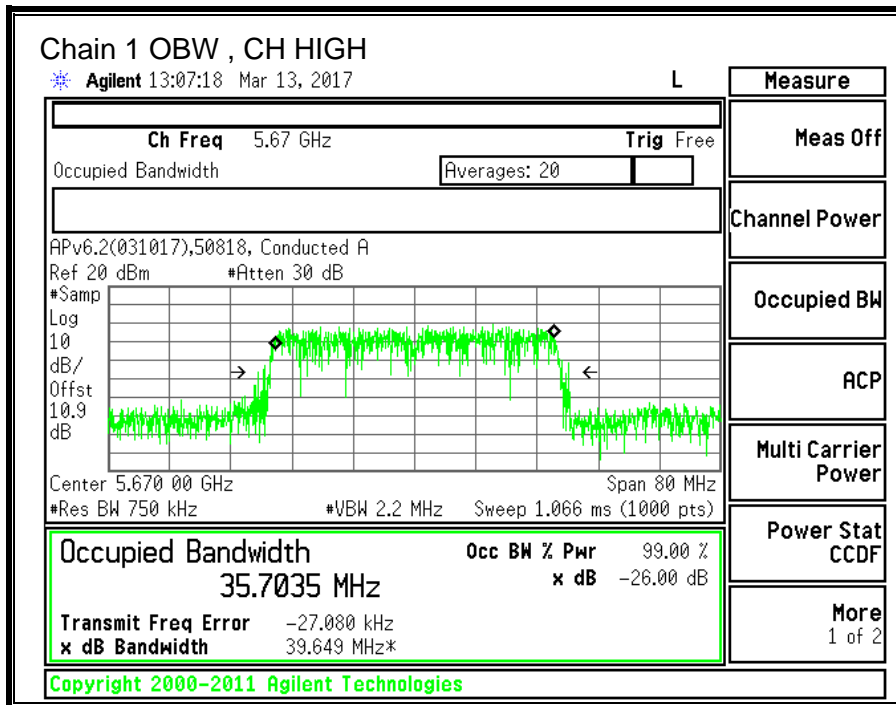
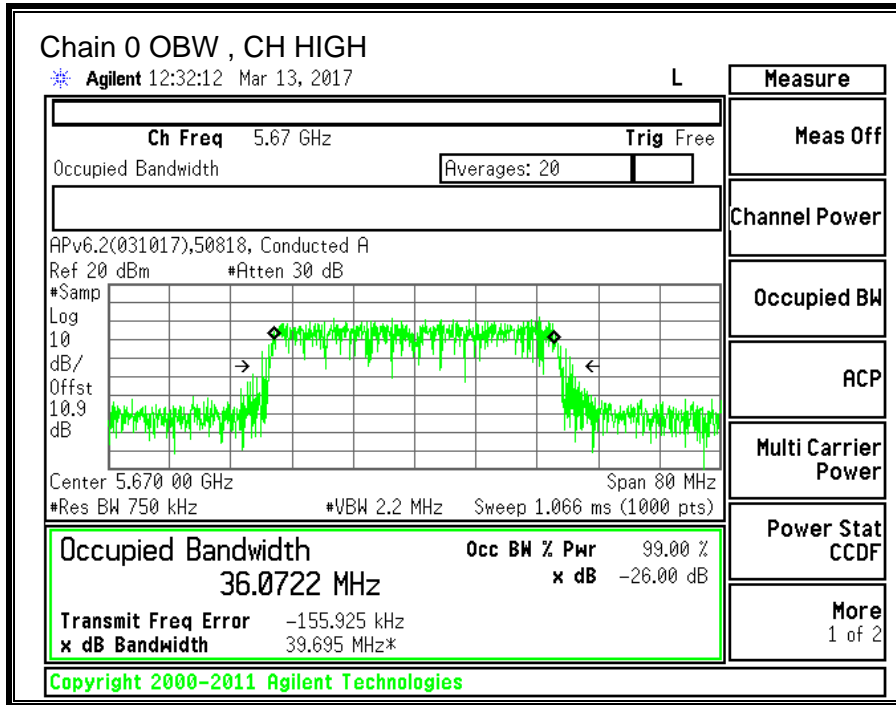

9.11.3. OUTPUT POWER AND PPSD

LIMITS

FCC §15.407 (a) (2)

For the band 5.47–5.725 GHz, the maximum conducted output power over the frequency band of operation shall not exceed the lesser of 250 mW or $11 \text{ dBm} + 10 \log B$, where B is the 26–dB emission bandwidth in MHz. In addition, the maximum power spectral density shall not exceed 11 dBm in any 1–MHz band. If transmitting antennas of directional gain greater than 6 dBi are used, both the maximum conducted output power and the peak power spectral density shall be reduced by the amount in dB that the directional gain of the antenna exceeds 6 dBi.

IC RSS-247 (6.2.3) (1)

The maximum conducted output power shall not exceed 250 mW or $11 + 10 \log_{10} B$, dBm, whichever is less. The power spectral density shall not exceed 11 dBm in any 1.0 MHz band.

The maximum e.i.r.p. shall not exceed 1.0 W or $17 + 10 \log_{10} B$, dBm, whichever is less. B is the 99% emission bandwidth in megahertz. Note that devices with a maximum e.i.r.p. greater than 500 mW shall implement TPC in order to have the capability to operate at least 6 dB below the maximum permitted e.i.r.p. of 1 W.

TEST PROCEDURE

Measurements perform using a wideband gated RF power meter provided that the gate parameters are adjusted such that the power is measured only when the EUT is transmitting at its maximum power control level. Since the measurement is made only during the ON time of the transmitter, no duty cycle correction factor is required.

Straddle channel power is measured using PXA spectrum analyzer, duty cycle correction factor is required.

DIRECTIONAL ANTENNA GAIN

For power, the TX chains are uncorrelated and the antenna gain is unequal among the chains. The directional gain is:

5470-5725 MHz

Chain 0 Antenna Gain (dBi)	Chain 1 Antenna Gain (dBi)	Uncorrelated Chains Directional Gain (dBi)
-0.40	-1.00	-0.69

For PSD the TX chains are correlated and the antenna gain is unequal among the chains. The directional gain is:

5470-5725 MHz

Chain 0 Antenna Gain (dBi)	Chain 1 Antenna Gain (dBi)	Correlated Chains Directional Gain (dBi)
-0.40	-1.00	2.32

RESULTS

ID:	43578	Date:	3/17/17
------------	-------	--------------	---------

Bandwidth and Antenna Gain

Channel	Frequency (MHz)	Min 26 dB BW (MHz)	Min 99% BW (MHz)	Directional Gain for Power (dBi)	Directional Gain for PPSD (dBi)
Low	5510	43.10	35.767	-0.69	2.32
Mid	5550	43.10	36.024	-0.69	2.32
Mid (FCC)	5630	42.90	35.721	-0.69	2.32
High	5670	43.20	35.704	-0.69	2.32

Limits

Channel	Frequency (MHz)	FCC Power Limit (dBm)	IC Power Limit (dBm)	IC EIRP Limit (dBm)	Power Limit (dBm)	FCC PPSD Limit (dBm)	IC PSD Limit (dBm)	PPSD Limit (dBm)
Low	5510	24.00	24.00	30.00	24.00	11.00	11.00	11.00
Mid	5550	24.00	24.00	30.00	24.00	11.00	11.00	11.00
Mid (FCC)	5630	24.00	24.00	30.00	24.00	11.00	11.00	11.00
High	5670	24.00	24.00	30.00	24.00	11.00	11.00	11.00

Duty Cycle CF (dB)	0.22	Included in Calculations of Corr'd PPSD
---------------------------	------	--

Output Power Results

Channel	Frequency (MHz)	Chain 0 Meas Power (dBm)	Chain 1 Meas Power (dBm)	Total Corr'd Power (dBm)	Power Limit (dBm)	Power Margin (dB)
Low	5510	12.79	11.18	15.07	24.00	-8.93
Mid	5550	12.86	11.12	15.09	24.00	-8.91
Mid (FCC)	5630	12.72	11.09	14.99	24.00	-9.01
High	5670	12.83	11.24	15.12	24.00	-8.88

PPSD Results

Channel	Frequency (MHz)	Chain 0 Meas PPSD (dBm)	Chain 1 Meas PPSD (dBm)	Total Corr'd PPSD (dBm)	PPSD Limit (dBm)	PPSD Margin (dB)
Low	5510	-1.664	-3.291	0.83	11.00	-10.17
Mid	5550	-1.714	-2.708	1.05	11.00	-9.95
Mid (FCC)	5630	-1.835	-2.822	0.93	11.00	-10.07
High	5670	-1.384	-2.881	1.16	11.00	-9.84

Note: the power readings above were measured with gated method, and the measurement was taken only during the ON time. No duty cycle correction was necessary.

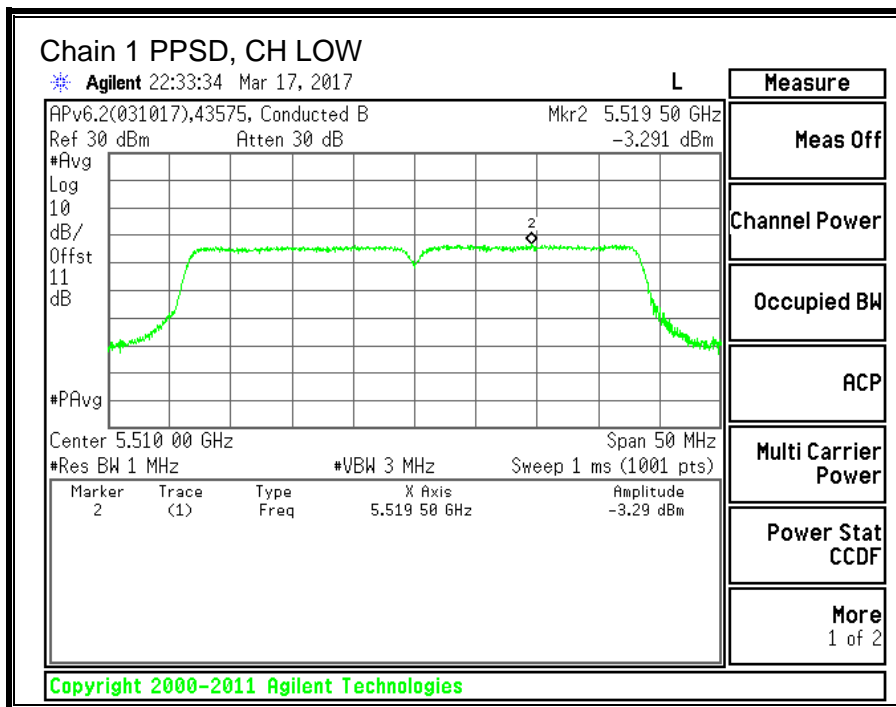
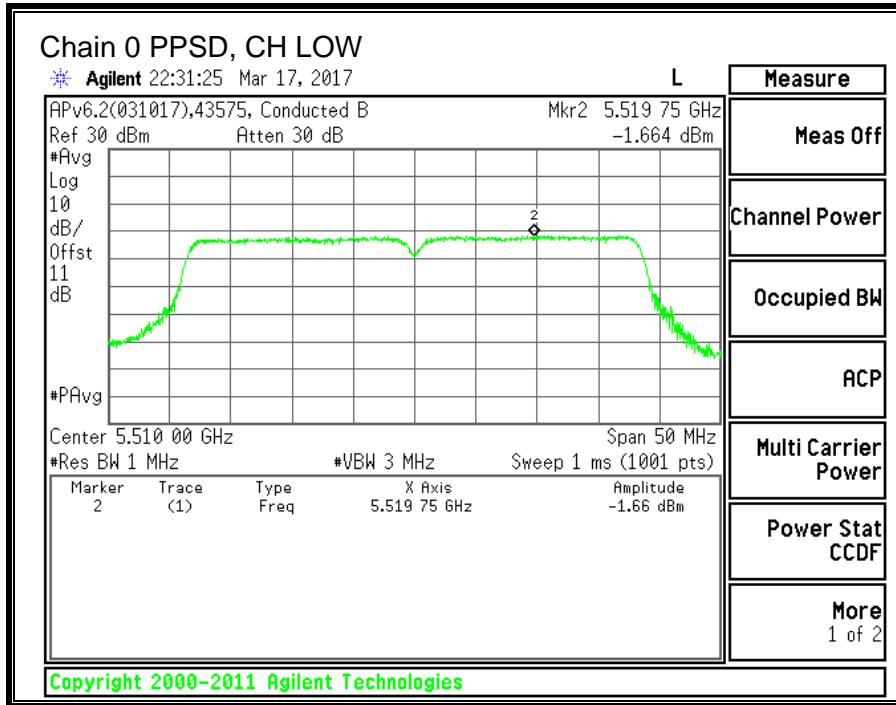

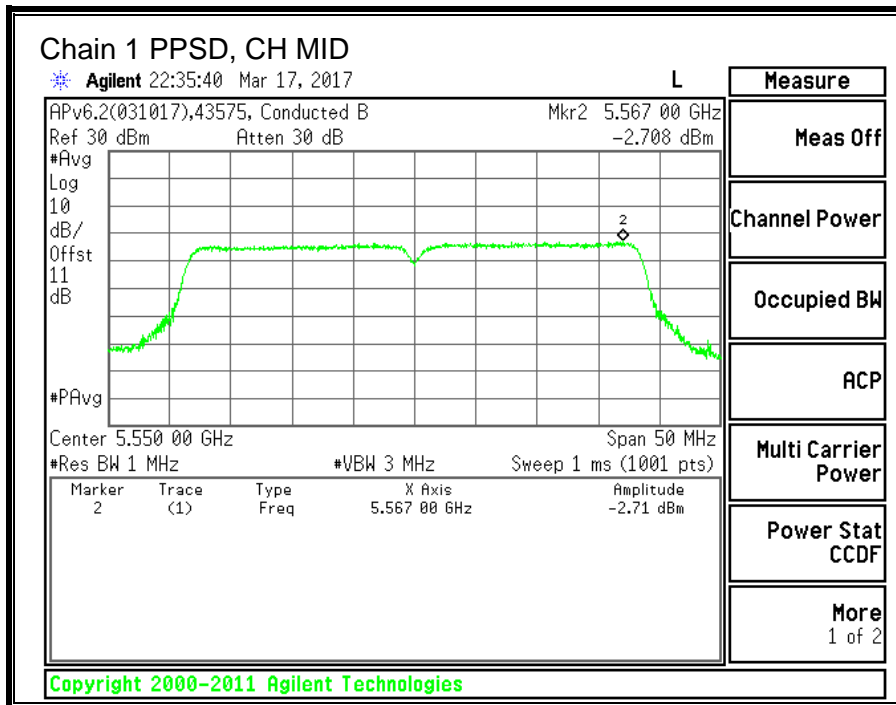
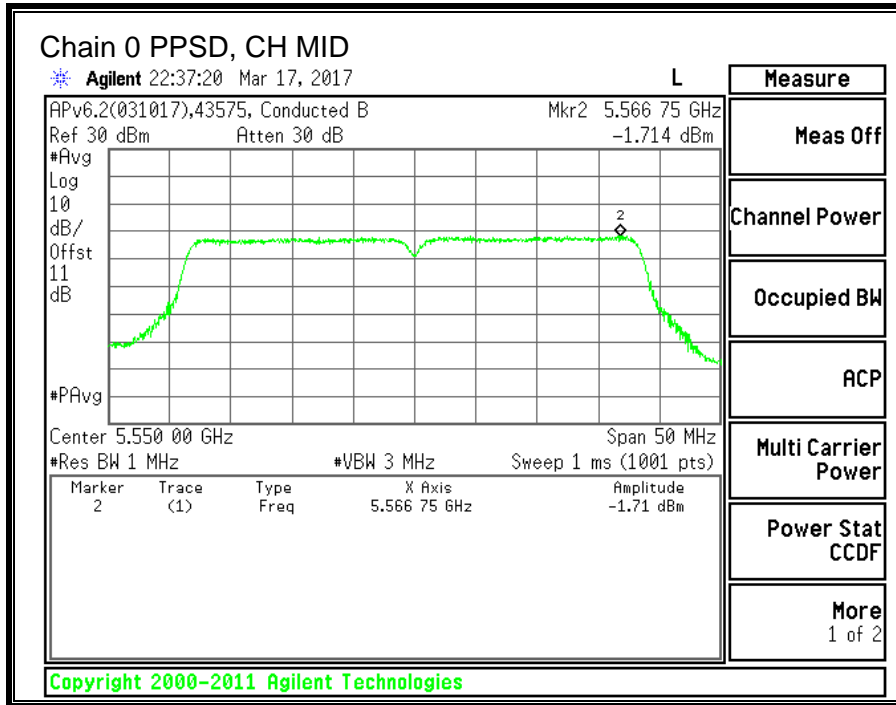

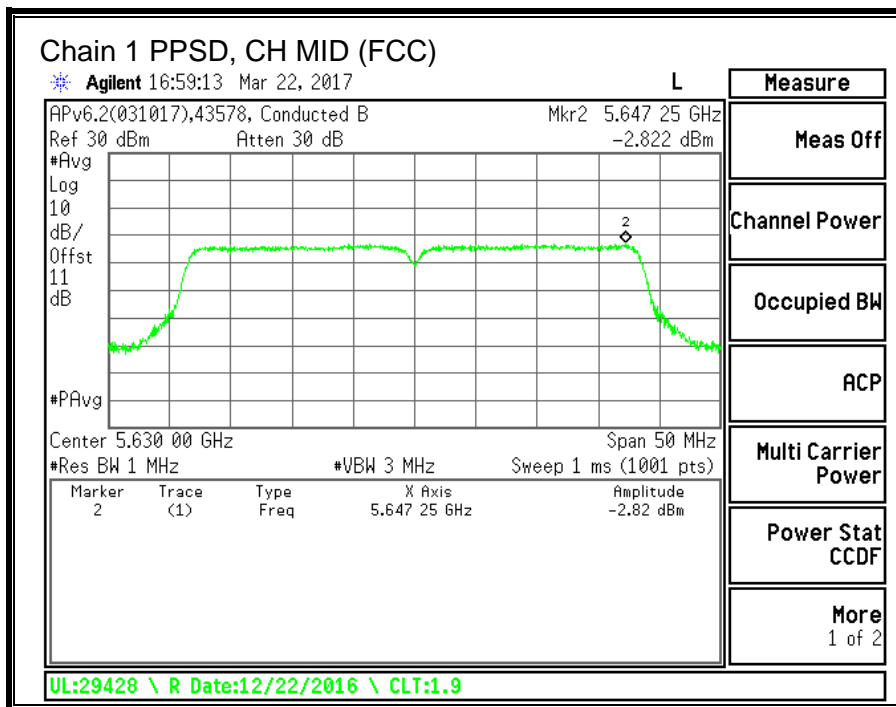
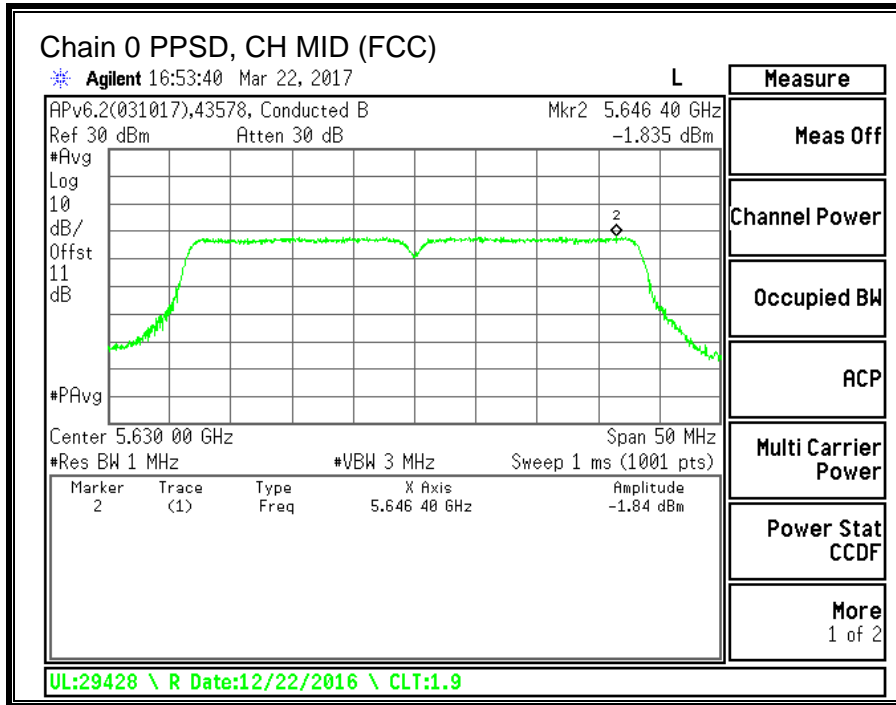

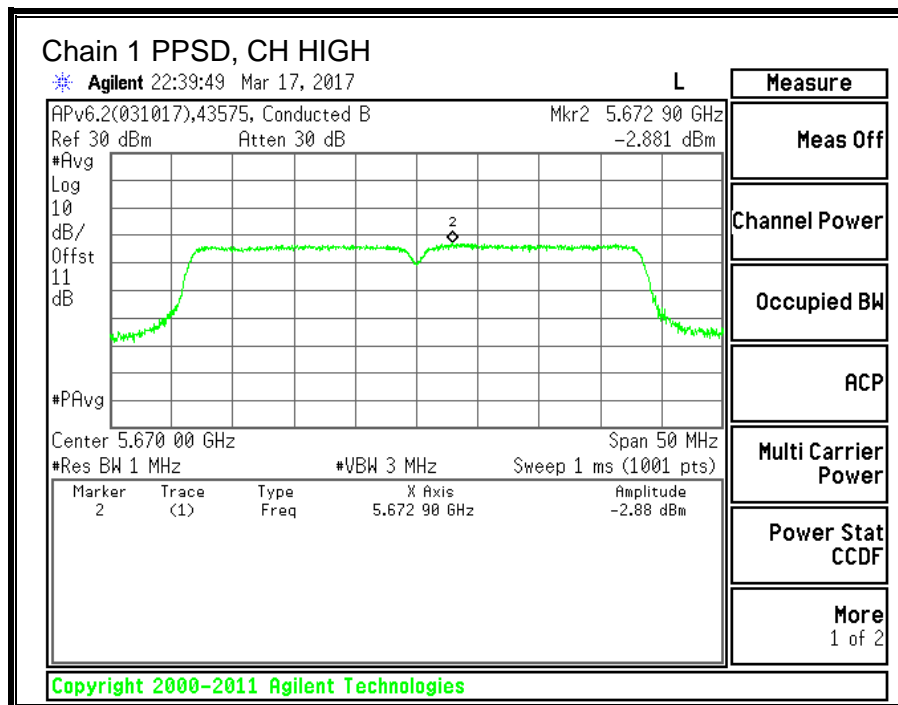
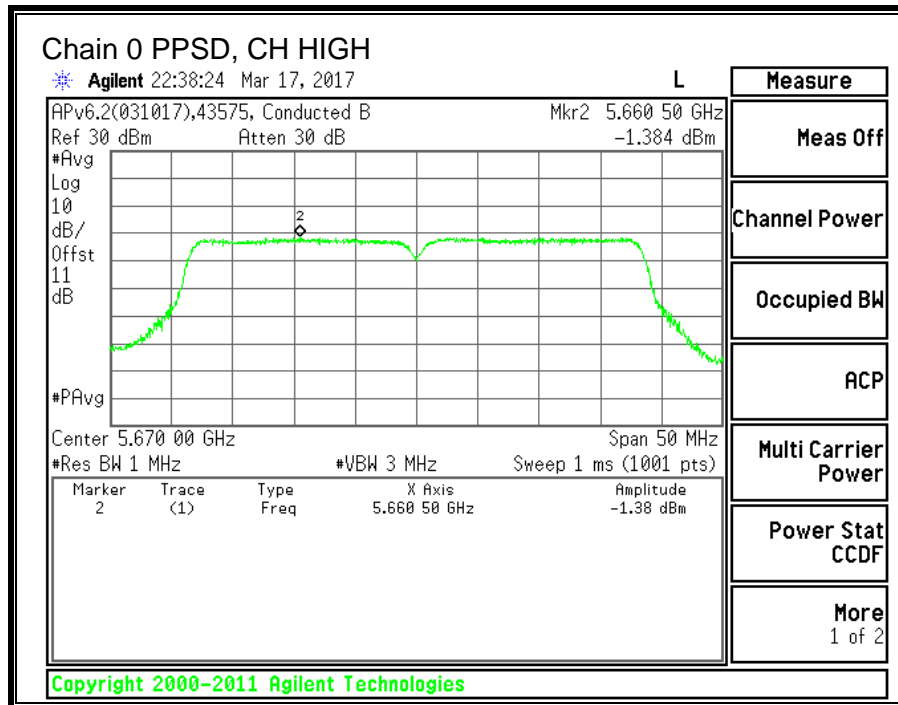

9.12. 11ac HT80 2TX CDD MIMO MODE IN THE 5.6GHz BAND

9.12.1. 26 dB BANDWIDTH

LIMITS

None; for reporting purposes only.

RESULTS

Channel	Frequency	26 dB BW Chain 0 (MHz)	26 dB BW Chain 1 (MHz)
Low	5530	85.40	86.20
Mid	5610	86.40	85.60

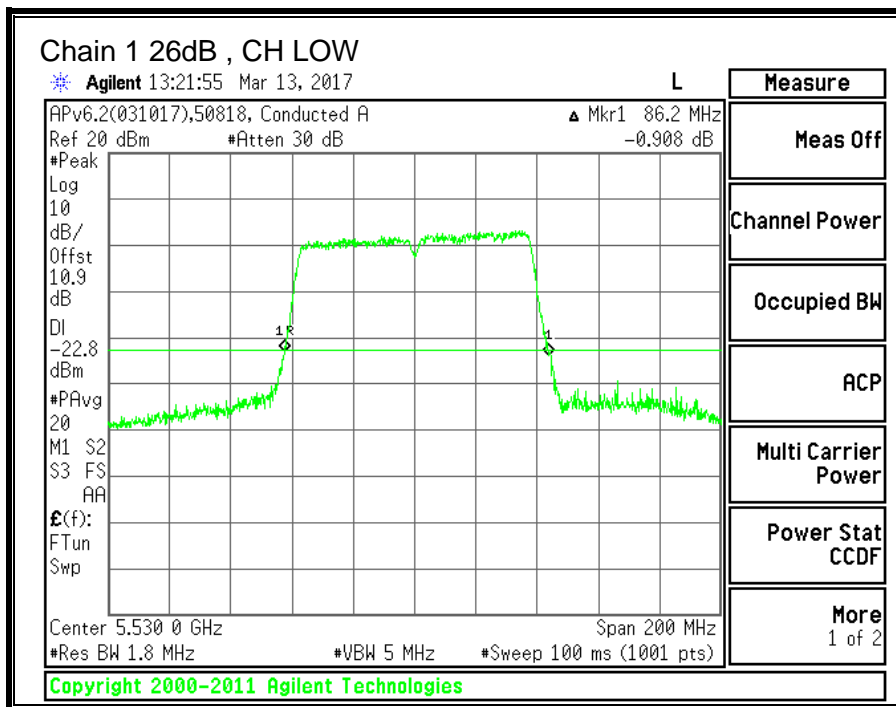
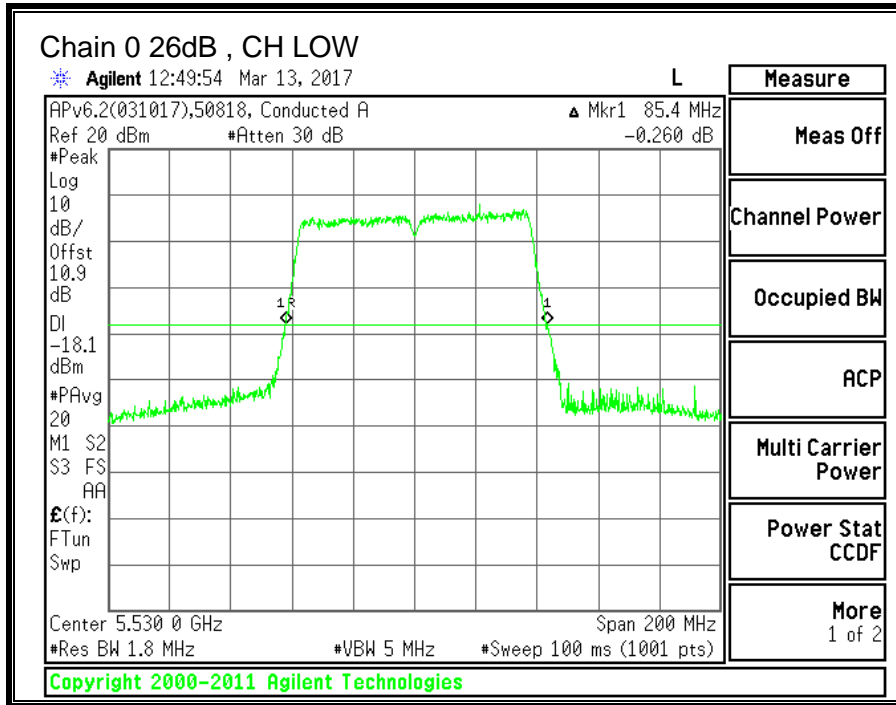

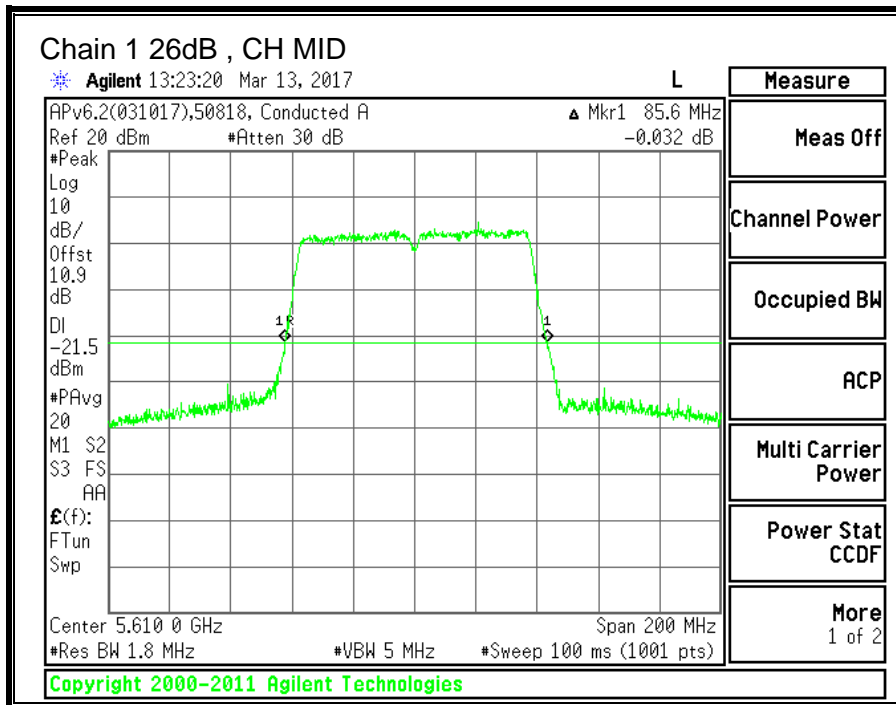
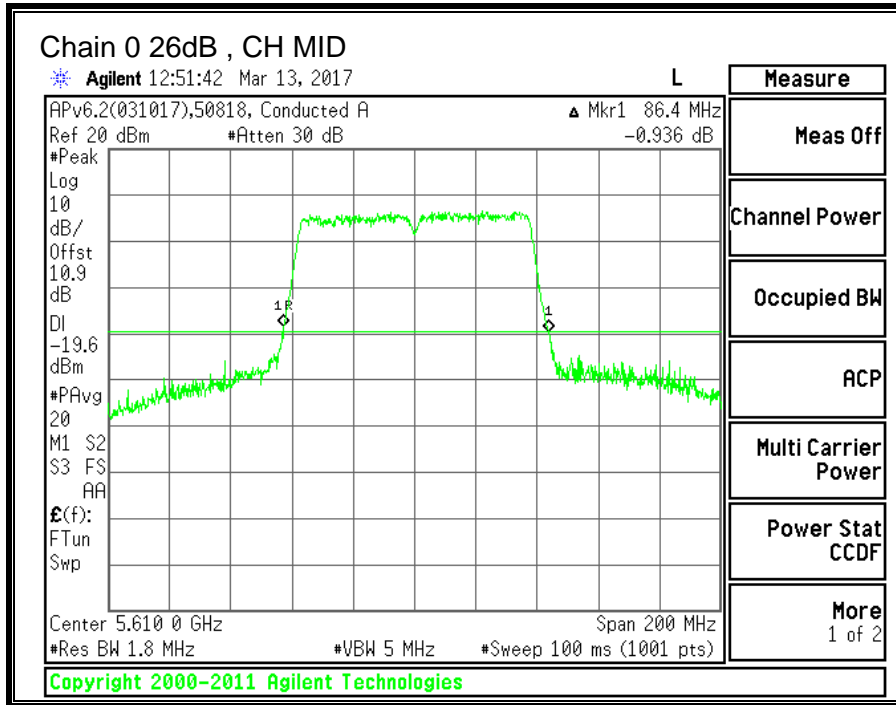

9.12.2. 99% BANDWIDTH

LIMITS

None; for reporting purposes only.

RESULTS

Channel	Frequency	99% BW Chain 0 (MHz)	99% BW Chain 1 (MHz)
Low	5530	75.0065	74.6387
Mid	5610	73.2809	75.1900

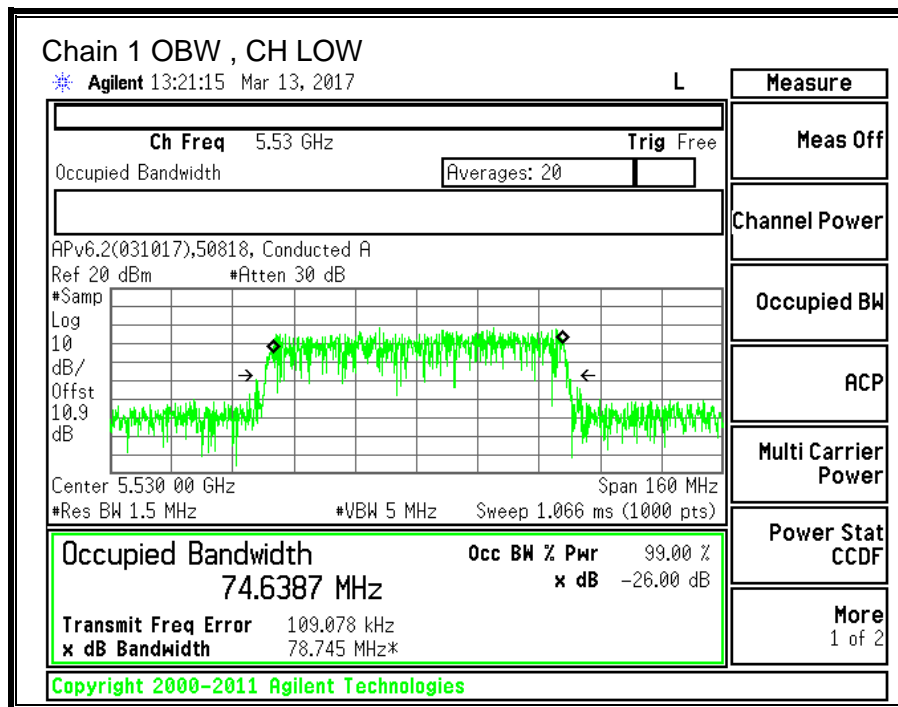
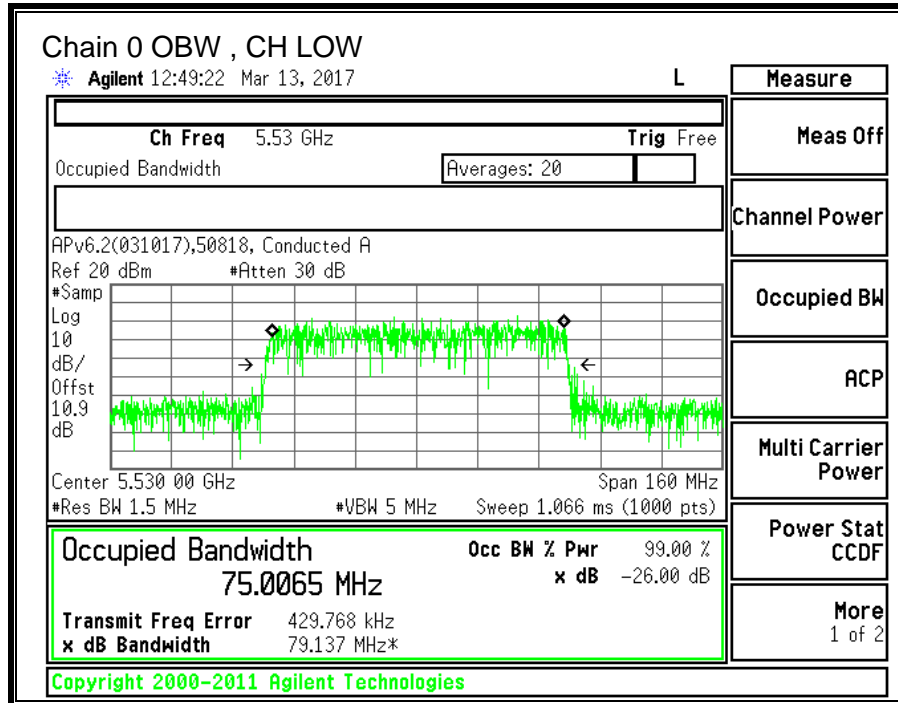

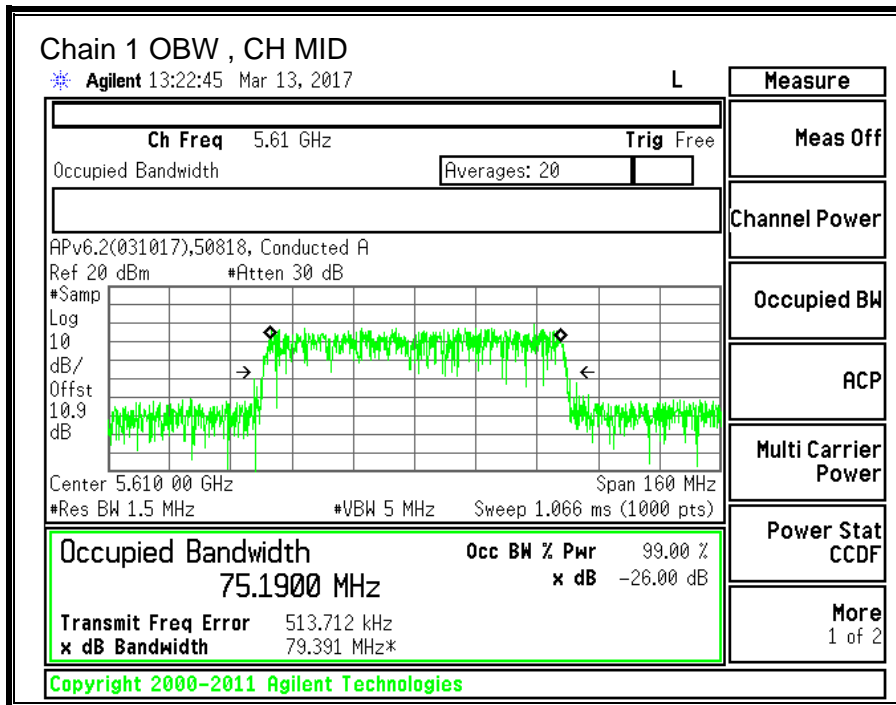
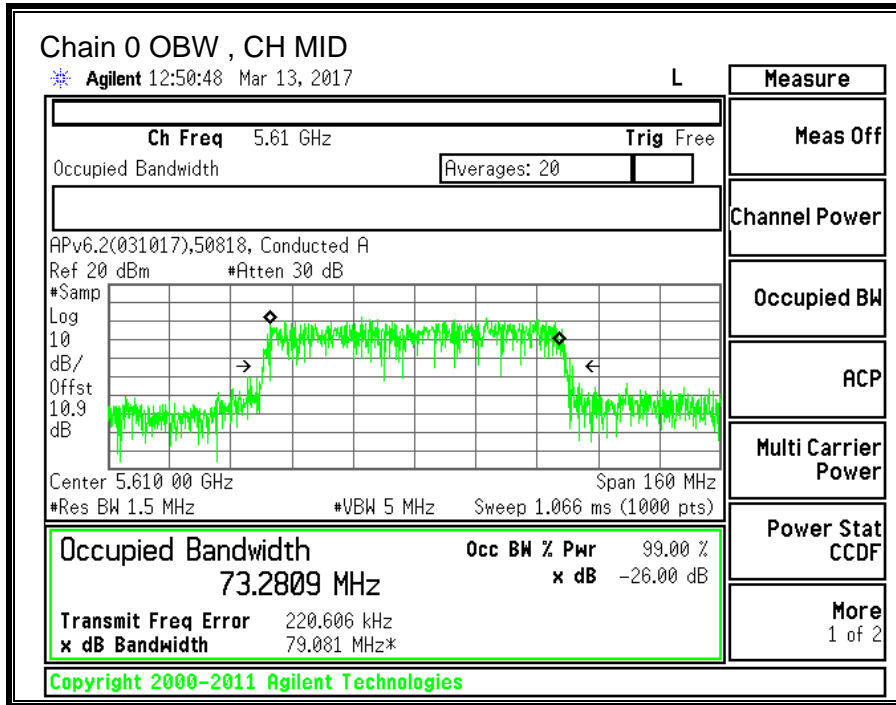

9.12.3. OUTPUT POWER AND PPSD

LIMITS

FCC §15.407 (a) (2)

For the band 5.47–5.725 GHz, the maximum conducted output power over the frequency band of operation shall not exceed the lesser of 250 mW or $11 \text{ dBm} + 10 \log B$, where B is the 26–dB emission bandwidth in MHz. In addition, the maximum power spectral density shall not exceed 11 dBm in any 1–MHz band. If transmitting antennas of directional gain greater than 6 dBi are used, both the maximum conducted output power and the peak power spectral density shall be reduced by the amount in dB that the directional gain of the antenna exceeds 6 dBi.

IC RSS-247 (6.2.3) (1)

The maximum conducted output power shall not exceed 250 mW or $11 + 10 \log_{10} B$, dBm, whichever is less. The power spectral density shall not exceed 11 dBm in any 1.0 MHz band.

The maximum e.i.r.p. shall not exceed 1.0 W or $17 + 10 \log_{10} B$, dBm, whichever is less. B is the 99% emission bandwidth in megahertz. Note that devices with a maximum e.i.r.p. greater than 500 mW shall implement TPC in order to have the capability to operate at least 6 dB below the maximum permitted e.i.r.p. of 1 W.

TEST PROCEDURE

Measurements perform using a wideband gated RF power meter provided that the gate parameters are adjusted such that the power is measured only when the EUT is transmitting at its maximum power control level. Since the measurement is made only during the ON time of the transmitter, no duty cycle correction factor is required.

Straddle channel power is measured using PXA spectrum analyzer, duty cycle correction factor is required.

DIRECTIONAL ANTENNA GAIN

For power, the TX chains are uncorrelated and the antenna gain is unequal among the chains. The directional gain is:

5470-5725 MHz

Chain 0 Antenna Gain (dBi)	Chain 1 Antenna Gain (dBi)	Uncorrelated Chains Directional Gain (dBi)
-0.40	-1.00	-0.69

For PSD the TX chains are correlated and the antenna gain is unequal among the chains. The directional gain is:

5470-5725 MHz

Chain 0 Antenna Gain (dBi)	Chain 1 Antenna Gain (dBi)	Correlated Chains Directional Gain (dBi)
-0.40	-1.00	2.32

RESULTS

ID:	43578	Date:	3/17/17
------------	-------	--------------	---------

Bandwidth and Antenna Gain

Channel	Frequency (MHz)	Min 26 dB BW (MHz)	Min 99% BW (MHz)	Directional Gain for Power (dBi)	Directional Gain for PPSD (dBi)
Low	5530	85.40	74.639	-0.69	2.32
Mid	5610	85.60	73.281	-0.69	2.32

Limits

Channel	Frequency (MHz)	FCC Power Limit (dBm)	IC Power Limit (dBm)	IC EIRP Limit (dBm)	Power Limit (dBm)	FCC PPSD Limit (dBm)	IC PSD Limit (dBm)	PPSD Limit (dBm)
Low	5530	24.00	24.00	30.00	24.00	11.00	11.00	11.00
Mid	5610	24.00	24.00	30.00	24.00	11.00	11.00	11.00

Duty Cycle CF (dB)	0.42	Included in Calculations of Corr'd PPSD
---------------------------	------	--

Output Power Results

Channel	Frequency (MHz)	Chain 0 Meas Power (dBm)	Chain 1 Meas Power (dBm)	Total Corr'd Power (dBm)	Power Limit (dBm)	Power Margin (dB)
Low	5530	12.78	11.08	15.02	24.00	-8.98
Mid	5610	12.71	11.16	15.01	24.00	-8.99

PPSD Results

Channel	Frequency (MHz)	Chain 0 Meas PPSD (dBm)	Chain 1 Meas PPSD (dBm)	Total Corr'd PPSD (dBm)	PPSD Limit (dBm)	PPSD Margin (dB)
Low	5530	-4.620	-6.266	-1.94	11.00	-12.94
Mid	5610	-5.258	-6.625	-2.46	11.00	-13.46

Note: the power readings above were measured with gated method, and the measurement was taken only during the ON time. No duty cycle correction was necessary.

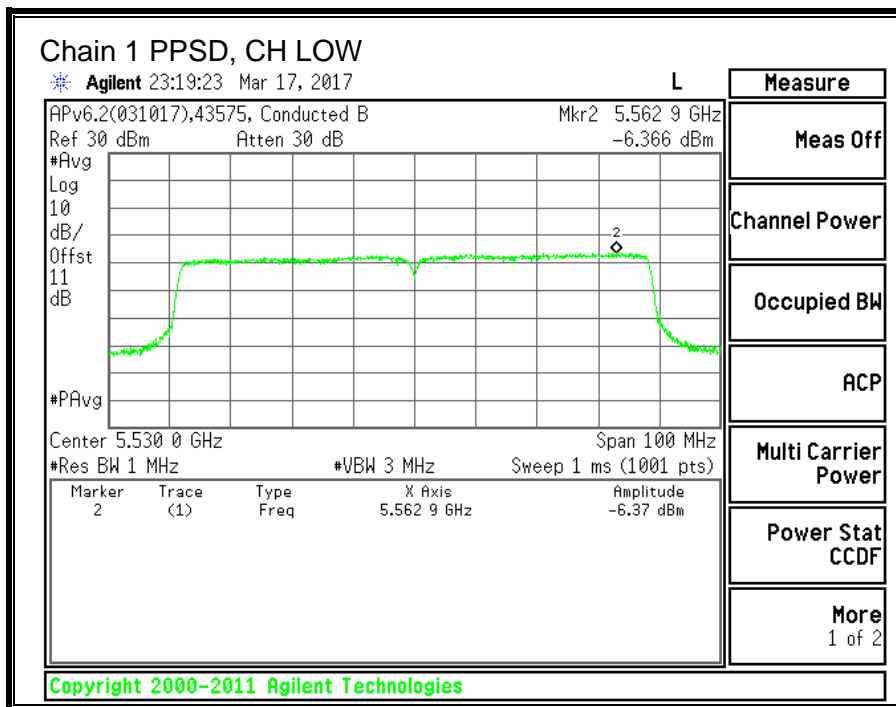
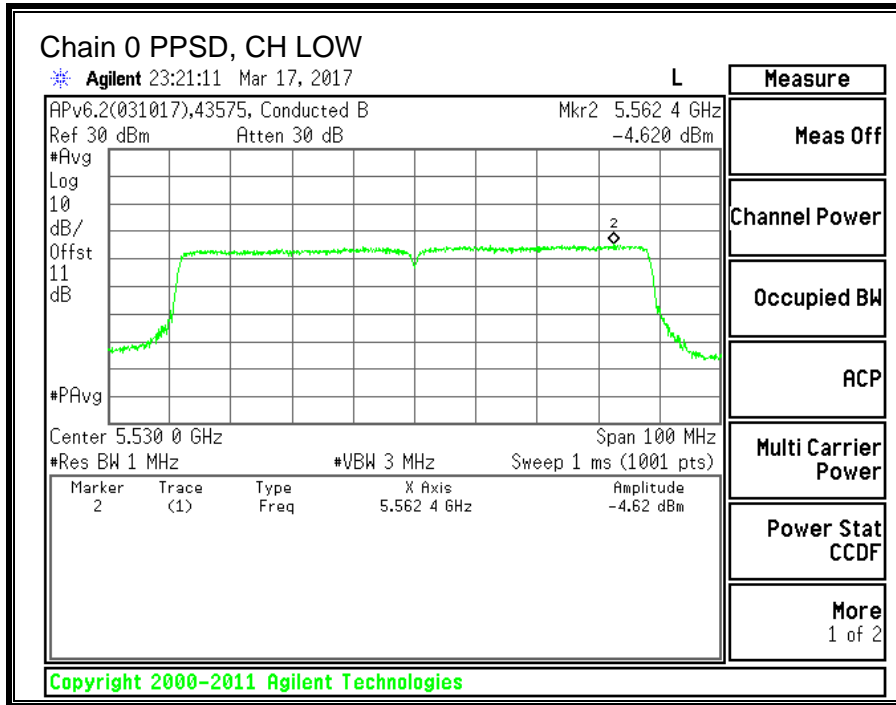

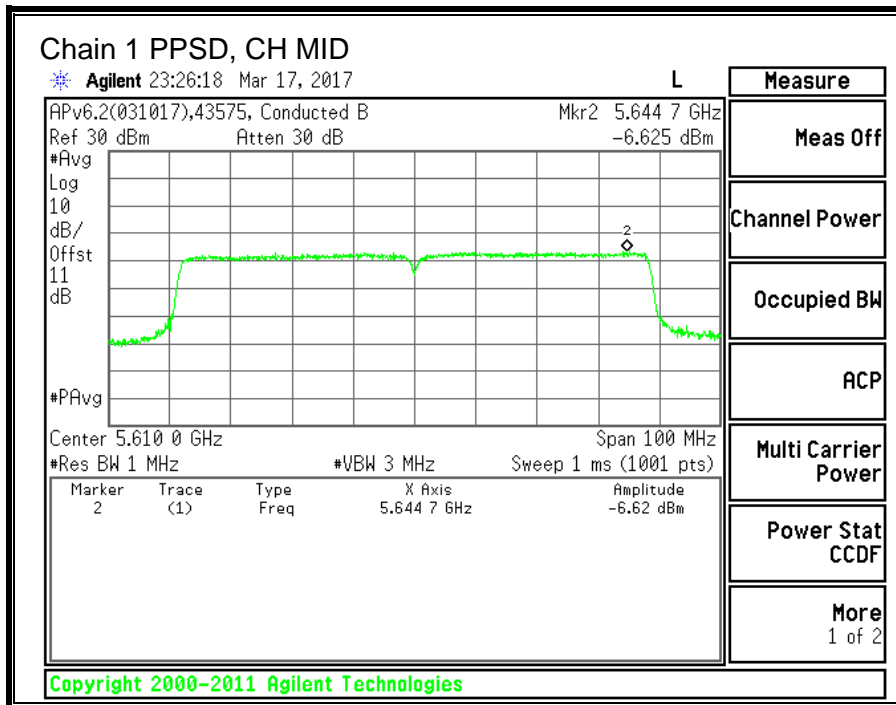
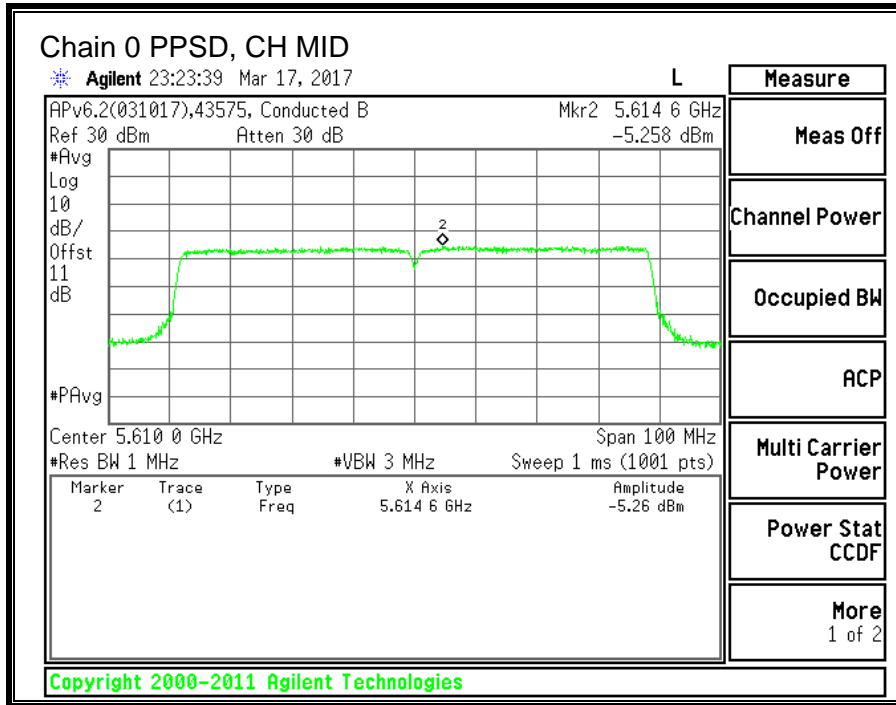

9.13. 11a 2TX CDD MIMO MODE IN THE 5.8GHz BAND

9.13.1. 6 dB BANDWIDTH

LIMITS

FCC §15.407 (e)

IC RSS-247 (6.2.4) (1)

The minimum 6 dB bandwidth shall be at least 500 kHz.

RESULTS

Channel	Frequency	6 dB BW Chain 0 (MHz)	6 dB BW Chain 1 (MHz)	Minimum Limit (MHz)
Low	5745	16.35	16.4	0.5
Mid	5785	16.45	16.45	0.5
High	5825	16.45	16.45	0.5

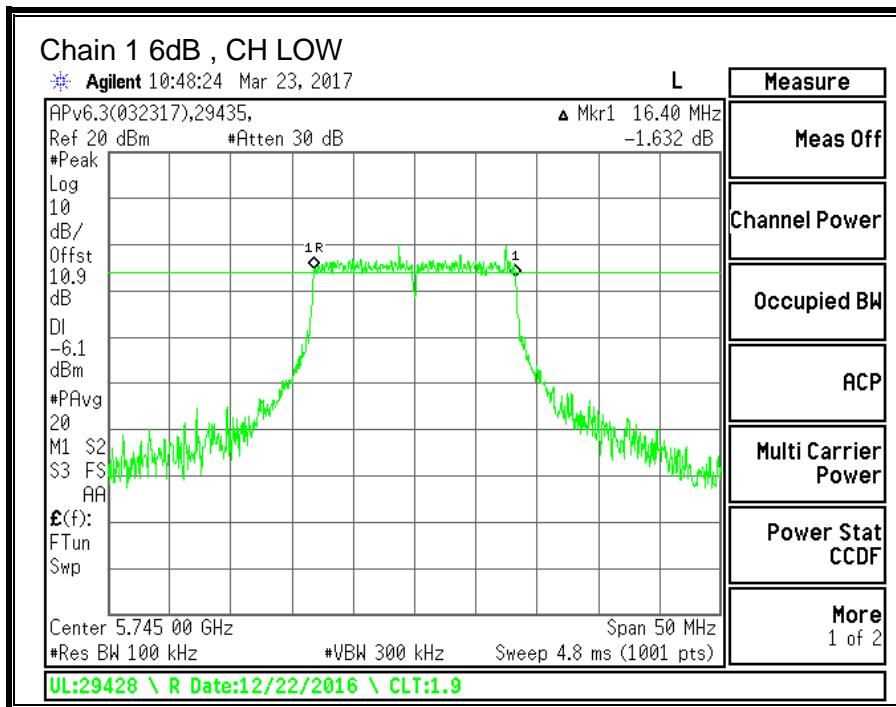
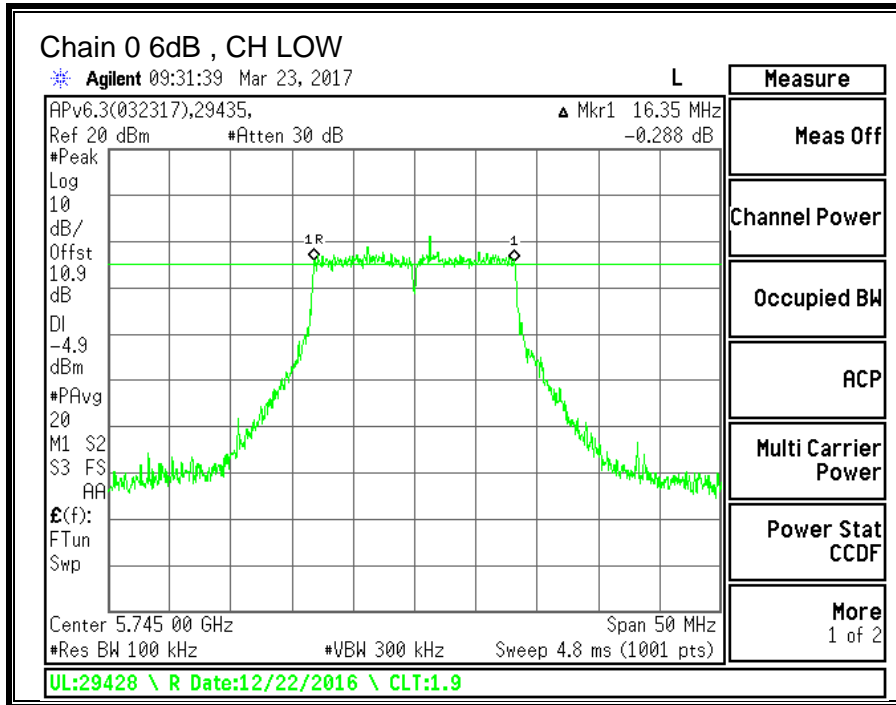

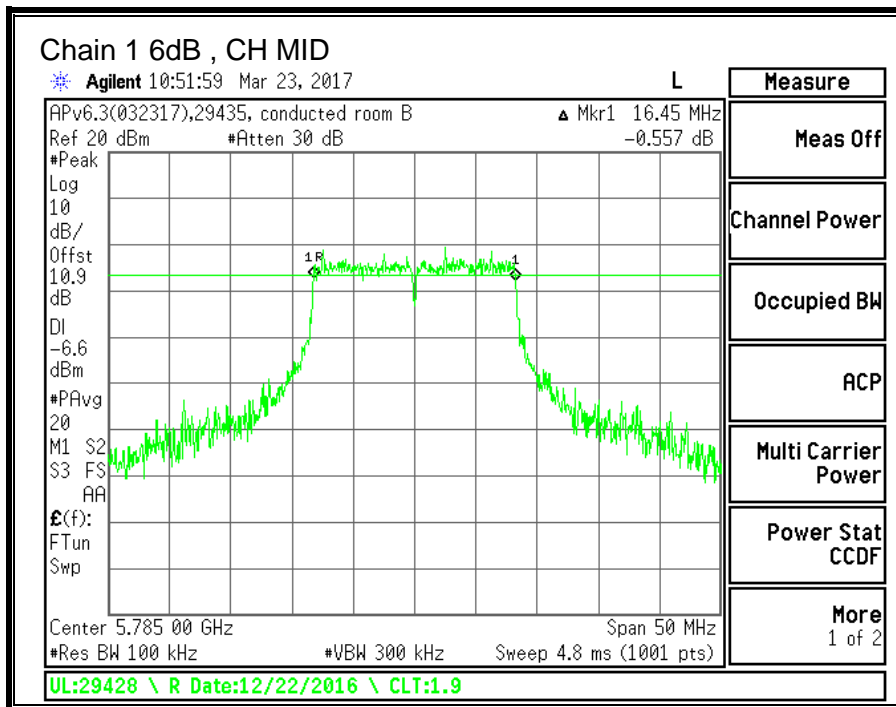
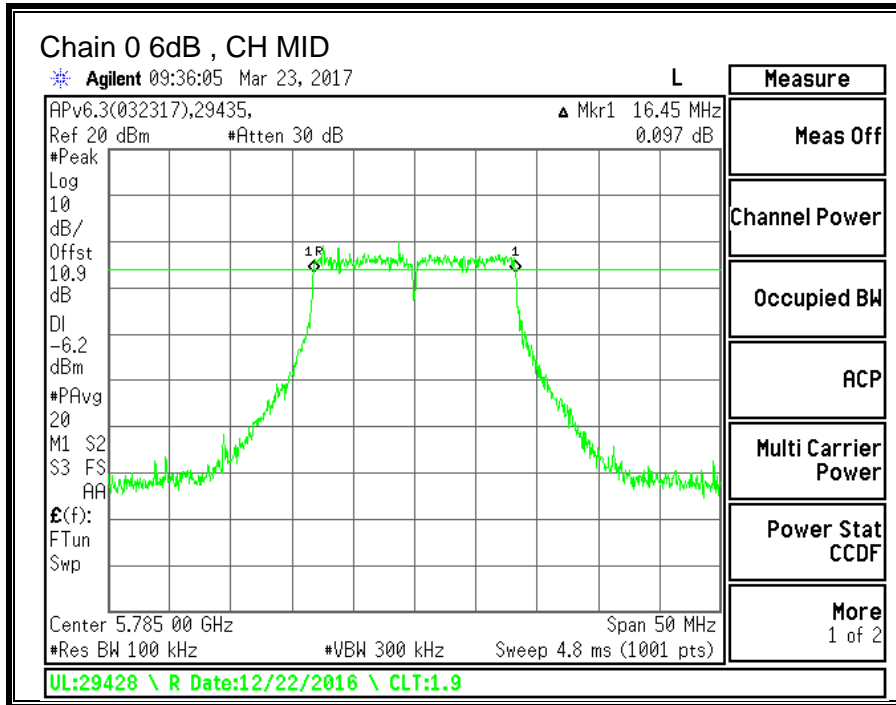

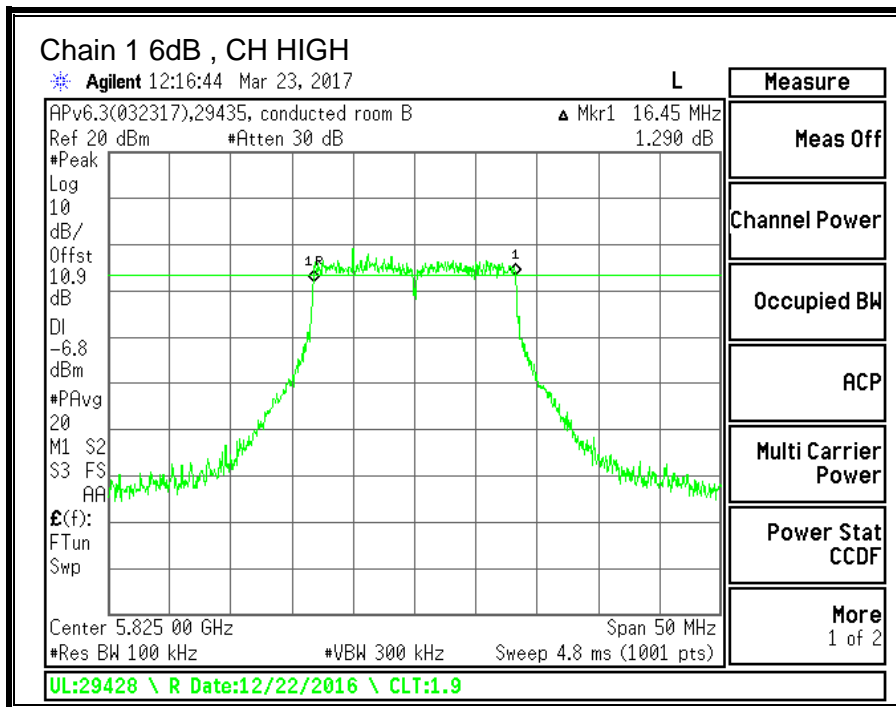
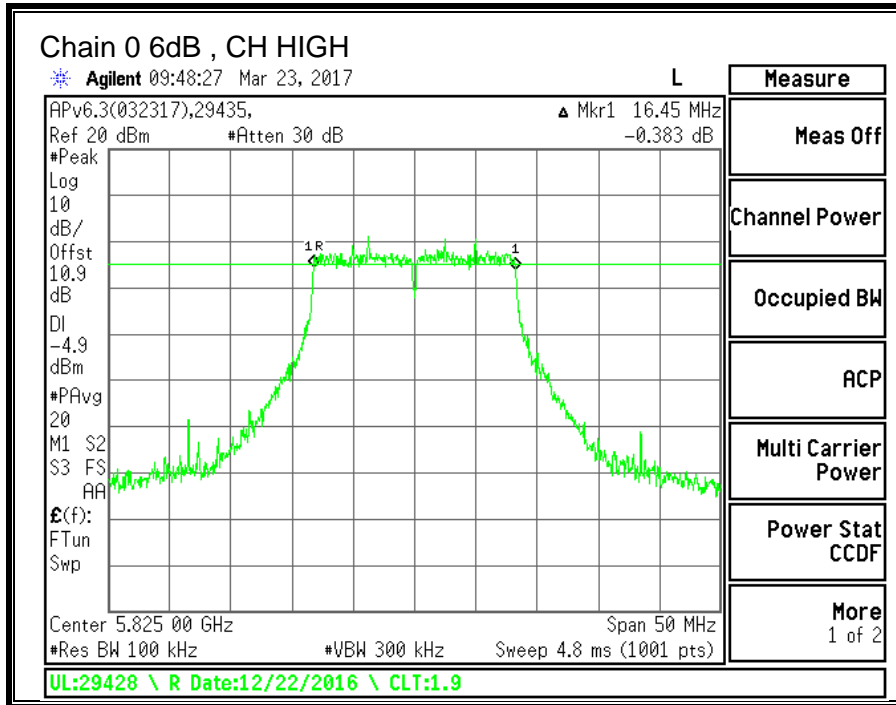

9.13.2. 99% BANDWIDTH

LIMITS

None; for reporting purposes only.

RESULTS

Channel	Frequency	99% BW Chain 0 (MHz)	99% BW Chain 1 (MHz)
Low	5745	16.5077	16.0437
Mid	5785	16.0545	16.0731
High	5825	16.3282	16.2159

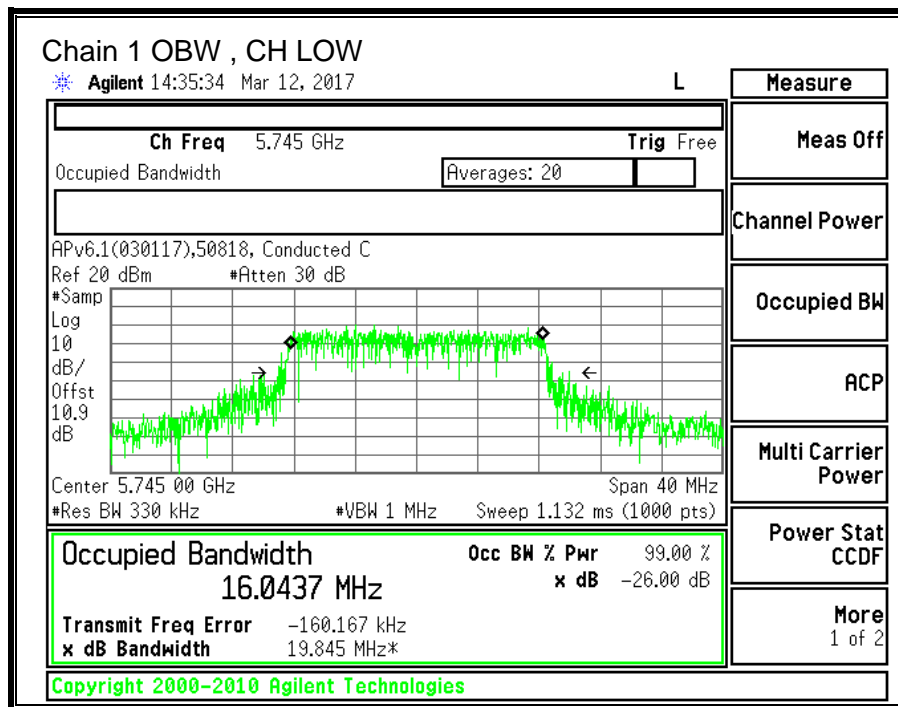
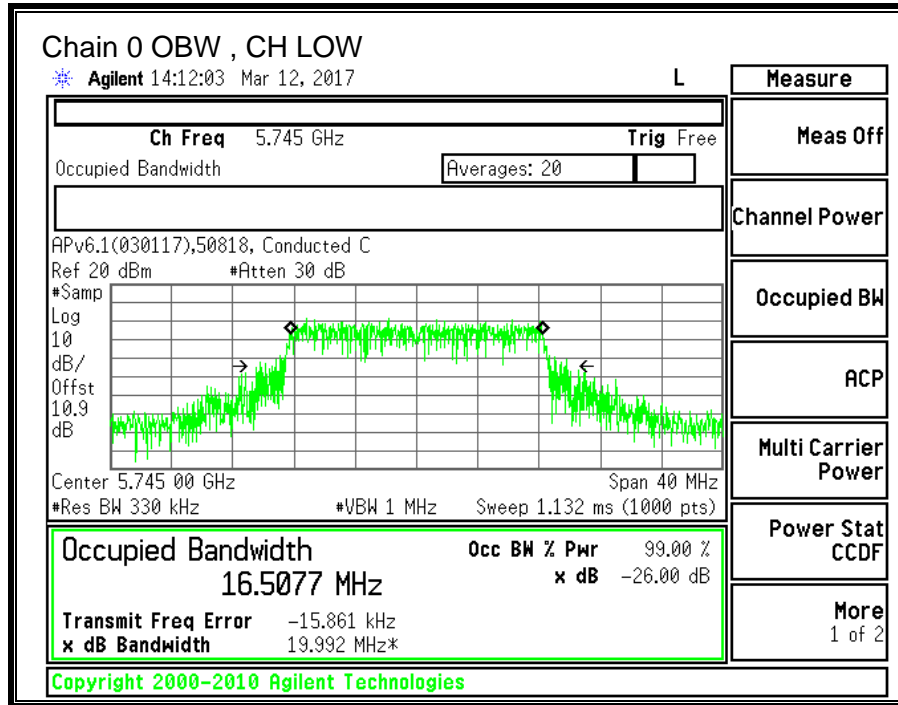

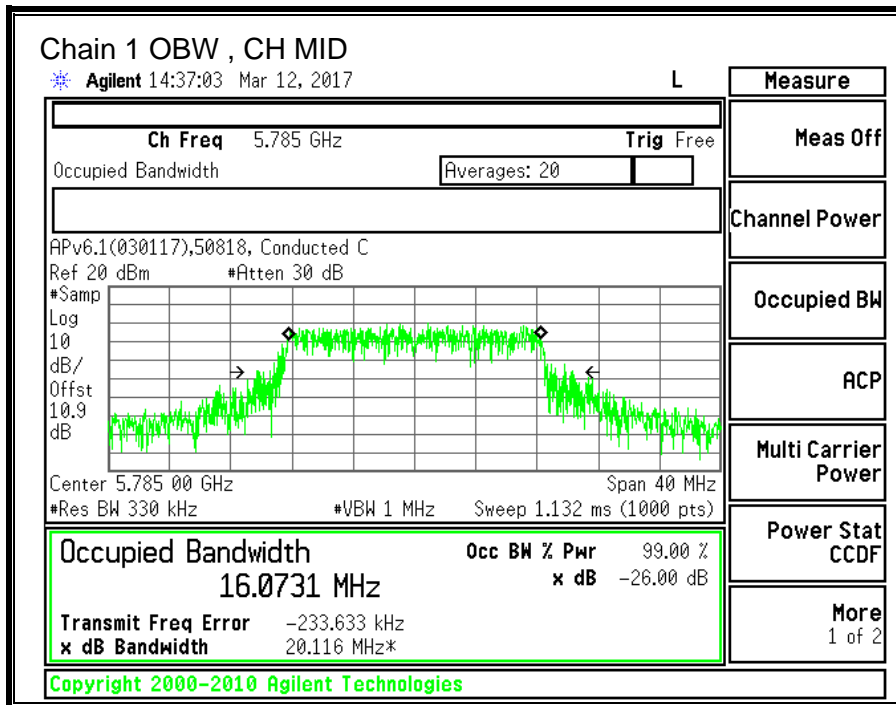
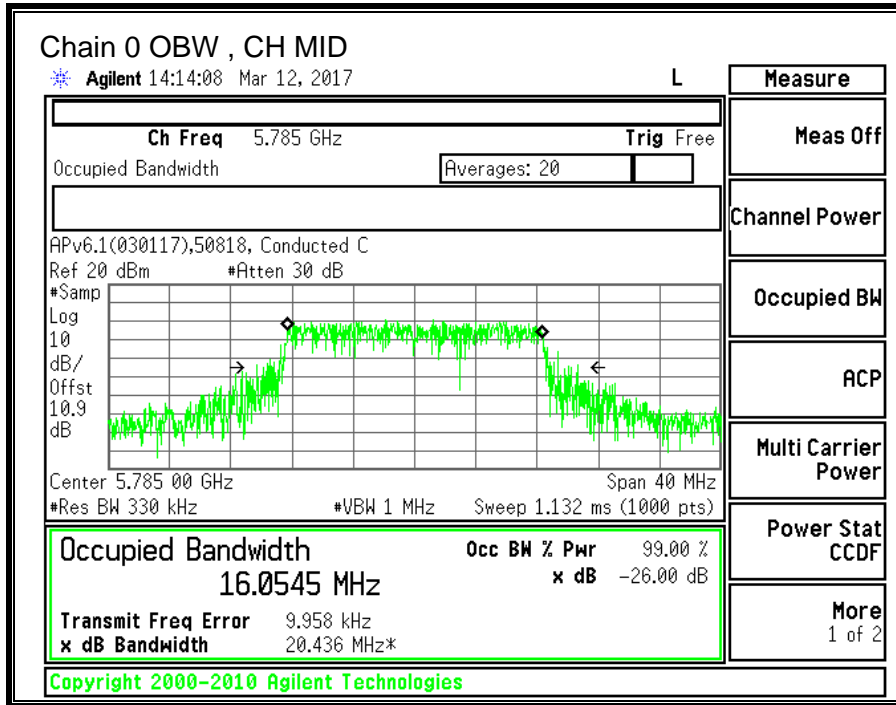

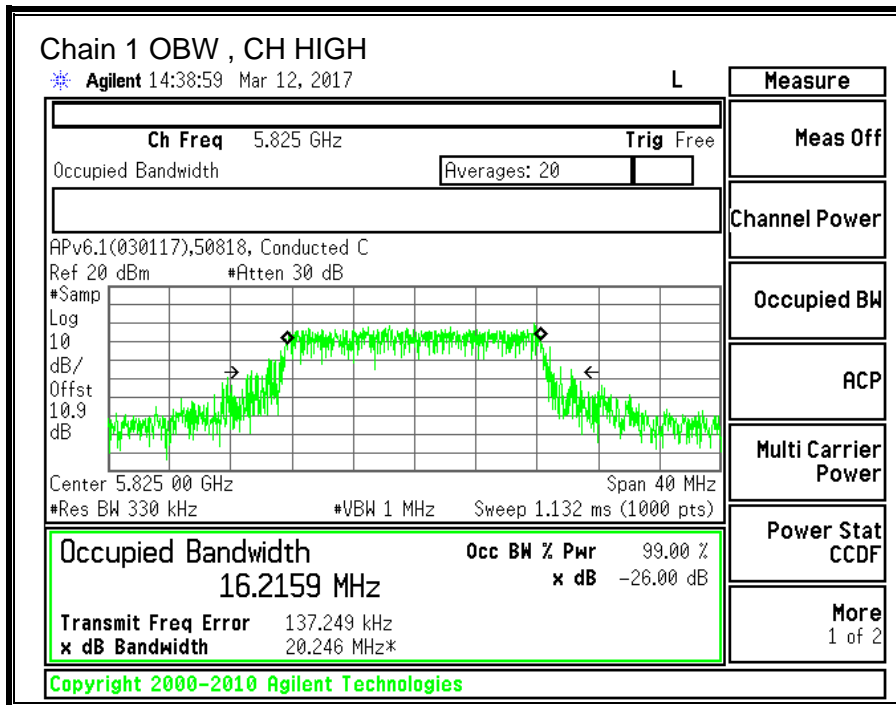
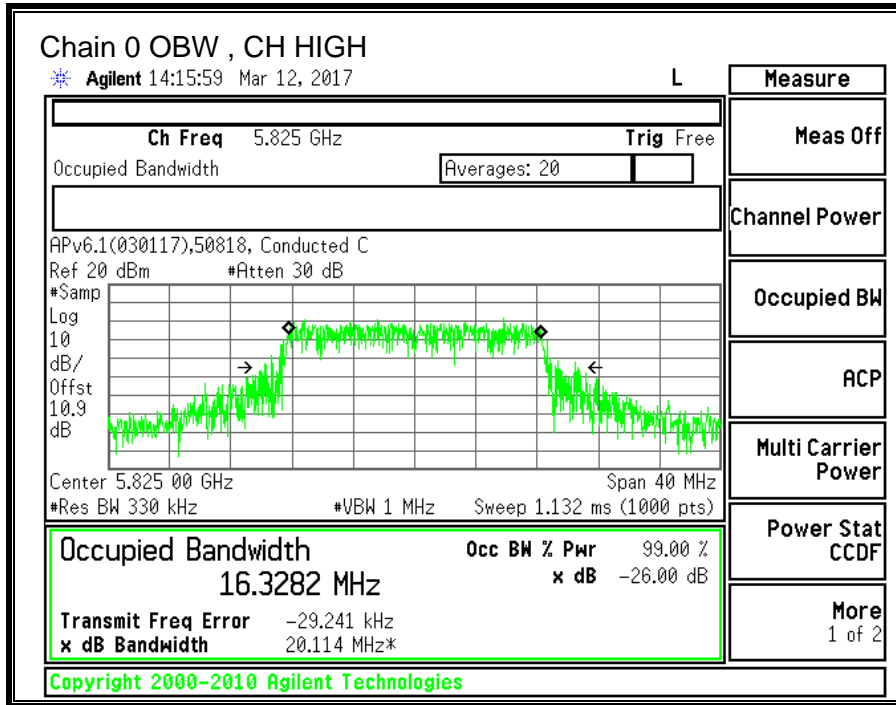

9.13.3. OUTPUT POWER AND PSD

LIMITS

FCC §15.407 (a) (3)

IC RSS-247 (6.2.4) (1)

For the band 5.725-5.85 GHz, the maximum conducted output power over the frequency band of operation shall not exceed 1 W. In addition, the maximum power spectral density shall not exceed 30 dBm in any 500-kHz band. If transmitting antennas of directional gain greater than 6 dBi are used, both the maximum conducted output power and the maximum power spectral density shall be reduced by the amount in dB that the directional gain of the antenna exceeds 6 dBi.

TEST PROCEDURE

Measurements perform using a wideband gated RF power meter provided that the gate parameters are adjusted such that the power is measured only when the EUT is transmitting at its maximum power control level. Since the measurement is made only during the ON time of the transmitter, no duty cycle correction factor is required.

DIRECTIONAL ANTENNA GAIN

For power, the TX chains are uncorrelated and the antenna gain is unequal among the chains. The directional gain is:

5725-5850 MHz

Chain 0 Antenna Gain (dBi)	Chain 1 Antenna Gain (dBi)	Uncorrelated Chains Directional Gain (dBi)
-3.00	-1.90	-2.42

For PSD the TX chains are correlated and the antenna gain is unequal among the chains. The directional gain is:

5725-5850 MHz

Chain 0 Antenna Gain (dBi)	Chain 1 Antenna Gain (dBi)	Correlated Chains Directional Gain (dBi)
-3.00	-1.90	0.58

RESULTS

ID:	43578	Date:	4/10/17
------------	-------	--------------	---------

Antenna Gain and Limit

Channel	Frequency (MHz)	Directional Gain for Power (dBi)	Directional Gain for PSD (dBi)	Power Limit (dBm)	Power Limit (dBm)
Low	5745	-2.42	0.58	30.00	30.00
Mid	5785	-2.42	0.58	30.00	30.00
High	5825	-2.42	0.58	30.00	30.00

Duty Cycle CF (dB)	0.24	Included in Calculations of Corr'd PSD
---------------------------	------	---

Output Power Results

Channel	Frequency (MHz)	Chain 0 Meas Power (dBm)	Chain 1 Meas Power (dBm)	Total Corr'd Power (dBm)	Power Limit (dBm)	Power Margin (dB)
Low	5745	12.80	11.25	15.10	30.00	-14.90
Mid	5785	12.81	11.22	15.10	30.00	-14.90
High	5825	11.92	10.72	14.37	30.00	-15.63

PSD Results

Channel	Frequency (MHz)	Chain 0 Meas PSD (dBm)	Chain 1 Meas PSD (dBm)	Total Corr'd PSD (dBm)	PSD Limit (dBm)	PSD Margin (dB)
Low	5745	-0.898	-2.701	1.54	30.00	-28.46
Mid	5785	-1.325	-2.571	1.35	30.00	-28.65
High	5825	-1.410	-2.781	1.21	30.00	-28.79

Note: the power readings above were measured with gated method, and the measurement was taken only during the ON time. No duty cycle correction was necessary.

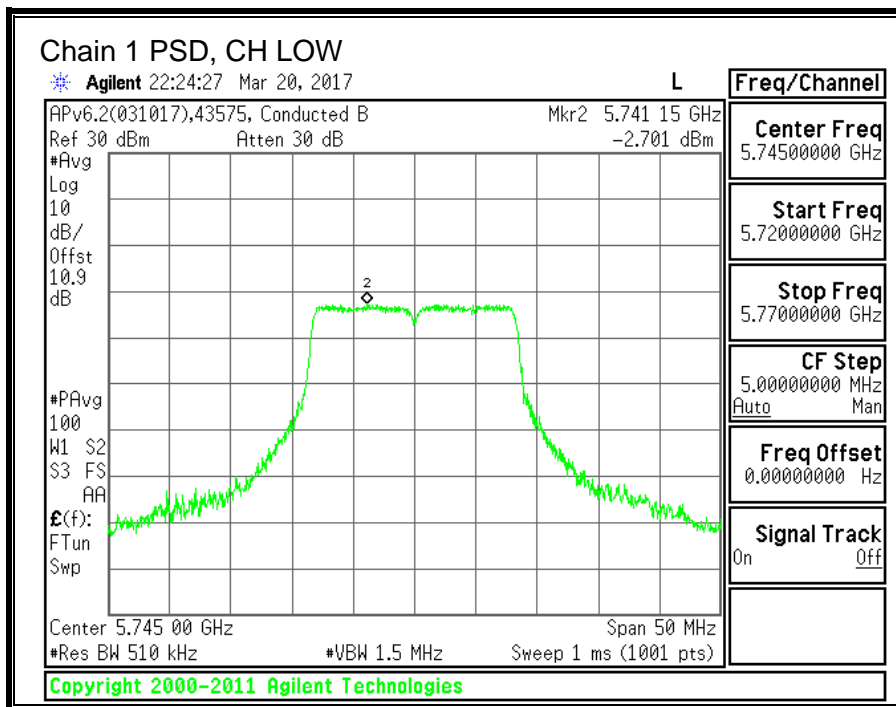
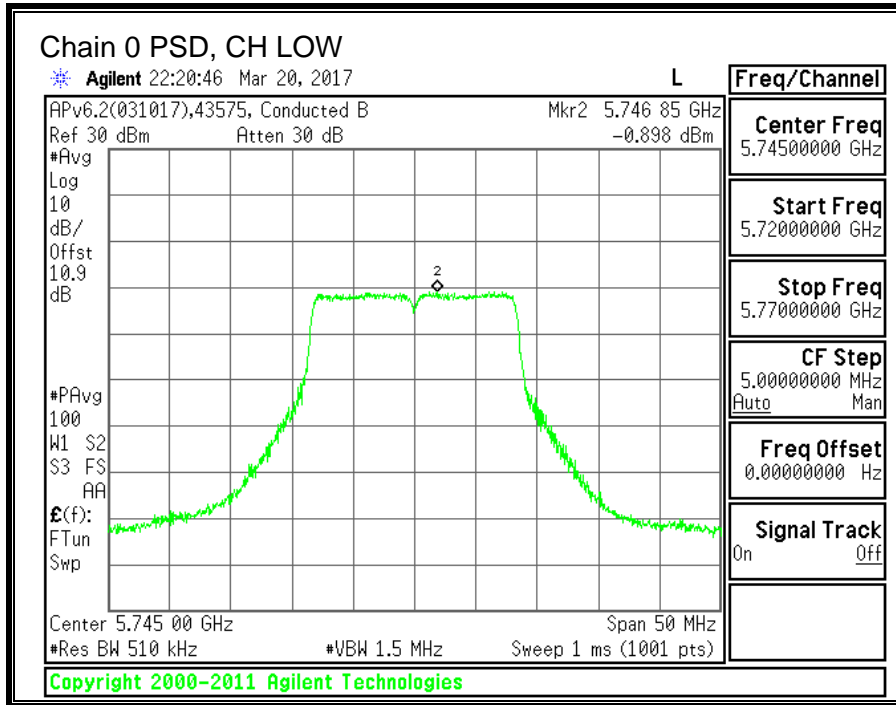

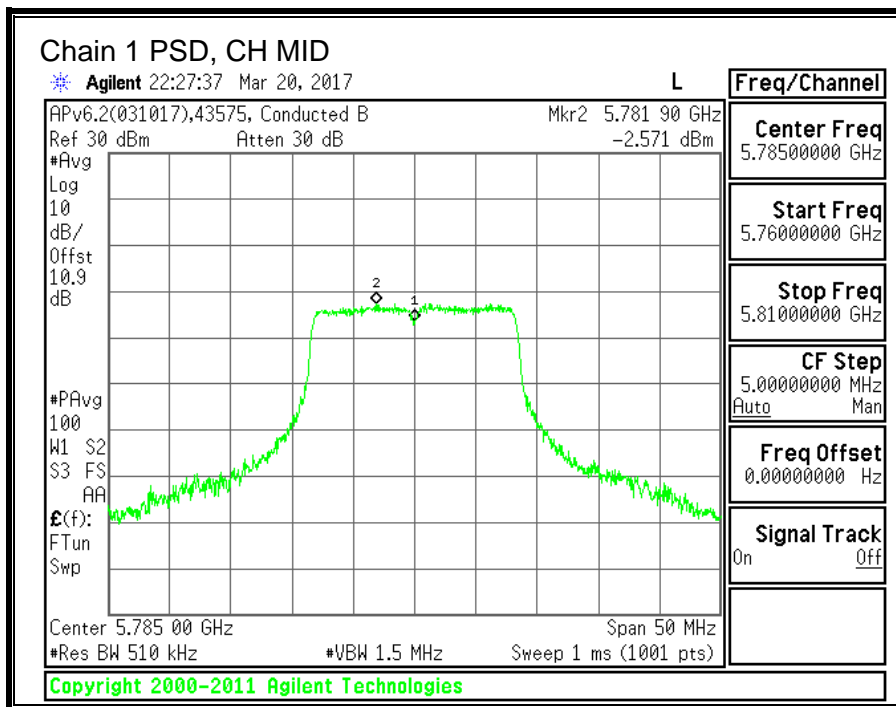
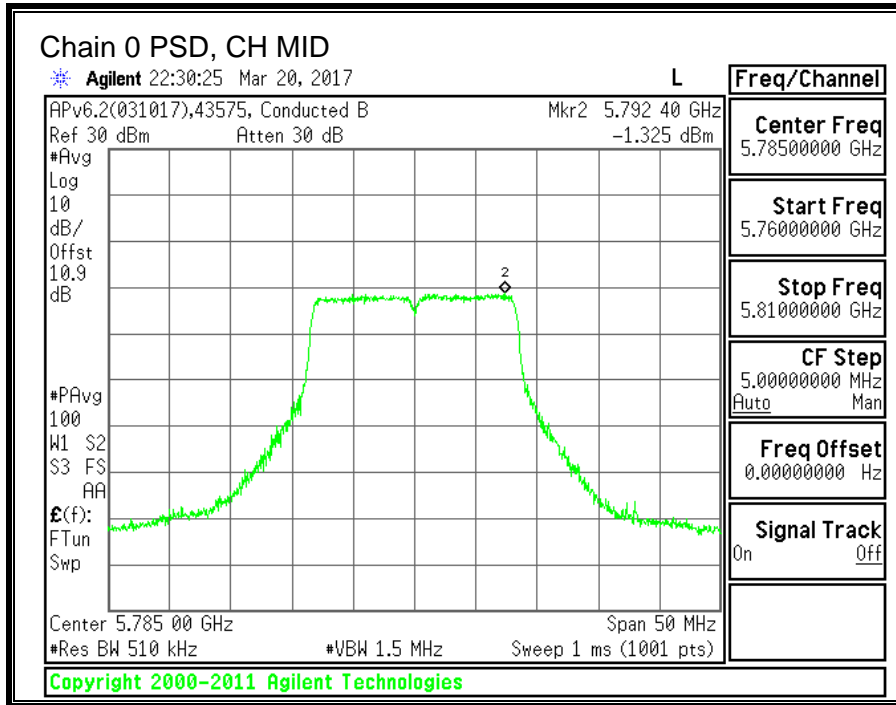

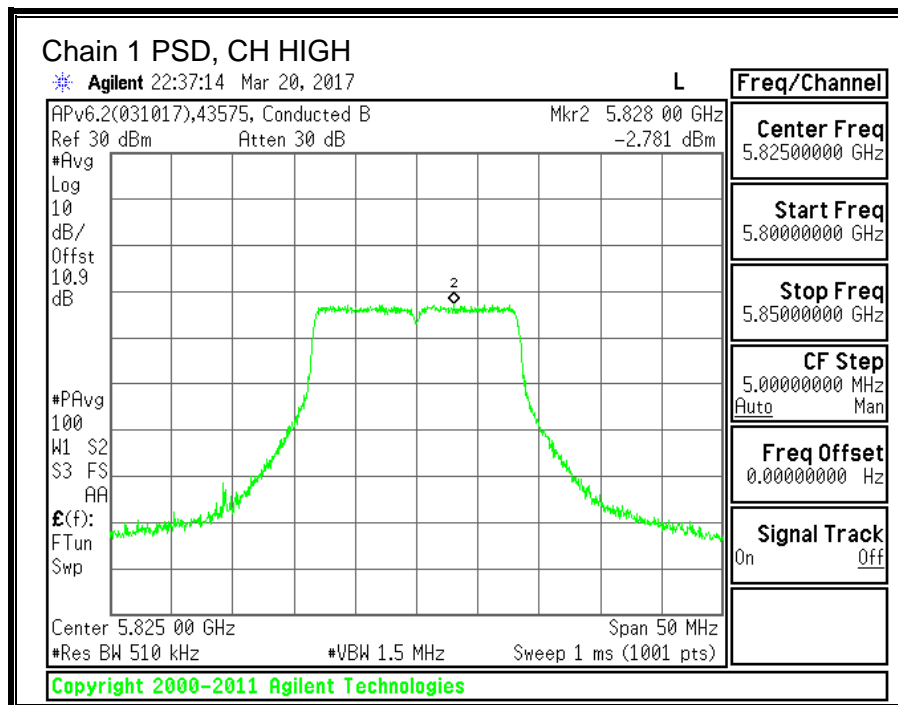
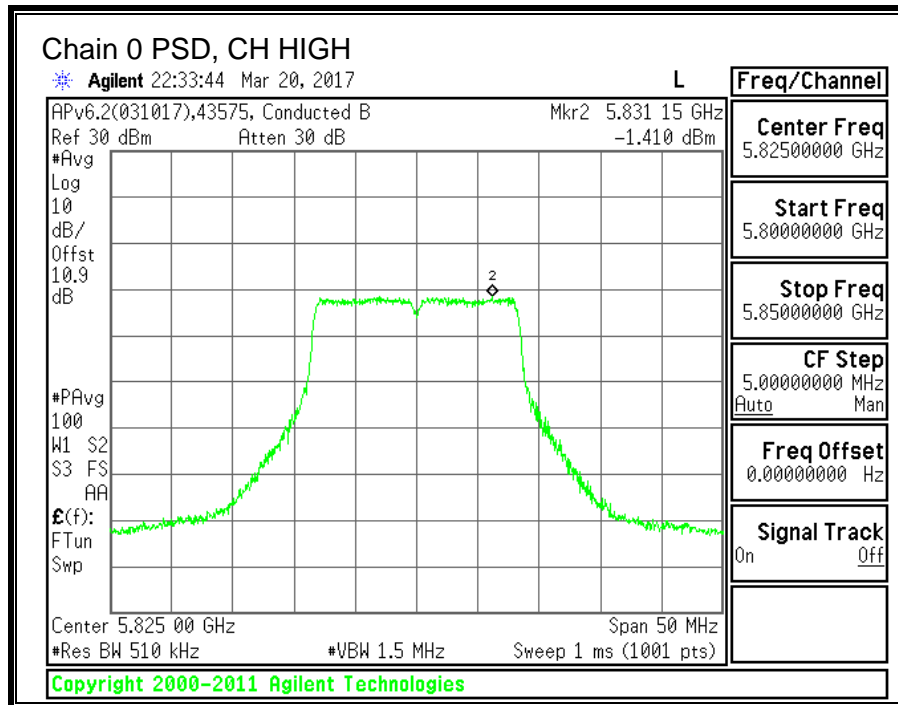

9.14. 11n HT20 2TX CDD MIMO MODE IN THE 5.8GHz BAND

9.14.1. 6 dB BANDWIDTH

LIMITS

FCC §15.407 (e)

IC RSS-247 (6.2.4) (1)

The minimum 6 dB bandwidth shall be at least 500 kHz.

RESULTS

Channel	Frequency	6 dB BW Chain 0 (MHz)	6 dB BW Chain 1 (MHz)	Minimum Limit (MHz)
Low	5745	17.65	17.65	0.5
Mid	5785	17.3	17.65	0.5
High	5825	17.1	17.7	0.5

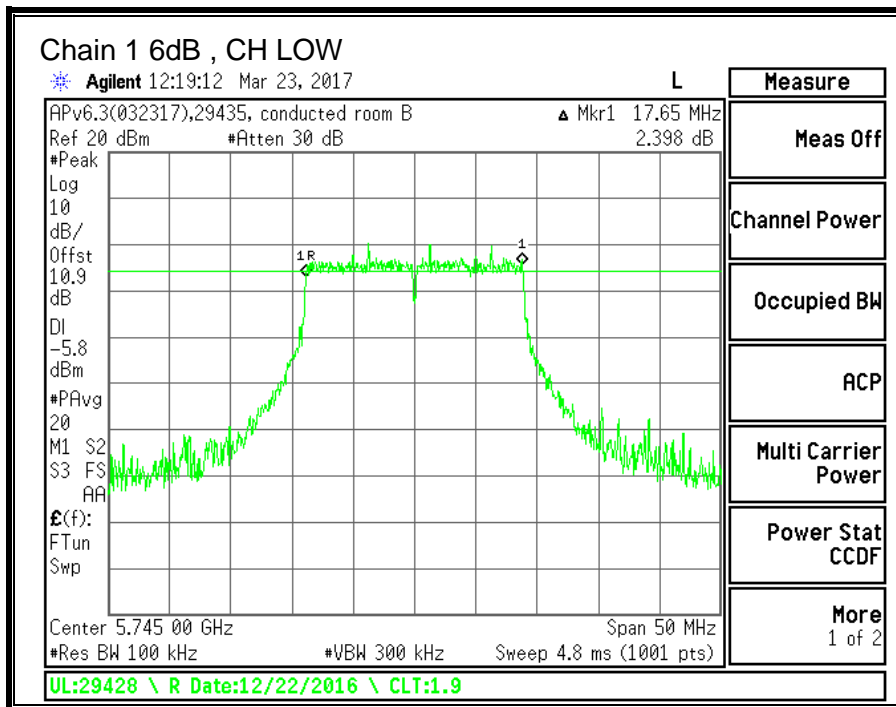
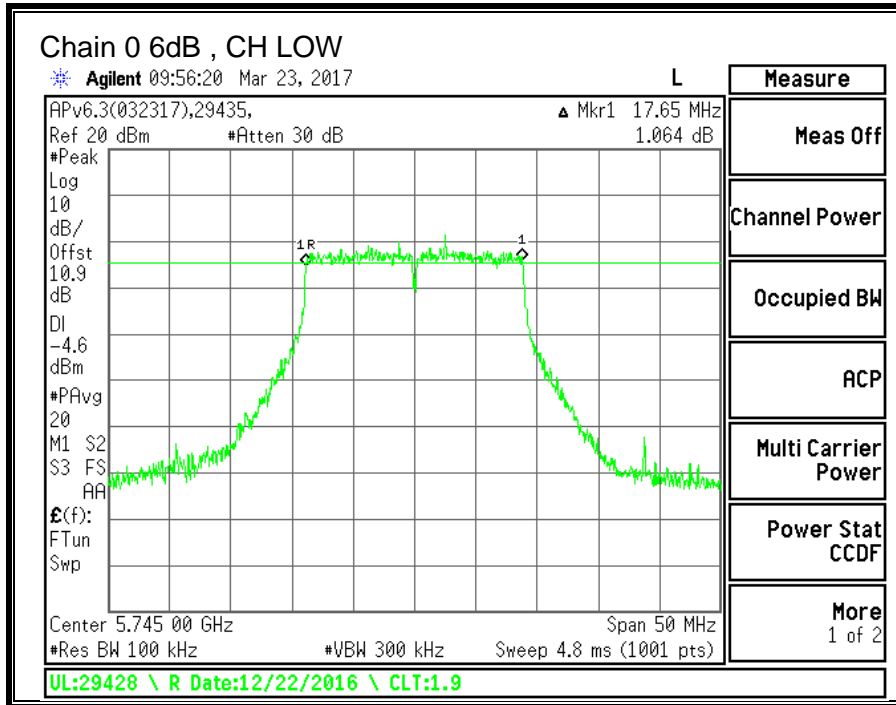

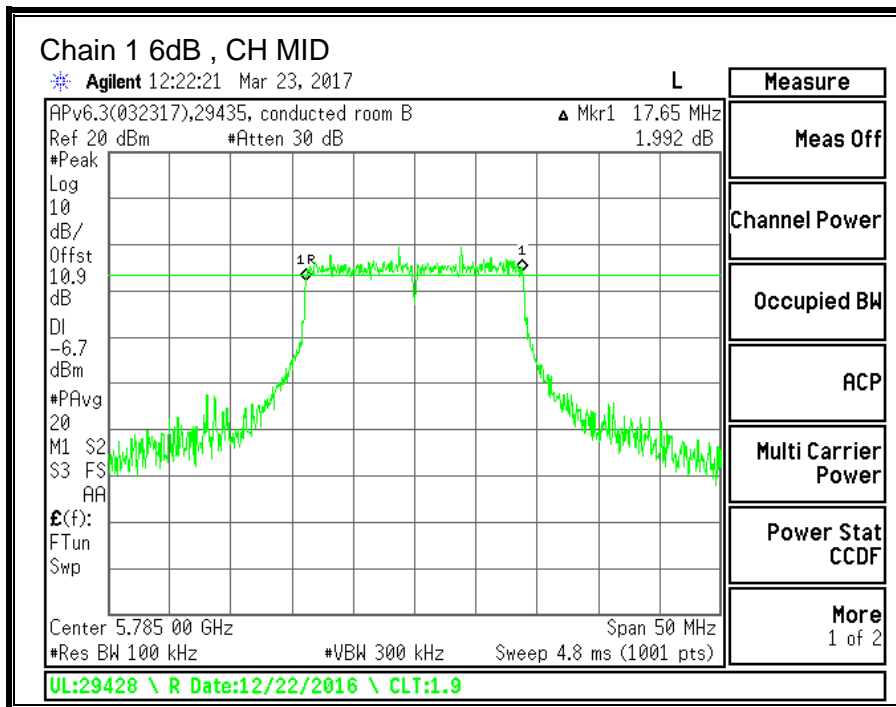
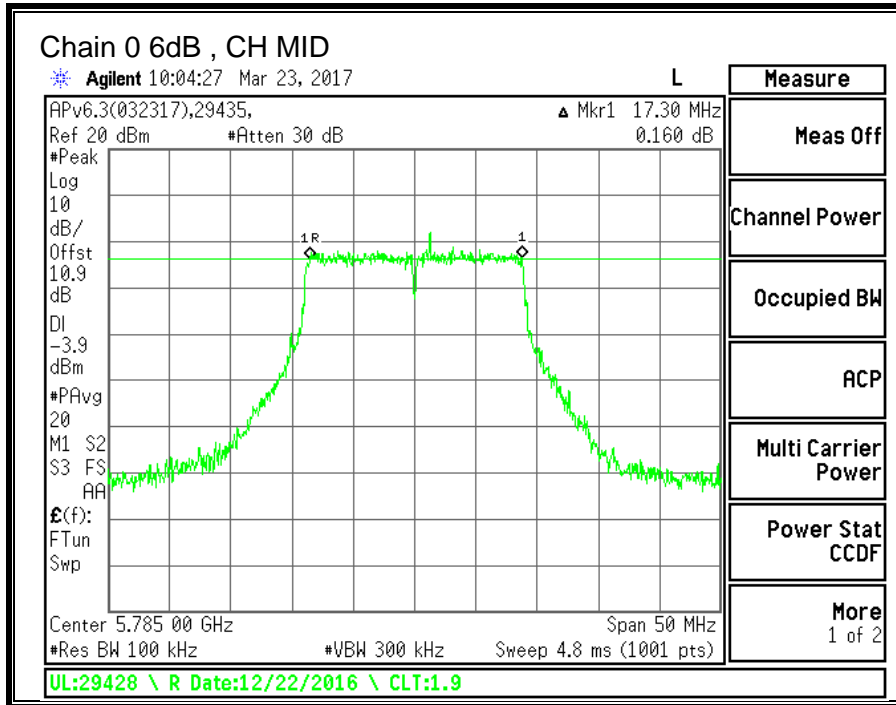

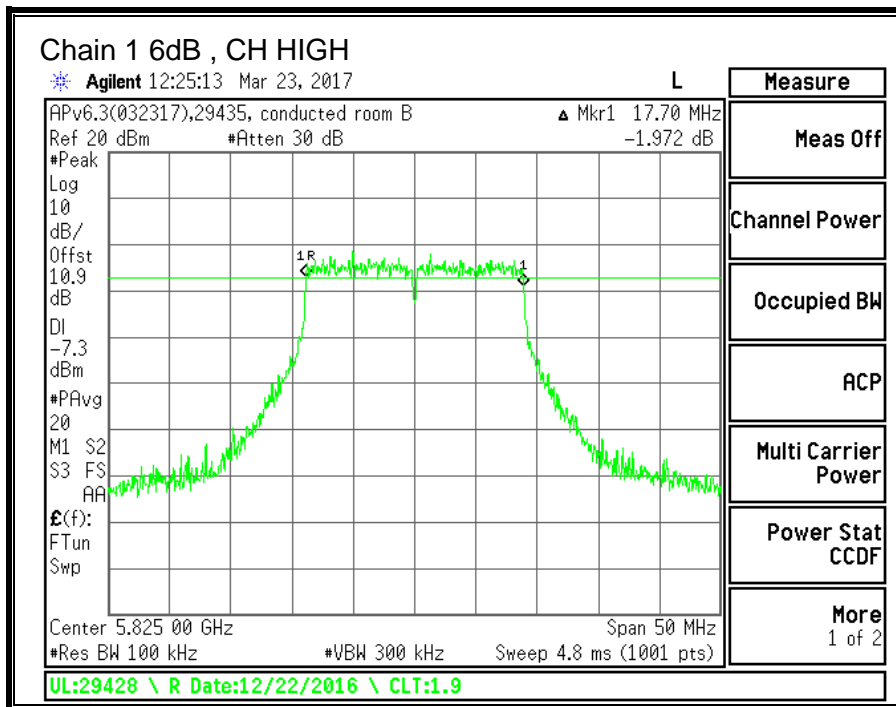
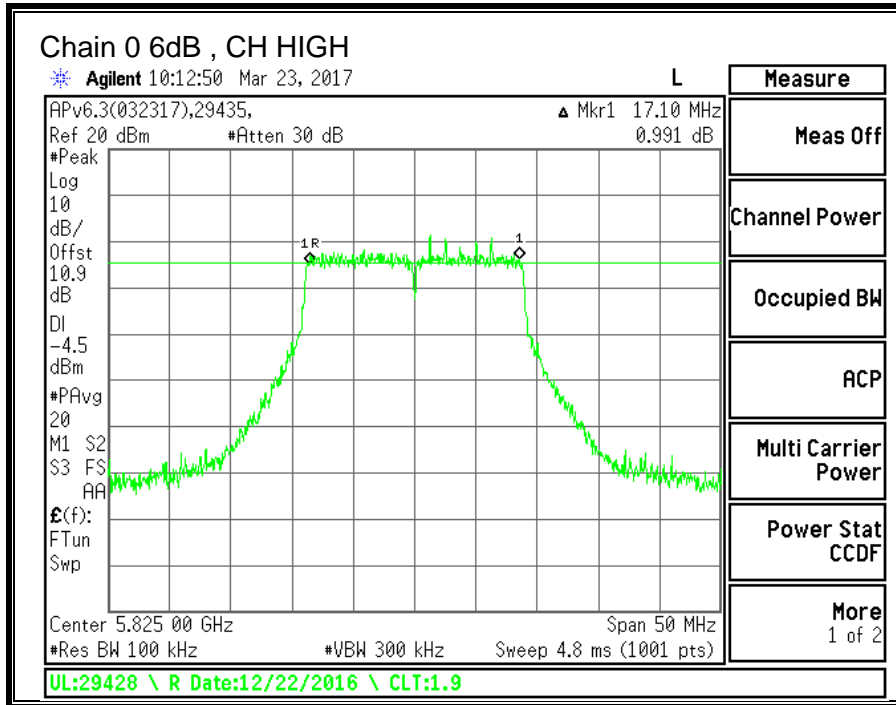

9.14.2. 99% BANDWIDTH

LIMITS

None; for reporting purposes only.

RESULTS

Channel	Frequency	99% BW Chain 0 (MHz)	99% BW Chain 1 (MHz)
Low	5745	17.6143	17.7626
Mid	5785	17.7516	17.7339
High	5825	17.7441	17.7241

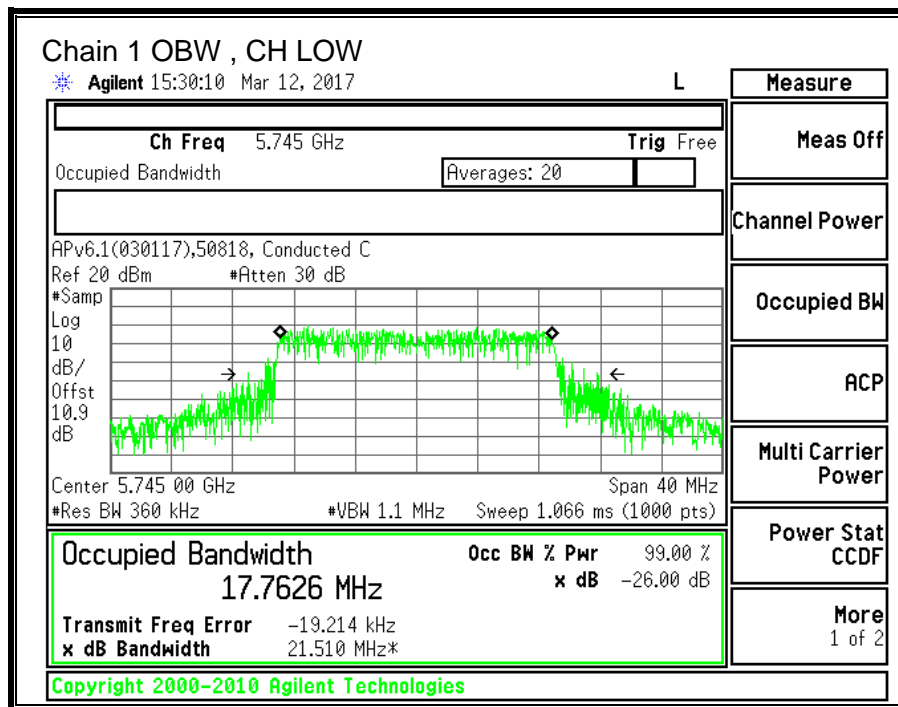
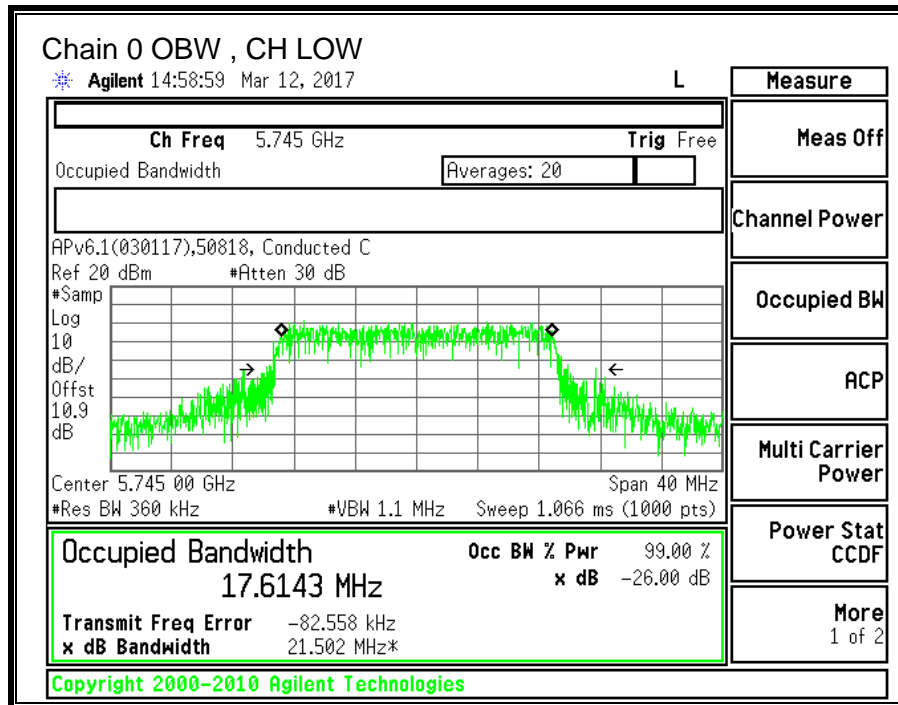

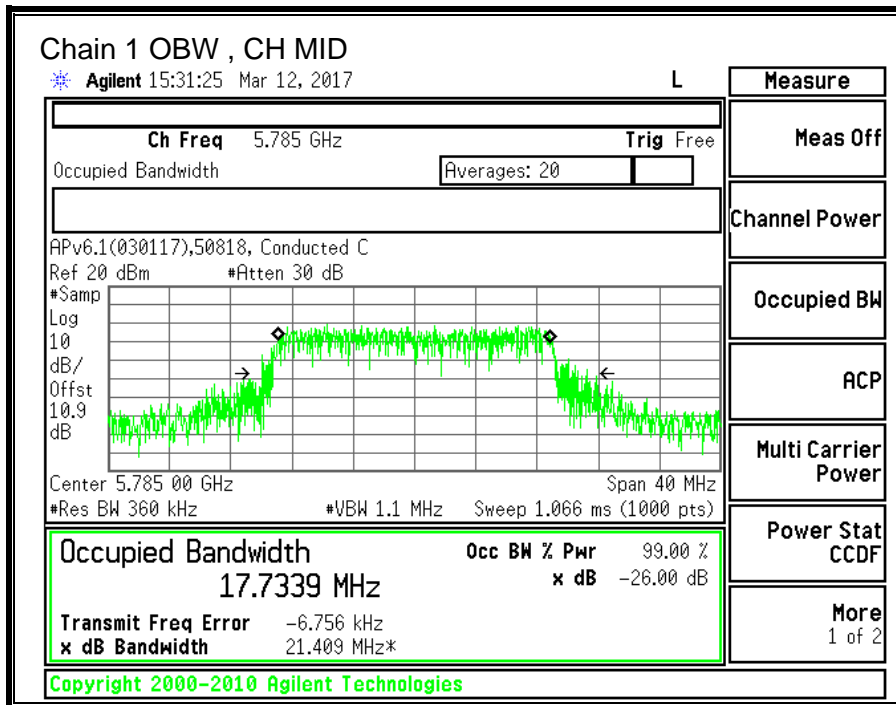
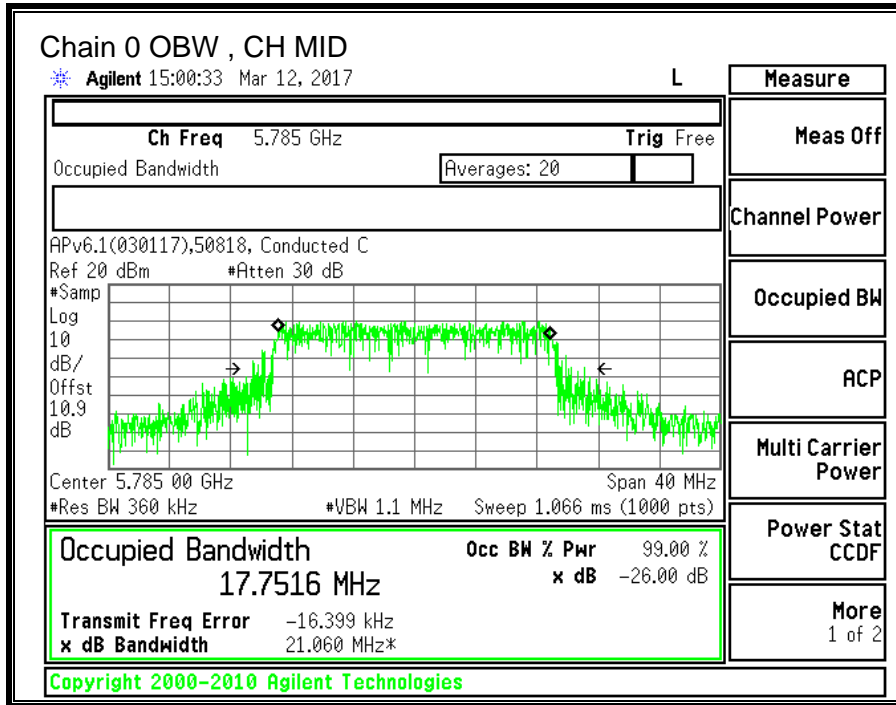

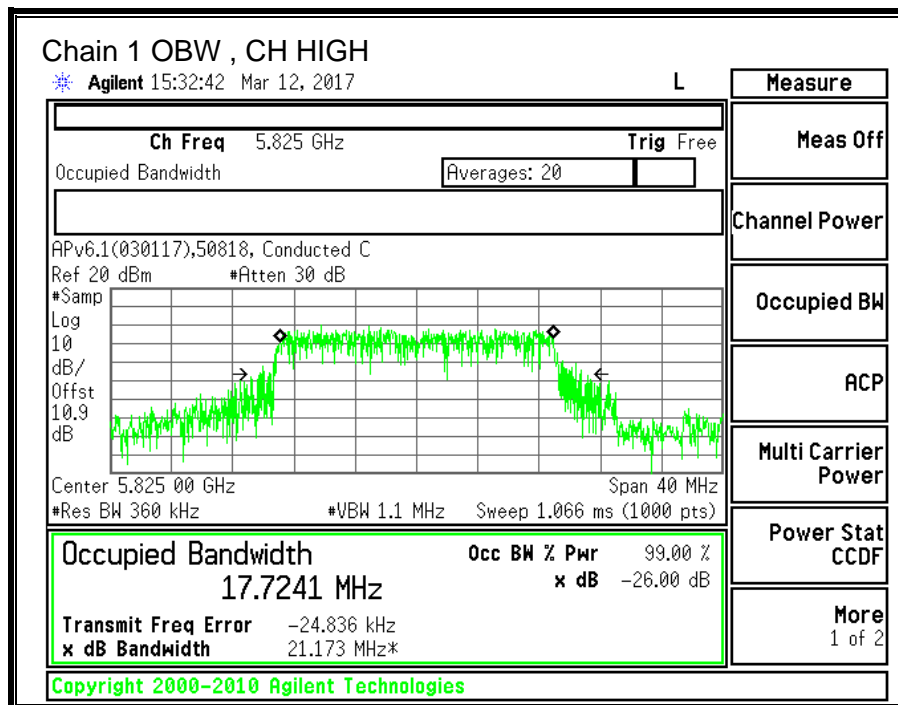
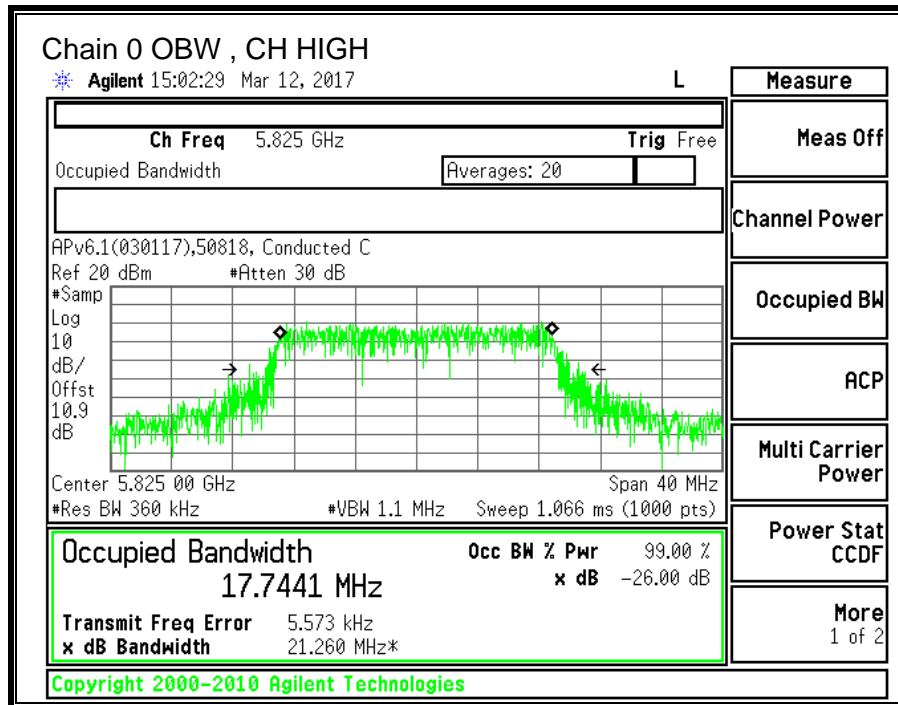

9.14.3. OUTPUT POWER AND PSD

LIMITS

FCC §15.407 (a) (3)

IC RSS-247 (6.2.4) (1)

For the band 5.725-5.85 GHz, the maximum conducted output power over the frequency band of operation shall not exceed 1 W. In addition, the maximum power spectral density shall not exceed 30 dBm in any 500-kHz band. If transmitting antennas of directional gain greater than 6 dBi are used, both the maximum conducted output power and the maximum power spectral density shall be reduced by the amount in dB that the directional gain of the antenna exceeds 6 dBi.

TEST PROCEDURE

Measurements perform using a wideband gated RF power meter provided that the gate parameters are adjusted such that the power is measured only when the EUT is transmitting at its maximum power control level. Since the measurement is made only during the ON time of the transmitter, no duty cycle correction factor is required.

DIRECTIONAL ANTENNA GAIN

For power, the TX chains are uncorrelated and the antenna gain is equal among the chains. The directional gain is:

5725-5850 MHz

Antenna Gain (dBi)	Antenna Gain (dBi)	Directional Gain (dBi)
-3.00	-1.90	-2.42

For PSD the TX chains are correlated and the antenna gain is equal among the chains. The directional gain is:

5725-5850 MHz

Chain 0 Antenna Gain (dBi)	Chain 1 Antenna Gain (dBi)	Correlated Chains Directional Gain (dBi)
-3.00	-1.90	0.58

RESULTS

ID:	43578	Date:	3/20/17
------------	-------	--------------	---------

Antenna Gain and Limit

Channel	Frequency (MHz)	Directional Gain for Power (dBi)	Directional Gain for PSD (dBi)	Power Limit (dBm)	Power Limit (dBm)
Low	5745	-2.42	0.58	30.00	30.00
Mid	5785	-2.42	0.58	30.00	30.00
High	5825	-2.42	0.58	30.00	30.00

Duty Cycle CF (dB)	0.10	Included in Calculations of Corr'd PSD
---------------------------	------	---

Output Power Results

Channel	Frequency (MHz)	Chain 0 Meas Power (dBm)	Chain 1 Meas Power (dBm)	Total Corr'd Power (dBm)	Power Limit (dBm)	Power Margin (dB)
Low	5745	12.81	11.13	15.06	30.00	-14.94
Mid	5785	12.86	11.23	15.13	30.00	-14.87
High	5825	12.60	11.08	14.92	30.00	-15.08

PSD Results

Channel	Frequency (MHz)	Chain 0 Meas PSD (dBm)	Chain 1 Meas PSD (dBm)	Total Corr'd PSD (dBm)	PSD Limit (dBm)	PSD Margin (dB)
Low	5745	-1.100	-2.960	1.18	30.00	-28.82
Mid	5785	-1.475	-3.114	0.89	30.00	-29.11
High	5825	-1.650	-3.125	0.79	30.00	-29.21

Note: the power readings above were measured with gated method, and the measurement was taken only during the ON time. No duty cycle correction was necessary.

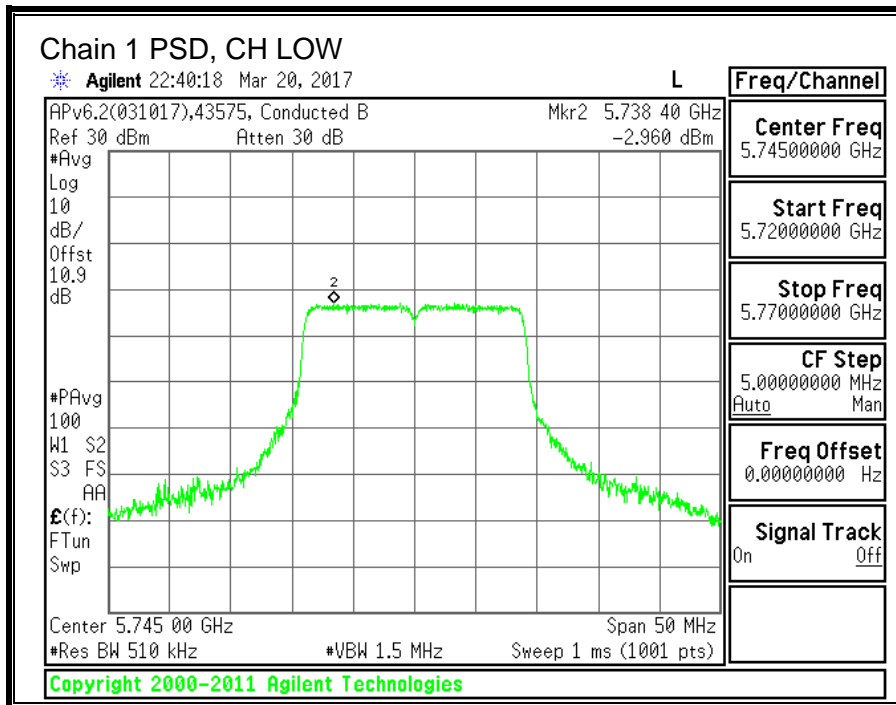
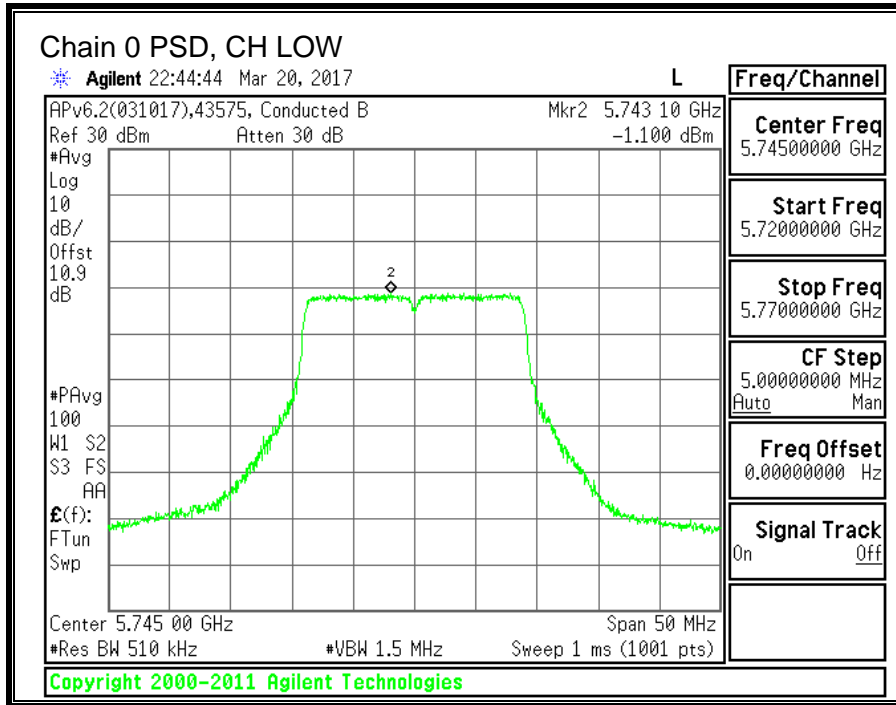

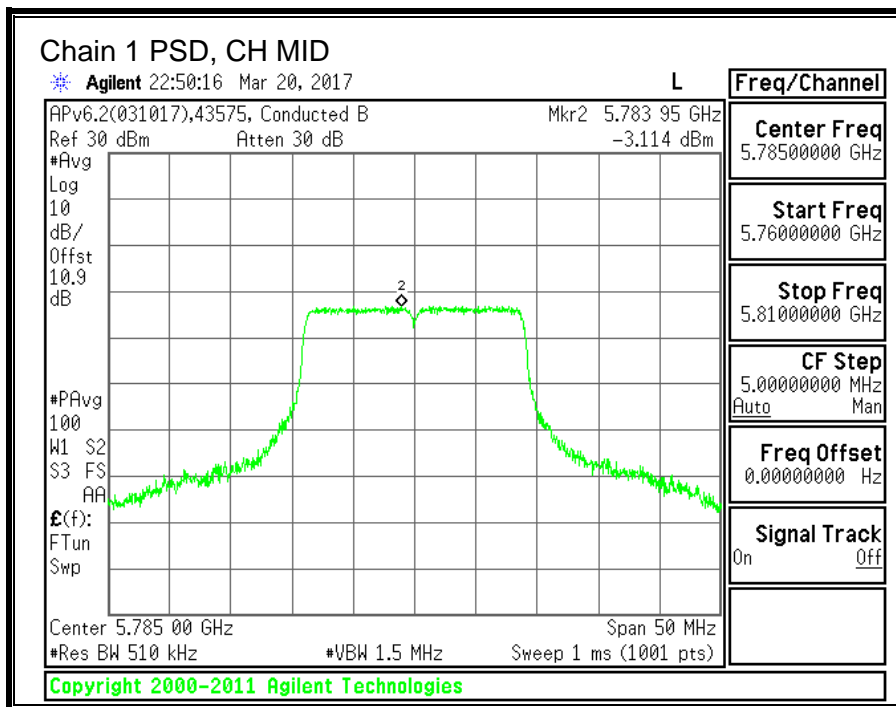
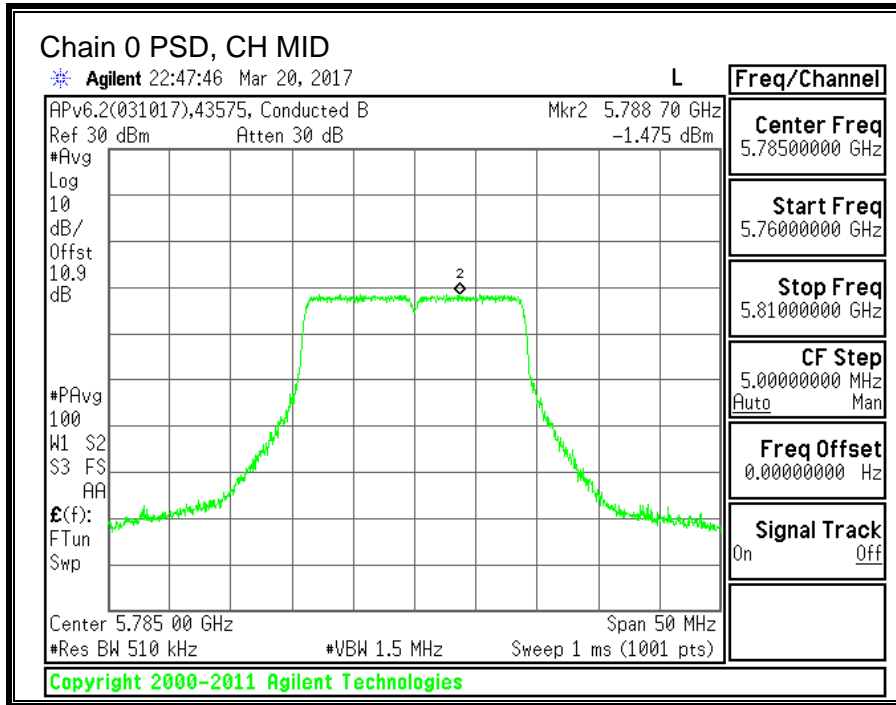

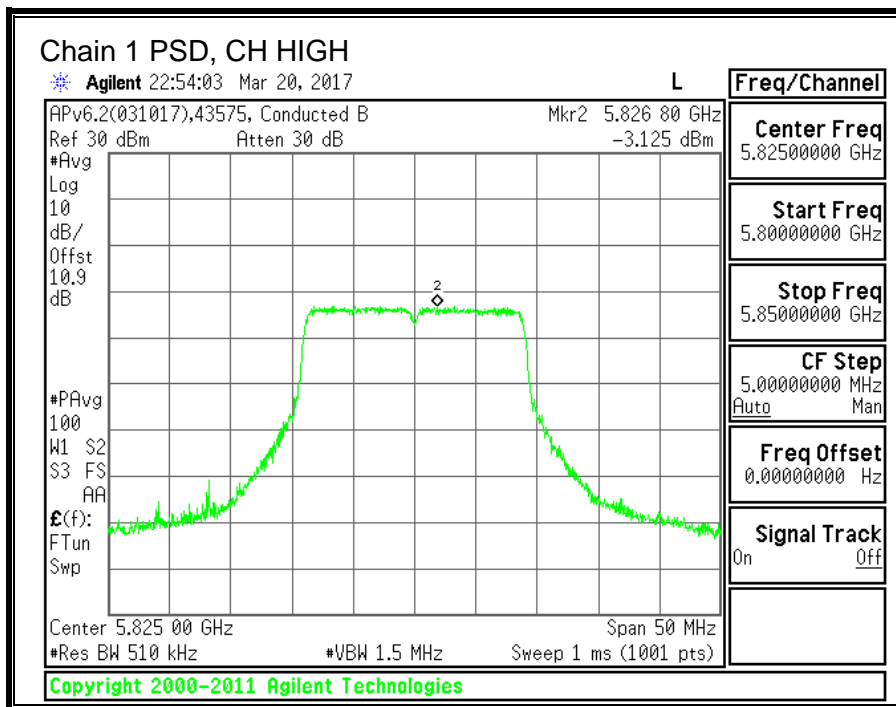
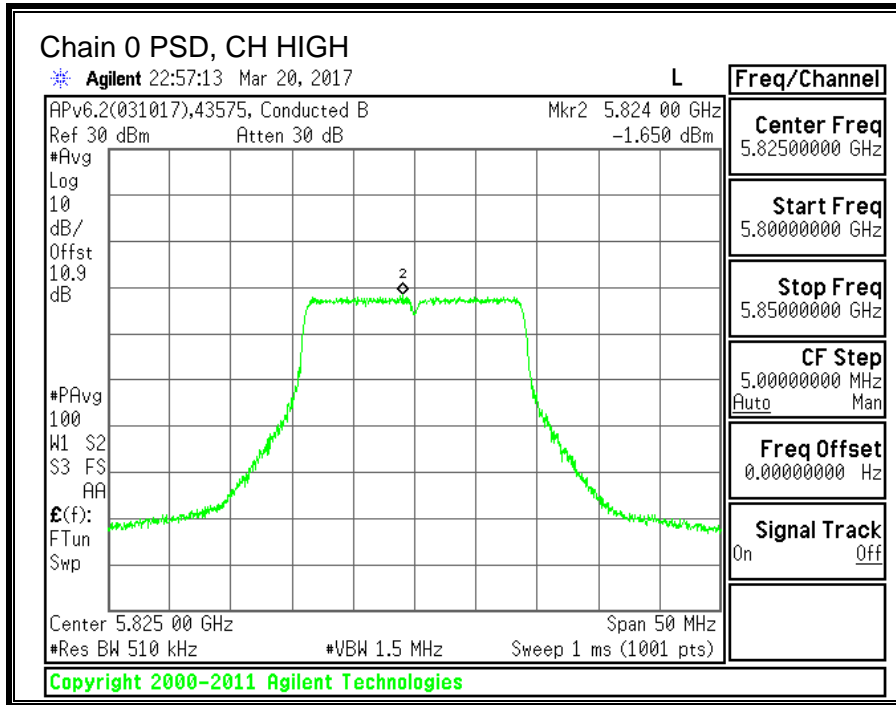

9.15. 11n HT40 2TX CDD MIMO MODE IN THE 5.8GHz BAND

9.15.1. 6 dB BANDWIDTH

LIMITS

FCC §15.407 (e)

IC RSS-247 (6.2.4) (1)

The minimum 6 dB bandwidth shall be at least 500 kHz.

RESULTS

Channel	Frequency	6 dB BW Chain 0 (MHz)	6 dB BW Chain 1 (MHz)	Minimum Limit (MHz)
Low	5755	36.3	36.3	0.5
High	5795	36.4	36.4	0.5

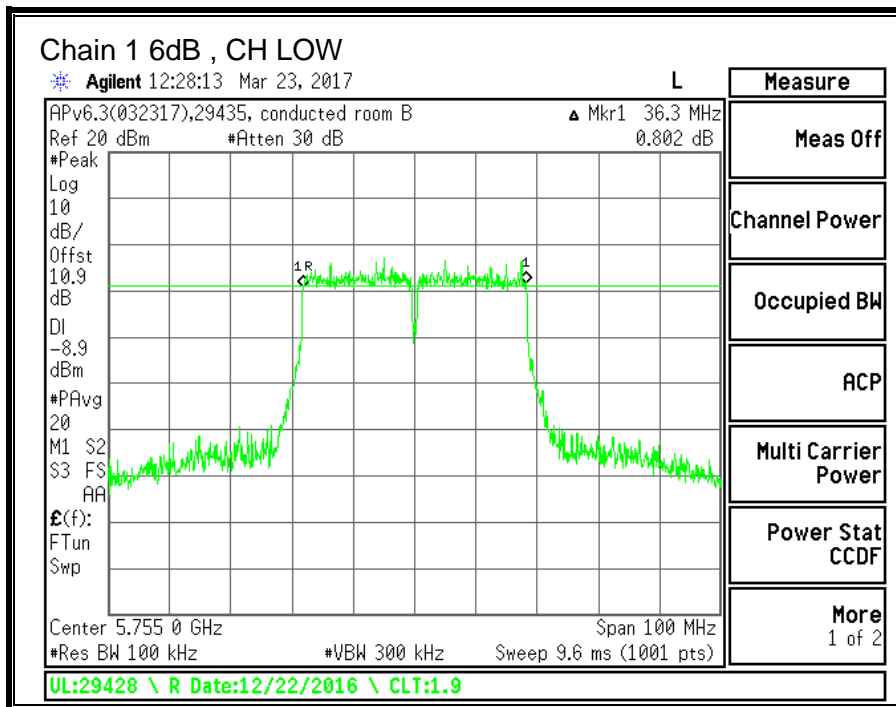
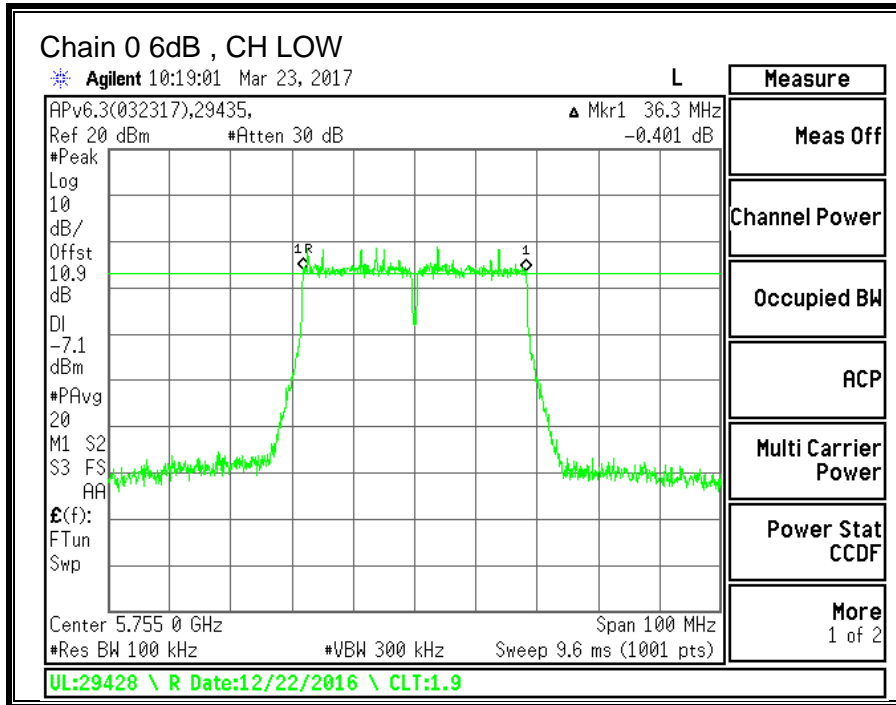

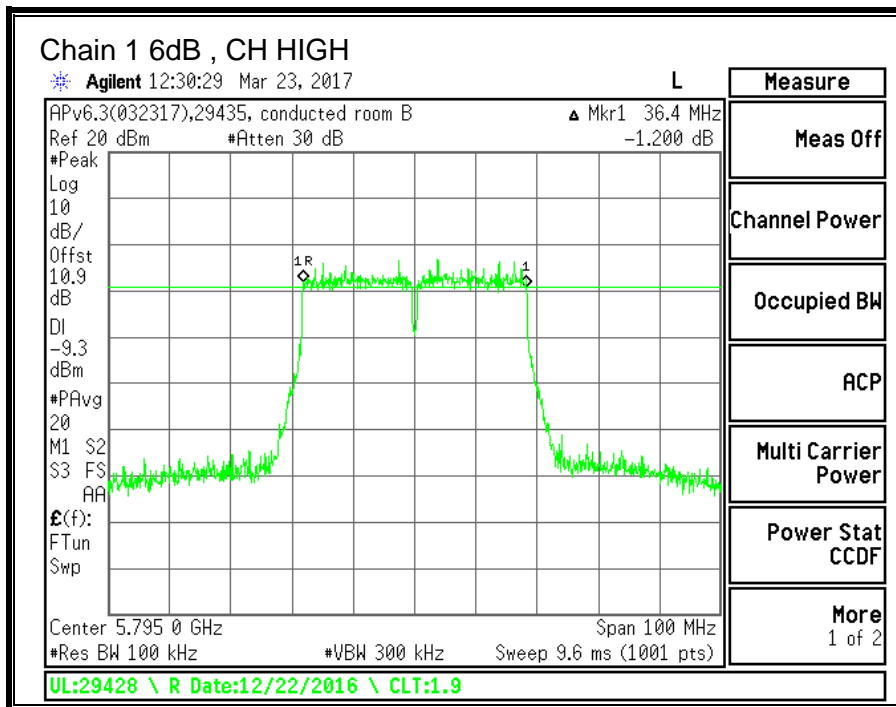
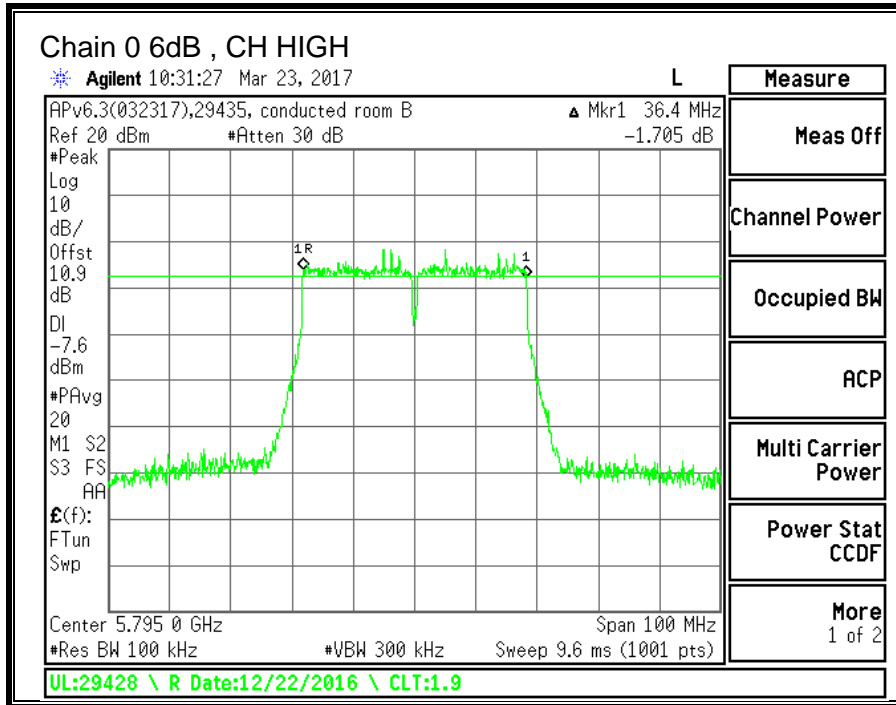

9.15.2. 99% BANDWIDTH

LIMITS

None; for reporting purposes only.

RESULTS

Channel	Frequency	99% BW Chain 0 (MHz)	99% BW Chain 1 (MHz)
Low	5755	35.8664	36.4494
High	5795	36.4516	35.6466

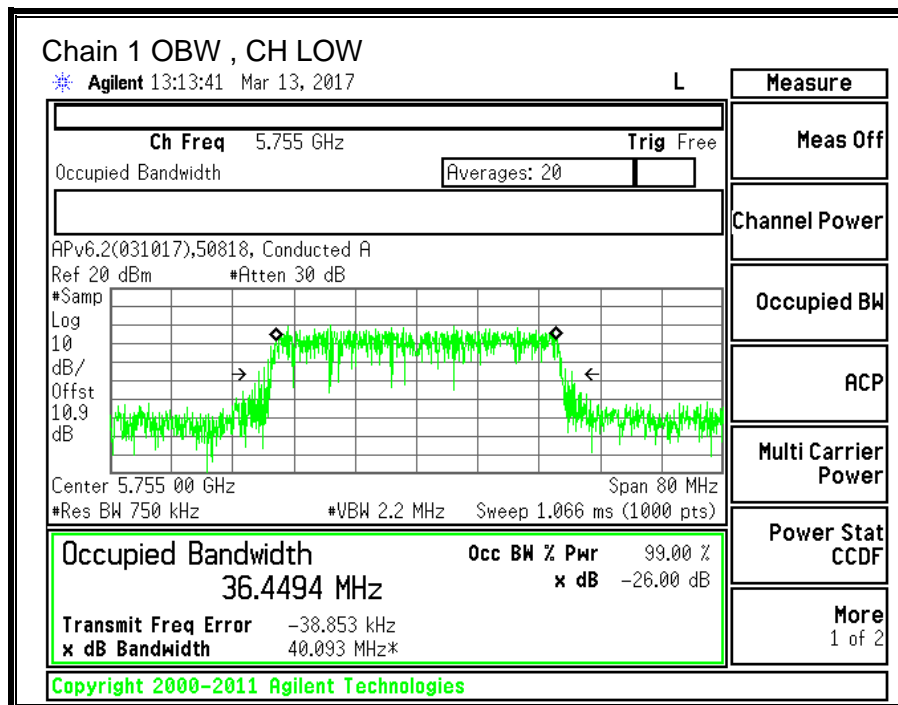
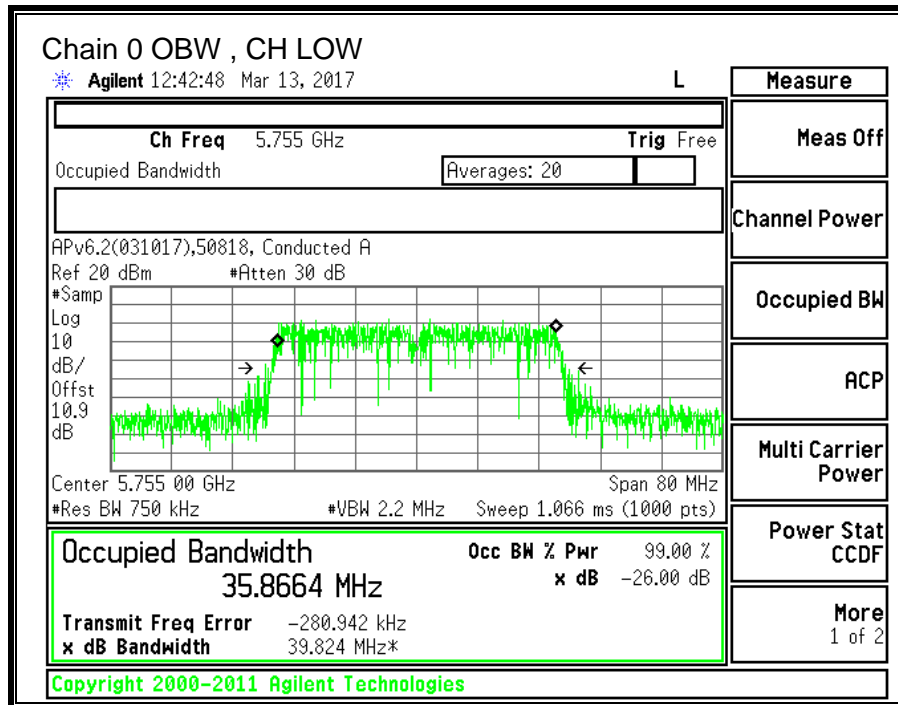

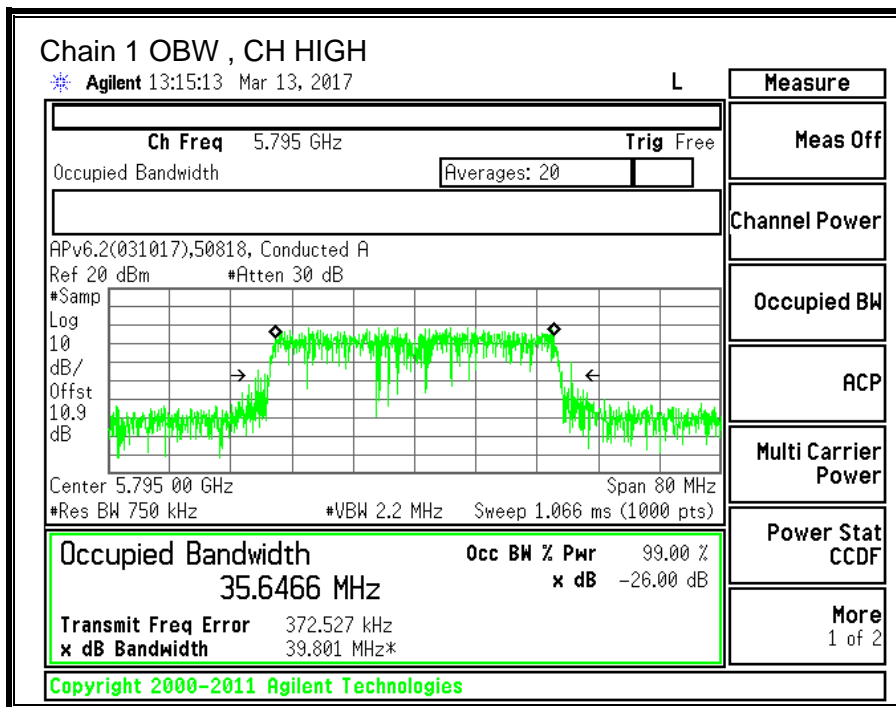
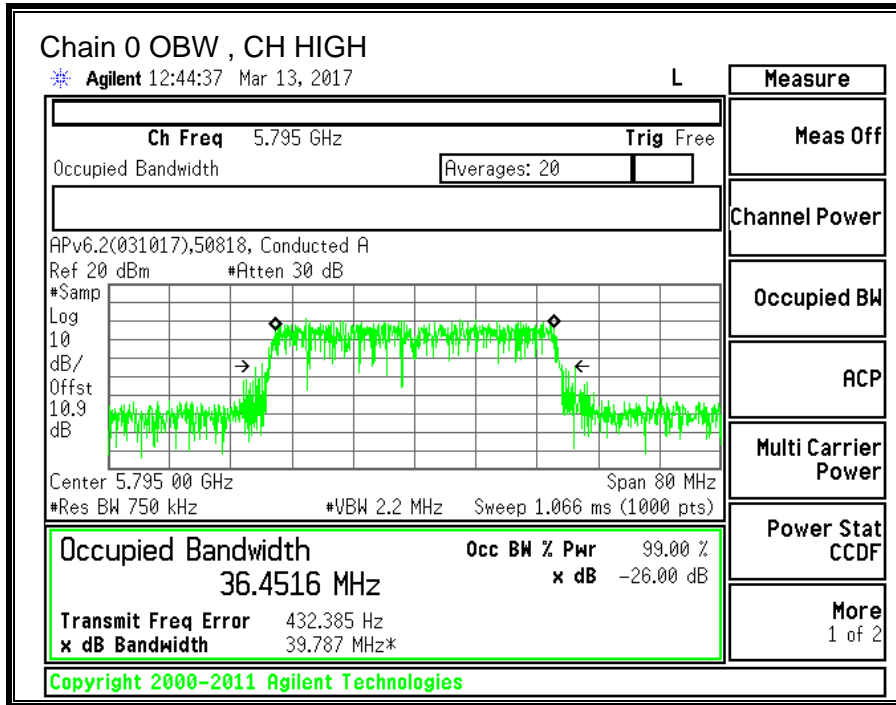

9.15.3. OUTPUT POWER AND PSD

LIMITS

FCC §15.407 (a) (3)

IC RSS-247 (6.2.4) (1)

For the band 5.725-5.85 GHz, the maximum conducted output power over the frequency band of operation shall not exceed 1 W. In addition, the maximum power spectral density shall not exceed 30 dBm in any 500-kHz band. If transmitting antennas of directional gain greater than 6 dBi are used, both the maximum conducted output power and the maximum power spectral density shall be reduced by the amount in dB that the directional gain of the antenna exceeds 6 dBi.

TEST PROCEDURE

Measurements perform using a wideband gated RF power meter provided that the gate parameters are adjusted such that the power is measured only when the EUT is transmitting at its maximum power control level. Since the measurement is made only during the ON time of the transmitter, no duty cycle correction factor is required.

DIRECTIONAL ANTENNA GAIN

For power, the TX chains are uncorrelated and the antenna gain is equal among the chains. The directional gain is:

5725-5850 MHz

Chain 0 Antenna Gain (dBi)	Chain 1 Antenna Gain (dBi)	Uncorrelated Chains Directional Gain (dBi)
-3.00	-1.90	-2.42

For PSD the TX chains are correlated and the antenna gain is equal among the chains. The directional gain is:

5725-5850 MHz

Chain 0 Antenna Gain (dBi)	Chain 1 Antenna Gain (dBi)	Correlated Chains Directional Gain (dBi)
-3.00	-1.90	0.58

RESULTS

ID:	43578	Date:	3/17/17
------------	-------	--------------	---------

Antenna Gain and Limit

Channel	Frequency (MHz)	Directional Gain For Power (dBi)	Directional Gain For PSD (dBi)	Power Limit (dBm)	Power Limit (dBm)
Low	5755	-2.42	0.58	30.00	30.00
High	5795	-2.42	0.58	30.00	30.00

Duty Cycle CF (dB)	0.22	Included in Calculations of Corr'd PSD
---------------------------	------	---

Output Power Results

Channel	Frequency (MHz)	Chain 0 Meas Power (dBm)	Chain 1 Meas Power (dBm)	Total Corr'd Power (dBm)	Power Limit (dBm)	Power Margin (dB)
Low	5755	12.72	11.25	15.06	30.00	-14.94
High	5795	12.81	11.17	15.08	30.00	-14.92

Output Power Results

Channel	Frequency (MHz)	Chain 0 Meas PSD (dBm)	Chain 1 Meas PSD (dBm)	Total Corr'd PSD (dBm)	PSD Limit (dBm)	PSD Margin (dB)
Low	5755	-4.489	-6.142	-2.01	30.00	-32.01
High	5795	-4.542	-5.818	-1.90	30.00	-31.90

Note: the power readings above were measured with gated method, and the measurement was taken only during the ON time. No duty cycle correction was necessary.

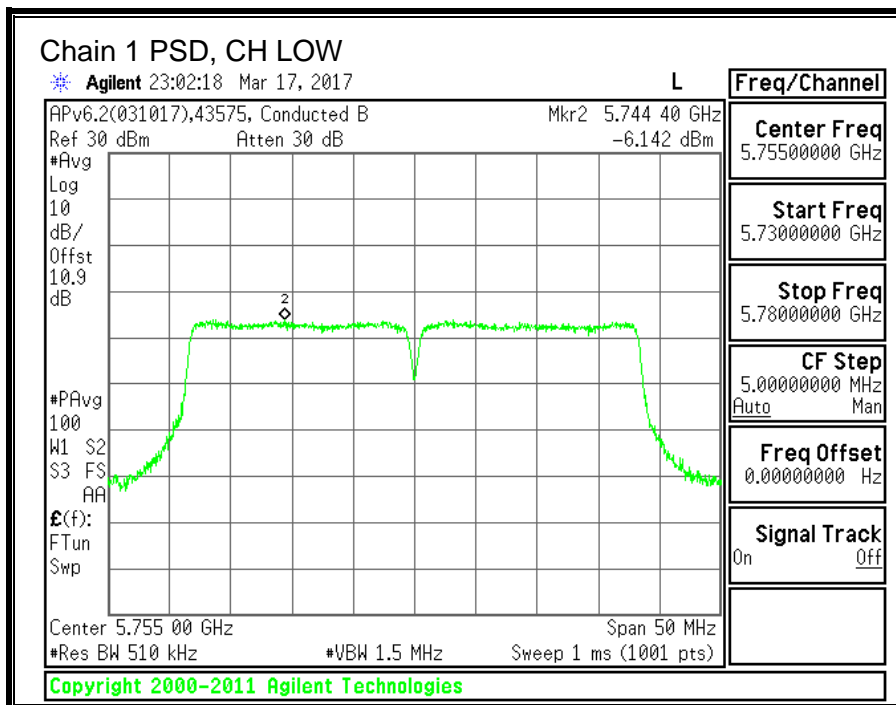
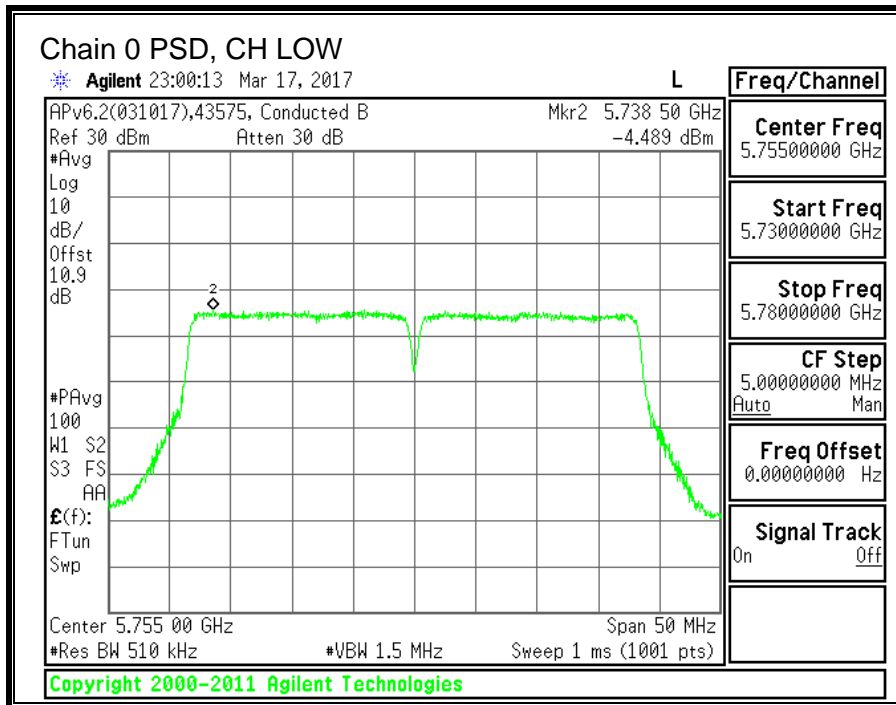

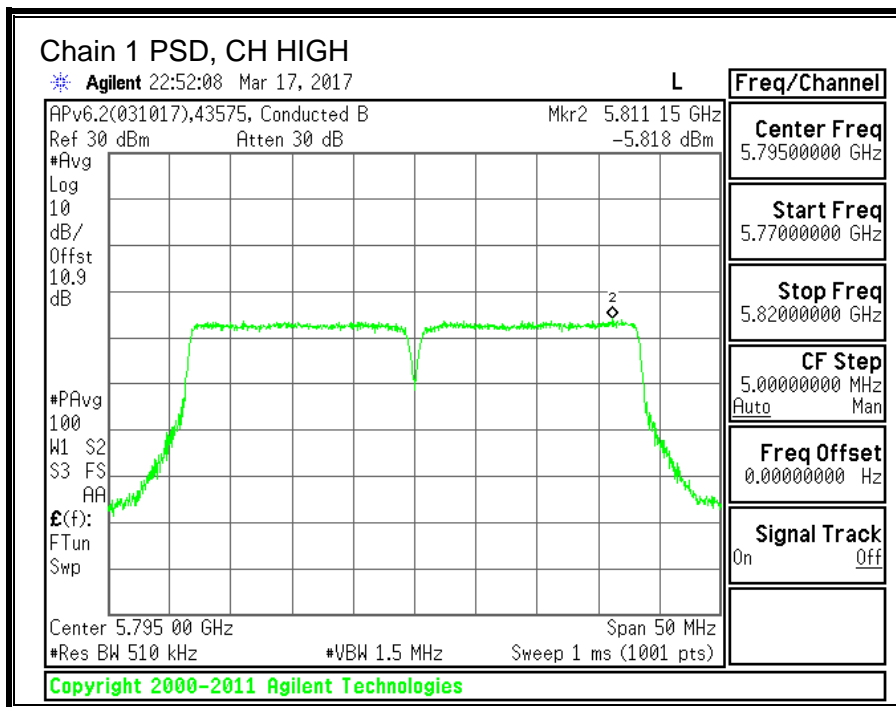
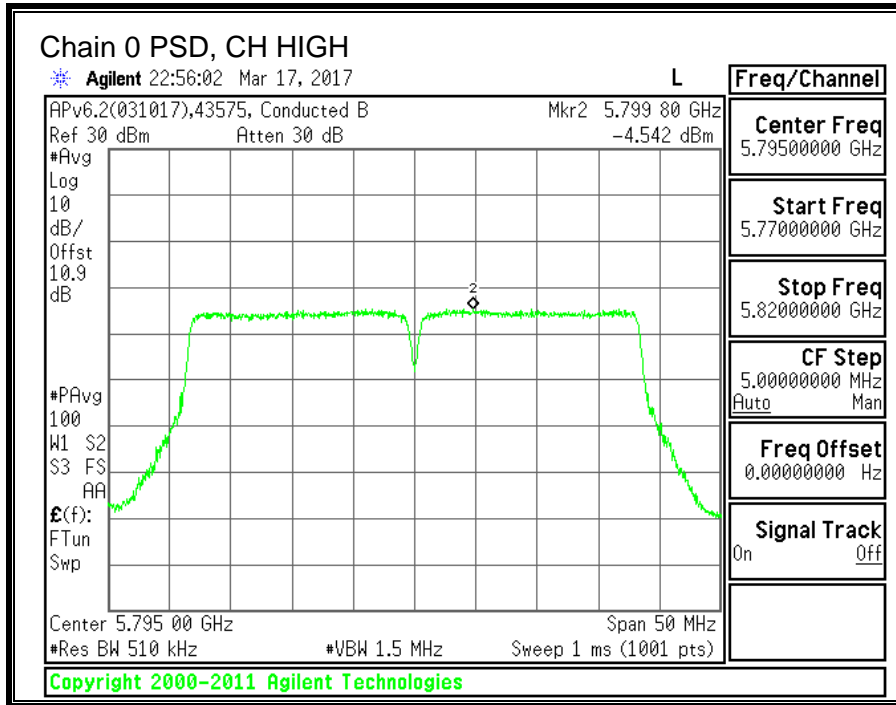

9.16. 11ac HT80 2TX CDD MIMO MODE IN THE 5.8GHz BAND

9.16.1. 6 dB BANDWIDTH

LIMITS

FCC §15.407 (e)

IC RSS-247 (6.2.4) (1)

The minimum 6 dB bandwidth shall be at least 500 kHz.

RESULTS

Channel	Frequency	6 dB BW Chain 0 (MHz)	6 dB BW Chain 1 (MHz)	Minimum Limit (MHz)
Mid	5775	76.4	75.8	0.5

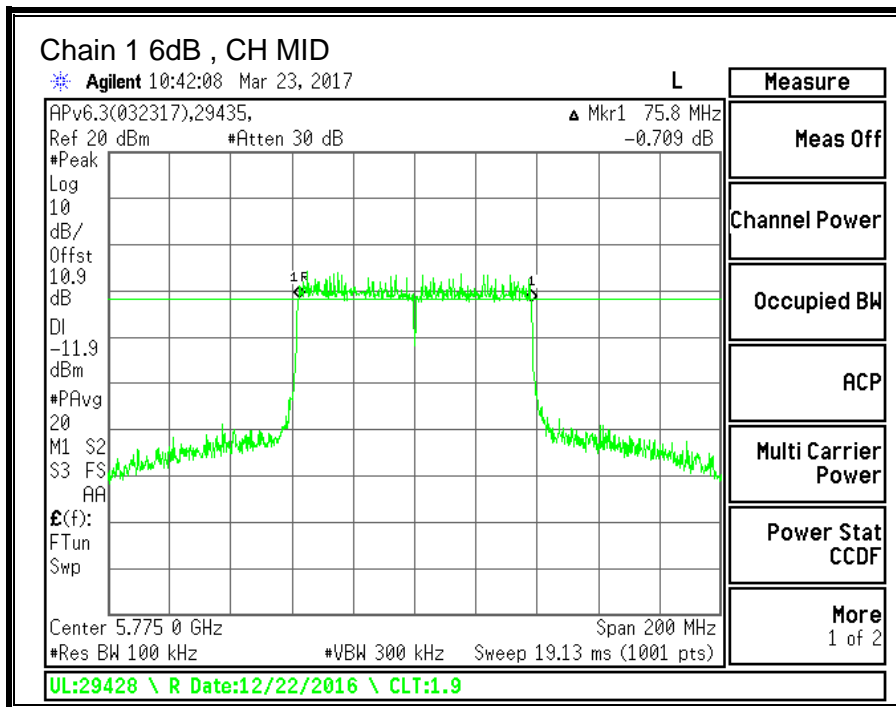
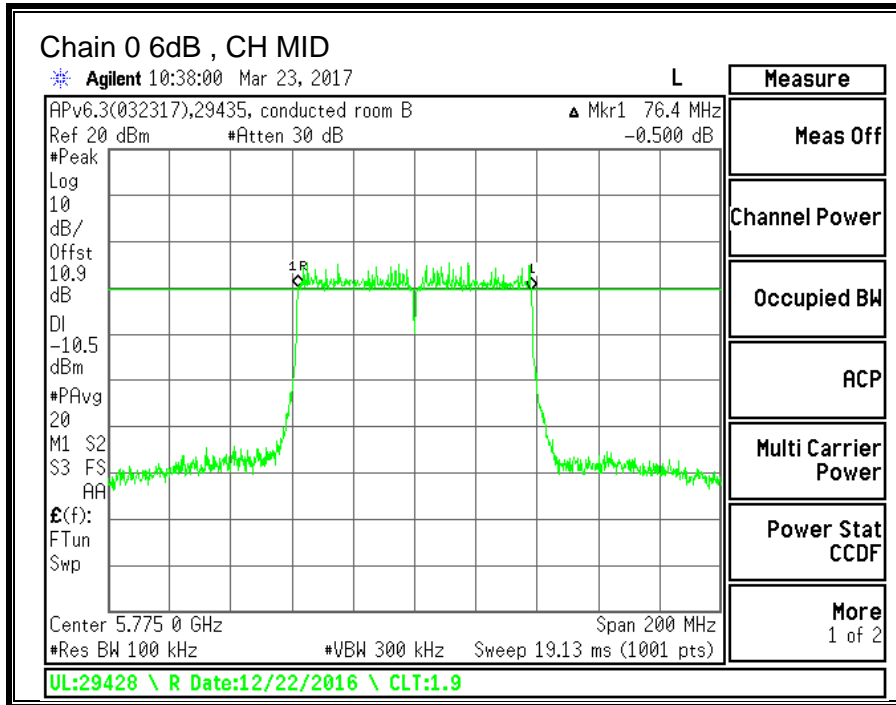

9.16.2. 99% BANDWIDTH

LIMITS

None; for reporting purposes only.

RESULTS

Channel	Frequency	99% BW Chain 0 (MHz)	99% BW Chain 1 (MHz)
Mid	5775	74.9251	74.5448

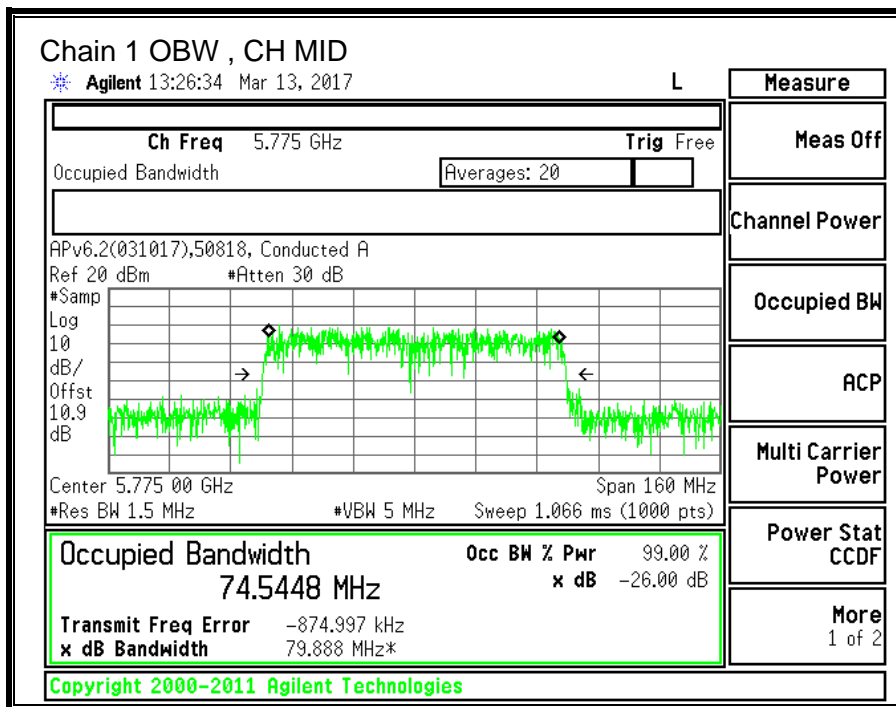
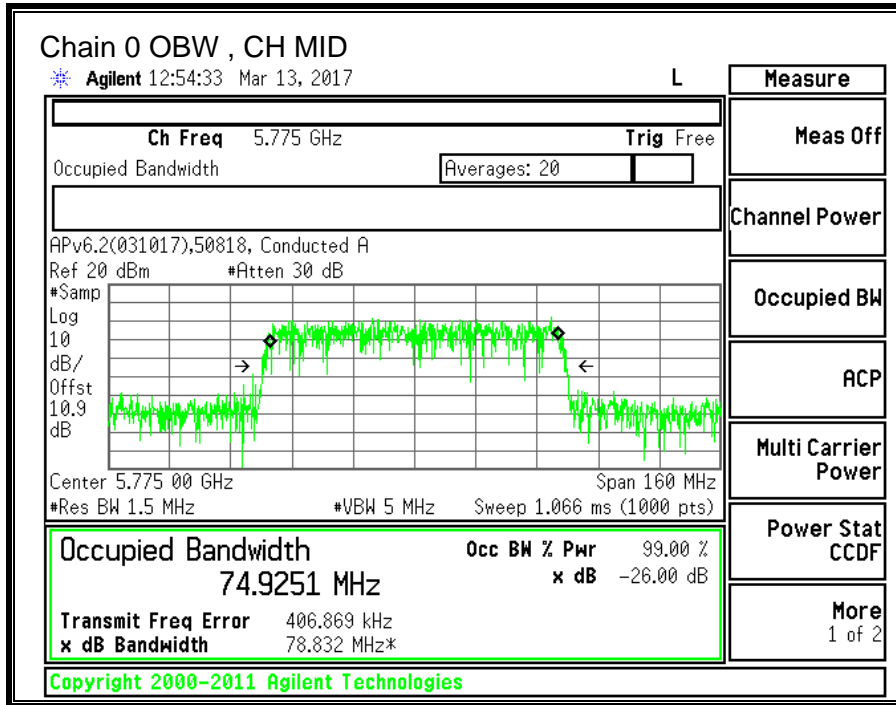

9.16.3. OUTPUT POWER AND PSD

LIMITS

FCC §15.407 (a) (3)

IC RSS-247 (6.2.4) (1)

For the band 5.725-5.85 GHz, the maximum conducted output power over the frequency band of operation shall not exceed 1 W. In addition, the maximum power spectral density shall not exceed 30 dBm in any 500-kHz band. If transmitting antennas of directional gain greater than 6 dBi are used, both the maximum conducted output power and the maximum power spectral density shall be reduced by the amount in dB that the directional gain of the antenna exceeds 6 dBi.

TEST PROCEDURE

Measurements perform using a wideband gated RF power meter provided that the gate parameters are adjusted such that the power is measured only when the EUT is transmitting at its maximum power control level. Since the measurement is made only during the ON time of the transmitter, no duty cycle correction factor is required.

DIRECTIONAL ANTENNA GAIN

For power, the TX chains are uncorrelated and the antenna gain is equal among the chains. The directional gain is:

5725-5850 MHz

Chain 0 Antenna Gain (dBi)	Chain 1 Antenna Gain (dBi)	Uncorrelated Chains Directional Gain (dBi)
-3.00	-1.90	-2.42

For PSD the TX chains are correlated and the antenna gain is equal among the chains. The directional gain is:

5725-5850 MHz

Chain 0 Antenna Gain (dBi)	Chain 1 Antenna Gain (dBi)	Correlated Chains Directional Gain (dBi)
-3.00	-1.90	0.58

RESULTS

ID:	43578	Date:	3/17/17
------------	-------	--------------	---------

Antenna Gain and Limit

Channel	Frequency (MHz)	Directional Gain for Power (dBi)	Power Limit for PSD (dBi)	Power Limit (dBm)	PSD Limit (dBm)
Mid	5775	-2.42	0.58	30.00	30.00

Duty Cycle CF (dB)	0.42	Included in Calculations of Corr'd PSD
---------------------------	------	---

Output Power Results

Channel	Frequency (MHz)	Chain 0 Meas Power (dBm)	Chain 1 Meas Power (dBm)	Total Corr'd Power (dBm)	Power Limit (dBm)	Power Margin (dB)
Mid	5775	12.67	11.18	15.00	30.00	-15.00

PSD Results

Channel	Frequency (MHz)	Chain 0 Meas Power (dBm)	Chain 1 Meas Power (dBm)	Total Corr'd Power (dBm)	Power Limit (dBm)	Power Margin (dB)
Mid	5775	-7.889	-9.763	-5.30	30.00	-35.30

Note: the power readings above were measured with gated method, and the measurement was taken only during the ON time. No duty cycle correction was necessary.

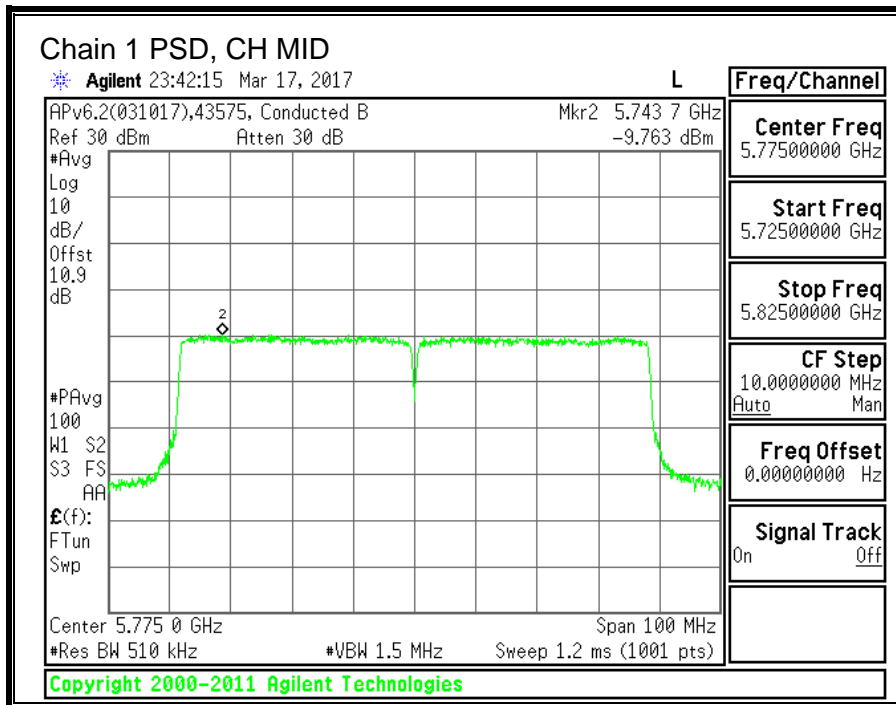
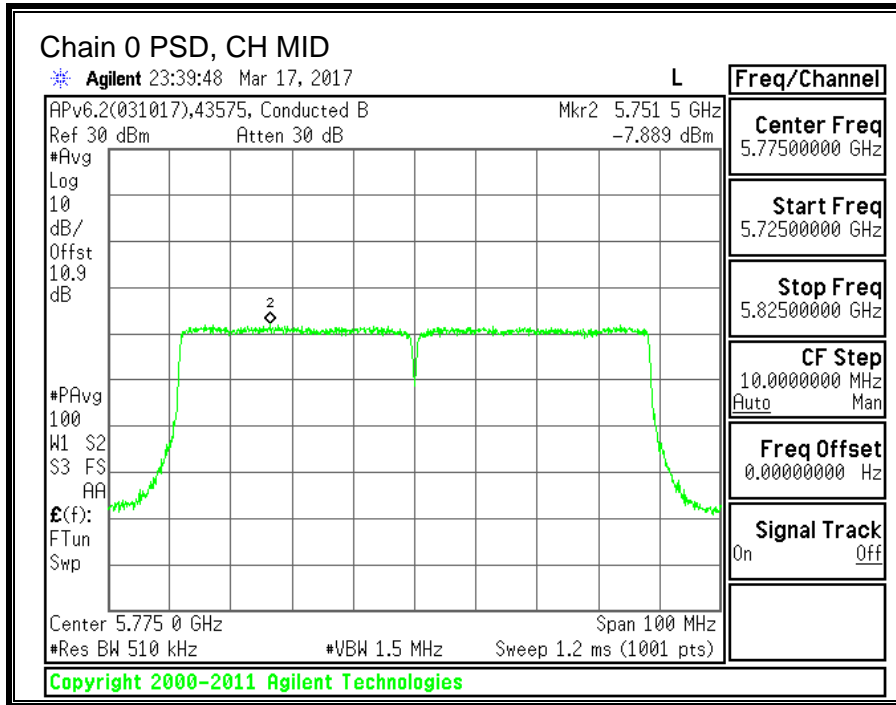

10. RADIATED TEST RESULTS

10.1. LIMITS AND PROCEDURE

LIMITS

FCC §15.205 and §15.209

IC RSS-GEN, Section 8.9 and 8.10.

Frequency Range (MHz)	Field Strength Limit (uV/m) at 3 m	Field Strength Limit (dBuV/m) at 3 m
30 - 88	100	40
88 - 216	150	43.5
216 - 960	200	46
Above 960	500	54

TEST PROCEDURE

The EUT is placed on a non-conducting table 80 cm above the ground plane for measurement below 1GHz; 1.5 m above the ground plane for measurement above 1GHz. The antenna to EUT distance is 3 meters. The EUT is configured in accordance with ANSI C63.10. The EUT is set to transmit in a continuous mode.

For measurements below 1 GHz the resolution bandwidth is set to 100 kHz for peak detection measurements or 120 kHz for quasi-peak detection measurements. Peak detection is used unless otherwise noted as quasi-peak.

For pre-scans above 1 GHz the resolution bandwidth is set to 1 MHz; the video bandwidth is set to 30 KHz for peak measurements.

For measurements above 1 GHz the resolution bandwidth is set to 1 MHz; the video bandwidth is set to 3 MHz for peak measurements and add duty cycle factor for average measurements.

The spectrum from 30 MHz to 40 GHz is investigated with the transmitter set to the lowest, middle, and highest channels in each applicable band. Below and above 18GHz emissions, the channel with the highest output power was tested.

The frequency range of interest is monitored at a fixed antenna height and EUT azimuth. The EUT is rotated through 360 degrees to maximize emissions received. The antenna is scanned from 1 to 4 meters above the ground plane to further maximize the emission. Measurements are made with the antenna polarized in both the vertical and the horizontal positions.

Radiated emission were performed with the EUT set to transmit at the channel with highest output power as worst-case scenario.

10.1.1. 11a 2TX CDD MIMO MODE IN THE 5.2GHZ BAND

RESTRICTED BANDEDGE (LOW CHANNEL)

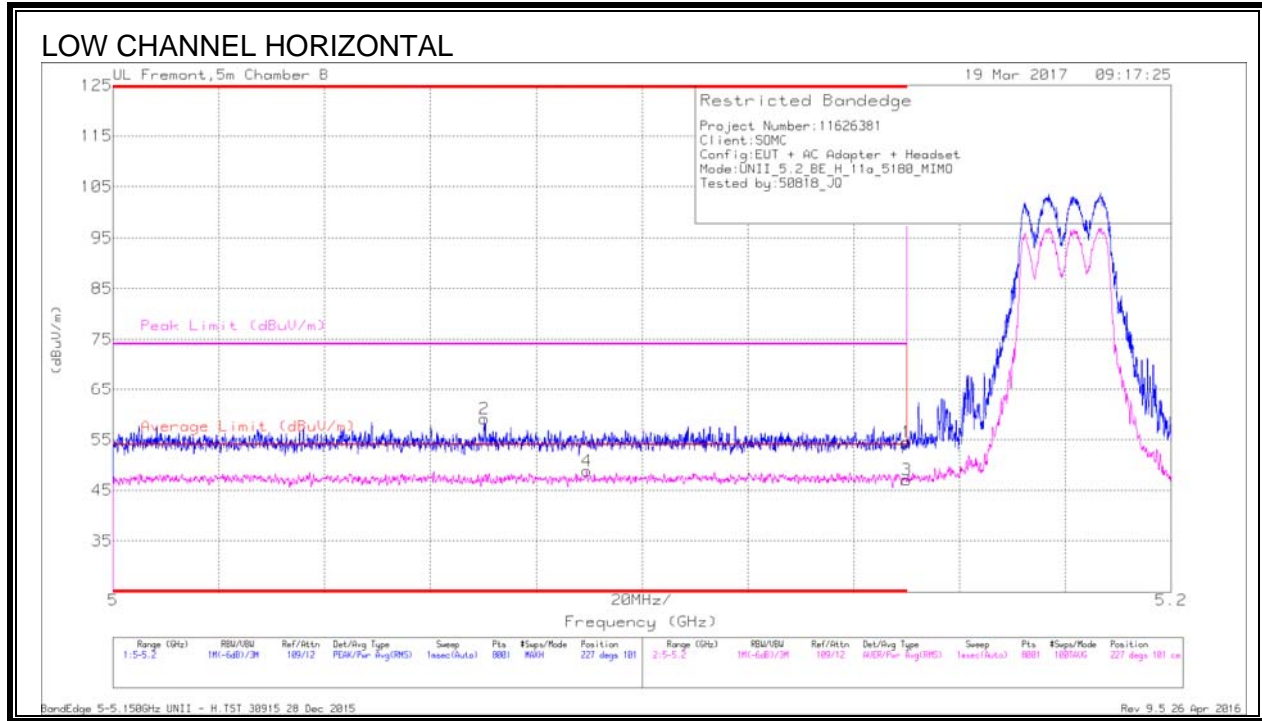

Trace Markers

Marker	Frequency (GHz)	Meter Reading (dBuV)	Det	AF T345 (dB/m)	Amp/Cb/Ftr/Pad (dB)	DC Corr (dB)	Corrected Reading (dBuV/m)	Average Limit (dBuV/m)	Margin (dB)	Peak Limit (dBuV/m)	PK Margin (dB)	Altitude (Degs)	Height (cm)	Polarity
2	* 5.07	42.8	Pk	34.1	-17.8	0	59.1	-	-	74	-14.9	227	101	H
4	* 5.09	32.17	RMS	34.1	-17.7	.24	48.81	54	-5.19	-	-	227	101	H
1	5.15	38.37	Pk	34.2	-18.1	0	54.47	-	-	74	-19.53	227	101	H
3	5.15	30.67	RMS	34.2	-18.1	.24	47.01	54	-6.99	-	-	227	101	H

* - indicates frequency in CFR15.205/IC8.10 RSS-Restricted Band

Pk - Peak detector

RMS - RMS detection

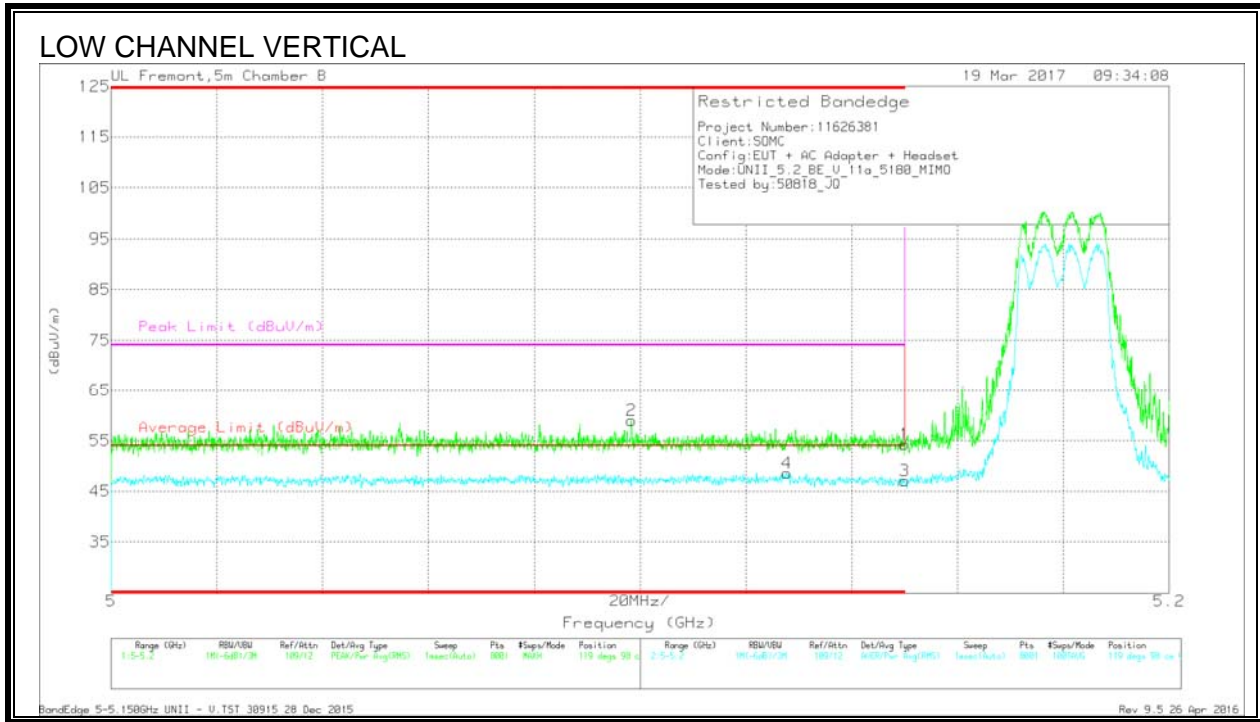

Trace Markers

Marker	Frequency (GHz)	Meter Reading (dBuV)	Det	AFT345 (dB/m)	Amp/Cb/Fkr/Pdr (dB)	DC Corr (dB)	Corrected Reading (dBuV/m)	Average Limit (dBuV/m)	Margin (dB)	Peak Limit (dBuV/m)	PK Margin (dB)	Azimuth (Degs)	Height (cm)	Polarity
2	* 5.098	42.83	Pk	34.1	-17.9	0	59.03	-	-	74	-14.97	119	98	V
4	* 5.128	31.71	RMS	34.2	-17.6	.24	48.55	54	-5.45	-	-	119	98	V
1	5.15	38.13	Pk	34.2	-18.1	0	54.23	-	-	74	-19.77	119	98	V
3	5.15	30.74	RMS	34.2	-18.1	.24	47.08	54	-6.92	-	-	119	98	V

* - indicates frequency in CFR15.205/IC8.10 RSS-Restricted Band

Pk - Peak detector

RMS - RMS detection

HARMONICS AND SPURIOUS EMISSIONS

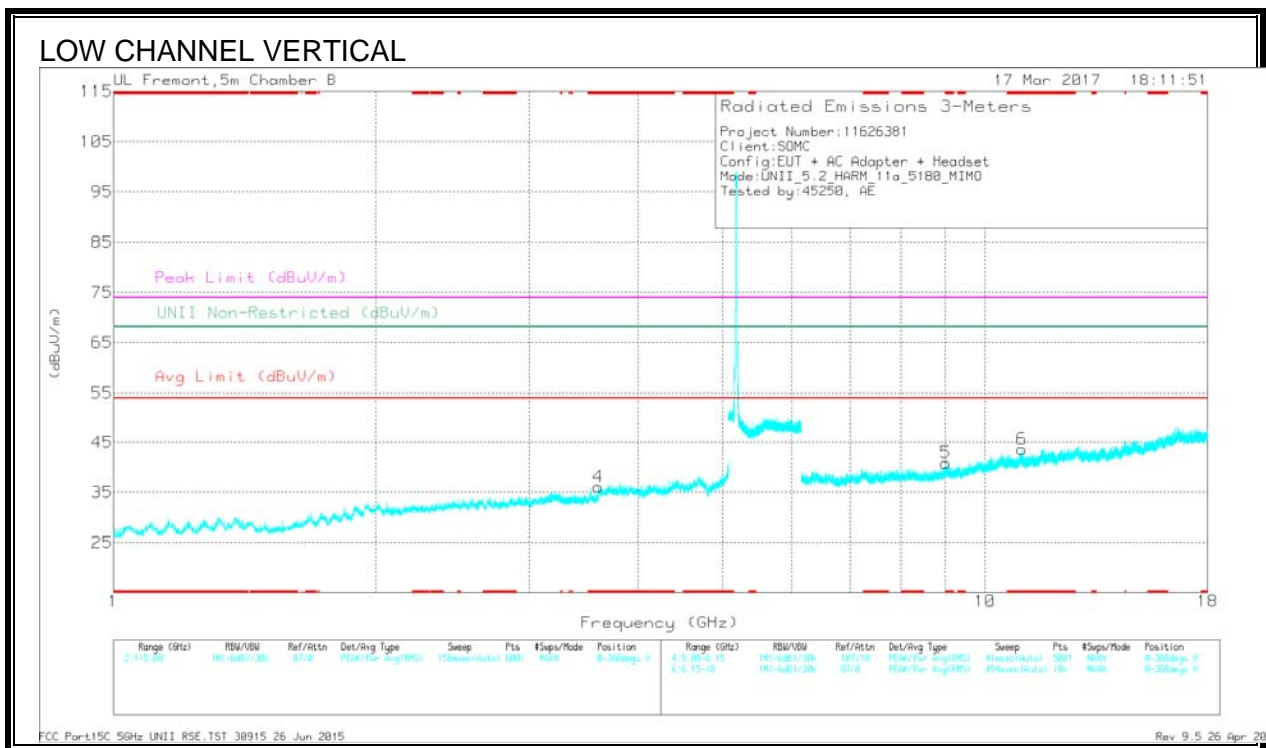
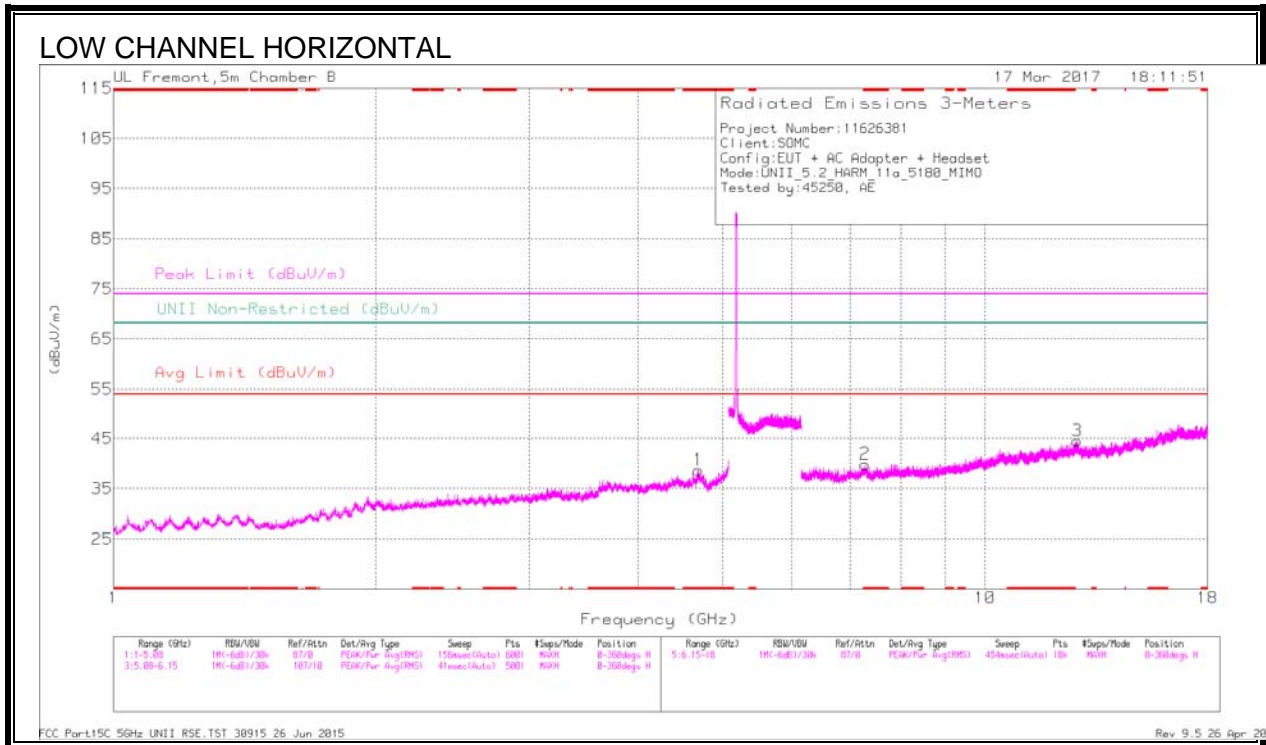

Trace Markers

Marker	Frequency (MHz)	Meter Reading (dBuV)	Det	AF T345 (dB/m)	Amp/Ch/Flt/Pad (dB)	DC Corr (dB)	Corrected Reading (dBuV/m)	Avg Limit (dBuV/m)	Margin (dB)	Peak Limit (dBuV/m)	PK Margin (dB)	UNII Non-Restricted (dBuV/m)	PK Margin (dB)	Altitude (Feet)	Height (m)	Polarity
1	* 4.688	33.84	Pk	34.1	-29.2	0	38.74	-	-	74	-35.26	-	-	0-360	99	H
4	* 3.602	34.25	Pk	33	-31.1	0	36.15	-	-	74	-37.85	-	-	0-360	201	V
2	* 7.288	30.33	Pk	35.6	-26.1	0	39.83	-	-	74	-34.17	-	-	0-360	201	H
5	* 9.012	30.03	Pk	36.1	-25.2	0	40.93	-	-	74	-33.07	-	-	0-360	201	V
6	* 11.023	28.28	Pk	37.9	-22.6	0	43.58	-	-	74	-30.42	-	-	0-360	201	V
3	12.751	27.39	Pk	39.4	-22.2	0	44.59	-	-	-	-	68.2	-23.61	0-360	201	H

* - indicates frequency in CFR15.205/IC8.10 RSS-Restricted Band
 Pk - Peak detector

Radiated Emissions

Frequency (MHz)	Meter Reading (dBuV)	Det	AF T345 (dB/m)	Amp/Ch/Flt/Pad (dB)	DC Corr (dB)	Corrected Reading (dBuV/m)	Avg Limit (dBuV/m)	Margin (dB)	Peak Limit (dBuV/m)	PK Margin (dB)	UNII Non-Restricted (dBuV/m)	PK Margin (dB)	Altitude (Feet)	Height (m)	Polarity
* 4.689	39.01	PK-U	34.1	-29.2	0	43.91	-	-	74	-30.09	-	-	157	339	H
* 4.688	28.62	ADR	34.1	-29.2	.24	33.76	54	-20.24	-	-	-	-	157	339	H
* 3.602	39.83	PK-U	33	-31.1	0	41.73	-	-	74	-32.27	-	-	201	198	V
* 3.602	28.81	ADR	33	-31.1	.24	30.95	54	-23.05	-	-	-	-	201	198	V
* 7.289	35.84	PK-U	35.6	-26.1	0	45.34	-	-	74	-28.66	-	-	102	240	H
* 7.289	25.67	ADR	35.6	-26.1	.24	35.41	54	-18.59	-	-	-	-	102	240	H
* 9.013	34.42	PK-U	36.1	-25.2	0	45.32	-	-	74	-28.68	-	-	298	195	V
* 9.013	24.46	ADR	36.1	-25.2	.24	35.6	54	-18.4	-	-	-	-	298	195	V
* 11.025	32.74	PK-U	37.9	-22.6	0	48.04	-	-	74	-25.96	-	-	70	168	V
* 11.023	23.27	ADR	37.9	-22.6	.24	38.81	54	-15.19	-	-	-	-	70	168	V
12.752	33.3	PK-U	39.4	-22.3	0	50.4	-	-	-	-	68.2	-17.8	207	219	H
12.753	22.31	ADR	39.4	-22.3	.24	39.65	-	-	-	-	-	-	207	219	H

* - indicates frequency in CFR15.205/IC8.10 RSS-Restricted Band
 PK-U - U-NII: Maximum Peak
 ADR - U-NII AD primary method, RMS average

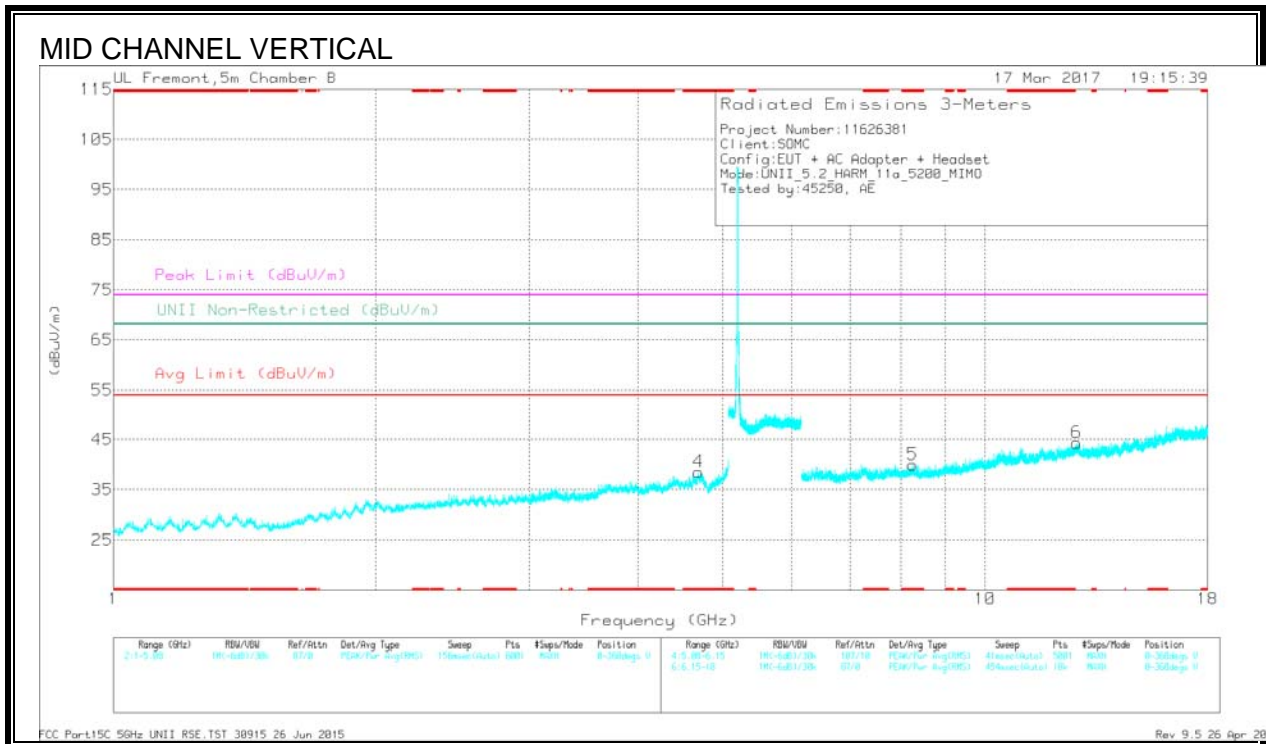
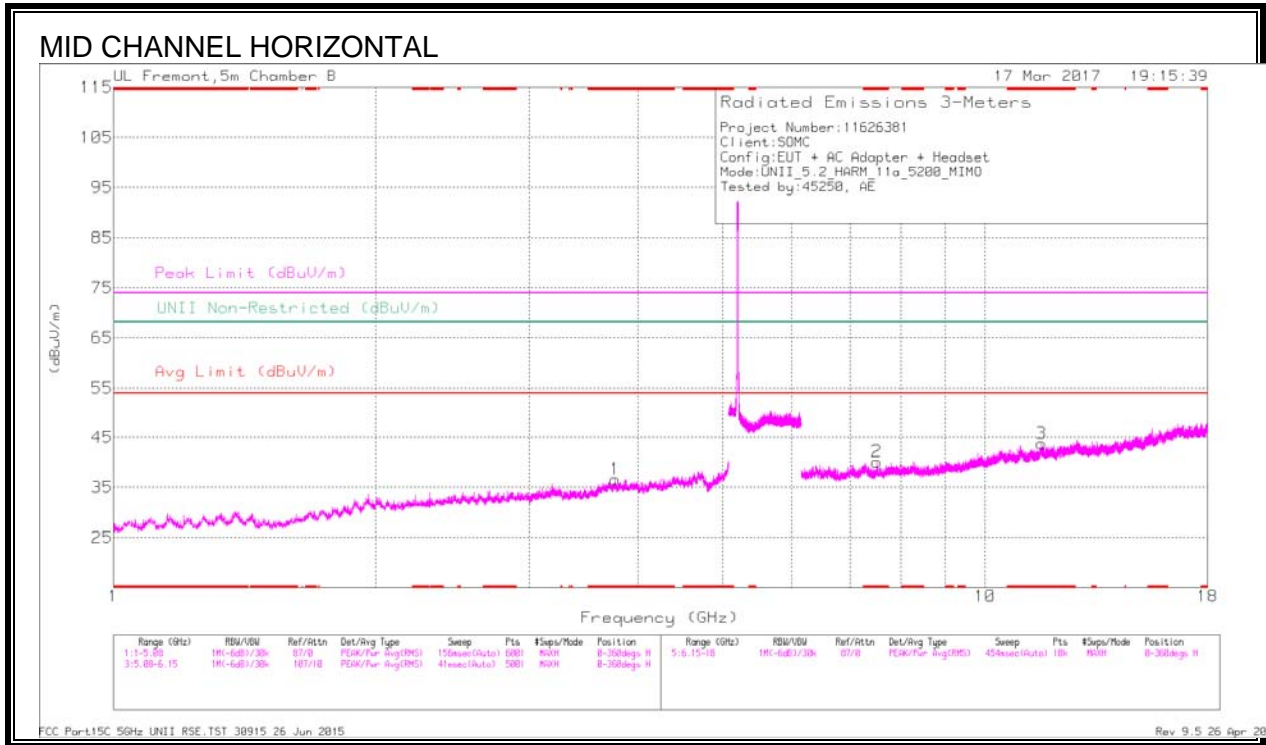

Trace Markers

Marker	Frequency (GHz)	Meter Reading (dBuV)	Det	AF T345 (dB/m)	Amp/Ch/Ftr/Pad (dB)	DC Corr (dB)	Corrected Reading (dBuV/m)	Avg Limit (dBuV/m)	Margin (dB)	Peak Limit (dBuV/m)	PK Margin (dB)	UNII Non-Restricted (dBuV/m)	PK Margin (dB)	Altitude (Degs)	Height (cm)	Polarity
1	* 3.764	33.8	Pk	33.4	-30.6	0	36.6	-	-	74	-37.4	-	-	0-360	98	H
4	* 4.687	33.67	Pk	34.1	-29.2	0	38.57	-	-	74	-35.43	-	-	0-360	98	V
2	* 7.519	30.9	Pk	35.7	-26.5	0	40.1	-	-	74	-33.9	-	-	0-360	98	H
3	* 11.616	27.64	Pk	38.4	-22.3	0	43.74	-	-	74	-30.26	-	-	0-360	98	H
5	* 8.259	30.33	Pk	35.8	-26.1	0	40.03	-	-	74	-33.97	-	-	0-360	98	V
6	12.743	27.24	Pk	39.4	-22.3	0	44.34	-	-	-	-	68.2	-23.86	0-360	98	V

* - indicates frequency in CFR15.205/IC8.10 RSS-Restricted Band
 Pk - Peak detector

Radiated Emissions

Frequency (GHz)	Meter Reading (dBuV)	Det	AF T345 (dB/m)	Amp/Ch/Ftr/Pad (dB)	DC Corr (dB)	Corrected Reading (dBuV/m)	Avg Limit (dBuV/m)	Margin (dB)	Peak Limit (dBuV/m)	PK Margin (dB)	UNII Non-Restricted (dBuV/m)	PK Margin (dB)	Altitude (Degs)	Height (cm)	Polarity
* 3.764	38.56	PK-U	33.4	-30.6	0	41.36	-	-	74	-32.64	-	-	3	114	H
* 3.762	28.68	ADR	33.4	-30.6	.24	31.72	54	-22.28	-	-	-	-	3	114	H
* 4.688	40.26	PK-U	34.1	-29.2	0	45.16	-	-	74	-28.84	-	-	80	175	V
* 4.686	29.22	ADR	34.1	-29.2	.24	34.36	54	-19.64	-	-	-	-	80	175	V
* 7.52	35.26	PK-U	35.7	-26.5	0	44.46	-	-	74	-29.54	-	-	157	163	H
* 7.519	25.45	ADR	35.7	-26.5	.24	34.89	54	-19.11	-	-	-	-	157	163	H
* 11.616	32.11	PK-U	38.4	-22.3	0	48.21	-	-	74	-25.79	-	-	252	237	H
* 11.616	22.67	ADR	38.4	-22.3	.24	39.01	54	-14.99	-	-	-	-	252	237	H
* 8.258	35.68	PK-U	35.8	-26.1	0	45.38	-	-	74	-28.62	-	-	168	155	V
* 8.259	25.48	ADR	35.8	-26.1	.24	35.42	54	-18.58	-	-	-	-	168	155	V
12.741	22.4	ADR	39.4	-22.3	.24	39.74	-	-	-	-	-	-	48	236	V
12.743	32.63	PK-U	39.4	-22.3	0	49.73	-	-	-	-	68.2	-18.47	48	236	V

* - indicates frequency in CFR15.205/IC8.10 RSS-Restricted Band
 PK-U - U-NII: Maximum Peak
 ADR - U-NII AD primary method, RMS average

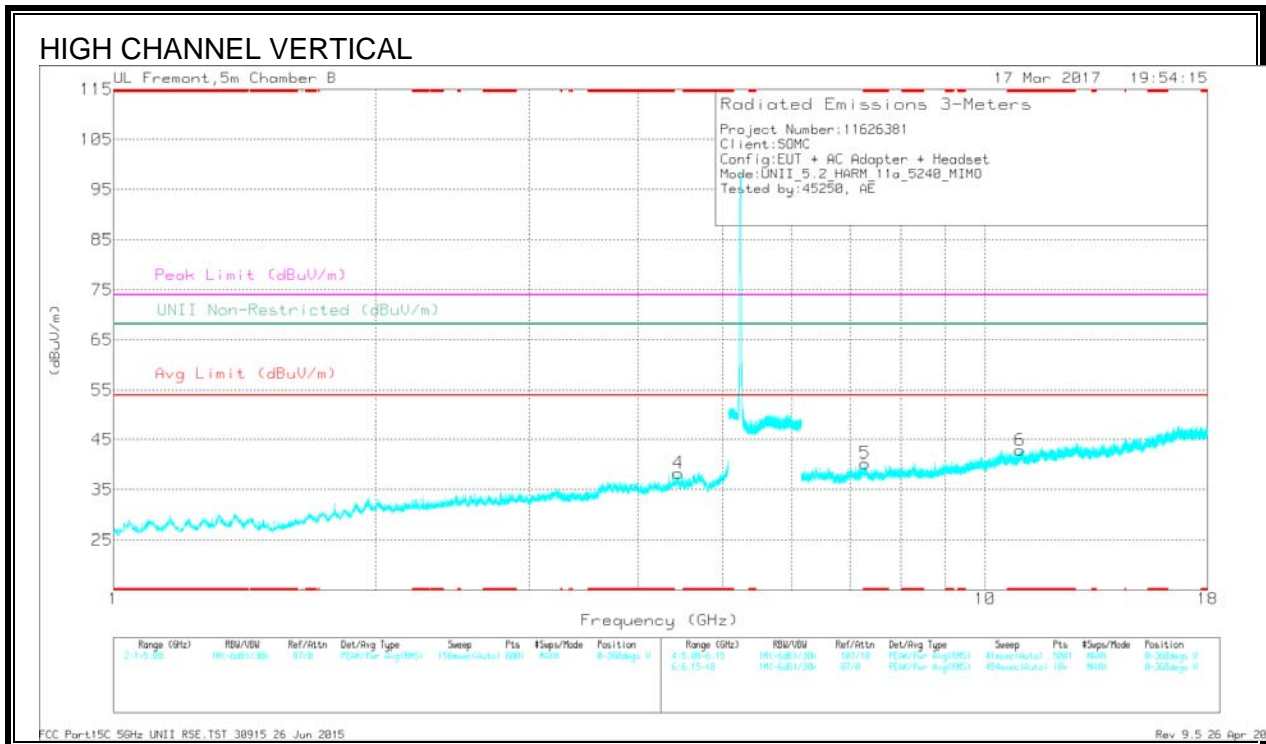
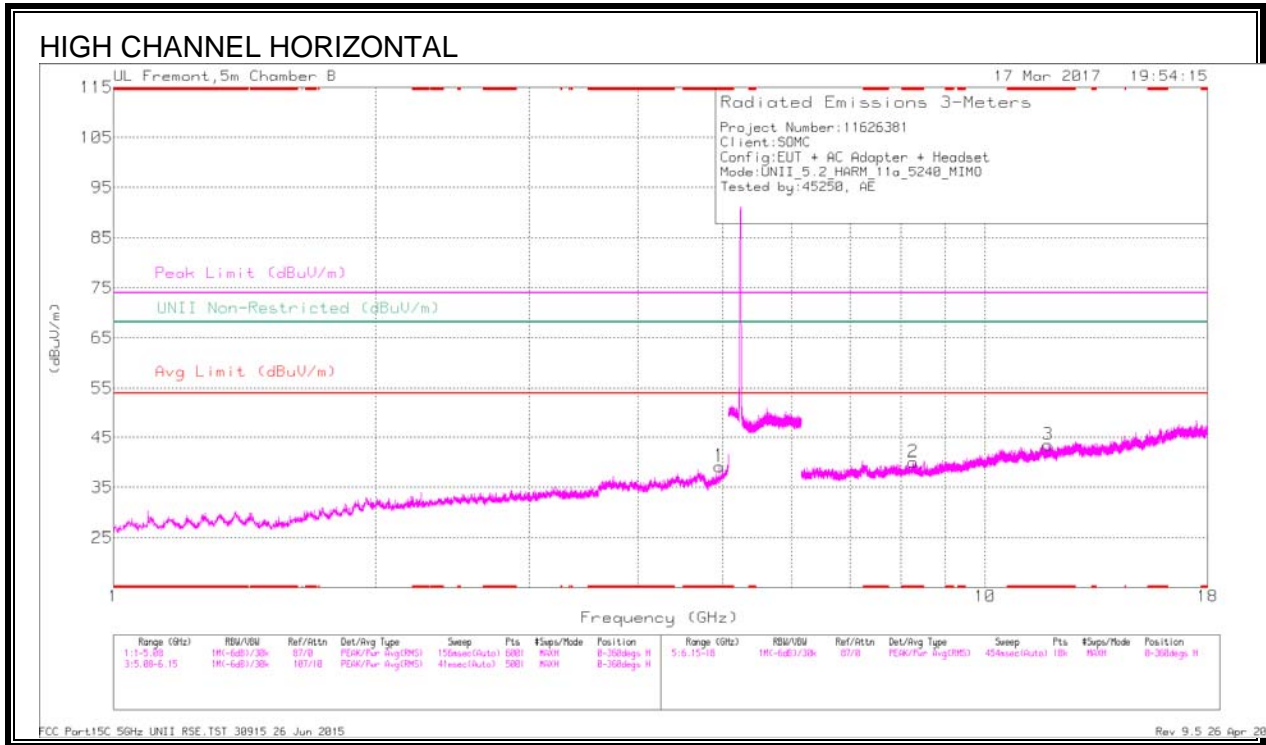

Trace Markers

Marker	Frequency (GHz)	Meter Reading (dBuV)	Det	AF T345 (dB/m)	Amp/Ch/Ftr/Pad (dB)	DC Corr (dB)	Corrected Reading (dBuV/m)	Avg Limit (dBuV/m)	Margin (dB)	Peak Limit (dBuV/m)	PK Margin (dB)	UNII Non-Restricted (dBuV/m)	PK Margin (dB)	Altitude (Degs)	Height (cm)	Polarity
1	* 4.953	34.37	Pk	34	-29.1	0	39.27	-	-	74	-34.73	-	-	0-360	98	H
2	* 8.27	30.21	Pk	35.8	-25.9	0	40.11	-	-	74	-33.89	-	-	0-360	201	H
3	* 11.815	27.96	Pk	38.7	-23.1	0	43.56	-	-	74	-30.44	-	-	0-360	201	H
5	* 7.287	30.8	Pk	35.6	-26.1	0	40.3	-	-	74	-33.7	-	-	0-360	201	V
6	* 10.975	27.49	Pk	37.9	-22.5	0	42.89	-	-	74	-31.11	-	-	0-360	98	V
4	4.446	33.5	Pk	34	-29.2	0	38.3	-	-	-	-	68.2	-29.9	0-360	98	V

* - indicates frequency in CFR15.205/IC8.10 RSS-Restricted Band
 Pk - Peak detector

Radiated Emissions

Frequency (GHz)	Meter Reading (dBuV)	Det	AF T345 (dB/m)	Amp/Ch/Ftr/Pad (dB)	DC Corr (dB)	Corrected Reading (dBuV/m)	Avg Limit (dBuV/m)	Margin (dB)	Peak Limit (dBuV/m)	PK Margin (dB)	UNII Non-Restricted (dBuV/m)	PK Margin (dB)	Altitude (Degs)	Height (cm)	Polarity
* 4.952	38.32	PK-U	34	-29.2	0	43.12	-	-	74	-30.88	-	-	90	123	H
* 4.951	28.37	ADR	34	-29.2	.24	33.41	54	-20.59	-	-	-	-	90	123	H
* 8.269	35.67	PK-U	35.8	-25.9	0	45.57	-	-	74	-28.43	-	-	157	178	H
* 8.27	25.35	ADR	35.8	-25.9	.24	35.49	54	-18.51	-	-	-	-	157	178	H
* 11.817	32.31	PK-U	38.7	-23.1	0	47.91	-	-	74	-26.09	-	-	237	197	H
* 11.816	22.81	ADR	38.7	-23.1	.24	38.65	54	-15.35	-	-	-	-	237	197	H
* 7.287	35.7	PK-U	35.6	-26.1	0	45.2	-	-	74	-28.8	-	-	195	273	V
* 7.286	25.94	ADR	35.6	-26.1	.24	35.68	54	-18.32	-	-	-	-	195	273	V
* 10.973	33.21	PK-U	37.9	-22.5	0	48.61	-	-	74	-25.39	-	-	111	183	V
* 10.974	22.92	ADR	37.9	-22.5	.24	38.56	54	-15.44	-	-	-	-	111	183	V
4.446	38.19	PK-U	34	-29.2	0	42.99	-	-	-	-	68.2	-25.21	113	220	V
4.446	27.99	ADR	34	-29.2	.24	33.03	-	-	-	-	-	-	113	220	V

* - indicates frequency in CFR15.205/IC8.10 RSS-Restricted Band
 PK-U - U-NII: Maximum Peak
 ADR - U-NII AD primary method, RMS average

10.1.2. 11n HT20 2TX CDD MIMO MODE IN THE 5.2GHZ BAND

RESTRICTED BANDEDGE (LOW CHANNEL)

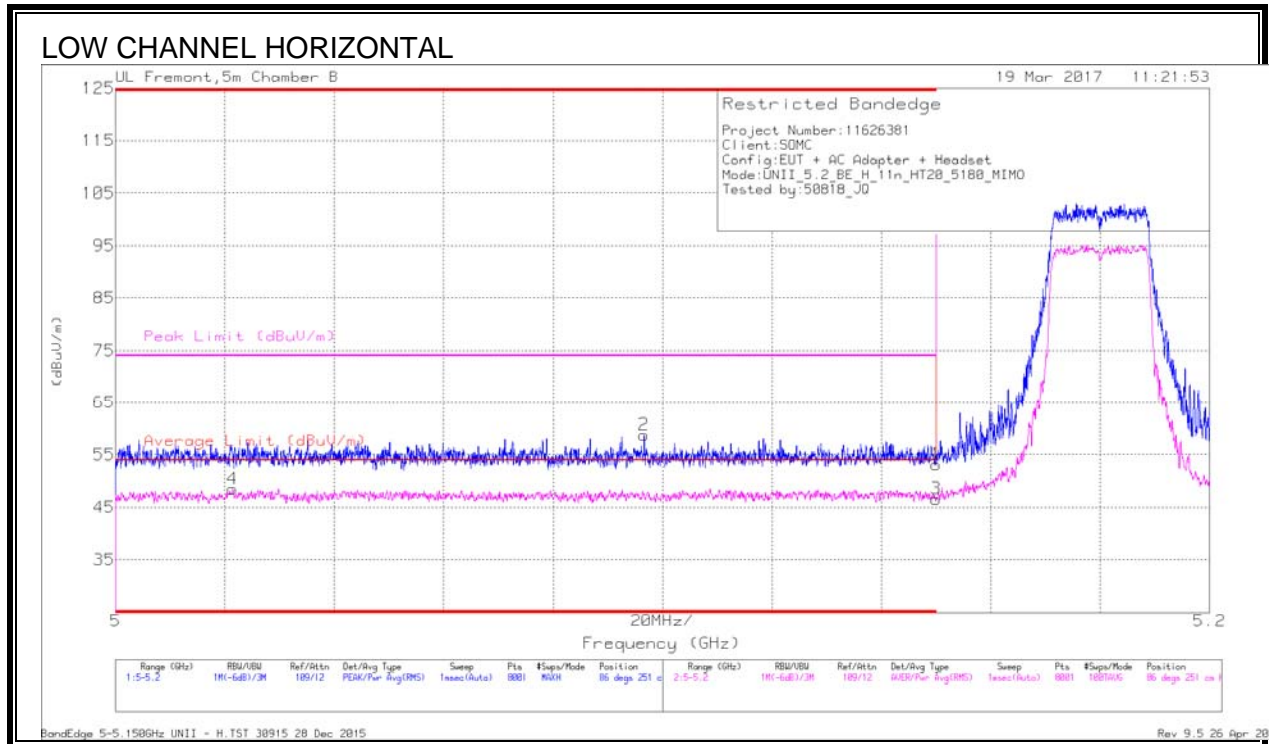

Trace Markers

Marker	Frequency (GHz)	Meter Reading (dBuV)	Det	AF1345 (dB/m)	Amp/Chl/Filt/Pad (dB)	DC Corr (dB)	Corrected Reading (dBuV/m)	Average Limit (dBuV/m)	Margin (dB)	Peak Limit (dBuV/m)	PK Margin (dB)	Azimuth (Degs)	Height (cm)	Polarity
2	* 5.097	42.43	Pk	34.1	-17.8	0	58.73	-	-	74	-15.27	86	251	H
4	* 5.021	31.97	RMS	34.1	-17.7	.1	48.47	54	-5.53	-	-	86	251	H
1	5.15	37.02	Pk	34.2	-18.1	0	53.12	-	-	74	-20.88	86	251	H
3	5.15	30.4	RMS	34.2	-18.1	.1	46.6	54	-7.4	-	-	86	251	H

* - indicates frequency in CFR15.205/IC8.10 RSS-Restricted Band

Pk - Peak detector

RMS - RMS detection

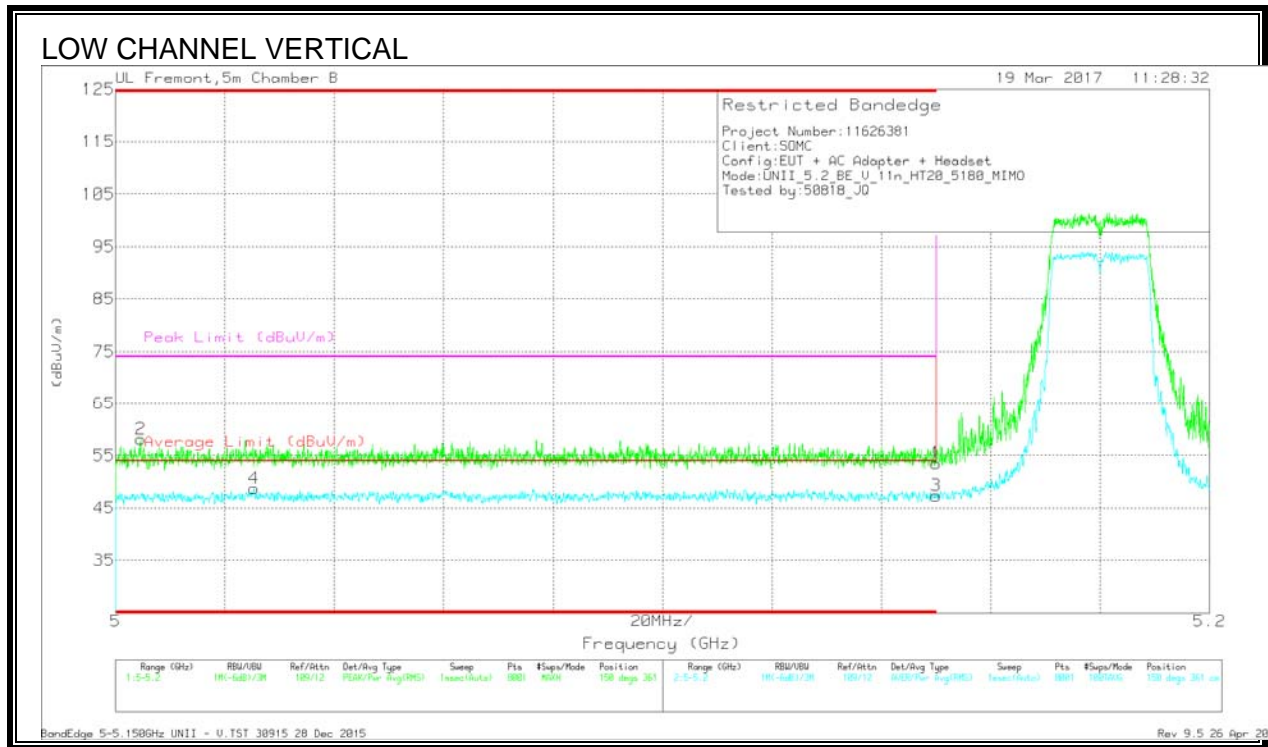

Trace Markers

Marker	Frequency (GHz)	Meter Reading (dBuV)	Det	AFT345 (dB/m)	Amp/CbI/Rtr/Pad (dB)	DC Corr (dB)	Corrected Reading (dBuV/m)	Average Limit (dBuV/m)	Margin (dB)	Peak Limit (dBuV/m)	PK Margin (dB)	Azimuth (Degs)	Height (cm)	Polarity
2	* 5.005	41.72	Pk	34.1	-17.7	0	58.12	-	-	74	-15.88	150	361	V
4	* 5.025	32.04	RMS	34.1	-17.6	.1	48.64	54	-5.36	-	-	150	361	V
1	5.15	37.37	Pk	34.2	-18.1	0	53.47	-	-	74	-20.53	150	361	V
3	5.15	31.11	RMS	34.2	-18.1	.1	47.31	54	-6.69	-	-	150	361	V

* - indicates frequency in CFR15.205/IC8.10 RSS-Restricted Band

Pk - Peak detector

RMS - RMS detection

HARMONICS AND SPURIOUS EMISSIONS

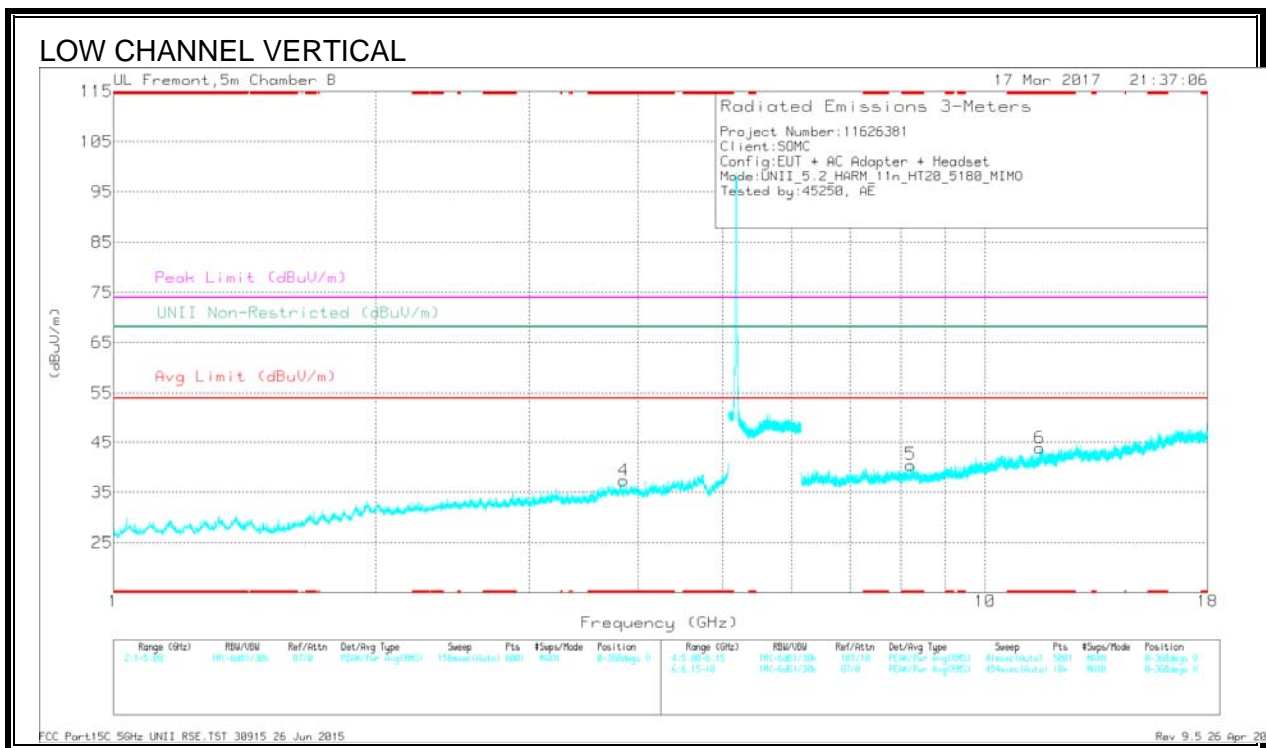
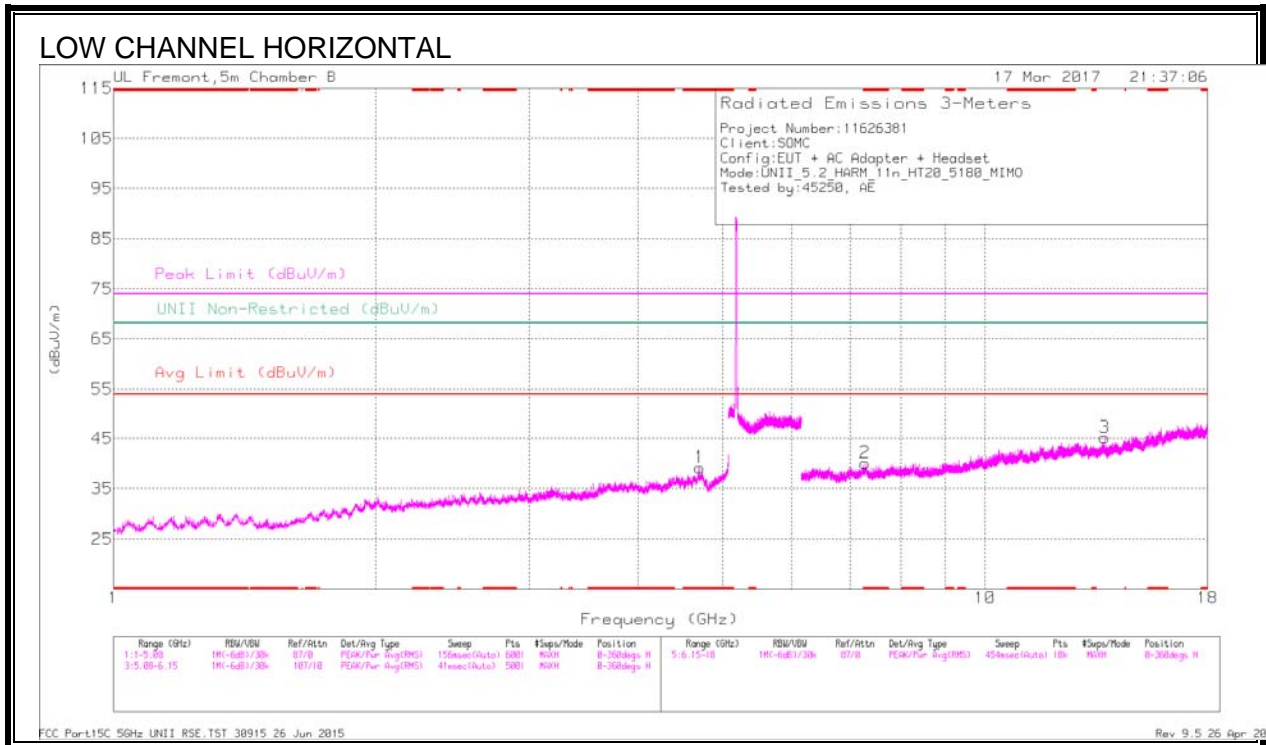

Trace Markers

Marker	Frequency (GHz)	Meter Reading (dBuV)	Det	AF T345 (dB/m)	Amp/Ch/Ftr/Pad (dB)	DC Corr (dB)	Corrected Reading (dBuV/m)	Avg Limit (dBuV/m)	Margin (dB)	Peak Limit (dBuV/m)	PK Margin (dB)	UNII Non-Restricted (dBuV/m)	PK Margin (dB)	Altitude (Degs)	Height (cm)	Polarity
1	* 4.707	34.55	Pk	34.1	-29.5	0	39.15	-	-	74	-34.85	-	-	0-360	98	H
4	* 3.849	35.04	Pk	33.4	-31	0	37.44	-	-	74	-36.56	-	-	0-360	98	V
2	* 7.283	30.65	Pk	35.6	-26.1	0	40.15	-	-	74	-33.85	-	-	0-360	98	H
5	* 8.222	31.27	Pk	35.8	-26.5	0	40.57	-	-	74	-33.43	-	-	0-360	201	V
6	* 11.555	28.19	Pk	38.4	-22.7	0	43.89	-	-	74	-30.11	-	-	0-360	98	V
3	13.711	28.79	Pk	38.8	-22.4	0	45.19	-	-	-	-	68.2	-23.01	0-360	201	H

* - indicates frequency in CFR15.205/IC8.10 RSS-Restricted Band
 Pk - Peak detector

Radiated Emissions

Frequency (GHz)	Meter Reading (dBuV)	Det	AF T345 (dB/m)	Amp/Ch/Ftr/Pad (dB)	DC Corr (dB)	Corrected Reading (dBuV/m)	Avg Limit (dBuV/m)	Margin (dB)	Peak Limit (dBuV/m)	PK Margin (dB)	UNII Non-Restricted (dBuV/m)	PK Margin (dB)	Altitude (Degs)	Height (cm)	Polarity
* 4.706	38.52	PK-U	34.1	-29.5	0	43.12	-	-	74	-30.88	-	-	317	173	H
* 4.705	28.84	ADR	34.1	-29.5	-1	33.54	54	-20.46	-	-	-	-	317	173	H
* 3.848	38.65	PK-U	33.4	-31	0	41.05	-	-	74	-32.95	-	-	170	236	V
* 3.85	29.58	ADR	33.4	-31	-1	32.08	54	-21.92	-	-	-	-	170	236	V
* 7.284	35.84	PK-U	35.6	-26.1	0	45.34	-	-	74	-28.66	-	-	226	298	H
* 7.283	25.93	ADR	35.6	-26.1	-1	35.53	54	-18.47	-	-	-	-	226	298	H
* 8.221	35.97	PK-U	35.8	-26.5	0	45.27	-	-	74	-28.73	-	-	224	224	V
* 8.22	25.5	ADR	35.8	-26.6	-1	34.8	54	-19.2	-	-	-	-	224	224	V
* 11.555	32.3	PK-U	38.4	-22.6	0	48.1	-	-	74	-25.9	-	-	125	145	V
* 11.553	22.68	ADR	38.4	-22.7	-1	38.48	54	-15.52	-	-	-	-	125	145	V
13.71	22.58	ADR	38.8	-22.4	-1	39.08	-	-	-	-	-	-	182	265	H
13.711	32.92	PK-U	38.8	-22.3	0	49.42	-	-	-	-	68.2	-18.78	182	265	H

* - indicates frequency in CFR15.205/IC8.10 RSS-Restricted Band
 PK-U - U-NII: Maximum Peak
 ADR - U-NII AD primary method, RMS average

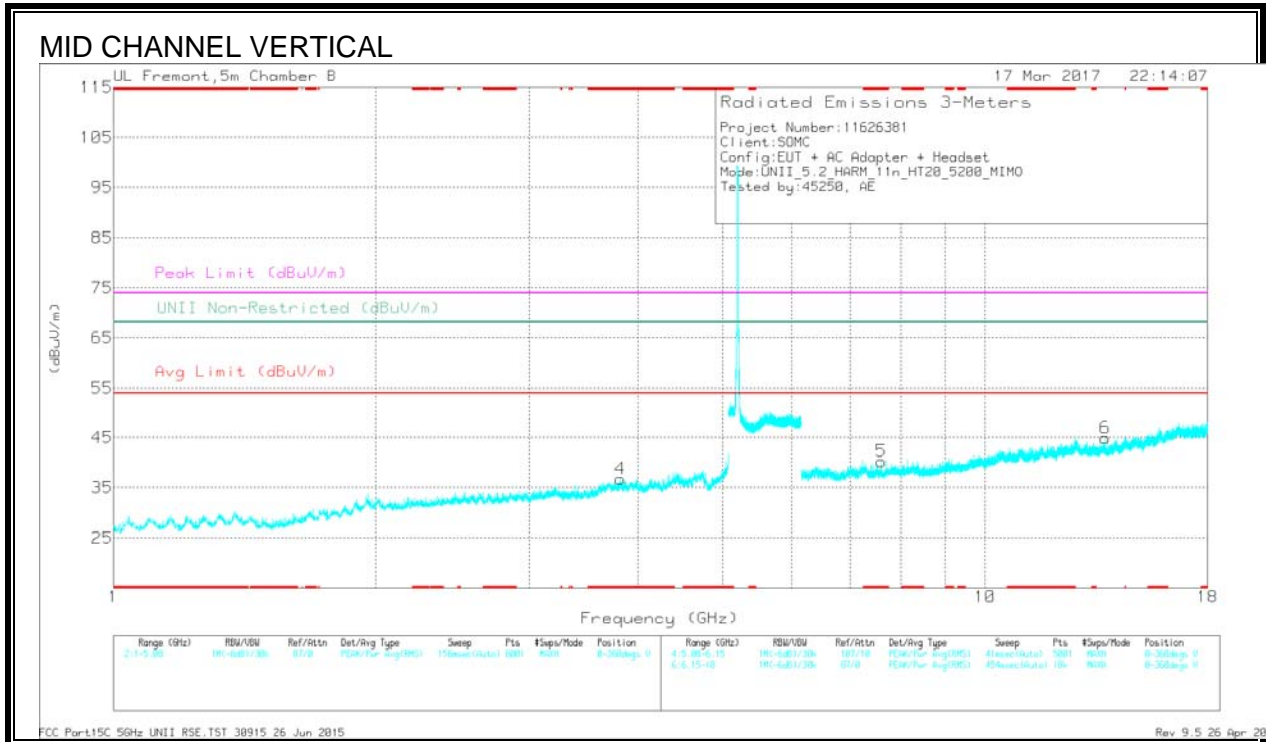
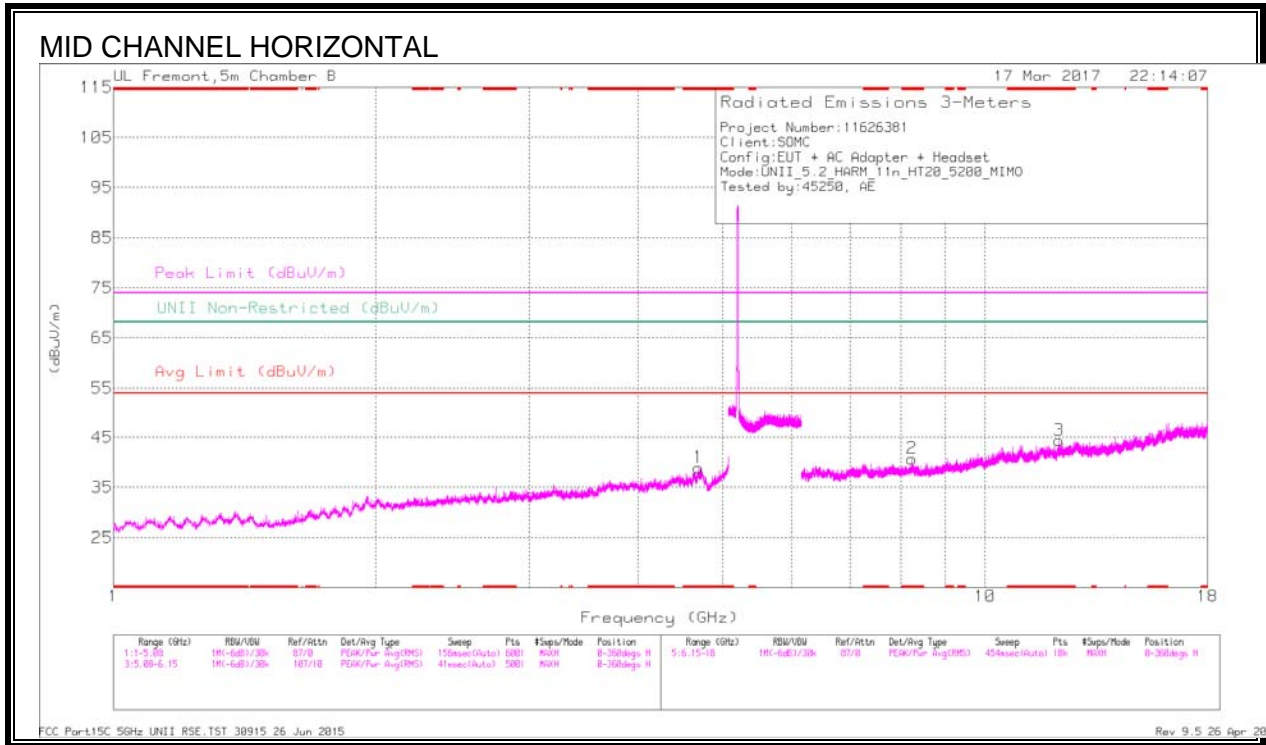

Trace Markers

Marker	Frequency (GHz)	Meter Reading (dBuV)	Det	AF T345 (dB/m)	Amp/Ch/Ftr/Pad (dB)	DC Corr (dB)	Corrected Reading (dBuV/m)	Avg Limit (dBuV/m)	Margin (dB)	Peak Limit (dBuV/m)	PK Margin (dB)	UNI Non-Restricted (dBuV/m)	PK Margin (dB)	Altitude (Degs)	Height (cm)	Polarity
1	* 4.694	34.17	Pk	34.1	-29.3	0	38.97	-	-	74	-35.03	-	-	0-360	201	H
4	* 3.819	34.1	Pk	33.4	-30.8	0	36.7	-	-	74	-37.3	-	-	0-360	201	V
2	* 8.248	31.41	Pk	35.8	-26.5	0	40.71	-	-	74	-33.29	-	-	0-360	201	H
3	* 12.153	28.3	Pk	39	-22.9	0	44.4	-	-	74	-29.6	-	-	0-360	98	H
5	* 7.605	31.7	Pk	35.7	-27.2	0	40.2	-	-	74	-33.8	-	-	0-360	98	V
6	13.735	28.52	Pk	38.8	-22.4	0	44.92	-	-	-	-	68.2	-23.28	0-360	98	V

* - indicates frequency in CFR15.205/IC8.10 RSS-Restricted Band
 Pk - Peak detector

Radiated Emissions

Frequency (GHz)	Meter Reading (dBuV)	Det	AF T345 (dB/m)	Amp/Ch/Ftr/Pad (dB)	DC Corr (dB)	Corrected Reading (dBuV/m)	Avg Limit (dBuV/m)	Margin (dB)	Peak Limit (dBuV/m)	PK Margin (dB)	UNI Non-Restricted (dBuV/m)	PK Margin (dB)	Altitude (Degs)	Height (cm)	Polarity
* 4.695	39.17	PK-U	34.1	-29.3	0	43.97	-	-	74	-30.03	-	-	3	173	H
* 4.692	29.16	ADR	34.1	-29.3	-1	34.06	54	-19.94	-	-	-	-	3	173	H
* 3.819	38.99	PK-U	33.4	-30.8	0	41.59	-	-	74	-32.41	-	-	66	205	V
* 3.818	29.16	ADR	33.4	-30.8	-1	31.86	54	-22.14	-	-	-	-	66	205	V
* 8.247	35.66	PK-U	35.8	-26.5	0	44.96	-	-	74	-29.04	-	-	156	268	H
* 8.249	25.95	ADR	35.8	-26.5	-1	35.35	54	-18.65	-	-	-	-	156	268	H
* 12.153	32.02	PK-U	39	-22.9	0	48.12	-	-	74	-25.88	-	-	242	235	H
* 12.155	22.62	ADR	39	-22.8	-1	38.92	54	-15.08	-	-	-	-	242	235	H
* 7.606	36.26	PK-U	35.7	-27.2	0	44.76	-	-	74	-29.24	-	-	187	179	V
* 7.607	25.74	ADR	35.7	-27.2	-1	34.34	54	-19.66	-	-	-	-	187	179	V
13.736	32.65	PK-U	38.8	-22.4	0	49.05	-	-	-	-	68.2	-19.15	96	107	V
13.737	22.71	ADR	38.8	-22.4	-1	39.21	-	-	-	-	-	-	96	107	V

* - indicates frequency in CFR15.205/IC8.10 RSS-Restricted Band
 PK-U - U-NII: Maximum Peak
 ADR - U-NII AD primary method, RMS average

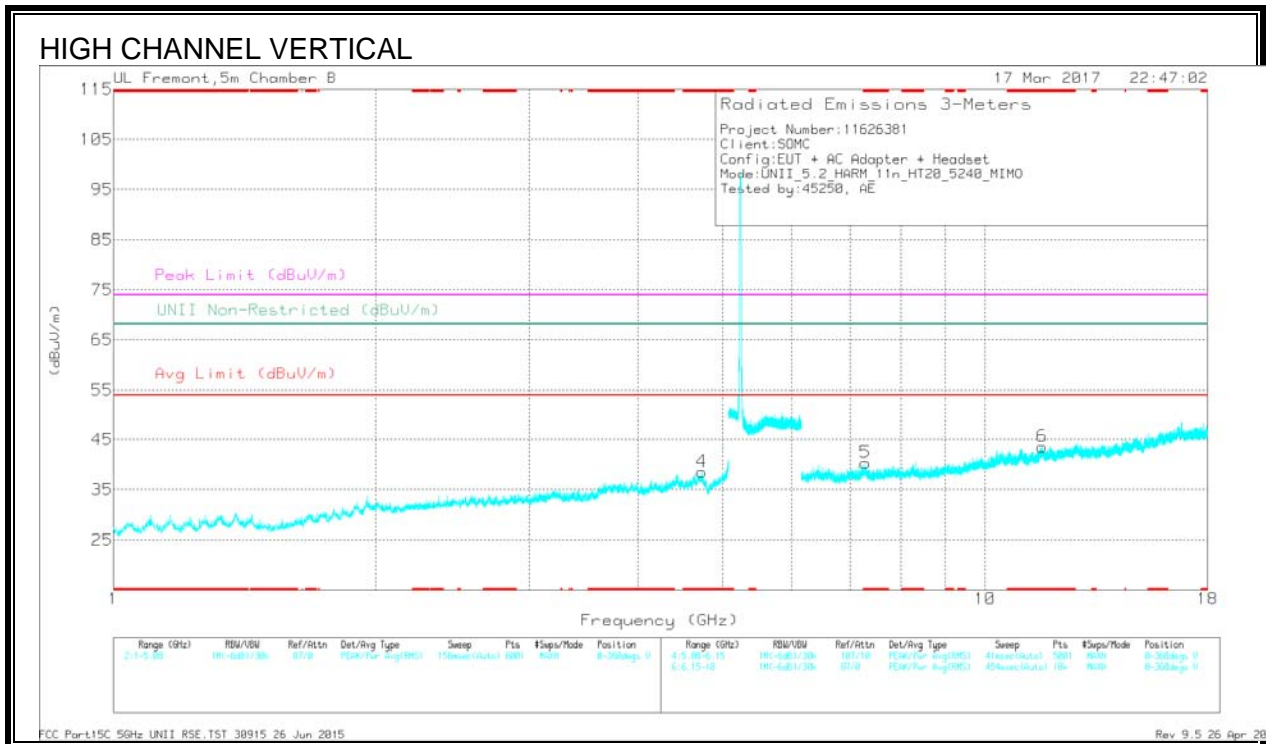
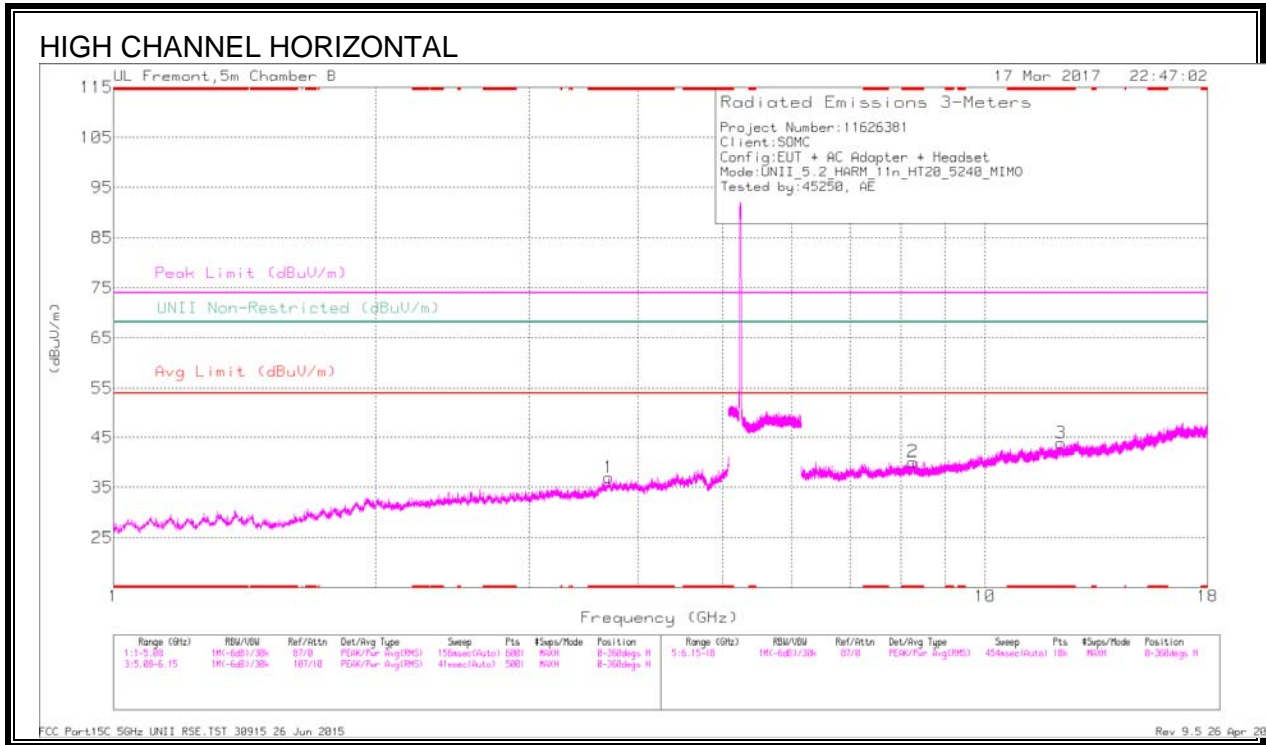

Trace Markers

Marker	Frequency (GHz)	Meter Reading (dBuV)	Det	AF T345 (dB/m)	Amp/Ch/Ftr/Pad (dB)	DC Corr (dB)	Corrected Reading (dBuV/m)	Avg Limit (dBuV/m)	Margin (dB)	Peak Limit (dBuV/m)	PK Margin (dB)	UNII Non-Restricted (dBuV/m)	PK Margin (dB)	Altitude (Degs)	Height (cm)	Polarity
1	* 3.702	34.17	Pk	33.4	-30.6	0	36.97	-	-	74	-37.03	-	-	0-360	201	H
4	* 4.731	33.65	Pk	34	-29.1	0	38.55	-	-	74	-35.45	-	-	0-360	201	V
2	* 8.265	30.35	Pk	35.8	-26	0	40.15	-	-	74	-33.85	-	-	0-360	201	H
3	* 12.219	27.44	Pk	39.1	-22.7	0	43.84	-	-	74	-30.16	-	-	0-360	201	H
5	* 7.29	30.84	Pk	35.6	-26.1	0	40.34	-	-	74	-33.66	-	-	0-360	98	V
6	* 11.634	27.36	Pk	38.5	-22.3	0	43.56	-	-	74	-30.44	-	-	0-360	201	V

* - indicates frequency in CFR15.205/IC8.10 RSS-Restricted Band
 Pk - Peak detector

Radiated Emissions

Frequency (GHz)	Meter Reading (dBuV)	Det	AF T345 (dB/m)	Amp/Ch/Ftr/Pad (dB)	DC Corr (dB)	Corrected Reading (dBuV/m)	Avg Limit (dBuV/m)	Margin (dB)	Peak Limit (dBuV/m)	PK Margin (dB)	UNII Non-Restricted (dBuV/m)	PK Margin (dB)	Altitude (Degs)	Height (cm)	Polarity
* 3.701	39.21	PK-U	33.4	-30.6	0	42.01	-	-	74	-31.99	-	-	190	107	H
* 3.704	29.06	ADR	33.4	-30.5	.1	32.06	54	-21.94	-	-	-	-	190	107	H
* 4.732	39.3	PK-U	34	-29.1	0	44.2	-	-	74	-29.8	-	-	273	156	V
* 4.733	29.01	ADR	34	-29.1	.1	34.01	54	-19.99	-	-	-	-	273	156	V
* 8.263	36.1	PK-U	35.8	-26.1	0	45.8	-	-	74	-28.2	-	-	239	206	H
* 8.267	25.58	ADR	35.8	-25.9	.1	35.58	54	-18.42	-	-	-	-	239	206	H
* 12.218	31.83	PK-U	39.1	-22.7	0	48.23	-	-	74	-25.77	-	-	289	310	H
* 12.22	22.79	ADR	39.1	-22.7	.1	39.29	54	-14.71	-	-	-	-	289	310	H
* 7.291	35.44	PK-U	35.6	-26.1	0	44.94	-	-	74	-29.06	-	-	175	284	V
* 7.289	25.63	ADR	35.6	-26.1	.1	35.23	54	-18.77	-	-	-	-	175	284	V
* 11.633	32.89	PK-U	38.5	-22.3	0	49.09	-	-	74	-24.91	-	-	360	196	V
* 11.635	22.72	ADR	38.5	-22.3	.1	39.02	54	-14.98	-	-	-	-	360	196	V

* - indicates frequency in CFR15.205/IC8.10 RSS-Restricted Band
 PK-U - U-NII: Maximum Peak
 ADR - U-NII AD primary method, RMS average

10.1.3. 11n HT40 2TX CDD MIMO MODE IN THE 5.2GHZ BAND

RESTRICTED BANDEDGE (LOW CHANNEL)

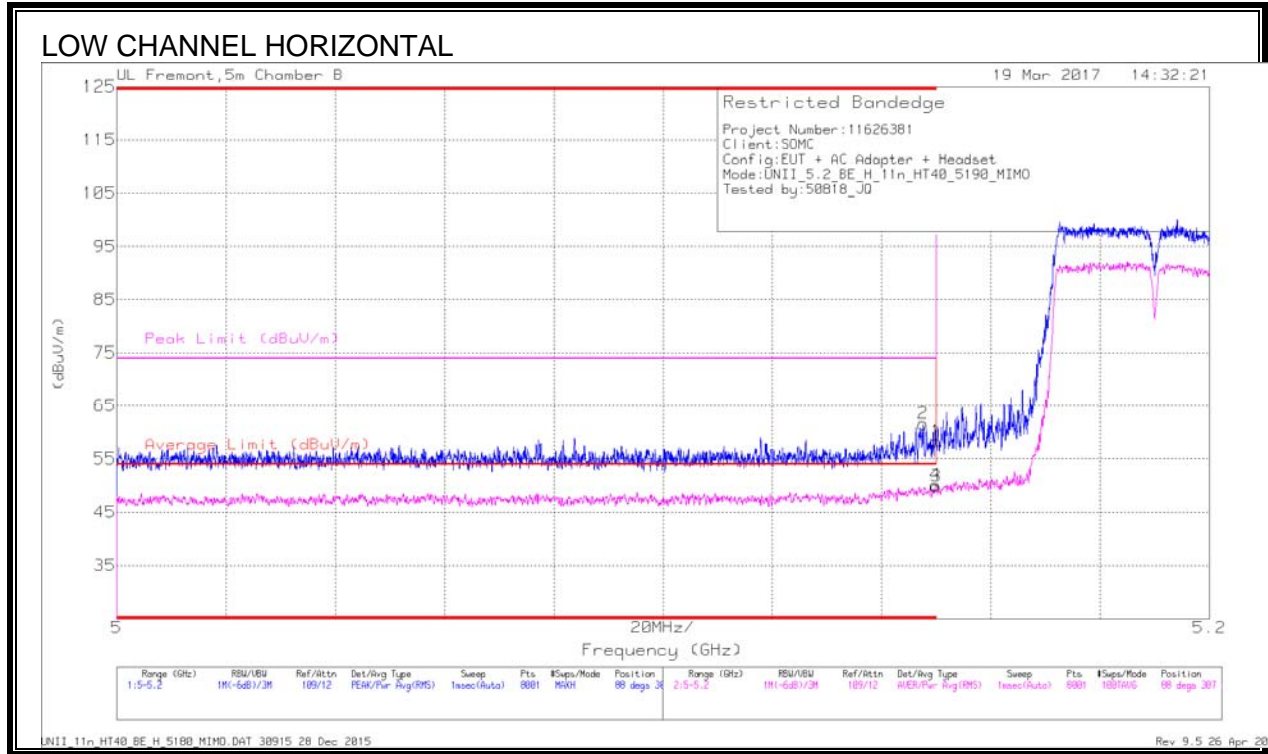

Trace Markers

Marker	Frequency (GHz)	Meter Reading (dBuV)	Det	AFT345 (dB/m)	Amp/Cbl/Fib/Pad (dB)	DC Corr (dB)	Corrected Reading (dBuV/m)	Average Limit (dBuV/m)	Margin (dB)	Peak Limit (dBuV/m)	PK Margin (dB)	Azimuth (Degs)	Height (cm)	Polarity
2	* 5.148	45.31	Pk	34.2	-18	0	61.51	-	-	74	-12.49	88	307	H
4	* 5.15	33.76	RMS	34.2	-18.1	.22	50.08	54	-3.92	-	-	88	307	H
1	5.15	42.15	Pk	34.2	-18.1	0	58.25	-	-	74	-15.75	88	307	H
3	5.15	33.53	RMS	34.2	-18.1	.22	49.85	54	-4.15	-	-	88	307	H

* - indicates frequency in CFR15.205/IC8.10 RSS-Restricted Band

Pk - Peak detector

RMS - RMS detection

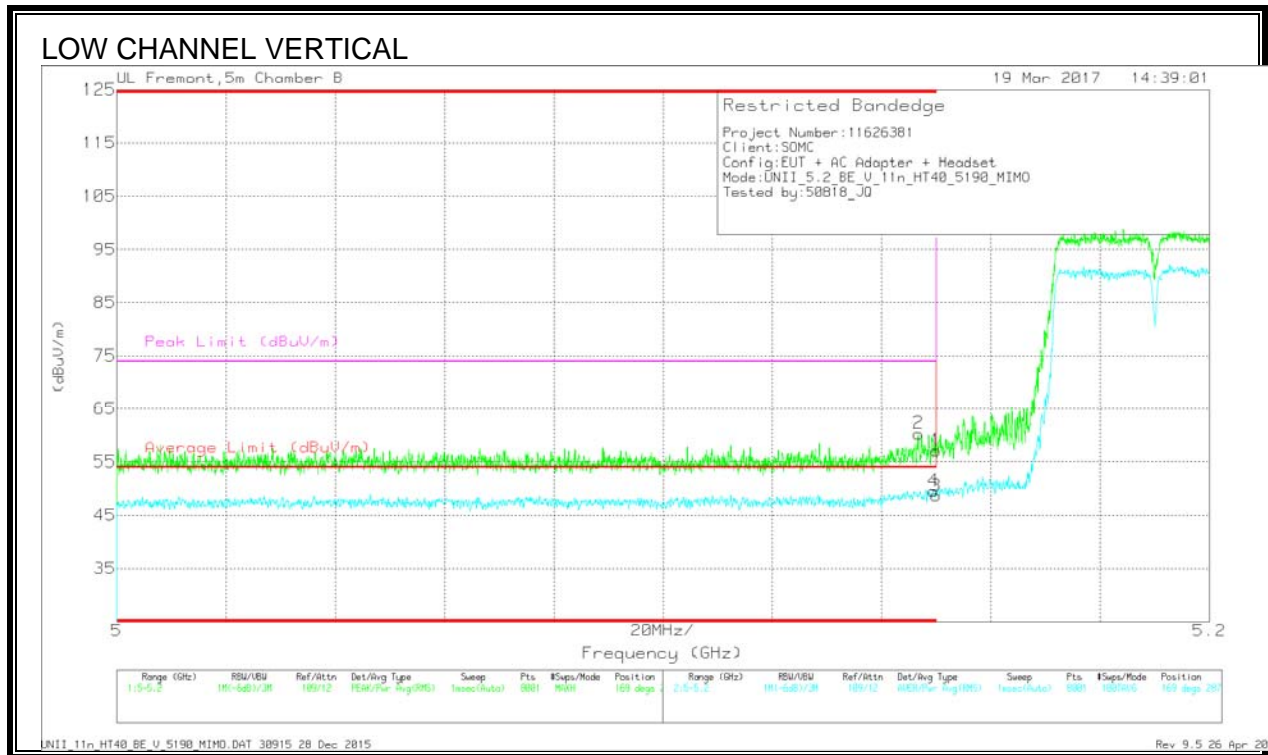

Trace Markers

Marker	Frequency (GHz)	Meter Reading (dBuV)	Det	AF T345 (dB/m)	Amp/Chl/Filt/Pad (dB)	DC Corr (dB)	Corrected Reading (dBuV/m)	Average Limit (dBuV/m)	Margin (dB)	Peak Limit (dBuV/m)	PK Margin (dB)	Azimuth (Degs)	Height (cm)	Polarity
2	* 5.147	43.98	Pk	34.2	-17.9	0	60.28	-	-	74	-13.72	169	287	V
4	* 5.149	33.4	RMS	34.2	-18.1	.22	49.72	54	-4.28	-	-	169	287	V
1	5.15	40.97	Pk	34.2	-18.1	0	57.07	-	-	74	-16.93	169	287	V
3	5.15	32.5	RMS	34.2	-18.1	.22	48.82	54	-5.18	-	-	169	287	V

* - indicates frequency in CFR15.205/IC8.10 RSS-Restricted Band

Pk - Peak detector

RMS - RMS detection

HARMONICS AND SPURIOUS EMISSIONS

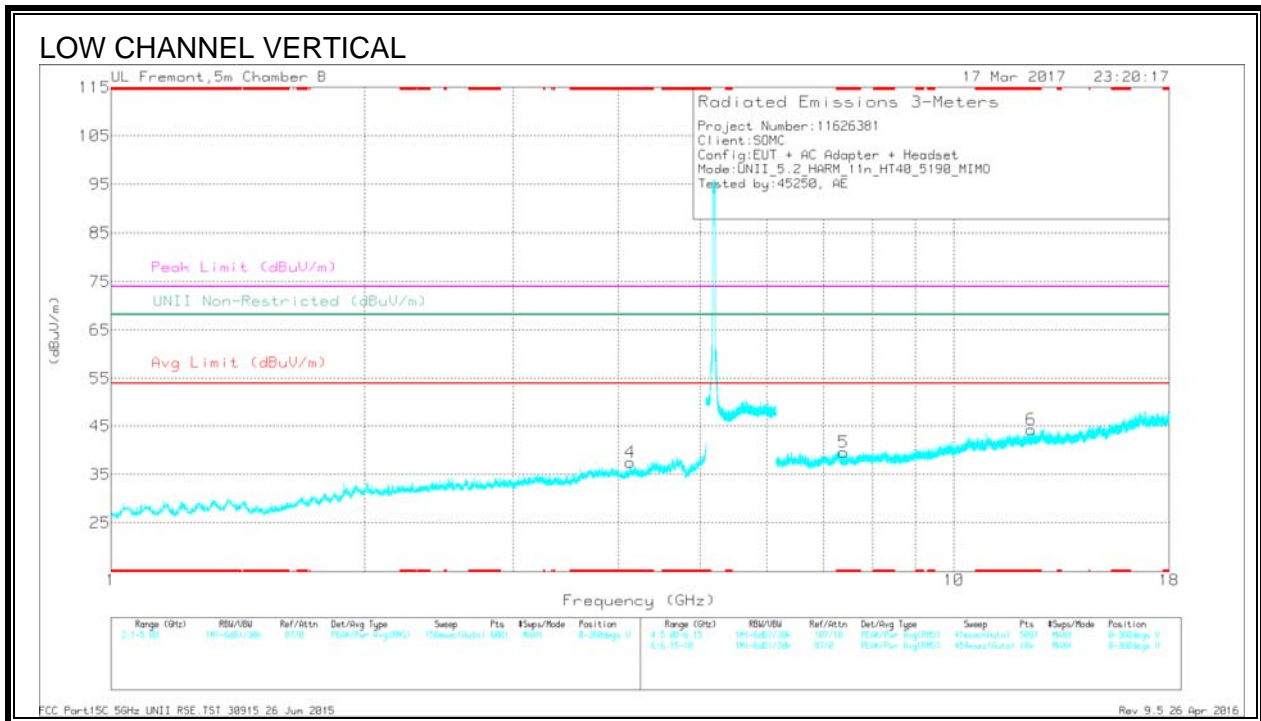
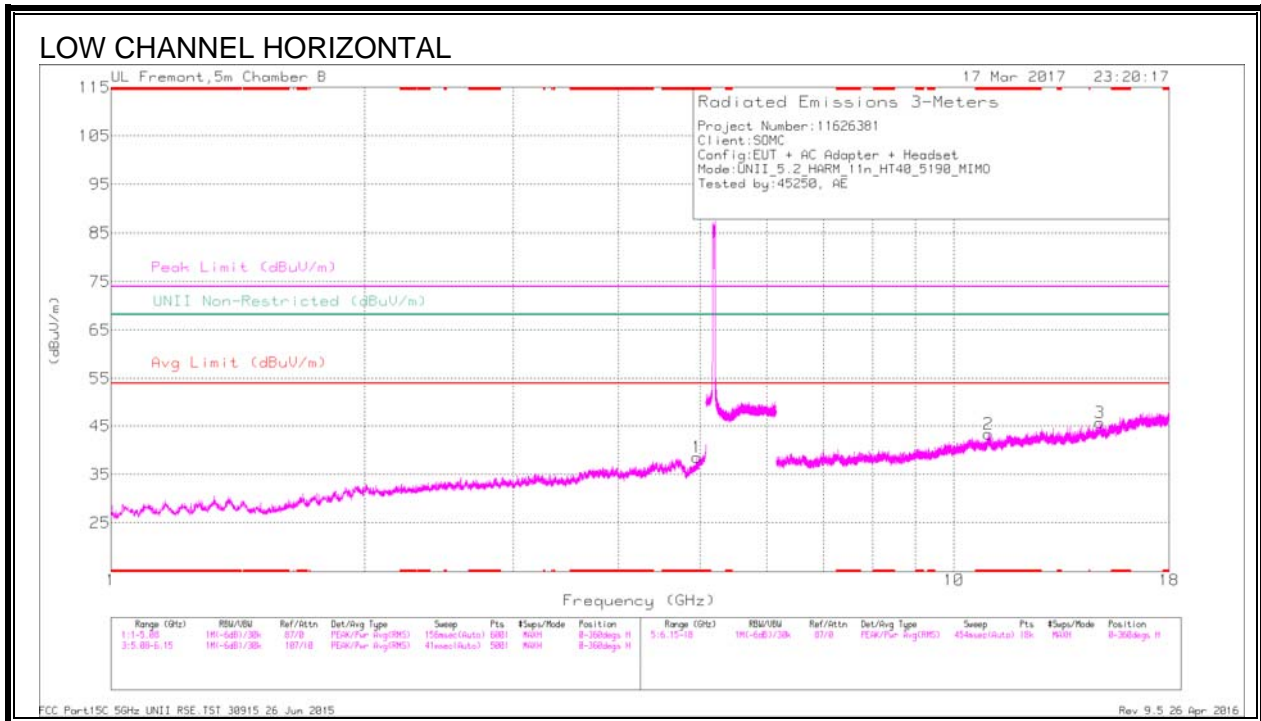

Trace Markers

Marker	Frequency (GHz)	Meter Reading (dBuV)	Det	AF T345 (dB/m)	Amp/CM/FT/Pad (dB)	DC Corr (dB)	Corrected Reading (dBuV/m)	Avg Limit (dBuV/m)	Margin (dB)	Peak Limit (dBuV/m)	PK Margin (dB)	UNII Non-Restricted (dBuV/m)	PK Margin (dB)	Asimuth (Degs)	Height (cm)	Polarity
1	* 4.954	33.56	Pk	34	-29	0	38.56	-	-	74	-35.44	-	-	0-360	201	H
4	* 4.132	33.79	Pk	33.7	-30	0	37.49	-	-	74	-36.51	-	-	0-360	98	V
2	* 10.987	27.94	Pk	37.9	-22.5	0	43.34	-	-	74	-30.66	-	-	0-360	98	H
5	* 7.403	31.84	Pk	35.6	-27.9	0	39.54	-	-	74	-34.46	-	-	0-360	201	V
6	* 12.354	28.41	Pk	39	-23.1	0	44.31	-	-	74	-29.69	-	-	0-360	98	V
3	14.899	27.58	Pk	39.8	-21.7	0	45.68	-	-	-	-	68.2	-22.52	0-360	98	H

* - indicates frequency in CFR15.205/IC8.10 RSS-Restricted Band
 Pk - Peak detector

Radiated Emissions

Frequency (GHz)	Meter Reading (dBuV)	Det	AF T345 (dB/m)	Amp/CM/FT/Pad (dB)	DC Corr (dB)	Corrected Reading (dBuV/m)	Avg Limit (dBuV/m)	Margin (dB)	Peak Limit (dBuV/m)	PK Margin (dB)	UNII Non-Restricted (dBuV/m)	PK Margin (dB)	Asimuth (Degs)	Height (cm)	Polarity
* 4.955	38.24	PK-U	34	-29	0	43.24	-	-	74	-30.76	-	-	307	121	H
* 4.955	28.43	ADR	34	-29	22	33.65	54	-20.35	-	-	-	-	307	121	H
* 4.133	38.54	PK-U	33.7	-30	0	42.24	-	-	74	-31.76	-	-	249	152	V
* 4.131	28.3	ADR	33.7	-30.1	22	32.12	54	-21.88	-	-	-	-	249	152	V
* 10.986	32.42	PK-U	37.9	-22.5	0	47.82	-	-	74	-26.18	-	-	188	320	H
* 10.989	22.79	ADR	37.9	-22.5	22	38.41	54	-15.59	-	-	-	-	188	320	H
* 7.402	36.67	PK-U	35.6	-27.8	0	44.47	-	-	74	-29.53	-	-	269	213	V
* 7.404	26.83	ADR	35.6	-27.9	22	34.75	54	-19.25	-	-	-	-	269	213	V
* 12.353	33.92	PK-U	39	-23	0	49.92	-	-	74	-24.08	-	-	36	102	V
* 12.355	22.82	ADR	39	-23.1	22	38.94	54	-15.06	-	-	-	-	36	102	V
14.898	32.99	PK-U	39.8	-21.7	0	51.09	-	-	-	-	68.2	-17.11	318	290	H
14.899	22.75	ADR	39.8	-21.7	22	41.07	-	-	-	-	-	-	318	290	H

* - indicates frequency in CFR15.205/IC8.10 RSS-Restricted Band
 PK-U - U-NII: Maximum Peak
 ADR - U-NII AD primary method, RMS average

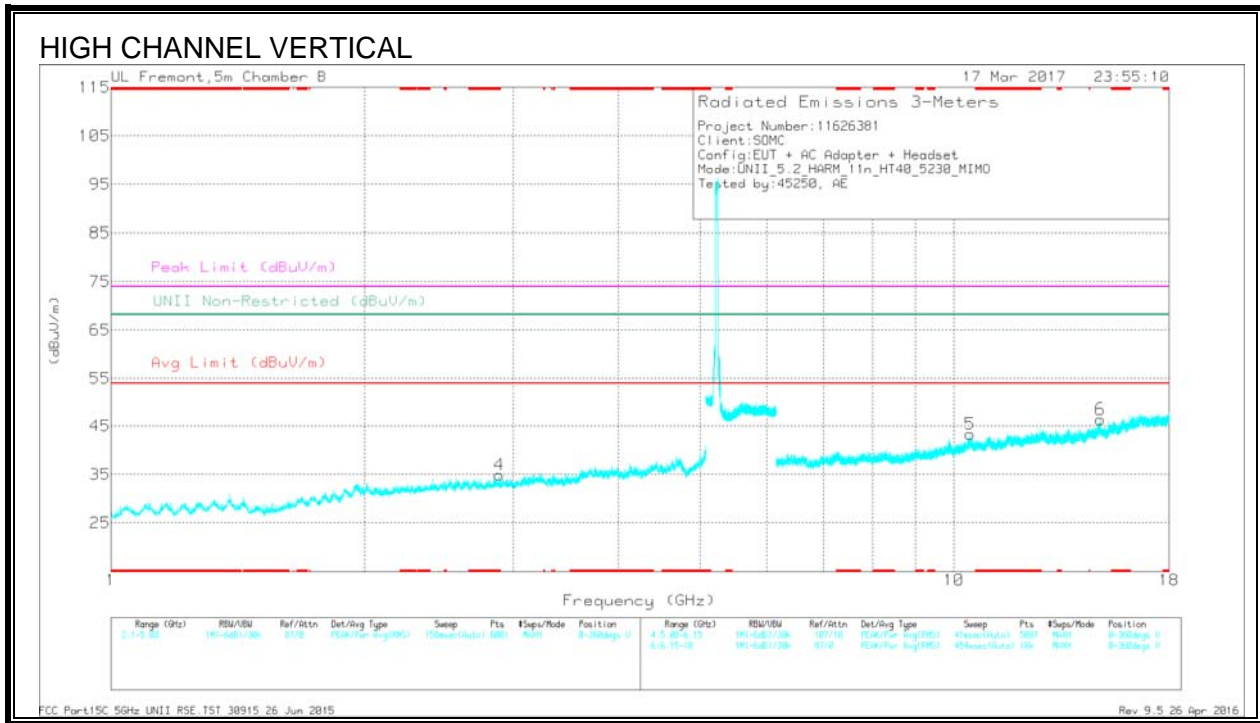
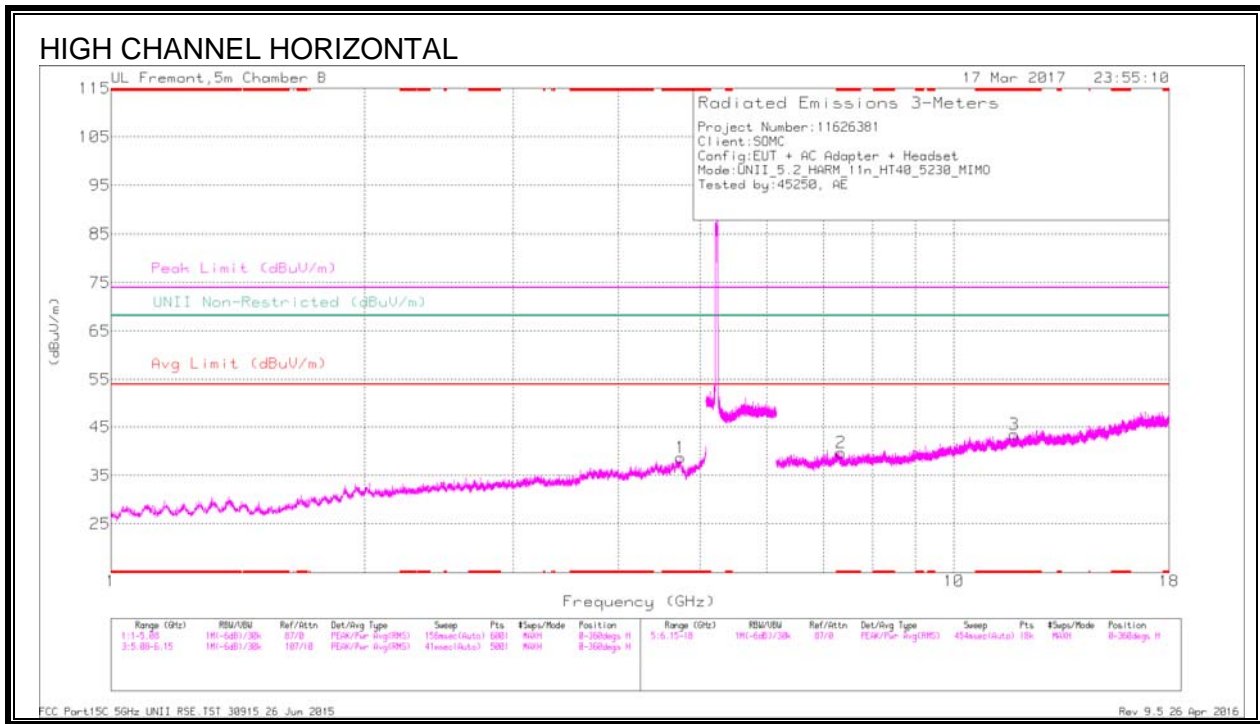

Trace Markers

Marker	Frequency (GHz)	Meter Reading (dBuV)	Det	AF T345 (dB/m)	Amp/CM/RTU/Pad (dB)	DC Corr (dB)	Corrected Reading (dBuV/m)	Aug Limit (dBuV/m)	Margin (dB)	Peak Limit (dBuV/m)	PK Margin (dB)	UNII Non-Restricted (dBuV/m)	PK Margin (dB)	Asimuth (Degs)	Height (cm)	Polarity
1	* 4.739	33.81	Pk	34	-29.1	0	38.71	-	-	74	-35.29	-	-	0-360	102	H
4	* 2.89	34.07	Pk	32.4	-31.5	0	34.97	-	-	74	-39.03	-	-	0-360	98	V
2	* 7.353	31.61	Pk	35.6	-27.5	0	39.71	-	-	74	-34.29	-	-	0-360	98	H
3	* 11.79	28.05	Pk	38.7	-23.2	0	43.55	-	-	74	-30.45	-	-	0-360	201	H
5	10.446	28.4	Pk	37.7	-22.7	0	43.4	-	-	-	-	68.2	-24.8	0-360	201	V
6	14.92	28.61	Pk	39.8	-22	0	46.41	-	-	-	-	68.2	-21.79	0-360	98	V

* - indicates frequency in CFR15.205/IC8.10 RSS-Restricted Band
 Pk - Peak detector

Radiated Emissions

Frequency (GHz)	Meter Reading (dBuV)	Det	AF T345 (dB/m)	Amp/CM/RTU/Pad (dB)	DC Corr (dB)	Corrected Reading (dBuV/m)	Aug Limit (dBuV/m)	Margin (dB)	Peak Limit (dBuV/m)	PK Margin (dB)	UNII Non-Restricted (dBuV/m)	PK Margin (dB)	Asimuth (Degs)	Height (cm)	Polarity
* 4.741	38.81	PK-U	34	-29.1	0	43.71	-	-	74	-30.29	-	-	38	120	H
* 4.738	28.86	ADR	34	-29.1	22	33.98	54	-20.02	-	-	-	-	38	120	H
* 2.892	39.25	PK-U	32.5	-31.5	0	40.25	-	-	74	-33.75	-	-	105	266	V
* 2.889	28.28	ADR	32.4	-31.5	22	29.4	54	-24.6	-	-	-	-	105	266	V
* 7.353	36.82	PK-U	35.6	-27.5	0	44.92	-	-	74	-29.08	-	-	221	315	H
* 7.354	26.35	ADR	35.6	-27.5	22	34.67	54	-19.33	-	-	-	-	221	315	H
* 11.791	32.9	PK-U	38.7	-23.2	0	48.4	-	-	74	-25.6	-	-	175	177	H
* 11.788	22.77	ADR	38.7	-23.2	22	38.49	54	-15.51	-	-	-	-	175	177	H
10.444	32.93	PK-U	37.7	-22.7	0	47.93	-	-	-	-	68.2	-20.27	85	252	V
10.445	23.11	ADR	37.7	-22.7	22	38.33	-	-	-	-	-	-	85	252	V
14.921	32.52	PK-U	39.8	-22	0	50.32	-	-	-	-	68.2	-17.88	9	106	V
14.922	22.53	ADR	39.8	-22	22	40.55	-	-	-	-	-	-	9	106	V

* - indicates frequency in CFR15.205/IC8.10 RSS-Restricted Band
 PK-U - U-NII: Maximum Peak
 ADR - U-NII AD primary method, RMS average

10.1.4. 11ac HT80 2TX CDD MIMO MODE IN THE 5.2GHz BAND

RESTRICTED BANDEDGE (LOW CHANNEL)

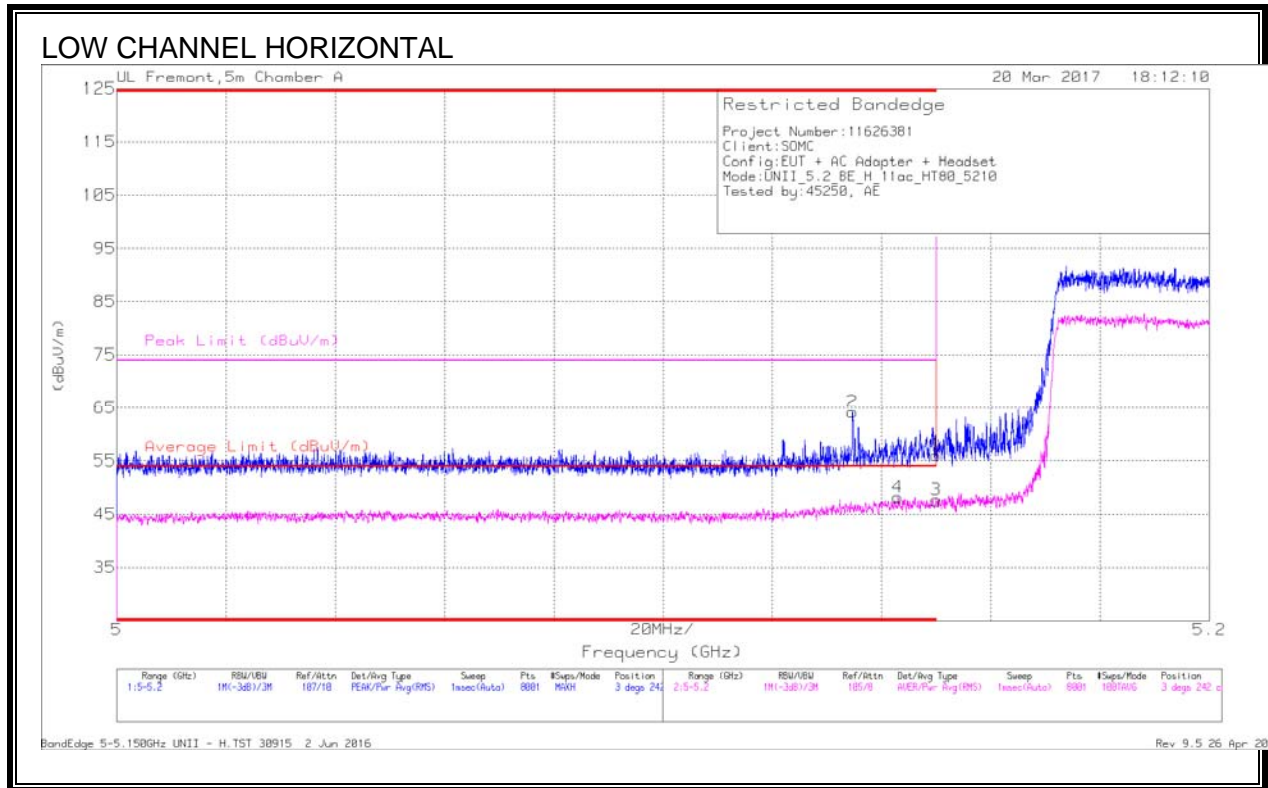

Trace Markers

Marker	Frequency (GHz)	Meter Reading (dBuV)	Det	AF T711 (dB/m)	Amp/Cb/Filt/Pad (dB)	Corrected Reading (dBuV/m)	Average Limit (dBuV/m)	Margin (dB)	Peak Limit (dBuV/m)	PK Margin (dB)	Azimuth (Degs)	Height (cm)	Polarity
2	* 5.135	48.69	Pk	34.1	-18.6	64.19	-	-	74	-9.81	3	242	H
4	* 5.143	32.6	RMS	34.1	-18.6	48.1	54	-5.9	-	-	3	242	H
1	5.15	40.6	Pk	34.1	-18.7	56	-	-	74	-18	3	242	H
3	5.15	32.19	RMS	34.1	-18.7	47.59	54	-6.41	-	-	3	242	H

* - indicates frequency in CFR15.205/IC8.10 RSS-Restricted Band

Pk - Peak detector

RMS - RMS detection

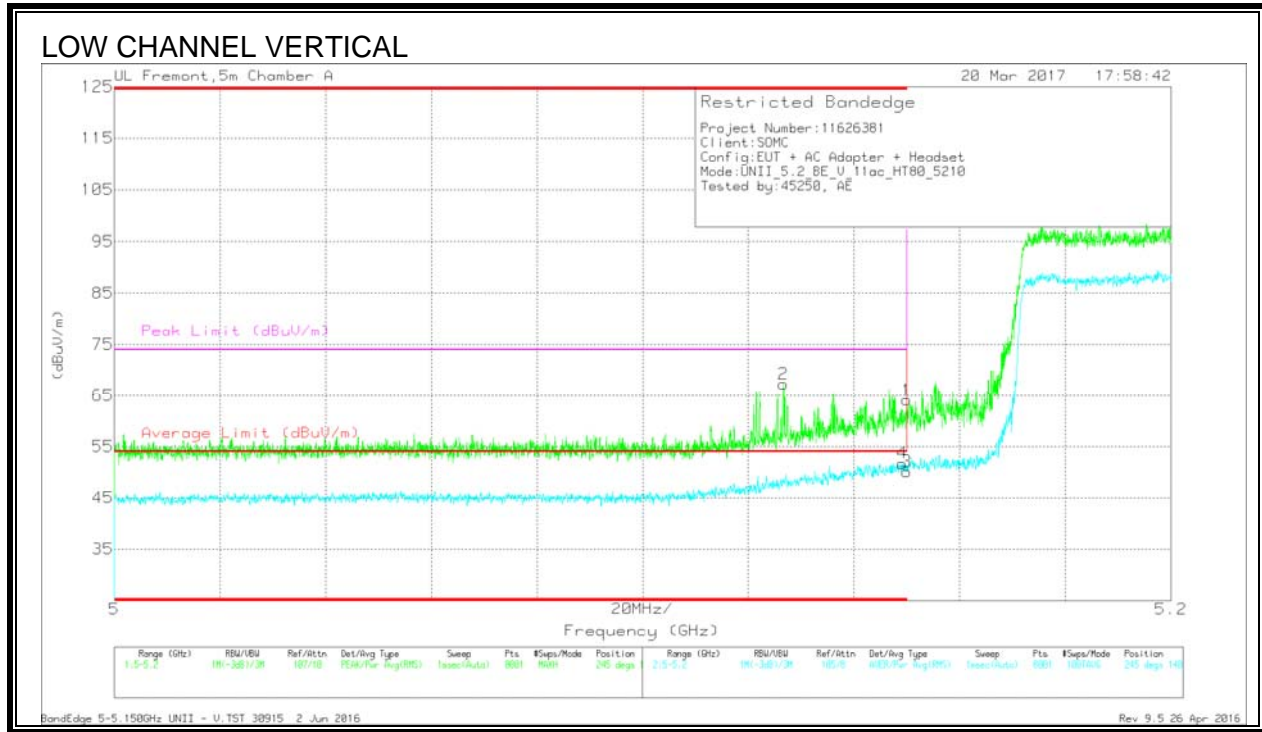

Trace Markers

Marker	Frequency (GHz)	Meter Reading (dBuV)	Det	AFT711 (dB/m)	Amp/Cb/Filt/Pad (dB)	DC Corr (dB)	Corrected Reading (dBuV/m)	Average Limit (dBuV/m)	Margin (dB)	Peak Limit (dBuV/m)	PK Margin (dB)	Azimuth (Degs)	Height (cm)	Polarity
2	* 5.127	51.81	Pk	34.1	-18.6	0	67.31	-	-	74	-6.69	245	140	V
4	* 5.149	35.81	RMS	34.1	-18.6	.42	51.73	54	-2.27	-	-	245	140	V
1	5.15	48.71	Pk	34.1	-18.7	0	64.11	-	-	74	-9.89	245	140	V
3	5.15	34.28	RMS	34.1	-18.7	.42	50.1	54	-3.9	-	-	245	140	V

* - indicates frequency in CFR15.205/IC8.10 RSS-Restricted Band

Pk - Peak detector

RMS - RMS detection

HARMONICS AND SPURIOUS EMISSIONS

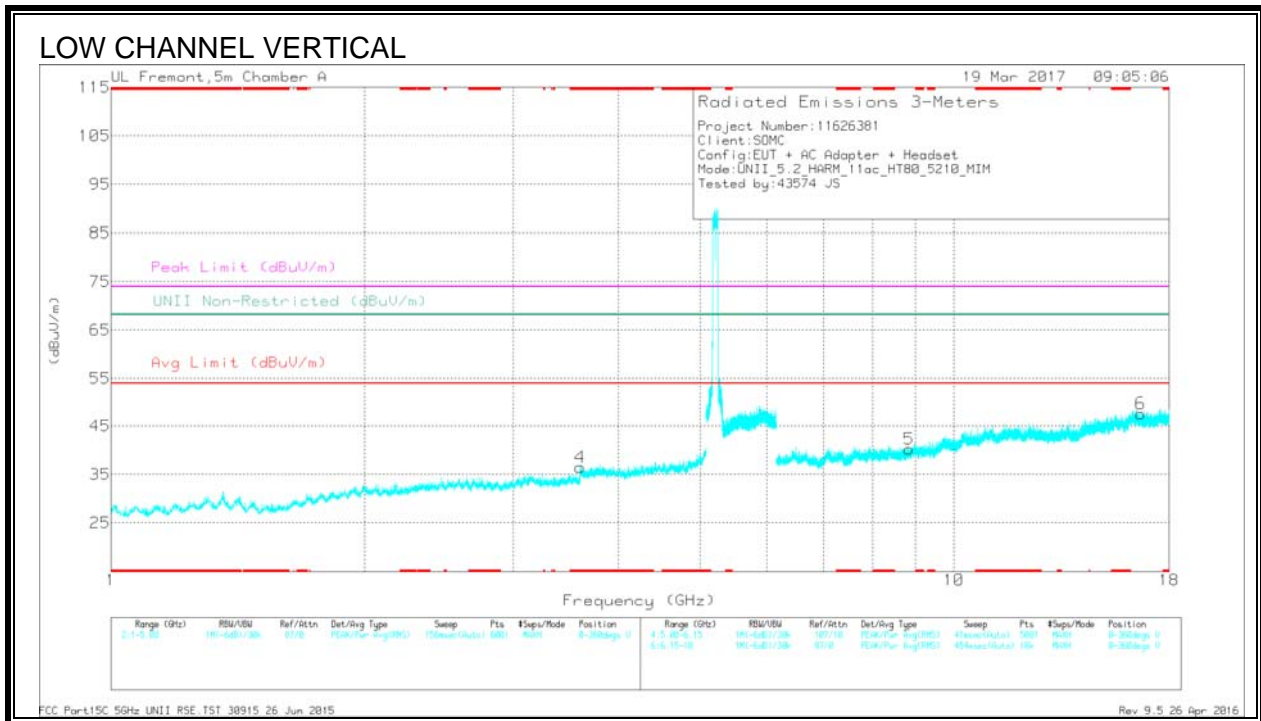
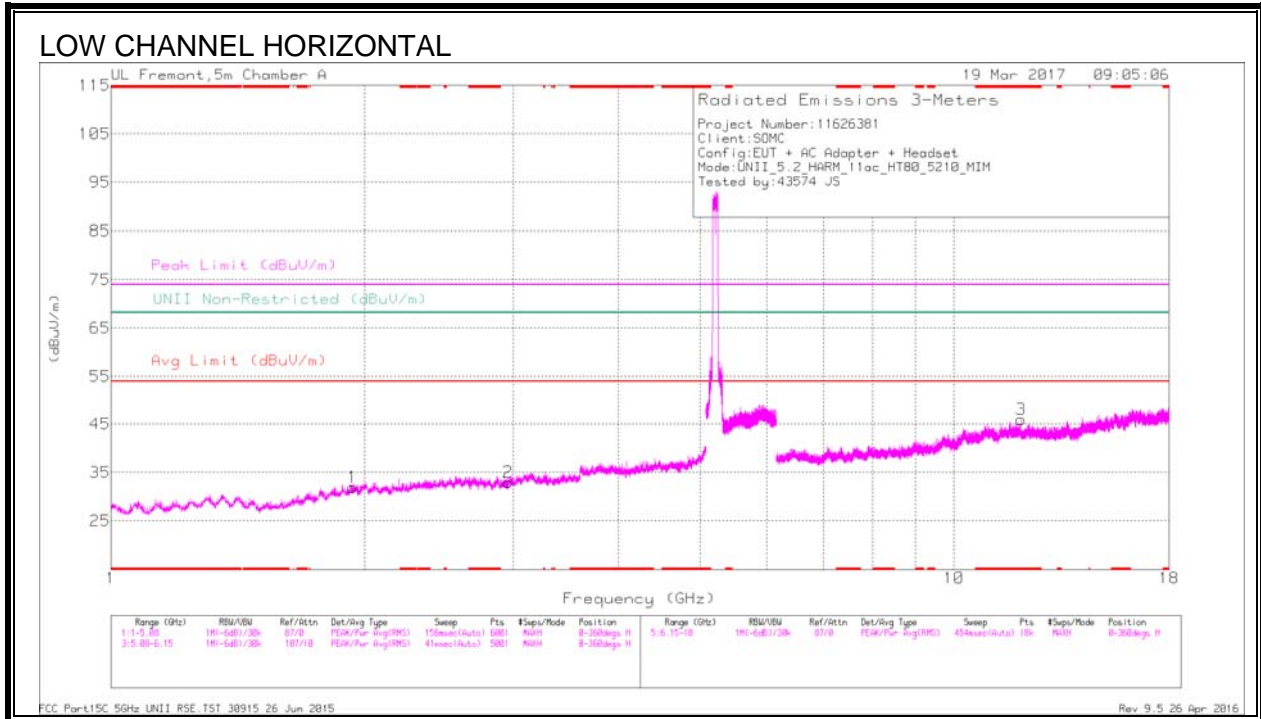

Trace Markers

Marker	Frequency (GHz)	Meter Reading (dBuV)	Det	AF 1711 (dB/m)	Amp/CM/FTz/Psd (dB)	DC Corr (dB)	Corrected Reading (dBuV/m)	Aug Limit (dBuV/m)	Margin (dB)	Peak Limit (dBuV/m)	PK Margin (dB)	UNII Non-Restricted (dBuV/m)	PK Margin (dB)	Asimuth (Degs)	Height (cm)	Polarity
4	* 3.602	34.23	Pk	33.1	-30.8	0	36.53	-	-	74	-37.47	-	-	0-360	199	V
3	* 12.008	27.44	Pk	38.6	-20.1	0	45.94	-	-	74	-28.06	-	-	0-360	199	H
1	1.936	33.88	Pk	31.4	-33.3	0	31.98	-	-	-	-	68.2	-36.22	0-360	101	H
2	2.96	32.51	Pk	32.4	-31.9	0	33.01	-	-	-	-	68.2	-35.19	0-360	101	H
5	8.85	27.52	Pk	35.9	-23.2	0	40.22	-	-	-	-	68.2	-27.98	0-360	101	V
6	16.654	25.38	Pk	41.7	-19.5	0	47.58	-	-	-	-	68.2	-20.62	0-360	199	V

* - indicates frequency in CFR15.205/IC8.10 RSS-Restricted Band
 Pk - Peak detector

Radiated Emissions

Frequency (GHz)	Meter Reading (dBuV)	Det	AF 1711 (dB/m)	Amp/CM/FTz/Psd (dB)	DC Corr (dB)	Corrected Reading (dBuV/m)	Aug Limit (dBuV/m)	Margin (dB)	Peak Limit (dBuV/m)	PK Margin (dB)	UNII Non-Restricted (dBuV/m)	PK Margin (dB)	Asimuth (Degs)	Height (cm)	Polarity
* 3.603	38.77	PK-U	33.1	-30.8	0	41.07	-	-	74	-32.93	-	-	290	241	V
* 3.601	28.8	ADR	33.1	-30.8	42	31.52	54	-22.48	-	-	-	-	290	241	V
* 12.008	32.38	PK-U	38.6	-20.1	0	50.88	-	-	74	-23.12	-	-	181	235	H
* 12.008	20.69	ADR	38.6	-20.1	42	39.61	54	-14.39	-	-	-	-	181	235	H
1.937	40.57	PK-U	31.4	-33.3	0	38.67	-	-	-	-	68.2	-29.53	325	181	H
1.937	29.55	ADR	31.4	-33.3	42	28.07	-	-	-	-	-	-	325	181	H
2.959	38.98	PK-U	32.4	-31.9	0	39.48	-	-	-	-	68.2	-28.72	233	194	H
2.961	28.53	ADR	32.4	-31.9	42	29.45	-	-	-	-	-	-	233	194	H
8.849	34.29	PK-U	35.9	-23.2	0	46.99	-	-	-	-	68.2	-21.21	277	205	V
8.849	22.84	ADR	35.9	-23.2	42	35.96	-	-	-	-	-	-	277	205	V
16.653	31.94	PK-U	41.7	-19.6	0	54.04	-	-	-	-	68.2	-14.16	332	251	V
16.656	20.29	ADR	41.7	-19.5	42	42.91	-	-	-	-	-	-	332	251	V

* - indicates frequency in CFR15.205/IC8.10 RSS-Restricted Band
 PK-U - U-NII: Maximum Peak
 ADR - U-NII AD primary method, RMS average

10.1.5. 11a 2TX CDD MIMO MODE IN THE 5.3GHZ BAND

AUTHORIZED BANDEDGE (HIGH CHANNEL)

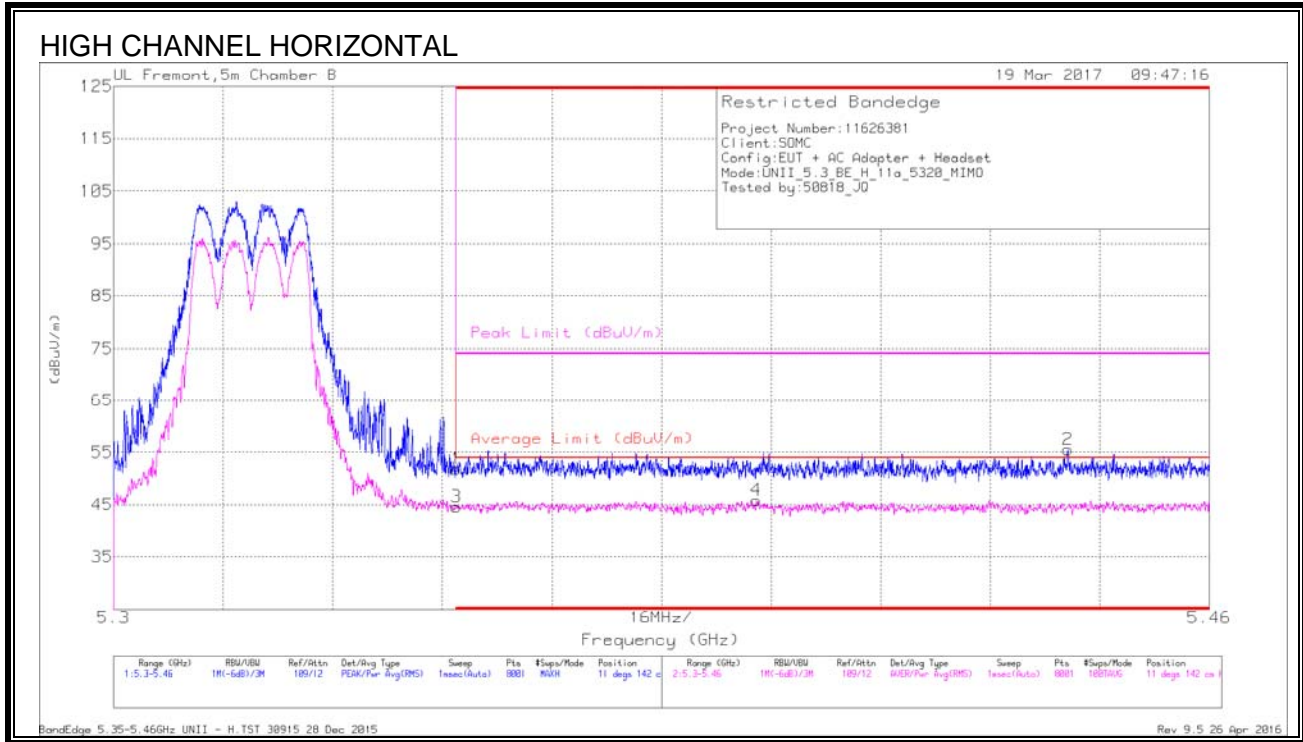

Trace Markers

Marker	Frequency (GHz)	Meter Reading (dBuV)	Det	AF T345 (dB/m)	Amp/Chl/Filt/Pad (dB)	DC Corr (dB)	Corrected Reading (dBuV/m)	Average Limit (dBuV/m)	Margin (dB)	Peak Limit (dBuV/m)	PK Margin (dB)	Azimuth (Degs)	Height (cm)	Polarity
1	* 5.35	36.06	Pk	34.5	-18.8	0	51.76	-	-	74	-22.24	11	142	H
3	* 5.35	28.62	RMS	34.5	-18.8	-24	44.56	54	-9.44	-	-	11	142	H
4	* 5.394	29.63	RMS	34.5	-18.5	-24	45.87	54	-8.13	-	-	11	142	H
2	* 5.439	40.01	Pk	34.5	-19	0	55.51	-	-	74	-18.49	11	142	H

* - indicates frequency in CFR15.205/IC8.10 RSS-Restricted Band

Pk - Peak detector

RMS - RMS detection

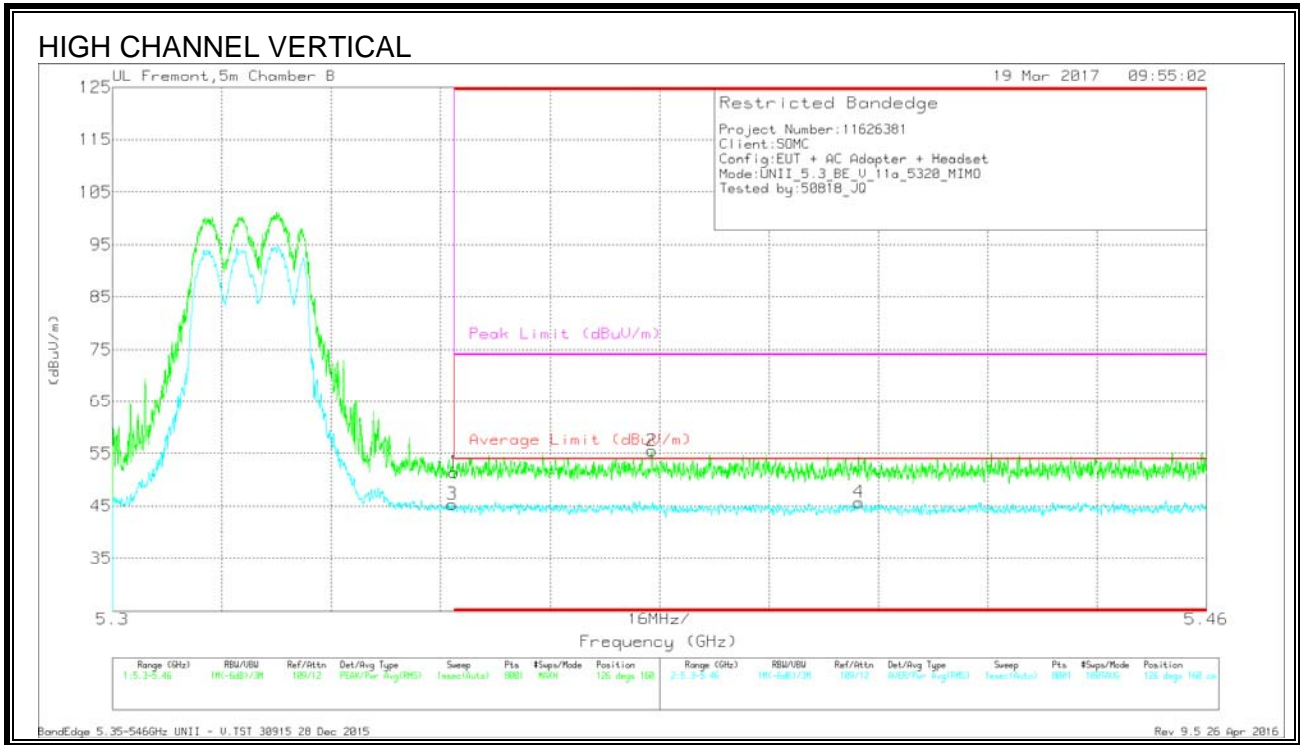

Trace Markers

Marker	Frequency (GHz)	Meter Reading (dBuV)	Det	AF T345 (dB/m)	Amp/Cbl/Rtr/Pad (dB)	DC Corr (dB)	Corrected Reading (dBuV/m)	Average Limit (dBuV/m)	Margin (dB)	Peak Limit (dBuV/m)	PK Margin (dB)	Azimuth (Degs)	Height (cm)	Polarity
2	* 5.379	39.37	Pk	34.5	-18.4	0	55.47	-	-	74	-18.53	126	160	V
4	* 5.409	29.65	RMS	34.5	-18.7	-24	45.69	54	-8.31	-	-	126	160	V
1	5.35	35.75	Pk	34.5	-18.8	0	51.45	-	-	74	-22.55	126	160	V
3	5.35	29.34	RMS	34.5	-18.8	-24	45.28	54	-9.72	-	-	126	160	V

* - indicates frequency in CFR15.205/IC8.10 RSS-Restricted Band

Pk - Peak detector

RMS - RMS detection

HARMONICS AND SPURIOUS EMISSIONS

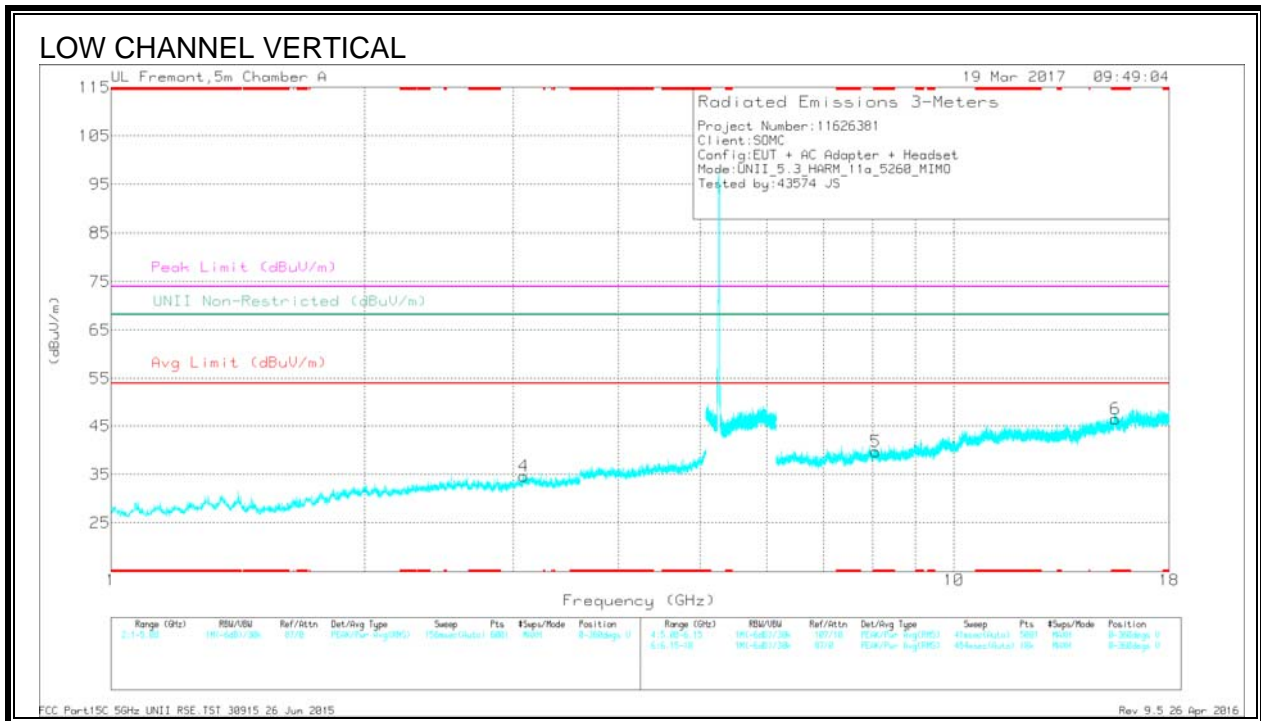
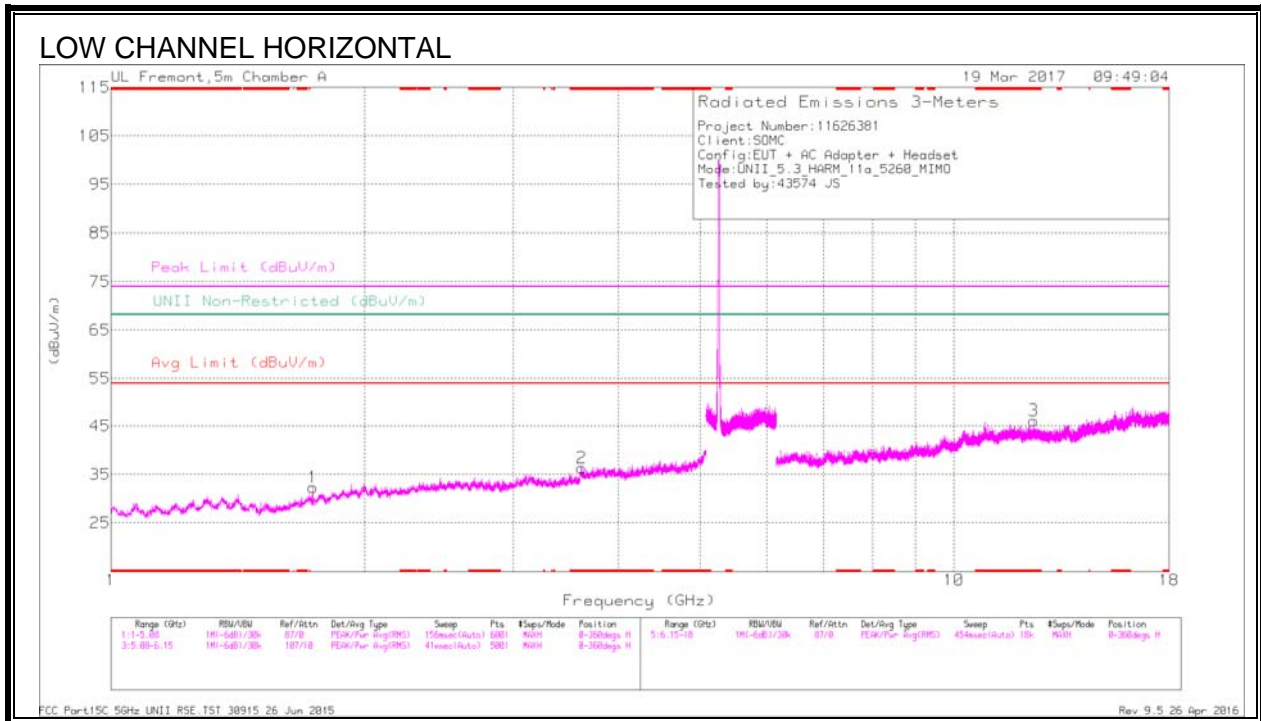

Trace Markers

Marker	Frequency (GHz)	Meter Reading (dBuV)	Det	AF 1711 (dB/m)	Amp/CM/FTz/Psd (dB)	DC Corr (dB)	Corrected Reading (dBuV/m)	Aug Limit (dBuV/m)	Margin (dB)	Peak Limit (dBuV/m)	PK Margin (dB)	UNII Non-Restricted (dBuV/m)	PK Margin (dB)	Asimuth (Degs)	Height (cm)	Polarity
2	* 3.62	33.99	Pk	33.1	-30.7	0	36.39	-	-	74	-37.61	-	-	0-360	101	H
3	* 12.428	27.45	Pk	38.9	-20.2	0	46.15	-	-	74	-27.85	-	-	0-360	199	H
5	* 8.077	27.67	Pk	35.6	-23.6	0	39.67	-	-	74	-34.33	-	-	0-360	101	V
6	* 15.545	25.29	Pk	40.3	-19.1	0	46.49	-	-	74	-27.51	-	-	0-360	199	V
1	1.736	35.64	Pk	29.6	-32.9	0	32.34	-	-	-	-	68.2	-35.86	0-360	101	H
4	3.086	32.72	Pk	32.9	-30.9	0	34.72	-	-	-	-	68.2	-33.48	0-360	101	V

* - indicates frequency in CFR15.205/IC8.10 RSS-Restricted Band
 Pk - Peak detector

Radiated Emissions

Frequency (GHz)	Meter Reading (dBuV)	Det	AF 1711 (dB/m)	Amp/CM/FTz/Psd (dB)	DC Corr (dB)	Corrected Reading (dBuV/m)	Aug Limit (dBuV/m)	Margin (dB)	Peak Limit (dBuV/m)	PK Margin (dB)	UNII Non-Restricted (dBuV/m)	PK Margin (dB)	Asimuth (Degs)	Height (cm)	Polarity
* 3.621	38.3	PK-U	33.1	-30.7	0	40.7	-	-	74	-33.3	-	-	195	177	H
* 3.619	28.35	ADR	33.1	-30.7	24	30.99	54	-23.01	-	-	-	-	195	177	H
* 12.429	31.48	PK-U	38.9	-20.2	0	50.18	-	-	74	-23.82	-	-	181	256	H
* 12.427	21	ADR	38.9	-20.2	24	39.94	54	-14.06	-	-	-	-	181	256	H
* 8.079	34.03	PK-U	35.6	-23.6	0	46.03	-	-	74	-27.97	-	-	223	148	V
* 8.078	23.18	ADR	35.6	-23.6	24	35.42	54	-18.58	-	-	-	-	223	148	V
* 15.547	32.11	PK-U	40.3	-19.1	0	53.31	-	-	74	-20.69	-	-	179	161	V
* 15.546	20.53	ADR	40.3	-19.1	24	41.97	54	-12.03	-	-	-	-	179	161	V
1.735	29.06	ADR	29.6	-33	24	25.9	-	-	-	-	-	-	257	194	H
1.737	39.78	PK-U	29.6	-32.9	0	36.48	-	-	-	-	68.2	-31.72	257	194	H
3.084	38.66	PK-U	32.9	-30.9	0	40.66	-	-	-	-	68.2	-27.54	263	214	V
3.085	27.88	ADR	32.9	-30.9	24	30.12	-	-	-	-	-	-	263	214	V

* - indicates frequency in CFR15.205/IC8.10 RSS-Restricted Band
 PK-U - U-NII: Maximum Peak
 ADR - U-NII AD primary method, RMS average