



FCC RADIO TEST REPORT

FCC ID : PY7-53953L
Equipment : GSM/WCDMA/LTE/5G Phone with BT, DTS/UNII a/b/g/n/ac/ax, GPS and NFC
Brand Name : Sony
Applicant : Sony Corporation
1-7-1 Konan Minato-ku Tokyo, 108-0075 Japan
Manufacturer : Sony Corporation
1-7-1 Konan Minato-ku Tokyo, 108-0075 Japan
Standard : FCC 47 CFR Part 2, 22(H), 24(E), 27(L)

The product was received on May 04, 2021 and testing was started from May 28, 2021 and completed on Jun. 06, 2021. We, Sporton International Inc. EMC & Wireless Communications Laboratory, would like to declare that the tested sample has been evaluated in accordance with the test procedures given in ANSI / TIA-603-E and has been in compliance with the applicable technical standards.

The test results in this report apply exclusively to the tested model / sample. Without written approval of Sporton International Inc. EMC & Wireless Communications Laboratory, the test report shall not be reproduced except in full.

Louis Wu

Approved by: Louis Wu

Sporton International Inc. EMC & Wireless Communications Laboratory

No. 52, Huaya 1st Rd., Guishan Dist., Taoyuan City 333, Taiwan (R.O.C.)



Table of Contents

History of this test report.....3

Summary of Test Result.....4

1 General Description5

 1.1 Product Feature of Equipment Under Test5

 1.2 Modification of EUT5

 1.3 Maximum ERP/EIRP Power, Frequency Tolerance, and Emission Designator6

 1.4 Testing Location6

 1.5 Applicable Standards7

2 Test Configuration of Equipment Under Test8

 2.1 Test Mode.....8

 2.2 Connection Diagram of Test System9

 2.3 Support Unit used in test configuration9

 2.4 Measurement Results Explanation Example9

 2.5 Frequency List of Low/Middle/High Channels10

3 Conducted Test Result11

 3.1 Measuring Instruments.....11

 3.2 Conducted Output Power and ERP/EIRP12

 3.3 Peak-to-Average Ratio13

 3.4 99% Occupied Bandwidth and 26dB Bandwidth Measurement.....14

 3.5 Conducted Band Edge15

 3.6 Conducted Spurious Emission16

 3.7 Frequency Stability.....17

4 Radiated Test Items18

 4.1 Measuring Instruments.....18

 4.2 Test Setup18

 4.3 Test Result of Radiated Test.....19

 4.4 Field Strength of Spurious Radiation Measurement20

5 List of Measuring Equipment.....21

6 Uncertainty of Evaluation23

Appendix A. Test Results of Conducted Test

Appendix B. Test Results of Radiated Test



Summary of Test Result

Report Clause	Ref Std. Clause	Test Items	Result (PASS/FAIL)	Remark
3.2	§2.1046	Conducted Output Power	Pass	-
	§22.913 (a)(5)	Effective Radiated Power (GSM850)		
	§24.232 (c)	Equivalent Isotropic Radiated Power (GSM1900) (WCDMA Band II)		
	§27.50 (d)(4)	Equivalent Isotropic Radiated Power (WCDMA Band IV)		
3.3	§24.232 (d)	Peak-to-Average Ratio	Pass	
3.4	§2.1049 §22.917 (b) §24.238 (b) §27.53 (g)	Occupied Bandwidth (GSM850) (GSM1900)(WCDMA Band II) (WCDMA Band IV)	Pass	-
3.5	§2.1051 §22.917 (a) §24.238 (a) §27.53 (g)	Band Edge Measurement (GSM850) (GSM1900)(WCDMA Band II) (WCDMA Band IV)	Pass	-
3.6	§2.1051 §22.917 (a) §24.238 (a) §27.53 (g)	Conducted Emission (GSM850) (GSM1900)(WCDMA Band II) (WCDMA Band IV)	Pass	-
3.7	§2.1055 §22.355 §24.235 §27.54	Frequency Stability Temperature & Voltage	Pass	-
4.4	§2.1053 §22.917 (a) §24.238 (a) §27.53 (h)	Field Strength of Spurious Radiation (GSM850) (GSM1900)(WCDMA Band II) (WCDMA Band IV)	Pass	Under limit 21.45 dB at 2472.000 MHz

Declaration of Conformity:
The test results with all measurement uncertainty excluded are presented in accordance with the regulation limits or requirements declared by manufacturers.
Comments and Explanations:
The declared of product specification for EUT presented in the report are provided by the manufacturer, and the manufacturer takes all the responsibilities for the accuracy of product specification.

Reviewed by: Keven Cheng

Report Producer: Celery Wei



1 General Description

1.1 Product Feature of Equipment Under Test

GSM/WCDMA/LTE, Bluetooth, DTS/UNII a/b/g/n/ac/ax, NFC, FM Receiver, and GNSS.

Product Specification subjective to this standard	
Antenna Type	Loop Antenna
Antenna Gain	Cellular Band: -4.5 dBi PCS Band: 0.8 dBi AWS Band: -0.7 dBi

Remark: The above EUT's information was declared by manufacturer. Please refer to Comments and Explanations in report summary.

EUT Information List			
HW Version	SW Version	S/N	Performed Test Item
A	2.33	QV7200CP7P	Conducted Measurement
	2.33	QV7200CM7P	Radiated Spurious Emission
	2.33	QV7200CP7P	ERP/EIRP Test

Accessory List	
AC Adapter	Model Name : AC-0540-JP
	S/N: 0020W51300039
USB Cable	Model Name.: XQZ-UB1
	S/N : N/A
Earphone	Model Name.: STH40D
	S/N : N/A

Note:

1. Above EUT list used are electrically identical per declared by manufacturer.
2. Above the accessories list are used to exercise the EUT during test, and the serial number of each type of accessories is listed in each section of this report.
3. For other wireless features of this EUT, test report will be issued separately.

1.2 Modification of EUT

No modifications are made to the EUT during all test items.



1.3 Maximum ERP/EIRP Power, Frequency Tolerance, and Emission Designator

FCC Rule	Frequency Range (MHz)	System	Type of Modulation	Maximum ERP/EIRP (W)	Frequency Tolerance (ppm)	Emission Designator
Part 22	824.2~848.8	GSM850 GPRS class 8	GMSK	0.4093	0.0143 ppm	246KGXW
Part 22	824.2~848.8	GSM850 EDGE class 8	8PSK	0.1132	0.0167 ppm	248KG7W
Part 24	1850.2~1909.8	GSM1900 GPRS class 8	GMSK	0.5808	0.0085 ppm	246KGXW
Part 24	1850.2~1909.8	GSM1900 EDGE class 8	8PSK	0.4645	0.0117 ppm	250KG7W
Part 24	1852.4~1907.6	WCDMA Band II RMC 12.2Kbps	QPSK	0.0942	0.0106 ppm	4M15F9W
Part 27	1712.4~1752.6	WCDMA Band IV RMC 12.2Kbps	QPSK	0.0652	0.0254 ppm	4M15F9W

1.4 Testing Location

Test Site	Sporton International Inc. EMC & Wireless Communications Laboratory
Test Site Location	No.52, Huaya 1st Rd., Guishan Dist., Taoyuan City 333, Taiwan (R.O.C.) TEL: +886-3-327-3456 FAX: +886-3-328-4978
Test Site No.	Sporton Site No. TH03-HY
Test Engineer	Oscar Chi
Temperature	21~24°C
Relative Humidity	51~55%

Test Site	Sporton International Inc. Wensan Laboratory
Test Site Location	No.58, Aly. 75, Ln. 564, Wenhua 3rd, Rd., Guishan Dist., Taoyuan City 333010, Taiwan (R.O.C.) TEL: +886-3-327-0868 FAX: +886-3-327-0855
Test Site No.	Sporton Site No. 03CH15-HY (TAF Code: 3786)
Test Engineer	Leo Lee, Mancy Chou and Bigshow Wang
Temperature	22.3~24.2%
Relative Humidity	46~56°C
Remark	The Radiated Spurious Emission Test item subcontracted to Sporton International Inc. Wensan Laboratory

Note: The test site complies with ANSI C63.4 2014 requirement.

FCC Designation No.: TW1190 and TW3786



1.5 Applicable Standards

According to the specifications of the manufacturer, the EUT must comply with the requirements of the following standards:

- ♦ ANSI C63.26-2015
- ♦ ANSI / TIA-603-E
- ♦ FCC 47 CFR Part 2, 22(H), 24(E), 27(L)
- ♦ FCC KDB 971168 D01 Power Meas. License Digital Systems v03r01
- ♦ FCC KDB 412172 D01 Determining ERP and EIRP v01r01
- ♦ FCC KDB 414788 D01 Radiated Test Site v01r01

Remark:

1. All test items were verified and recorded according to the standards and without any deviation during the test.
2. This EUT has also been tested and complied with the requirements of FCC Part 15, Subpart B, recorded in a separate test report.
3. The TAF code is not including all the FCC KDB listed without accreditation.



2 Test Configuration of Equipment Under Test

2.1 Test Mode

Antenna port conducted and radiated test items were performed according to KDB 971168 D01 Power Meas. License Digital Systems v03r01 with maximum output power.

For radiated measurement, pre-scanned in three orthogonal panels, X, Y, Z. The worst cases (Y Plane for Cellular Band and PCS Band, X Plane for AWS Band) were recorded in this report.

Radiated emissions were investigated as following frequency range:

1. 30 MHz to 9000 MHz for GSM850
2. 30 MHz to 18000 MHz for WCDMA Band IV
3. 30 MHz to 19100 MHz for GSM1900 and WCDMA Band II

All modes, data rates and positions were investigated.

Test modes are chosen to be reported as the worst case configuration below:

Test Modes		
Band	Radiated TCs	Conducted TCs
GSM850	<ul style="list-style-type: none">■ GPRS Class 8 Link■ EDGE Class 8 Link	<ul style="list-style-type: none">■ GPRS Class 8 Link■ EDGE Class 8 Link
GSM1900	<ul style="list-style-type: none">■ GPRS Class 8 Link■ EDGE Class 8 Link	<ul style="list-style-type: none">■ GPRS Class 8 Link■ EDGE Class 8 Link
WCDMA Band II	<ul style="list-style-type: none">■ RMC 12.2Kbps Link	<ul style="list-style-type: none">■ RMC 12.2Kbps Link
WCDMA Band IV	<ul style="list-style-type: none">■ RMC 12.2Kbps Link	<ul style="list-style-type: none">■ RMC 12.2Kbps Link

Remark: We have evaluated simultaneous transmissions modes and determined no new significant emissions are observed.

2.2 Connection Diagram of Test System

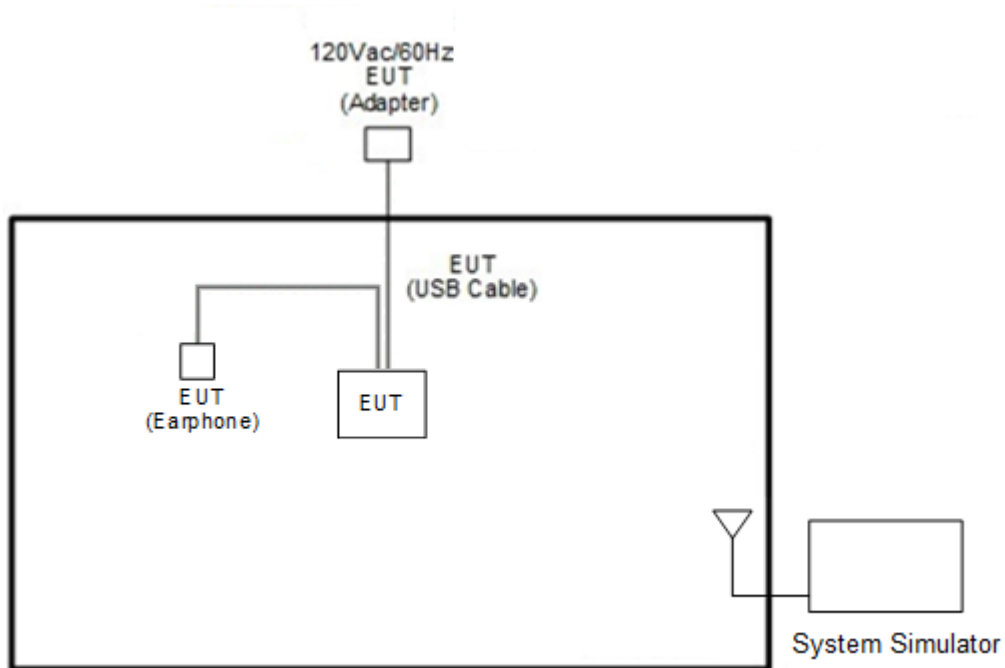

2.3 Support Unit used in test configuration

Item	Equipment	Brand Name	Model No.	FCC ID	Data Cable	Power Cord
1.	System Simulator	Anritsu	MT8820C	N/A	N/A	Unshielded, 1.8 m

2.4 Measurement Results Explanation Example

For all conducted test items:

The offset level is set in the spectrum analyzer to compensate the RF cable loss and attenuator factor between RF conducted output port and spectrum analyzer. With the offset compensation, the spectrum analyzer reading level will be exactly the RF output level.

The spectrum analyzer offset is derived from RF cable loss and attenuator factor.

Offset = RF cable loss + attenuator factor.

The following shows an offset computation example with RF cable loss 4.2 dB and a 10 dB attenuator.

Example:

$$\begin{aligned} \text{Offset(dB)} &= \text{RF cable loss(dB)} + \text{attenuator factor(dB)}. \\ &= 4.2 + 10 = 14.2 \text{ (dB)} \end{aligned}$$



2.5 Frequency List of Low/Middle/High Channels

Frequency List				
Band	Channel/Frequency(MHz)	Lowest	Middle	Highest
GSM850	Channel	128	189	251
	Frequency	824.2	836.4	848.8
GSM1900	Channel	512	661	810
	Frequency	1850.2	1880.0	1909.8
WCDMA Band II	Channel	9262	9400	9538
	Frequency	1852.4	1880.0	1907.6
WCDMA Band IV	Channel	1312	1413	1513
	Frequency	1712.4	1732.6	1752.6

3 Conducted Test Result

3.1 Measuring Instruments

See list of measuring instruments of this test report.

3.1.1 Test Setup

3.1.2 Conducted Output Power

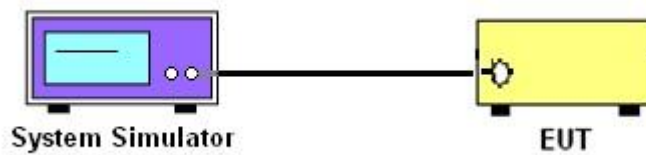

3.1.3 Peak-to-Average Ratio, Occupied Bandwidth, Conducted Band-Edge and Conducted Spurious Emission

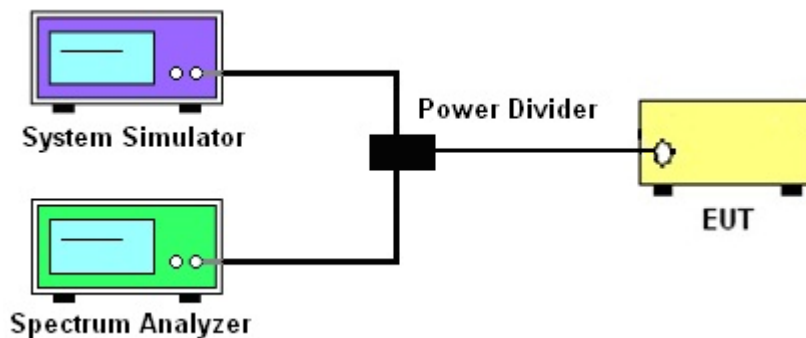

3.1.4 Frequency Stability

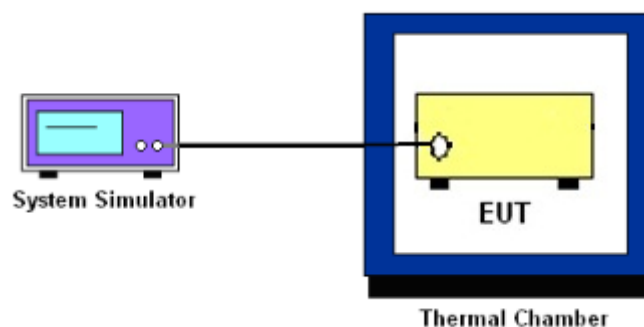

3.1.5 Test Result of Conducted Test

Please refer to Appendix A.



3.2 Conducted Output Power and ERP/EIRP

3.2.1 Description of the Conducted Output Power and ERP/EIRP

A system simulator was used to establish communication with the EUT. Its parameters were set to enforce EUT transmitting at the maximum power. The measured power in the radio frequency on the transmitter output terminals shall be reported.

The ERP of mobile transmitters must not exceed 7 Watts for GSM850

The EIRP of mobile transmitters must not exceed 2 Watts for GSM1900 and WCDMA Band II

The EIRP of mobile transmitters must not exceed 1 Watts for WCDMA Band IV

According to KDB 412172 D01 Power Approach,

$EIRP = P_T + G_T - L_C$, $ERP = EIRP - 2.15$, where

P_T = transmitter output power in dBm

G_T = gain of the transmitting antenna in dBi

L_C = signal attenuation in the connecting cable between the transmitter and antenna in dB

3.2.2 Test Procedures

1. The transmitter output port was connected to the system simulator.
2. Set EUT at maximum power through system simulator.
3. Select the lowest, middle, and the highest channels for each band and different modulation.
4. Measure the maximum burst average power for GSM and maximum average power for other modulation signal.



3.3 Peak-to-Average Ratio

3.3.1 Description of the PAR Measurement

The peak-to-average ratio (PAR) of the transmission may not exceed 13 dB.

3.3.2 Test Procedures

The testing follows ANSI C63.26-2015 Section 5.2.6

1. The EUT was connected to spectrum analyzer and system simulator via a power divider.
2. Set EUT to transmit at maximum output power.
3. When the duty cycle is less than 98%, then signal gating will be implemented on the spectrum analyzer by triggering from the system simulator.
4. Set the CCDF (Complementary Cumulative Distribution Function) option of the spectrum analyzer.
5. Record the maximum PAPR level associated with a probability of 0.1%.



3.4 99% Occupied Bandwidth and 26dB Bandwidth Measurement

3.4.1 Description of 99% Occupied Bandwidth and 26dB Bandwidth Measurement

The occupied bandwidth is the width of a frequency band such that, below the lower and above the upper frequency limits, the mean powers emitted are each equal to a specified percentage 0.5% of the total mean transmitted power.

The 26 dB emission bandwidth is defined as the frequency range between two points, one above and one below the carrier frequency, at which the spectral density of the emission is attenuated 26 dB below the maximum in-band spectral density of the modulated signal. Spectral density (power per unit bandwidth) is to be measured with a detector of resolution bandwidth equal to approximately 1.0% of the emission bandwidth.

3.4.2 Test Procedures

The testing follows ANSI C63.26-2015 Section 5.4.3 (26dB) and Section 5.4.4 (99OB)

1. The EUT was connected to spectrum analyzer and system simulator via a power divider.
2. The spectrum analyzer center frequency is set to the nominal EUT channel center frequency. The span range for the spectrum analyzer shall be between two and five times the anticipated OBW.
3. The nominal resolution bandwidth (RBW) shall be in the range of 1 to 5 % of the anticipated OBW, and the VBW shall be at least 3 times the RBW.
4. Set the detection mode to peak, and the trace mode to max hold.
5. Determine the reference value: Set the EUT to transmit a modulated signal. Allow the trace to stabilize. Set the spectrum analyzer marker to the highest level of the displayed trace.
(This is the reference value)
6. Determine the “-26 dB down amplitude” as equal to (Reference Value – X).
7. Place two markers, one at the lowest and the other at the highest frequency of the envelope of the spectral display such that each marker is at or slightly below the “-X dB down amplitude” determined in step 6. If a marker is below this “-X dB down amplitude” value it shall be placed as close as possible to this value. The OBW is the positive frequency difference between the two markers.
8. Use the 99 % power bandwidth function of the spectrum analyzer and report the measured bandwidth.



3.5 Conducted Band Edge

3.5.1 Description of Conducted Band Edge Measurement

The power of any emission outside of the authorized operating frequency ranges must be lower than the transmitter power (P) by a factor of at least $43 + 10 \log (P)$ dB.

3.5.2 Test Procedures

The testing follows FCC KDB 971168 D01 v03r01 Section 6.1.

1. The EUT was connected to the spectrum analyzer and system simulator via a power divider.
2. The RF output of EUT was connected to the spectrum analyzer by an RF cable and attenuator. The path loss was compensated to the results for each measurement.
3. The band edges of low and high channels for the highest RF powers were measured.
4. The RF fundamental frequency should be excluded against the limit line in the operating frequency band.
5. The limit line is derived from $43 + 10\log(P)$ dB below the transmitter power P(Watts)



3.6 Conducted Spurious Emission

3.6.1 Description of Conducted Spurious Emission Measurement

The power of any emission outside of the authorized operating frequency ranges must be lower than the transmitter power (P) by a factor of at least $43 + 10 \log (P)$ dB.

It is measured by means of a calibrated spectrum analyzer and scanned from 30 MHz up to a frequency including its 10th harmonic.

3.6.2 Test Procedures

The testing follows FCC KDB 971168 D01 v03r01 Section 6.1.

1. The EUT was connected to the spectrum analyzer and system simulator via a power divider.
2. The RF output of EUT was connected to the spectrum analyzer by an RF cable and attenuator. The path loss was compensated to the results for each measurement.
3. The middle channel for the highest RF power within the transmitting frequency was measured.
4. The conducted spurious emission for the whole frequency range was taken.
5. The RF fundamental frequency should be excluded against the limit line in the operating frequency band.
6. The limit line is derived from $43 + 10\log(P)$ dB below the transmitter power P(Watts)



3.7 Frequency Stability

3.7.1 Description of Frequency Stability Measurement

22.355

The frequency stability shall be measured by variation of ambient temperature and variation of primary supply voltage to ensure that the fundamental emission stays within the authorized frequency block. The frequency stability of the transmitter shall be maintained within $\pm 0.00025\%$ ($\pm 2.5\text{ppm}$) of the center frequency.

24.235 & 27.54

The frequency stability shall be sufficient to ensure that the fundamental emission stays within the authorized frequency block.

3.7.2 Test Procedures for Temperature Variation

The testing follows FCC KDB 971168 D01 v03r01 Section 9.0.

1. The EUT was set up in the thermal chamber and connected with the system simulator.
2. With power OFF, the temperature was decreased to -30°C and the EUT was stabilized before testing. Power was applied and the maximum change in frequency was recorded within one minute.
3. With power OFF, the temperature was raised in 10°C steps up to 50°C . The EUT was stabilized at each step for at least half an hour. Power was applied and the maximum frequency change was recorded within one minute.

3.7.3 Test Procedures for Voltage Variation

The testing follows FCC KDB 971168 D01 v03r01 Section 9.0.

1. The EUT was placed in a temperature chamber at $20\pm 5^{\circ}\text{C}$ and connected with the system simulator.
2. The power supply voltage to the EUT was varied from 85% to 115% of the nominal value measured at the input to the EUT.
3. The variation in frequency was measured for the worst case.

4 Radiated Test Items

4.1 Measuring Instruments

See list of measuring instruments of this test report.

4.2 Test Setup

For radiated test below 30MHz

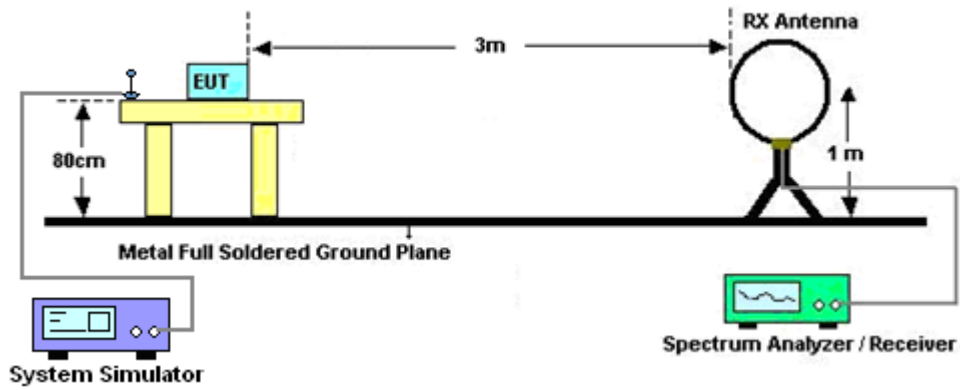

For radiated test from 30MHz to 1GHz

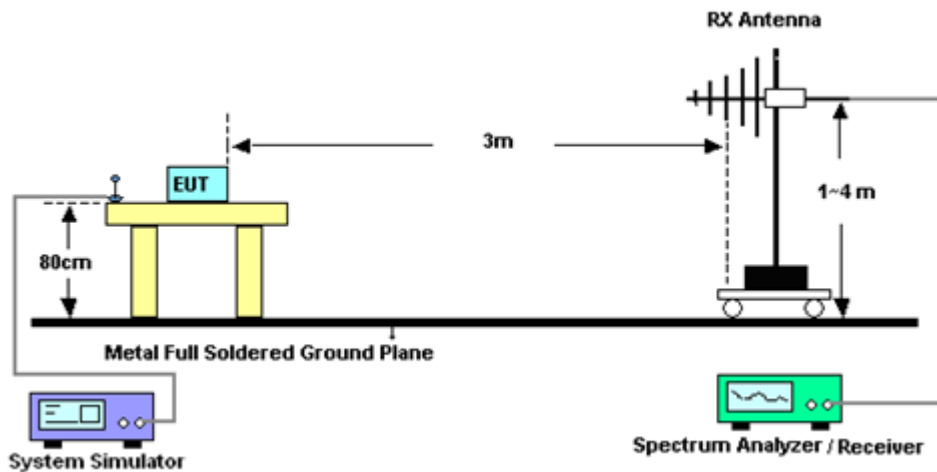

For radiated test from 1GHz to 18GHz

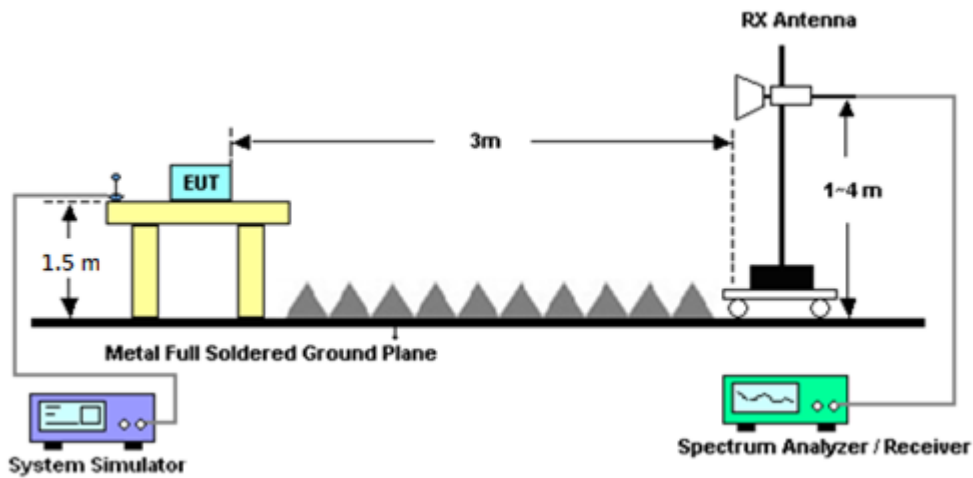

For radiated test above 18GHz

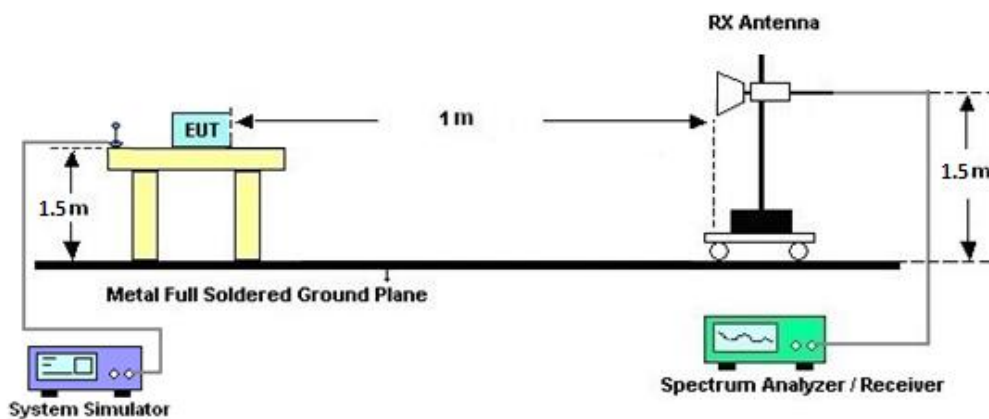

4.3 Test Result of Radiated Test

Please refer to Appendix B.

Note:

The low frequency, which started from 9 kHz to 30 MHz, was pre-scanned and the result which was 20 dB lower than the limit line was not reported.

There is adequate comparison measurement of both open-field test site and alternative test site - semi-Anechoic chamber according to 414788 D01 Radiated Test Site v01r01, and the result came out very similar.



4.4 Field Strength of Spurious Radiation Measurement

4.4.1 Description of Field Strength of Spurious Radiated Measurement

The power of any emission outside of the authorized operating frequency ranges must be attenuated below the transmitter power (P) by a factor of at least $43 + 10 \log (P)$ dB. The spectrum is scanned from 30 MHz up to a frequency including its 10th harmonic.

4.4.2 Test Procedures

The testing follows FCC KDB 971168 D01 v03r01 Section 7 and ANSI / TIA-603-E Section 2.2.12.

1. The EUT was placed on a rotatable wooden table 0.8 meters for frequency below 1 GHz and 1.5 meter for frequency above 1 GHz above the ground.
2. The EUT was set 3 meters from the receiving antenna, which was mounted on the antenna tower.
3. The table was rotated 360 degrees to determine the position of the highest spurious emission.
4. The height of the receiving antenna is varied between one meter and four meters to search for the maximum spurious emission for both horizontal and vertical polarizations.
5. Make the measurement with the spectrum analyzer's RBW = 1 MHz, VBW = 3 MHz, taking record of maximum spurious emission.
6. A horn antenna was substituted in place of the EUT and was driven by a signal generator.
7. Tune the output power of signal generator to the same emission level with EUT maximum spurious emission.
8. Take the record of output power at antenna port.
9. Repeat step 7 to step 8 for another polarization.
10. $EIRP \text{ (dBm)} = S.G. \text{ Power} - Tx \text{ Cable Loss} + Tx \text{ Antenna Gain}$
11. $ERP \text{ (dBm)} = EIRP - 2.15$
12. The RF fundamental frequency should be excluded against the limit line in the operating frequency band.
13. The limit line is derived from $43 + 10\log(P)$ dB below the transmitter power P(Watts)



5 List of Measuring Equipment

Instrument	Brand Name	Model No.	Serial No.	Characteristics	Calibration Date	Test Date	Due Date	Remark
Bilog Antenna	TESEQ	CBL 6111D & 00800N1D01N-06	37059 & 01	30MHz~1GHz	Oct. 11, 2020	Jun. 05, 2021~ Jun. 06, 2021	Oct. 10, 2021	Radiation (03CH15-HY)
Bilog Antenna	TESEQ	CBL6111D&00800N1D01N-06	41912&05	30MHz to 1GHz	Feb. 08, 2021	Jun. 05, 2021~ Jun. 06, 2021	Feb. 07, 2022	Radiation (03CH15-HY)
Amplifier	SONOMA	310N	363440	9kHz~1GHz	Dec. 28, 2020	Jun. 05, 2021~ Jun. 06, 2021	Dec. 27, 2021	Radiation (03CH15-HY)
Horn Antenna	SCHWARZBECK	BBHA 9120 D	9120D-02114	1-18GHz	Aug. 04, 2020	Jun. 05, 2021~ Jun. 06, 2021	Aug. 03, 2021	Radiation (03CH15-HY)
Horn Antenna	SCHWARZBECK	BBHA 9120 D	9120D-1326	1GHz~18GHz	Nov. 03, 2020	Jun. 05, 2021~ Jun. 06, 2021	Nov. 02, 2021	Radiation (03CH15-HY)
SHF-EHF Horn Antenna	SCHWARZBECK	BBHA 9170	BBHA9170251	18GHz- 40GHz	Dec. 02, 2020	Jun. 05, 2021~ Jun. 06, 2021	Dec. 01, 2021	Radiation (03CH15-HY)
SHF-EHF Horn Antenna	SCHWARZBECK	BBHA 9170	BBHA9170576	18GHz~40GHz	May 22, 2020	Jun. 05, 2021~ Jun. 06, 2021	May 21, 2021	Radiation (03CH15-HY)
Preamplifier	Jet-Power	JPA0118-55-303	1710001800055006	1GHz~18GHz	May 06, 2021	Jun. 05, 2021~ Jun. 06, 2021	May 05, 2022	Radiation (03CH15-HY)
Preamplifier	Keysight	83017A	MY53270195	1GHz~26.5GHz	Aug. 21, 2020	Jun. 05, 2021~ Jun. 06, 2021	Aug. 20, 2021	Radiation (03CH15-HY)
Preamplifier	EMEC	EM18G40G	060801	18GHz ~ 40GHz	Jun. 15, 2020	Jun. 05, 2021~ Jun. 06, 2021	Jun. 14, 2021	Radiation (03CH15-HY)
Spectrum Analyzer	Keysight	N9038A	MY54130085	20MHz~8.4GHz	Nov. 02, 2020	Jun. 05, 2021~ Jun. 06, 2021	Nov. 01, 2021	Radiation (03CH15-HY)
Spectrum Analyzer	Keysight	N9010A	MY54200485	10Hz~44GHz	Mar. 05, 2021	Jun. 05, 2021~ Jun. 06, 2021	Mar. 04, 2022	Radiation (03CH15-HY)
Antenna Mast	ChainTek	MBS-520-1	N/A	1m~4m	N/A	Jun. 05, 2021~ Jun. 06, 2021	N/A	Radiation (03CH15-HY)
Turn Table	ChainTek	T-200-S-1	N/A	0~360 Degree	N/A	Jun. 05, 2021~ Jun. 06, 2021	N/A	Radiation (03CH15-HY)
Software	Audix	E3 6.2009-8-24(k5)	RK-000451	N/A	N/A	Jun. 05, 2021~ Jun. 06, 2021	N/A	Radiation (03CH15-HY)
RF Cable	HUBER + SUHNER	SUCOFLEX 104, 102E	MY36980/4, MY9838/4PE, 508405/2E	30MHz~18G	Nov. 16, 2020	Jun. 05, 2021~ Jun. 06, 2021	Nov. 15, 2021	Radiation (03CH15-HY)
RF Cable	HUBER + SUHNER	SUCOFLEX 102	505134/2	30MHz-40GHz	Feb. 22, 2021	Jun. 05, 2021~ Jun. 06, 2021	Feb. 21, 2022	Radiation (03CH15-HY)
RF Cable	HUBER + SUHNER	SUCOFLEX 102	800740/2	30MHz-40GHz	Feb. 22, 2021	Jun. 05, 2021~ Jun. 06, 2021	Feb. 21, 2022	Radiation (03CH15-HY)
RF Cable	HUBER + SUHNER	SUCOFLEX 104	MY9837/4PE	9kHz~30MHz	Mar. 11, 2021	Jun. 05, 2021~ Jun. 06, 2021	Mar. 10, 2022	Radiation (03CH15-HY)
Filter	Wainwright	WLK4-1000-1530-8000-40SS	SN4	1.53G Low Pass	Jul. 03, 2020	Jun. 05, 2021~ Jun. 06, 2021	Jul. 02, 2021	Radiation (03CH15-HY)
Filter	Wainwright	WHKX12-1080-1200-15000-60ST	SN5	1.2GHz High Pass Filter	Jul. 01, 2020	Jun. 05, 2021~ Jun. 06, 2021	Jun. 30, 2021	Radiation (03CH15-HY)
Filter	Wainwright	WHKX12-2700-3000-18000-60ST	SN4	3GHz High Pass Filter	Sep. 16, 2020	Jun. 05, 2021~ Jun. 06, 2021	Sep. 15, 2021	Radiation (03CH15-HY)
Signal Generator	Anritsu	MG3694C	163401	0.1Hz~40GHz	Jan. 31, 2021	Jun. 05, 2021~ Jun. 06, 2021	Jan. 30, 2022	Radiation (03CH15-HY)



Instrument	Brand Name	Model No.	Serial No.	Characteristics	Calibration Date	Test Date	Due Date	Remark
Hygrometer	Testo	608-H1	34893241	N/A	Mar. 03, 2021	May 28, 2021	Mar. 02, 2022	Conducted (TH03-HY)
Spectrum Analyzer	Rohde & Schwarz	FSP30	101329	9kHz~30GHz	Sep. 03, 2020	May 28, 2021	Sep. 02, 2021	Conducted (TH03-HY)
Temperature Chamber	ESPEC	SH-641	92013720	-40°C ~90°C	Sep. 14, 2020	May 28, 2021	Sep. 13, 2021	Conducted (TH03-HY)
Programmable Power Supply	GW Instek	PSS-2005	EL890001	1V~20V 0.5A~4A	Oct. 05, 2020	May 28, 2021	Oct. 04, 2021	Conducted (TH03-HY)
Base Station (Measure)	Rohde & Schwarz	CMU200	117995	GSM / GPRS / WCDMA / CDMA	Sep. 07, 2020	May 28, 2021	Sep. 06, 2021	Conducted (TH03-HY)
Power Divider	Warison	WCOU-0.4-26. 5S-20	#A	N/A	Nov. 03, 2020	May 28, 2021	Nov. 02, 2021	Conducted (TH03-HY)



6 Uncertainty of Evaluation

Uncertainty of Radiated Emission Measurement (30 MHz ~ 1000 MHz)

Measuring Uncertainty for a Level of Confidence of 95% ($U = 2Uc(y)$)	2.98 dB
---	---------

Uncertainty of Radiated Emission Measurement (1 GHz ~ 18 GHz)

Measuring Uncertainty for a Level of Confidence of 95% ($U = 2Uc(y)$)	3.31 dB
---	---------

Uncertainty of Radiated Emission Measurement (18 GHz ~ 40 GHz)

Measuring Uncertainty for a Level of Confidence of 95% ($U = 2Uc(y)$)	3.92 dB
---	---------



Appendix A. Test Results of Conducted Test

Conducted Output Power(Average power) & ERP / EIRP

GSM850 Maximum Average Power [dBm] (GT - LC = -4.5 dB)					
Channel	128	189	251	ERP (dBm)	ERP (W)
Frequency	824.2	836.4	848.8		
GSM	32.31	32.71	32.45	26.12	0.4093
GPRS class 8	32.35	32.77	32.50		
GPRS class 10	29.32	29.42	29.46		
GPRS class 11	27.57	27.51	27.65		
GPRS class 12	26.28	26.46	26.40		
EGPRS class 8	27.19	26.78	26.70	20.54	0.1132
EGPRS class 10	23.99	23.78	23.56		
EGPRS class 11	22.25	21.87	21.92		
EGPRS class 12	20.84	20.71	20.35		
Limit	ERP < 7W			Result	Pass

GSM1900 Maximum Average Power [dBm] (GT - LC = 0.8 dB)					
Channel	512	661	810	EIRP (dBm)	EIRP (W)
Frequency	1850.2	1880	1909.8		
GSM	26.45	26.70	26.79	27.64	0.5808
GPRS class 8	26.48	26.74	26.84		
GPRS class 10	23.61	23.82	23.81		
GPRS class 11	21.58	21.75	21.72		
GPRS class 12	20.59	20.63	20.88		
EGPRS class 8	25.87	25.82	25.72	26.67	0.4645
EGPRS class 10	22.79	22.63	22.49		
EGPRS class 11	20.96	20.70	20.65		
EGPRS class 12	19.61	19.38	19.00		
Limit	EIRP < 2W			Result	Pass



WCDMA Band II Maximum Average Power [dBm] (GT - LC = 0.8 dB)							
Channel	9262	9400	9538	EIRP (dBm)	EIRP (W)		
Frequency	1852.4	1880	1907.6				
RMC 12.2K	18.83	18.94	18.85	19.74	0.0942		
HSDPA Subtest-1	17.79	17.89	17.83				
HSDPA Subtest-2	17.79	17.86	17.83				
HSDPA Subtest-3	17.27	17.38	17.33				
HSDPA Subtest-4	17.28	17.38	17.33				
HSUPA Subtest-1	17.20	17.84	17.80				
HSUPA Subtest-2	15.65	15.82	15.74				
HSUPA Subtest-3	16.69	16.83	16.78				
HSUPA Subtest-4	15.68	15.84	15.79				
HSUPA Subtest-5	17.70	17.80	17.80				
Limit	EIRP < 2W					Result	Pass

WCDMA Band IV Maximum Average Power [dBm] (GT - LC = -0.7 dB)							
Channel	1312	1413	1513	EIRP (dBm)	EIRP (W)		
Frequency	1712.4	1732.6	1752.6				
RMC 12.2K	18.84	18.69	18.78	18.14	0.0652		
HSDPA Subtest-1	17.75	17.67	17.72				
HSDPA Subtest-2	17.72	17.68	17.75				
HSDPA Subtest-3	17.25	17.19	17.24				
HSDPA Subtest-4	17.27	17.19	17.24				
HSUPA Subtest-1	17.68	17.55	17.69				
HSUPA Subtest-2	15.66	15.59	15.68				
HSUPA Subtest-3	16.65	16.59	16.62				
HSUPA Subtest-4	15.70	15.58	15.63				
HSUPA Subtest-5	17.70	17.60	17.70				
Limit	EIRP < 1W					Result	Pass



A1. GSM

Peak-to-Average Ratio

Mode	GSM850		Limit: 13dB
Mod.	GPRS class 8	EDGE class 8	Result
Lowest CH	0.32	3.20	PASS
Middle CH	0.32	3.48	
Highest CH	0.32	3.36	

Mode	GSM1900		Limit: 13dB
Mod.	GPRS class 8	EDGE class 8	Result
Lowest CH	0.44	3.28	PASS
Middle CH	0.40	3.32	
Highest CH	0.40	3.24	

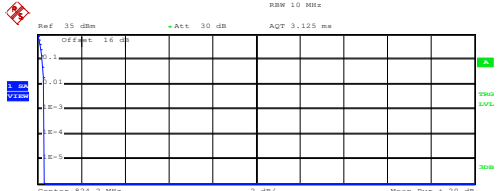
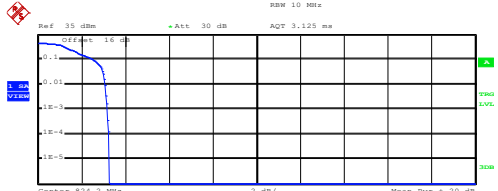
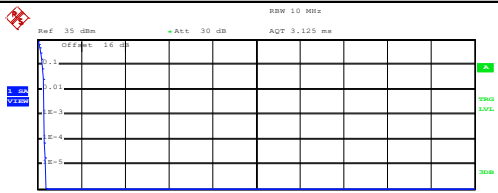
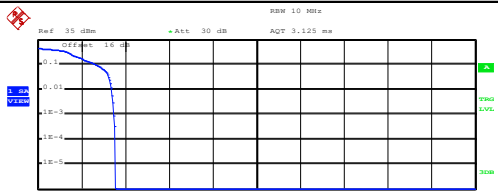
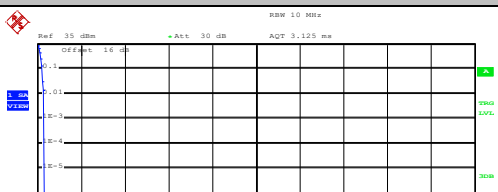
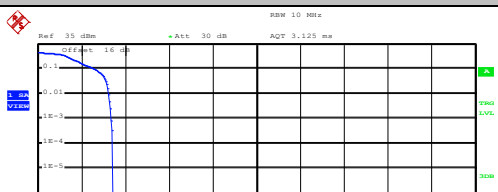

GSM850 (GPRS class 8)	GSM850 (EDGE class 8)
<p align="center">Lowest Channel</p>  <p>Center 824.2 MHz 2 dB/ Mean Pwr + 20 dB</p> <p>Complementary Cumulative Distribution Function (100000 samples)</p> <p>Trace 1</p> <p>Mean 31.48 dBm Peak 31.79 dBm Crest 0.31 dB</p> <p>10 % 0.20 dB 1 % 0.32 dB .1 % 0.32 dB .01 % 0.32 dB</p> <p>Date: 28.MAY.2021 09:48:46</p>	<p align="center">Lowest Channel</p>  <p>Center 824.2 MHz 2 dB/ Mean Pwr + 20 dB</p> <p>Complementary Cumulative Distribution Function (100000 samples)</p> <p>Trace 1</p> <p>Mean 26.56 dBm Peak 29.82 dBm Crest 3.26 dB</p> <p>10 % 2.52 dB 1 % 3.08 dB .1 % 3.20 dB .01 % 3.24 dB</p> <p>Date: 28.MAY.2021 10:17:30</p>
<p align="center">Middle Channel</p>  <p>Center 836.4 MHz 2 dB/ Mean Pwr + 20 dB</p> <p>Complementary Cumulative Distribution Function (100000 samples)</p> <p>Trace 1</p> <p>Mean 31.49 dBm Peak 31.86 dBm Crest 0.37 dB</p> <p>10 % 0.24 dB 1 % 0.32 dB .1 % 0.32 dB .01 % 0.32 dB</p> <p>Date: 28.MAY.2021 09:49:04</p>	<p align="center">Middle Channel</p>  <p>Center 836.4 MHz 2 dB/ Mean Pwr + 20 dB</p> <p>Complementary Cumulative Distribution Function (100000 samples)</p> <p>Trace 1</p> <p>Mean 26.14 dBm Peak 29.68 dBm Crest 3.54 dB</p> <p>10 % 2.72 dB 1 % 3.36 dB .1 % 3.48 dB .01 % 3.56 dB</p> <p>Date: 28.MAY.2021 10:17:48</p>
<p align="center">Highest Channel</p>  <p>Center 848.8 MHz 2 dB/ Mean Pwr + 20 dB</p> <p>Complementary Cumulative Distribution Function (100000 samples)</p> <p>Trace 1</p> <p>Mean 31.62 dBm Peak 31.93 dBm Crest 0.31 dB</p> <p>10 % 0.20 dB 1 % 0.28 dB .1 % 0.32 dB .01 % 0.32 dB</p> <p>Date: 28.MAY.2021 09:49:21</p>	<p align="center">Highest Channel</p>  <p>Center 848.8 MHz 2 dB/ Mean Pwr + 20 dB</p> <p>Complementary Cumulative Distribution Function (100000 samples)</p> <p>Trace 1</p> <p>Mean 26.53 dBm Peak 29.96 dBm Crest 3.43 dB</p> <p>10 % 2.60 dB 1 % 3.24 dB .1 % 3.36 dB .01 % 3.44 dB</p> <p>Date: 28.MAY.2021 10:18:06</p>



GSM1900 (GPRS class 8)	GSM1900 (EDGE class 8)																												
<p align="center">Lowest Channel</p> <p>Center 1.8502 GHz 2 dB/ Mean Pwr + 20 dB</p> <p>Complementary Cumulative Distribution Function (100000 samples)</p> <p>Trace 1</p> <table border="0"> <tr><td>Mean</td><td>25.37 dBm</td></tr> <tr><td>Peak</td><td>25.87 dBm</td></tr> <tr><td>Crest</td><td>0.50 dB</td></tr> </table> <table border="0"> <tr><td>10 %</td><td>0.24 dB</td></tr> <tr><td>1 %</td><td>0.36 dB</td></tr> <tr><td>.1 %</td><td>0.44 dB</td></tr> <tr><td>.01 %</td><td>0.44 dB</td></tr> </table> <p>Date: 28.MAY.2021 10:04:14</p>	Mean	25.37 dBm	Peak	25.87 dBm	Crest	0.50 dB	10 %	0.24 dB	1 %	0.36 dB	.1 %	0.44 dB	.01 %	0.44 dB	<p align="center">Lowest Channel</p> <p>Center 1.8502 GHz 2 dB/ Mean Pwr + 20 dB</p> <p>Complementary Cumulative Distribution Function (100000 samples)</p> <p>Trace 1</p> <table border="0"> <tr><td>Mean</td><td>25.23 dBm</td></tr> <tr><td>Peak</td><td>28.62 dBm</td></tr> <tr><td>Crest</td><td>3.39 dB</td></tr> </table> <table border="0"> <tr><td>10 %</td><td>2.64 dB</td></tr> <tr><td>1 %</td><td>3.16 dB</td></tr> <tr><td>.1 %</td><td>3.28 dB</td></tr> <tr><td>.01 %</td><td>3.36 dB</td></tr> </table> <p>Date: 28.MAY.2021 10:29:33</p>	Mean	25.23 dBm	Peak	28.62 dBm	Crest	3.39 dB	10 %	2.64 dB	1 %	3.16 dB	.1 %	3.28 dB	.01 %	3.36 dB
Mean	25.37 dBm																												
Peak	25.87 dBm																												
Crest	0.50 dB																												
10 %	0.24 dB																												
1 %	0.36 dB																												
.1 %	0.44 dB																												
.01 %	0.44 dB																												
Mean	25.23 dBm																												
Peak	28.62 dBm																												
Crest	3.39 dB																												
10 %	2.64 dB																												
1 %	3.16 dB																												
.1 %	3.28 dB																												
.01 %	3.36 dB																												
<p align="center">Middle Channel</p> <p>Center 1.88 GHz 2 dB/ Mean Pwr + 20 dB</p> <p>Complementary Cumulative Distribution Function (100000 samples)</p> <p>Trace 1</p> <table border="0"> <tr><td>Mean</td><td>25.63 dBm</td></tr> <tr><td>Peak</td><td>26.08 dBm</td></tr> <tr><td>Crest</td><td>0.45 dB</td></tr> </table> <table border="0"> <tr><td>10 %</td><td>0.28 dB</td></tr> <tr><td>1 %</td><td>0.36 dB</td></tr> <tr><td>.1 %</td><td>0.40 dB</td></tr> <tr><td>.01 %</td><td>0.44 dB</td></tr> </table> <p>Date: 28.MAY.2021 10:04:33</p>	Mean	25.63 dBm	Peak	26.08 dBm	Crest	0.45 dB	10 %	0.28 dB	1 %	0.36 dB	.1 %	0.40 dB	.01 %	0.44 dB	<p align="center">Middle Channel</p> <p>Center 1.88 GHz 2 dB/ Mean Pwr + 20 dB</p> <p>Complementary Cumulative Distribution Function (100000 samples)</p> <p>Trace 1</p> <table border="0"> <tr><td>Mean</td><td>25.44 dBm</td></tr> <tr><td>Peak</td><td>28.83 dBm</td></tr> <tr><td>Crest</td><td>3.39 dB</td></tr> </table> <table border="0"> <tr><td>10 %</td><td>2.60 dB</td></tr> <tr><td>1 %</td><td>3.20 dB</td></tr> <tr><td>.1 %</td><td>3.32 dB</td></tr> <tr><td>.01 %</td><td>3.36 dB</td></tr> </table> <p>Date: 28.MAY.2021 10:29:51</p>	Mean	25.44 dBm	Peak	28.83 dBm	Crest	3.39 dB	10 %	2.60 dB	1 %	3.20 dB	.1 %	3.32 dB	.01 %	3.36 dB
Mean	25.63 dBm																												
Peak	26.08 dBm																												
Crest	0.45 dB																												
10 %	0.28 dB																												
1 %	0.36 dB																												
.1 %	0.40 dB																												
.01 %	0.44 dB																												
Mean	25.44 dBm																												
Peak	28.83 dBm																												
Crest	3.39 dB																												
10 %	2.60 dB																												
1 %	3.20 dB																												
.1 %	3.32 dB																												
.01 %	3.36 dB																												
<p align="center">Highest Channel</p> <p>Center 1.9098 GHz 2 dB/ Mean Pwr + 20 dB</p> <p>Complementary Cumulative Distribution Function (100000 samples)</p> <p>Trace 1</p> <table border="0"> <tr><td>Mean</td><td>25.56 dBm</td></tr> <tr><td>Peak</td><td>26.01 dBm</td></tr> <tr><td>Crest</td><td>0.44 dB</td></tr> </table> <table border="0"> <tr><td>10 %</td><td>0.28 dB</td></tr> <tr><td>1 %</td><td>0.36 dB</td></tr> <tr><td>.1 %</td><td>0.40 dB</td></tr> <tr><td>.01 %</td><td>0.44 dB</td></tr> </table> <p>Date: 28.MAY.2021 10:04:51</p>	Mean	25.56 dBm	Peak	26.01 dBm	Crest	0.44 dB	10 %	0.28 dB	1 %	0.36 dB	.1 %	0.40 dB	.01 %	0.44 dB	<p align="center">Highest Channel</p> <p>Center 1.9098 GHz 2 dB/ Mean Pwr + 20 dB</p> <p>Complementary Cumulative Distribution Function (100000 samples)</p> <p>Trace 1</p> <table border="0"> <tr><td>Mean</td><td>25.17 dBm</td></tr> <tr><td>Peak</td><td>28.55 dBm</td></tr> <tr><td>Crest</td><td>3.38 dB</td></tr> </table> <table border="0"> <tr><td>10 %</td><td>2.56 dB</td></tr> <tr><td>1 %</td><td>3.12 dB</td></tr> <tr><td>.1 %</td><td>3.24 dB</td></tr> <tr><td>.01 %</td><td>3.32 dB</td></tr> </table> <p>Date: 28.MAY.2021 10:30:09</p>	Mean	25.17 dBm	Peak	28.55 dBm	Crest	3.38 dB	10 %	2.56 dB	1 %	3.12 dB	.1 %	3.24 dB	.01 %	3.32 dB
Mean	25.56 dBm																												
Peak	26.01 dBm																												
Crest	0.44 dB																												
10 %	0.28 dB																												
1 %	0.36 dB																												
.1 %	0.40 dB																												
.01 %	0.44 dB																												
Mean	25.17 dBm																												
Peak	28.55 dBm																												
Crest	3.38 dB																												
10 %	2.56 dB																												
1 %	3.12 dB																												
.1 %	3.24 dB																												
.01 %	3.32 dB																												



26dB Bandwidth

Mode	GSM850: 26dB BW (MHz)	
Mod.	GPRS class 8	EDGE class 8
Lowest CH	0.303	0.302
Middle CH	0.308	0.305
Highest CH	0.302	0.311

Mode	GSM1900: 26dB BW (MHz)	
Mod.	GPRS class 8	EDGE class 8
Lowest CH	0.303	0.291
Middle CH	0.301	0.308
Highest CH	0.306	0.301

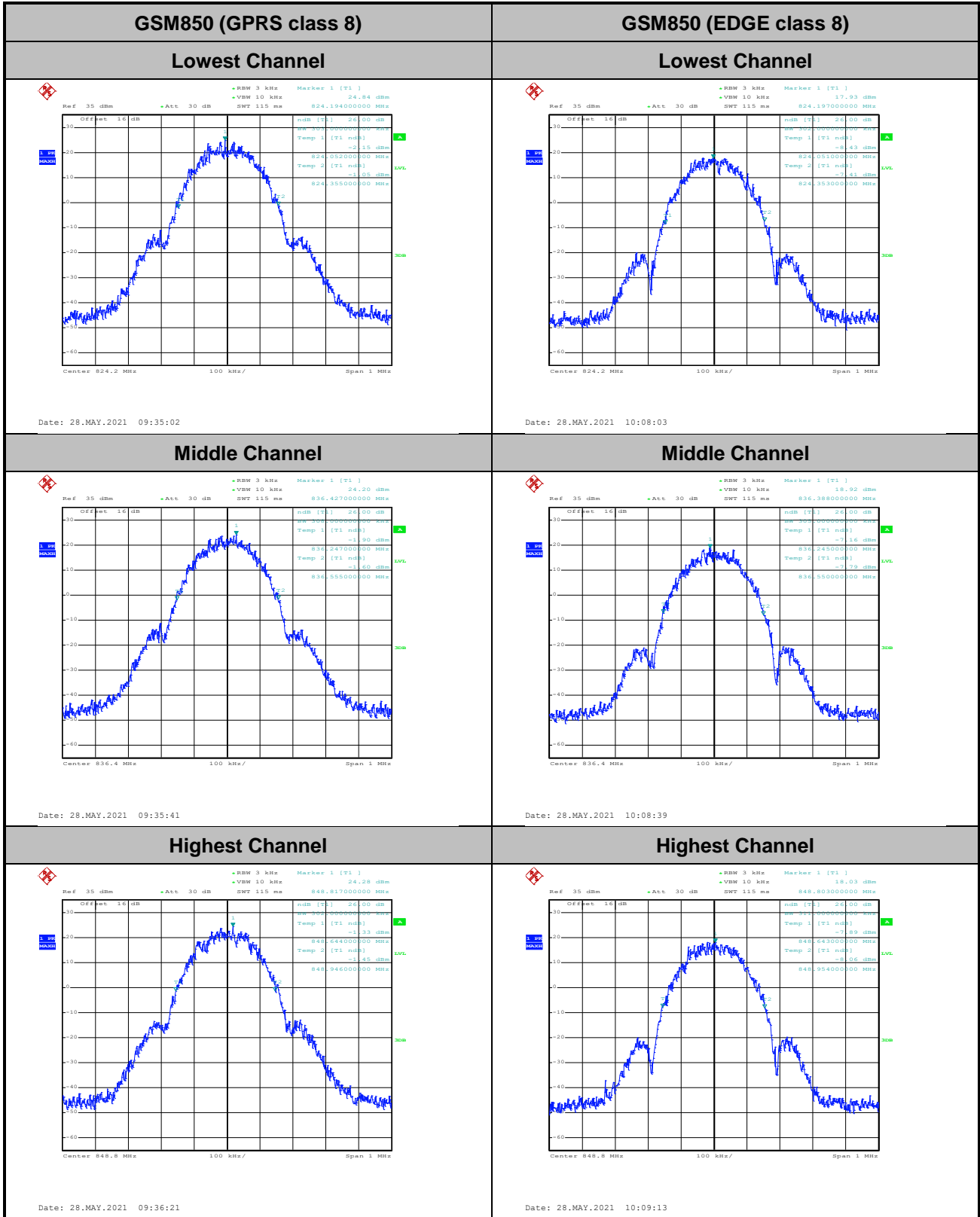

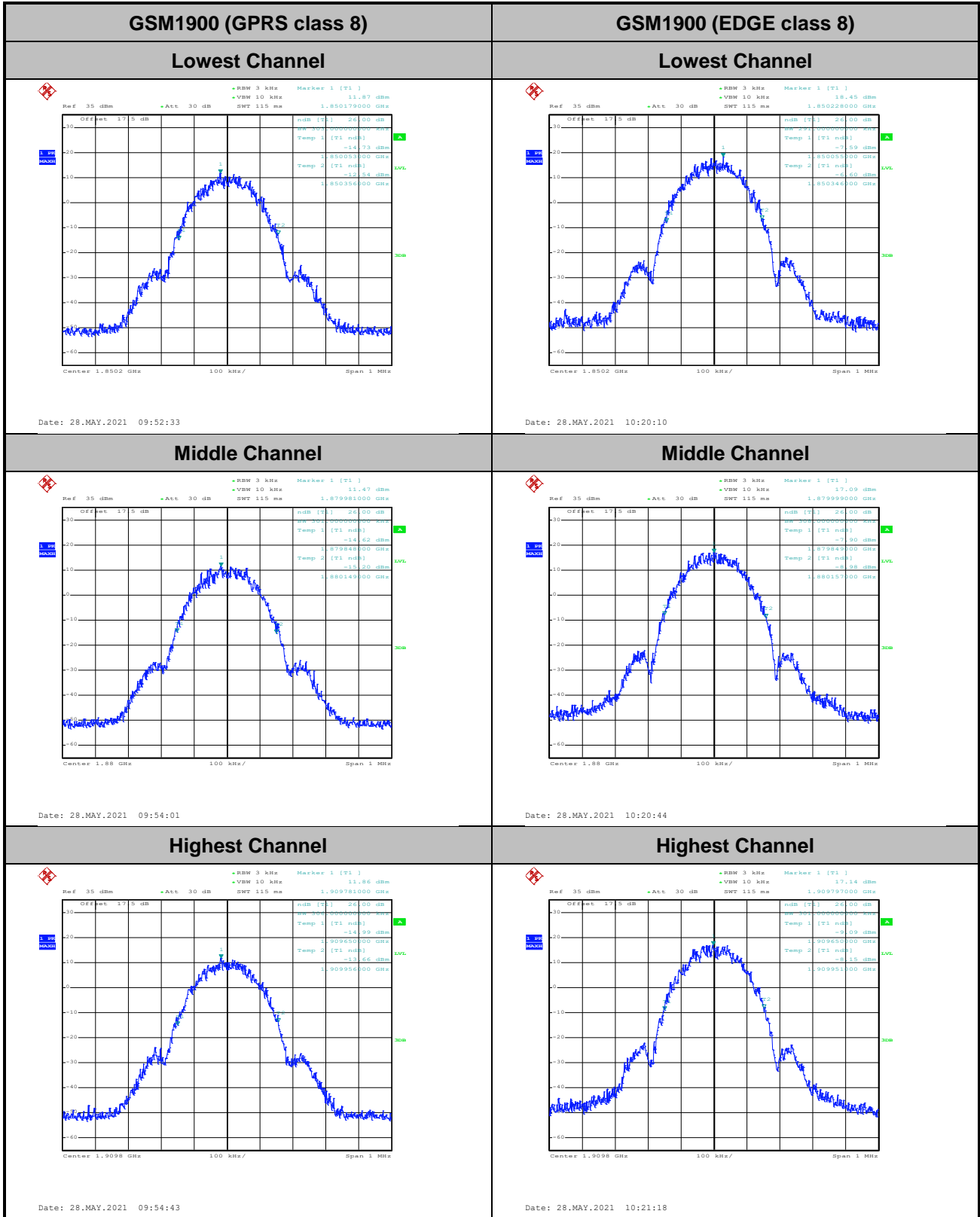



Occupied Bandwidth

Mode	GSM850: 99% BW (MHz)	
Mod.	GPRS class 8	EDGE class 8
Lowest CH	0.246	0.248
Middle CH	0.243	0.245
Highest CH	0.243	0.244

Mode	GSM1900: 99% BW (MHz)	
Mod.	GPRS class 8	EDGE class 8
Lowest CH	0.243	0.245
Middle CH	0.246	0.247
Highest CH	0.241	0.250

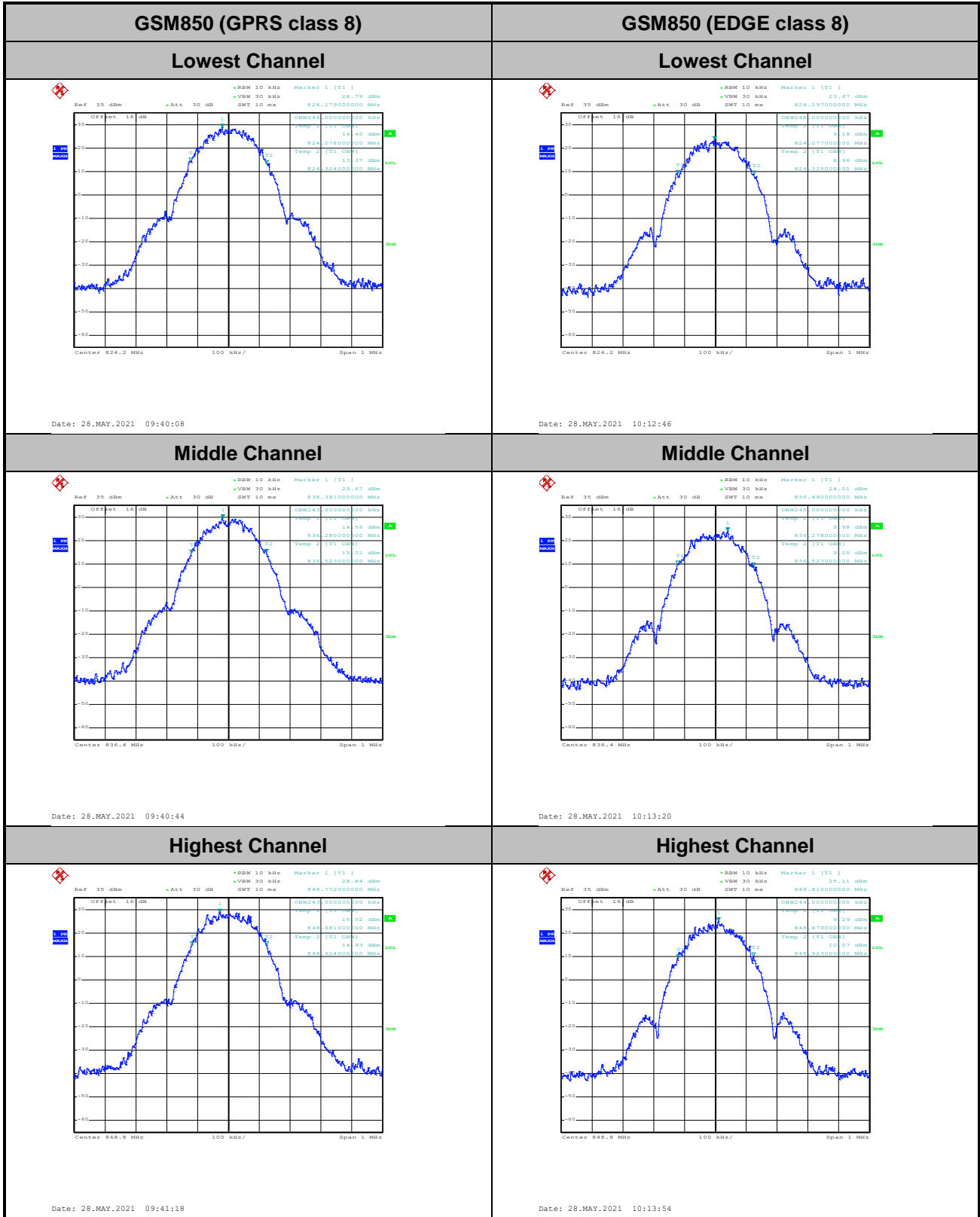

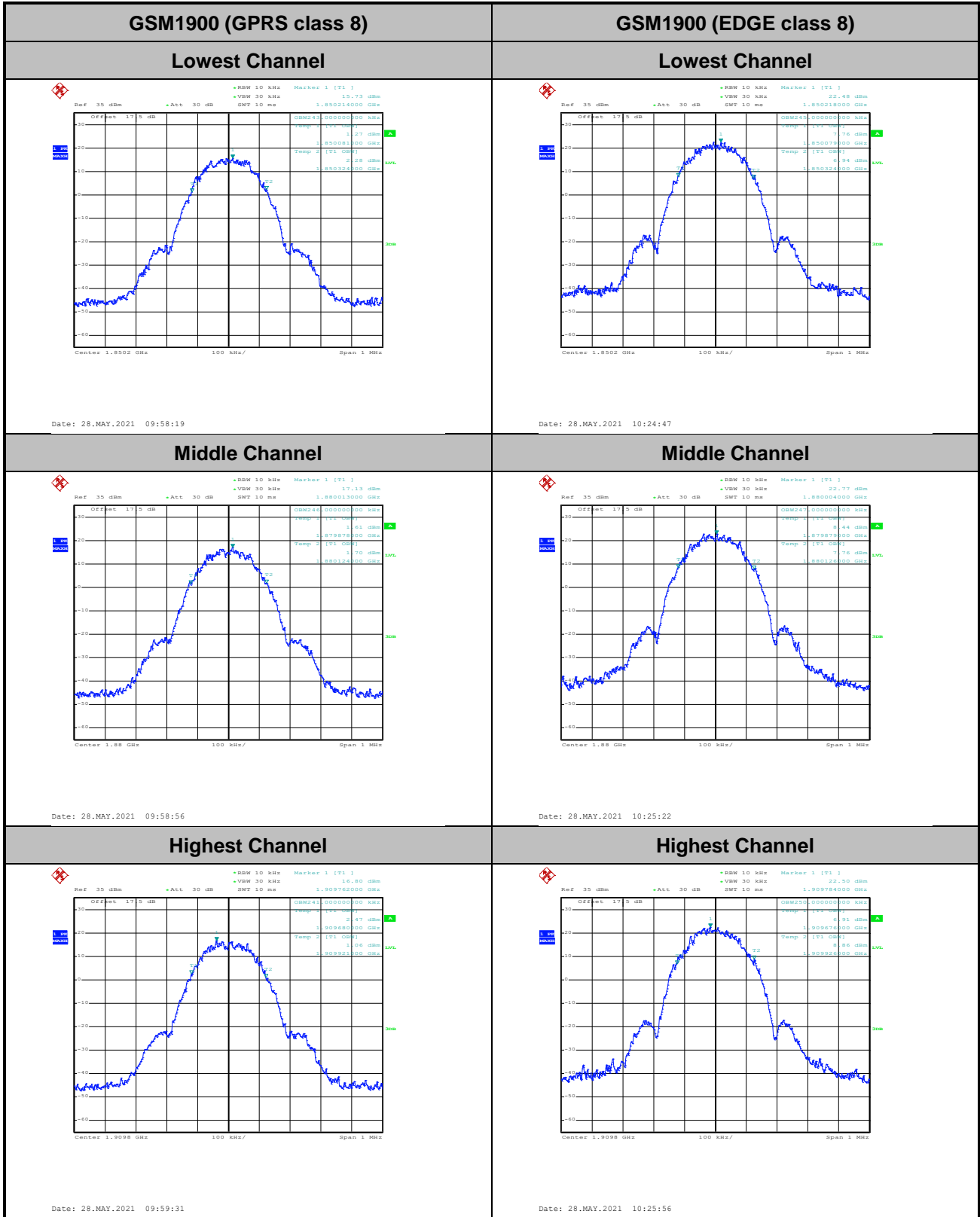



Conducted Band Edge

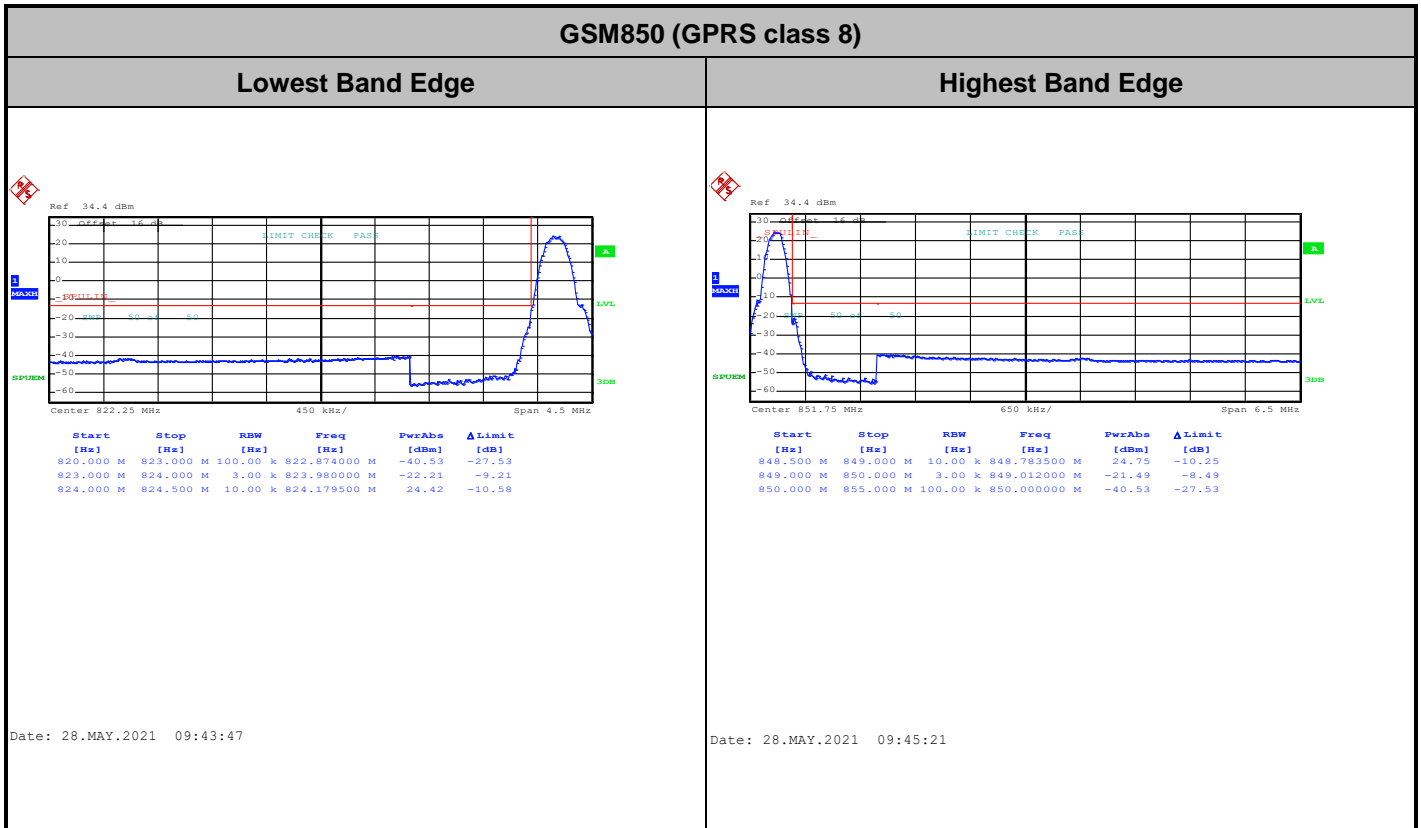



GSM850 (EDGE class 8)

Lowest Band Edge

Highest Band Edge

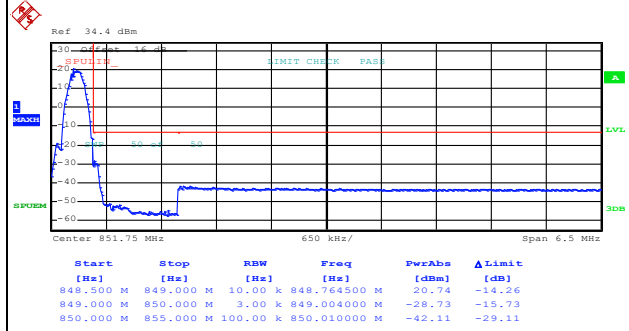
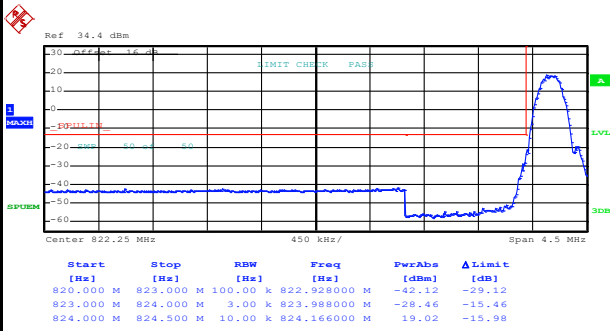

Date: 28.MAY.2021 10:15:33

Date: 28.MAY.2021 10:17:05



GSM1900 (GPRS class 8)

Lowest Band Edge

Highest Band Edge

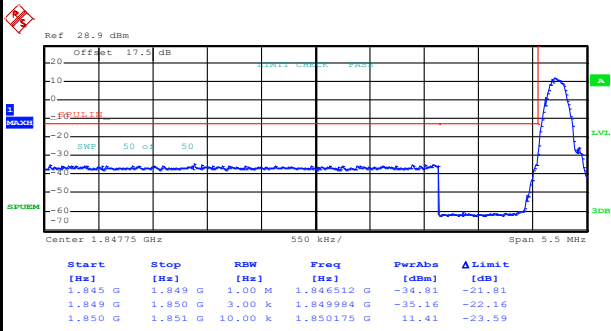

Date: 28.MAY.2021 10:01:10

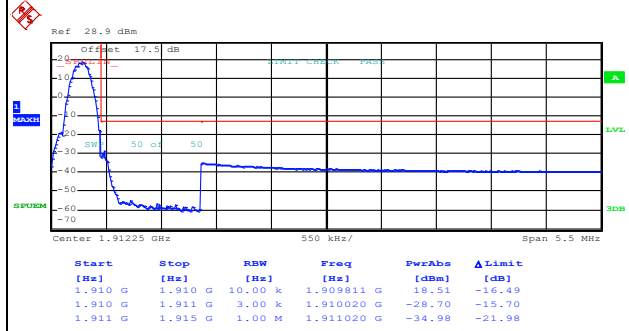

Date: 28.MAY.2021 10:03:30



GSM1900 (EDGE class 8)

Lowest Band Edge

Highest Band Edge

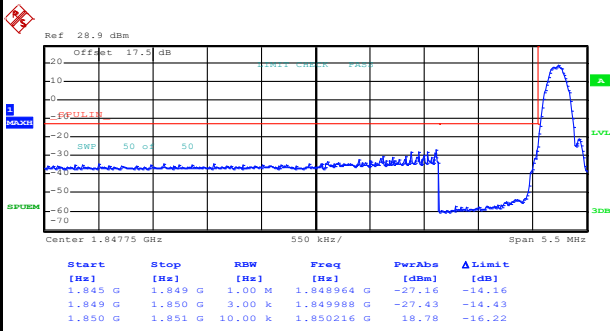

Date: 28.MAY.2021 10:27:36

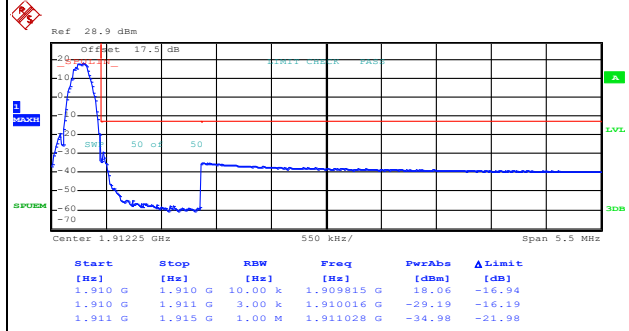

Date: 28.MAY.2021 10:29:09

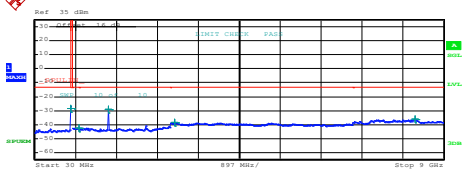
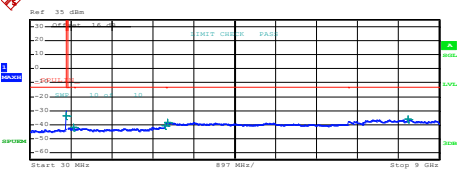
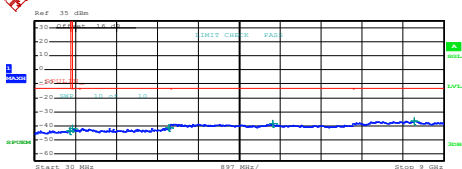
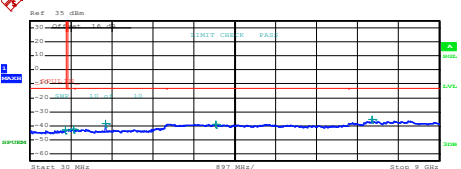
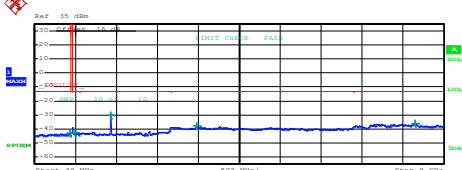
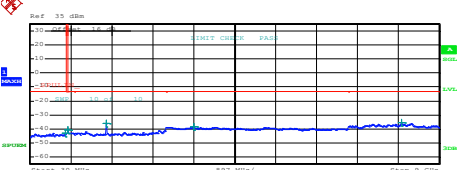

Conducted Spurious Emission

GSM850 (GPRS class 8)	GSM850 (EDGE class 8)																																																																								
Lowest Channel	Lowest Channel																																																																								
 <table border="1" data-bbox="239 660 654 739"> <thead> <tr> <th>Start [Hz]</th> <th>Stop [Hz]</th> <th>RBW [Hz]</th> <th>Freq [Hz]</th> <th>Power [dBm]</th> <th>Limit [dB]</th> </tr> </thead> <tbody> <tr><td>35,000 M</td><td>820,000 M</td><td>1,00 M</td><td>816,802500 M</td><td>-28.18</td><td>-25.18</td></tr> <tr><td>855,000 M</td><td>1,000 G</td><td>1,00 M</td><td>999,021260 M</td><td>-42.58</td><td>-29.58</td></tr> <tr><td>1,000 G</td><td>3,000 G</td><td>1,00 M</td><td>1,668500 G</td><td>-29.07</td><td>-26.07</td></tr> <tr><td>3,000 G</td><td>7,000 G</td><td>1,00 M</td><td>3,090000 G</td><td>-38.61</td><td>-25.61</td></tr> <tr><td>7,000 G</td><td>9,000 G</td><td>1,00 M</td><td>8,375000 G</td><td>-35.84</td><td>-22.84</td></tr> </tbody> </table> <p>Date: 28.MAY.2021 09:37:23</p>	Start [Hz]	Stop [Hz]	RBW [Hz]	Freq [Hz]	Power [dBm]	Limit [dB]	35,000 M	820,000 M	1,00 M	816,802500 M	-28.18	-25.18	855,000 M	1,000 G	1,00 M	999,021260 M	-42.58	-29.58	1,000 G	3,000 G	1,00 M	1,668500 G	-29.07	-26.07	3,000 G	7,000 G	1,00 M	3,090000 G	-38.61	-25.61	7,000 G	9,000 G	1,00 M	8,375000 G	-35.84	-22.84	 <table border="1" data-bbox="893 660 1308 739"> <thead> <tr> <th>Start [Hz]</th> <th>Stop [Hz]</th> <th>RBW [Hz]</th> <th>Freq [Hz]</th> <th>Power [dBm]</th> <th>Limit [dB]</th> </tr> </thead> <tbody> <tr><td>35,000 M</td><td>820,000 M</td><td>1,00 M</td><td>816,802500 M</td><td>-28.18</td><td>-25.18</td></tr> <tr><td>855,000 M</td><td>1,000 G</td><td>1,00 M</td><td>999,021260 M</td><td>-42.58</td><td>-29.58</td></tr> <tr><td>1,000 G</td><td>3,000 G</td><td>1,00 M</td><td>2,984500 G</td><td>-40.94</td><td>-27.94</td></tr> <tr><td>3,000 G</td><td>7,000 G</td><td>1,00 M</td><td>3,052000 G</td><td>-38.15</td><td>-25.15</td></tr> <tr><td>7,000 G</td><td>9,000 G</td><td>1,00 M</td><td>8,324500 G</td><td>-36.08</td><td>-23.08</td></tr> </tbody> </table> <p>Date: 28.MAY.2021 10:10:20</p>	Start [Hz]	Stop [Hz]	RBW [Hz]	Freq [Hz]	Power [dBm]	Limit [dB]	35,000 M	820,000 M	1,00 M	816,802500 M	-28.18	-25.18	855,000 M	1,000 G	1,00 M	999,021260 M	-42.58	-29.58	1,000 G	3,000 G	1,00 M	2,984500 G	-40.94	-27.94	3,000 G	7,000 G	1,00 M	3,052000 G	-38.15	-25.15	7,000 G	9,000 G	1,00 M	8,324500 G	-36.08	-23.08
Start [Hz]	Stop [Hz]	RBW [Hz]	Freq [Hz]	Power [dBm]	Limit [dB]																																																																				
35,000 M	820,000 M	1,00 M	816,802500 M	-28.18	-25.18																																																																				
855,000 M	1,000 G	1,00 M	999,021260 M	-42.58	-29.58																																																																				
1,000 G	3,000 G	1,00 M	1,668500 G	-29.07	-26.07																																																																				
3,000 G	7,000 G	1,00 M	3,090000 G	-38.61	-25.61																																																																				
7,000 G	9,000 G	1,00 M	8,375000 G	-35.84	-22.84																																																																				
Start [Hz]	Stop [Hz]	RBW [Hz]	Freq [Hz]	Power [dBm]	Limit [dB]																																																																				
35,000 M	820,000 M	1,00 M	816,802500 M	-28.18	-25.18																																																																				
855,000 M	1,000 G	1,00 M	999,021260 M	-42.58	-29.58																																																																				
1,000 G	3,000 G	1,00 M	2,984500 G	-40.94	-27.94																																																																				
3,000 G	7,000 G	1,00 M	3,052000 G	-38.15	-25.15																																																																				
7,000 G	9,000 G	1,00 M	8,324500 G	-36.08	-23.08																																																																				
Middle Channel	Middle Channel																																																																								
 <table border="1" data-bbox="239 1178 654 1256"> <thead> <tr> <th>Start [Hz]</th> <th>Stop [Hz]</th> <th>RBW [Hz]</th> <th>Freq [Hz]</th> <th>Power [dBm]</th> <th>Limit [dB]</th> </tr> </thead> <tbody> <tr><td>35,000 M</td><td>820,000 M</td><td>1,00 M</td><td>799,312500 M</td><td>-43.58</td><td>-30.58</td></tr> <tr><td>855,000 M</td><td>1,000 G</td><td>1,00 M</td><td>820,412500 M</td><td>-42.13</td><td>-29.13</td></tr> <tr><td>1,000 G</td><td>3,000 G</td><td>1,00 M</td><td>2,980000 G</td><td>-41.18</td><td>-28.18</td></tr> <tr><td>3,000 G</td><td>7,000 G</td><td>1,00 M</td><td>3,247000 G</td><td>-38.53</td><td>-25.53</td></tr> <tr><td>7,000 G</td><td>9,000 G</td><td>1,00 M</td><td>8,358000 G</td><td>-36.42</td><td>-23.42</td></tr> </tbody> </table> <p>Date: 28.MAY.2021 09:38:16</p>	Start [Hz]	Stop [Hz]	RBW [Hz]	Freq [Hz]	Power [dBm]	Limit [dB]	35,000 M	820,000 M	1,00 M	799,312500 M	-43.58	-30.58	855,000 M	1,000 G	1,00 M	820,412500 M	-42.13	-29.13	1,000 G	3,000 G	1,00 M	2,980000 G	-41.18	-28.18	3,000 G	7,000 G	1,00 M	3,247000 G	-38.53	-25.53	7,000 G	9,000 G	1,00 M	8,358000 G	-36.42	-23.42	 <table border="1" data-bbox="893 1178 1308 1256"> <thead> <tr> <th>Start [Hz]</th> <th>Stop [Hz]</th> <th>RBW [Hz]</th> <th>Freq [Hz]</th> <th>Power [dBm]</th> <th>Limit [dB]</th> </tr> </thead> <tbody> <tr><td>35,000 M</td><td>820,000 M</td><td>1,00 M</td><td>799,472500 M</td><td>-43.02</td><td>-30.02</td></tr> <tr><td>855,000 M</td><td>1,000 G</td><td>1,00 M</td><td>820,731250 M</td><td>-42.30</td><td>-29.30</td></tr> <tr><td>1,000 G</td><td>3,000 G</td><td>1,00 M</td><td>1,672500 G</td><td>-38.34</td><td>-25.34</td></tr> <tr><td>3,000 G</td><td>7,000 G</td><td>1,00 M</td><td>4,096000 G</td><td>-38.73</td><td>-25.73</td></tr> <tr><td>7,000 G</td><td>9,000 G</td><td>1,00 M</td><td>7,334500 G</td><td>-35.53</td><td>-22.53</td></tr> </tbody> </table> <p>Date: 28.MAY.2021 10:11:12</p>	Start [Hz]	Stop [Hz]	RBW [Hz]	Freq [Hz]	Power [dBm]	Limit [dB]	35,000 M	820,000 M	1,00 M	799,472500 M	-43.02	-30.02	855,000 M	1,000 G	1,00 M	820,731250 M	-42.30	-29.30	1,000 G	3,000 G	1,00 M	1,672500 G	-38.34	-25.34	3,000 G	7,000 G	1,00 M	4,096000 G	-38.73	-25.73	7,000 G	9,000 G	1,00 M	7,334500 G	-35.53	-22.53
Start [Hz]	Stop [Hz]	RBW [Hz]	Freq [Hz]	Power [dBm]	Limit [dB]																																																																				
35,000 M	820,000 M	1,00 M	799,312500 M	-43.58	-30.58																																																																				
855,000 M	1,000 G	1,00 M	820,412500 M	-42.13	-29.13																																																																				
1,000 G	3,000 G	1,00 M	2,980000 G	-41.18	-28.18																																																																				
3,000 G	7,000 G	1,00 M	3,247000 G	-38.53	-25.53																																																																				
7,000 G	9,000 G	1,00 M	8,358000 G	-36.42	-23.42																																																																				
Start [Hz]	Stop [Hz]	RBW [Hz]	Freq [Hz]	Power [dBm]	Limit [dB]																																																																				
35,000 M	820,000 M	1,00 M	799,472500 M	-43.02	-30.02																																																																				
855,000 M	1,000 G	1,00 M	820,731250 M	-42.30	-29.30																																																																				
1,000 G	3,000 G	1,00 M	1,672500 G	-38.34	-25.34																																																																				
3,000 G	7,000 G	1,00 M	4,096000 G	-38.73	-25.73																																																																				
7,000 G	9,000 G	1,00 M	7,334500 G	-35.53	-22.53																																																																				
Highest Channel	Highest Channel																																																																								
 <table border="1" data-bbox="239 1695 654 1774"> <thead> <tr> <th>Start [Hz]</th> <th>Stop [Hz]</th> <th>RBW [Hz]</th> <th>Freq [Hz]</th> <th>Power [dBm]</th> <th>Limit [dB]</th> </tr> </thead> <tbody> <tr><td>35,000 M</td><td>820,000 M</td><td>1,00 M</td><td>802,412500 M</td><td>-43.19</td><td>-30.19</td></tr> <tr><td>855,000 M</td><td>1,000 G</td><td>1,00 M</td><td>914,993754 M</td><td>-42.71</td><td>-29.71</td></tr> <tr><td>1,000 G</td><td>3,000 G</td><td>1,00 M</td><td>1,638000 G</td><td>-30.12</td><td>-27.12</td></tr> <tr><td>3,000 G</td><td>7,000 G</td><td>1,00 M</td><td>3,288000 G</td><td>-37.71</td><td>-24.71</td></tr> <tr><td>7,000 G</td><td>9,000 G</td><td>1,00 M</td><td>8,366000 G</td><td>-36.19</td><td>-23.19</td></tr> </tbody> </table> <p>Date: 28.MAY.2021 09:39:10</p>	Start [Hz]	Stop [Hz]	RBW [Hz]	Freq [Hz]	Power [dBm]	Limit [dB]	35,000 M	820,000 M	1,00 M	802,412500 M	-43.19	-30.19	855,000 M	1,000 G	1,00 M	914,993754 M	-42.71	-29.71	1,000 G	3,000 G	1,00 M	1,638000 G	-30.12	-27.12	3,000 G	7,000 G	1,00 M	3,288000 G	-37.71	-24.71	7,000 G	9,000 G	1,00 M	8,366000 G	-36.19	-23.19	 <table border="1" data-bbox="893 1695 1308 1774"> <thead> <tr> <th>Start [Hz]</th> <th>Stop [Hz]</th> <th>RBW [Hz]</th> <th>Freq [Hz]</th> <th>Power [dBm]</th> <th>Limit [dB]</th> </tr> </thead> <tbody> <tr><td>35,000 M</td><td>820,000 M</td><td>1,00 M</td><td>803,012500 M</td><td>-43.93</td><td>-30.93</td></tr> <tr><td>855,000 M</td><td>1,000 G</td><td>1,00 M</td><td>855,036250 M</td><td>-40.58</td><td>-27.58</td></tr> <tr><td>1,000 G</td><td>3,000 G</td><td>1,00 M</td><td>1,638000 G</td><td>-36.31</td><td>-23.31</td></tr> <tr><td>3,000 G</td><td>7,000 G</td><td>1,00 M</td><td>3,610000 G</td><td>-38.60</td><td>-25.60</td></tr> <tr><td>7,000 G</td><td>9,000 G</td><td>1,00 M</td><td>8,178500 G</td><td>-35.74</td><td>-22.74</td></tr> </tbody> </table> <p>Date: 28.MAY.2021 10:12:03</p>	Start [Hz]	Stop [Hz]	RBW [Hz]	Freq [Hz]	Power [dBm]	Limit [dB]	35,000 M	820,000 M	1,00 M	803,012500 M	-43.93	-30.93	855,000 M	1,000 G	1,00 M	855,036250 M	-40.58	-27.58	1,000 G	3,000 G	1,00 M	1,638000 G	-36.31	-23.31	3,000 G	7,000 G	1,00 M	3,610000 G	-38.60	-25.60	7,000 G	9,000 G	1,00 M	8,178500 G	-35.74	-22.74
Start [Hz]	Stop [Hz]	RBW [Hz]	Freq [Hz]	Power [dBm]	Limit [dB]																																																																				
35,000 M	820,000 M	1,00 M	802,412500 M	-43.19	-30.19																																																																				
855,000 M	1,000 G	1,00 M	914,993754 M	-42.71	-29.71																																																																				
1,000 G	3,000 G	1,00 M	1,638000 G	-30.12	-27.12																																																																				
3,000 G	7,000 G	1,00 M	3,288000 G	-37.71	-24.71																																																																				
7,000 G	9,000 G	1,00 M	8,366000 G	-36.19	-23.19																																																																				
Start [Hz]	Stop [Hz]	RBW [Hz]	Freq [Hz]	Power [dBm]	Limit [dB]																																																																				
35,000 M	820,000 M	1,00 M	803,012500 M	-43.93	-30.93																																																																				
855,000 M	1,000 G	1,00 M	855,036250 M	-40.58	-27.58																																																																				
1,000 G	3,000 G	1,00 M	1,638000 G	-36.31	-23.31																																																																				
3,000 G	7,000 G	1,00 M	3,610000 G	-38.60	-25.60																																																																				
7,000 G	9,000 G	1,00 M	8,178500 G	-35.74	-22.74																																																																				

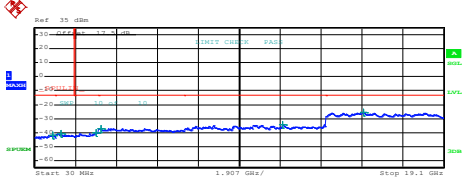
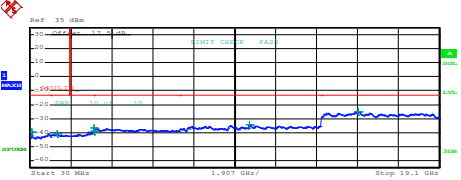
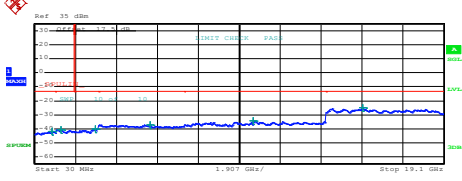
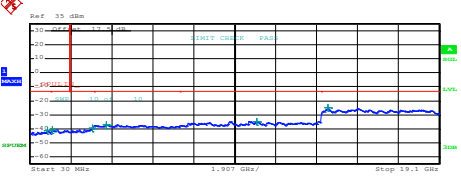
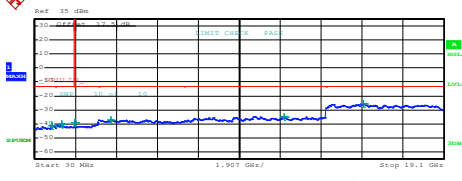
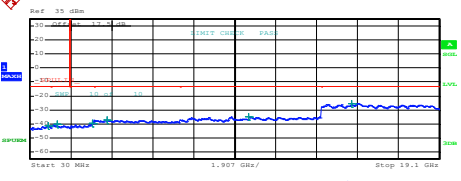

GSM1900 (GPRS class 8)	GSM1900 (EDGE class 8)																																																																																				
Lowest Channel	Lowest Channel																																																																																				
 <table border="1" data-bbox="239 577 638 672"> <thead> <tr> <th>Start [Hz]</th> <th>Stop [Hz]</th> <th>RBW [Hz]</th> <th>Freq [Hz]</th> <th>PwrAve [dBm]</th> <th>ΔLimit [dB]</th> </tr> </thead> <tbody> <tr><td>30.000 M</td><td>1.000 G</td><td>1.00 M</td><td>866.067500 M</td><td>-43.94</td><td>-28.45</td></tr> <tr><td>1.000 G</td><td>1.845 G</td><td>1.00 M</td><td>1.293959 G</td><td>-40.82</td><td>-27.82</td></tr> <tr><td>1.845 G</td><td>3.000 G</td><td>1.00 M</td><td>2.193070 G</td><td>-39.95</td><td>-26.93</td></tr> <tr><td>3.000 G</td><td>7.000 G</td><td>1.00 M</td><td>3.108000 G</td><td>-37.08</td><td>-24.08</td></tr> <tr><td>7.000 G</td><td>13.600 G</td><td>1.00 M</td><td>11.601890 G</td><td>-34.15</td><td>-21.15</td></tr> <tr><td>13.600 G</td><td>19.100 G</td><td>1.00 M</td><td>15.348313 G</td><td>-25.38</td><td>-12.38</td></tr> </tbody> </table> <p>Date: 28.MAY.2021 09:55:48</p>	Start [Hz]	Stop [Hz]	RBW [Hz]	Freq [Hz]	PwrAve [dBm]	ΔLimit [dB]	30.000 M	1.000 G	1.00 M	866.067500 M	-43.94	-28.45	1.000 G	1.845 G	1.00 M	1.293959 G	-40.82	-27.82	1.845 G	3.000 G	1.00 M	2.193070 G	-39.95	-26.93	3.000 G	7.000 G	1.00 M	3.108000 G	-37.08	-24.08	7.000 G	13.600 G	1.00 M	11.601890 G	-34.15	-21.15	13.600 G	19.100 G	1.00 M	15.348313 G	-25.38	-12.38	 <table border="1" data-bbox="893 577 1292 672"> <thead> <tr> <th>Start [Hz]</th> <th>Stop [Hz]</th> <th>RBW [Hz]</th> <th>Freq [Hz]</th> <th>PwrAve [dBm]</th> <th>ΔLimit [dB]</th> </tr> </thead> <tbody> <tr><td>30.000 M</td><td>1.000 G</td><td>1.00 M</td><td>112.207100 M</td><td>-39.40</td><td>-26.40</td></tr> <tr><td>1.000 G</td><td>1.845 G</td><td>1.00 M</td><td>1.293215 G</td><td>-40.96</td><td>-27.96</td></tr> <tr><td>1.845 G</td><td>3.000 G</td><td>1.00 M</td><td>2.993259 G</td><td>-39.69</td><td>-25.69</td></tr> <tr><td>3.000 G</td><td>7.000 G</td><td>1.00 M</td><td>3.002000 G</td><td>-36.80</td><td>-23.80</td></tr> <tr><td>7.000 G</td><td>13.600 G</td><td>1.00 M</td><td>10.234825 G</td><td>-34.56</td><td>-21.56</td></tr> <tr><td>13.600 G</td><td>19.100 G</td><td>1.00 M</td><td>15.309813 G</td><td>-25.07</td><td>-12.07</td></tr> </tbody> </table> <p>Date: 28.MAY.2021 10:22:18</p>	Start [Hz]	Stop [Hz]	RBW [Hz]	Freq [Hz]	PwrAve [dBm]	ΔLimit [dB]	30.000 M	1.000 G	1.00 M	112.207100 M	-39.40	-26.40	1.000 G	1.845 G	1.00 M	1.293215 G	-40.96	-27.96	1.845 G	3.000 G	1.00 M	2.993259 G	-39.69	-25.69	3.000 G	7.000 G	1.00 M	3.002000 G	-36.80	-23.80	7.000 G	13.600 G	1.00 M	10.234825 G	-34.56	-21.56	13.600 G	19.100 G	1.00 M	15.309813 G	-25.07	-12.07
Start [Hz]	Stop [Hz]	RBW [Hz]	Freq [Hz]	PwrAve [dBm]	ΔLimit [dB]																																																																																
30.000 M	1.000 G	1.00 M	866.067500 M	-43.94	-28.45																																																																																
1.000 G	1.845 G	1.00 M	1.293959 G	-40.82	-27.82																																																																																
1.845 G	3.000 G	1.00 M	2.193070 G	-39.95	-26.93																																																																																
3.000 G	7.000 G	1.00 M	3.108000 G	-37.08	-24.08																																																																																
7.000 G	13.600 G	1.00 M	11.601890 G	-34.15	-21.15																																																																																
13.600 G	19.100 G	1.00 M	15.348313 G	-25.38	-12.38																																																																																
Start [Hz]	Stop [Hz]	RBW [Hz]	Freq [Hz]	PwrAve [dBm]	ΔLimit [dB]																																																																																
30.000 M	1.000 G	1.00 M	112.207100 M	-39.40	-26.40																																																																																
1.000 G	1.845 G	1.00 M	1.293215 G	-40.96	-27.96																																																																																
1.845 G	3.000 G	1.00 M	2.993259 G	-39.69	-25.69																																																																																
3.000 G	7.000 G	1.00 M	3.002000 G	-36.80	-23.80																																																																																
7.000 G	13.600 G	1.00 M	10.234825 G	-34.56	-21.56																																																																																
13.600 G	19.100 G	1.00 M	15.309813 G	-25.07	-12.07																																																																																
Middle Channel	Middle Channel																																																																																				
 <table border="1" data-bbox="239 1102 638 1196"> <thead> <tr> <th>Start [Hz]</th> <th>Stop [Hz]</th> <th>RBW [Hz]</th> <th>Freq [Hz]</th> <th>PwrAve [dBm]</th> <th>ΔLimit [dB]</th> </tr> </thead> <tbody> <tr><td>30.000 M</td><td>1.000 G</td><td>1.00 M</td><td>839.707500 M</td><td>-41.71</td><td>-28.71</td></tr> <tr><td>1.000 G</td><td>3.845 G</td><td>1.00 M</td><td>1.232266 G</td><td>-40.32</td><td>-27.32</td></tr> <tr><td>1.915 G</td><td>3.000 G</td><td>1.00 M</td><td>2.862747 G</td><td>-39.98</td><td>-26.98</td></tr> <tr><td>3.000 G</td><td>7.000 G</td><td>1.00 M</td><td>3.418000 G</td><td>-37.21</td><td>-24.21</td></tr> <tr><td>7.000 G</td><td>13.600 G</td><td>1.00 M</td><td>10.213925 G</td><td>-34.47</td><td>-21.47</td></tr> <tr><td>13.600 G</td><td>19.100 G</td><td>1.00 M</td><td>15.322188 G</td><td>-25.21</td><td>-12.21</td></tr> </tbody> </table> <p>Date: 28.MAY.2021 09:56:40</p>	Start [Hz]	Stop [Hz]	RBW [Hz]	Freq [Hz]	PwrAve [dBm]	ΔLimit [dB]	30.000 M	1.000 G	1.00 M	839.707500 M	-41.71	-28.71	1.000 G	3.845 G	1.00 M	1.232266 G	-40.32	-27.32	1.915 G	3.000 G	1.00 M	2.862747 G	-39.98	-26.98	3.000 G	7.000 G	1.00 M	3.418000 G	-37.21	-24.21	7.000 G	13.600 G	1.00 M	10.213925 G	-34.47	-21.47	13.600 G	19.100 G	1.00 M	15.322188 G	-25.21	-12.21	 <table border="1" data-bbox="893 1102 1292 1196"> <thead> <tr> <th>Start [Hz]</th> <th>Stop [Hz]</th> <th>RBW [Hz]</th> <th>Freq [Hz]</th> <th>PwrAve [dBm]</th> <th>ΔLimit [dB]</th> </tr> </thead> <tbody> <tr><td>30.000 M</td><td>1.000 G</td><td>1.00 M</td><td>849.042500 M</td><td>-41.50</td><td>-28.50</td></tr> <tr><td>1.000 G</td><td>3.845 G</td><td>1.00 M</td><td>1.077029 G</td><td>-40.51</td><td>-27.51</td></tr> <tr><td>1.915 G</td><td>3.000 G</td><td>1.00 M</td><td>2.933273 G</td><td>-39.68</td><td>-26.68</td></tr> <tr><td>3.000 G</td><td>7.000 G</td><td>1.00 M</td><td>3.591000 G</td><td>-37.36</td><td>-24.36</td></tr> <tr><td>7.000 G</td><td>13.600 G</td><td>1.00 M</td><td>10.238250 G</td><td>-34.73</td><td>-21.73</td></tr> <tr><td>13.600 G</td><td>19.100 G</td><td>1.00 M</td><td>13.926582 G</td><td>-24.78</td><td>-11.78</td></tr> </tbody> </table> <p>Date: 28.MAY.2021 10:23:10</p>	Start [Hz]	Stop [Hz]	RBW [Hz]	Freq [Hz]	PwrAve [dBm]	ΔLimit [dB]	30.000 M	1.000 G	1.00 M	849.042500 M	-41.50	-28.50	1.000 G	3.845 G	1.00 M	1.077029 G	-40.51	-27.51	1.915 G	3.000 G	1.00 M	2.933273 G	-39.68	-26.68	3.000 G	7.000 G	1.00 M	3.591000 G	-37.36	-24.36	7.000 G	13.600 G	1.00 M	10.238250 G	-34.73	-21.73	13.600 G	19.100 G	1.00 M	13.926582 G	-24.78	-11.78
Start [Hz]	Stop [Hz]	RBW [Hz]	Freq [Hz]	PwrAve [dBm]	ΔLimit [dB]																																																																																
30.000 M	1.000 G	1.00 M	839.707500 M	-41.71	-28.71																																																																																
1.000 G	3.845 G	1.00 M	1.232266 G	-40.32	-27.32																																																																																
1.915 G	3.000 G	1.00 M	2.862747 G	-39.98	-26.98																																																																																
3.000 G	7.000 G	1.00 M	3.418000 G	-37.21	-24.21																																																																																
7.000 G	13.600 G	1.00 M	10.213925 G	-34.47	-21.47																																																																																
13.600 G	19.100 G	1.00 M	15.322188 G	-25.21	-12.21																																																																																
Start [Hz]	Stop [Hz]	RBW [Hz]	Freq [Hz]	PwrAve [dBm]	ΔLimit [dB]																																																																																
30.000 M	1.000 G	1.00 M	849.042500 M	-41.50	-28.50																																																																																
1.000 G	3.845 G	1.00 M	1.077029 G	-40.51	-27.51																																																																																
1.915 G	3.000 G	1.00 M	2.933273 G	-39.68	-26.68																																																																																
3.000 G	7.000 G	1.00 M	3.591000 G	-37.36	-24.36																																																																																
7.000 G	13.600 G	1.00 M	10.238250 G	-34.73	-21.73																																																																																
13.600 G	19.100 G	1.00 M	13.926582 G	-24.78	-11.78																																																																																
Highest Channel	Highest Channel																																																																																				
 <table border="1" data-bbox="239 1626 638 1720"> <thead> <tr> <th>Start [Hz]</th> <th>Stop [Hz]</th> <th>RBW [Hz]</th> <th>Freq [Hz]</th> <th>PwrAve [dBm]</th> <th>ΔLimit [dB]</th> </tr> </thead> <tbody> <tr><td>30.000 M</td><td>1.000 G</td><td>1.00 M</td><td>836.432500 M</td><td>-41.27</td><td>-28.27</td></tr> <tr><td>1.000 G</td><td>1.845 G</td><td>1.00 M</td><td>1.270823 G</td><td>-40.03</td><td>-27.03</td></tr> <tr><td>1.845 G</td><td>3.000 G</td><td>1.00 M</td><td>1.932071 G</td><td>-38.79</td><td>-25.79</td></tr> <tr><td>3.000 G</td><td>7.000 G</td><td>1.00 M</td><td>3.559000 G</td><td>-37.15</td><td>-24.15</td></tr> <tr><td>7.000 G</td><td>13.600 G</td><td>1.00 M</td><td>11.674450 G</td><td>-34.68</td><td>-21.68</td></tr> <tr><td>13.600 G</td><td>19.100 G</td><td>1.00 M</td><td>15.366887 G</td><td>-25.45</td><td>-12.45</td></tr> </tbody> </table> <p>Date: 28.MAY.2021 09:57:32</p>	Start [Hz]	Stop [Hz]	RBW [Hz]	Freq [Hz]	PwrAve [dBm]	ΔLimit [dB]	30.000 M	1.000 G	1.00 M	836.432500 M	-41.27	-28.27	1.000 G	1.845 G	1.00 M	1.270823 G	-40.03	-27.03	1.845 G	3.000 G	1.00 M	1.932071 G	-38.79	-25.79	3.000 G	7.000 G	1.00 M	3.559000 G	-37.15	-24.15	7.000 G	13.600 G	1.00 M	11.674450 G	-34.68	-21.68	13.600 G	19.100 G	1.00 M	15.366887 G	-25.45	-12.45	 <table border="1" data-bbox="893 1626 1292 1720"> <thead> <tr> <th>Start [Hz]</th> <th>Stop [Hz]</th> <th>RBW [Hz]</th> <th>Freq [Hz]</th> <th>PwrAve [dBm]</th> <th>ΔLimit [dB]</th> </tr> </thead> <tbody> <tr><td>30.000 M</td><td>1.000 G</td><td>1.00 M</td><td>850.377500 M</td><td>-41.45</td><td>-28.45</td></tr> <tr><td>1.000 G</td><td>1.845 G</td><td>1.00 M</td><td>1.292159 G</td><td>-40.18</td><td>-27.18</td></tr> <tr><td>1.845 G</td><td>3.000 G</td><td>1.00 M</td><td>2.947006 G</td><td>-39.38</td><td>-26.38</td></tr> <tr><td>3.000 G</td><td>7.000 G</td><td>1.00 M</td><td>3.597000 G</td><td>-37.21</td><td>-24.21</td></tr> <tr><td>7.000 G</td><td>13.600 G</td><td>1.00 M</td><td>10.216675 G</td><td>-34.97</td><td>-21.97</td></tr> <tr><td>13.600 G</td><td>19.100 G</td><td>1.00 M</td><td>15.031375 G</td><td>-25.30</td><td>-12.30</td></tr> </tbody> </table> <p>Date: 28.MAY.2021 10:24:03</p>	Start [Hz]	Stop [Hz]	RBW [Hz]	Freq [Hz]	PwrAve [dBm]	ΔLimit [dB]	30.000 M	1.000 G	1.00 M	850.377500 M	-41.45	-28.45	1.000 G	1.845 G	1.00 M	1.292159 G	-40.18	-27.18	1.845 G	3.000 G	1.00 M	2.947006 G	-39.38	-26.38	3.000 G	7.000 G	1.00 M	3.597000 G	-37.21	-24.21	7.000 G	13.600 G	1.00 M	10.216675 G	-34.97	-21.97	13.600 G	19.100 G	1.00 M	15.031375 G	-25.30	-12.30
Start [Hz]	Stop [Hz]	RBW [Hz]	Freq [Hz]	PwrAve [dBm]	ΔLimit [dB]																																																																																
30.000 M	1.000 G	1.00 M	836.432500 M	-41.27	-28.27																																																																																
1.000 G	1.845 G	1.00 M	1.270823 G	-40.03	-27.03																																																																																
1.845 G	3.000 G	1.00 M	1.932071 G	-38.79	-25.79																																																																																
3.000 G	7.000 G	1.00 M	3.559000 G	-37.15	-24.15																																																																																
7.000 G	13.600 G	1.00 M	11.674450 G	-34.68	-21.68																																																																																
13.600 G	19.100 G	1.00 M	15.366887 G	-25.45	-12.45																																																																																
Start [Hz]	Stop [Hz]	RBW [Hz]	Freq [Hz]	PwrAve [dBm]	ΔLimit [dB]																																																																																
30.000 M	1.000 G	1.00 M	850.377500 M	-41.45	-28.45																																																																																
1.000 G	1.845 G	1.00 M	1.292159 G	-40.18	-27.18																																																																																
1.845 G	3.000 G	1.00 M	2.947006 G	-39.38	-26.38																																																																																
3.000 G	7.000 G	1.00 M	3.597000 G	-37.21	-24.21																																																																																
7.000 G	13.600 G	1.00 M	10.216675 G	-34.97	-21.97																																																																																
13.600 G	19.100 G	1.00 M	15.031375 G	-25.30	-12.30																																																																																



Frequency Stability

Test Conditions	Middle Channel	GSM850 (GPRS class 8)	GSM850 (EDGE class 8)	Limit 2.5ppm
Temperature (°C)	Voltage (Volt)	Deviation (ppm)		Result
50	Normal Voltage	0.0036	0.0060	PASS
40	Normal Voltage	0.0012	0.0036	
30	Normal Voltage	0.0012	0.0024	
20(Ref.)	Normal Voltage	0.0000	0.0000	
10	Normal Voltage	0.0000	0.0024	
0	Normal Voltage	0.0024	0.0072	
-10	Normal Voltage	0.0072	0.0096	
-20	Normal Voltage	0.0096	0.0120	
-30	Normal Voltage	0.0143	0.0167	
20	Maximum Voltage	0.0024	0.0036	
20	Normal Voltage	0.0000	0.0000	
20	Battery End Point	0.0036	0.0048	

Test Conditions	Middle Channel	GSM1900 (GPRS class 8)	GSM1900 (EDGE class 8)	Limit Note 2.
Temperature (°C)	Voltage (Volt)	Deviation (ppm)		Result
50	Normal Voltage	0.0053	0.0053	PASS
40	Normal Voltage	0.0032	0.0032	
30	Normal Voltage	0.0021	0.0027	
20(Ref.)	Normal Voltage	0.0000	0.0000	
10	Normal Voltage	0.0000	0.0021	
0	Normal Voltage	0.0011	0.0074	
-10	Normal Voltage	0.0032	0.0080	
-20	Normal Voltage	0.0053	0.0096	
-30	Normal Voltage	0.0085	0.0117	
20	Maximum Voltage	0.0011	0.0027	
20	Normal Voltage	0.0000	0.0000	
20	Battery End Point	0.0011	0.0021	

Note:

1. Normal Voltage = 3.87V. ; Battery End Point (BEP) = 3.67 V. ; Maximum Voltage =4.26 V
2. The frequency fundamental emissions stay within the authorized frequency block.



A2. WCDMA

Peak-to-Average Ratio

Mode	WCDMA Band II	WCDMA Band IV	Limit: 13dB
Mod.	RMC 12.2Kbps	RMC 12.2Kbps	Result
Lowest CH	3.00	3.04	PASS
Middle CH	3.00	3.04	
Highest CH	3.08	3.04	

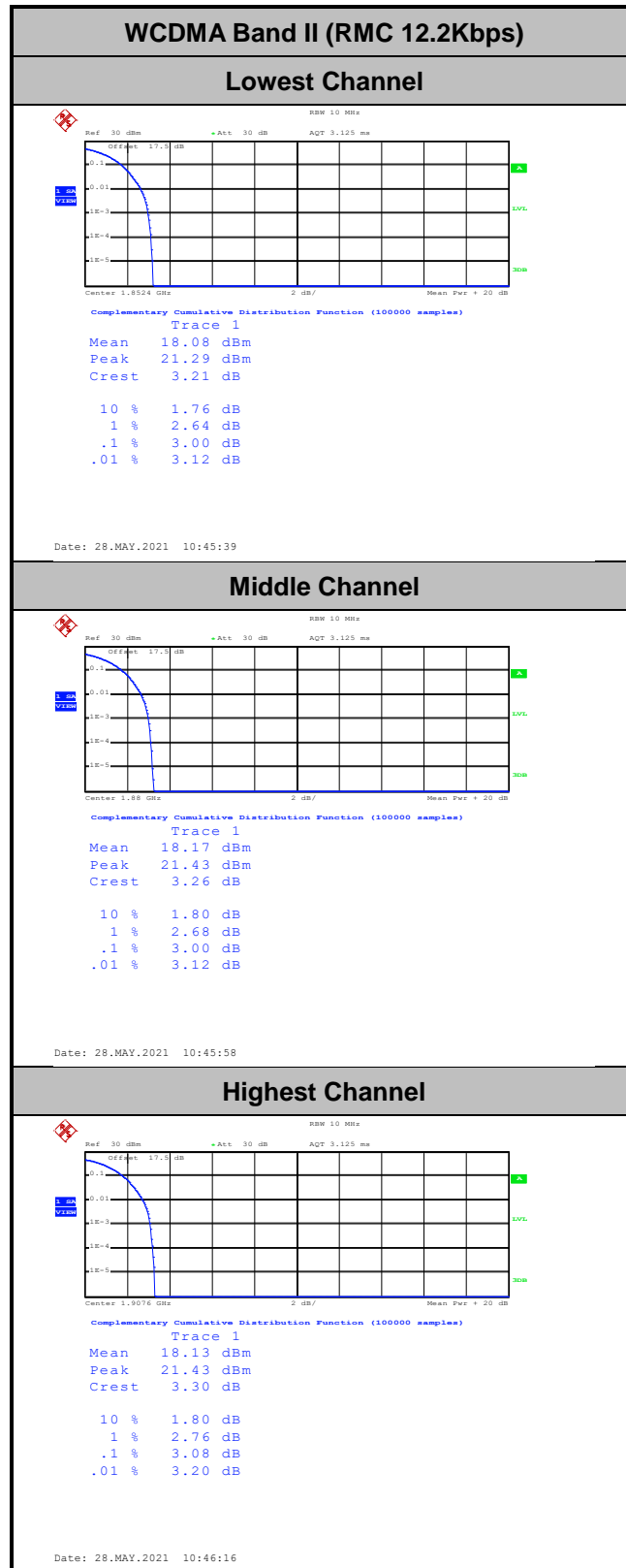

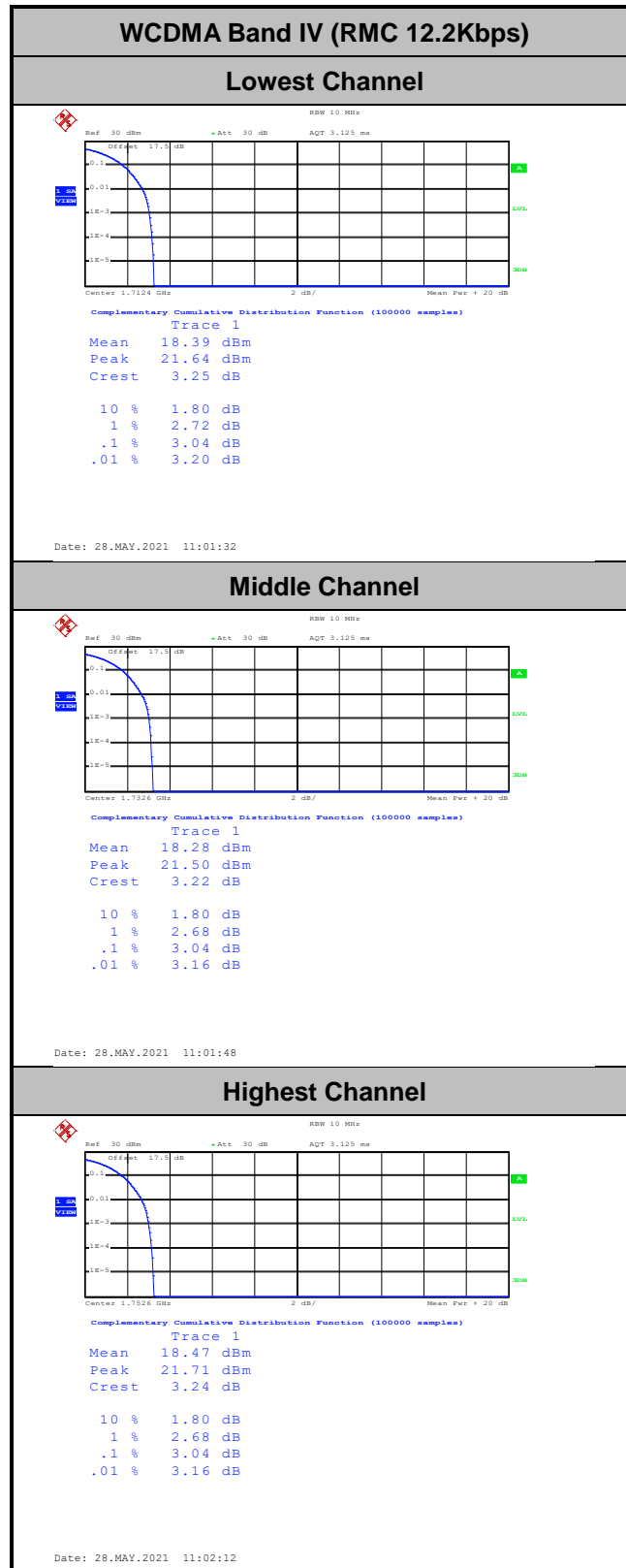



26dB Bandwidth

Mode	WCDMA Band II(MHz): 26dB BW (MHz)	WCDMA Band IV(MHz) : 26dB BW (MHz)
Mod.	RMC 12.2Kbps	RMC 12.2Kbps
Lowest CH	4.71	4.71
Middle CH	4.70	4.70
Highest CH	4.70	4.69

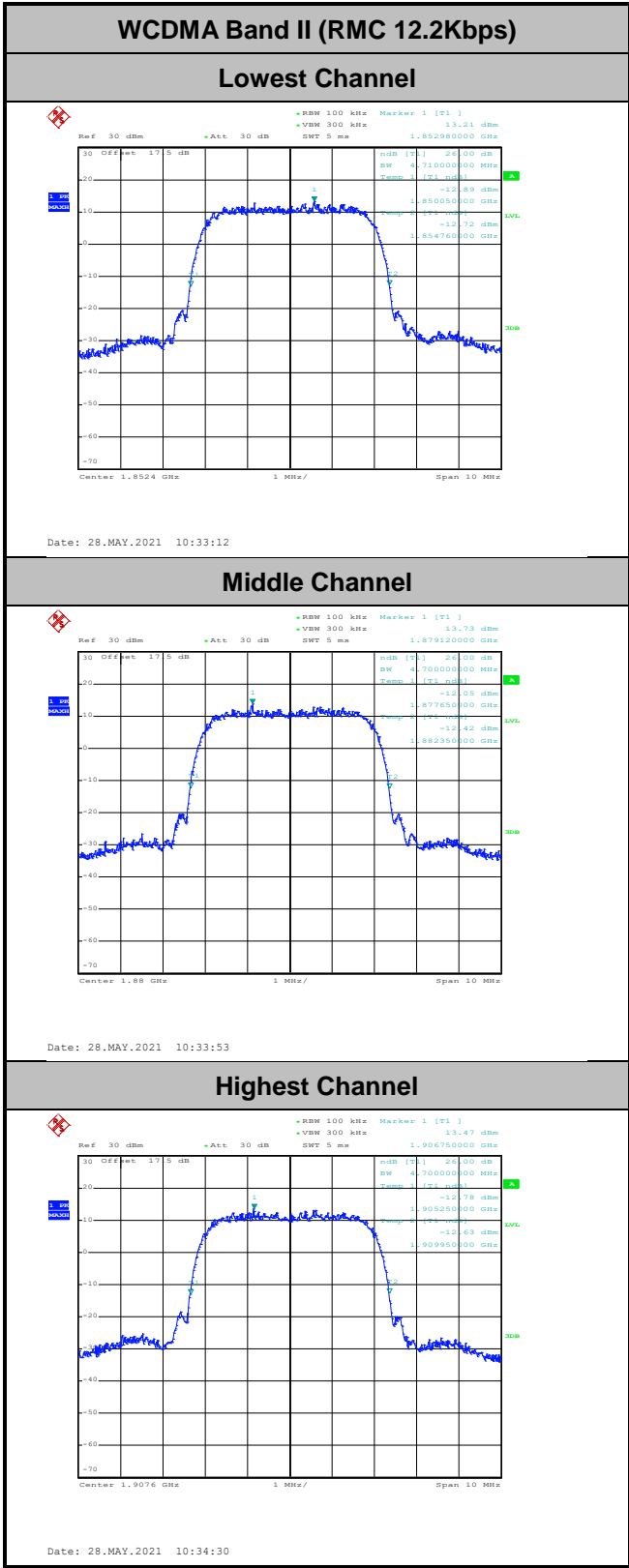



WCDMA Band IV (RMC 12.2Kbps)

Lowest Channel

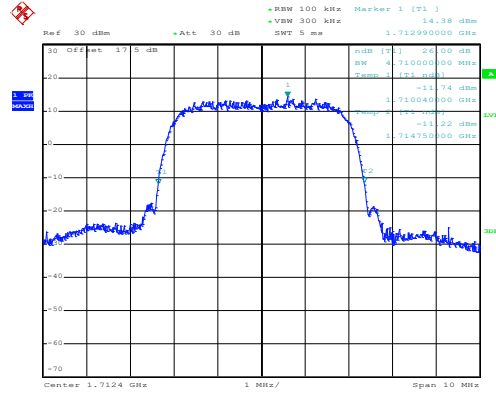

Date: 28.MAY.2021 10:47:26

Middle Channel

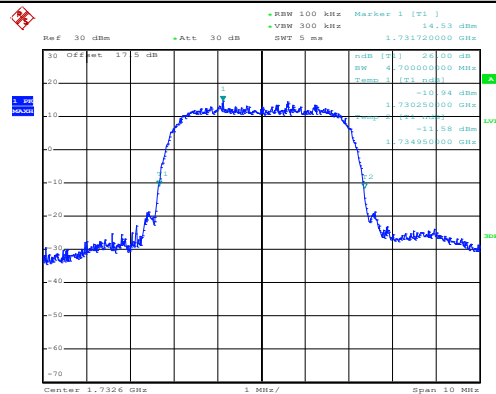

Date: 28.MAY.2021 10:48:06

Highest Channel

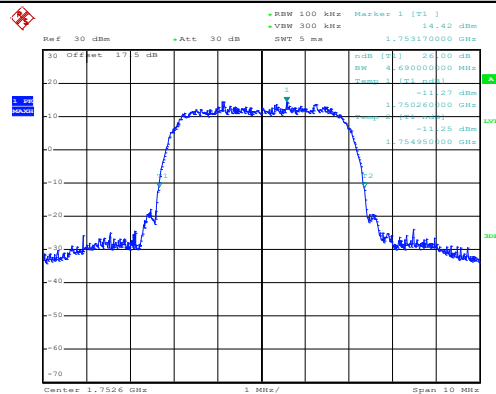

Date: 28.MAY.2021 10:48:40



Occupied Bandwidth

Mode	WCDMA Band II(MHz): 99% BW (MHz)	WCDMA Band IV(MHz) : 99% BW (MHz)
Mod.	RMC 12.2Kbps	RMC 12.2Kbps
Lowest CH	4.15	4.15
Middle CH	4.15	4.14
Highest CH	4.15	4.14



WCDMA Band II (RMC 12.2Kbps)

Lowest Channel

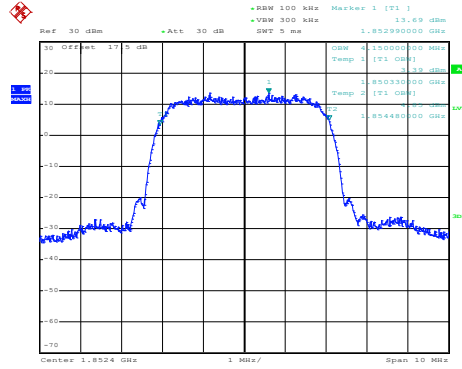

Date: 28.MAY.2021 10:38:05

Middle Channel

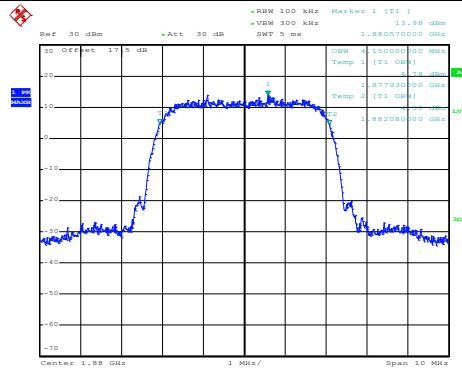

Date: 28.MAY.2021 10:38:40

Highest Channel

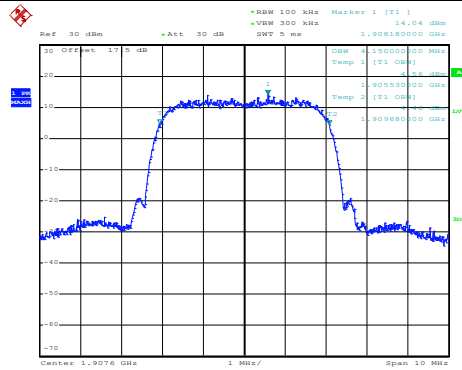

Date: 28.MAY.2021 10:39:19



WCDMA Band IV (RMC 12.2Kbps)

Lowest Channel

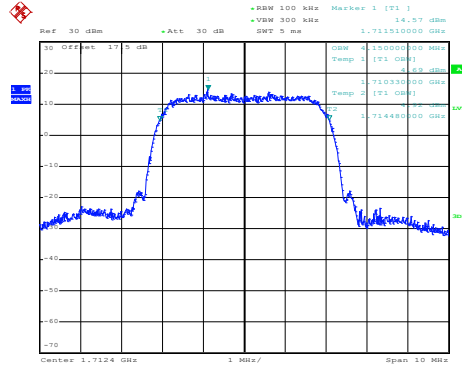

Date: 28.MAY.2021 10:53:59

Middle Channel

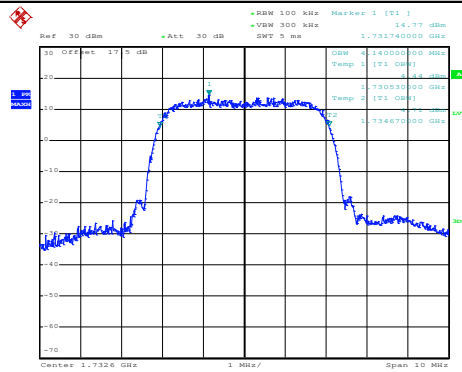

Date: 28.MAY.2021 10:54:37

Highest Channel

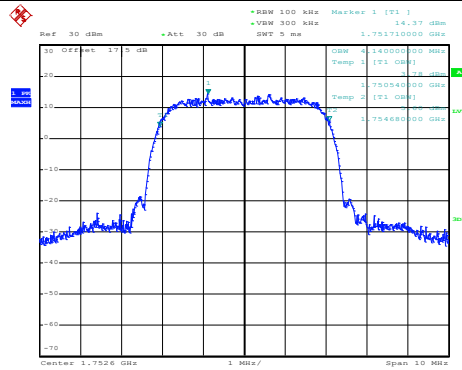

Date: 28.MAY.2021 10:55:16



Conducted Band Edge

WCDMA Band II (RMC 12.2Kbps)

Lowest Band Edge

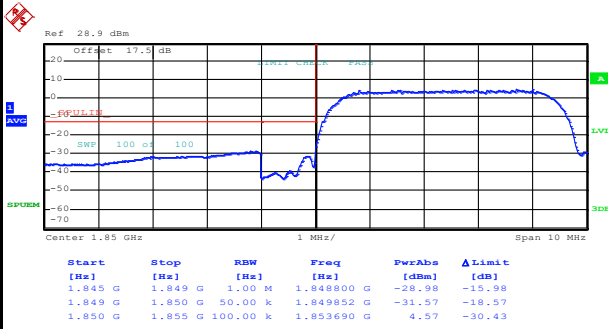

Date: 28.MAY.2021 10:42:14

Highest Band Edge

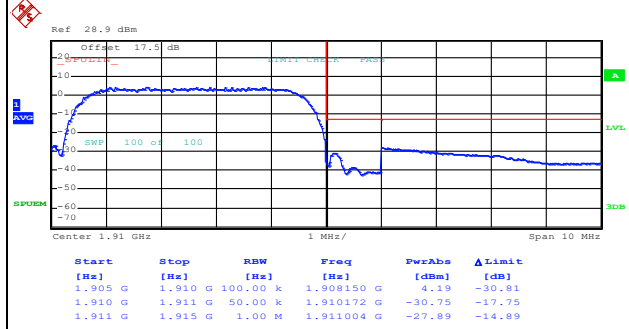

Date: 28.MAY.2021 10:45:13



WCDMA Band IV (RMC 12.2Kbps)

Lowest Band Edge

Highest Band Edge

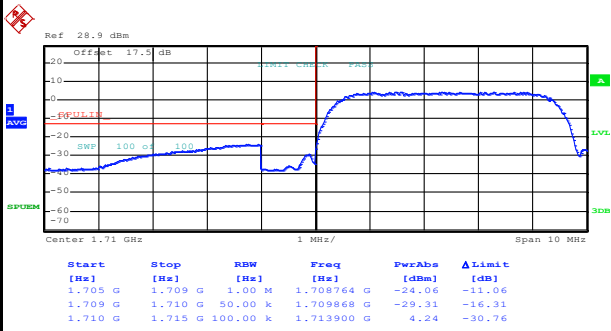

Date: 28.MAY.2021 10:58:15

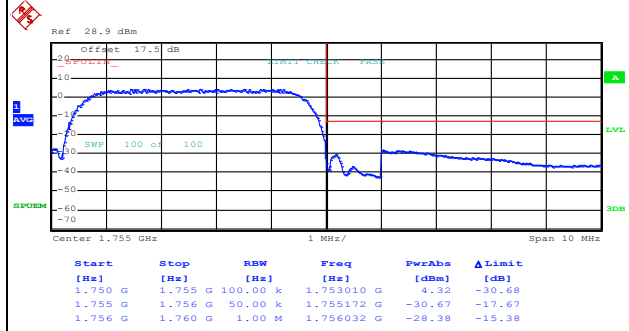

Date: 28.MAY.2021 11:01:07



Conducted Spurious Emission

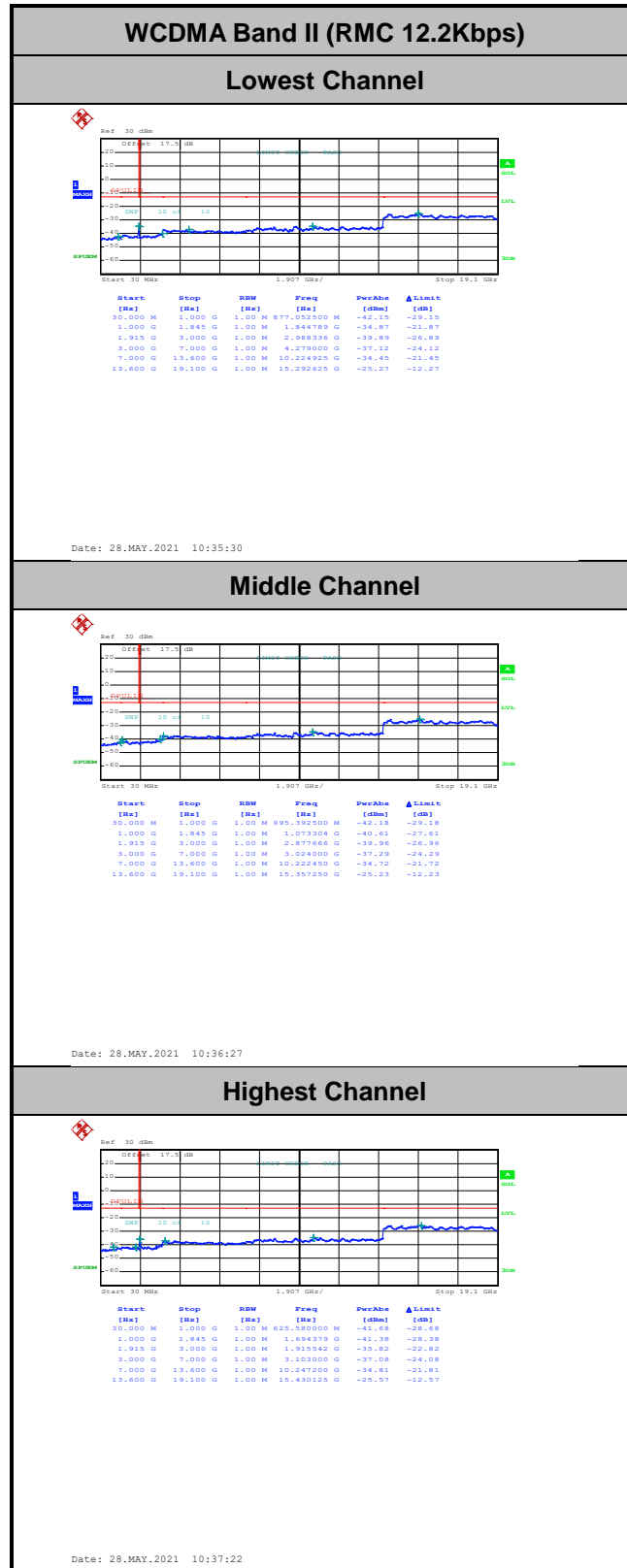



WCDMA Band IV (RMC 12.2Kbps)

Lowest Channel

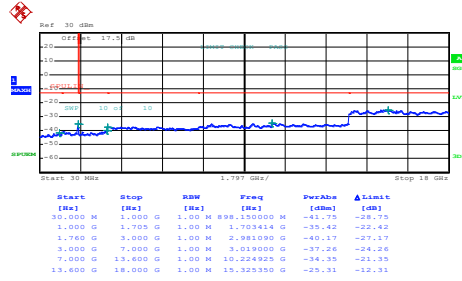

Date: 28.MAY.2021 10:51:15

Middle Channel

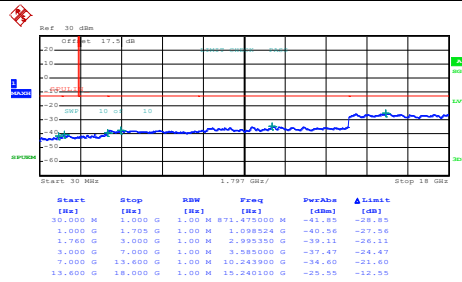

Date: 28.MAY.2021 10:52:10

Highest Channel

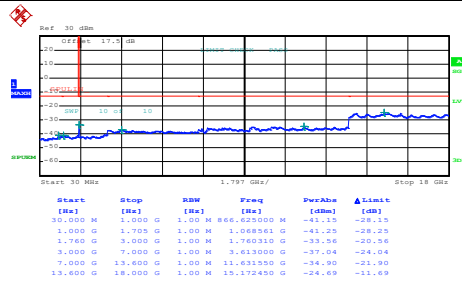

Date: 28.MAY.2021 10:53:15



Frequency Stability

Test Conditions	Middle Channel	WCDMA Band II (RMC 12.2Kbps)	Limit Note 2.
Temperature (°C)	Voltage (Volt)	Deviation (ppm)	Result
50	Normal Voltage	0.0016	PASS
40	Normal Voltage	0.0011	
30	Normal Voltage	0.0005	
20(Ref.)	Normal Voltage	0.0000	
10	Normal Voltage	0.0011	
0	Normal Voltage	0.0043	
-10	Normal Voltage	0.0074	
-20	Normal Voltage	0.0096	
-30	Normal Voltage	0.0106	
20	Maximum Voltage	0.0005	
20	Normal Voltage	0.0000	
20	Battery End Point	0.0011	

Test Conditions	Middle Channel	WCDMA Band IV (RMC 12.2Kbps)	Limit Note 2.
Temperature (°C)	Voltage (Volt)	Deviation (ppm)	Result
50	Normal Voltage	0.0098	PASS
40	Normal Voltage	0.0069	
30	Normal Voltage	0.0040	
20(Ref.)	Normal Voltage	0.0000	
10	Normal Voltage	0.0046	
0	Normal Voltage	0.0110	
-10	Normal Voltage	0.0127	
-20	Normal Voltage	0.0202	
-30	Normal Voltage	0.0254	
20	Maximum Voltage	0.0017	
20	Normal Voltage	0.0000	
20	Battery End Point	0.0006	

Note:

1. Normal Voltage = 3.87V. ; Battery End Point (BEP) = 3.67 V. ; Maximum Voltage =4.26 V
2. The frequency fundamental emissions stay within the authorized frequency block.



Appendix B. Test Results of Radiated Test

GPRS 850

GPRS 850									
Channel	Frequency (MHz)	ERP (dBm)	Limit (dBm)	Over Limit (dB)	SPA Reading (dBm)	S.G. Power (dBm)	TX Cable loss (dB)	TX Antenna Gain (dBi)	Polarization (H/V)
Lowest	1648	-61.17	-13	-48.17	-73.14	-66.47	1.83	9.28	H
	2472	-34.45	-13	-21.45	-51.03	-40.68	2.25	10.63	H
	3296	-57.69	-13	-44.69	-76.39	-65.20	2.62	12.28	H
									H
									H
									H
	1648	-57.25	-13	-44.25	-69.68	-62.55	1.83	9.28	V
	2472	-36.73	-13	-23.73	-53.54	-42.96	2.25	10.63	V
	3296	-57.68	-13	-44.68	-76.79	-65.19	2.62	12.28	V
									V
									V
									V
Middle	1672	-57.73	-13	-44.73	-69.88	-63.16	1.85	9.43	H
	2512	-34.75	-13	-21.75	-51.48	-41.13	2.27	10.80	H
	3345.6	-57.53	-13	-44.53	-76.11	-65.39	2.65	12.66	H
									H
									H
									H
	1672	-57.61	-13	-44.61	-70.23	-63.04	1.85	9.43	V
	2512	-37.06	-13	-24.06	-53.91	-43.44	2.27	10.80	V
	3345.6	-57.33	-13	-44.33	-76.3	-65.19	2.65	12.66	V
									V
									V
									V



Highest	1696	-62.03	-13	-49.03	-74.37	-67.60	1.86	9.58	H
	2544	-51.57	-13	-38.57	-68.17	-57.94	2.28	10.80	H
	3395.2	-58.18	-13	-45.18	-76.64	-65.97	2.67	12.61	H
									H
									H
									H
	1696	-61.73	-13	-48.73	-74.55	-67.30	1.86	9.58	V
	2544	-50.49	-13	-37.49	-67.41	-56.86	2.28	10.80	V
	3395.2	-57.69	-13	-44.69	-76.53	-65.48	2.67	12.61	V
									V
									V
									V

Remark: Spurious emissions within 30-1000MHz were found more than 20dB below limit line.



EDGE 850

EDGE 850										
Channel	Frequency (MHz)	ERP (dBm)	Limit (dBm)	Over Limit (dB)	SPA Reading (dBm)	S.G. Power (dBm)	TX Cable loss (dB)	TX Antenna Gain (dBi)	Polarization (H/V)	
Lowest	1648	-56.65	-13	-43.65	-68.62	-61.95	1.83	9.28	H	
	2472	-36.50	-13	-23.50	-53.08	-42.73	2.25	10.63	H	
	3296	-61.14	-13	-48.14	-79.84	-68.65	2.62	12.28	H	
	4120	-51.43	-13	-38.43	-72.89	-59.08	2.90	12.70	H	
										H
										H
										H
	1648	-55.40	-13	-42.40	-67.83	-60.70	1.83	9.28	V	
	2472	-39.41	-13	-26.41	-56.22	-45.64	2.25	10.63	V	
	3296	-60.85	-13	-47.85	-79.96	-68.36	2.62	12.28	V	
	4120	-52.40	-13	-39.40	-74.39	-60.05	2.90	12.70	V	
										V
										V
										V
Middle	1672	-63.70	-13	-50.70	-75.85	-69.13	1.85	9.43	H	
	2512	-41.51	-13	-28.51	-58.24	-47.89	2.27	10.80	H	
	3345	-61.06	-13	-48.06	-79.64	-68.92	2.65	12.66	H	
	4184	-56.20	-13	-43.20	-77.86	-63.81	2.94	12.70	H	
										H
										H
										H
	1672	-61.59	-13	-48.59	-74.21	-67.02	1.85	9.43	V	
	2512	-44.72	-13	-31.72	-61.57	-51.10	2.27	10.80	V	
	3345	-60.79	-13	-47.79	-79.76	-68.65	2.65	12.66	V	
	4184	-57.36	-13	-44.36	-79.6	-64.97	2.94	12.70	V	
										V
										V
										V



Highest	1760	-63.22	-13	-50.22	-76.04	-69.07	1.90	9.90	H
	2544	-38.26	-13	-25.26	-54.86	-44.63	2.28	10.80	H
	3395	-61.36	-13	-48.36	-79.82	-69.15	2.67	12.61	H
	4240	-46.80	-13	-33.80	-68.61	-54.39	2.96	12.70	H
	5092	-57.19	-13	-44.19	-81.24	-64.05	3.30	12.32	H
	5944	-50.85	-13	-37.85	-76.2	-58.34	3.56	13.20	H
									H
	1679	-63.81	-13	-50.81	-76.63	-69.28	1.85	9.47	V
	2544	-41.49	-13	-28.49	-58.41	-47.86	2.28	10.80	V
	3395	-61.13	-13	-48.13	-79.97	-68.92	2.67	12.61	V
	4240	-50.26	-13	-37.26	-72.67	-57.85	2.96	12.70	V
	6092	-56.41	-13	-43.41	-81.05	-63.94	3.60	13.28	V
	5941	-55.03	-13	-42.03	-80.81	-62.52	3.56	13.20	V
									V

Remark: Spurious emissions within 30-1000MHz were found more than 20dB below limit line.



GPRS 1900

GPRS 1900									
Channel	Frequency (MHz)	EIRP (dBm)	Limit (dBm)	Over Limit (dB)	SPA Reading (dBm)	S.G. Power (dBm)	TX Cable loss (dB)	TX Antenna Gain (dBi)	Polarization (H/V)
Lowest	3700.4	-55.46	-13	-42.46	-76.33	-65.09	2.77	12.40	H
	5550.6	-51.66	-13	-38.66	-76.7	-61.60	3.46	13.40	H
	7400.8	-46.91	-13	-33.91	-76.43	-54.13	3.98	11.20	H
									H
									H
									H
									H
	3700.4	-55.18	-13	-42.18	-76.46	-64.81	2.77	12.40	V
	5550.6	-51.96	-13	-38.96	-77.06	-61.90	3.46	13.40	V
	7400.8	-46.53	-13	-33.53	-76.53	-53.75	3.98	11.20	V
									V
									V
									V
									V
Middle	3760	-55.30	-13	-42.30	-76.39	-65.00	2.78	12.48	H
	5640	-52.40	-13	-39.40	-77.41	-62.38	3.48	13.46	H
	7520	-47.66	-13	-34.66	-77.08	-54.85	4.01	11.20	H
									H
									H
									H
									H
	3760	-55.01	-13	-42.01	-76.49	-64.71	2.78	12.48	V
	5640	-52.40	-13	-39.40	-77.64	-62.38	3.48	13.46	V
	7520	-46.76	-13	-33.76	-76.57	-53.95	4.01	11.20	V
									V
									V
									V
									V



Highest	3819.6	-55.78	-13	-42.78	-77.01	-65.35	2.80	12.36	H
	5729.4	-52.07	-13	-39.07	-77.56	-61.97	3.50	13.40	H
	7639.2	-47.28	-13	-34.28	-76.35	-54.71	4.05	11.48	H
									H
									H
									H
									H
	3819.6	-55.36	-13	-42.36	-76.98	-64.93	2.80	12.36	V
	5729.4	-52.00	-13	-39.00	-77.72	-61.90	3.50	13.40	V
	7639.2	-46.44	-13	-33.44	-76.05	-53.87	4.05	11.48	V
									V
									V
									V
									V

Remark: Spurious emissions within 30-1000MHz were found more than 20dB below limit line.



EDGE 1900

EDGE 1900									
Channel	Frequency (MHz)	EIRP (dBm)	Limit (dBm)	Over Limit (dB)	SPA Reading (dBm)	S.G. Power (dBm)	TX Cable loss (dB)	TX Antenna Gain (dBi)	Polarization (H/V)
Lowest	3700.4	-55.41	-13	-42.41	-76.28	-65.04	2.77	12.40	H
	5550.6	-51.91	-13	-38.91	-76.95	-61.85	3.46	13.40	H
	7400.8	-46.91	-13	-33.91	-76.43	-54.13	3.98	11.20	H
									H
									H
									H
									H
	3700.4	-55.10	-13	-42.10	-76.38	-64.73	2.77	12.40	V
	5550.6	-52.06	-13	-39.06	-77.16	-62.00	3.46	13.40	V
	7400.8	-46.58	-13	-33.58	-76.58	-53.80	3.98	11.20	V
									V
									V
									V
									V
Middle	3760	-55.58	-13	-42.58	-76.67	-65.28	2.78	12.48	H
	5640	-52.62	-13	-39.62	-77.63	-62.60	3.48	13.46	H
	7520	-47.33	-13	-34.33	-76.75	-54.52	4.01	11.20	H
									H
									H
									H
									H
	3760	-55.04	-13	-42.04	-76.52	-64.74	2.78	12.48	V
	5640	-52.27	-13	-39.27	-77.51	-62.25	3.48	13.46	V
	7520	-46.72	-13	-33.72	-76.53	-53.91	4.01	11.20	V
									V
									V
									V
									V



Highest	3819.6	-55.57	-13	-42.57	-76.8	-65.14	2.80	12.36	H
	5729.4	-52.04	-13	-39.04	-77.53	-61.94	3.50	13.40	H
	7639.2	-46.96	-13	-33.96	-76.03	-54.39	4.05	11.48	H
									H
									H
									H
									H
	3819.6	-55.16	-13	-42.16	-76.78	-64.73	2.80	12.36	V
	5729.4	-51.78	-13	-38.78	-77.5	-61.68	3.50	13.40	V
	7639.2	-46.46	-13	-33.46	-76.07	-53.89	4.05	11.48	V
									V
									V
									V
									V

Remark: Spurious emissions within 30-1000MHz were found more than 20dB below limit line.



WCDMA 1900

WCDMA 1900									
Channel	Frequency (MHz)	EIRP (dBm)	Limit (dBm)	Over Limit (dB)	SPA Reading (dBm)	S.G. Power (dBm)	TX Cable loss (dB)	TX Antenna Gain (dBi)	Polarization (H/V)
Lowest	3704.8	-55.51	-13	-42.51	-76.41	-65.15	2.77	12.41	H
	5557.2	-51.74	-13	-38.74	-76.75	-61.66	3.46	13.39	H
	7409.6	-46.91	-13	-33.91	-76.43	-54.09	3.98	11.16	H
									H
									H
									H
									H
	3704.8	-55.21	-13	-42.21	-76.52	-64.85	2.77	12.41	V
	5557.2	-51.76	-13	-38.76	-76.85	-61.68	3.46	13.39	V
	7409.6	-46.47	-13	-33.47	-76.45	-53.65	3.98	11.16	V
									V
									V
									V
									V
Middle	3760	-55.20	-13	-42.20	-76.29	-64.90	2.78	12.48	H
	5640	-52.32	-13	-39.32	-77.33	-62.30	3.48	13.46	H
	7520	-47.46	-13	-34.46	-76.88	-54.65	4.01	11.20	H
									H
									H
									H
									H
	3760	-55.11	-13	-42.11	-76.59	-64.81	2.78	12.48	V
	5640	-52.26	-13	-39.26	-77.5	-62.24	3.48	13.46	V
	7520	-47.19	-13	-34.19	-77	-54.38	4.01	11.20	V
									V
									V
									V
									V



Highest	3819	-55.55	-13	-42.55	-76.78	-65.12	2.80	12.36	H
	5726	-52.23	-13	-39.23	-77.71	-62.13	3.50	13.40	H
	7635	-47.29	-13	-34.29	-76.36	-54.71	4.05	11.47	H
									H
									H
									H
									H
	3819	-55.04	-13	-42.04	-76.66	-64.61	2.80	12.36	V
	5726	-52.02	-13	-39.02	-77.73	-61.92	3.50	13.40	V
	7635	-46.43	-13	-33.43	-76.04	-53.85	4.05	11.47	V
									V
									V
									V
									V

Remark: Spurious emissions within 30-1000MHz were found more than 20dB below limit line.



WCDMA 1700

WCDMA 1700									
Channel	Frequency (MHz)	EIRP (dBm)	Limit (dBm)	Over Limit (dB)	SPA Reading (dBm)	S.G. Power (dBm)	TX Cable loss (dB)	TX Antenna Gain (dBi)	Polarization (H/V)
Lowest	3424.8	-57.41	-13	-44.41	-76.8	-67.33	2.68	12.60	H
	5137.2	-53.14	-13	-40.14	-77.5	-62.27	3.32	12.45	H
	6849.6	-49.11	-13	-36.11	-77.19	-57.65	3.86	12.40	H
									H
									H
									H
									H
	3424.8	-56.80	-13	-43.80	-76.64	-66.72	2.68	12.60	V
	5137.2	-52.49	-13	-39.49	-77.4	-61.62	3.32	12.45	V
	6849.6	-48.52	-13	-35.52	-76.95	-57.06	3.86	12.40	V
									V
									V
									V
									V
Middle	3465.2	-56.90	-13	-43.90	-76.74	-66.74	2.70	12.54	H
	5197.8	-53.02	-13	-40.02	-77.6	-62.46	3.34	12.78	H
	6930.4	-47.62	-13	-34.62	-75.94	-55.73	3.89	12.00	H
									H
									H
									H
									H
	3465.2	-56.28	-13	-43.28	-76.49	-66.12	2.70	12.54	V
	5197.8	-52.23	-13	-39.23	-77.31	-61.67	3.34	12.78	V
	6930.4	-47.47	-13	-34.47	-75.87	-55.58	3.89	12.00	V
									V
									V
									V
									V



Highest	3505.2	-56.49	-13	-43.49	-76.66	-66.15	2.72	12.38	H
	5257.8	-52.68	-13	-39.68	-77.3	-62.55	3.36	13.23	H
	7010.4	-47.50	-13	-34.50	-76.03	-55.43	3.91	11.84	H
									H
									H
									H
									H
	3505.2	-56.21	-13	-43.21	-76.75	-65.87	2.72	12.38	V
	5555	-52.38	-13	-39.38	-77.4	-62.31	3.46	13.39	V
	7010.4	-47.63	-13	-34.63	-76.05	-55.56	3.91	11.84	V
									V
									V
									V
									V

Remark: Spurious emissions within 30-1000MHz were found more than 20dB below limit line.

————THE END————