



FCC RADIO TEST REPORT

FCC ID : PY7-53953L
Equipment : GSM/WCDMA/LTE/5G Phone with BT, DTS/UNII a/b/g/n/ac/ax, GPS and NFC
Brand Name : Sony
Applicant : Sony Corporation
1-7-1 Konan Minato-ku Tokyo, 108-0075 Japan
Manufacturer : Sony Corporation
1-7-1 Konan Minato-ku Tokyo, 108-0075 Japan
Standard : FCC Part 15 Subpart C §15.225

The product was received on May 11, 2021 and testing was started from Jun. 07, 2021 and completed on Jun. 08, 2021. We, Sporton International Inc. Wensan Laboratory, would like to declare that the tested sample has been evaluated in accordance with the test procedures and has been in compliance with the applicable technical standards.

The test results in this spot check data report apply exclusively to the tested model / sample. Without written approval of Sporton International Inc. Wensan Laboratory, the test report shall not be reproduced except in full.

Reviewed by: Louis Wu

Sporton International Inc. Wensan Laboratory

No.58, Aly. 75, Ln. 564, Wenhua 3rd, Rd., Guishan Dist., Taoyuan City 333010, Taiwan (R.O.C.)



Table of Contents

| | |
|---|-----------|
| History of this test report | 3 |
| Summary of Test Result | 4 |
| 1. General Description | 5 |
| 1.1 Product Feature of Equipment Under Test | 5 |
| 1.2 Modification of EUT | 5 |
| 1.3 Testing Location | 6 |
| 1.4 Applicable Standards..... | 6 |
| 2. Test Configuration of Equipment Under Test | 7 |
| 2.1 Descriptions of Test Mode | 7 |
| 2.2 Connection Diagram of Test System | 7 |
| 2.3 Table for Supporting Units | 8 |
| 2.4 EUT Operation Test Setup | 8 |
| 3. Test Results | 9 |
| 3.1 Field Strength of Fundamental Emissions and Mask Measurement..... | 9 |
| 3.2 Radiated Emissions Measurement | 11 |
| 3.3 Antenna Requirements..... | 14 |
| 4. List of Measuring Equipment | 15 |
| 5. Uncertainty of Evaluation | 16 |
| Appendix A. Test Results of Radiated Test Items | |
| A1. Test Result of Field Strength of Fundamental Emissions | |
| A2. Results of Radiated Emissions (9 kHz~30MHz) | |
| A3. Results of Radiated Emissions (30MHz~1GHz) | |



History of this test report

| Report No. | Version | Description | Issued Date |
|------------|---------|-------------------------|---------------|
| FR133144D | 01 | Initial issue of report | Jun. 11, 2021 |
| | | | |
| | | | |
| | | | |
| | | | |
| | | | |
| | | | |
| | | | |
| | | | |
| | | | |
| | | | |
| | | | |
| | | | |
| | | | |
| | | | |
| | | | |
| | | | |
| | | | |
| | | | |



Summary of Test Result

| Report Clause | Ref Std. Clause | Test Items | Result (PASS/FAIL) | Remark |
|---------------|---------------------|---|--------------------|--|
| - | 15.207 | AC Power Line Conducted Emissions | - | See Note |
| - | 15.215(c) | 20dB Spectrum Bandwidth | - | See Note |
| | 2.1049 | 99% OBW Spectrum Bandwidth | - | See Note |
| - | 15.225(e) | Frequency Stability | - | See Note |
| 3.1 | 15.225(a)(b)(c) | Field Strength of Fundamental Emissions | Pass | Max level 21.25 dB μ V/m at 13.560 MHz |
| 3.2 | 15.225(d) 15.209 | Radiated Spurious Emissions | Pass | Under limit 7.49 dB at 45.520MHz |
| 3.3 | 15.203 | Antenna Requirements | Pass | - |

Note: The RF circuit, output power level and antenna performance is the same in NFC function across all two FCC ID PY7-53953L and PY7-38061M, since the change, only verify radiated spurious emission test data the worst mode was reported in this report.

| |
|--|
| Declaration of Conformity: |
| The test results with all measurement uncertainty excluded are presented in accordance with the regulation limits or requirements declared by manufacturers. |
| Comments and Explanations: |
| The declared of product specification for EUT presented in the report are provided by the manufacturer, and the manufacturer takes all the responsibilities for the accuracy of product specification. |

Reviewed by: Keven Cheng

Report Producer: Lucy Wu



1. General Description

1.1 Product Feature of Equipment Under Test

GSM/WCDMA/LTE, Bluetooth, DTS/UNII a/b/g/n/ac/ax, NFC, FM Receiver, and GNSS.

| Product Specification subjective to this standard | |
|---|--------------|
| Antenna Type | Loop Antenna |

Remark: The above EUT's information was declared by manufacturer. Please refer to Comments and Explanations in report summary.

| EUT Information List | | | |
|----------------------|------------|------------|----------------------------|
| HW Version | SW Version | S/N | Performed Test Item |
| A | 0.617 | QV7200GQ7P | Radiated Spurious Emission |

| Accessory List | |
|----------------|----------------------|
| AC Adapter | Model Name : XQZ-UC1 |
| | S/N : 0020W51300024 |
| Earphone | Model Name : STH40D |
| | S/N : N/A |
| USB Cable | Model Name : XQZ-UB1 |
| | S/N : N/A |

Note:

- Above EUT list used are electrically identical per declared by manufacturer.
- Above the accessories list are used to exercise the EUT during test, and the serial number of each type of accessories is listed in each section of this report.
- For other wireless features of this EUT, test report will be issued separately.

1.2 Modification of EUT

No modifications are made to the EUT during all test items.



1.3 Testing Location

| | |
|--------------------|--|
| Test Site | Sporton International Inc. Wensan Laboratory |
| Test Site Location | No.58, Aly. 75, Ln. 564, Wenhua 3rd, Rd., Guishan Dist., Taoyuan City 333010, Taiwan (R.O.C.) TEL: +886-3-327-0868 FAX: +886-3-327-0855 |
| Test Site No. | Sporton Site No. 03CH11-HY |
| Test Engineer | Harvey Guo |
| Temperature | 20.6~21.2°C |
| Relative Humidity | 58.3~68.9% |

Note: The test site complies with ANSI C63.4 2014 requirement.

FCC designation No.: TW3786

1.4 Applicable Standards

According to the specifications of the manufacturer, the EUT must comply with the requirements of the following standards:

- ♦ FCC Part 15 Subpart C §15.225
- ♦ FCC KDB 414788 D01 Radiated Test Site v01r01
- ♦ ANSI C63.10-2013

Remark:

1. All test items were verified and recorded according to the standards and without any deviation during the test.
2. The TAF code is not including all the FCC KDB listed without accreditation.
3. This EUT has also been tested and complied with the requirements of FCC Part 15, Subpart B, recorded in a separate test report.

2. Test Configuration of Equipment Under Test

2.1 Descriptions of Test Mode

Investigation has been done on all the possible configurations.

The following table is a list of the test modes shown in this test report.

| Test Items |
|---|
| Field Strength of Fundamental Emissions |
| Radiated Emissions 9kHz~30MHz |
| Radiated Emissions 30MHz~1GHz |

The EUT pre-scanned in four NFC type, A, B, F, V. The worst type (type F) was recorded in this report. Pre-scanned tests, X, Y, Z in three orthogonal panels to determine the final configuration (Y plane as worst plane) from all possible combinations.

2.2 Connection Diagram of Test System

<For Radiated Emissions Measurement with NFC Card>

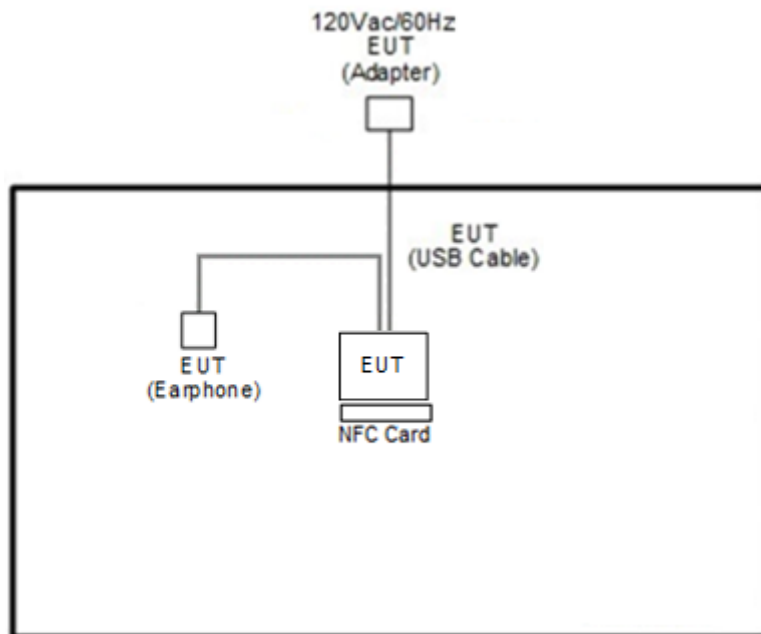



2.3 Table for Supporting Units

| Item | Equipment | Brand Name | Model Name | FCC ID | Data Cable | Power Cord |
|------|-----------|------------|------------|--------|------------|------------|
| 1. | NFC Card | N/A | N/A | N/A | N/A | N/A |

2.4 EUT Operation Test Setup

The EUT was programmed to be in continuously transmitting mode.

The ancillary equipment, NFC card, is used to make the EUT (NFC) continuously transmitting signal (Power Level: Default) at 13.56MHz and is placed around 1 cm gap to the EUT.



3. Test Results

3.1 Field Strength of Fundamental Emissions and Mask Measurement

3.1.1 Limit

| Rules and specifications | FCC CFR 47 Part 15 section 15.225 | | | |
|--------------------------|---|--------------------------------|--------------------------------|-------------------------------|
| Description | Compliance with the spectrum mask is tested with RBW set to 9kHz. | | | |
| Freq. of Emission (MHz) | Field Strength (μV/m) at 30m | Field Strength (dBμV/m) at 30m | Field Strength (dBμV/m) at 10m | Field Strength (dBμV/m) at 3m |
| 1.705~13.110 | 30 | 29.5 | 48.58 | 69.5 |
| 13.110~13.410 | 106 | 40.5 | 59.58 | 80.5 |
| 13.410~13.553 | 334 | 50.5 | 69.58 | 90.5 |
| 13.553~13.567 | 15848 | 84.0 | 103.08 | 124.0 |
| 13.567~13.710 | 334 | 50.5 | 69.58 | 90.5 |
| 13.710~14.010 | 106 | 40.5 | 59.58 | 80.5 |
| 14.010~30.000 | 30 | 29.5 | 48.58 | 69.5 |

Remark:

- 1. The field strength test result is in 3m test distance, follow test rules the test data use distance extrapolation factor and reported in this report at 30m test result.
- 2. Distance extrapolation factor = $40 \log(\text{specific distance} / \text{test distance})$ (dB)

3.1.2 Measuring Instruments

See list of measuring instruments of this test report.

3.1.3 Test Procedures

1. Configure the EUT according to ANSI C63.10. The EUT was placed on the top of the turntable 0.8 meter above ground. The phase center of the loop receiving antenna mounted antenna tower was placed 3 meters far away from the turntable.
 2. Power on the EUT and all the supporting units. The turntable was rotated by 360 degrees to determine the position of the highest radiation.
 3. The height of the receiving antenna was fixed at one meter above ground to find the maximum emissions field strength.
 4. For Fundamental emissions, use the receiver to measure QP reading.
 5. When the radiated emissions limits are expressed in terms of the average value of the emissions, and pulsed operation is employed, the measurement field strength shall be determined by averaging over one complete pulse train, including blanking intervals, as long as the pulse train does not exceed 0.1 seconds. As an alternative (provided the transmitter operates for longer than 0.1 seconds) or in cases where the pulse train exceeds 0.1 seconds, the measured field strength shall be determined from the average absolute voltage during a 0.1 second interval during which the field strength is at its maximum value.
 6. Compliance with the spectrum mask is tested with RBW set to 9 kHz.
- Note: Emission level (dB μ V/m) = 20 log Emission level (μ V/m).

3.1.4 Test Setup

For radiated test below 30MHz

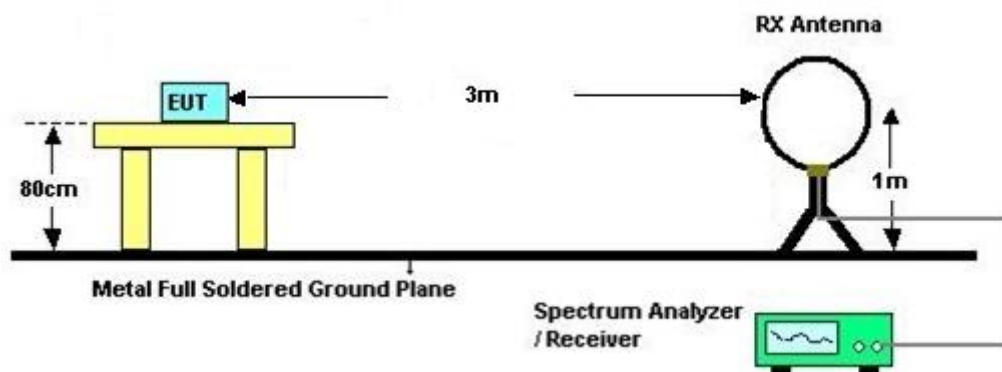

3.1.5 Test Result of Field Strength of Fundamental Emissions and Mask

Please refer to Appendix A.



3.2 Radiated Emissions Measurement

3.2.1 Limit

The field strength of any emissions which appear outside of 13.110 ~14.010MHz band shall not exceed the general radiated emissions limits.

| Frequencies (MHz) | Field Strength (µV/m) | Measurement Distance (meters) |
|-------------------|-----------------------|-------------------------------|
| 0.009~0.490 | 2400/F(kHz) | 300 |
| 0.490~1.705 | 24000/F(kHz) | 30 |
| 1.705~30.0 | 30 | 30 |
| 30~88 | 100 | 3 |
| 88~216 | 150 | 3 |
| 216~960 | 200 | 3 |
| Above 960 | 500 | 3 |

3.2.2 Measuring Instruments

See list of measuring instruments of this test report.

3.2.3 Measuring Instrument Setting

The following table is the setting of receiver:

| Receiver Parameter | Setting |
|--------------------------------|---------------------|
| Attenuation | Auto |
| Frequency Range: 9kHz~150kHz | RBW 200Hz for QP |
| Frequency Range: 150kHz~30MHz | RBW 9kHz for QP |
| Frequency Range: 30MHz~1000MHz | RBW 120kHz for Peak |

Note: The emission limits shown in the above table are based on measurements employing a CISPR quasi-peak detector except for the frequency bands 9-90 kHz and 110-490 kHz. Radiated emission limits in these two bands are based on measurements employing an average detector.



3.2.4 Test Procedures

1. Configure the EUT according to ANSI C63.10. The EUT was placed on the top of the turntable 0.8 meter above ground. The phase center of the receiving antenna mounted on the top of a height-variable antenna tower was placed 3 meters far away from the turntable.
2. Power on the EUT and all the supporting units. The turntable was rotated by 360 degrees to determine the position of the highest radiation.
3. The height of the broadband receiving antenna was varied between one meter and four meters above ground to find the maximum emissions field strength of both horizontal and vertical polarization.
4. For each suspected emissions, the antenna tower was scan (from 1 M to 4 M) and then the turntable was rotated (from 0 degree to 360 degrees) to find the maximum reading.
5. Set the test-receiver system to Peak or CISPR quasi-peak Detect Function with specified bandwidth under Maximum Hold Mode.
6. When the radiated emissions limits are expressed in terms of the average value of the emissions, and pulsed operation is employed, the measurement field strength shall be determined by averaging over one complete pulse train, including blanking intervals, as long as the pulse train does not exceed 0.1 seconds. As an alternative (provided the transmitter operates for longer than 0.1 seconds) or in cases where the pulse train exceeds 0.1 seconds, the measured field strength shall be determined from the average absolute voltage during a 0.1 second interval during which the field strength is at its maximum value.
7. In case the emission is lower than 30 MHz, loop antenna has to be used for measurement and the recorded data shall be QP measured by receiver.

3.2.5 Test Setup

For radiated test below 30MHz

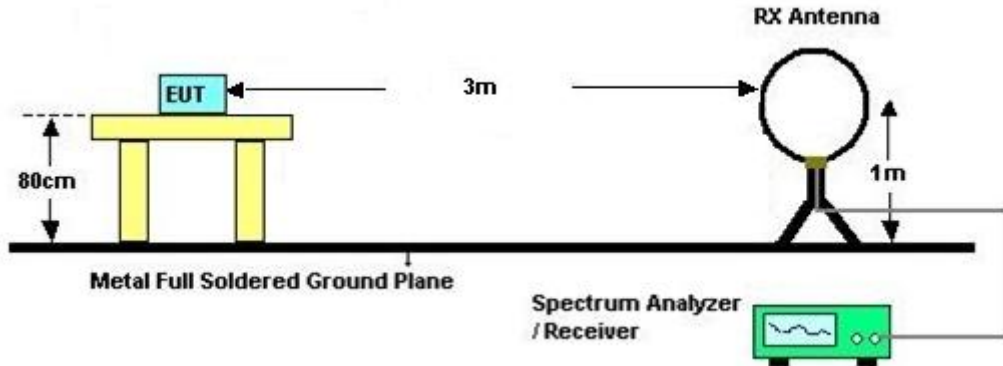

For radiated test above 30MHz

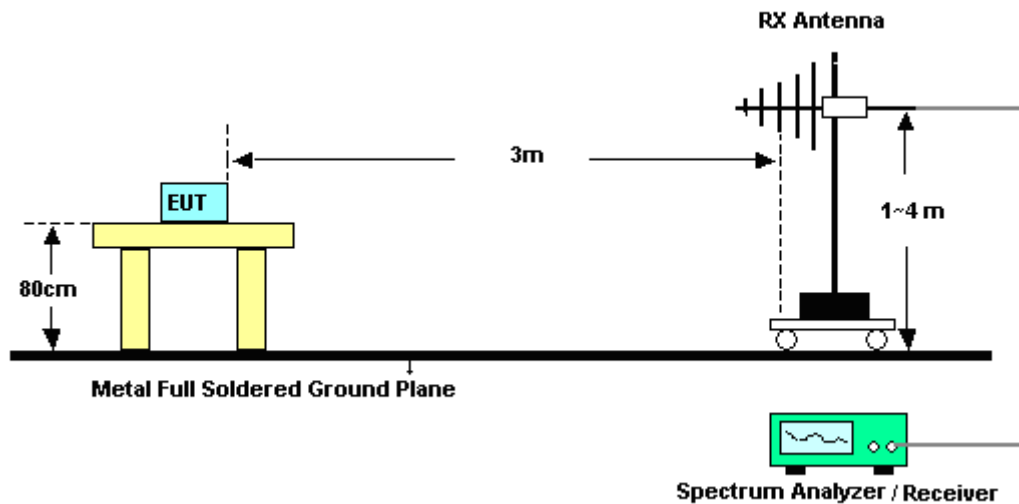

3.2.6 Test Result of Radiated Emissions Measurement

Please refer to Appendix A.

Remark:

1. There is adequate comparison measurement of both open-field test site and alternative test site - semi-Anechoic chamber according to 414788 D01 Radiated Test Site v01r01, and the result came out very similar.
2. According to C63.10 radiated Test, the EUT pre-scanned horizontal, vertical, and ground-parallel three polarization's, the worst case is horizontal & vertical polarization, test data of two mode was reported.



3.3 Antenna Requirements

3.3.1 Standard Applicable

Except for special regulations, the Low-power Radio-frequency Devices must not be equipped with any jacket for installing an antenna with extension cable. An intentional radiator shall be designed to ensure that no antenna other than that furnished by the responsible party shall be used with the device. The use of a permanently attached antenna or of an antenna that uses a unique coupling to the intentional radiator shall be considered sufficient to comply with the provisions of this Section. The manufacturer may design the unit so that the user can replace a broken antenna, but the use of a standard antenna jack or electrical connector is prohibited.

The use of a permanently attached antenna or of an antenna that uses a unique coupling to the intentional radiator shall be considered sufficient to comply with the rule.

3.3.2 Antenna Anti-Replacement Construction

An embedded-in antenna design is used.



4. List of Measuring Equipment

| Instrument | Brand Name | Model No. | Serial No. | Characteristics | Calibration Date | Test Date | Due Date | Remark |
|-------------------|--------------------|----------------------------------|---------------------|----------------------------|------------------|---------------------------------|---------------|--------------------------|
| Amplifier | SONOMA | 310N | 187312 | 9kHz~1GHz | Dec. 02, 2020 | Jun. 07, 2021~ Jun. 08, 2021 | Dec. 01, 2021 | Radiation (03CH11-HY) |
| Bilog Antenna | TESEQ | CBL 6111D & N-6-06 | 35414 & AT-N0602 | 30MHz~1GHz | Oct. 11, 2020 | Jun. 07, 2021~ Jun. 08, 2021 | Oct. 10, 2021 | Radiation (03CH11-HY) |
| Hygrometer | TECPEL | DTM-303B | TP140325 | N/A | Nov. 18, 2020 | Jun. 07, 2021~ Jun. 08, 2021 | Nov. 17, 2021 | Radiation (03CH11-HY) |
| Loop Antenna | Rohde & Schwarz | HFH2-Z2 | 100488 | 9 kHz~30 MHz | Jul. 14, 2020 | Jun. 07, 2021~ Jun. 08, 2021 | Jul. 13, 2021 | Radiation (03CH11-HY) |
| Filter | Wainwright | WHK20/1000 C7/40SS | SN2 | 20MHz High Pass Filter | Sep. 14, 2020 | Jun. 07, 2021~ Jun. 08, 2021 | Sep. 13, 2021 | Radiation (03CH11-HY) |
| Filter | Wainwright | WLK4-1000-1 530-8000-40S S | SN11 | 1.53GHz Low Pass Filter | Sep. 14, 2020 | Jun. 07, 2021~ Jun. 08, 2021 | Sep. 13, 2021 | Radiation (03CH11-HY) |
| RF Cable | HUBER + SUHNER | SUCOFLEX 104 | MY9837/4 PE | 9kHz~30MHz | Mar. 11, 2021 | Jun. 07, 2021~ Jun. 08, 2021 | Mar. 10, 2022 | Radiation (03CH11-HY) |
| RF Cable | HUBER + SUHNER | SUCOFLEX 102 | MY2859/2 | 30MHz~40GHz | Mar. 11, 2021 | Jun. 07, 2021~ Jun. 08, 2021 | Mar. 10, 2022 | Radiation (03CH11-HY) |
| RF Cable | HUBER + SUHNER | SUCOFLEX 104 | MY9837/4 PE | 30MHz~18GHz | Mar. 11, 2021 | Jun. 07, 2021~ Jun. 08, 2021 | Mar. 10, 2022 | Radiation (03CH11-HY) |
| Software | Audix | E3 6.2009-8-24 | RK-00105 3 | N/A | N/A | Jun. 07, 2021~ Jun. 08, 2021 | N/A | Radiation (03CH11-HY) |
| Antenna Mast | EMEC | AM-BS-4500- B | N/A | 1~4m | N/A | Jun. 07, 2021~ Jun. 08, 2021 | N/A | Radiation (03CH11-HY) |
| Turn Table | EMEC | TT 2000 | N/A | 0~360 Degree | N/A | Jun. 07, 2021~ Jun. 08, 2021 | N/A | Radiation (03CH11-HY) |
| EMI Test Receiver | Keysight | N9038A(MXE) | MY541300 85 | 20MHz~8.4GHz | Nov. 02, 2020 | Jun. 07, 2021~ Jun. 08, 2021 | Nov. 01, 2021 | Radiation (03CH11-HY) |



5. Uncertainty of Evaluation

Uncertainty of Radiated Emission Measurement (9 kHz ~ 30 MHz)

| | |
|---|-------|
| Measuring Uncertainty for a Level of Confidence of 95% ($U = 2Uc(y)$) | 3.4dB |
|---|-------|

Uncertainty of Radiated Emission Measurement (30 MHz ~ 1000 MHz)

| | |
|---|-------|
| Measuring Uncertainty for a Level of Confidence of 95% ($U = 2Uc(y)$) | 4.4dB |
|---|-------|



Appendix A. Test Results of Radiated Test Items

A1. Test Result of Field Strength of Fundamental Emissions

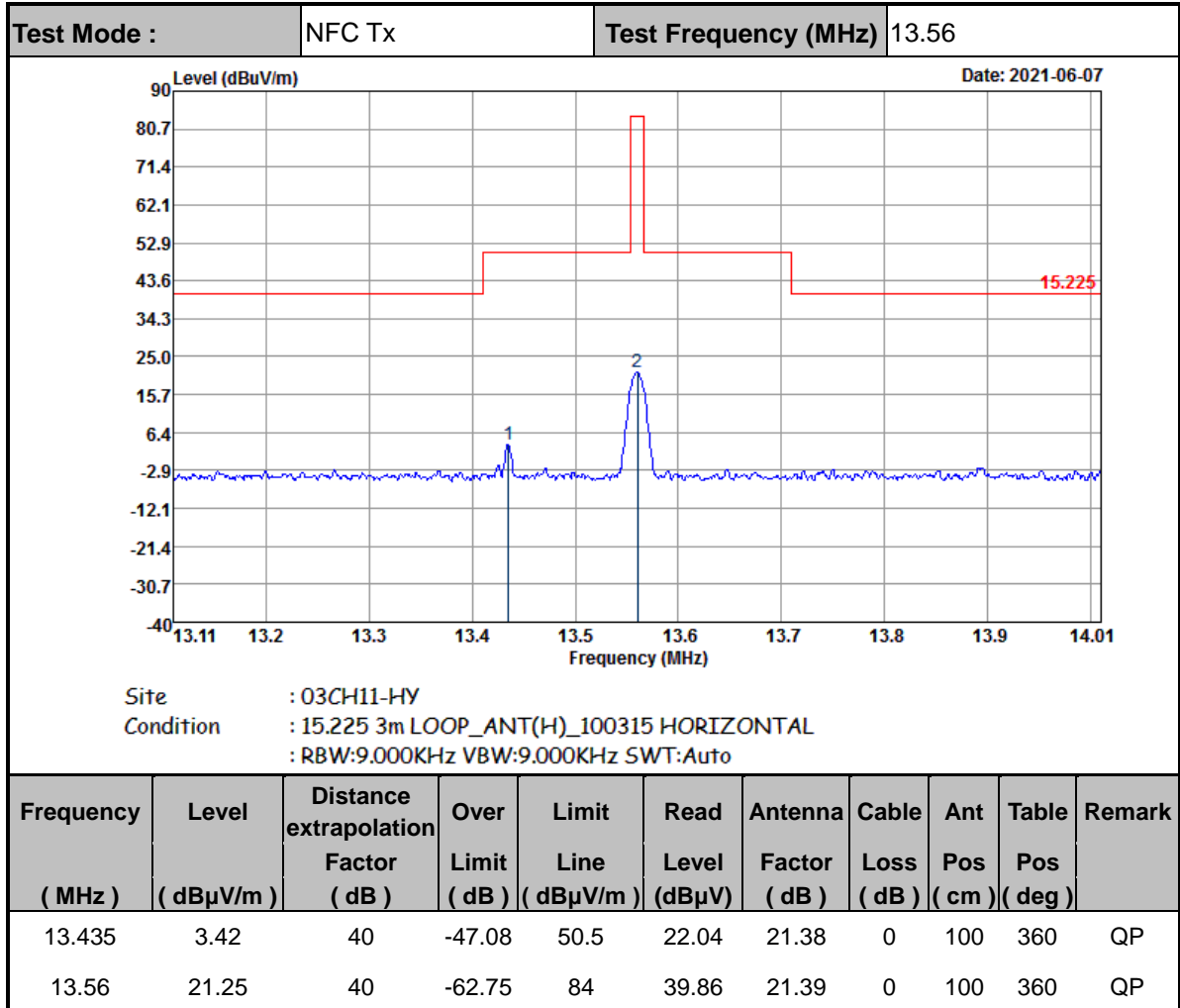

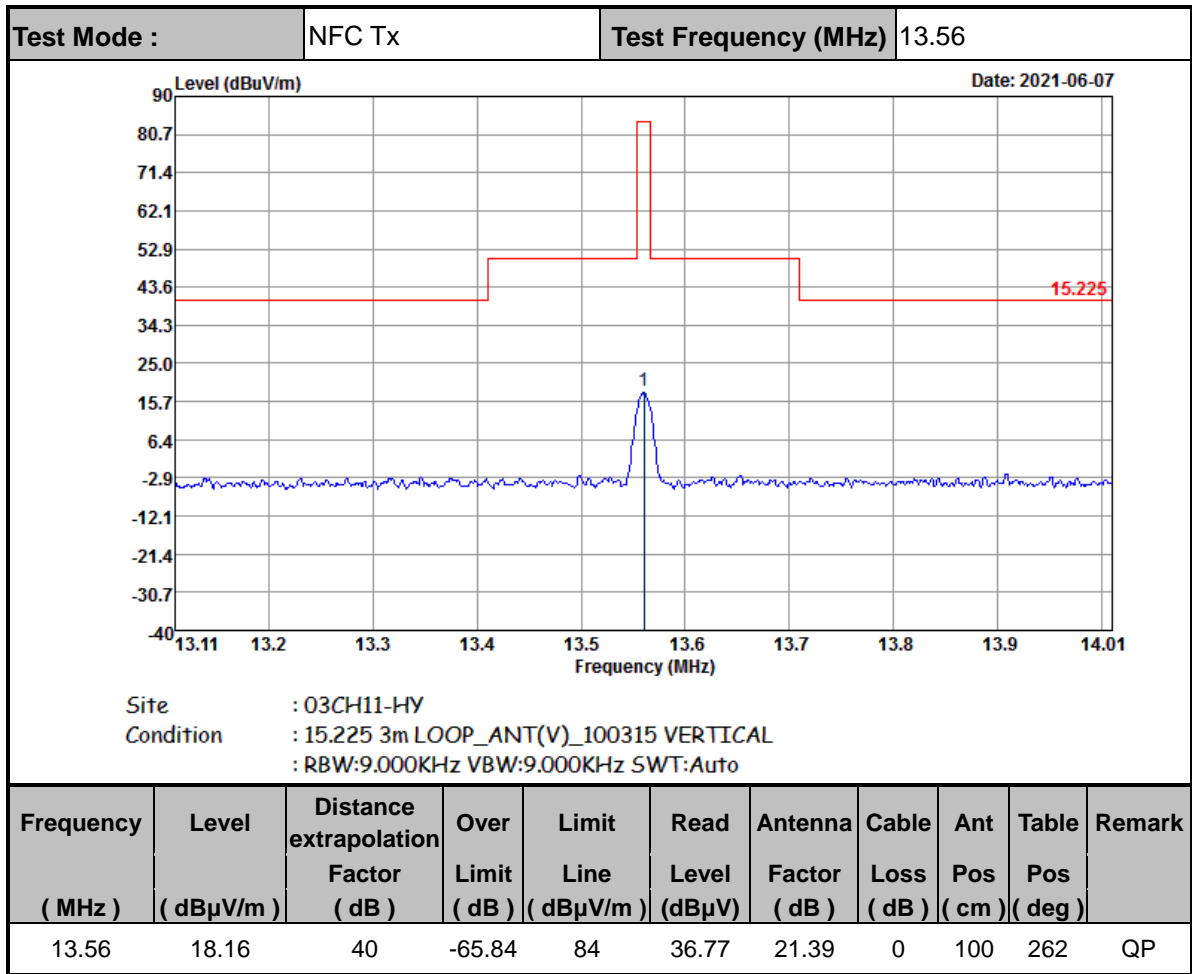



A2. Results of Radiated Spurious Emissions (9 kHz~30MHz)

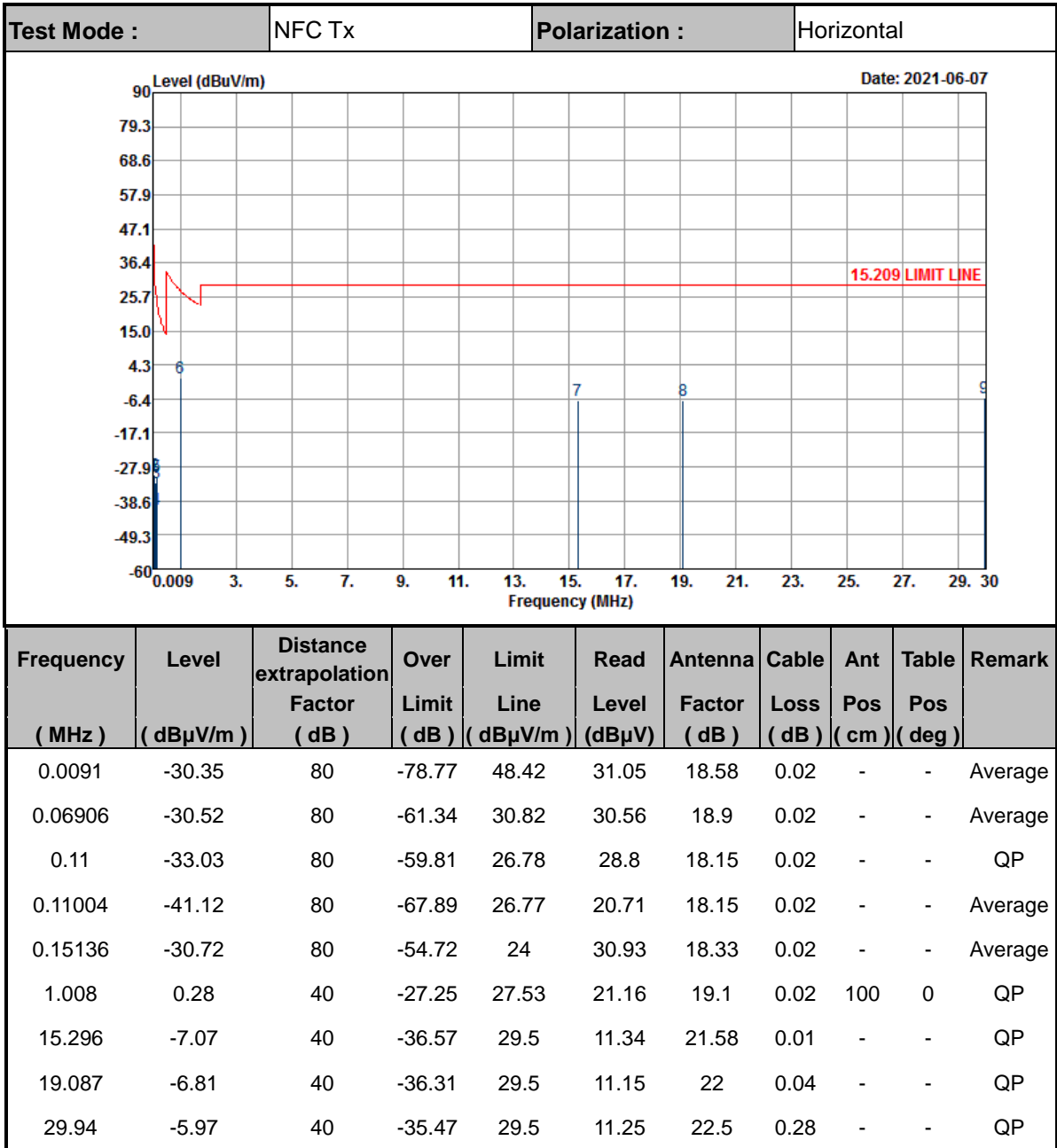

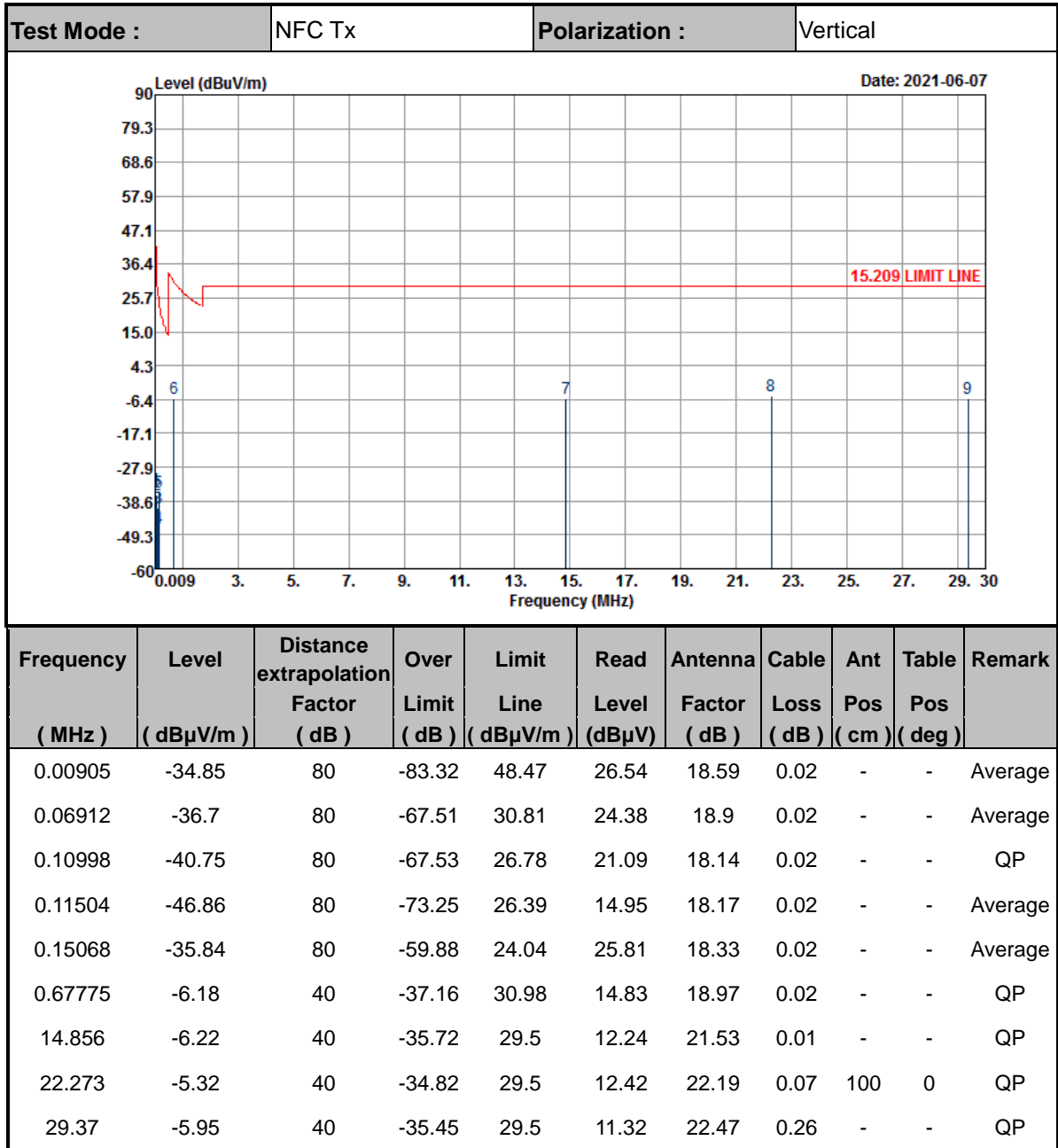

Note:

1. The amplitude of spurious emissions which are attenuated by more than 20dB below the permissible value has no need to be reported.
2. Distance extrapolation factor = 40 log (specific distance / test distance) (dB)
3. Limit line = specific limits (dBμV) + distance extrapolation factor



A3. Results of Radiated Spurious Emissions (30MHz~1GHz)

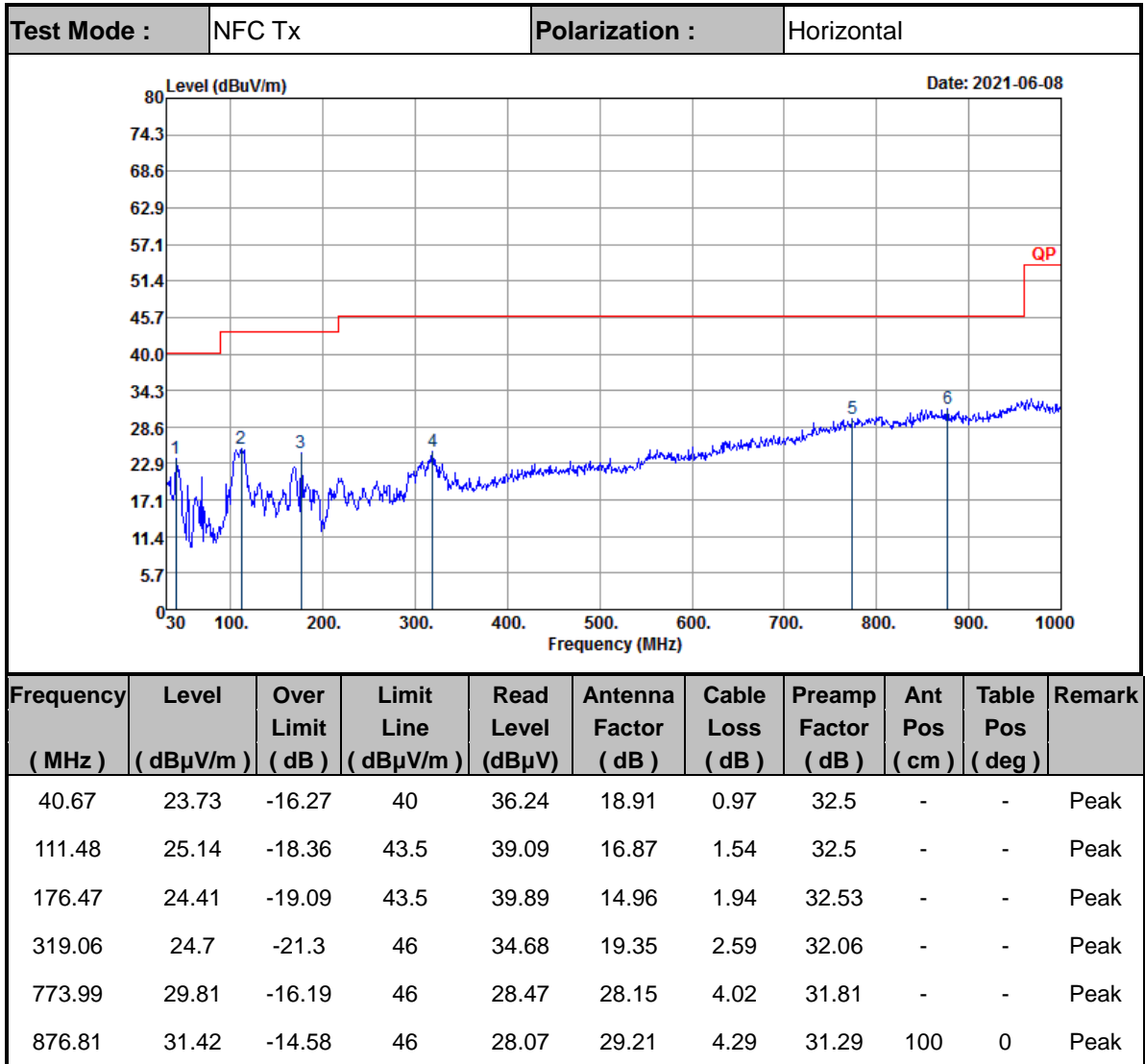

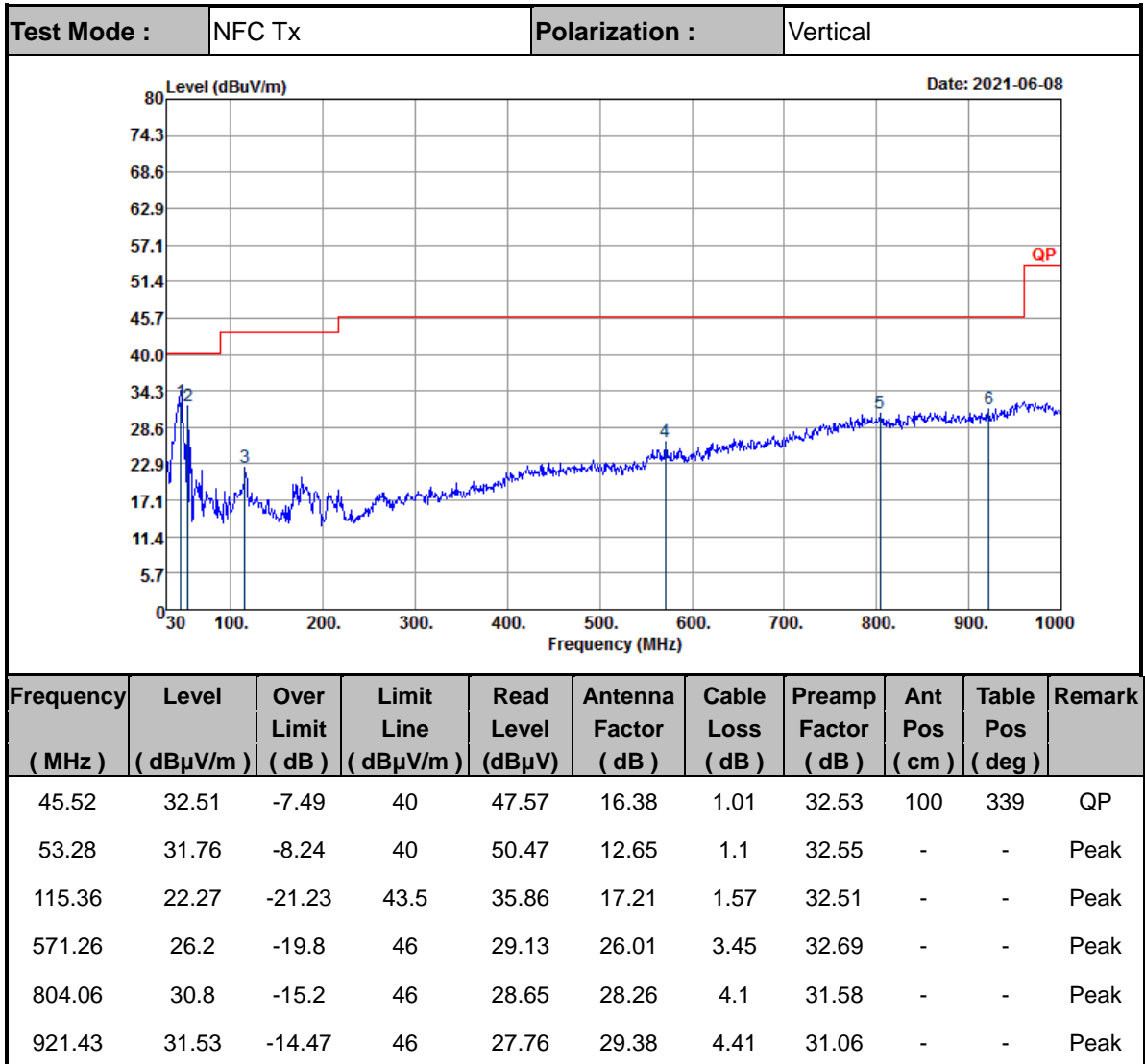

Note:

1. The amplitude of spurious emissions which are attenuated by more than 20dB below the permissible value has no need to be reported.
2. Emission level (dB μ V/m) = 20 log Emission level (μ V/m).
3. Corrected Reading: Antenna Factor + Cable Loss + Read Level - Preamp Factor= Level.

—————THE END—————