



# FCC RADIO TEST REPORT

**FCC ID** : PY7-53953L  
**Equipment** : GSM/WCDMA/LTE/5G Phone with BT, DTS/UNII a/b/g/n/ac/ax, GPS and NFC  
**Brand Name** : Sony  
**Applicant** : Sony Corporation  
1-7-1 Konan Minato-ku Tokyo, 108-0075 Japan  
**Manufacturer** : Sony Corporation  
1-7-1 Konan Minato-ku Tokyo, 108-0075 Japan  
**Standard** : FCC Part 15 Subpart C §15.247

The product was received on Apr. 27, 2021 and testing was started from May 06, 2021 and completed on Jun. 07, 2021. We, Sporton International Inc. EMC & Wireless Communications Laboratory, would like to declare that the tested sample has been evaluated in accordance with the test procedures and has been in compliance with the applicable technical standards.

The test results in this spot check data report apply exclusively to the tested model / sample. Without written approval of Sporton International Inc. EMC & Wireless Communications Laboratory, the test report shall not be reproduced except in full.

*Louis Wu*

Approved by: Louis Wu

**Sporton International Inc. EMC & Wireless Communications Laboratory**

No. 52, Huaya 1st Rd., Guishan Dist., Taoyuan City 333, Taiwan (R.O.C.)



## Table of Contents

History of this test report.....	3
Summary of Test Result.....	4
<b>1 General Description .....</b>	<b>5</b>
1.1 Product Feature of Equipment Under Test.....	5
1.2 Modification of EUT .....	5
1.3 Testing Location .....	6
1.4 Applicable Standards.....	6
<b>2 Test Configuration of Equipment Under Test .....</b>	<b>7</b>
2.1 Carrier Frequency and Channel .....	7
2.2 Test Mode.....	7
2.3 Connection Diagram of Test System.....	8
2.4 EUT Operation Test Setup .....	8
<b>3 Test Result .....</b>	<b>9</b>
3.1 Output Power Measurement.....	9
3.2 Radiated Band Edges and Spurious Emission Measurement .....	10
3.3 Antenna Requirements .....	15
<b>4 List of Measuring Equipment.....</b>	<b>16</b>
<b>5 Uncertainty of Evaluation .....</b>	<b>17</b>
<b>Appendix A. Conducted Test Results</b>	
<b>Appendix B. Radiated Spurious Emission</b>	
<b>Appendix C. Radiated Spurious Emission Plots</b>	
<b>Appendix D. Duty Cycle Plots</b>	



### History of this test report

Report No.	Version	Description	Issued Date
FR133144C	01	Initial issue of report	Jun. 11, 2021



## Summary of Test Result

Report Clause	Ref Std. Clause	Test Items	Result (PASS/FAIL)	Remark
-	15.247(a)(2)	6dB Bandwidth	-	See Note
-	2.1049	99% Occupied Bandwidth	-	See Note
3.1	15.247(b)	Power Output Measurement	Pass	-
-	15.247(e)	Power Spectral Density	-	See Note
-	15.247(d)	Conducted Band Edges	-	See Note
		Conducted Spurious Emission	-	See Note
3.2	15.247(d)	Radiated Band Edges and Radiated Spurious Emission	Pass	Under limit 3.97 dB at 18000.000 MHz
-	15.207	AC Conducted Emission	-	See Note
3.3	15.203 & 15.247(b)	Antenna Requirement	Pass	-

**Note:** The RF circuit, output power level and antenna performance is the same in WLAN function across all two FCC ID PY7-53953L and PY7-45256F, since the change, only verify RF output power and radiated spurious emission test data the worst mode was reported in this report.

<b>Declaration of Conformity:</b>
The test results with all measurement uncertainty excluded are presented in accordance with the regulation limits or requirements declared by manufacturers.
<b>Comments and Explanations:</b>
The declared of product specification for EUT presented in the report are provided by the manufacturer, and the manufacturer takes all the responsibilities for the accuracy of product specification.

**Reviewed by: Keven Cheng**  
**Report Producer: Amy Chen**



# 1 General Description

## 1.1 Product Feature of Equipment Under Test

GSM/WCDMA/LTE, Bluetooth, DTS/UNII a/b/g/n/ac/ax, NFC, FM Receiver, and GNSS.

Product Specification subjective to this standard	
Antenna Type	<Chain 0>: Loop Antenna with gain -2.3 dBi <Chain 1>: Loop Antenna with gain -7.0 dBi

**Remark:** The above EUT's information was declared by manufacturer. Please refer to Comments and Explanations in report summary.

EUT Information List			
HW Version	SW Version	S/N	Performed Test Item
A	0.325	QV72003V7P	RF Conducted Measurement
	0.325	QV7200D87P	Radiated Spurious Emission

Accessory List	
AC Adapter	Model Name : XQZ-UC1
	S/N : 0020W51300039
Earphone	Model Name : STH40D
	S/N : N/A
USB Cable	Model Name : XQZ-UB1
	S/N : N/A

**Note:**

- Above EUT list used are electrically identical per declared by manufacturer.
- Above the accessories list are used to exercise the EUT during test, and the serial number of each type of accessories is listed in each section of this report.
- For other wireless features of this EUT, test report will be issued separately.

## 1.2 Modification of EUT

No modifications are made to the EUT during all test items.



### 1.3 Testing Location

<b>Test Site</b>	Sporton International Inc. EMC & Wireless Communications Laboratory
<b>Test Site Location</b>	No.52, Huaya 1st Rd., Guishan Dist., Taoyuan City 333, Taiwan (R.O.C.) TEL: +886-3-327-3456 FAX: +886-3-328-4978
<b>Test Site No.</b>	<b>Sporton Site No.</b> TH02-HY
<b>Test Site</b>	Sporton International Inc. Wensan Laboratory
<b>Test Site Location</b>	No.58, Aly. 75, Ln. 564, Wenhua 3rd, Rd., Guishan Dist., Taoyuan City 333010, Taiwan (R.O.C.) TEL: +886-3-327-0868 FAX: +886-3-327-0855
<b>Test Site No.</b>	<b>Sporton Site No.</b> 03CH15-HY (TAF Code: 3786)
<b>Remark</b>	The Radiated Spurious Emission test item subcontracted to Sporton International Inc. Wensan Laboratory

**Note:** The test site complies with ANSI C63.4 2014 requirement.

FCC designation No.: TW1190 and TW3786

### 1.4 Applicable Standards

According to the specifications of the manufacturer, the EUT must comply with the requirements of the following standards:

- ♦ FCC Part 15 Subpart C §15.247
- ♦ FCC KDB Publication No. 558074 D01 DTS Meas. Guidance v05r02
- ♦ FCC KDB 414788 D01 Radiated Test Site v01r01.
- ♦ FCC KDB 662911 D01 Multiple Transmitter Output v02r01.
- ♦ ANSI C63.10-2013

**Remark:**

1. All test items were verified and recorded according to the standards and without any deviation during the test.
2. The TAF code is not including all the FCC KDB listed without accreditation.
3. This EUT has also been tested and complied with the requirements of FCC Part 15, Subpart B, recorded in a separate test report.



## 2 Test Configuration of Equipment Under Test

- a. The EUT has been associated with peripherals and configuration operated in a manner tended to maximize its emission characteristics in a typical application. Frequency range investigated: radiation emission (9 kHz to the 10th harmonic of the highest fundamental frequency or to 40 GHz, whichever is lower). For radiated measurement, pre-scanned in three orthogonal panels, X, Y, Z. The worst cases (X plane) were recorded in this report.

### 2.1 Carrier Frequency and Channel

Frequency Band	Channel	Freq. (MHz)	Channel	Freq. (MHz)
2400-2483.5 MHz	1	2412	7	2442
	2	2417	8	2447
	3	2422	9	2452
	4	2427	10	2457
	5	2432	11	2462
	6	2437		

### 2.2 Test Mode

Final test modes are considering the modulation and worse data rates as below table.

Modulation	Data Rate
802.11b	1 Mbps
802.11g	6 Mbps
802.11n HT20	MCS0
802.11ax HE20	MCS0

Ch. #	2400-2483.5 MHz		
	802.11b	802.11g	802.11ax HE20
Low	01	-	01
Middle	-	-	-
High	11	11	-

**Remark:** For radiation spurious emission, the final modulation and the worst data rate was reference the original report worse case.

## 2.3 Connection Diagram of Test System

<WLAN TX Mode>

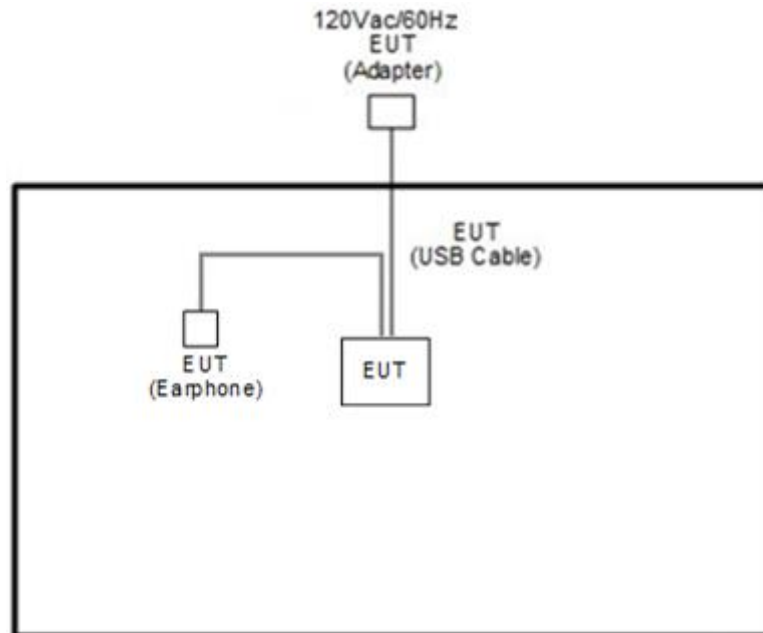

## 2.4 EUT Operation Test Setup

The RF test items, utility “FTMC\_bridge 0.39” was installed in Notebook which was programmed in order to make the EUT get into the engineering modes to provide channel selection, power level, data rate and the application type and for continuous transmitting signals.



### 3 Test Result

#### 3.1 Output Power Measurement

##### 3.1.1 Limit of Output Power

For systems using digital modulation in the 2400-2483.5 MHz, the limit for output power is 30 dBm. If transmitting antenna with directional gain greater than 6 dBi is used, the peak output power from the intentional radiator shall be reduced below the above stated value by the amount in dB that the directional gain of the antenna exceeds 6 dBi. In case of point-to-point operation, the limit has to be reduced by 1 dB for every 3 dB that the directional gain of the antenna exceeds 6 dBi.

##### 3.1.2 Measuring Instruments

See list of measuring equipment of this test report.

##### 3.1.3 Test Procedures

1. For Peak Power, the testing follows ANSI C63.10 Section 11.9.1.3 PKPM1
2. For Average Power, the testing follows ANSI C63.10 Section 11.9.2.3.2 Method AVGPM-G
3. The RF output of EUT was connected to the power meter by RF cable and attenuator. The path loss was compensated to the results for each measurement.
4. Set the maximum power setting and enable the EUT to transmit continuously.
5. Measure the conducted output power and record the results in the test report.
6. For MIMO mode, calculation method follows FCC KDB 662911 D01 Multiple Transmitter Output v02r01.

##### 3.1.4 Test Setup

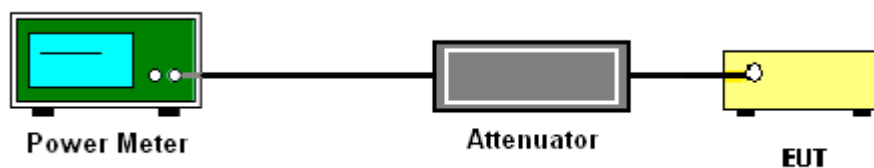

##### 3.1.5 Test Result of Peak Output Power

Please refer to Appendix A.

##### 3.1.6 Test Result of Average Output Power (Reporting Only)

Please refer to Appendix A.



### 3.2 Radiated Band Edges and Spurious Emission Measurement

#### 3.2.1 Limit of Radiated band edge and Spurious Emission Measurement

In any 100 kHz bandwidth outside the intentional radiator frequency band, all harmonics/spurious must be at least 20 dB below the highest emission level within the authorized band. If the output power of this device was measured by spectrum analyzer, the attenuation under this paragraph shall be 30 dB instead of 20 dB. In addition, radiated emissions which fall in the restricted bands must also comply with the limits as below.

Frequency (MHz)	Field Strength (microvolts/meter)	Measurement Distance (meters)
0.009 – 0.490	2400/F(kHz)	300
0.490 – 1.705	24000/F(kHz)	30
1.705 – 30.0	30	30
30 – 88	100	3
88 – 216	150	3
216 - 960	200	3
Above 960	500	3

#### 3.2.2 Measuring Instruments

See list of measuring equipment of this test report.

**3.2.3 Test Procedures**

1. The testing follows the ANSI C63.10 Section 11.12.1 Radiated emission measurements.
2. The EUT was arranged to its worst case and then tune the antenna tower (from 1 m to 4 m) and turntable (from 0 degree to 360 degrees) to find the maximum reading. A pre-amp and a high pass filter are used for the test in order to get better signal level.
3. The EUT was placed on a turntable with 0.8 meter for frequency below 1 GHz and 1.5 meter for frequency above 1 GHz respectively above ground.
4. The EUT was set 3 meters from the interference receiving antenna, which was mounted on the top of a variable height antenna tower.
5. Corrected Reading: Antenna Factor + Cable Loss + Read Level - Preamp Factor = Level
6. For testing below 1 GHz, if the emission level of the EUT in peak mode was 3 dB lower than the limit specified, then peak values of EUT will be reported, otherwise, the emissions will be repeated one by one using the CISPR quasi-peak method and reported.
7. For testing above 1 GHz, the emission level of the EUT in peak mode was 20 dB lower than average limit (that means the emission level in average mode also complies with the limit in average mode), then peak values of EUT will be reported, otherwise, the emissions will be measured in average mode again and reported.
8. Use the following spectrum analyzer settings:
  - (1) Span shall wide enough to fully capture the emission being measured;
  - (2) Set RBW = 100 kHz for  $f < 1$  GHz; VBW  $\geq$  RBW; Sweep = auto; Detector function = peak; Trace = max hold;
  - (3) Set RBW = 1 MHz, VBW= 3 MHz for  $f \geq 1$  GHz for peak measurement.  
For average measurement:
    - VBW = 10 Hz, when duty cycle is no less than 98 percent.
    - VBW  $\geq 1/T$ , when duty cycle is less than 98 percent where T is the minimum transmission duration over which the transmitter is on and is transmitting at its maximum power control level for the tested mode of operation.

### 3.2.4 Test Setup

For radiated emissions below 30MHz

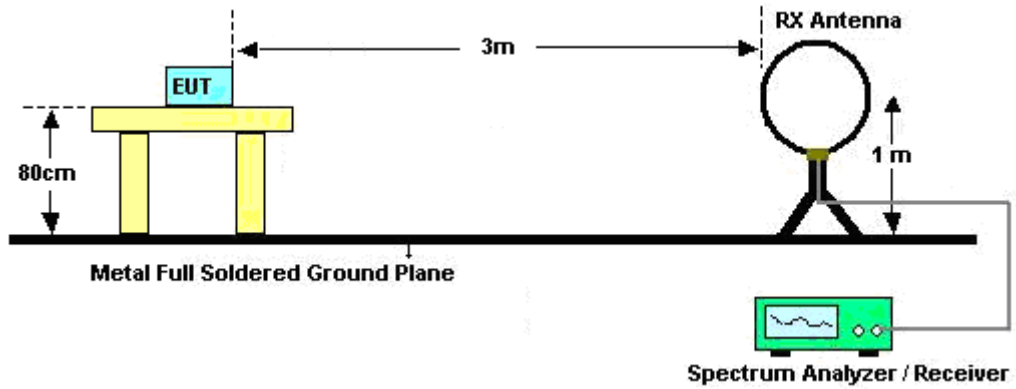

For radiated emissions from 30MHz to 1GHz

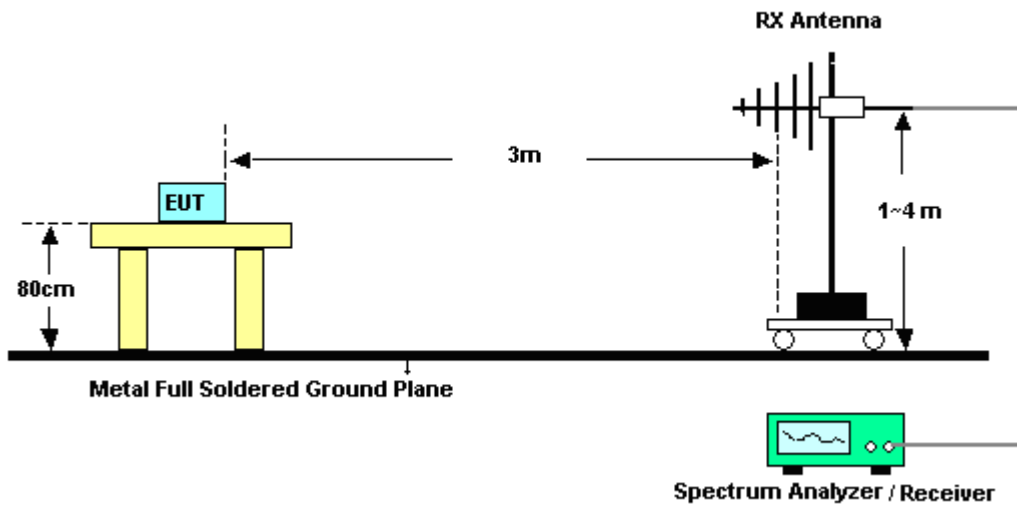

For radiated test from 1GHz to 18GHz

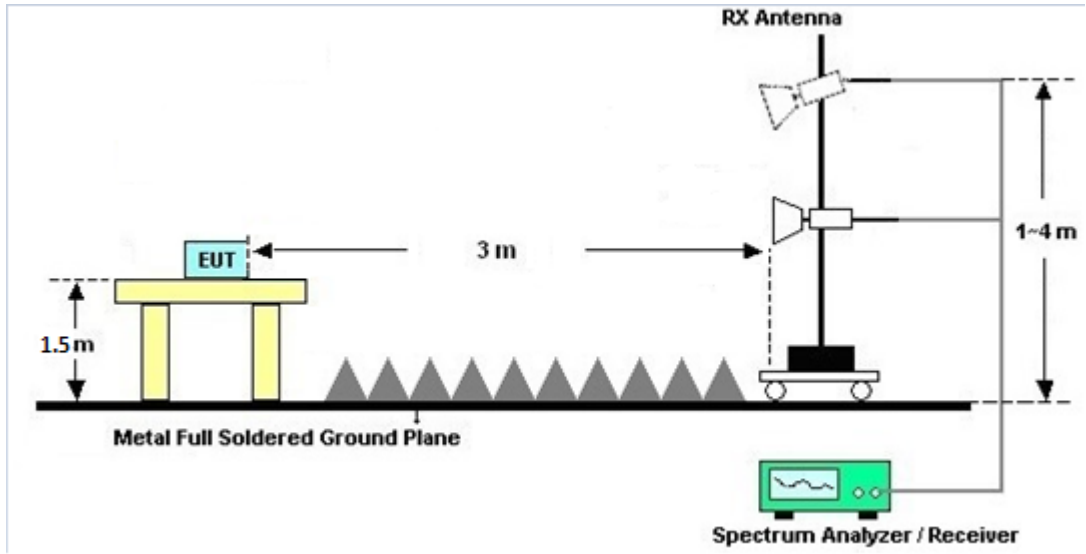

For radiated test above 18GHz

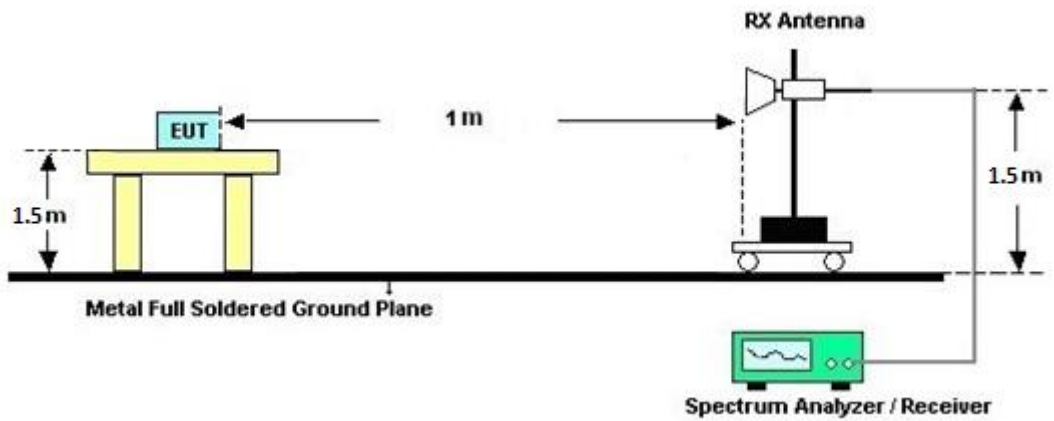



### **3.2.5 Test Results of Radiated Spurious Emissions (9kHz ~ 30MHz)**

The low frequency, which started from 9 kHz to 30MHz, was pre-scanned and the result which was 20dB lower than the limit line was not reported.

There is a comparison data of both open-field test site and alternative test site - semi-Anechoic chamber according to 414788 D01 Radiated Test Site v01r01, and the result came out very similar.

### **3.2.6 Test Result of Radiated Spurious at Band Edges**

Please refer to Appendix B and C.

### **3.2.7 Duty Cycle**

Please refer to Appendix D.

### **3.2.8 Test Result of Radiated Spurious Emission (30MHz ~ 10<sup>th</sup> Harmonic)**

Please refer to Appendix B and C.



### **3.3 Antenna Requirements**

#### **3.3.1 Standard Applicable**

If directional gain of transmitting Antennas is greater than 6 dBi, the power shall be reduced by the same level in dB comparing to gain minus 6 dBi. The use of a permanently attached antenna or of an antenna that uses a unique coupling to the intentional radiator shall be considered sufficient to comply with the rule.

#### **3.3.2 Antenna Anti-Replacement Construction**

An embedded-in antenna design is used.

#### **3.3.3 Antenna Gain**

The antenna peak gain of EUT is less than 6 dBi. Therefore, it is not necessary to reduce maximum peak output power limit.



## 4 List of Measuring Equipment

Instrument	Brand Name	Model No.	Serial No.	Characteristics	Calibration Date	Test Date	Due Date	Remark
Hygrometer	TECEPEL	TR-32	HE17XB2468	N/A	Mar. 09, 2021	May 06, 2021	Mar. 08, 2022	Conducted (TH02-HY)
Power Sensor	DARE	RPR3006W	16100054SNO12	10MHz~6GHz	Dec. 16, 2020	May 06, 2021	Dec. 15, 2021	Conducted (TH02-HY)
Signal Analyzer	Rohde & Schwarz	FSV40	101566	10Hz ~ 40GHz	Jul. 22, 2020	May 06, 2021	Jul. 21, 2021	Conducted (TH02-HY)
Switch Box & RF Cable	Burgeon	ETF058	EC1300484	N/A	Nov. 19, 2020	May 06, 2021	Nov. 18, 2021	Conducted (TH02-HY)
Loop Antenna	Rohde & Schwarz	HFH2-Z2	100488	9 kHz~30 MHz	Jul. 14, 2020	May 31, 2021~Jun. 07, 2021	Jul. 13, 2021	Radiation (03CH15-HY)
Bilog Antenna	TESEQ	CBL 6111D & 00800N1D01N-06	41912 & 05	30MHz~1GHz	Feb. 08, 2021	May 31, 2021~Jun. 07, 2021	Feb. 07, 2022	Radiation (03CH15-HY)
Amplifier	SONOMA	310N	363440	9kHz~1GHz	Dec. 28, 2020	May 31, 2021~Jun. 07, 2021	Dec. 27, 2021	Radiation (03CH15-HY)
Horn Antenna	SCHWARZBECK	BBHA 9120 D	9120D-01620	1GHz~18GHz	Nov. 03, 2020	May 31, 2021~Jun. 07, 2021	Nov. 02, 2021	Radiation (03CH15-HY)
SHF-EHF Horn Antenna	SCHWARZBECK	BBHA 9170	BBHA9170251	18GHz~40GHz	Dec. 02, 2020	May 31, 2021~Jun. 07, 2021	Dec. 01, 2021	Radiation (03CH15-HY)
Preamplifier	Jet-Power	JPA0118-55-303	1710001800055006	1GHz~18GHz	May 06, 2021	May 31, 2021~Jun. 07, 2021	May 05, 2022	Radiation (03CH15-HY)
Preamplifier	Keysight	83017A	MY53270195	1GHz~26.5GHz	Aug. 21, 2020	May 31, 2021~Jun. 07, 2021	Aug. 20, 2021	Radiation (03CH15-HY)
Preamplifier	EMEC	EM18G40G	0600789	18-40GHz	Oct. 27, 2020	May 31, 2021~Jun. 07, 2021	Oct. 26, 2021	Radiation (03CH15-HY)
EMI Test Receiver	Keysight	N9038A(MXE)	MY54130085	20MHz~8.4GHz	Nov. 02, 2020	May 31, 2021~Jun. 07, 2021	Nov. 01, 2021	Radiation (03CH15-HY)
Spectrum Analyzer	Keysight	N9010A	MY54200485	10Hz~44GHz	Mar. 05, 2021	May 31, 2021~Jun. 07, 2021	Mar. 04, 2022	Radiation (03CH15-HY)
Antenna Mast	ChainTek	MBS-520-1	N/A	1m~4m	N/A	May 31, 2021~Jun. 07, 2021	N/A	Radiation (03CH15-HY)
Turn Table	ChainTek	T-200-S-1	N/A	0~360 Degree	N/A	May 31, 2021~Jun. 07, 2021	N/A	Radiation (03CH15-HY)
Software	Audix	E3 6.2009-8-24 (k5)	RK-000451	N/A	N/A	May 31, 2021~Jun. 07, 2021	N/A	Radiation (03CH15-HY)
RF Cable	HUBER + SUHNER	SUCOFLEX 104, 102E	MY36980/4, MY9838/4PE, 508405/2E	30MHz~18G	Nov. 16, 2020	May 31, 2021~Jun. 07, 2021	Nov. 15, 2021	Radiation (03CH15-HY)
RF Cable	HUBER + SUHNER	SUCOFLEX 102	505134/2	30MHz-40GHz	Feb. 22, 2021	May 31, 2021~Jun. 07, 2021	Feb. 21, 2022	Radiation (03CH15-HY)
RF Cable	HUBER + SUHNER	SUCOFLEX 102	800740/2	30MHz-40GHz	Feb. 22, 2021	May 31, 2021~Jun. 07, 2021	Feb. 21, 2022	Radiation (03CH15-HY)
RF Cable	HUBER + SUHNER	SUCOFLEX 104	MY9837/4PE	9kHz~30MHz	Mar. 11, 2021	May 31, 2021~Jun. 07, 2021	Mar. 10, 2022	Radiation (03CH15-HY)
Filter	Wainwright	WLJ4-1000-1530-6000-40ST	SN4	1.53GHz Low Pass Filter	Jul. 03, 2020	May 31, 2021~Jun. 07, 2021	Jul. 02, 2021	Radiation (03CH15-HY)
Filter	Wainwright	WHKX12-2700-3000-18000-60ST	SN4	3GHz High Pass Filter	Sep. 16, 2020	May 31, 2021~Jun. 07, 2021	Sep. 15, 2021	Radiation (03CH15-HY)





## 5 Uncertainty of Evaluation

### Uncertainty of Radiated Emission Measurement (30 MHz ~ 1000 MHz)

Measuring Uncertainty for a Level of Confidence of 95% ( $U = 2Uc(y)$ )	4.7 dB
---	--------

### Uncertainty of Radiated Emission Measurement (1000 MHz ~ 18000 MHz)

Measuring Uncertainty for a Level of Confidence of 95% ( $U = 2Uc(y)$ )	5.3 dB
---	--------

### Uncertainty of Radiated Emission Measurement (18000 MHz ~ 40000 MHz)

Measuring Uncertainty for a Level of Confidence of 95% ( $U = 2Uc(y)$ )	4.9 dB
---	--------

**Appendix A. Test Result of Conducted Test Items**

Test Engineer:	Eason Huang	Temperature:	21~25	°C
Test Date:	2021/5/6	Relative Humidity:	51~54	%

**TEST RESULTS DATA**  
**Peak Output Power**

2.4GHz Band MIMO																
Mod.	Data Rate	NTX	CH.	Freq. (MHz)	Peak Conducted Power (dBm)			Conducted Power Limit (dBm)		DG (dBi)		EIRP Power (dBm)		EIRP Power Limit (dBm)		Pass /Fail
					Chain 0	Chain 1	SUM	Chain 0	Chain 1	Chain 0	Chain 1	Chain 0	Chain 1	Chain 0	Chain 1	
11b	1Mbps	2	1	2412	17.46	15.45	19.58	30.00		-2.30		17.28		36.00	Pass	
11b	1Mbps	2	6	2437	17.51	15.53	19.64	30.00		-2.30		17.34		36.00	Pass	
11b	1Mbps	2	11	2462	17.45	15.58	19.63	30.00		-2.30		17.33		36.00	Pass	
11g	6Mbps	2	1	2412	22.76	22.46	25.62	30.00		-2.30		23.32		36.00	Pass	
11g	6Mbps	2	6	2437	22.66	22.36	25.52	30.00		-2.30		23.22		36.00	Pass	
11g	6Mbps	2	11	2462	22.33	22.29	25.32	30.00		-2.30		23.02		36.00	Pass	
HT20	MCS0	2	1	2412	22.65	22.78	25.73	30.00		-2.30		23.43		36.00	Pass	
HT20	MCS0	2	6	2437	22.95	22.74	25.86	30.00		-2.30		23.56		36.00	Pass	
HT20	MCS0	2	11	2462	21.87	21.81	24.85	30.00		-2.30		22.55		36.00	Pass	

Note: Measured power (dBm) has offset with cable loss.

**TEST RESULTS DATA**  
**Average Output Power**

2.4GHz Band MIMO																
Mod.	Data Rate	NTX	CH.	Freq. (MHz)	Average Conducted Power with duty factor (dBm)			Conducted Power Limit (dBm)		DG (dBi)		EIRP Power (dBm)		EIRP Power Limit (dBm)		Pass /Fail
					Chain 0	Chain 1	SUM	Chain 0	Chain 1	Chain 0	Chain 1	Chain 0	Chain 1	Chain 0	Chain 1	
11b	1Mbps	2	1	2412	14.87	12.78	16.96	30.00		-2.30		14.66		36.00	Pass	
11b	1Mbps	2	6	2437	14.73	12.68	16.84	30.00		-2.30		14.54		36.00	Pass	
11b	1Mbps	2	11	2462	14.77	12.60	16.83	30.00		-2.30		14.53		36.00	Pass	
11g	6Mbps	2	1	2412	14.94	14.81	17.89	30.00		-2.30		15.59		36.00	Pass	
11g	6Mbps	2	6	2437	14.96	14.88	17.93	30.00		-2.30		15.63		36.00	Pass	
11g	6Mbps	2	11	2462	14.43	14.21	17.33	30.00		-2.30		15.03		36.00	Pass	
HT20	MCS0	2	1	2412	14.26	14.22	17.25	30.00		-2.30		14.95		36.00	Pass	
HT20	MCS0	2	6	2437	14.69	14.76	17.74	30.00		-2.30		15.44		36.00	Pass	
HT20	MCS0	2	11	2462	12.59	12.76	15.69	30.00		-2.30		13.39		36.00	Pass	

Note: Measured power (dBm) has offset with cable loss.

**TEST RESULTS DATA**  
**Peak Output Power**

2.4GHz Band MIMO																	
Mod.	Data Rate	Ntx	CH.	Freq. (MHz)	RU Config	Peak Conducted Power (dBm)			Conducted Power Limit (dBm)		DG (dBi)		EIRP Power (dBm)		EIRP Power Limit (dBm)		Pass /Fail
						Chain 0	Chain 1	SUM	Chain 0	Chain 1	Chain 0	Chain 1	Chain 0	Chain 1	Chain 0	Chain 1	
HE20	MCS 0	2	1	2412	Full	22.57	22.69	25.64	30.00		-2.30	23.34		36.00		Pass	
HE20	MCS 0	2	1	2412	26/0	20.00	21.09	23.59	30.00		-2.30	21.29		36.00		Pass	
HE20	MCS 0	2	1	2412	52/37	22.45	22.71	25.59	30.00		-2.30	23.29		36.00		Pass	
HE20	MCS 0	2	1	2412	106/53	23.25	23.21	26.24	30.00		-2.30	23.94		36.00		Pass	
HE20	MCS 0	2	6	2437	Full	23.09	22.81	25.96	30.00		-2.30	23.66		36.00		Pass	
HE20	MCS 0	2	6	2437	26/4	20.31	20.71	23.52	30.00		-2.30	21.22		36.00		Pass	
HE20	MCS 0	2	6	2437	52/39	22.45	22.64	25.56	30.00		-2.30	23.26		36.00		Pass	
HE20	MCS 0	2	6	2437	106/53	23.45	23.09	26.28	30.00		-2.30	23.98		36.00		Pass	
HE20	MCS 0	2	11	2462	Full	22.03	21.78	24.92	30.00		-2.30	22.62		36.00		Pass	
HE20	MCS 0	2	11	2462	26/8	20.31	20.92	23.64	30.00		-2.30	21.34		36.00		Pass	
HE20	MCS 0	2	11	2462	52/40	22.86	22.74	25.81	30.00		-2.30	23.51		36.00		Pass	
HE20	MCS 0	2	11	2462	106/54	22.66	22.79	25.74	30.00		-2.30	23.44		36.00		Pass	

Note: Measured power (dBm) has offset with cable loss.

**TEST RESULTS DATA**  
**Average Output Power**

2.4GHz Band MIMO																
Mod.	Data Rate	N <sub>Tx</sub>	CH.	Freq. (MHz)	RU Config	Average Conducted Power with duty factor (dBm)			Conducted Power Limit (dBm)		DG (dBi)		EIRP Power (dBm)		EIRP Power Limit (dBm)	Pass /Fail
						Chain 0	Chain 1	SUM	Chain 0	Chain 1	Chain 0	Chain 1	Chain 0	Chain 1		
HE20	MCS0	2	1	2412	Full	14.41	14.39	17.41	30.00		-2.30		15.11		36.00	Pass
HE20	MCS0	2	1	2412	26/0	9.42	9.49	12.47	30.00		-2.30		10.17		36.00	Pass
HE20	MCS0	2	1	2412	52/37	12.40	12.30	15.36	30.00		-2.30		13.06		36.00	Pass
HE20	MCS0	2	1	2412	106/53	14.46	14.37	17.43	30.00		-2.30		15.13		36.00	Pass
HE20	MCS0	2	6	2437	Full	14.87	14.87	17.88	30.00		-2.30		15.58		36.00	Pass
HE20	MCS0	2	6	2437	26/4	9.40	9.32	12.37	30.00		-2.30		10.07		36.00	Pass
HE20	MCS0	2	6	2437	52/39	12.43	12.44	15.45	30.00		-2.30		13.15		36.00	Pass
HE20	MCS0	2	6	2437	106/53	14.31	14.46	17.40	30.00		-2.30		15.10		36.00	Pass
HE20	MCS0	2	11	2462	Full	12.74	12.79	15.78	30.00		-2.30		13.48		36.00	Pass
HE20	MCS0	2	11	2462	26/8	9.32	9.32	12.33	30.00		-2.30		10.03		36.00	Pass
HE20	MCS0	2	11	2462	52/40	12.42	12.26	15.35	30.00		-2.30		13.05		36.00	Pass
HE20	MCS0	2	11	2462	106/54	12.44	12.30	15.38	30.00		-2.30		13.08		36.00	Pass

Note: Measured power (dBm) has offset with cable loss.



## Appendix B. Radiated Spurious Emission

Test Engineer :	Leo Lee, Mancy Chou, and Bigshow Wang	Temperature :	22.7~23.7°C
		Relative Humidity :	46~52%

### 2.4GHz 2400~2483.5MHz

#### WIFI 802.11b (Band Edge @ 3m)

WIFI Chain	Note	Frequency ( MHz )	Level ( dBμV/m )	Over Limit ( dB )	Limit Line ( dBμV/m )	Read Level ( dBμV )	Antenna Factor ( dB/m )	Path Loss ( dB )	Preamp Factor ( dB )	Ant Pos ( cm )	Table Pos ( deg )	Peak Avg. ( P/A )	Pol. ( H/V )	
802.11b CH 11 2462MHz	*	2462	103.05	-	-	89.78	27.48	16.68	30.89	106	216	P	H	
	*	2462	99.84	-	-	86.57	27.48	16.68	30.89	106	216	A	H	
		2489.75	55.32	-18.68	74	42.05	27.42	16.72	30.87	106	216	P	H	
		2485	43.84	-10.16	54	30.58	27.43	16.71	30.88	106	216	A	H	
													H	
														H
	*	2462	100.73	-	-	87.46	27.48	16.68	30.89	361	293	P	V	
	*	2462	97.73	-	-	84.46	27.48	16.68	30.89	361	293	A	V	
		2488.35	55.68	-18.32	74	42.41	27.42	16.72	30.87	361	293	P	V	
		2486.25	43.79	-10.21	54	30.53	27.43	16.71	30.88	361	293	A	V	
														V
														V
Remark	1. No other spurious found. 2. All results are PASS against Peak and Average limit line.													



2.4GHz 2400~2483.5MHz
WIFI 802.11b (Harmonic @ 3m)

Table with 14 columns: WIFI Chain 0+1, Note, Frequency (MHz), Level (dBµV/m), Over Limit (dB), Limit Line (dBµV/m), Read Level (dBµV), Antenna Factor (dB/m), Path Loss (dB), Preamp Factor (dB), Ant Pos (cm), Table Pos (deg), Peak Avg. (P/A), Pol. (H/V). Rows include data for 802.11b CH 01 2412MHz and a Remark section.





**2.4GHz 2400~2483.5MHz  
WIFI 802.11g (Band Edge @ 3m)**

WIFI Chain 0+1	Note	Frequency ( MHz )	Level ( dBμV/m )	Over Limit ( dB )	Limit Line ( dBμV/m )	Read Level ( dBμV )	Antenna Factor ( dB/m )	Path Loss ( dB )	Preamp Factor ( dB )	Ant Pos ( cm )	Table Pos ( deg )	Peak Avg. ( P/A )	Pol. ( H/V )	
802.11g CH 11 2462MHz	*	2462	108.08	-	-	94.81	27.48	16.68	30.89	109	157	P	H	
	*	2462	100.4	-	-	87.13	27.48	16.68	30.89	109	157	A	H	
		2483.5	61.16	-12.84	74	47.9	27.43	16.71	30.88	109	157	P	H	
		2483.5	48.77	-5.23	54	35.51	27.43	16.71	30.88	109	157	A	H	
													H	
														H
	*	2462	106.39	-	-	93.12	27.48	16.68	30.89	365	281	P	V	
	*	2462	98.38	-	-	85.11	27.48	16.68	30.89	365	281	A	V	
		2483.6	60.17	-13.83	74	46.91	27.43	16.71	30.88	365	281	P	V	
		2483.5	47.18	-6.82	54	33.92	27.43	16.71	30.88	365	281	A	V	
														V
														V
<b>Remark</b>	1. No other spurious found. 2. All results are PASS against Peak and Average limit line.													



**2.4GHz 2400~2483.5MHz**

**WIFI 802.11ax HE20 Partial 106/53 (Harmonic @ 3m)**

WIFI Chain 0+1	Note	Frequency ( MHz )	Level ( dBμV/m )	Over Limit ( dB )	Limit Line ( dBμV/m )	Read Level ( dBμV )	Antenna Factor ( dB/m )	Path Loss ( dB )	Preamp Factor ( dB )	Ant Pos ( cm )	Table Pos ( deg )	Peak Avg. ( P/A )	Pol. ( H/V )	
802.11ax HE20 Partial 106/53 CH 01 2412MHz		4824	39.04	-34.96	74	56.73	31.1	10.07	58.86	100	0	P	H	
		18000	59.88	-14.12	74	49.23	49	18.89	57.24	100	33	P	H	
		18000	49.91	-4.09	54	39.26	49	18.89	57.24	100	33	A	H	
													H	
			4824	39.63	-34.37	74	57.32	31.1	10.07	58.86	100	0	P	V
			18000	60.13	-13.87	74	49.48	49	18.89	57.24	100	23	P	V
			18000	50.03	-3.97	54	39.38	49	18.89	57.24	100	23	A	V
													V	
Remark	1. No other spurious found. 2. All results are PASS against Peak and Average limit line.													



**Emission above 18GHz  
WIFI 802.11ax HE20 Partial 106/53 (SHF)**

WIFI Chain 0+1	Note	Frequency ( MHz )	Level ( dBμV/m )	Over Limit ( dB )	Limit Line ( dBμV/m )	Read Level (dBμV)	Antenna Factor ( dB/m )	Path Loss ( dB )	Preamp Factor ( dB )	Ant Pos ( cm )	Table Pos ( deg )	Peak Avg. (P/A)	Pol. (H/V)
2.4GHz 802.11ax HE20 Partial 106/53 SHF		23355	38.16	-35.84	74	55.47	39.77	-3.05	54.03	150	0	P	H
													H
													H
													H
													H
													H
													H
													H
													H
													H
													H
													H
													H
													H
2.4GHz 802.11ax HE20 Partial 106/53 SHF		22788	38.79	-35.21	74	56.1	40.17	-3.21	54.27	150	0	P	V
													V
													V
													V
													V
													V
													V
													V
													V
													V
													V
													V
													V
													V
<b>Remark</b>	1. No other spurious found. 2. All results are PASS against limit line.												



Emission below 1GHz
WIFI 802.11ax HE20 Partial 106/53 (LF)

Table with 14 columns: WIFI Chain 0+1, Note, Frequency (MHz), Level (dBμV/m), Over Limit (dB), Limit Line (dBμV/m), Read Level (dBμV), Antenna Factor (dB/m), Path Loss (dB), Preamp Factor (dB), Ant Pos (cm), Table Pos (deg), Peak Avg. (P/A), Pol. (H/V). Rows include data for 2.4GHz WIFI 802.11ax HE20 Partial 106/53 LF and a Remark section.



**Note symbol**

*	<b>Fundamental Frequency</b> which can be ignored. However, the level of any unwanted emissions shall not exceed the level of the fundamental frequency.
!	Test result is <b>over limit</b> line.
P/A	<b>Peak</b> or <b>Average</b>
H/V	<b>Horizontal</b> or <b>Vertical</b>



A calculation example for radiated spurious emission is shown as below:

WIFI	Note	Frequency	Level	Over	Limit	Read	Antenna	Path	Preamp	Ant	Table	Peak	Pol.
Ant.				Limit	Line	Level	Factor	Loss	Factor	Pos	Pos	Avg.	
0+1		( MHz )	( dBμV/m )	( dB )	( dBμV/m )	( dBμV )	( dB/m )	( dB )	( dB )	( cm )	( deg )	( P/A )	( H/V )
802.11b		2390	55.45	-18.55	74	54.51	32.22	4.58	35.86	103	308	P	H
CH 01													
2412MHz		2390	43.54	-10.46	54	42.6	32.22	4.58	35.86	103	308	A	H

1. Path Loss(dB) = Cable loss(dB) + Filter loss(dB) + Attenuator loss(dB)
2. Level(dBμV/m) =  
Antenna Factor(dB/m) + Path Loss(dB) + Read Level(dBμV) - Preamp Factor(dB)
3. Over Limit(dB) = Level(dBμV/m) – Limit Line(dBμV/m)

**For Peak Limit @ 2390MHz:**

1. Level(dBμV/m)  
= Antenna Factor(dB/m) + Path Loss(dB) + Read Level(dBμV) - Preamp Factor(dB)  
= 32.22(dB/m) + 4.58(dB) + 54.51(dBμV) – 35.86 (dB)  
= 55.45 (dBμV/m)
2. Over Limit(dB)  
= Level(dBμV/m) – Limit Line(dBμV/m)  
= 55.45(dBμV/m) – 74(dBμV/m)  
= -18.55(dB)

**For Average Limit @ 2390MHz:**

1. Level(dBμV/m)  
= Antenna Factor(dB/m) + Path Loss(dB) + Read Level(dBμV) - Preamp Factor(dB)  
= 32.22(dB/m) + 4.58(dB) + 42.6(dBμV) – 35.86 (dB)  
= 43.54 (dBμV/m)
2. Over Limit(dB)  
= Level(dBμV/m) – Limit Line(dBμV/m)  
= 43.54(dBμV/m) – 54(dBμV/m)  
= -10.46(dB)

**Both peak and average measured complies with the limit line, so test result is “PASS”.**



### Appendix C. Radiated Spurious Emission Plots

<b>Test Engineer :</b>	Leo Lee, Mancy Chou, and Bigshow Wang	<b>Temperature :</b>	22.7~23.7°C
		<b>Relative Humidity :</b>	46~52%

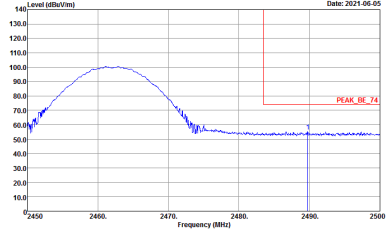
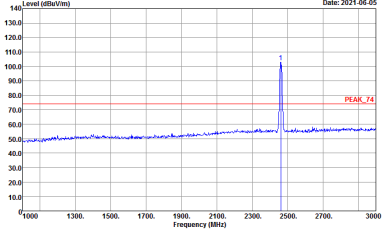
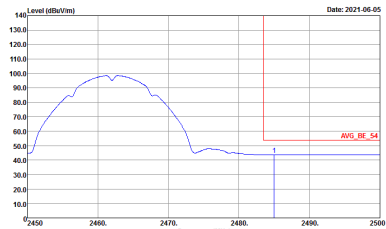
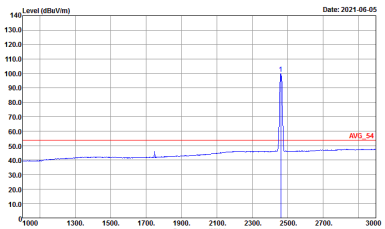

**2.4GHz 2400~2483.5MHz**  
**WIFI 802.11b (Band Edge @ 3m)**

WIFI	2.4GHz 2400~2483.5MHz Band Edge @ 3m	
Chain	802.11b CH11 2462MHz	
0+1	Horizontal	Fundamental
<b>Peak</b>	 <p>Level (dBuV/m) vs Frequency (MHz) plot showing a peak at 2462 MHz. The y-axis ranges from 10.0 to 140.0 dBuV/m, and the x-axis ranges from 2450 to 2500 MHz. A red line indicates the peak level at approximately 100.0 dBuV/m.</p> <p>Site : 03CH15-HY            Condition : PEAK_BE_74 3m 91200_15_1620 HORIZONTAL            : RBW:1000.000KHz VBW:3000.000KHz SWT:Auto</p>	 <p>Level (dBuV/m) vs Frequency (MHz) plot showing a sharp peak at 2462 MHz. The y-axis ranges from 10.0 to 140.0 dBuV/m, and the x-axis ranges from 1000 to 3000 MHz. A red line indicates the peak level at approximately 100.0 dBuV/m.</p> <p>Site : 03CH15-HY            Condition : PEAK_74 3m 91200_15_1620 HORIZONTAL            : RBW:1000.000KHz VBW:3000.000KHz SWT:Auto</p>
<b>Avg.</b>	 <p>Level (dBuV/m) vs Frequency (MHz) plot showing the average spectrum. The y-axis ranges from 10.0 to 140.0 dBuV/m, and the x-axis ranges from 2450 to 2500 MHz. A red line indicates the average level at approximately 50.0 dBuV/m.</p> <p>Site : 03CH15-HY            Condition : AVG_BE_54 3m 91200_15_1620 HORIZONTAL            : RBW:1000.000KHz VBW:0.010KHz SWT:Auto</p>	 <p>Level (dBuV/m) vs Frequency (MHz) plot showing the average spectrum. The y-axis ranges from 10.0 to 140.0 dBuV/m, and the x-axis ranges from 1000 to 3000 MHz. A red line indicates the average level at approximately 50.0 dBuV/m.</p> <p>Site : 03CH15-HY            Condition : AVG_54 3m 91200_15_1620 HORIZONTAL            : RBW:1000.000KHz VBW:0.010KHz SWT:Auto</p>



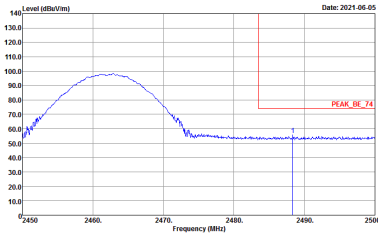
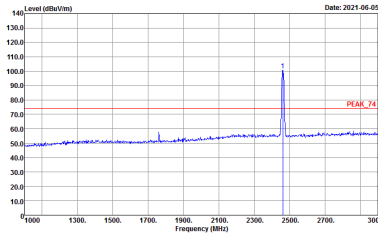
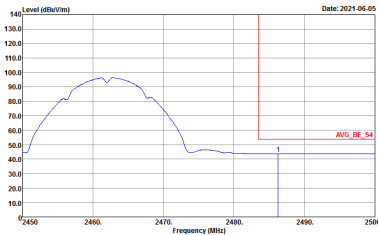
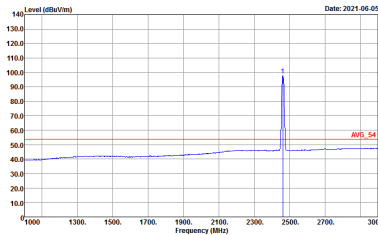

WIFI	2.4GHz 2400~2483.5MHz Band Edge @ 3m	
Chain	802.11b CH11 2462MHz	
0+1	Vertical	Fundamental
Peak	 <p>Level (dBuV/m) vs Frequency (MHz) plot for Peak Vertical. The plot shows a signal level starting at approximately 60 dBuV/m at 2450 MHz, rising to a peak of about 100 dBuV/m around 2460 MHz, and then falling to about 50 dBuV/m by 2470 MHz. A red line indicates the peak level at approximately 2483.5 MHz, labeled 'PEAK_BE_74'. The x-axis ranges from 2450 to 2500 MHz, and the y-axis ranges from 10.0 to 140.0 dBuV/m.</p> <p>Site : 03CH15-HY            Condition : PEAK_BE_74 3m 91200_15_1620 VERTICAL            : RBW:1000.000KHz VBW:3000.000KHz SWT:Auto</p>	 <p>Level (dBuV/m) vs Frequency (MHz) plot for Peak Fundamental. The plot shows a signal level starting at approximately 50 dBuV/m at 1000 MHz, rising to a sharp peak of about 100 dBuV/m at 2462 MHz, and then falling to about 50 dBuV/m by 2470 MHz. A red line indicates the peak level at approximately 2483.5 MHz, labeled 'PEAK_74'. The x-axis ranges from 1000 to 3000 MHz, and the y-axis ranges from 10.0 to 140.0 dBuV/m.</p> <p>Site : 03CH15-HY            Condition : PEAK_74 3m 91200_15_1620 VERTICAL            : RBW:1000.000KHz VBW:3000.000KHz SWT:Auto</p>
Avg.	 <p>Level (dBuV/m) vs Frequency (MHz) plot for Avg Vertical. The plot shows a signal level starting at approximately 60 dBuV/m at 2450 MHz, rising to a peak of about 90 dBuV/m around 2460 MHz, and then falling to about 50 dBuV/m by 2470 MHz. A red line indicates the average level at approximately 2483.5 MHz, labeled 'AVG_BE_54'. The x-axis ranges from 2450 to 2500 MHz, and the y-axis ranges from 10.0 to 140.0 dBuV/m.</p> <p>Site : 03CH15-HY            Condition : AVG_BE_54 3m 91200_15_1620 VERTICAL            : RBW:1000.000KHz VBW:0.010KHz SWT:Auto</p>	 <p>Level (dBuV/m) vs Frequency (MHz) plot for Avg Fundamental. The plot shows a signal level starting at approximately 40 dBuV/m at 1000 MHz, rising to a sharp peak of about 100 dBuV/m at 2462 MHz, and then falling to about 50 dBuV/m by 2470 MHz. A red line indicates the average level at approximately 2483.5 MHz, labeled 'AVG_54'. The x-axis ranges from 1000 to 3000 MHz, and the y-axis ranges from 10.0 to 140.0 dBuV/m.</p> <p>Site : 03CH15-HY            Condition : AVG_54 3m 91200_15_1620 VERTICAL            : RBW:1000.000KHz VBW:0.010KHz SWT:Auto</p>



2.4GHz 2400~2483.5MHz

WIFI 802.11g (Band Edge @ 3m)

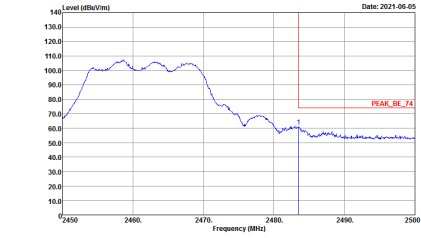
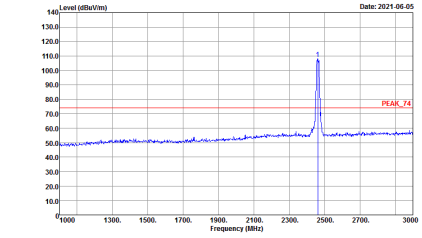
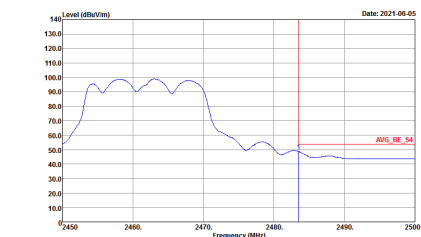
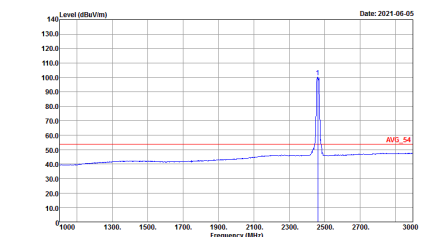
WIFI	2.4GHz 2400~2483.5MHz Band Edge @ 3m	
Chain	802.11g CH11 2462MHz	
0+1	Horizontal	Fundamental
Peak	 <p>Level (dBuV/m) vs Frequency (MHz) plot showing a peak at 2462 MHz. The y-axis ranges from 10.0 to 140.0 dBuV/m, and the x-axis ranges from 2450 to 2500 MHz. A red vertical line marks the peak at 2462 MHz, labeled 'PEAK_BE_74'.</p> <p>Site : 03CH15-HY Condition : PEAK_BE_74 3m 91200_15_1620 HORIZONTAL : RBW:1000.000KHz VBW:3000.000KHz SWT:Auto</p>	 <p>Level (dBuV/m) vs Frequency (MHz) plot showing a sharp peak at 2462 MHz. The y-axis ranges from 10.0 to 140.0 dBuV/m, and the x-axis ranges from 2400 to 2500 MHz. A red vertical line marks the peak at 2462 MHz, labeled 'PEAK_74'.</p> <p>Site : 03CH15-HY Condition : PEAK_74 3m 91200_15_1620 HORIZONTAL : RBW:1000.000KHz VBW:3000.000KHz SWT:Auto</p>
Avg.	 <p>Level (dBuV/m) vs Frequency (MHz) plot showing the average spectrum. The y-axis ranges from 10.0 to 140.0 dBuV/m, and the x-axis ranges from 2450 to 2500 MHz. A red vertical line marks the average level at 2462 MHz, labeled 'AVG_BE_54'.</p> <p>Site : 03CH15-HY Condition : AVG_BE_54 3m 91200_15_1620 HORIZONTAL : RBW:1000.000KHz VBW:0.010KHz SWT:Auto</p>	 <p>Level (dBuV/m) vs Frequency (MHz) plot showing the average spectrum with a sharp peak at 2462 MHz. The y-axis ranges from 10.0 to 140.0 dBuV/m, and the x-axis ranges from 2400 to 2500 MHz. A red vertical line marks the average level at 2462 MHz, labeled 'AVG_54'.</p> <p>Site : 03CH15-HY Condition : AVG_54 3m 91200_15_1620 HORIZONTAL : RBW:1000.000KHz VBW:0.010KHz SWT:Auto</p>

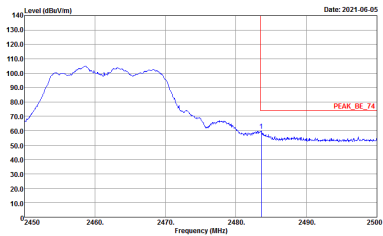
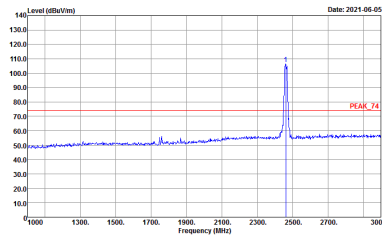
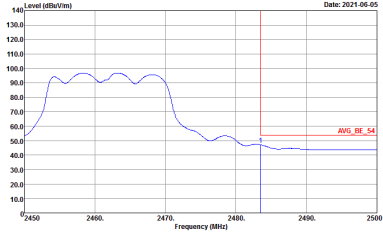
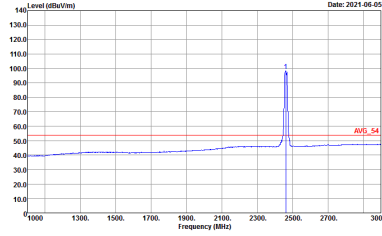

WIFI	2.4GHz 2400~2483.5MHz Band Edge @ 3m	
Chain	802.11g CH11 2462MHz	
0+1	Vertical	Fundamental
Peak	 <p>Level (dBuV/m) vs Frequency (MHz) plot for Vertical. The y-axis ranges from 10.0 to 140.0 dBuV/m, and the x-axis ranges from 2450 to 2500 MHz. A red vertical line marks the peak at approximately 2462 MHz, labeled 'PEAK_BE_74'. The plot shows a broad signal between 2450 and 2475 MHz, followed by a sharp peak at 2462 MHz.</p> <p>Site : 03CH15-HY            Condition : PEAK_BE_74 3m 91200_15_1620 VERTICAL            : RBW:1000.000KHz VBW:3000.000KHz SWT:Auto</p>	 <p>Level (dBuV/m) vs Frequency (MHz) plot for Fundamental. The y-axis ranges from 10.0 to 140.0 dBuV/m, and the x-axis ranges from 1000 to 3000 MHz. A red vertical line marks the peak at approximately 2462 MHz, labeled 'PEAK_74'. The plot shows a very narrow, sharp peak at 2462 MHz against a low noise floor.</p> <p>Site : 03CH15-HY            Condition : PEAK_74 3m 91200_15_1620 VERTICAL            : RBW:1000.000KHz VBW:3000.000KHz SWT:Auto</p>
Avg.	 <p>Level (dBuV/m) vs Frequency (MHz) plot for Average. The y-axis ranges from 10.0 to 140.0 dBuV/m, and the x-axis ranges from 2450 to 2500 MHz. A red vertical line marks the average level at approximately 2462 MHz, labeled 'AVG_BE_54'. The plot shows a broad signal between 2450 and 2475 MHz, followed by a sharp peak at 2462 MHz.</p> <p>Site : 03CH15-HY            Condition : AVG_BE_54 3m 91200_15_1620 VERTICAL            : RBW:1000.000KHz VBW:0.010KHz SWT:Auto</p>	 <p>Level (dBuV/m) vs Frequency (MHz) plot for Average. The y-axis ranges from 10.0 to 140.0 dBuV/m, and the x-axis ranges from 1000 to 3000 MHz. A red vertical line marks the average level at approximately 2462 MHz, labeled 'AVG_54'. The plot shows a very narrow, sharp peak at 2462 MHz against a low noise floor.</p> <p>Site : 03CH15-HY            Condition : AVG_54 3m 91200_15_1620 VERTICAL            : RBW:1000.000KHz VBW:0.010KHz SWT:Auto</p>



**2.4GHz 2400~2483.5MHz**  
**WIFI 802.11b (Harmonic @ 3m)**

<b>WIFI</b>	<b>2.4GHz 2400~2483.5MHz Harmonic @ 3m</b>	
<b>Chain</b>	<b>802.11b CH01 2412MHz</b>	
<b>0+1</b>	<b>Horizontal</b>	<b>Vertical</b>
<b>Peak</b> <b>Avg.</b>	<p>Site : 03CH15-HY          Condition : PEAK_74 3m 91200_15_1620 HORIZONTAL</p>	<p>Site : 03CH15-HY          Condition : PEAK_74 3m 91200_15_1620 VERTICAL</p>



2.4GHz 2400~2483.5MHz

WIFI 802.11ax HE20 Partial 106/53 (Harmonic @ 3m)

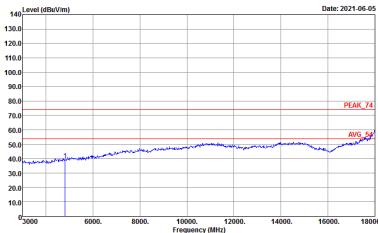
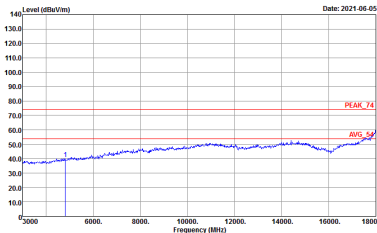
WIFI	2.4GHz 2400~2483.5MHz Harmonic @ 3m	
Chain	802.11ax HE20 Partial 106/53 CH01 2412MHz	
0+1	Horizontal	Vertical
<p>Peak</p> <p>Avg.</p>	 <p>Site Condition : 03CH15-HY : PEAK_74 3m 91200_15_1620 HORIZONTAL</p>	 <p>Site Condition : 03CH15-HY : PEAK_74 3m 91200_15_1620 VERTICAL</p>



**Emission above 18GHz  
WIFI 802.11ax HE20 Partial 106/53 (SHF)**

<b>WIFI</b>	<b>2.4GHz 2400~2483.5MHz</b>	
<b>Chain</b>	<b>802.11ax HE20 Partial 106/53 CH01 2412MHz</b>	
<b>0+1</b>	<b>Horizontal</b>	<b>Vertical</b>
<b>Peak Avg.</b>	<p>Site : 03CH15-1HY Condition : PEAK_74 1m SHF ANT_9170_00994 HORIZONTAL</p>	<p>Site : 03CH15-1HY Condition : PEAK_74 1m SHF ANT_9170_00994 VERTICAL</p>

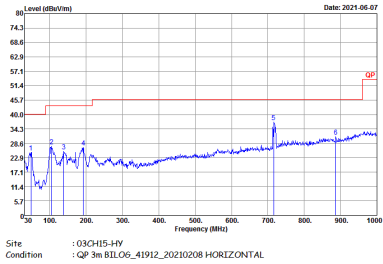
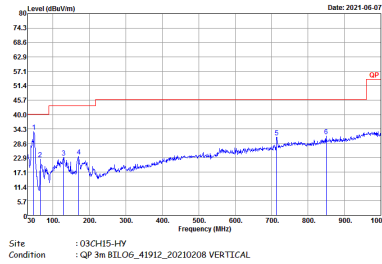

Emission below 1GHz  
WIFI 802.11ax HE20 Partial 106/53 (LF)

WIFI	2.4GHz 2400~2483.5MHz	
Chain	802.11ax HE20 Partial 106/53 LF	
0+1	Horizontal	Vertical
QP / Peak	 <p>Site : 03CH15-HY Condition : QP 3m BIL06_41912_20210208 HORIZONTAL</p>	 <p>Site : 03CH15-HY Condition : QP 3m BIL06_41912_20210208 VERTICAL</p>



## Appendix E. Duty Cycle Plots

Chain	Band	Duty Cycle(%)	T(us)	1/T(kHz)	VBW Setting	Duty Factor(dB)
0+1	802.11b	100.00	-	-	10Hz	0.00
0+1	802.11g	99.29	-	-	10Hz	0.03
0+1	2.4GHz 802.11ax HE20 106 RU	99.39	-	-	10Hz	0.03

### MIMO <Chain 0+1>

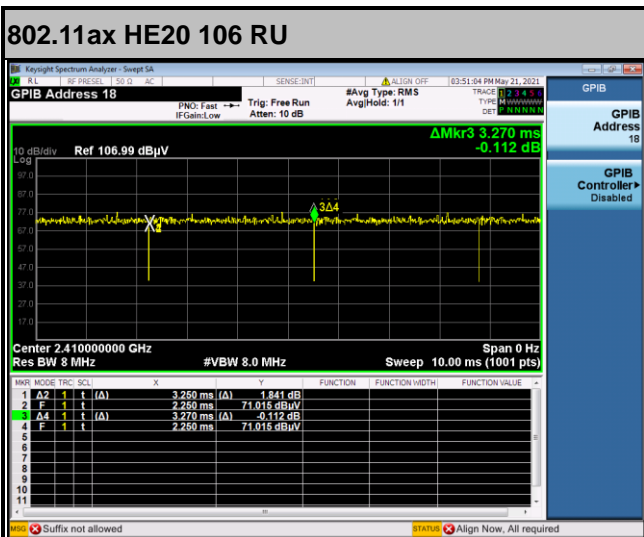
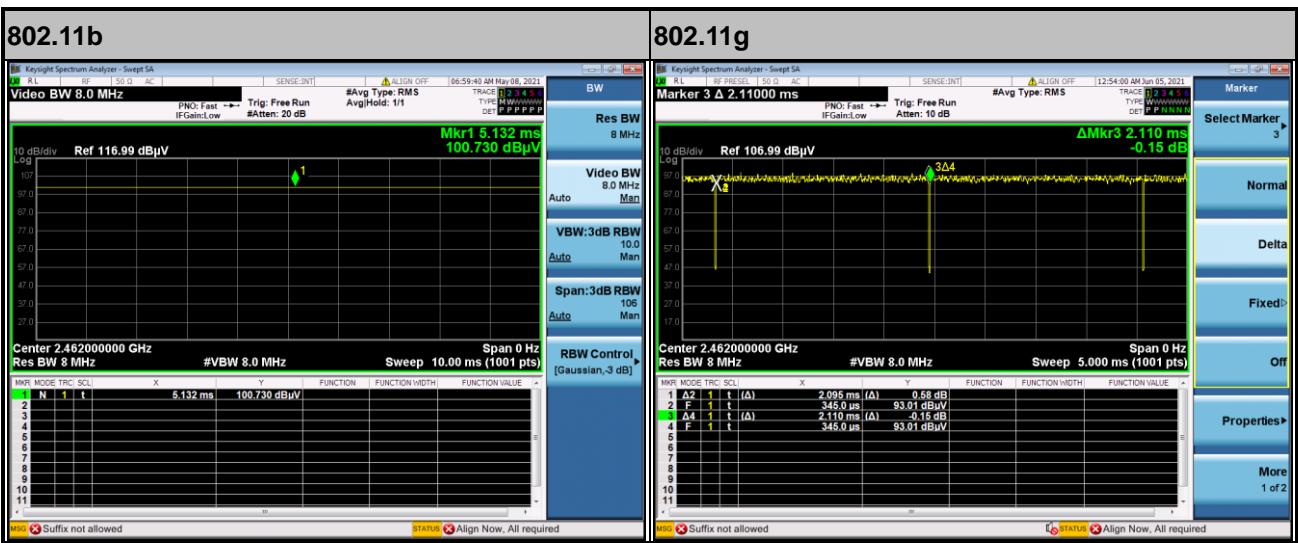

—THE END—