



# FCC RADIO TEST REPORT

**FCC ID** : PY7-53953L  
**Equipment** : GSM/WCDMA/LTE/5G Phone with BT, DTS/UNII a/b/g/n/ac/ax, GPS and NFC  
**Brand Name** : Sony  
**Applicant** : Sony Corporation  
1-7-1 Konan Minato-ku Tokyo, 108-0075 Japan  
**Manufacturer** : Sony Corporation  
1-7-1 Konan Minato-ku Tokyo, 108-0075 Japan  
**Standard** : FCC Part 15 Subpart C §15.247

The product was received on Apr. 27, 2021 and testing was started from May 10, 2021 and completed on Jun. 07, 2021. We, Sporton International Inc. EMC & Wireless Communications Laboratory, would like to declare that the tested sample has been evaluated in accordance with the test procedures and has been in compliance with the applicable technical standards.

The test results in this spot check data report apply exclusively to the tested model / sample. Without written approval of Sporton International Inc. EMC & Wireless Communications Laboratory, the test report shall not be reproduced except in full.

*Louis Wu*

Reviewed by: Louis Wu

**Sporton International Inc. EMC & Wireless Communications Laboratory**

No. 52, Huaya 1st Rd., Guishan Dist., Taoyuan City 333, Taiwan (R.O.C.)



## Table of Contents

History of this test report.....	3
Summary of Test Result.....	4
<b>1 General Description.....</b>	<b>5</b>
1.1 Product Feature of Equipment Under Test.....	5
1.2 Modification of EUT .....	5
1.3 Testing Location .....	6
1.4 Applicable Standards.....	6
<b>2 Test Configuration of Equipment Under Test .....</b>	<b>7</b>
2.1 Carrier Frequency Channel .....	7
2.2 Test Mode.....	8
2.3 Connection Diagram of Test System.....	8
2.4 Support Unit used in test configuration and system .....	9
2.5 EUT Operation Test Setup .....	9
<b>3 Test Result.....</b>	<b>10</b>
3.1 Output Power Measurement.....	10
3.2 Radiated Band Edges and Spurious Emission Measurement .....	11
3.3 Antenna Requirements .....	16
<b>4 List of Measuring Equipment .....</b>	<b>17</b>
<b>5 Uncertainty of Evaluation.....</b>	<b>18</b>
<b>Appendix A. Conducted Test Results</b>	
<b>Appendix B. Radiated Spurious Emission</b>	
<b>Appendix C. Radiated Spurious Emission Plots</b>	
<b>Appendix D. Duty Cycle Plots</b>	





### Summary of Test Result

Report Clause	Ref Std. Clause	Test Items	Result (PASS/FAIL)	Remark
-	15.247(a)(1)	Number of Channels	-	See Note
-	15.247(a)(1)	Hopping Channel Separation	-	See Note
-	15.247(a)(1)	Dwell Time of Each Channel	-	See Note
-	15.247(a)(1)	20dB Bandwidth	-	See Note
-	2.1049	99% Occupied Bandwidth	-	See Note
3.1	15.247(b)(1)	Peak Output Power	Pass	-
-	15.247(d)	Conducted Band Edges	-	See Note
-	15.247(d)	Conducted Spurious Emission	-	See Note
3.2	15.247(d)	Radiated Band Edges and Radiated Spurious Emission	Pass	Under limit 8.02 dB at 48.430 MHz
-	15.207	AC Conducted Emission	-	See Note
3.3	15.203 & 15.247(b)	Antenna Requirement	Pass	-

**Note:** The RF circuit, output power level and antenna performance is the same in Bluetooth function across all two FCC ID PY7-53953L and PY7-45256F, since the change, only verify RF output power and radiated spurious emission test data the worst mode was reported in this report.

<b>Declaration of Conformity:</b>
The test results with all measurement uncertainty excluded are presented in accordance with the regulation limits or requirements declared by manufacturers.
<b>Comments and Explanations:</b>
The declared of product specification for EUT presented in the report are provided by the manufacturer, and the manufacturer takes all the responsibilities for the accuracy of product specification.

**Reviewed by: Keven Cheng**  
**Report Producer: Cindy Liu**



# 1 General Description

## 1.1 Product Feature of Equipment Under Test

GSM/WCDMA/LTE, Bluetooth, DTS/UNII a/b/g/n/ac/ax, NFC, FM Receiver, and GNSS.

Product Specification subjective to this standard	
Antenna Type / Gain	<Ant. 0>: Loop Antenna with gain -2.3 dBi <Ant. 1>: Loop Antenna with gain -7.0 dBi

**Remark:** The above EUT's information was declared by manufacturer. Please refer to Comments and Explanations in report summary.

EUT Information List			
HW Version	SW Version	S/N	Performed Test Item
A	0.325	QV72003V7P	RF conducted measurement
	0.325	QV7200D87P	Radiated Spurious Emission

Accessory List	
AC Adapter	Model Name : XQZ-UC1
	S/N : 0020W51300039
Earphone	Model Name : STH40D
	S/N : N/A
USB Cable	Model Name : XQZ-UB1
	S/N : N/A

**Note:**

1. Above EUT list used are electrically identical per declared by manufacturer.
2. Above the accessories list are used to exercise the EUT during test, and the serial number of each type of accessories is listed in each section of this report.
3. For other wireless features of this EUT, test report will be issued separately.

## 1.2 Modification of EUT

No modifications are made to the EUT during all test items.



### 1.3 Testing Location

<b>Test Site</b>	Sporton International Inc. EMC & Wireless Communications Laboratory
<b>Test Site Location</b>	No.52, Huaya 1st Rd., Guishan Dist., Taoyuan City 333, Taiwan (R.O.C.) TEL: +886-3-327-3456 FAX: +886-3-328-4978
<b>Test Site No.</b>	<b>Sporton Site No.</b> TH02-HY
<b>Test Site</b>	Sporton International Inc. Wensan Laboratory
<b>Test Site Location</b>	No.58, Aly. 75, Ln. 564, Wenhua 3rd, Rd., Guishan Dist., Taoyuan City 333010, Taiwan (R.O.C.) TEL: +886-3-327-0868 FAX: +886-3-327-0855
<b>Test Site No.</b>	<b>Sporton Site No.</b> 03CH15-HY (TAF Code: 3786)
<b>Remark</b>	The Radiated Spurious Emission test item subcontracted to Sporton International Inc. Wensan Laboratory.

**Note:** The test site complies with ANSI C63.4 2014 requirement.

FCC designation No.: TW1190 and TW3786

### 1.4 Applicable Standards

According to the specifications of the manufacturer, the EUT must comply with the requirements of the following standards:

- ♦ FCC Part 15 Subpart C §15.247
- ♦ FCC KDB Publication No. 558074 D01 DTS Meas. Guidance v05r02
- ♦ FCC KDB 414788 D01 Radiated Test Site v01r01
- ♦ ANSI C63.10-2013

**Remark:**

1. All test items were verified and recorded according to the standards and without any deviation during the test.
2. The TAF code is not including all the FCC KDB listed without accreditation.
3. This EUT has also been tested and complied with the requirements of FCC Part 15, Subpart B, recorded in a separate test report.



## 2 Test Configuration of Equipment Under Test

### 2.1 Carrier Frequency Channel

Frequency Band	Channel	Freq. (MHz)	Channel	Freq. (MHz)	Channel	Freq. (MHz)
2400-2483.5 MHz	0	2402	27	2429	54	2456
	1	2403	28	2430	55	2457
	2	2404	29	2431	56	2458
	3	2405	30	2432	57	2459
	4	2406	31	2433	58	2460
	5	2407	32	2434	59	2461
	6	2408	33	2435	60	2462
	7	2409	34	2436	61	2463
	8	2410	35	2437	62	2464
	9	2411	36	2438	63	2465
	10	2412	37	2439	64	2466
	11	2413	38	2440	65	2467
	12	2414	39	2441	66	2468
	13	2415	40	2442	67	2469
	14	2416	41	2443	68	2470
	15	2417	42	2444	69	2471
	16	2418	43	2445	70	2472
	17	2419	44	2446	71	2473
	18	2420	45	2447	72	2474
	19	2421	46	2448	73	2475
	20	2422	47	2449	74	2476
	21	2423	48	2450	75	2477
	22	2424	49	2451	76	2478
	23	2425	50	2452	77	2479
	24	2426	51	2453	78	2480
	25	2427	52	2454	-	-
	26	2428	53	2455	-	-

## 2.2 Test Mode

- a. The EUT has been associated with peripherals and configuration operated in a manner tended to maximize its emission characteristics in a typical application. Frequency range investigated: radiation emission (9 kHz to the 10th harmonic of the highest fundamental frequency or to 40 GHz, whichever is lower). For radiated measurement, pre-scanned in three orthogonal panels, X, Y, Z. The worst cases (Z plane) were recorded in this report, and the worst mode of radiated spurious emissions is Bluetooth 3Mbps mode, and recorded in this report.

The following summary table is showing all test modes to demonstrate in compliance with the standard.

Summary table of Test Cases	
Test Item	Data Rate / Modulation
Radiated Test Cases	Bluetooth EDR 3Mbps 8-DPSK
	Mode 1: CH78_2480 MHz
<b>Remark:</b> For radiation spurious emission, the final modulation and the worst data rate was reference the original report worse case.	

## 2.3 Connection Diagram of Test System

<Bluetooth Tx Mode>

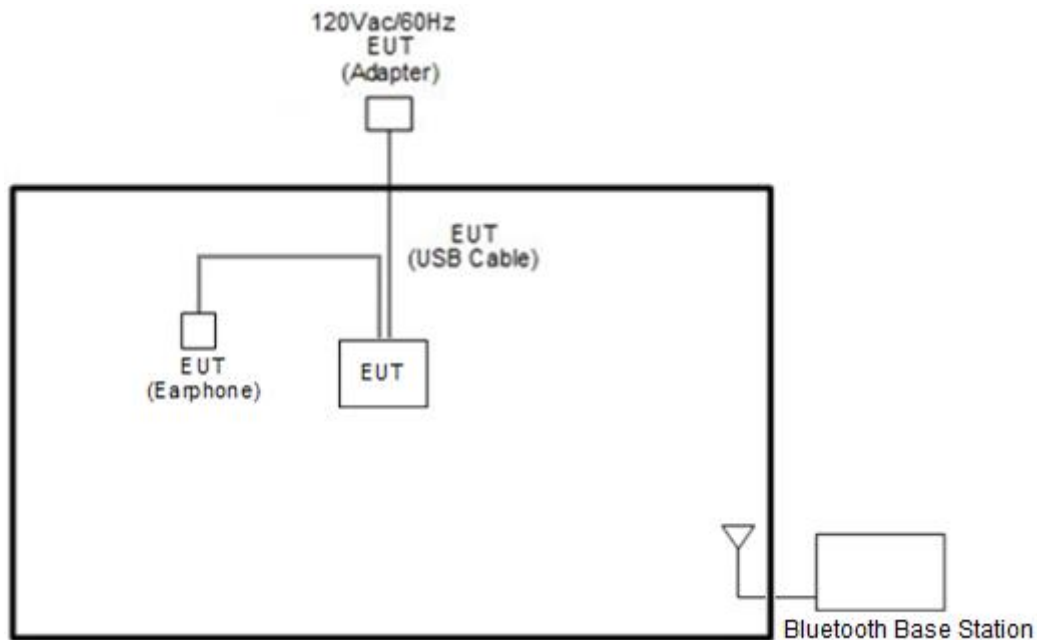





## 2.4 Support Unit used in test configuration and system

Item	Equipment	Brand Name	Model Name	FCC ID	Data Cable	Power Cord
1.	Bluetooth Base Station	R&S	CBT32	N/A	N/A	Unshielded, 1.8 m

## 2.5 EUT Operation Test Setup

The RF test items, utility "FTMC\_bridge V\_0.39" was installed in Notebook which was programmed in order to make the EUT get into the engineering modes to contact with base station to provide channel selection, power level, data rate and the application type and for continuous transmitting signals.

### **3 Test Result**

#### **3.1 Output Power Measurement**

##### **3.1.1 Limit of Output Power**

The maximum peak conducted output power of the intentional radiator shall not exceed the following:  
For frequency hopping systems operating in the 2400-2483.5 MHz band employing at least 75 non-overlapping hopping channels, and all frequency hopping systems in the 5725-5850 MHz band: 1 watt. For all other frequency hopping systems in the 2400-2483.5 MHz band 0.125 watts.

##### **3.1.2 Measuring Instruments**

See list of measuring equipment of this test report.

##### **3.1.3 Test Procedures**

1. The testing follows ANSI C63.10-2013 clause 7.8.5.
2. The RF output of EUT was connected to the power meter by RF cable and attenuator. The path loss was compensated to the results for each measurement.
3. Set the maximum power setting and enable the EUT to transmit continuously.
4. Measure the conducted output power with cable loss and record the results in the test report.
5. Measure and record the results in the test report.

##### **3.1.4 Test Setup**

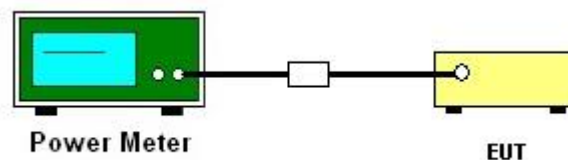

##### **3.1.5 Test Result of Peak Output Power**

Please refer to Appendix A.

##### **3.1.6 Test Result of Average Output Power (Reporting Only)**

Please refer to Appendix A.



## 3.2 Radiated Band Edges and Spurious Emission Measurement

### 3.2.1 Limit of Radiated Band Edges and Spurious Emission

In any 100 kHz bandwidth outside the intentional radiator frequency band, all harmonics / spurious must be at least 20 dB below the highest emission level within the authorized band. In addition, radiated emissions which fall in the restricted bands must also comply with the limits as below.

Frequency (MHz)	Field Strength (microvolts/meter)	Measurement Distance (meters)
0.009 – 0.490	2400/F(kHz)	300
0.490 – 1.705	24000/F(kHz)	30
1.705 – 30.0	30	30
30 – 88	100	3
88 – 216	150	3
216 - 960	200	3
Above 960	500	3

### 3.2.2 Measuring Instruments

See list of measuring equipment of this test report.



### 3.2.3 Test Procedures

1. The EUT was placed on a turntable with 0.8 meter for frequency below 1 GHz and 1.5 meter for frequency above 1 GHz respectively above ground.
2. The EUT was set 3 meters from the interference receiving antenna, which was mounted on the top of a variable height antenna tower.
3. For each suspected emission, the EUT was arranged to its worst case and then tune the Antenna tower (from 1 m to 4 m) and turntable (from 0 degree to 360 degrees) to find the maximum reading. A pre-amp and a high pass filter are used for the test in order to get better signal level to comply with the guidelines.
4. Set the maximum power setting and enable the EUT to transmit continuously.
5. Use the following spectrum analyzer settings:
  - (1) Span shall wide enough to fully capture the emission being measured;
  - (2) Set RBW = 100 kHz for  $f < 1$  GHz, RBW = 1 MHz for  $f > 1$  GHz ; VBW  $\geq$  RBW; Sweep = auto; Detector function = peak; Trace = max hold for peak
  - (3) For average measurement: use duty cycle correction factor method per 15.35(c).  
Duty cycle = On time/100 milliseconds  
On time =  $N_1 * L_1 + N_2 * L_2 + \dots + N_{n-1} * L_{n-1} + N_n * L_n$   
Where  $N_1$  is number of type 1 pulses,  $L_1$  is length of type 1 pulses, etc.  
Average Emission Level = Peak Emission Level +  $20 * \log(\text{Duty cycle})$
6. Corrected Reading: Antenna Factor + Cable Loss + Read Level - Preamp Factor = Level
7. For testing below 1 GHz, if the emission level of the EUT in peak mode was 3 dB lower than the limit specified, then peak values of EUT will be reported, otherwise, the emissions will be repeated one by one using the CISPR quasi-peak method and reported.
8. For testing above 1 GHz, the emission level of the EUT in peak mode was 20 dB lower than average limit (that means the emission level in average mode also complies with the limit in average mode), then peak values of EUT will be reported, otherwise, the emissions will be measured in average mode again and reported.

Note: The average levels were calculated from the peak level corrected with duty cycle correction factor (-24.79dB) derived from  $20 \log(\text{dwell time}/100\text{ms})$ . This correction is only for signals that hop with the fundamental signal, such as band-edge and harmonic. Other spurious signals that are independent of the hopping signal would not use this correction.

### 3.2.4 Test Setup

For radiated test below 30MHz

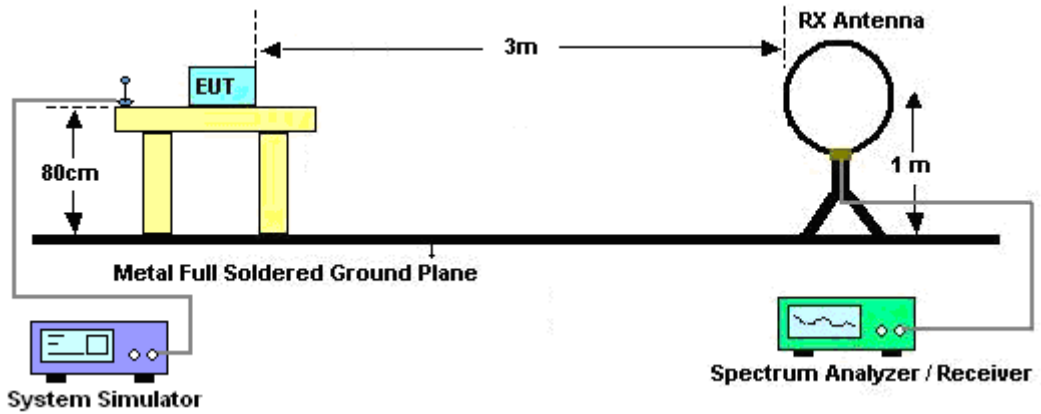

For radiated test from 30MHz to 1GHz

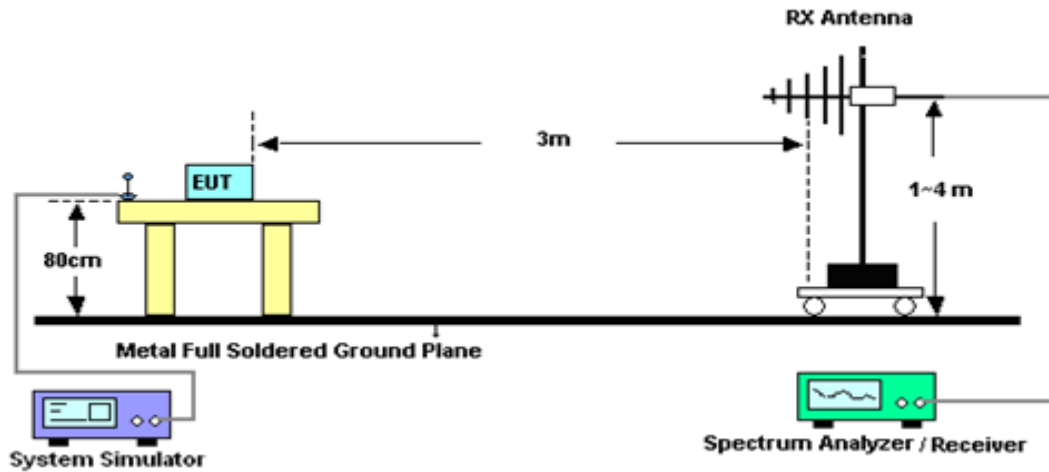

For radiated test from 1GHz to 18GHz

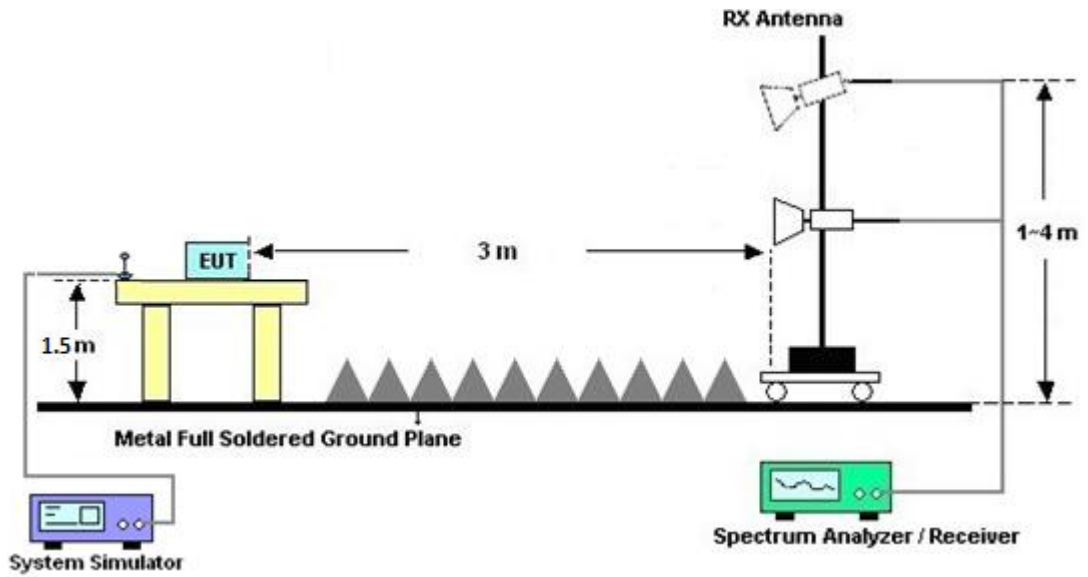

For radiated test above 18GHz

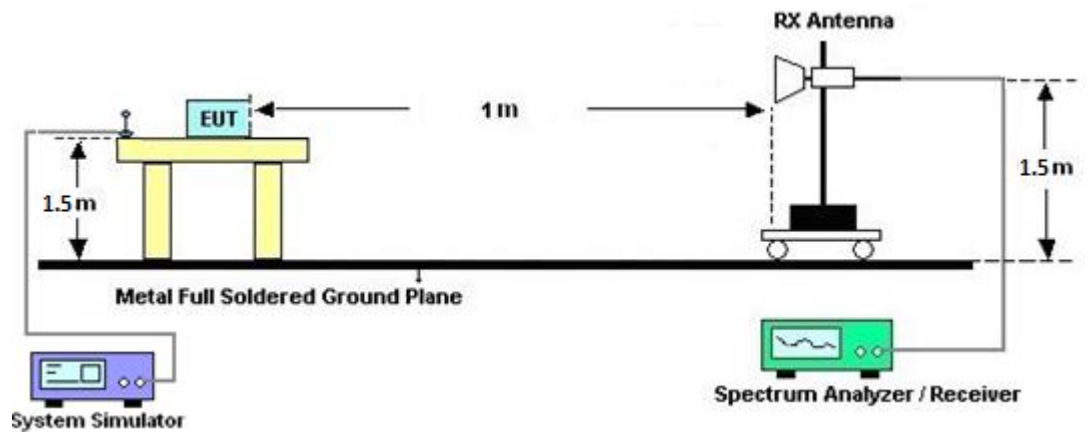



### **3.2.5 Test Results of Radiated Spurious Emissions (9 kHz ~ 30 MHz)**

The low frequency, which started from 9 kHz to 30MHz, was pre-scanned and the result which was 20dB lower than the limit line was not reported.

There is adequate comparison measurement of both open-field test site and alternative test site - semi-Anechoic chamber according to 414788 D01 Radiated Test Site v01r01, and the result came out very similar.

### **3.2.6 Test Result of Radiated Spurious at Band Edges**

Please refer to Appendix B and C.

### **3.2.7 Duty Cycle**

Please refer to Appendix D.

### **3.2.8 Test Result of Radiated Spurious Emission (30MHz ~ 10<sup>th</sup> Harmonic)**

Please refer to Appendix B and C.



### **3.3 Antenna Requirements**

#### **3.3.1 Standard Applicable**

If directional gain of transmitting antennas is greater than 6 dBi, the power shall be reduced by the same level in dB comparing to gain minus 6 dBi. The use of a permanently attached antenna or of an antenna that uses a unique coupling to the intentional radiator shall be considered sufficient to comply with the rule.

#### **3.3.2 Antenna Anti-Replacement Construction**

An embedded-in antenna design is used.

#### **3.3.3 Antenna Gain**

The antenna peak gain of EUT is less than 6 dBi. Therefore, it is not necessary to reduce maximum peak output power limit.





## 4 List of Measuring Equipment

Instrument	Brand Name	Model No.	Serial No.	Characteristics	Calibration Date	Test Date	Due Date	Remark
Loop Antenna	Rohde & Schwarz	HFH2-Z2	100488	9 kHz~30 MHz	Jul. 14, 2020	May 31, 2021~ Jun. 07, 2021	Jul. 13, 2021	Radiation (03CH15-HY)
Bilog Antenna	TESEQ	CBL 6111D & 00800N1D01N- 06	41912 & 05	30MHz~1GHz	Feb. 08, 2021	May 31, 2021~ Jun. 07, 2021	Feb. 07, 2022	Radiation (03CH15-HY)
Amplifier	SONOMA	310N	363440	9kHz~1GHz	Dec. 28, 2020	May 31, 2021~ Jun. 07, 2021	Dec. 27, 2021	Radiation (03CH15-HY)
Horn Antenna	SCHWARZB ECK	BBHA 9120 D	9120D-01620	1GHz~18GHz	Nov. 03, 2020	May 31, 2021~ Jun. 07, 2021	Nov. 02, 2021	Radiation (03CH15-HY)
SHF-EHF Horn Antenna	SCHWARZB ECK	BBHA 9170	BBHA9170251	18GHz~40GHz	Dec. 02, 2020	May 31, 2021~ Jun. 07, 2021	Dec. 01, 2021	Radiation (03CH15-HY)
Preamplifier	Jet-Power	JPA0118-55-30 3	1710001800055 006	1GHz~18GHz	May 06, 2021	May 31, 2021~ Jun. 07, 2021	May 05, 2022	Radiation (03CH15-HY)
Preamplifier	Keysight	83017A	MY53270195	1GHz~26.5GHz	Aug. 21, 2020	May 31, 2021~ Jun. 07, 2021	Aug. 20, 2021	Radiation (03CH15-HY)
Preamplifier	EMEC	EM18G40G	0600789	18-40GHz	Oct. 27, 2020	May 31, 2021~ Jun. 07, 2021	Oct. 26, 2021	Radiation (03CH15-HY)
EMI Test Receiver	Keysight	N9038A(MXE)	MY54130085	20MHz~8.4GHz	Nov. 02, 2020	May 31, 2021~ Jun. 07, 2021	Nov. 01, 2021	Radiation (03CH15-HY)
Spectrum Analyzer	Keysight	N9010A	MY54200485	10Hz~44GHz	Mar. 05, 2021	May 31, 2021~ Jun. 07, 2021	Mar. 04, 2022	Radiation (03CH15-HY)
Antenna Mast	ChainTek	MBS-520-1	N/A	1m~4m	N/A	May 31, 2021~ Jun. 07, 2021	N/A	Radiation (03CH15-HY)
Turn Table	ChainTek	T-200-S-1	N/A	0~360 Degree	N/A	May 31, 2021~ Jun. 07, 2021	N/A	Radiation (03CH15-HY)
Software	Audix	E3 6.2009-8-24(k5)	RK-000451	N/A	N/A	May 31, 2021~ Jun. 07, 2021	N/A	Radiation (03CH15-HY)
RF Cable	HUBER + SUHNER	SUCOFLEX 104, 102E	MY36980/4, MY9838/4PE,50 8405/2E	30MHz~18G	Nov. 16, 2020	May 31, 2021~ Jun. 07, 2021	Nov. 15, 2021	Radiation (03CH15-HY)
RF Cable	HUBER + SUHNER	SUCOFLEX 102	505134/2	30MHz-40GHz	Feb. 22, 2021	May 31, 2021~ Jun. 07, 2021	Feb. 21, 2022	Radiation (03CH15-HY)
RF Cable	HUBER + SUHNER	SUCOFLEX 102	800740/2	30MHz-40GHz	Feb. 22, 2021	May 31, 2021~ Jun. 07, 2021	Feb. 21, 2022	Radiation (03CH15-HY)
RF Cable	HUBER + SUHNER	SUCOFLEX 104	MY9837/4PE	9kHz~30MHz	Mar. 11, 2021	May 31, 2021~ Jun. 07, 2021	Mar. 10, 2022	Radiation (03CH15-HY)
Filter	Wainwright	WLJ4-1000-153 0-6000-40ST	SN4	1.53GHz Low Pass Filter	Jul. 03, 2020	May 31, 2021~ Jun. 07, 2021	Jul. 02, 2021	Radiation (03CH15-HY)
Filter	Wainwright	WHKX12-2700- 3000-18000-60 ST	SN4	3GHz High Pass Filter	Sep. 16, 2020	May 31, 2021~ Jun. 07, 2021	Sep. 15, 2021	Radiation (03CH15-HY)
Hygrometer	Testo	608-H1	34893241	N/A	Mar. 02, 2021	May 10, 2021	Mar. 01, 2022	Conducted (TH02-HY)
Power Meter	Agilent	E4416A	GB41292344	N/A	Jan. 14, 2021	May 10, 2021	Jan. 13, 2022	Conducted (TH02-HY)
Power Sensor	Agilent	E9327A	US40441548	50MHz~18GHz	Jan. 14, 2021	May 10, 2021	Jan. 13, 2022	Conducted (TH02-HY)
Signal Analyzer	Rohde & Schwarz	FSV40	101566	10Hz ~ 40GHz	Jul. 22, 2020	May 10, 2021	Jul. 21, 2021	Conducted (TH02-HY)
BT Base Station	Rohde & Schwarz	CBT	101135	BT 3.0	Sep. 15, 2020	May 10, 2021	Sep. 14, 2022	Conducted (TH02-HY)
Switch Box & RF Cable	EM Electronics	EMSW18SE	SW200302	N/A	Mar. 17, 2021	May 10, 2021	Mar. 16, 2022	Conducted (TH02-HY)



## 5 Uncertainty of Evaluation

### Uncertainty of Radiated Emission Measurement (30 MHz ~ 1000 MHz)

Measuring Uncertainty for a Level of Confidence of 95% ( $U = 2Uc(y)$ )	4.7 dB
---	--------

### Uncertainty of Radiated Emission Measurement (1000 MHz ~ 18000 MHz)

Measuring Uncertainty for a Level of Confidence of 95% ( $U = 2Uc(y)$ )	5.3 dB
---	--------

### Uncertainty of Radiated Emission Measurement (18000 MHz ~ 40000 MHz)

Measuring Uncertainty for a Level of Confidence of 95% ( $U = 2Uc(y)$ )	4.9 dB
---	--------

## Appendix A. Test Result of Conducted Test Items

Test Engineer:	Eason Huang	Temperature:	21~25	°C
Test Date:	2021/5/10	Relative Humidity:	51~54	%

&lt;Ant. 0&gt;

### TEST RESULTS DATA

#### Peak Power Table

DH	CH.	NTX	Peak Power (dBm)	Power Limit (dBm)	Test Result
DH1	0	1	13.85	20.97	Pass
	39	1	13.56	20.97	Pass
	78	1	<b>13.91</b>	20.97	Pass
2DH1	0	1	15.03	20.97	Pass
	39	1	14.89	20.97	Pass
	78	1	<b>15.11</b>	20.97	Pass
3DH1	0	1	15.36	20.97	Pass
	39	1	15.23	20.97	Pass
	78	1	<b>15.41</b>	20.97	Pass

### TEST RESULTS DATA

#### Average Power Table

(Reporting Only)

DH	CH.	NTX	Average Power (dBm)	Duty Factor (dB)
DH1	0	1	13.45	5.20
	39	1	13.40	5.20
	78	1	<b>13.52</b>	5.20
2DH1	0	1	12.50	5.08
	39	1	12.46	5.08
	78	1	<b>12.63</b>	5.08
3DH1	0	1	12.53	5.08
	39	1	12.48	5.08
	78	1	<b>12.68</b>	5.08

&lt;Ant. 1&gt;

**TEST RESULTS DATA****Peak Power Table**

DH	CH.	NTX	Peak Power (dBm)	Power Limit (dBm)	Test Result
DH1	0	1	13.60	20.97	Pass
	39	1	<b>13.77</b>	20.97	Pass
	78	1	13.55	20.97	Pass
2DH1	0	1	14.61	20.97	Pass
	39	1	<b>14.72</b>	20.97	Pass
	78	1	14.51	20.97	Pass
3DH1	0	1	14.93	20.97	Pass
	39	1	<b>15.04</b>	20.97	Pass
	78	1	14.85	20.97	Pass

**TEST RESULTS DATA****Average Power Table***(Reporting Only)*

DH	CH.	NTX	Average Power (dBm)	Duty Factor (dB)
DH1	0	1	13.28	5.20
	39	1	<b>13.33</b>	5.20
	78	1	13.22	5.20
2DH1	0	1	12.22	5.20
	39	1	<b>12.35</b>	5.20
	78	1	12.19	5.20
3DH1	0	1	12.24	5.20
	39	1	<b>12.38</b>	5.20
	78	1	12.21	5.20



### Appendix B. Radiated Spurious Emission

Test Engineer :	Leo Lee, Mancy Chou and Bigshow Wang	Temperature :	22.7~23.7°C
		Relative Humidity :	46~52%

#### 2.4GHz 2400~2483.5MHz

#### BT (Band Edge @ 3m)

BT Ant.	Note	Frequency ( MHz )	Level ( dBμV/m )	Over Limit ( dB )	Limit Line ( dBμV/m )	Read Level ( dBμV )	Antenna Factor ( dB/m )	Path Loss ( dB )	Preamp Factor ( dB )	Ant Pos ( cm )	Table Pos ( deg )	Peak Avg. ( P/A )	Pol. ( H/V )	
BT CH 78 2480MHz	*	2480	103.53	-	-	100.19	27.44	6.78	30.88	356	231	P	H	
	*	2480	78.74	-	-	-	-	-	-	-	-	A	H	
		2483.92	46.8	-27.2	74	43.46	27.43	6.79	30.88	356	231	P	H	
		2483.92	22.01	-31.99	54	-	-	-	-	-	-	A	H	
													H	
														H
	*	2480	105.25	-	-	101.91	27.44	6.78	30.88	100	251	P	V	
	*	2480	80.46	-	-	-	-	-	-	-	-	-	A	V
		2483.56	48.98	-25.02	74	45.64	27.43	6.79	30.88	100	251	P	V	
		2483.56	24.19	-29.81	54	-	-	-	-	-	-	A	V	
														V
														V
Remark	1. No other spurious found. 2. All results are PASS against Peak and Average limit line.													



2.4GHz 2400~2483.5MHz
BT (Harmonic @ 3m)

Table with 14 columns: BT Ant. 0, Note, Frequency (MHz), Level (dBµV/m), Over Limit (dB), Limit Line (dBµV/m), Read Level (dBµV), Antenna Factor (dB/m), Path Loss (dB), Preamp Factor (dB), Ant Pos (cm), Table Pos (deg), Peak Avg. (P/A), Pol. (H/V). Rows include data for BT CH 78 2480MHz at various frequencies (4960, 7440, 18000, 17985 MHz) and a Remark section.



Emission above 18GHz

2.4GHz BT (SHF)

BT	Note	Frequency	Level	Over	Limit	Read	Antenna	Path	Preamp	Ant	Table	Peak	Pol.
Ant.				Limit	Line	Level	Factor	Loss	Factor	Pos	Pos	Avg.	
0		( MHz )	( dBμV/m )	( dB )	( dBμV/m )	(dBμV)	( dB/m )	( dB )	( dB )	( cm )	( deg )	(P/A)	(H/V)
2.4GHz BT SHF		23187	38.72	-35.28	74	56.19	39.7	-3.11	54.06	150	0	P	H
													H
													H
													H
													H
													H
													H
													H
													H
													H
													H
													H
													H
													H
													H
													H
													H
													H
													H
			23607	38.25	-35.75	74	55.5	39.66	-2.97	53.94	150	0	P
													V
													V
													V
													V
													V
													V
													V
													V
													V
													V
													V
													V
													V
													V
Remark	1. No other spurious found. 2. All results are PASS against limit line.												



Emission below 1GHz

2.4GHz BT (LF)

BT	Note	Frequency	Level	Over	Limit	Read	Antenna	Path	Preamp	Ant	Table	Peak	Pol.	
Ant.				Limit	Line	Level	Factor	Loss	Factor	Pos	Pos	Avg.		
0		( MHz )	( dBμV/m )	( dB )	( dBμV/m )	(dBμV)	( dB/m )	( dB )	( dB )	( cm )	( deg )	(P/A)	(H/V)	
2.4GHz BT LF		49.4	24.9	-15.1	40	42	14.57	0.91	32.58	-	-	P	H	
		99.84	28.51	-14.99	43.5	43.66	15.91	1.44	32.5	-	-	P	H	
		136.7	25.72	-17.78	43.5	39.13	17.43	1.67	32.51	-	-	P	H	
		191.99	27.11	-16.39	43.5	42.8	14.76	2.01	32.46	-	-	P	H	
		703.18	29.36	-16.64	46	31.81	26.4	3.6	32.45	-	-	P	H	
		943.74	32.99	-13.01	46	29.67	30.34	4.32	31.34	100	0	P	H	
														H
														H
														H
														H
														H
														H
														H
			48.43	31.98	-8.02	40	48.71	14.95	0.9	32.58	100	0	P	V
			128.94	23.28	-20.22	43.5	36.66	17.53	1.62	32.53	-	-	P	V
			168.71	23.35	-20.15	43.5	38.27	15.7	1.87	32.49	-	-	P	V
			555.74	26.26	-19.74	46	29.96	25.69	3.23	32.62	-	-	P	V
			755.56	30.28	-15.72	46	30.96	28	3.74	32.42	-	-	P	V
			901.06	30.77	-15.23	46	29.29	28.94	4.16	31.62	-	-	P	V
														V
													V	
													V	
													V	
													V	
													V	
<b>Remark</b>	1. No other spurious found. 2. All results are PASS against limit line.													





**Note symbol**

*	<b>Fundamental Frequency</b> which can be ignored. However, the level of any unwanted emissions shall not exceed the level of the fundamental frequency.
!	Test result is <b>over limit</b> line.
P/A	<b>Peak</b> or <b>Average</b>
H/V	<b>Horizontal</b> or <b>Vertical</b>



A calculation example for radiated spurious emission is shown as below:

BT	Note	Frequency	Level	Over	Limit	Read	Antenna	Path	Preamp	Ant	Table	Peak	Pol.
		( MHz )	( dBμV/m )	( dB )	( dBμV/m )	( dBμV )	( dB/m )	( dB )	( dB )	( cm )	( deg )	( P/A )	( H/V )
BT CH 00 2402MHz		2390	55.45	-18.55	74	54.51	32.22	4.58	35.86	103	308	P	H
		2390	43.54	-10.46	54	42.6	32.22	4.58	35.86	103	308	A	H

1. Path Loss(dB) = Cable loss(dB) + Filter loss(dB) + Attenuator loss(dB)
2. Level(dBμV/m) =  
Antenna Factor(dB/m) + Path Loss(dB) + Read Level(dBμV) - Preamp Factor(dB)
3. Over Limit(dB) = Level(dBμV/m) – Limit Line(dBμV/m)

**For Peak Limit @ 2390MHz:**

1. Level(dBμV/m)  
= Antenna Factor(dB/m) + Path Loss(dB) + Read Level(dBμV) - Preamp Factor(dB)  
= 32.22(dB/m) + 4.58(dB) + 54.51(dBμV) – 35.86 (dB)  
= 55.45 (dBμV/m)
2. Over Limit(dB)  
= Level(dBμV/m) – Limit Line(dBμV/m)  
= 55.45(dBμV/m) – 74(dBμV/m)  
= -18.55(dB)

**For Average Limit @ 2390MHz:**

1. Level(dBμV/m)  
= Antenna Factor(dB/m) + Path Loss(dB) + Read Level(dBμV) - Preamp Factor(dB)  
= 32.22(dB/m) + 4.58(dB) + 42.6(dBμV) – 35.86 (dB)  
= 43.54 (dBμV/m)
2. Over Limit(dB)  
= Level(dBμV/m) – Limit Line(dBμV/m)  
= 43.54(dBμV/m) – 54(dBμV/m)  
= -10.46(dB)

Both peak and average measured complies with the limit line, so test result is "PASS".



## Appendix C. Radiated Spurious Emission Plots

Test Engineer :	Leo Lee, Mancy Chou and Bigshow Wang	Temperature :	22.7~23.7°C
		Relative Humidity :	46~52%

### 2.4GHz 2400~2483.5MHz

### BT (Band Edge @ 3m)

BT	2.4GHz 2400~2483.5MHz Band Edge @ 3m	
Ant.	BT CH78 2480MHz	
0	Horizontal	Fundamental
Peak	<p>Site Condition : 03CH15-4Y : PEAK_BE_74 3m 91200_15_1620 HORIZONTAL : RBW:1000.000KHz VBW:3000.000KHz SWT:Auto</p>	<p>Site Condition : 03CH15-4Y : PEAK_74 3m 91200_15_1620 HORIZONTAL : RBW:1000.000KHz VBW:3000.000KHz SWT:Auto</p>

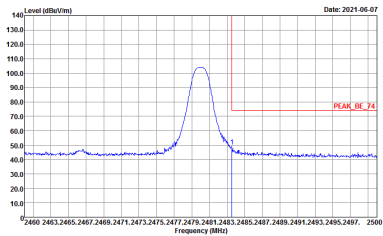
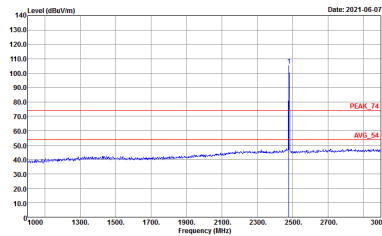

BT	2.4GHz 2400~2483.5MHz Band Edge @ 3m	
Ant.	BT CH78 2480MHz	
0	Vertical	Fundamental
Peak	 <p>Site : 03CH15-HY          Condition : PEAK_BC_74 3m 9120D_15_1620 VERTICAL          : RBW:1000.000KHz VBW:3000.000KHz SWT:Auto</p>	 <p>Site : 03CH15-HY          Condition : PEAK_74 3m 9120D_15_1620 VERTICAL          : RBW:1000.000KHz VBW:3000.000KHz SWT:Auto</p>



2.4GHz 2400~2483.5MHz

BT (Harmonic @ 3m)

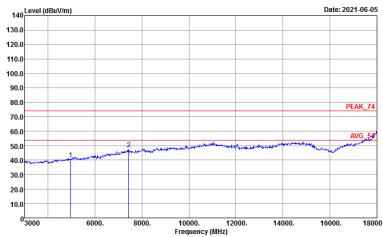
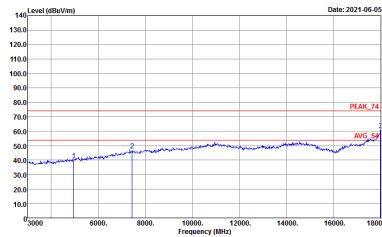
BT	2.4GHz 2400~2483.5MHz Harmonic @ 3m	
Ant.	BT CH78 2480MHz	
0	Horizontal	Vertical
Peak Avg.	 <p>Site : 03CH15-HY Condition : PEAK_74 3m 91200_15_1620 HORIZONTAL Detector : Peak</p>	 <p>Site : 03CH15-HY Condition : PEAK_74 3m 91200_15_1620 VERTICAL Detector : Peak</p>



Emission above 18GHz

2.4GHz BT (SHF)

<b>BT</b>	<b>2.4GHz 2400~2483.5MHz</b>	
<b>Ant.</b>	<b>BT SHF</b>	
<b>0</b>	<b>Horizontal</b>	<b>Vertical</b>
<b>Peak</b> <b>Avg.</b>	<p>Site : 03CH15-HY Condition : PEAK_74 In SHF ANT_9170_00994 HORIZONTAL</p>	<p>Site : 03CH15-HY Condition : PEAK_74 In SHF ANT_9170_00994 VERTICAL</p>



Emission below 1GHz  
2.4GHz BT (LF)

BT	2.4GHz 2400~2483.5MHz	
Ant.	BT LF	
0	Horizontal	Vertical
QP / Peak	<p>Site : 03CH15-HY Condition : QP 3m BIL06_41912_20210208 HORIZONTAL Detector : Peak</p>	<p>Site : 03CH15-HY Condition : QP 3m BIL06_41912_20210208 VERTICAL Detector : Peak</p>



# Appendix D. Duty Cycle Plots

<Ant. 0>

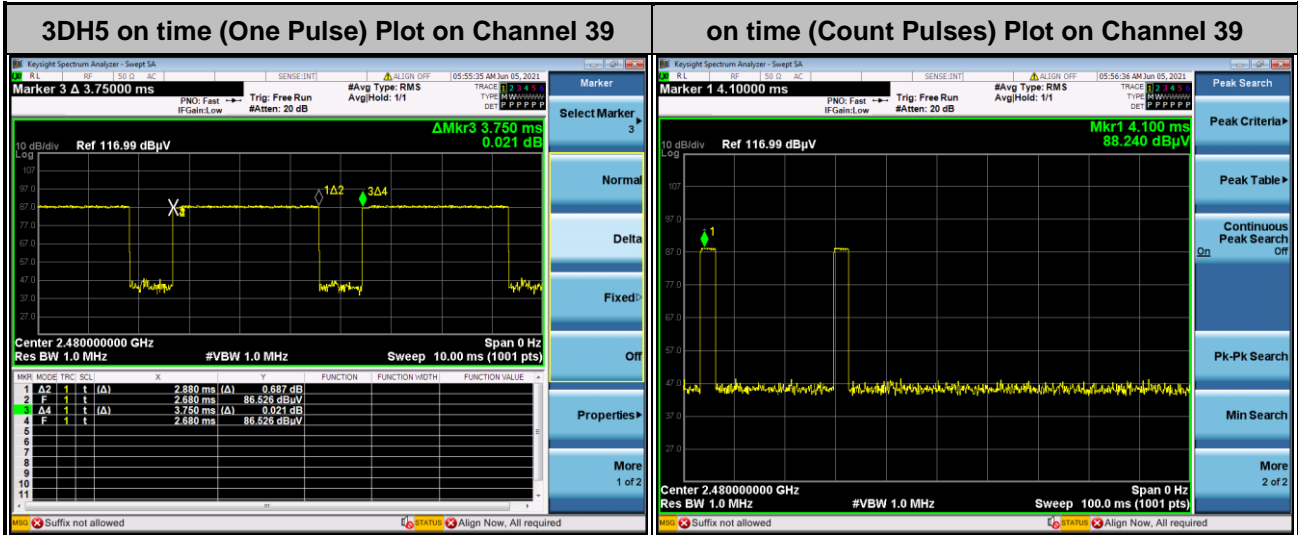

**Note:**

1. Worst case Duty cycle = on time/100 milliseconds = 2 \* 2.88 / 100 = 5.76 %
2. Worst case Duty cycle correction factor = 20\*log(Duty cycle) = -24.79 dB
3. **3DH5** has the highest duty cycle worst case and is reported.

**Duty Cycle Correction Factor Consideration for AFH mode:**

Bluetooth normal hopping rate is 1600Hz and reduced to 800Hz in AFH mode; due to the reduced number of hopping frequencies, with the same packet configuration the dwell time in each channel frequency within 100msec period is longer in AFH mode than normal mode.

In AFH mode, the minimum hopping frequencies are 20, to get the longest dwell time DH5 packet is observed; the period to have DH5 packet completing one hopping sequence is

$$2.88 \text{ ms} \times 20 \text{ channels} = 57.6 \text{ ms}$$

There cannot be 2 complete hopping sequences within 100ms period, considering the random hopping behavior, maximum 2 hops can be possibly observed within the period. [100 ms / 57.6 ms] = 2 hops

Thus, the maximum possible ON time:

$$2.88 \text{ ms} \times 2 = 5.76 \text{ ms}$$

Worst case Duty Cycle Correction factor, which is derived from the maximum possible ON time,

$$20 \times \log(5.76 \text{ ms}/100 \text{ ms}) = -24.79 \text{ dB}$$

—THE END—