



FCC RADIO TEST REPORT

FCC ID : PY7-502520
Equipment : GSM/WCDMA/LTE Phone with BT, DTS/UNII
a/b/g/n/ac, GPS and NFC
Brand Name : Sony
Applicant : Sony Mobile Communications Inc.
4-12-3 Higashi-Shinagawa, Shinagawa-ku,
Tokyo, 140-0002, Japan
Manufacturer : Sony Mobile Communications Inc.
4-12-3 Higashi-Shinagawa, Shinagawa-ku,
Tokyo, 140-0002, Japan
Standard : FCC Part 15 Subpart E §15.407

The product was received on Jun. 10, 2019 and testing was started from Jul. 17, 2019 and completed on Jul. 23, 2019. We, SPORTON INTERNATIONAL INC. EMC & Wireless Communications Laboratory, would like to declare that the tested sample has been evaluated in accordance with the test procedures and has been in compliance with the applicable technical standards.

The report must not be used by the client to claim product certification, approval, or endorsement by TAF or any agency of government.

The test results in this spot check data report apply exclusively to the tested model / sample. Without written approval of SPORTON INTERNATIONAL INC. EMC & Wireless Communications Laboratory, the test report shall not be reproduced except in full.

Approved by: Jones Tsai

SPORTON INTERNATIONAL INC. EMC & Wireless Communications Laboratory
No. 52, Huaya 1st Rd., Guishan Dist., Taoyuan City, Taiwan (R.O.C.)



Table of Contents

History of this test report3

Summary of Test Result4

1 General Description.....5

 1.1 Product Feature of Equipment Under Test5

 1.2 Modification of EUT6

 1.3 Testing Location6

 1.4 Applicable Standards6

2 Test Configuration of Equipment Under Test.....7

 2.1 Carrier Frequency and Channel.....7

 2.2 Test Mode.....8

 2.3 Connection Diagram of Test System9

 2.4 EUT Operation Test Setup9

3 Test Result.....10

 3.1 Maximum Conducted Output Power Measurement10

 3.2 Unwanted Emissions Measurement.....12

 3.3 Antenna Requirements.....17

4 List of Measuring Equipment18

5 Uncertainty of Evaluation.....20

Appendix A. Conducted Test Results

Appendix B. Radiated Spurious Emission

Appendix C. Radiated Spurious Emission Plots

Appendix D. Duty Cycle Plots



Summary of Test Result

Report Clause	Ref Std. Clause	Test Items	Result (PASS/FAIL)	Remark
-	15.403(i)	6dB & 26dB Bandwidth	Not Required	-
-	2.1049	99% Occupied Bandwidth	Not Required	-
3.1	15.407(a)	Maximum Conducted Output Power	Pass	-
-	15.407(a)	Power Spectral Density	Not Required	-
3.2	15.407(b)	Unwanted Emissions	Pass	Under limit 6.54 dB at 5459.920 MHz
-	15.207	AC Conducted Emission	Not Required	-
-	15.407(c)	Automatically Discontinue Transmission	Not Required	-
3.3	15.203 15.407(a)	Antenna Requirement	Pass	-

Remark:

1. Not required means after assessing, test items are not necessary to carry out.
2. This is a spot check data report and data performed in appendix of this report are chosen from the worst case of the original FCC ID report. All the test cases were performed on original report which can be referred to Sporton Report Number FR940901-03E.

Declaration of Conformity:
The test results with all measurement uncertainty excluded are presented in accordance with the regulation limits or requirements declared by manufacturers.
Comments and Explanations:
The declared of product specification for EUT presented in the report are provided by the manufacturer, and the manufacturer takes all the responsibilities for the accuracy of product specification.

Reviewed by: Wii Chang

Report Producer: Yimin Ho



1 General Description

1.1 Product Feature of Equipment Under Test

GSM/WCDMA/LTE, Bluetooth, DTS/UNII a/b/g/n/ac, NFC, and GNSS.

Standards-related Product Specification	
Antenna Type	<Ant. 1>: Loop Antenna <Ant. 2>: Loop Antenna
Antenna Gain	<5150 MHz ~ 5250 MHz> <Ant. 1>: -1.8 dBi <Ant. 2>: -3.7 dBi <5250 MHz ~ 5350 MHz> <Ant. 1>: -1.5 dBi <Ant. 2>: -3.6 dBi <5470 MHz ~ 5725 MHz> <Ant. 1>: -1.6 dBi <Ant. 2>: -1.5 dBi

EUT Information List			
HW Version	SW Version	IMEI	Performed Test Item
A	0_77003_A_28_2	004402459556522	RF conducted measurement
	3.122	004402459554493	Radiated Spurious Emission

Accessory List	
AC Adapter	Model Name : UCH32
	S/N: 6218W30200106
Earphone	Model Name.: MH750
	S/N : N/A
USB Cable	Model Name.: UCB24
	S/N : N/A
2 in 1 USB Audio Cable	Model Name.: EC270
	S/N : N/A

Note:

1. Above EUT list used are electrically identical per declared by manufacturer.
2. Above the accessories list are used to exercise the EUT during test, and the serial number of each type of accessories is listed in each section of this report.
3. For other wireless features of this EUT, test report will be issued separately.
4. The antenna 1 and antenna 2 in this test report are equivalent to WLAN chain 0 and chain 1 in Antenna Specification by manufacturer.
5. The firmware installed in the EUT during testing was 0_77003_A_28_2.



1.2 Modification of EUT

No modifications are made to the EUT during all test items.

1.3 Testing Location

Test Site	SPORTON INTERNATIONAL INC. EMC & Wireless Communications Laboratory
Test Site Location	No.52, Huaya 1st Rd., Guishan Dist., Taoyuan City, Taiwan (R.O.C.) TEL: +886-3-327-3456 FAX: +886-3-328-4978
Test Site No.	Sporton Site No.
	TH05-HY

Note: The test site complies with ANSI C63.4 2014 requirement.

Test Site	SPORTON INTERNATIONAL INC. EMC & Wireless Communications Laboratory
Test Site Location	No.58, Aly. 75, Ln. 564, Wenhua 3rd, Rd., Guishan Dist., Taoyuan City, Taiwan (R.O.C.) TEL: +886-3-327-0868 FAX: +886-3-327-0855
Test Site No.	Sporton Site No.
	03CH16-HY

Note: The test site complies with ANSI C63.4 2014 requirement.

FCC Designation No.: TW1190 and TW0007

1.4 Applicable Standards

According to the specifications of the manufacturer, the EUT must comply with the requirements of the following standards:

- ♦ FCC Part 15 Subpart E
- ♦ FCC KDB 789033 D02 General UNII Test Procedures New Rules v02r01.
- ♦ FCC KDB 414788 D01 Radiated Test Site v01r01.
- ♦ FCC KDB 662911 D01 Multiple Transmitter Output v02r01.
- ♦ ANSI C63.10-2013

Remark:

1. All test items were verified and recorded according to the standards and without any deviation during the test.
2. This EUT has also been tested and complied with the requirements of FCC Part 15, Subpart B, recorded in a separate test report.



2 Test Configuration of Equipment Under Test

- a. The EUT has been associated with peripherals and configuration operated in a manner tended to maximize its emission characteristics in a typical application. Frequency range investigated: radiation emission (9 kHz to the 10th harmonic of the highest fundamental frequency or to 40 GHz, whichever is lower). For radiated measurement, pre-scanned in three orthogonal panels, X, Y, Z and Accessory. The worst cases (Y plane with Adapter) were recorded in this report.

2.1 Carrier Frequency and Channel

Frequency Band	Channel	Freq. (MHz)	Channel	Freq. (MHz)
5150-5250 MHz Band 1 (U-NII-1)	36	5180	44	5220
	38*	5190	46*	5230
	40	5200	48	5240
	42 [#]	5210		

Frequency Band	Channel	Freq. (MHz)	Channel	Freq. (MHz)
5250-5350 MHz Band 2 (U-NII-2A)	52	5260	60	5300
	54*	5270	62*	5310
	56	5280	64	5320
	58 [#]	5290		

Frequency Band	Channel	Freq. (MHz)	Channel	Freq. (MHz)
5470-5725 MHz Band 3 (U-NII-2C)	100	5500	112	5560
	102*	5510	116	5580
	104	5520	132	5660
	106 [#]	5530	134*	5670
	108	5540	136	5680
	110*	5550	140	5700



Frequency Band	Channel	Freq. (MHz)	Channel	Freq. (MHz)
TDWR Channel	118*	5590	124	5620
	120	5600	126*	5630
	122 [#]	5610	128	5640

Frequency Band	Channel	Freq. (MHz)	Channel	Freq. (MHz)
Straddle Channel	138 [#]	5690	144	5720
	142*	5710		

Note:

1. The above Frequency and Channel in "*" were 802.11n HT40 and 802.11ac VHT40.
2. The above Frequency and Channel in "[#]" were 802.11ac VHT80.

2.2 Test Mode

Final test modes are considering the modulation and worse data rates as below table.

Modulation	Data Rate
802.11ac VHT80	MCS0

Ch. #	Band I : 5150-5250 MHz			Band II : 5250-5350 MHz			Band III : 5470-5725MHz		
	802.11ac VHT80			802.11ac VHT80			802.11ac VHT80		
L	Low	-	-	-	-	-	-	-	106
M	Middle	42	-	58	-	-	-	-	-
H	High	-	-	-	-	-	-	-	-
Straddle		-	-	-	-	-	-	-	-

2.3 Connection Diagram of Test System

<WLAN Tx Mode>

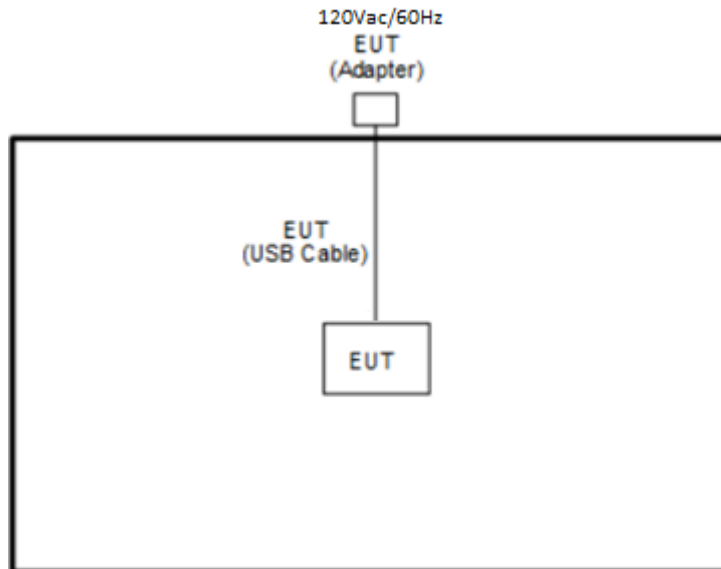

2.4 EUT Operation Test Setup

The RF test items, utility “Tera Term” was installed in Notebook which was programmed in order to make the EUT get into the engineering modes to provide channel selection, power level, data rate and the application type and for continuous transmitting signals.



3 Test Result

3.1 Maximum Conducted Output Power Measurement

3.1.1 Limit of Maximum Conducted Output Power

<FCC 14-30 CFR 15.407>

For the 5.15–5.25 GHz bands:

- For mobile and portable client devices in the 5.15–5.25 GHz band, the maximum conducted output power over the frequency band of operation shall not exceed 250 mW. For an indoor access point operating in the band 5.15-5.25 GHz, the maximum conducted output power over the frequency band of operation shall not exceed 1 W.

For the 5.25–5.725 GHz bands:

- The maximum conducted output power over the frequency bands of operation shall not exceed the lesser of 250 mW or $11 \text{ dBm} + 10 \log B$, where B is the 26 dB emission bandwidth in megahertz.

For Straddle Channel, according to KDB 789033 D02 General UNII Test Procedures New Rules v02r01, if the power and PSD of the devices are uniform and comply with the lower limits specified for the U-NII-2 bands, a single measurement over the entire emission bandwidth can be performed to show compliance.

If transmitting antennas of directional gain greater than 6 dBi are used, the peak output power shall be reduced by the amount in dB that the directional gain of the antenna exceeds 6 dBi.

Note that U-NII-2 band, devices with a maximum e.i.r.p. greater than 500 mW shall implement TPC in order to have the capability to operate at least 6 dB below the maximum permitted e.i.r.p. of 1 W.

3.1.2 Measuring Instruments

See list of measuring equipment of this test report.

3.1.3 Test Procedures

The testing follows Method PM-G of FCC KDB 789033 D02 General UNII Test Procedures New Rules v02r01.

Method PM-G (Measurement using a gated RF average power meter):

1. Measurement is performed using a wideband RF power meter.
2. The EUT is configured to transmit at its maximum power control level.
3. Measure the average power of the transmitter
4. Since the measurement is made only during the ON time of the transmitter, no duty cycle correction factor is required.

For Straddle Channel, according to KDB 789033 D02 General UNII Test Procedures New Rules v02r01, if the power and PSD of the devices are uniform and comply with the lower limits specified for the U-NII-2 bands, a single measurement over the entire emission bandwidth can be performed to show compliance.

3.1.4 Test Setup

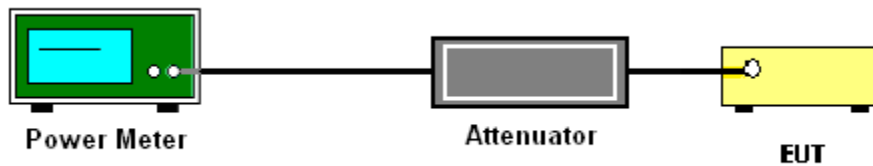

3.1.5 Test Result of Maximum Conducted Output Power

Please refer to Appendix A.



3.2 Unwanted Emissions Measurement

This section is to measure unwanted emissions through radiated measurement for band edge spurious emissions and out of band emissions measurement.

3.2.1 Limit of Unwanted Emissions

- (1) For transmitters operating in the 5150-5250 MHz band: all emissions outside of the 5150-5350 MHz band shall not exceed an EIRP of -27dBm/MHz.

For transmitters operating in the 5250-5350 MHz band: all emissions outside of the 5150-5350 MHz band shall not exceed an EIRP of -27 dBm/MHz. Devices operating in the 5250-5350 MHz band that generate emissions in the 5150-5250 MHz band must meet all applicable technical requirements for operation in the 5150-5250 MHz band (including indoor use) or alternatively meet an out-of-band emission EIRP limit of -27 dBm/MHz in the 5150-5250 MHz band.

For transmitters operating in the 5470-5600 MHz and 5650-5725MHz band: all emissions outside of the 5470-5600 MHz and 5650-5725MHz band shall not exceed an EIRP of -27 dBm/MHz.

- (2) Unwanted spurious emissions fallen in restricted bands shall comply with the general field strength limits as below table,

Frequency (MHz)	Field Strength (microvolts/meter)	Measurement Distance (meters)
0.009 – 0.490	2400/F(kHz)	300
0.490 – 1.705	24000/F(kHz)	30
1.705 – 30.0	30	30
30 – 88	100	3
88 – 216	150	3
216 - 960	200	3
Above 960	500	3

Note: The following formula is used to convert the EIRP to field strength.

$$E = \frac{1000000\sqrt{30P}}{3} \mu\text{V/m, where P is the eirp (Watts)}$$



EIRP (dBm)	Field Strength at 3m (dBμV/m)
- 27	68.3

(3) KDB789033 D02 v02r01 G)2)c)

- (i) Section 15.407(b)(1) to (b)(3) specify the unwanted emission limits for the U-NII-1 and U-NII-2 bands. As specified, emissions above 1000 MHz that are outside of the restricted bands are subject to a peak emission limit of -27 dBm/MHz.³
- (ii) Section 15.407(b)(4) specifies the unwanted emission limit for the U-NII-3 band. A band emissions mask is specified in Section 15.407(b)(4)(i). The emission limits are in terms of a Peak detector. An alternative to the band emissions mask is specified in Section 15.407(b)(4)(ii). The alternative limits are based on the highest antenna gain specified in the filing. There are also marketing and importation restrictions for the devices using the alternative limit.⁴

Note 3: An out-of-band emission that complies with both the average and peak limits of Section 15.209 is not required to satisfy the -27 dBm/MHz peak emission limit.

Note 4: Only devices with antenna gains of 10 dBi or less may be approved using the emission limits specified in Section 15.247(d) till March 2, 2018; all other devices operating in this band must use the mask specified in Section 15.407(b)(4)(i).

3.2.2 Measuring Instruments

See list of measuring equipment of this test report.

3.2.3 Test Procedures

1. The testing follows FCC KDB 789033 D02 General UNII Test Procedures New Rules v02r01. Section G) Unwanted emissions measurement.
 - (1) Procedure for Unwanted Emissions Measurements Below 1000MHz
 - RBW = 120 kHz
 - VBW = 300 kHz
 - Detector = Peak
 - Trace mode = max hold
 - (2) Procedure for Peak Unwanted Emissions Measurements Above 1000 MHz
 - RBW = 1 MHz
 - VBW ≥ 3 MHz
 - Detector = Peak
 - Sweep time = auto
 - Trace mode = max hold



(3) Procedures for Average Unwanted Emissions Measurements Above 1000MHz

- RBW = 1 MHz
 - VBW = 10 Hz, when duty cycle is no less than 98 percent.
 - $VBW \geq 1/T$, when duty cycle is less than 98 percent where T is the minimum transmission duration over which the transmitter is on and is transmitting at its maximum power control level for the tested mode of operation.
2. The EUT was placed on a turntable with 0.8 meter for frequency below 1GHz and 1.5 meter for frequency above 1GHz respectively above ground.
 3. The EUT was set 3 meters from the interference receiving antenna which was mounted on the top of a variable height antenna tower.
 4. The antenna is a broadband antenna and its height is adjusted between one meter and four meters above ground to find the maximum value of the field strength for both horizontal polarization and vertical polarization of the antenna.
 5. For each suspected emission, the EUT was arranged to its worst case and then adjust the antenna tower (from 1 m to 4 m) and turntable (from 0 degree to 360 degrees) to find the maximum reading.
 6. For testing below 1GHz, if the emission level of the EUT in peak mode was 3 dB lower than the limit specified, then peak values of EUT will be reported, otherwise, the emissions will be repeated one by one using the CISPR quasi-peak method and reported.
 7. For testing above 1GHz, the emission level of the EUT in peak mode was 20dB lower than average limit (that means the emission level in average mode also complies with the limit in average mode), then peak values of EUT will be reported, otherwise, the emissions will be measured in average mode again and reported.

3.2.4 Test Setup

For radiated emissions below 30MHz

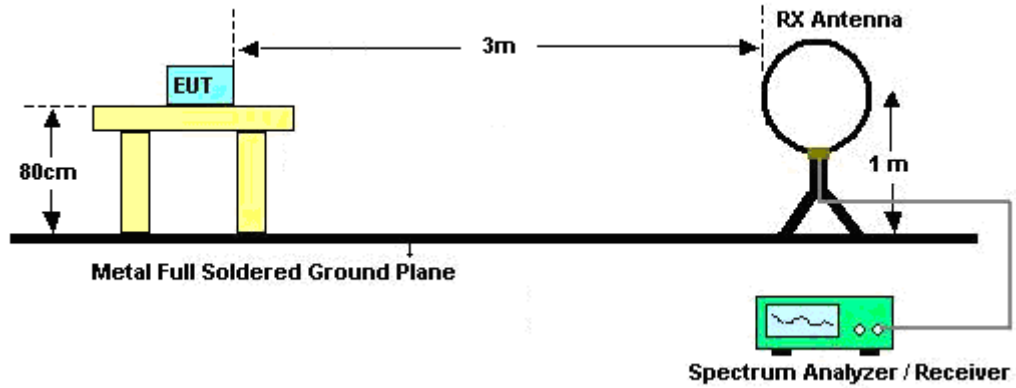

For radiated emissions from 30MHz to 1GHz

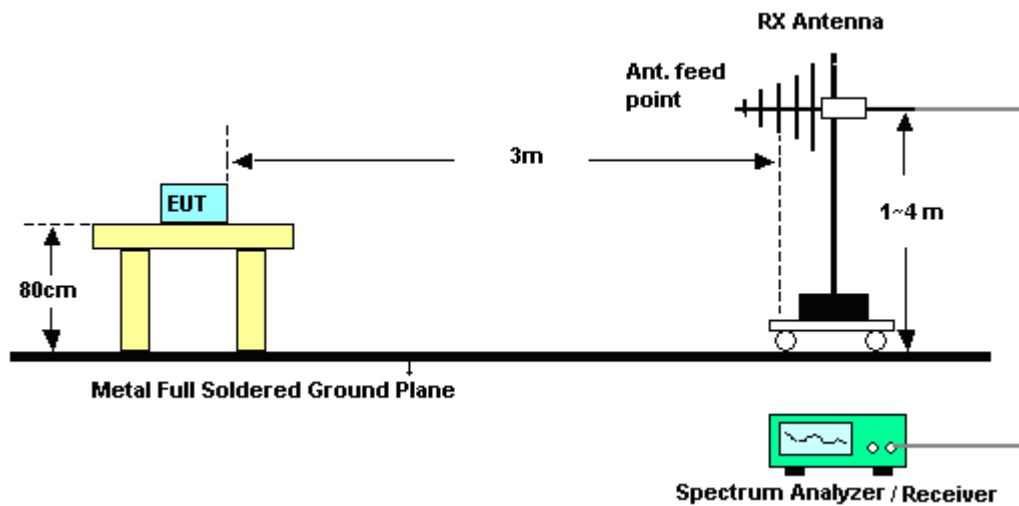

For radiated emissions above 1GHz

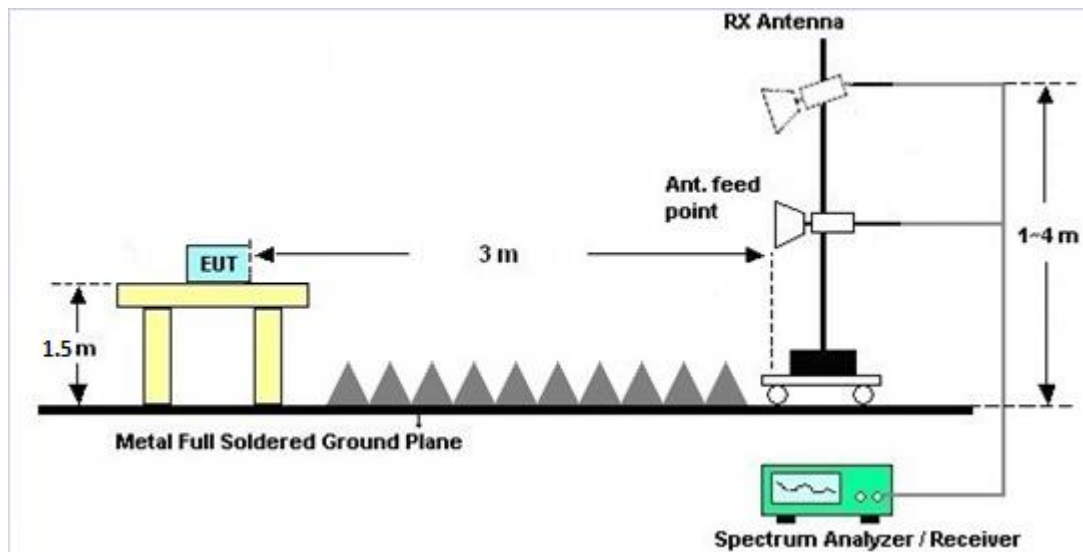

3.2.5 Test Results of Radiated Spurious Emissions (9 kHz ~ 30 MHz)

The low frequency, which started from 9 kHz to 30MHz, was pre-scanned and the result which was 20dB lower than the limit line was not reported.

There is a comparison data of both open-field test site and alternative test site - semi-Anechoic chamber according to 414788 D01 Radiated Test Site v01r01, and the result came out very similar.

3.2.6 Test Result of Radiated Spurious at Band Edges

Please refer to Appendix B and C.

3.2.7 Duty Cycle

Please refer to Appendix D.

3.2.8 Test Result of Radiated Spurious Emissions (30MHz ~ 10th Harmonic)

Please refer to Appendix B and C.



3.3 Antenna Requirements

3.3.1 Standard Applicable

If transmitting antenna directional gain is greater than 6 dBi, both the peak transmit power and the peak power spectral density shall be reduced by the amount in dB that the directional gain of the antenna exceeds 6 dBi.

3.3.2 Antenna Anti-Replacement Construction

An embedded-in antenna design is used.

3.3.3 Antenna Gain

<CDD Modes >

FCC KDB 662911 D01 Multiple Transmitter Output v02r01

For CDD transmissions, directional gain is calculated as

Directional gain = GANT + Array Gain, where Array Gain is as follows.

For power spectral density (PSD) measurements on all devices,

Array Gain = 10 log(NANT/NSS=1) dB.

For power measurements on IEEE 802.11 devices,

Array Gain = 0 dB (i.e., no array gain) for NANT ≤ 4.

Directional gain may be calculated by using the formulas applicable to equal gain antennas with GANT set equal to the gain of the antenna having the highest gain;

The EUT supports CDD mode.

For power, the directional gain GANT is set equal to the antenna having the highest gain, i.e., F)2)f)i).

For PSD, the directional gain calculation is following F)2)f)ii) of KDB 662911 D01 v02r01.

The power and PSD limit should be modified if the directional gain of EUT is over 6 dBi,

The directional gain "DG" is calculated as following table.

<CDD Modes>						
	Ant. 1	Ant. 2	DG for Power	DG for PSD	Power Limit Reduction	PSD Limit Reduction
	(dBi)	(dBi)	(dBi)	(dBi)	(dB)	(dB)
Band I	-1.50	-3.60	-1.50	0.52	0.00	0.00
Band II	-1.50	-3.60	-1.50	0.52	0.00	0.00
Band III	-1.60	-1.50	-1.50	1.46	0.00	0.00

Power limit reduction = Composite gain – 6dBi, (min = 0)

PSD limit reduction = Composite gain + PSD Array gain – 6dBi, (min = 0)



4 List of Measuring Equipment

Instrument	Manufacturer	Model No.	Serial No.	Characteristics	Calibration Date	Test Date	Due Date	Remark
Hygrometer	Testo	DTM-303A	TP157075	N/A	Nov. 05, 2018	Jul. 23, 2019	Nov. 04, 2019	Conducted (TH05-HY)
Power Sensor	DARE	RPR3006W	16I00054SN O10	10MHz~6GHz	Dec. 19, 2018	Jul. 23, 2019	Dec. 18, 2019	Conducted (TH05-HY)
Spectrum Analyzer	Rohde & Schwarz	FSP40	100057	9kHz~40GHz	Nov. 21, 2018	Jul. 23, 2019	Nov. 20, 2019	Conducted (TH05-HY)
Signal Analyzer	Rohde & Schwarz	FSV40	101397	10Hz~40GHz	Nov. 13, 2018	Jul. 23, 2019	Nov. 12, 2019	Conducted (TH05-HY)
Switch Box & RF Cable	Burgeon	ETF-058	EC1208382	N/A	Mar. 27, 2019	Jul. 23, 2019	Mar. 26, 2020	Conducted (TH05-HY)
Loop Antenna	Rohde & Schwarz	HFH2-Z2	100315	9 kHz~30 MHz	Jan. 11, 2019	Jul. 17, 2019~ Jul. 18, 2019	Jan. 10, 2020	Radiation (03CH16-HY)
Bilog Antenna	TESEQ	CBL6111D& 00802N1D0 1N-06	47020&06	30MHz to 1GHz	Oct. 13, 2018	Jul. 17, 2019~ Jul. 18, 2019	Oct. 12, 2019	Radiation (03CH16-HY)
Horn Antenna	SCHWARZBE CK	BBHA 9120 D	9120D-1522	1G~18GHz	Sep. 07, 2018	Jul. 17, 2019~ Jul. 18, 2019	Sep. 06, 2019	Radiation (03CH16-HY)
SHF-EHF Horn Antenna	SCHWARZBE CK	BBHA 9170	BBHA91702 51	18GHz ~ 40GHz	Nov. 20, 2018	Jul. 17, 2019~ Jul. 18, 2019	Nov. 19, 2019	Radiation (03CH16-HY)
Amplifier	SONOMA	310N	371607	9kHz~1000MHz	Oct. 02, 2018	Jul. 17, 2019~ Jul. 18, 2019	Oct. 01, 2019	Radiation (03CH16-HY)
Preamplifier	Jet-Power	JPA0118-55- 303	1710001800 055007	1GHz~18GHz	Apr. 01, 2019	Jul. 17, 2019~ Jul. 18, 2019	Mar. 31, 2020	Radiation (03CH16-HY)
Preamplifier	Keysight	83017A	MY5327026 4	1GHz~26.5GHz	Dec. 12, 2018	Jul. 17, 2019~ Jul. 18, 2019	Dec. 11, 2019	Radiation (03CH16-HY)
Preamplifier	EMEC	EM18G40G	060715	18GHz~40GHz	Dec. 06, 2018	Jul. 17, 2019~ Jul. 18, 2019	Dec. 05, 2019	Radiation (03CH16-HY)
EMI Test Receiver	Keysight	N9038A (MXE)	MY57290111	3Hz~26.5GHz	Nov. 29, 2018	Jul. 17, 2019~ Jul. 18, 2019	Nov. 28, 2019	Radiation (03CH16-HY)
Spectrum Analyzer	Agilent	N9010A	MY5420048 6	10Hz~44GHz	Oct. 19, 2018	Jul. 17, 2019~ Jul. 18, 2019	Oct. 18, 2019	Radiation (03CH16-HY)
Hygrometer	TECPEL	DTM-303B	TP162965	N/A	Oct. 22, 2018	Jul. 17, 2019~ Jul. 18, 2019	Oct. 21, 2019	Radiation (03CH16-HY)
Filter	Wainwright	WLK4-1000- 1530-8000-4 0SS	SN11	1G Low Pass	Sep. 16, 2018	Jul. 17, 2019~ Jul. 18, 2019	Sep. 15, 2019	Radiation (03CH16-HY)
Filter	Wainwright	WHKX8-587 2.5-6750-18 000-40ST	SN3	6.75 GHz Highpass	Sep. 16, 2018	Jul. 17, 2019~ Jul. 18, 2019	Sep. 15, 2019	Radiation (03CH16-HY)
RF Cable	HUBER + SUHNER	SUCOFLEX 126E	MY1082/26E A	30M-18G	Oct. 15, 2018	Jul. 17, 2019~ Jul. 18, 2019	Oct. 14, 2019	Radiation (03CH16-HY)
RF Cable	HUBER + SUHNER	SUCOFLEX 104	MY15539/4	30M-18G	Feb. 26, 2019	Jul. 17, 2019~ Jul. 18, 2019	Feb. 25, 2020	Radiation (03CH16-HY)
RF Cable	HUBER + SUHNER	SUCOFLEX 104	MY36980/4	30M~18GHz	Apr. 15, 2019	Jul. 17, 2019~ Jul. 18, 2019	Apr. 14, 2020	Radiation (03CH16-HY)



Instrument	Manufacturer	Model No.	Serial No.	Characteristics	Calibration Date	Test Date	Due Date	Remark
Controller	ChainTek	3000-1	N/A	Control Turn table & Ant Mast	N/A	Jul. 17, 2019~ Jul. 18, 2019	N/A	Radiation (03CH16-HY)
Antenna Mast	ChainTek	MBS-520-1	N/A	1m~4m	N/A	Jul. 17, 2019~ Jul. 18, 2019	N/A	Radiation (03CH16-HY)
Turn Table	ChainTek	T-200-S-1	N/A	0~360 Degree	N/A	Jul. 17, 2019~ Jul. 18, 2019	N/A	Radiation (03CH16-HY)
Software	Audix	E3 6.2009-8-24	RK-001136	N/A	N/A	Jul. 17, 2019~ Jul. 18, 2019	N/A	Radiation (03CH16-HY)



5 Uncertainty of Evaluation

Uncertainty of Radiated Emission Measurement (30 MHz ~ 1000 MHz)

Measuring Uncertainty for a Level of Confidence of 95% ($U = 2Uc(y)$)	4.90
---	------

Uncertainty of Radiated Emission Measurement (1000 MHz ~ 18000 MHz)

Measuring Uncertainty for a Level of Confidence of 95% ($U = 2Uc(y)$)	5.80
---	------

Uncertainty of Radiated Emission Measurement (18000 MHz ~ 40000 MHz)

Measuring Uncertainty for a Level of Confidence of 95% ($U = 2Uc(y)$)	3.90
---	------

Appendix A. Test Result of Conducted Test Items

Test Engineer:	Howard Lin	Temperature:	21~25	°C
Test Date:	2019/7/23	Relative Humidity:	51~54	%

TEST RESULTS DATA
Average Power Table

FCC Band I												
Mod.	Data Rate	NTX	CH.	Freq. (MHz)	Average Conducted Power (dBm)			FCC Conducted Power Limit (dBm)		DG (dBi)		Pass/Fail
					Ant 1	Ant 2	SUM	Ant 1	Ant 2	Ant 1	Ant 2	
11a	6Mbps	1	36	5180	10.30	8.80		24.00	24.00	-1.50	-3.60	Pass
11a	6Mbps	1	44	5220	10.30	8.80		24.00	24.00	-1.50	-3.60	Pass
11a	6Mbps	1	48	5240	10.30	9.00		24.00	24.00	-1.50	-3.60	Pass
HT20	MCS0	1	36	5180	10.10	8.80		24.00	24.00	-1.50	-3.60	Pass
HT20	MCS0	1	44	5220	10.10	8.80		24.00	24.00	-1.50	-3.60	Pass
HT20	MCS0	1	48	5240	10.10	8.80		24.00	24.00	-1.50	-3.60	Pass
HT40	MCS0	1	38	5190	10.20	8.90		24.00	24.00	-1.50	-3.60	Pass
HT40	MCS0	1	46	5230	10.10	9.00		24.00	24.00	-1.50	-3.60	Pass
VHT20	MCS0	1	36	5180	10.00	8.70		24.00	24.00	-1.50	-3.60	Pass
VHT20	MCS0	1	44	5220	10.00	8.70		24.00	24.00	-1.50	-3.60	Pass
VHT20	MCS0	1	48	5240	10.00	8.70		24.00	24.00	-1.50	-3.60	Pass
VHT40	MCS0	1	38	5190	10.10	8.80		24.00	24.00	-1.50	-3.60	Pass
VHT40	MCS0	1	46	5230	10.00	8.90		24.00	24.00	-1.50	-3.60	Pass
VHT80	MCS0	1	42	5210	10.30	8.80		24.00	24.00	-1.50	-3.60	Pass
11a	6Mbps	2	36	5180	10.40	8.90	12.72	24.00		-1.50		Pass
11a	6Mbps	2	44	5220	10.40	8.90	12.72	24.00		-1.50		Pass
11a	6Mbps	2	48	5240	10.40	9.10	12.81	24.00		-1.50		Pass
HT20	MCS0	2	36	5180	10.20	8.90	12.61	24.00		-1.50		Pass
HT20	MCS0	2	44	5220	10.20	8.90	12.61	24.00		-1.50		Pass
HT20	MCS0	2	48	5240	10.20	8.90	12.61	24.00		-1.50		Pass
HT40	MCS0	2	38	5190	10.30	9.00	12.71	24.00		-1.50		Pass
HT40	MCS0	2	46	5230	10.20	9.10	12.70	24.00		-1.50		Pass
VHT20	MCS0	2	36	5180	10.10	8.80	12.51	24.00		-1.50		Pass
VHT20	MCS0	2	44	5220	10.10	8.80	12.51	24.00		-1.50		Pass
VHT20	MCS0	2	48	5240	10.10	8.80	12.51	24.00		-1.50		Pass
VHT40	MCS0	2	38	5190	10.20	8.90	12.61	24.00		-1.50		Pass
VHT40	MCS0	2	46	5230	10.10	9.00	12.60	24.00		-1.50		Pass
VHT80	MCS0	2	42	5210	10.40	8.90	12.72	24.00		-1.50		Pass

TEST RESULTS DATA
Average Power Table

FCC Band II													
Mod.	Data Rate	NTX	CH.	Freq. (MHz)	Average Conducted Power (dBm)			FCC Conducted Power Limit (dBm)		DG (dBi)		EIRP Power Limit (dBm)	Pass/Fail
					Ant 1	Ant 2	SUM	Ant 1	Ant 2	Ant 1	Ant 2		
11a	6Mbps	1	52	5260	10.30	9.00		23.98	23.98	-1.50	-3.60	26.99	Pass
11a	6Mbps	1	60	5300	10.30	8.80		23.98	23.98	-1.50	-3.60	26.99	Pass
11a	6Mbps	1	64	5320	10.20	9.00		23.98	23.98	-1.50	-3.60	26.99	Pass
HT20	MCS0	1	52	5260	10.30	8.90		23.98	23.98	-1.50	-3.60	26.99	Pass
HT20	MCS0	1	60	5300	10.20	8.80		23.98	23.98	-1.50	-3.60	26.99	Pass
HT20	MCS0	1	64	5320	10.30	8.90		23.98	23.98	-1.50	-3.60	26.99	Pass
HT40	MCS0	1	54	5270	10.10	9.10		23.98	23.98	-1.50	-3.60	26.99	Pass
HT40	MCS0	1	62	5310	10.20	9.00		23.98	23.98	-1.50	-3.60	26.99	Pass
VHT20	MCS0	1	52	5260	10.20	8.80		23.98	23.98	-1.50	-3.60	26.99	Pass
VHT20	MCS0	1	60	5300	10.10	8.70		23.98	23.98	-1.50	-3.60	26.99	Pass
VHT20	MCS0	1	64	5320	10.20	8.80		23.98	23.98	-1.50	-3.60	26.99	Pass
VHT40	MCS0	1	54	5270	10.00	9.00		23.98	23.98	-1.50	-3.60	26.99	Pass
VHT40	MCS0	1	62	5310	10.10	8.90		23.98	23.98	-1.50	-3.60	26.99	Pass
VHT80	MCS0	1	58	5290	10.30	9.00		23.98	23.98	-1.50	-3.60	26.99	Pass
11a	6Mbps	2	52	5260	10.40	9.10	12.81	23.98		-1.50		26.99	Pass
11a	6Mbps	2	60	5300	10.40	8.90	12.72	23.98		-1.50		26.99	Pass
11a	6Mbps	2	64	5320	10.30	9.10	12.75	23.98		-1.50		26.99	Pass
HT20	MCS0	2	52	5260	10.40	9.00	12.77	23.98		-1.50		26.99	Pass
HT20	MCS0	2	60	5300	10.30	8.90	12.67	23.98		-1.50		26.99	Pass
HT20	MCS0	2	64	5320	10.40	9.00	12.77	23.98		-1.50		26.99	Pass
HT40	MCS0	2	54	5270	10.20	9.20	12.74	23.98		-1.50		26.99	Pass
HT40	MCS0	2	62	5310	10.30	9.10	12.75	23.98		-1.50		26.99	Pass
VHT20	MCS0	2	52	5260	10.30	8.90	12.67	23.98		-1.50		26.99	Pass
VHT20	MCS0	2	60	5300	10.20	8.80	12.57	23.98		-1.50		26.99	Pass
VHT20	MCS0	2	64	5320	10.30	8.90	12.67	23.98		-1.50		26.99	Pass
VHT40	MCS0	2	54	5270	10.10	9.10	12.64	23.98		-1.50		26.99	Pass
VHT40	MCS0	2	62	5310	10.20	9.00	12.65	23.98		-1.50		26.99	Pass
VHT80	MCS0	2	58	5290	10.40	9.10	12.81	23.98		-1.50		26.99	Pass

TEST RESULTS DATA
Average Power Table

FCC Band III													
Mod.	Data Rate	NTX	CH.	Freq. (MHz)	Average Conducted Power (dBm)			FCC Conducted Power Limit (dBm)		DG (dBi)		EIRP Power Limit (dBm)	Pass/Fail
					Ant 1	Ant 2	SUM	Ant 1	Ant 2	Ant 1	Ant 2		
11a	6Mbps	1	100	5500	10.10	9.00		23.98	23.98	-1.60	-1.50	26.99	Pass
11a	6Mbps	1	116	5580	10.30	9.00		23.98	23.98	-1.60	-1.50	26.99	Pass
11a	6Mbps	1	140	5700	10.20	8.80		23.98	23.98	-1.60	-1.50	26.99	Pass
11a	6Mbps	1	144	5720	10.10	9.00		23.98	23.98	-1.60	-1.50	26.99	Pass
HT20	MCS0	1	100	5500	10.20	8.80		23.98	23.98	-1.60	-1.50	26.99	Pass
HT20	MCS0	1	116	5580	10.30	8.90		23.98	23.98	-1.60	-1.50	26.99	Pass
HT20	MCS0	1	140	5700	10.30	8.80		23.98	23.98	-1.60	-1.50	26.99	Pass
HT20	MCS0	1	144	5720	10.10	9.00		23.98	23.98	-1.60	-1.50	26.99	Pass
HT40	MCS0	1	102	5510	10.10	9.00		23.98	23.98	-1.60	-1.50	26.99	Pass
HT40	MCS0	1	110	5550	10.30	8.90		23.98	23.98	-1.60	-1.50	26.99	Pass
HT40	MCS0	1	134	5670	10.10	8.90		23.98	23.98	-1.60	-1.50	26.99	Pass
HT40	MCS0	1	142	5710	10.30	8.80		23.98	23.98	-1.60	-1.50	26.99	Pass
VHT20	MCS0	1	100	5500	10.10	8.70		23.98	23.98	-1.60	-1.50	26.99	Pass
VHT20	MCS0	1	116	5580	10.20	8.80		23.98	23.98	-1.60	-1.50	26.99	Pass
VHT20	MCS0	1	140	5700	10.20	8.70		23.98	23.98	-1.60	-1.50	26.99	Pass
VHT20	MCS0	1	144	5720	10.00	8.90		23.98	23.98	-1.60	-1.50	26.99	Pass
VHT40	MCS0	1	102	5510	10.00	8.90		23.98	23.98	-1.60	-1.50	26.99	Pass
VHT40	MCS0	1	110	5550	10.20	8.80		23.98	23.98	-1.60	-1.50	26.99	Pass
VHT40	MCS0	1	134	5670	10.00	8.80		23.98	23.98	-1.60	-1.50	26.99	Pass
VHT40	MCS0	1	142	5710	10.20	8.70		23.98	23.98	-1.60	-1.50	26.99	Pass
VHT80	MCS0	1	106	5530	10.10	8.80		23.98	23.98	-1.60	-1.50	26.99	Pass
VHT80	MCS0	1	122	5610	10.40	9.00		23.98	23.98	-1.60	-1.50	26.99	Pass
VHT80	MCS0	1	138	5690	10.10	8.90		23.98	23.98	-1.60	-1.50	26.99	Pass

FCC Band III													
Mod.	Data Rate	NTX	CH.	Freq. (MHz)	Average Conducted Power (dBm)			FCC Conducted Power Limit (dBm)		DG (dBi)		EIRP Power Limit (dBm)	Pass/Fail
					Ant 1	Ant 2	SUM	Ant 1	Ant 2	Ant 1	Ant 2		
11a	6Mbps	2	100	5500	10.20	9.10	12.70	23.98		-1.50	26.99	Pass	
11a	6Mbps	2	116	5580	10.40	9.10	12.81	23.98		-1.50	26.99	Pass	
11a	6Mbps	2	140	5700	10.30	8.90	12.67	23.98		-1.50	26.99	Pass	
11a	6Mbps	2	144	5720	10.20	9.10	12.70	23.98		-1.50	26.99	Pass	
HT20	MCS0	2	100	5500	10.30	8.90	12.67	23.98		-1.50	26.99	Pass	
HT20	MCS0	2	116	5580	10.40	9.00	12.77	23.98		-1.50	26.99	Pass	
HT20	MCS0	2	140	5700	10.40	8.90	12.72	23.98		-1.50	26.99	Pass	
HT20	MCS0	2	144	5720	10.20	9.10	12.70	23.98		-1.50	26.99	Pass	
HT40	MCS0	2	102	5510	10.20	9.10	12.70	23.98		-1.50	26.99	Pass	
HT40	MCS0	2	110	5550	10.40	9.00	12.77	23.98		-1.50	26.99	Pass	
HT40	MCS0	2	134	5670	10.20	9.00	12.65	23.98		-1.50	26.99	Pass	
HT40	MCS0	2	142	5710	10.40	8.90	12.72	23.98		-1.50	26.99	Pass	
VHT20	MCS0	2	100	5500	10.20	8.80	12.57	23.98		-1.50	26.99	Pass	
VHT20	MCS0	2	116	5580	10.30	8.90	12.67	23.98		-1.50	26.99	Pass	
VHT20	MCS0	2	140	5700	10.30	8.80	12.62	23.98		-1.50	26.99	Pass	
VHT20	MCS0	2	144	5720	10.10	9.00	12.60	23.98		-1.50	26.99	Pass	
VHT40	MCS0	2	102	5510	10.10	9.00	12.60	23.98		-1.50	26.99	Pass	
VHT40	MCS0	2	110	5550	10.30	8.90	12.67	23.98		-1.50	26.99	Pass	
VHT40	MCS0	2	134	5670	10.10	8.90	12.55	23.98		-1.50	26.99	Pass	
VHT40	MCS0	2	142	5710	10.30	8.80	12.62	23.98		-1.50	26.99	Pass	
VHT80	MCS0	2	106	5530	10.20	8.90	12.61	23.98		-1.50	26.99	Pass	
VHT80	MCS0	2	122	5610	10.40	9.10	12.81	23.98		-1.50	26.99	Pass	
VHT80	MCS0	2	138	5690	10.20	9.00	12.65	23.98		-1.50	26.99	Pass	



Appendix B. Radiated Spurious Emission

Test Engineer :	Jacky Hung	Temperature :	20~25°C
		Relative Humidity :	50~60%

Band 1 - 5150~5250MHz

WIFI 802.11ac VHT80 (Band Edge @ 3m)

WIFI Ant. 1+2	Note	Frequency (MHz)	Level (dBμV/m)	Over Limit (dB)	Limit Line (dBμV/m)	Read Level (dBμV)	Antenna Factor (dB/m)	Path Loss (dB)	Preamp Factor (dB)	Ant Pos (cm)	Table Pos (deg)	Peak Avg. (P/A)	Pol. (H/V)
802.11ac VHT80 CH 42 5210MHz		5124.02	55.54	-18.46	74	39.35	32.65	13.26	29.72	157	317	P	H
		5146.9	46.6	-7.4	54	30.49	32.62	13.21	29.72	157	317	A	H
	*	5210	100.13	-	-	84.23	32.55	13.07	29.72	157	317	P	H
	*	5210	92.39	-	-	76.49	32.55	13.07	29.72	157	317	A	H
		5421.08	54.65	-19.35	74	39.08	32.29	13.02	29.74	157	317	P	H
		5453	44.81	-9.19	54	29.15	32.26	13.14	29.74	157	317	A	H
		5020.8	56.11	-17.89	74	39.53	32.78	13.51	29.71	250	170	P	V
		5146.9	46.15	-7.85	54	30.04	32.62	13.21	29.72	250	170	A	V
	*	5210	95.68	-	-	79.78	32.55	13.07	29.72	250	170	P	V
	*	5210	86.55	-	-	70.65	32.55	13.07	29.72	250	170	A	V
	5436.76	53.86	-20.14	74	38.24	32.28	13.08	29.74	250	170	P	V	
	5449.64	44.62	-9.38	54	28.97	32.26	13.13	29.74	250	170	A	V	
Remark	<ol style="list-style-type: none"> No other spurious found. All results are PASS against Peak and Average limit line. 												



Band 1 5150~5250MHz

WIFI 802.11ac VHT80 (Harmonic @ 3m)

WIFI	Note	Frequency	Level	Over	Limit	Read	Antenna	Path	Preamp	Ant	Table	Peak	Pol.	
Ant.				Limit	Line	Level	Factor	Loss	Factor	Pos	Pos	Avg.		
1+2		(MHz)	(dBμV/m)	(dB)	(dBμV/m)	(dBμV)	(dB/m)	(dB)	(dB)	(cm)	(deg)	(P/A)	(H/V)	
802.11ac VHT80 CH 42 5210MHz		10420	46.01	-22.19	68.2	47.81	39.99	17.53	59.32	100	0	P	H	
		15630	44.03	-29.97	74	44.5	37.9	21.53	59.9	100	0	P	H	
													H	
													H	
			10420	45.48	-22.72	68.2	47.28	39.99	17.53	59.32	100	0	P	V
			15630	44.14	-29.86	74	44.61	37.9	21.53	59.9	100	0	P	V
														V

Remark

- No other spurious found.
- All results are PASS against Peak and Average limit line.



Band 2 - 5250~5350MHz

WIFI 802.11ac VHT80 (Band Edge @ 3m)

WIFI	Note	Frequency	Level	Over	Limit	Read	Antenna	Path	Preamp	Ant	Table	Peak	Pol.
Ant.				Limit	Line	Level	Factor	Loss	Factor	Pos	Pos	Avg.	
1+2		(MHz)	(dBμV/m)	(dB)	(dBμV/m)	(dBμV)	(dB/m)	(dB)	(dB)	(cm)	(deg)	(P/A)	(H/V)
802.11ac VHT80 CH 58 5290MHz		5057.8	55.53	-18.47	74	39.09	32.73	13.42	29.71	163	301	P	H
		5087.38	45.97	-8.03	54	29.64	32.7	13.35	29.72	163	301	A	H
	*	5290	101.73	-	-	85.99	32.45	13.02	29.73	163	301	P	H
	*	5290	93.8	-	-	78.06	32.45	13.02	29.73	163	301	A	H
		5351.28	61.85	-12.15	74	46.22	32.38	12.98	29.73	163	301	P	H
		5350.32	49.87	-4.13	54	34.24	32.38	12.98	29.73	163	301	A	H
		5084.66	55.21	-18.79	74	38.87	32.7	13.36	29.72	243	203	P	V
		5059.16	45.89	-8.11	54	29.45	32.73	13.42	29.71	243	203	A	V
	*	5290	97.06	-	-	81.32	32.45	13.02	29.73	243	203	P	V
	*	5290	89.13	-	-	73.39	32.45	13.02	29.73	243	203	A	V
		5353.44	57.06	-16.94	74	41.43	32.38	12.98	29.73	243	203	P	V
		5351.28	46.73	-7.27	54	31.1	32.38	12.98	29.73	243	203	A	V
Remark	1. No other spurious found. 2. All results are PASS against Peak and Average limit line.												



Band 2 5250~5350MHz

WIFI 802.11ac VHT80 (Harmonic @ 3m)

WIFI	Note	Frequency	Level	Over	Limit	Read	Antenna	Path	Preamp	Ant	Table	Peak	Pol.	
Ant.				Limit	Line	Level	Factor	Loss	Factor	Pos	Pos	Avg.		
1+2		(MHz)	(dBμV/m)	(dB)	(dBμV/m)	(dBμV)	(dB/m)	(dB)	(dB)	(cm)	(deg)	(P/A)	(H/V)	
802.11ac VHT80 CH 58 5290MHz		10580	45.57	-22.63	68.2	47.35	40.1	17.66	59.54	100	0	P	H	
		15870	43.17	-30.83	74	43.43	37.9	21.58	59.74	100	0	P	H	
													H	
													H	
			10580	47.1	-21.1	68.2	48.88	40.1	17.66	59.54	100	0	P	V
			15870	42.66	-31.34	74	42.92	37.9	21.58	59.74	100	0	P	V
														V

Remark

- No other spurious found.
- All results are PASS against Peak and Average limit line.



Band 3 - 5470~5725MHz

WIFI 802.11ac VHT80 (Band Edge @ 3m)

WIFI	Note	Frequency	Level	Over	Limit	Read	Antenna	Path	Preamp	Ant	Table	Peak	Pol.
Ant.				Limit	Line	Level	Factor	Loss	Factor	Pos	Pos	Avg.	
1+2		(MHz)	(dBμV/m)	(dB)	(dBμV/m)	(dBμV)	(dB/m)	(dB)	(dB)	(cm)	(deg)	(P/A)	(H/V)
802.11ac VHT80 CH 106 5530MHz		5459.44	56.51	-17.49	74	40.84	32.25	13.16	29.74	194	304	P	H
		5467.6	57.24	-10.96	68.2	41.55	32.24	13.19	29.74	194	304	P	H
		5459.92	47.46	-6.54	54	31.79	32.25	13.16	29.74	194	304	A	H
	*	5530	101.77	-	-	85.84	32.27	13.41	29.75	194	304	P	H
	*	5530	93.36	-	-	77.43	32.27	13.41	29.75	194	304	A	H
		5753.975	54.73	-13.47	68.2	37.75	32.76	14.08	29.86	194	304	P	H
		5455.36	55.3	-18.7	74	39.64	32.25	13.15	29.74	247	210	P	V
		5460.4	55.29	-12.91	68.2	39.62	32.25	13.16	29.74	247	210	P	V
		5458.24	45.8	-8.2	54	30.13	32.25	13.16	29.74	247	210	A	V
	*	5530	95.79	-	-	79.86	32.27	13.41	29.75	247	210	P	V
	*	5530	87.68	-	-	71.75	32.27	13.41	29.75	247	210	A	V
			5741.375	55.41	-12.79	68.2	38.5	32.73	14.04	29.86	247	210	P



Band 3 5470~5725MHz

WIFI 802.11ac VHT80 (Harmonic @ 3m)

WIFI	Note	Frequency	Level	Over	Limit	Read	Antenna	Path	Preamp	Ant	Table	Peak	Pol.
Ant.				Limit	Line	Level	Factor	Loss	Factor	Pos	Pos	Avg.	
1+2		(MHz)	(dBμV/m)	(dB)	(dBμV/m)	(dBμV)	(dB/m)	(dB)	(dB)	(cm)	(deg)	(P/A)	(H/V)
802.11ac		11060	46.08	-27.92	74	48.51	40.05	18.03	60.51	100	0	P	H
		16590	48.56	-19.64	68.2	44.48	40.42	22.39	58.73	100	0	P	H
VHT80													H
CH 106													H
5530MHz		11060	45.83	-28.17	74	48.26	40.05	18.03	60.51	100	0	P	V
		16590	46.23	-21.97	68.2	42.15	40.42	22.39	58.73	100	0	P	V
													V
													V



Emission below 1GHz
WIFI 802.11ac VHT80 (LF @ 3m)

WIFI	Note	Frequency	Level	Over	Limit	Read	Antenna	Path	Preamp	Ant	Table	Peak	Pol.	
Ant.				Limit	Line	Level	Factor	Loss	Factor	Pos	Pos	Avg.		
1+2		(MHz)	(dBμV/m)	(dB)	(dBμV/m)	(dBμV)	(dB/m)	(dB)	(dB)	(cm)	(deg)	(P/A)	(H/V)	
802.11ac VHT80 LF		152.22	26.16	-17.34	43.5	40.01	17.01	1.5	32.36	-	-	P	H	
		215.27	26.78	-16.72	43.5	42.03	15.19	1.92	32.36	-	-	P	H	
		653.71	27.27	-18.73	46	29.49	26.3	4.08	32.6	-	-	P	H	
		774.96	30.21	-15.79	46	29.97	28.21	4.43	32.4	-	-	P	H	
		861.29	31.86	-14.14	46	30.08	29.13	4.66	32.01	-	-	P	H	
		945.68	33.16	-12.84	46	29.32	30.62	4.61	31.39	100	0	P	H	
														H
														H
														H
														H
														H
														H
			43.58	29.6	-10.4	40	44.07	17.35	0.62	32.44	100	0	P	V
			184.23	24.82	-18.68	43.5	40.63	14.88	1.66	32.35	-	-	P	V
			563.5	26.46	-19.54	46	29.29	26.15	3.66	32.64	-	-	P	V
			747.8	30.83	-15.17	46	30.63	28.14	4.51	32.45	-	-	P	V
			878.75	31.47	-14.53	46	29.77	28.95	4.66	31.91	-	-	P	V
			954.41	33.37	-12.63	46	29.13	30.86	4.69	31.31	-	-	P	V
														V
														V
													V	
													V	
													V	
													V	
Remark	1. No other spurious found. 2. All results are PASS against limit line.													



Note symbol

*	Fundamental Frequency which can be ignored. However, the level of any unwanted emissions shall not exceed the level of the fundamental frequency.
!	Test result is over limit line.
P/A	Peak or Average
H/V	Horizontal or Vertical



A calculation example for radiated spurious emission is shown as below:

WIFI	Note	Frequency	Level	Over	Limit	Read	Antenna	Path	Preamp	Ant	Table	Peak	Pol.
Ant.				Limit	Line	Level	Factor	Loss	Factor	Pos	Pos	Avg.	
1		(MHz)	(dBμV/m)	(dB)	(dBμV/m)	(dBμV)	(dB/m)	(dB)	(dB)	(cm)	(deg)	(P/A)	(H/V)
802.11b		2390	55.45	-18.55	74	54.51	32.22	4.58	35.86	103	308	P	H
CH 01													
2412MHz		2390	43.54	-10.46	54	42.6	32.22	4.58	35.86	103	308	A	H

1. Path Loss(dB) = Cable loss(dB) + Filter loss(dB) + Attenuator loss(dB)
2. Level(dBμV/m) = Antenna Factor(dB/m) + Path Loss(dB) + Read Level(dBμV) - Preamp Factor(dB)
3. Over Limit(dB) = Level(dBμV/m) – Limit Line(dBμV/m)

For Peak Limit @ 2390MHz:

1. Level(dBμV/m)
= Antenna Factor(dB/m) + Path Loss(dB) + Read Level(dBμV) - Preamp Factor(dB)
= 32.22(dB/m) + 4.58(dB) + 54.51(dBμV) – 35.86 (dB)
= 55.45 (dBμV/m)
2. Over Limit(dB)
= Level(dBμV/m) – Limit Line(dBμV/m)
= 55.45(dBμV/m) – 74(dBμV/m)
= -18.55(dB)

For Average Limit @ 2390MHz:

1. Level(dBμV/m)
= Antenna Factor(dB/m) + Path Loss(dB) + Read Level(dBμV) - Preamp Factor(dB)
= 32.22(dB/m) + 4.58(dB) + 42.6(dBμV) – 35.86 (dB)
= 43.54 (dBμV/m)
2. Over Limit(dB) = Level(dBμV/m) – Limit Line(dBμV/m)
= 43.54(dBμV/m) – 54(dBμV/m)
= -10.46(dB)

Both peak and average measured complies with the limit line, so test result is “PASS”.



Appendix C. Radiated Spurious Emission

Test Engineer :	Jacky Hung	Temperature :	20~25°C
		Relative Humidity :	50~60%

Note symbol

-L	Low channel location
-R	High channel location

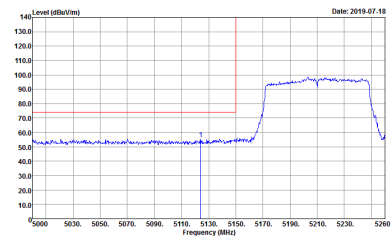
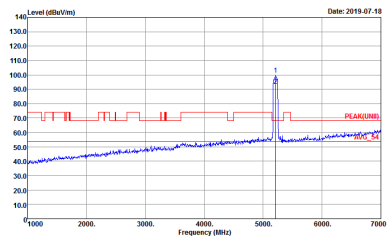
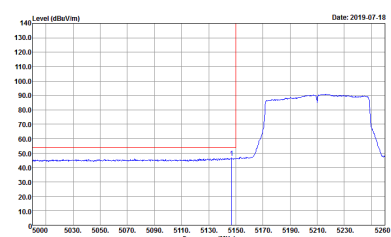

Band 1 - 5150~5250MHz
WIFI 802.11ac VHT80 (Band Edge @ 3m)

WIFI	Band 1 5150~5250MHz Band Edge @ 3m	
ANT	802.11ac VHT80 CH42 5210MHz - L	
1+2	Horizontal	Fundamental
Peak	 <p>Site : 03CH16-HY Condition : PEAK_BE_74 3m 91200_1522 HORIZONTAL Detector : Peak Project : 971021-01</p>	 <p>Site : 03CH16-HY Condition : PEAK(LINE) 3m 91200_1522 HORIZONTAL Detector : Peak Project : 971021-01</p>
Avg.	 <p>Site : 03CH16-HY Condition : AV6_BE_54 3m 91200_1522 HORIZONTAL Detector : Peak Project : 971021-01</p>	Left blank

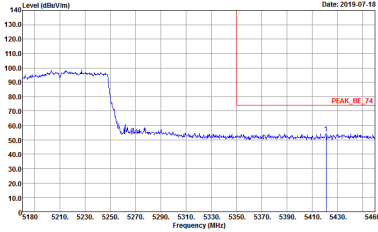
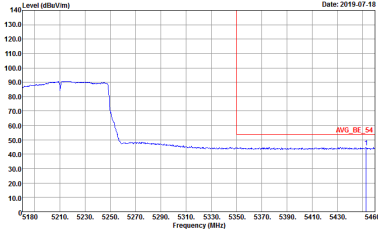

WIFI	Band 1 5150~5250MHz Band Edge @ 3m	
ANT	802.11ac VHT80 CH42 5210MHz - R	
1+2	Horizontal	Fundamental
<p>Peak</p>	 <p>Site : 03CH16-HY Condition : PEAK_BE_74 3m 91200_1522 HORIZONTAL Detector : Peak Project : 971021-01</p>	<p>Left blank</p>
<p>Avg.</p>	 <p>Site : 03CH16-HY Condition : AVG_BE_54 3m 91200_1522 HORIZONTAL Detector : Peak Project : 971021-01</p>	<p>Left blank</p>

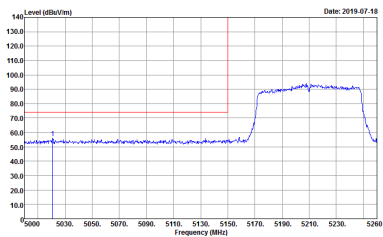
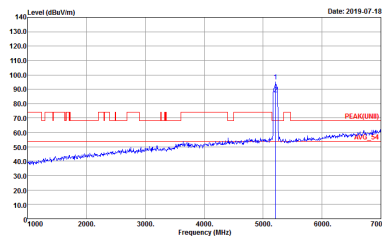

WIFI	Band 1 5150~5250MHz Band Edge @ 3m	
ANT	802.11ac VHT80 CH42 5210MHz - L	
1+2	Vertical	Fundamental
<p>Peak</p>	 <p>Site : 03CH16-HY Condition : PEAK_BE_74 3m 91200_1522 VERTICAL Detector : Peak Project : 971021-01</p>	 <p>Site : 03CH16-HY Condition : PEAK(UNII) 3m 91200_1522 VERTICAL Detector : Peak Project : 971021-01</p>
<p>Avg.</p>	 <p>Site : 03CH16-HY Condition : AVG_BE_54 3m 91200_1522 VERTICAL Detector : Peak Project : 971021-01</p>	<p>Left blank</p>

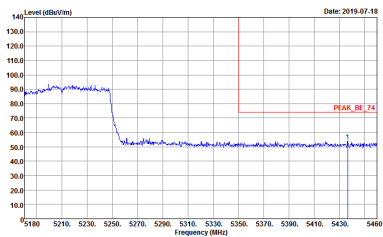
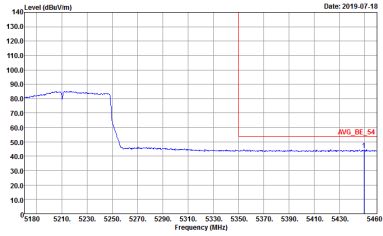

WIFI	Band 1 5150~5250MHz Band Edge @ 3m	
ANT	802.11ac VHT80 CH42 5210MHz - R	
1+2	Vertical	Fundamental
<p>Peak</p>	 <p>Site : 03CH16-HY Condition : PEAK_BE_74 3m 91200_1522 VERTICAL RBW:1000.000KHz VBW:3000.000KHz SWT:Auto Detector : Peak Project : 971021-01</p>	<p>Left blank</p>
<p>Avg.</p>	 <p>Site : 03CH16-HY Condition : AVG_BE_54 3m 91200_1522 VERTICAL RBW:1000.000KHz VBW:3.000KHz SWT:Auto Detector : Peak Project : 971021-01</p>	<p>Left blank</p>



Band 1 - 5150~5250MHz
WIFI 802.11ac VHT80 (Harmonic @ 3m)

WIFI	Band 1 5150~5250MHz Harmonic @ 3m	
ANT	802.11ac VHT80 CH42 5210MHz	
1+2	Horizontal	Vertical
Peak Avg.	<p>Site : 03CH16-HY Condition : PEAK(UNIT) 3m 91200_1522 HORIZONTAL Detector : Peak Project : 971021-01</p>	<p>Site : 03CH16-HY Condition : PEAK(UNIT) 3m 91200_1522 VERTICAL Detector : Peak Project : 971021-01</p>

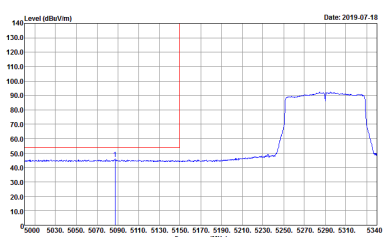

Band 2 - 5250~5350MHz
WIFI 802.11ac VHT80 (Band Edge @ 3m)

WIFI	Band 2 5250~5350MHz Band Edge @ 3m	
ANT	802.11ac VHT80 CH58 5290MHz - L	
1+2	Horizontal	Fundamental
Peak	 <p>Site : 03CH16-HY Condition : PEAK_BE_74 3m 91200_1522 HORIZONTAL Detector : Peak Project : 971021-01 Setting : 0x18</p>	 <p>Site : 03CH16-HY Condition : PEAK(LINE) 3m 91200_1522 HORIZONTAL Detector : Peak Project : 971021-01 Setting : 0x18</p>
Avg.	 <p>Site : 03CH16-HY Condition : AV6_BE_54 3m 91200_1522 HORIZONTAL Detector : Peak Project : 971021-01 Setting : 0x18</p>	Left blank

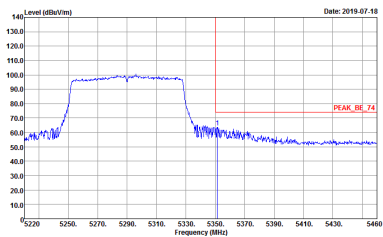
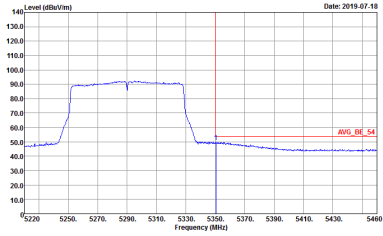

WIFI	Band 2 5250~5350MHz Band Edge @ 3m	
ANT	802.11ac VHT80 CH58 5290MHz - R	
1+2	Horizontal	Fundamental
Peak	 <p>Site : 03CH16-HY Condition : PEAK_BE_74 3m 91200_1522 HORIZONTAL : RBW:1000.000kHz VBW:3000.000kHz SWT:Auto Detector : Peak Project : 971021-01 Setting : 0x1B</p>	Left blank
Avg.	 <p>Site : 03CH16-HY Condition : AVG_BE_54 3m 91200_1522 HORIZONTAL : RBW:1000.000kHz VBW:3.000kHz SWT:Auto Detector : Peak Project : 971021-01 Setting : 0x1B</p>	Left blank

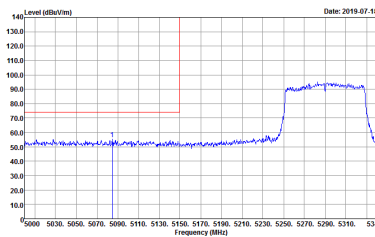
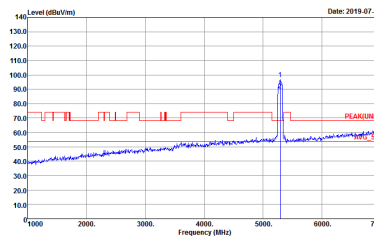

WIFI	Band 2 5250~5350MHz Band Edge @ 3m	
ANT	802.11ac VHT80 CH58 5290MHz - L	
1+2	Vertical	Fundamental
Peak	 <p>Site : 03CH16-HY Condition : PEAK_BE_74 3m 91200_1522 VERTICAL Detector : Peak Project : 971021-01 Setting : 0x1B</p>	 <p>Site : 03CH16-HY Condition : PEAK(UNII) 3m 91200_1522 VERTICAL Detector : Peak Project : 971021-01 Setting : 0x1B</p>
Avg.	 <p>Site : 03CH16-HY Condition : AVG_BE_54 3m 91200_1522 VERTICAL Detector : Peak Project : 971021-01 Setting : 0x1B</p>	Left blank

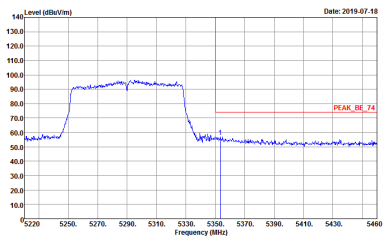
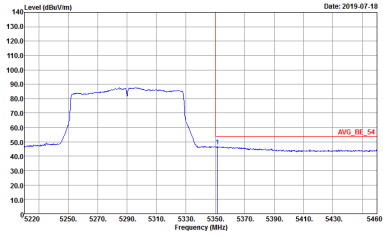

WIFI	Band 2 5250~5350MHz Band Edge @ 3m	
ANT	802.11ac VHT80 CH58 5290MHz - R	
1+2	Vertical	Fundamental
Peak	 <p>Site : 03CH16-HY Condition : PEAK_BE_74 3m 91200_1522 VERTICAL : RBW:1000.000kHz VBW:3000.000kHz SWT:Auto Detector : Peak Project : 971021-01 Setting : 0x1B</p>	Left blank
Avg.	 <p>Site : 03CH16-HY Condition : AVG_BE_54 3m 91200_1522 VERTICAL : RBW:1000.000kHz VBW:3.000kHz SWT:Auto Detector : Peak Project : 971021-01 Setting : 0x1B</p>	Left blank



Band 2 - 5250~5350MHz
WIFI 802.11ac VHT80 (Harmonic @ 3m)

WIFI	Band 2 5250~5350MHz Harmonic @ 3m	
ANT	802.11ac VHT80 CH58 5290MHz	
1+2	Horizontal	Vertical
Peak Avg.	<p>Site : 03CH16-HY Condition : PEAK(UNIT) 3m 91200_1522 HORIZONTAL Detector : Peak Project : 971021-01 Setting : 0x1B</p>	<p>Site : 03CH16-HY Condition : PEAK(UNIT) 3m 91200_1522 VERTICAL Detector : Peak Project : 971021-01 Setting : 0x1B</p>



Band 3 - 5470~5725MHz
WIFI 802.11ac VHT80 (Band Edge @ 3m)

WIFI	Band 3 5470~5725MHz Band Edge @ 3m	
ANT	802.11ac VHT80 CH106 5530MHz - L	
1+2	Horizontal	Fundamental
Peak	<p>Site : 03CH16-HY Condition : PEAK_BE(UNIT)_B3 3m 91200_1522 HORIZONTAL RBW:1000.000KHz VBW:3000.000KHz SWT:Auto Detector : Peak Project : 971021-01 Setting : 0x19</p>	<p>Site : 03CH16-HY Condition : PEAK(UNIT) 3m 91200_1522 HORIZONTAL RBW:1000.000KHz VBW:3000.000KHz SWT:Auto Detector : Peak Project : 971021-01 Setting : 0x19</p>
Avg.	<p>Site : 03CH16-HY Condition : AV6_BE(UNIT)_B3 3m 91200_1522 HORIZONTAL RBW:1000.000KHz VBW:3.000KHz SWT:Auto Detector : Peak Project : 971021-01 Setting : 0x19</p>	Left blank



WIFI	Band 3 5470~5725MHz Band Edge @ 3m	
ANT	802.11ac VHT80 CH106 5530MHz - R	
1+2	Horizontal	Fundamental
Peak	<p>Site : D8CH16-111 Condition : PEAK_BE([UNIT], B3 3m 91200_1522 HORIZONTAL Detector : Peak Project : 971021-01 Setting : 0x19</p>	Left blank

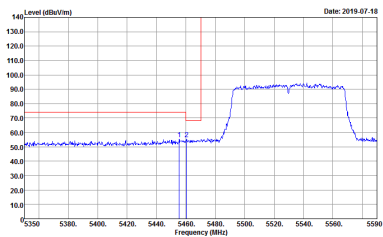
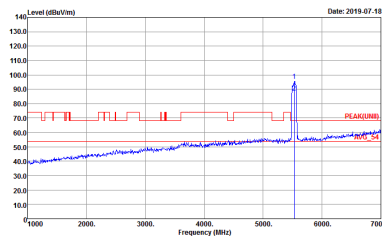
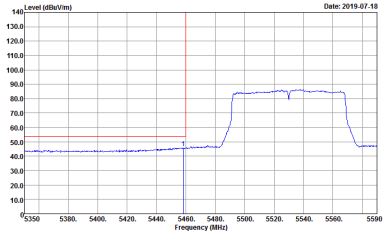

WIFI	Band 3 5470~5725MHz Band Edge @ 3m	
ANT	802.11ac VHT80 CH106 5530MHz - L	
1+2	Vertical	Fundamental
<p>Peak</p>	 <p>Site : 03CH16-HY Condition : PEAK_BE(UNIT)_B3 3m 91200_1522 VERTICAL Detector : Peak Project : 971021-01 Setting : 0x19</p>	 <p>Site : 03CH16-HY Condition : PEAK(UNIT)_3m 91200_1522 VERTICAL Detector : Peak Project : 971021-01 Setting : 0x19</p>
<p>Avg.</p>	 <p>Site : 03CH16-HY Condition : AVG_BE(UNIT)_B3 3m 91200_1522 VERTICAL Detector : Peak Project : 971021-01 Setting : 0x19</p>	<p>Left blank</p>



WIFI	Band 3 5470~5725MHz Band Edge @ 3m	
ANT	802.11ac VHT80 CH106 5530MHz - R	
1+2	Vertical	Fundamental
Peak	<p>Site : D3CH16-111 Condition : PEAK_BE([UNIT]), B3 3m 91200_1522 VERTICAL Detector : Peak Project : 971021-01 Setting : 0x19</p>	Left blank



Band 3 - 5470~5725MHz
WIFI 802.11ac VHT80 (Harmonic @ 3m)

WIFI	Band 3 5470~5725MHz Harmonic @ 3m	
ANT	802.11ac VHT80 CH106 5530MHz	
1+2	Horizontal	Vertical
Peak Avg.	<p>Site : 03CH16-HY Condition : PEAK(UNIT) 3m 91200_1522 HORIZONTAL Detector : Peak Project : 971021-01 Setting : 0x19</p>	<p>Site : 03CH16-HY Condition : PEAK(UNIT) 3m 91200_1522 VERTICAL Detector : Peak Project : 971021-01 Setting : 0x19</p>



Emission below 1GHz
5GHz WIFI 802.11ac VHT80 (LF)

WIFI	5GHz WIFI	
ANT	802.11ac VHT80 LF	
1+2	Horizontal	Vertical
QP / Peak	<p>Site : 03CH16-HY Condition : QP 3m BIL06_47020606 HORIZONTAL Detector : Peak Project : 971021-01</p>	<p>Site : 03CH16-HY Condition : QP 3m BIL06_47020606 VERTICAL Detector : Peak Project : 971021-01</p>



Appendix D. Duty Cycle Plots

Antenna	Band	Duty Cycle(%)	T(us)	1/T(kHz)	VBW Setting	Duty Factor(dB)
1+2	5GHz 802.11ac VHT80 for Ant. 1	93.78	588	1.70	3kHz	0.28
1+2	5GHz 802.11ac VHT80 for Ant. 2	94.26	591	1.69	3kHz	0.26



MIMO <Ant. 1>

802.11ac VHT80

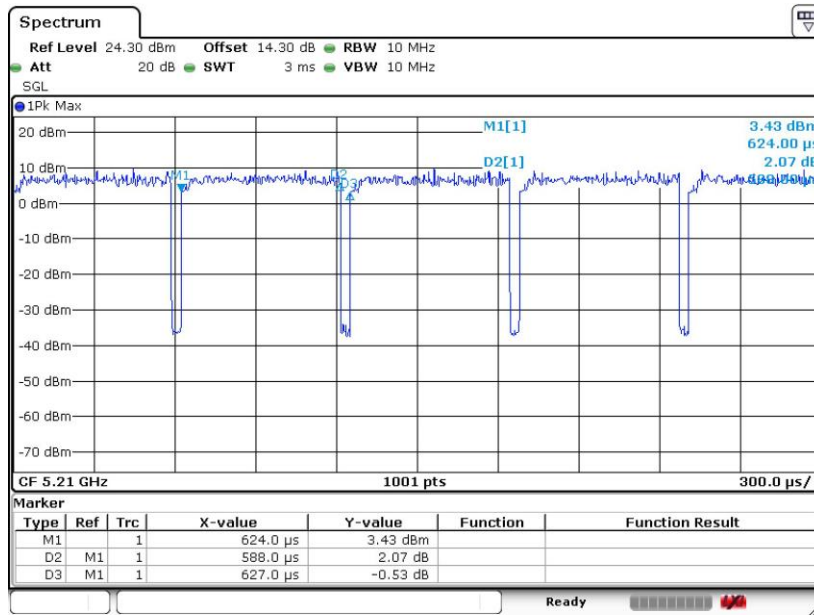

Date: 23.JUL.2019 11:17:57

MIMO <Ant. 2>

802.11ac VHT80

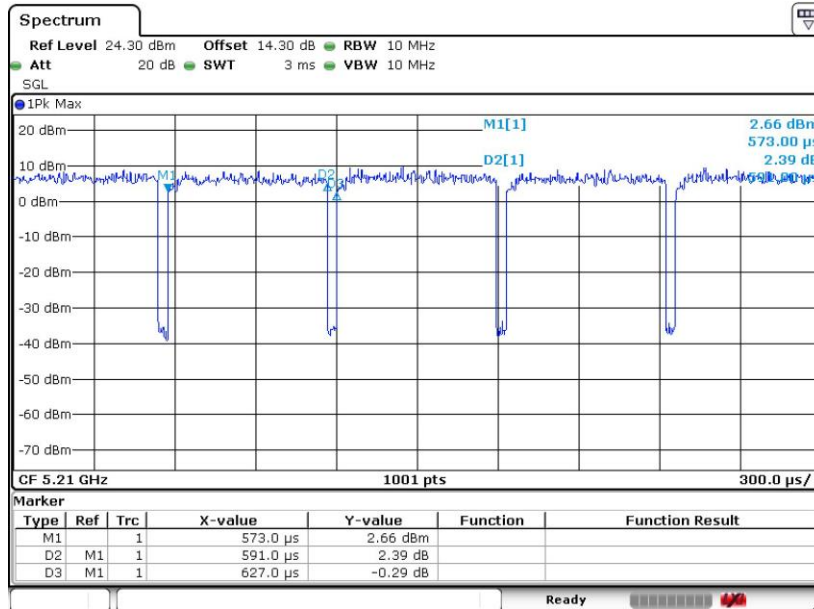

Date: 23.JUL.2019 11:18:43

—THE END—