



# FCC RADIO TEST REPORT

**FCC ID** : PY7-502520  
**Equipment** : GSM/WCDMA/LTE Phone with BT, DTS/UNII  
a/b/g/n/ac, GPS and NFC  
**Brand Name** : Sony  
**Applicant** : Sony Mobile Communications Inc.  
4-12-3 Higashi-Shinagawa, Shinagawa-ku,  
Tokyo, 140-0002, Japan  
**Manufacturer** : Sony Mobile Communications Inc.  
4-12-3 Higashi-Shinagawa, Shinagawa-ku,  
Tokyo, 140-0002, Japan  
**Standard** : FCC Part 15 Subpart C §15.247

The product was received on Jun. 10, 2019 and testing was started from Jul. 22, 2019 and completed on Jul. 25, 2019. We, SPORTON INTERNATIONAL INC. EMC & Wireless Communications Laboratory, would like to declare that the tested sample has been evaluated in accordance with the test procedures and has been in compliance with the applicable technical standards.

The report must not be used by the client to claim product certification, approval, or endorsement by TAF or any agency of government.

The test results in this spot check data report apply exclusively to the tested model / sample. Without written approval of SPORTON INTERNATIONAL INC. EMC & Wireless Communications Laboratory, the test report shall not be reproduced except in full.

Reviewed by: Jones Tsai

**SPORTON INTERNATIONAL INC. EMC & Wireless Communications Laboratory**  
No. 52, Huaya 1st Rd., Guishan Dist., Taoyuan City, Taiwan (R.O.C.)



## Table of Contents

**History of this test report..... 3**

**Summary of Test Result..... 4**

**1 General Description..... 5**

    1.1 Product Feature of Equipment Under Test..... 5

    1.2 Modification of EUT ..... 5

    1.3 Testing Location ..... 6

    1.4 Applicable Standards..... 6

**2 Test Configuration of Equipment Under Test ..... 7**

    2.1 Carrier Frequency Channel ..... 7

    2.2 Test Mode..... 8

    2.3 Connection Diagram of Test System..... 9

    2.4 EUT Operation Test Setup ..... 9

**3 Test Result..... 10**

    3.1 Output Power Measurement..... 10

    3.2 Radiated Band Edges and Spurious Emission Measurement ..... 11

    3.3 Antenna Requirements..... 15

**4 List of Measuring Equipment ..... 16**

**5 Uncertainty of Evaluation ..... 18**

**Appendix A. Conducted Test Results**

**Appendix B. Radiated Spurious Emission**

**Appendix C. Radiated Spurious Emission Plots**

**Appendix D. Duty Cycle Plots**



### History of this test report

Report No.	Version	Description	Issued Date
FR971021-01A	01	Initial issue of report	Aug. 15, 2019



### Summary of Test Result

Report Clause	Ref Std. Clause	Test Items	Result (PASS/FAIL)	Remark
-	15.247(a)(1)	Number of Channels	Not Required	-
-	15.247(a)(1)	Hopping Channel Separation	Not Required	-
-	15.247(a)(1)	Dwell Time of Each Channel	Not Required	-
-	15.247(a)(1)	20dB Bandwidth	Not Required	-
-	2.1049	99% Occupied Bandwidth	Not Required	-
3.1	15.247(b)(1)	Peak Output Power	Pass	-
-	15.247(d)	Conducted Band Edges	Not Required	-
-	15.247(d)	Conducted Spurious Emission	Not Required	-
3.2	15.247(d)	Radiated Band Edges and Radiated Spurious Emission	Pass	Under limit 7.18 dB at 42.610 MHz
-	15.207	AC Conducted Emission	Not Required	-
3.3	15.203 & 15.247(b)	Antenna Requirement	Pass	-

**Remark:**

1. Not required means after assessing, test items are not necessary to carry out.
2. This is a spot check data report and data performed in appendix of this report are chosen from the worst case of the original FCC ID report. All the test cases were performed on original report which can be referred to Sporton Report Number FR940901-03A.

**Declaration of Conformity:**

The test results with all measurement uncertainty excluded are presented in accordance with the regulation limits or requirements declared by manufacturers.

**Comments and Explanations:**

The declared of product specification for EUT presented in the report are provided by the manufacturer, and the manufacturer takes all the responsibilities for the accuracy of product specification.

**Reviewed by: Wii Chang**

**Report Producer: Yimin Ho**



# 1 General Description

## 1.1 Product Feature of Equipment Under Test

GSM/WCDMA/LTE, Bluetooth, DTS/UNII a/b/g/n/ac, NFC, and GNSS.

Standards-related Product Specification	
Antenna Type / Gain	Loop Antenna with gain -2.6 dBi

EUT Information List			
HW Version	SW Version	IMEI	Performed Test Item
A	0_77003_A_28_2	004402459556613	RF conducted measurement
	3.122	004402459554238	Radiated Spurious Emission

Accessory List	
AC Adapter	Model Name : UCH32
	S/N: 6218W30200106
Earphone	Model Name.: MH750
	S/N : N/A
USB Cable	Model Name.: UCB24
	S/N : N/A
2 in 1 USB Audio Cable	Model Name.: EC270
	S/N : N/A

**Note:**

1. Above EUT list used are electrically identical per declared by manufacturer.
2. Above the accessories list are used to exercise the EUT during test, and the serial number of each type of accessories is listed in each section of this report. .
3. For other wireless features of this EUT, test report will be issued separately.
4. The firmware installed in the EUT during testing was 0\_77003\_A\_28\_2.

## 1.2 Modification of EUT

No modifications are made to the EUT during all test items.



### 1.3 Testing Location

<b>Test Site</b>	SPORTON INTERNATIONAL INC. EMC & Wireless Communications Laboratory
<b>Test Site Location</b>	No.52, Huaya 1st Rd., Guishan Dist., Taoyuan City, Taiwan (R.O.C.) TEL: +886-3-327-3456 FAX: +886-3-328-4978
<b>Test Site No.</b>	<b>Sporton Site No.</b>
	TH05-HY

**Note:** The test site complies with ANSI C63.4 2014 requirement.

<b>Test Site</b>	SPORTON INTERNATIONAL INC. EMC & Wireless Communications Laboratory
<b>Test Site Location</b>	No.58, Aly. 75, Ln. 564, Wenhua 3rd, Rd., Guishan Dist., Taoyuan City, Taiwan (R.O.C.) TEL: +886-3-327-0868 FAX: +886-3-327-0855
<b>Test Site No.</b>	<b>Sporton Site No.</b>
	03CH11-HY

**Note:** The test site complies with ANSI C63.4 2014 requirement.

FCC Designation No.: TW1190 and TW0007

### 1.4 Applicable Standards

According to the specifications of the manufacturer, the EUT must comply with the requirements of the following standards:

- ♦ FCC Part 15 Subpart C §15.247
- ♦ FCC KDB Publication No. 558074 D01 DTS Meas. Guidance v05r02
- ♦ FCC KDB 414788 D01 Radiated Test Site v01r01.
- ♦ ANSI C63.10-2013

**Remark:**

1. All test items were verified and recorded according to the standards and without any deviation during the test.
2. This EUT has also been tested and complied with the requirements of FCC Part 15, Subpart B, recorded in a separate test report.



## 2 Test Configuration of Equipment Under Test

### 2.1 Carrier Frequency Channel

Frequency Band	Channel	Freq. (MHz)	Channel	Freq. (MHz)	Channel	Freq. (MHz)
2400-2483.5 MHz	0	2402	27	2429	54	2456
	1	2403	28	2430	55	2457
	2	2404	29	2431	56	2458
	3	2405	30	2432	57	2459
	4	2406	31	2433	58	2460
	5	2407	32	2434	59	2461
	6	2408	33	2435	60	2462
	7	2409	34	2436	61	2463
	8	2410	35	2437	62	2464
	9	2411	36	2438	63	2465
	10	2412	37	2439	64	2466
	11	2413	38	2440	65	2467
	12	2414	39	2441	66	2468
	13	2415	40	2442	67	2469
	14	2416	41	2443	68	2470
	15	2417	42	2444	69	2471
	16	2418	43	2445	70	2472
	17	2419	44	2446	71	2473
	18	2420	45	2447	72	2474
	19	2421	46	2448	73	2475
	20	2422	47	2449	74	2476
	21	2423	48	2450	75	2477
	22	2424	49	2451	76	2478
	23	2425	50	2452	77	2479
	24	2426	51	2453	78	2480
	25	2427	52	2454	-	-
	26	2428	53	2455	-	-



## 2.2 Test Mode

- a. The EUT has been associated with peripherals and configuration operated in a manner tended to maximize its emission characteristics in a typical application. Frequency range investigated: radiation emission (9 kHz to the 10th harmonic of the highest fundamental frequency or to 40 GHz, whichever is lower). For radiated measurement, pre-scanned in three orthogonal panels, X, Y, Z and Accessory. The worst cases (X plane with Adapter) were recorded in this report, and the worst mode of radiated spurious emissions is Bluetooth 1Mbps mode, and recorded in this report.

The following summary table is showing all test modes to demonstrate in compliance with the standard.

Summary table of Test Cases	
Test Item	Data Rate / Modulation
Radiated Test Cases	Bluetooth 1Mbps GFSK
	Mode 1: CH78_2480 MHz for 1Mbps



## 2.3 Connection Diagram of Test System

<Bluetooth Tx Mode>

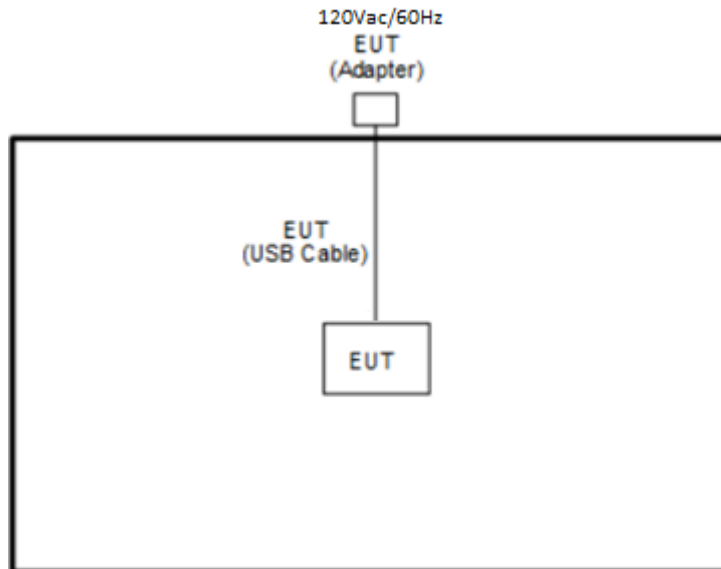

## 2.4 EUT Operation Test Setup

The RF test items, utility “Tera Term” was installed in Notebook which was programmed in order to make the EUT get into the engineering modes to provide channel selection, power level, data rate and the application type and for continuous transmitting signals.

### **3 Test Result**

#### **3.1 Output Power Measurement**

##### **3.1.1 Limit of Output Power**

The maximum peak conducted output power of the intentional radiator shall not exceed the following:  
(1) For frequency hopping systems operating in the 2400-2483.5 MHz band employing at least 75 non-overlapping hopping channels, and all frequency hopping systems in the 5725-5850 MHz band: 1 watt. For all other frequency hopping systems in the 2400-2483.5 MHz band 0.125 watts. The power limit for 1Mbps, 2Mbps, 3Mbps and AFH modes are 0.125 watts.

##### **3.1.2 Measuring Instruments**

See list of measuring equipment of this test report.

##### **3.1.3 Test Procedures**

1. The testing follows ANSI C63.10-2013 clause 7.8.5.
1. The RF output of EUT was connected to the power meter by RF cable and attenuator. The path loss was compensated to the results for each measurement.
2. Set to the maximum power setting and enable the EUT transmit continuously.
3. Measure the conducted output power with cable loss and record the results in the test report.
4. Measure and record the results in the test report.

##### **3.1.4 Test Setup**

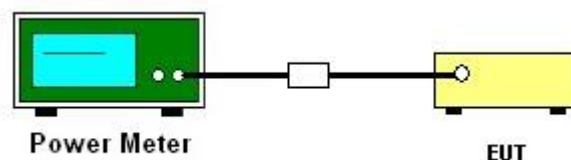

##### **3.1.5 Test Result of Peak Output Power**

Please refer to Appendix A.

##### **3.1.6 Test Result of Average Output Power (Reporting Only)**

Please refer to Appendix A.



### 3.2 Radiated Band Edges and Spurious Emission Measurement

#### 3.2.1 Limit of Radiated Band Edges and Spurious Emission

In any 100 kHz bandwidth outside the intentional radiator frequency band, all harmonics/spurious must be at least 20 dB below the highest emission level within the authorized band. In addition, radiated emissions which fall in the restricted bands must also comply with the limits as below.

Frequency (MHz)	Field Strength (microvolts/meter)	Measurement Distance (meters)
0.009 – 0.490	2400/F(kHz)	300
0.490 – 1.705	24000/F(kHz)	30
1.705 – 30.0	30	30
30 – 88	100	3
88 – 216	150	3
216 - 960	200	3
Above 960	500	3

#### 3.2.2 Measuring Instruments

See list of measuring equipment of this test report.



### 3.2.3 Test Procedures

1. The EUT was placed on a turntable with 0.8 meter for frequency below 1GHz and 1.5 meter for frequency above 1GHz respectively above ground.
2. The EUT was set 3 meters from the interference receiving antenna, which was mounted on the top of a variable height antenna tower.
3. For each suspected emission, the EUT was arranged to its worst case and then tune the Antenna tower (from 1 m to 4 m) and turntable (from 0 degree to 360 degrees) to find the maximum reading. A pre-amp and a high pass filter are used for the test in order to get better signal level to comply with the guidelines.
4. Set to the maximum power setting and enable the EUT transmit continuously.
5. Use the following spectrum analyzer settings:
  - (1) Span shall wide enough to fully capture the emission being measured;
  - (2) Set RBW=100 kHz for  $f < 1$  GHz, RBW=1MHz for  $f > 1$ GHz ; VBW  $\geq$  RBW; Sweep = auto; Detector function = peak; Trace = max hold for peak
  - (3) For average measurement: use duty cycle correction factor method per 15.35(c).  
Duty cycle = On time/100 milliseconds  
On time =  $N_1 * L_1 + N_2 * L_2 + \dots + N_{n-1} * L_{n-1} + N_n * L_n$   
Where  $N_1$  is number of type 1 pulses,  $L_1$  is length of type 1 pulses, etc.  
Average Emission Level = Peak Emission Level +  $20 * \log(\text{Duty cycle})$
6. Corrected Reading: Antenna Factor + Cable Loss + Read Level - Preamp Factor = Level
7. For testing below 1GHz, if the emission level of the EUT in peak mode was 3 dB lower than the limit specified, then peak values of EUT will be reported, otherwise, the emissions will be repeated one by one using the CISPR quasi-peak method and reported.
8. For testing above 1GHz, the emission level of the EUT in peak mode was 20dB lower than average limit (that means the emission level in average mode also complies with the limit in average mode), then peak values of EUT will be reported, otherwise, the emissions will be measured in average mode again and reported.

Note: The average levels were calculated from the peak level corrected with duty cycle correction factor (-24.79dB) derived from  $20 \log(\text{dwell time}/100\text{ms})$ . This correction is only for signals that hop with the fundamental signal, such as band-edge and harmonic. Other spurious signals that are independent of the hopping signal would not use this correction.

### 3.2.4 Test Setup

For radiated emissions below 30MHz

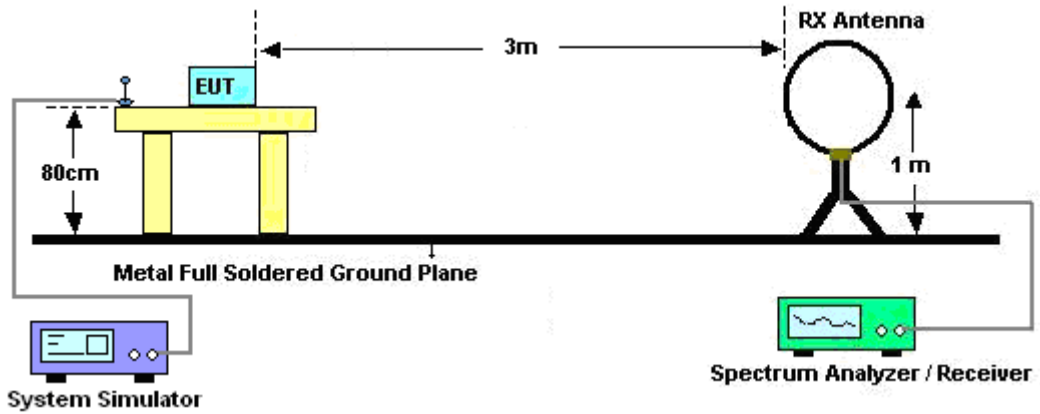

For radiated emissions from 30MHz to 1GHz

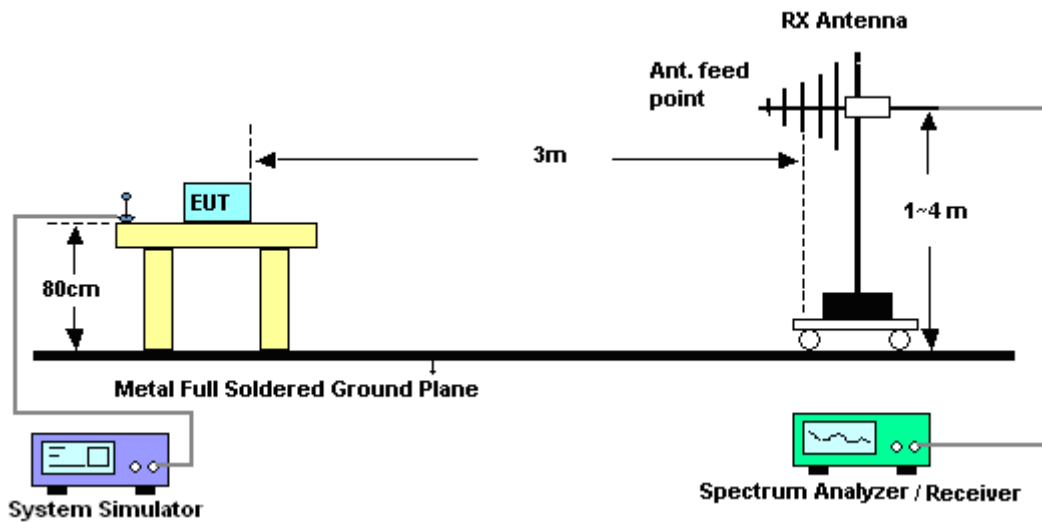

For radiated emissions above 1GHz

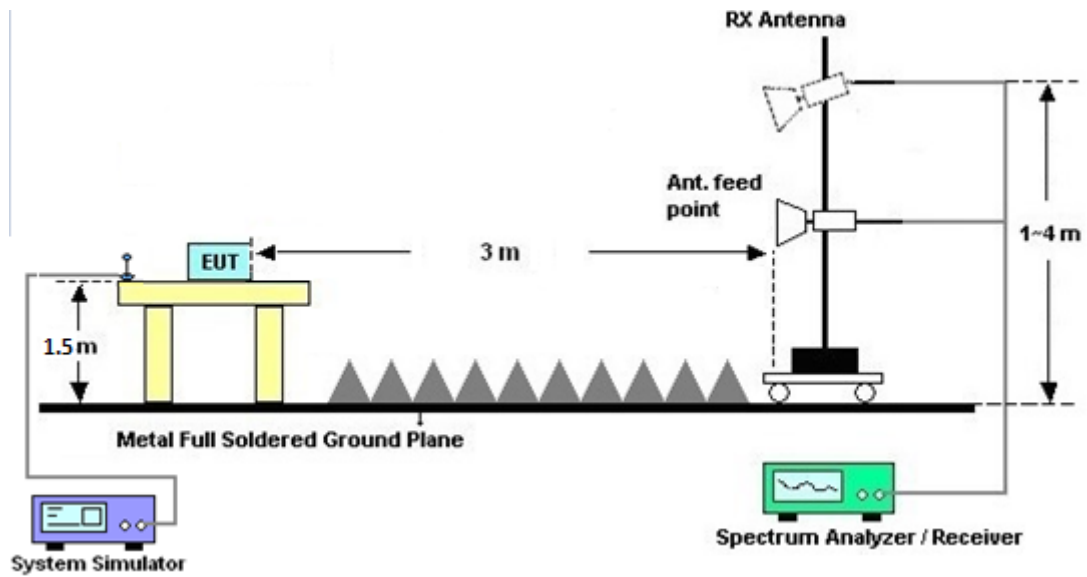

### 3.2.5 Test Results of Radiated Spurious Emissions (9 kHz ~ 30 MHz)

The low frequency, which started from 9 kHz to 30MHz, was pre-scanned and the result which was 20dB lower than the limit line was not reported.

There is a comparison data of both open-field test site and alternative test site - semi-Anechoic chamber according to 414788 D01 Radiated Test Site v01r01, and the result came out very similar.

### 3.2.6 Test Result of Radiated Spurious at Band Edges

Please refer to Appendix B and C.

### 3.2.7 Duty Cycle

Please refer to Appendix D.

### 3.2.8 Test Result of Radiated Spurious Emission (30MHz ~ 10<sup>th</sup> Harmonic)

Please refer to Appendix B and C.



### **3.3 Antenna Requirements**

#### **3.3.1 Standard Applicable**

If directional gain of transmitting antennas is greater than 6dBi, the power shall be reduced by the same level in dB comparing to gain minus 6dBi. The use of a permanently attached antenna or of an antenna that uses a unique coupling to the intentional radiator shall be considered sufficient to comply with the rule.

#### **3.3.2 Antenna Anti-Replacement Construction**

An embedded-in antenna design is used.

#### **3.3.3 Antenna Gain**

The antenna peak gain of EUT is less than 6 dBi. Therefore, it is not necessary to reduce maximum peak output power limit.



## 4 List of Measuring Equipment

Instrument	Manufacturer	Model No.	Serial No.	Characteristics	Calibration Date	Test Date	Due Date	Remark
Hygrometer	Testo	DTM-303A	TP157075	N/A	Nov. 05, 2018	Jul. 22, 2019~ Jul. 23, 2019	Nov. 04, 2019	Conducted (TH05-HY)
Power Meter	Agilent	E4416A	GB4129234 4	N/A	Dec. 27, 2018	Jul. 22, 2019~ Jul. 23, 2019	Dec. 26, 2019	Conducted (TH05-HY)
Power Sensor	Agilent	E9327A	US40441548	50MHz~18GHz	Dec. 27, 2018	Jul. 22, 2019~ Jul. 23, 2019	Dec. 26, 2019	Conducted (TH05-HY)
Signal Analyzer	Rohde & Schwarz	FSV40	101397	10Hz~40GHz	Nov. 13, 2018	Jul. 22, 2019~ Jul. 23, 2019	Nov. 12, 2019	Conducted (TH05-HY)
Switch Box & RF Cable	Burgeon	ETF-058	EC1208382	N/A	Mar. 27, 2019	Jul. 22, 2019~ Jul. 23, 2019	Mar. 26, 2020	Conducted (TH05-HY)
Loop Antenna	Rohde & Schwarz	HFH2-Z2	100488	9 kHz~30 MHz	Jan. 07, 2019	Jul. 24, 2019~ Jul. 25, 2019	Jan. 06, 2020	Radiation (03CH11-HY)
Bilog Antenna	TESEQ	CBL 6111D &N-6-06	35414&AT-N 0602	30MHz~1GHz	Oct. 13, 2018	Jul. 24, 2019~ Jul. 25, 2019	Oct. 12, 2019	Radiation (03CH11-HY)
Horn Antenna	SCHWARZBE CK	BBHA 9120 D	9120D-1326	1GHz ~ 18GHz	Oct. 30, 2018	Jul. 24, 2019~ Jul. 25, 2019	Oct. 29, 2019	Radiation (03CH11-HY)
SHF-EHF Horn Antenna	SCHWARZBE CK	BBHA 9170	BBHA91705 84	18GHz- 40GHz	Dec. 05, 2018	Jul. 24, 2019~ Jul. 25, 2019	Dec. 04, 2019	Radiation (03CH11-HY)
Amplifier	SONOMA	310N	187312	9kHz~1GHz	Dec. 04, 2018	Jul. 24, 2019~ Jul. 25, 2019	Dec. 03, 2019	Radiation (03CH11-HY)
Preamplifier	Jet-Power	JPA0118-55- 303	1710001800 055007	1GHz~18GHz	Apr. 01, 2019	Jul. 24, 2019~ Jul. 25, 2019	Mar. 31, 2020	Radiation (03CH11-HY)
Preamplifier	Keysight	83017A	MY5327008 0	1GHz~26.5GHz	Nov. 14, 2018	Jul. 24, 2019~ Jul. 25, 2019	Nov. 13, 2020	Radiation (03CH11-HY)
Preamplifier	EMEC	EM18G40G	060715	18GHz ~ 40GHz	Dec. 06, 2018	Jul. 24, 2019~ Jul. 25, 2019	Dec. 05, 2019	Radiation (03CH11-HY)
Spectrum Analyzer	Keysight	N9010A	MY5420048 6	10Hz ~ 44GHz	Oct. 19, 2018	Jul. 24, 2019~ Jul. 25, 2019	Oct. 18, 2019	Radiation (03CH11-HY)
Hygrometer	TECEPEL	DTN-303B	TP140325	N/A	Nov. 05, 2018	Jul. 24, 2019~ Jul. 25, 2019	Nov. 04, 2019	Radiation (03CH11-HY)
Filter	Wainwright	WLK4-1000- 1530-8000-4 0SS	SN11	1G Low Pass	Sep. 16, 2018	Jul. 24, 2019~ Jul. 25, 2019	Sep. 17, 2019	Radiation (03CH11-HY)
Filter	Wainwright	WHKX12-27 00-3000-180 00-60SS	SN3	2.7G High Pass	Sep. 16, 2018	Jul. 24, 2019~ Jul. 25, 2019	Sep. 17, 2019	Radiation (03CH11-HY)
RF Cable	HUBER + SUHNER	SUCOFLEX 104	MY9837/4P E	9kHz-30MHz	Mar. 13, 2019	Jul. 24, 2019~ Jul. 25, 2019	Mar. 12, 2020	Radiation (03CH11-HY)
RF Cable	HUBER + SUHNER	SUCOFLEX 102	MY2859/2	30MHz-40GHz	Mar. 13, 2019	Jul. 24, 2019~ Jul. 25, 2019	Mar. 12, 2020	Radiation (03CH11-HY)
RF Cable	HUBER + SUHNER	SUCOFLEX 104	MY9837/4P E	30M-18G	Mar. 13, 2019	Jul. 24, 2019~ Jul. 25, 2019	Mar. 12, 2020	Radiation (03CH11-HY)
RF Cable	HUBER + SUHNER	SUCOFLEX 102	MY4274/2	30MHz-40GHz	Mar. 13, 2019	Jul. 24, 2019~ Jul. 25, 2019	Mar. 12, 2020	Radiation (03CH11-HY)





Instrument	Manufacturer	Model No.	Serial No.	Characteristics	Calibration Date	Test Date	Due Date	Remark
Controller	EMEC	EM 1000	N/A	Control Turn table & Ant Mast	N/A	Jul. 24, 2019~ Jul. 25, 2019	N/A	Radiation (03CH11-HY)
Antenna Mast	EMEC	AM-BS-4500 -B	N/A	1~4m	N/A	Jul. 24, 2019~ Jul. 25, 2019	N/A	Radiation (03CH11-HY)
Turn Table	EMEC	TT 2000	N/A	0~360 Degree	N/A	Jul. 24, 2019~ Jul. 25, 2019	N/A	Radiation (03CH11-HY)
Software	Audix	E3 6.2009-8-24	RK-001042	N/A	N/A	Jul. 24, 2019~ Jul. 25, 2019	N/A	Radiation (03CH11-HY)



## 5 Uncertainty of Evaluation

### Uncertainty of Radiated Emission Measurement (30 MHz ~ 1000 MHz)

Measuring Uncertainty for a Level of Confidence of 95% ( $U = 2Uc(y)$ )	5.20
---	------

### Uncertainty of Radiated Emission Measurement (1000 MHz ~ 18000 MHz)

Measuring Uncertainty for a Level of Confidence of 95% ( $U = 2Uc(y)$ )	5.50
---	------

### Uncertainty of Radiated Emission Measurement (18000 MHz ~ 40000 MHz)

Measuring Uncertainty for a Level of Confidence of 95% ( $U = 2Uc(y)$ )	5.20
---	------

### Appendix A. Test Result of Conducted Test Items

Test Engineer:	Howard Lin	Temperature:	21~25	°C
Test Date:	2019/7/22~2019/7/23	Relative Humidity:	51~54	%

**TEST RESULTS DATA**

**Peak Power Table**

DH	CH.	NTX	Peak Power (dBm)	Power Limit (dBm)	Test Result
DH1	0	1	10.29	20.97	Pass
	39	1	10.03	20.97	Pass
	78	1	<b>10.60</b>	20.97	Pass
2DH5	0	1	9.56	20.97	Pass
	39	1	9.37	20.97	Pass
	78	1	<b>10.28</b>	20.97	Pass
3DH3	0	1	9.93	20.97	Pass
	39	1	9.78	20.97	Pass
	78	1	<b>10.57</b>	20.97	Pass

**TEST RESULTS DATA**

**Average Power Table**  
***(Reporting Only)***

DH	CH.	NTX	Average Power (dBm)	Duty Factor (dB)
DH1	0	1	10.10	5.15
	39	1	9.89	5.15
	78	1	<b>10.35</b>	5.15
2DH1	0	1	7.01	5.08
	39	1	7.00	5.08
	78	1	<b>7.65</b>	5.08
3DH1	0	1	7.05	5.08
	39	1	6.92	5.08
	78	1	<b>7.68</b>	5.08



## Appendix B. Radiated Spurious Emission

Test Engineer :	Bill Kuo, Fu Chen, Troye Hsieh	Temperature :	21.3~24.7°C
		Relative Humidity :	53.5~66.9%

### 2.4GHz 2400~2483.5MHz

#### BT 1Mbps (Band Edge @ 3m)

BT	Note	Frequency ( MHz )	Level ( dBμV/m )	Over Limit ( dB )	Limit Line ( dBμV/m )	Read Level ( dBμV )	Antenna Factor ( dB/m )	Path Loss ( dB )	Preamp Factor ( dB )	Ant Pos ( cm )	Table Pos ( deg )	Peak Avg. ( P/A )	Pol. ( H/V )	
BT CH 78 2480MHz	*	2480	102.94	-	-	102.44	27.3	6.8	33.6	125	40	P	H	
	*	2480	78.18	-	-	-	-	-	-	-	-	A	H	
		2483.52	49.84	-24.16	74	49.33	27.3	6.81	33.6	125	40	P	H	
		2483.52	25.08	-28.92	54	-	-	-	-	-	-	A	H	
													H	
														H
	*	2480	97.98	-	-	97.48	27.3	6.8	33.6	373	107	P	V	
	*	2480	73.22	-	-	-	-	-	-	-	-	-	A	H
		2483.52	44.69	-29.31	74	44.18	27.3	6.81	33.6	373	107	P	V	
		2483.52	19.93	-34.07	54	-	-	-	-	-	-	A	H	
														V
														V
Remark	<ol style="list-style-type: none"> <li>No other spurious found.</li> <li>All results are PASS against Peak and Average limit line.</li> </ol>													



2.4GHz 2400~2483.5MHz

BT 1Mbps (Harmonic @ 3m)

BT	Note	Frequency	Level	Over	Limit	Read	Antenna	Path	Preamp	Ant	Table	Peak	Pol.
		( MHz )	( dBμV/m )	( dB )	Limit Line	Level	Factor	Loss	Factor	Pos	Pos	Avg.	
					( dBμV/m )	( dBμV )	( dB/m )	( dB )	( dB )	( cm )	( deg )	( P/A )	( H/V )
BT CH 78 2480MHz		4960	38.55	-35.45	74	55.31	31.32	10.7	59.19	100	0	P	H
		4960	13.79	-40.21	54	-	-	-	-	-	-	A	H
		7440	42.38	-31.62	74	51.4	36.48	13.24	59.12	100	0	P	H
		7440	17.62	-36.38	54	-	-	-	-	-	-	A	H
		4960	37.86	-36.14	74	54.62	31.32	10.7	59.19	100	0	P	V
		4960	13.1	-40.9	54	-	-	-	-	-	-	A	V
		7440	41.47	-32.53	74	50.49	36.48	13.24	59.12	100	0	P	V
		7440	16.71	-37.29	54	-	-	-	-	-	-	A	V

**Remark**

- No other spurious found.
- All results are PASS against Peak and Average limit line.



Emission below 1GHz

2.4GHz BT (LF)

BT	Note	Frequency	Level	Over	Limit	Read	Antenna	Path	Preamp	Ant	Table	Peak	Pol.	
		( MHz )	( dBμV/m )	( dB )	Line	Level	Factor	Loss	Factor	Pos	Pos	Avg.	(H/V)	
					( dBμV/m )	( dBμV )	( dB/m )	( dB )	( dB )	( cm )	( deg )	( P/A )		
2.4GHz BT LF		30.97	21.95	-18.05	40	29.96	23.58	0.78	32.37	-	-	P	H	
		148.34	29.91	-13.59	43.5	43.6	16.95	1.64	32.28	-	-	P	H	
		177.44	26.47	-17.03	43.5	41.92	14.93	1.88	32.26	-	-	P	H	
		943.74	33.01	-12.99	46	29.47	30.19	4.3	30.95	-	-	P	H	
		951.5	33.14	-12.86	46	29.07	30.64	4.31	30.88	-	-	P	H	
		959.26	33.2	-12.8	46	28.69	30.97	4.34	30.8	100	0	P	H	
														H
														H
														H
														H
														H
														H
														H
														H
														H
														H
														H
														H
			42.61	32.82	-7.18	40	46.57	17.75	0.87	32.37	100	0	P	V
			73.65	22.56	-17.44	40	41.33	12.4	1.18	32.35	-	-	P	V
		149.31	24.25	-19.25	43.5	37.97	16.91	1.65	32.28	-	-	P	V	
		929.19	32.43	-13.57	46	29.81	29.44	4.26	31.08	-	-	P	V	
		935.01	32.5	-13.5	46	29.55	29.71	4.27	31.03	-	-	P	V	
		943.74	33.73	-12.27	46	30.19	30.19	4.3	30.95	-	-	P	V	
													V	
													V	
													V	
													V	
													V	
													V	
													V	
													V	
													V	
Remark	1. No other spurious found. 2. All results are PASS against limit line.													



**Note symbol**

*	<b>Fundamental Frequency</b> which can be ignored. However, the level of any unwanted emissions shall not exceed the level of the fundamental frequency.
!	Test result is <b>over limit</b> line.
P/A	<b>Peak</b> or <b>Average</b>
H/V	<b>Horizontal</b> or <b>Vertical</b>



A calculation example for radiated spurious emission is shown as below:

BT	Note	Frequency	Level	Over	Limit	Read	Antenna	Path	Preamp	Ant	Table	Peak	Pol.
		( MHz )	( dBμV/m )	( dB )	Line ( dBμV/m )	Level ( dBμV )	Factor ( dB/m )	Loss ( dB )	Factor ( dB )	Pos ( cm )	Pos ( deg )	Avg. ( P/A )	( H/V )
BT CH 00 2402MHz		2390	55.45	-18.55	74	54.51	32.22	4.58	35.86	103	308	P	H
		2390	43.54	-10.46	54	42.6	32.22	4.58	35.86	103	308	A	H

1. Path Loss(dB) = Cable loss(dB) + Filter loss(dB) + Attenuator loss(dB)
2. Level(dBμV/m) =  
Antenna Factor(dB/m) + Path Loss(dB) + Read Level(dBμV) - Preamp Factor(dB)
3. Over Limit(dB) = Level(dBμV/m) – Limit Line(dBμV/m)

**For Peak Limit @ 2390MHz:**

1. Level(dBμV/m)  
= Antenna Factor(dB/m) + Path Loss(dB) + Read Level(dBμV) - Preamp Factor(dB)  
= 32.22(dB/m) + 4.58(dB) + 54.51(dBμV) – 35.86 (dB)  
= 55.45 (dBμV/m)
2. Over Limit(dB)  
= Level(dBμV/m) – Limit Line(dBμV/m)  
= 55.45(dBμV/m) – 74(dBμV/m)  
= -18.55(dB)

**For Average Limit @ 2390MHz:**

1. Level(dBμV/m)  
= Antenna Factor(dB/m) + Path Loss(dB) + Read Level(dBμV) - Preamp Factor(dB)  
= 32.22(dB/m) + 4.58(dB) + 42.6(dBμV) – 35.86 (dB)  
= 43.54 (dBμV/m)
2. Over Limit(dB)  
= Level(dBμV/m) – Limit Line(dBμV/m)  
= 43.54(dBμV/m) – 54(dBμV/m)  
= -10.46(dB)

Both peak and average measured complies with the limit line, so test result is “PASS”.





### Appendix C. Radiated Spurious Emission Plots

Test Engineer :	Bill Kuo, Fu Chen, Troye Hsieh	Temperature :	21.3~24.7°C
		Relative Humidity :	53.5~66.9%

Note symbol

-L	Low channel location
-R	High channel location

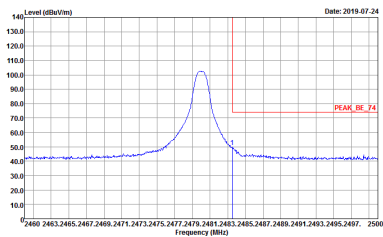
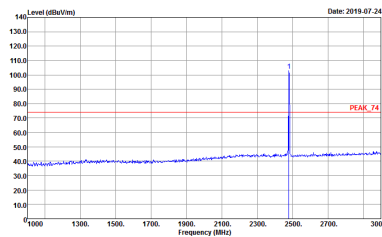

2.4GHz 2400~2483.5MHz  
BT 1Mbps (Band Edge @ 3m)

BT	2.4GHz 2400~2483.5MHz Band Edge @ 3m	
	BT CH78 2480MHz	
	Horizontal	Fundamental
Peak	 <p>Site : 03CH11-HY Condition : PEAK_BE_74 3m HORN 91200-HF HORIZONTAL Detector : Peak Project : 9701021-01 Mode : 1</p>	 <p>Site : 03CH11-HY Condition : PEAK_Z4 3m HORN 91200-HF HORIZONTAL Detector : Peak Project : 9701021-01 Mode : 1</p>

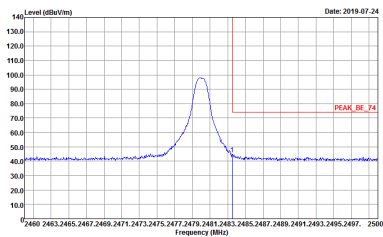
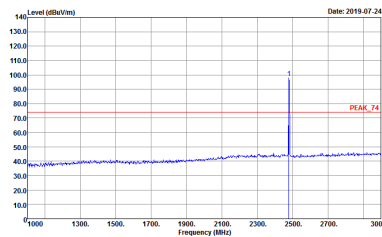

BT	2.4GHz 2400~2483.5MHz Band Edge @ 3m	
BT CH78 2480MHz		
Vertical		Fundamental
Peak	 <p>Site : 03CH11-1F Condition : PEAK_BE_74 3m HORN 91200-HF VERTICAL : RBW:1000.000KHz VBW:3000.000KHz SWT:Auto Detector : Peak Project : 9701021-01 Mode : 1</p>	 <p>Site : 03CH11-1F Condition : PEAK_74 3m HORN 91200-HF VERTICAL : RBW:1000.000KHz VBW:3000.000KHz SWT:Auto Detector : Peak Project : 9701021-01 Mode : 1</p>

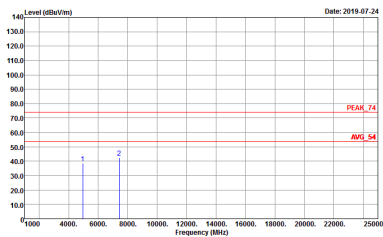
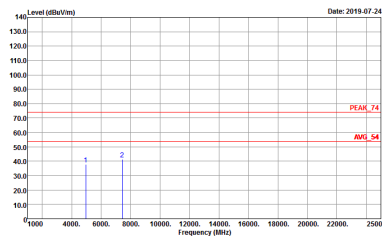

2.4GHz 2400~2483.5MHz  
BT 1Mbps (Harmonic @ 3m)

BT	2.4GHz 2400~2483.5MHz Harmonic @ 3m	
	BT CH78 2480MHz	
	Horizontal	Vertical
<p>Peak Avg.</p>	 <p>Site : 03CH11-HY Condition : PEAK_74 3m HORN 9120D-HF HORIZONTAL Detector : Peak Project : 971021-01</p>	 <p>Site : 03CH11-HY Condition : PEAK_74 3m HORN 9120D-HF VERTICAL Detector : Peak Project : 971021-01</p>



Emission below 1GHz

2.4GHz BT (LF)

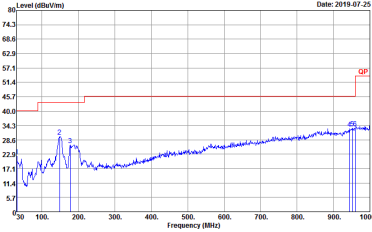
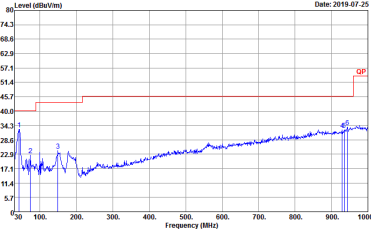
BT	2.4GHz 2400~2483.5MHz																																																																																																																																																																																											
BT LF																																																																																																																																																																																												
Horizontal		Vertical																																																																																																																																																																																										
<p>QP / Peak</p>	 <p>Site : 03CH11-HY            Condition : QP 3m BT-LOG 6111D-LF_ETC HORIZONTAL            Detector : Peak            Project : 971021-01</p> <table border="1"> <thead> <tr> <th>Peak</th> <th>Freq</th> <th>Level</th> <th>Limit</th> <th>ReadAntenna</th> <th>Cable</th> <th>Preamp</th> <th>A/Pos</th> <th>T/Pos</th> <th>Remark</th> </tr> <tr> <th></th> <th>MHz</th> <th>dBuV/m</th> <th>dB</th> <th>dBuV/m</th> <th>dBuV</th> <th>dB/m</th> <th>dB</th> <th>dB</th> <th>cm</th> <th>deg</th> </tr> </thead> <tbody> <tr><td>1</td><td>30.97</td><td>21.95</td><td>-18.85</td><td>48.00</td><td>29.96</td><td>23.58</td><td>0.77</td><td>32.37</td><td>---</td><td>---</td><td>Peak</td></tr> <tr><td>2</td><td>148.34</td><td>29.91</td><td>-13.59</td><td>43.50</td><td>43.69</td><td>16.95</td><td>1.59</td><td>32.28</td><td>---</td><td>---</td><td>Peak</td></tr> <tr><td>3</td><td>177.44</td><td>26.47</td><td>-17.03</td><td>43.50</td><td>41.92</td><td>14.93</td><td>1.77</td><td>32.26</td><td>---</td><td>---</td><td>Peak</td></tr> <tr><td>4</td><td>943.74</td><td>33.01</td><td>-12.99</td><td>46.00</td><td>29.47</td><td>30.19</td><td>4.11</td><td>30.95</td><td>---</td><td>---</td><td>Peak</td></tr> <tr><td>5</td><td>951.58</td><td>33.14</td><td>-12.86</td><td>46.00</td><td>29.07</td><td>30.64</td><td>4.12</td><td>30.88</td><td>---</td><td>---</td><td>Peak</td></tr> <tr><td>6</td><td>959.26</td><td>33.20</td><td>-12.80</td><td>46.00</td><td>28.69</td><td>30.97</td><td>4.14</td><td>30.80</td><td>100</td><td>0</td><td>Peak</td></tr> </tbody> </table>	Peak	Freq	Level	Limit	ReadAntenna	Cable	Preamp	A/Pos	T/Pos	Remark		MHz	dBuV/m	dB	dBuV/m	dBuV	dB/m	dB	dB	cm	deg	1	30.97	21.95	-18.85	48.00	29.96	23.58	0.77	32.37	---	---	Peak	2	148.34	29.91	-13.59	43.50	43.69	16.95	1.59	32.28	---	---	Peak	3	177.44	26.47	-17.03	43.50	41.92	14.93	1.77	32.26	---	---	Peak	4	943.74	33.01	-12.99	46.00	29.47	30.19	4.11	30.95	---	---	Peak	5	951.58	33.14	-12.86	46.00	29.07	30.64	4.12	30.88	---	---	Peak	6	959.26	33.20	-12.80	46.00	28.69	30.97	4.14	30.80	100	0	Peak	 <p>Site : 03CH11-HY            Condition : QP 3m BT-LOG 6111D-LF_ETC VERTICAL            Detector : Peak            Project : 971021-01</p> <table border="1"> <thead> <tr> <th>Peak</th> <th>Freq</th> <th>Level</th> <th>Limit</th> <th>ReadAntenna</th> <th>Cable</th> <th>Preamp</th> <th>A/Pos</th> <th>T/Pos</th> <th>Remark</th> </tr> <tr> <th></th> <th>MHz</th> <th>dBuV/m</th> <th>dB</th> <th>dBuV/m</th> <th>dBuV</th> <th>dB/m</th> <th>dB</th> <th>dB</th> <th>cm</th> <th>deg</th> </tr> </thead> <tbody> <tr><td>1</td><td>42.61</td><td>32.82</td><td>-7.18</td><td>48.00</td><td>46.57</td><td>17.75</td><td>0.86</td><td>32.37</td><td>100</td><td>0</td><td>Peak</td></tr> <tr><td>2</td><td>73.65</td><td>22.56</td><td>-17.44</td><td>48.00</td><td>41.33</td><td>12.40</td><td>1.13</td><td>32.35</td><td>---</td><td>---</td><td>Peak</td></tr> <tr><td>3</td><td>149.31</td><td>24.25</td><td>-19.25</td><td>43.50</td><td>37.97</td><td>16.91</td><td>1.60</td><td>32.28</td><td>---</td><td>---</td><td>Peak</td></tr> <tr><td>4</td><td>929.19</td><td>32.43</td><td>-13.57</td><td>46.00</td><td>29.81</td><td>29.44</td><td>4.08</td><td>31.08</td><td>---</td><td>---</td><td>Peak</td></tr> <tr><td>5</td><td>935.01</td><td>32.50</td><td>-13.50</td><td>46.00</td><td>29.55</td><td>29.71</td><td>4.09</td><td>31.03</td><td>---</td><td>---</td><td>Peak</td></tr> <tr><td>6</td><td>943.74</td><td>33.73</td><td>-12.27</td><td>46.00</td><td>30.19</td><td>30.19</td><td>4.11</td><td>30.95</td><td>---</td><td>---</td><td>Peak</td></tr> </tbody> </table>	Peak	Freq	Level	Limit	ReadAntenna	Cable	Preamp	A/Pos	T/Pos	Remark		MHz	dBuV/m	dB	dBuV/m	dBuV	dB/m	dB	dB	cm	deg	1	42.61	32.82	-7.18	48.00	46.57	17.75	0.86	32.37	100	0	Peak	2	73.65	22.56	-17.44	48.00	41.33	12.40	1.13	32.35	---	---	Peak	3	149.31	24.25	-19.25	43.50	37.97	16.91	1.60	32.28	---	---	Peak	4	929.19	32.43	-13.57	46.00	29.81	29.44	4.08	31.08	---	---	Peak	5	935.01	32.50	-13.50	46.00	29.55	29.71	4.09	31.03	---	---	Peak	6	943.74	33.73	-12.27	46.00	30.19	30.19	4.11	30.95	---	---	Peak
	Peak	Freq	Level	Limit	ReadAntenna	Cable	Preamp	A/Pos	T/Pos	Remark																																																																																																																																																																																		
	MHz	dBuV/m	dB	dBuV/m	dBuV	dB/m	dB	dB	cm	deg																																																																																																																																																																																		
1	30.97	21.95	-18.85	48.00	29.96	23.58	0.77	32.37	---	---	Peak																																																																																																																																																																																	
2	148.34	29.91	-13.59	43.50	43.69	16.95	1.59	32.28	---	---	Peak																																																																																																																																																																																	
3	177.44	26.47	-17.03	43.50	41.92	14.93	1.77	32.26	---	---	Peak																																																																																																																																																																																	
4	943.74	33.01	-12.99	46.00	29.47	30.19	4.11	30.95	---	---	Peak																																																																																																																																																																																	
5	951.58	33.14	-12.86	46.00	29.07	30.64	4.12	30.88	---	---	Peak																																																																																																																																																																																	
6	959.26	33.20	-12.80	46.00	28.69	30.97	4.14	30.80	100	0	Peak																																																																																																																																																																																	
Peak	Freq	Level	Limit	ReadAntenna	Cable	Preamp	A/Pos	T/Pos	Remark																																																																																																																																																																																			
	MHz	dBuV/m	dB	dBuV/m	dBuV	dB/m	dB	dB	cm	deg																																																																																																																																																																																		
1	42.61	32.82	-7.18	48.00	46.57	17.75	0.86	32.37	100	0	Peak																																																																																																																																																																																	
2	73.65	22.56	-17.44	48.00	41.33	12.40	1.13	32.35	---	---	Peak																																																																																																																																																																																	
3	149.31	24.25	-19.25	43.50	37.97	16.91	1.60	32.28	---	---	Peak																																																																																																																																																																																	
4	929.19	32.43	-13.57	46.00	29.81	29.44	4.08	31.08	---	---	Peak																																																																																																																																																																																	
5	935.01	32.50	-13.50	46.00	29.55	29.71	4.09	31.03	---	---	Peak																																																																																																																																																																																	
6	943.74	33.73	-12.27	46.00	30.19	30.19	4.11	30.95	---	---	Peak																																																																																																																																																																																	



## Appendix D. Duty Cycle Plots

<1Mbps>

DH5 on time (One Pulse) Plot on Channel 39

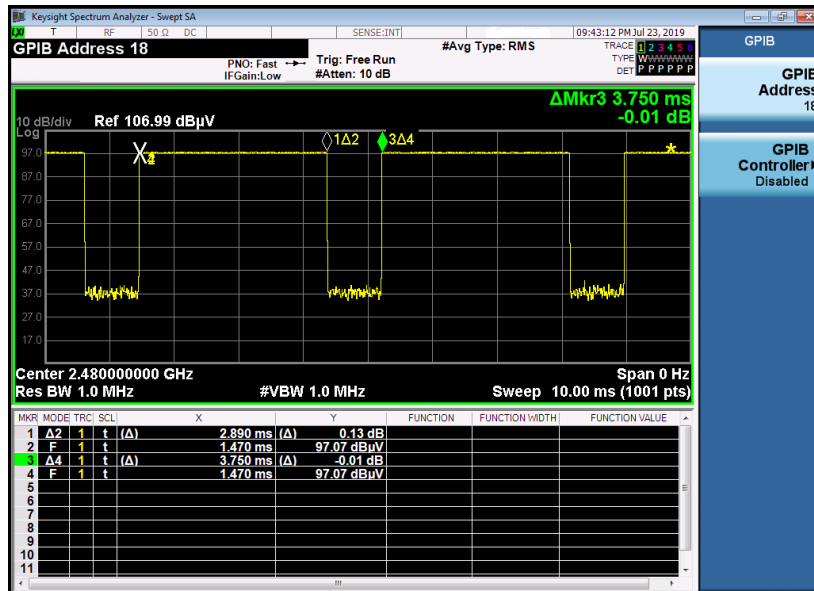

on time (Count Pulses) Plot on Channel 39

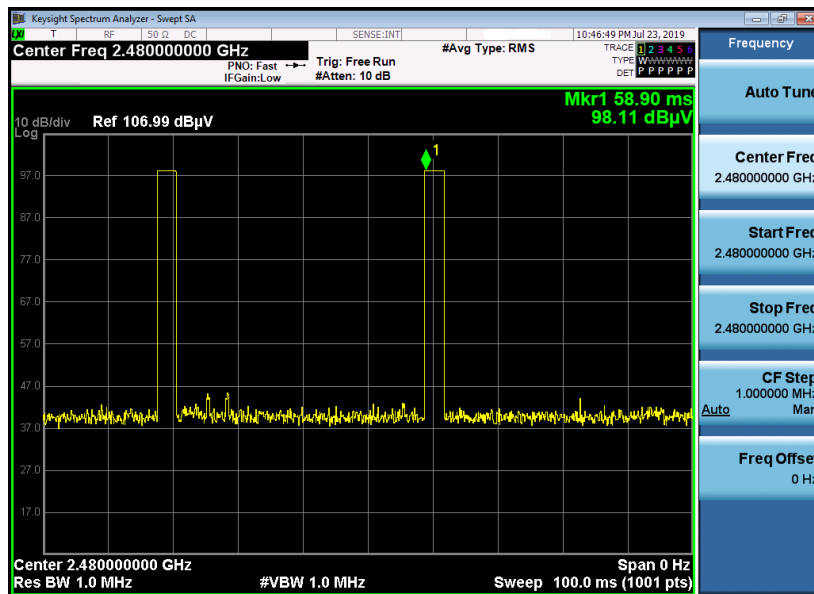

**Note:**

1. Worst case Duty cycle = on time/100 milliseconds = 2 \* 2.89 / 100 = 5.78 %
2. Worst case Duty cycle correction factor = 20\*log(Duty cycle) = -24.76 dB
3. DH5 has the highest duty cycle worst case and is reported.



**Duty Cycle Correction Factor Consideration for AFH mode:**

Bluetooth normal hopping rate is 1600Hz and reduced to 800Hz in AFH mode; due to the reduced number of hopping frequencies, with the same packet configuration the dwell time in each channel frequency within 100msec period is longer in AFH mode than normal mode.

In AFH mode, the minimum hopping frequencies are 20, to get the longest dwell time DH5 packet is observed; the period to have DH5 packet completing one hopping sequence is

$$2.89 \text{ ms} \times 20 \text{ channels} = 57.8 \text{ ms}$$

There cannot be 2 complete hopping sequences within 100ms period, considering the random hopping behavior, maximum 2 hops can be possibly observed within the period.  $[100\text{ms} / 57.6\text{ms}] = 2 \text{ hops}$

Thus, the maximum possible ON time:

$$2.89 \text{ ms} \times 2 = 5.78 \text{ ms}$$

Worst case Duty Cycle Correction factor, which is derived from the maximum possible ON time,

$$20 \times \log(5.78 \text{ ms}/100\text{ms}) = -24.76 \text{ dB}$$

—————THE END—————