



FCC RADIO TEST REPORT

FCC ID : PY7-48130K
Equipment : GSM/WCDMA/LTE Phone with BT, DTS/UNII
a/b/g/n/ac, GPS and NFC
Brand Name : Sony
Applicant : Sony Mobile Communications Inc.
4-12-3 Higashi-Shinagawa, Shinagawa-ku,
Tokyo, 140-0002, Japan
Manufacturer : Sony Mobile Communications Inc.
4-12-3 Higashi-Shinagawa, Shinagawa-ku,
Tokyo, 140-0002, Japan
Standard : FCC Part 15 Subpart E §15.407

The product was received on Nov. 01, 2018 and testing was started from Apr. 16, 2019 and completed on Apr. 26, 2019. We, SPORTON INTERNATIONAL INC. EMC & Wireless Communications Laboratory, would like to declare that the tested sample has been evaluated in accordance with the test procedures and has been in compliance with the applicable technical standards.

The report must not be used by the client to claim product certification, approval, or endorsement by TAF or any agency of government.

The test results in this variant report apply exclusively to the tested model / sample. Without written approval of SPORTON INTERNATIONAL INC. EMC & Wireless Communications Laboratory, the test report shall not be reproduced except in full.

Approved by: Jones Tsai

SPORTON INTERNATIONAL INC. EMC & Wireless Communications Laboratory

No. 52, Huaya 1st Rd., Guishan Dist., Taoyuan City, Taiwan (R.O.C.)



Table of Contents

History of this test report..... 3

Summary of Test Result..... 4

1 General Description 5

 1.1 Product Feature of Equipment Under Test..... 5

 1.2 Modification of EUT 5

 1.3 Testing Location 6

 1.4 Applicable Standards..... 6

2 Test Configuration of Equipment Under Test 7

 2.1 Carrier Frequency and Channel 7

 2.2 Test Mode..... 8

 2.3 Connection Diagram of Test System..... 8

 2.4 EUT Operation Test Setup 8

3 Test Result 9

 3.1 Maximum Conducted Output Power Measurement 9

 3.2 Unwanted Emissions Measurement 10

 3.3 Antenna Requirements..... 15

4 List of Measuring Equipment..... 16

5 Uncertainty of Evaluation 18

Appendix A. Conducted Test Results

Appendix B. Radiated Spurious Emission

Appendix C. Radiated Spurious Emission Plots

Appendix D. Duty Cycle Plots



History of this test report

Report No.	Version	Description	Issued Date
FR8O2421-03F	01	Initial issue of report	Apr. 30, 2019
FR8O2421-03F	02	Add the description of accessing spot check test plan in Summary of Test Result	May 15, 2019



Summary of Test Result

Report Clause	Ref Std. Clause	Test Items	Result (PASS/FAIL)	Remark
-	15.403 (i)	6dB & 26dB Bandwidth	Not Required	-
-	2.1049	99% Occupied Bandwidth	Not Required	-
3.1	15.407 (a)	Maximum Conducted Output Power	Pass	-
-	15.407 (a)	Power Spectral Density	Not Required	-
3.2	15.407(b)	Unwanted Emissions	Pass	Under limit 6.52 dB at 43.580 MHz
-	15.207	AC Conducted Emission	Not Required	-
-	15.407 (c)	Automatically Discontinue Transmission	Not Required	-
3.3	15.203 & 15.407 (a)	Antenna Requirement	Pass	-

Remark:

- Not required means after assessing, test items are not necessary to carry out.
- This is a variant report. All the test cases were performed on original report which can be referred to Sporton Report Number FR802417-03F.
- The spot-check data performed in this report are chosen from the worst case of the original FCC ID report and the spot-check data summary is included in the another spot check data report.

Declaration of Conformity:
The test results with all measurement uncertainty excluded are presented in accordance with the regulation limits or requirements declared by manufacturers.

Comments and Explanations:
The declared of product specification for EUT presented in the report are provided by the manufacturer, and the manufacturer takes all the responsibilities for the accuracy of product specification.

Reviewed by: Wii Chang

Report Producer: Natasha Hsieh



1 General Description

1.1 Product Feature of Equipment Under Test

GSM/WCDMA/LTE, Bluetooth, DTS/UNII a/b/g/n/ac, NFC, and GNSS.

Standards-related Product Specification	
Antenna Type / Gain	<Ant. 1>: Loop Antenna with gain -5.9 dBi <Ant. 2>: Monopole Antenna with gain 1.2 dBi

EUT Information List			
HW Version	SW Version	S/N	Performed Test Item
A	2.37	QV71006R1S	RF conducted measurement
		QV71002F1S	Radiated Spurious Emission

Accessory List	
AC Adapter	Model Name : UCH32
	S/N : 6218W30200106
Earphone	Model Name.: MH750
	S/N : N/A
USB Cable	Model Name.: UCB24
	S/N : N/A
2 in 1 USB Audio Cable	Model Name: EC270
	S/N : N/A

Note:

1. Above EUT list used are electrically identical per declared by manufacturer.
2. Above the accessories list are used to exercise the EUT during test, and the serial number of each type of accessories is listed in each section of this report. .
3. For other wireless features of this EUT, test report will be issued separately.

1.2 Modification of EUT

No modifications are made to the EUT during all test items.



1.3 Testing Location

Test Site	SPORTON INTERNATIONAL INC.
Test Site Location	No.58, Aly. 75, Ln. 564, Wenhua 3rd, Rd., Guishan Dist., Taoyuan City, Taiwan (R.O.C.) TEL: +886-3-327-0868 FAX: +886-3-327-0855
Test Site No.	Sporton Site No. 03CH12-HY

Note: The test site complies with ANSI C63.4 2014 requirement.

FCC Designation No.: TW0007

1.4 Applicable Standards

According to the specifications of the manufacturer, the EUT must comply with the requirements of the following standards:

- ♦ FCC Part 15 Subpart E
- ♦ FCC KDB 789033 D02 General UNII Test Procedures New Rules v02r01.
- ♦ FCC KDB 414788 D01 Radiated Test Site v01r01.
- ♦ FCC KDB 662911 D01 Multiple Transmitter Output v02r01.
- ♦ ANSI C63.10-2013

Remark:

1. All test items were verified and recorded according to the standards and without any deviation during the test.
2. This EUT has also been tested and complied with the requirements of FCC Part 15, Subpart B, recorded in a separate test report.



2 Test Configuration of Equipment Under Test

- a. The EUT has been associated with peripherals and configuration operated in a manner tended to maximize its emission characteristics in a typical application. Frequency range investigated: radiation emission (9 kHz to the 10th harmonic of the highest fundamental frequency or to 40 GHz, whichever is lower). For radiated measurement, pre-scanned in three orthogonal panels, X, Y, Z. The worst cases (Z plane) were recorded in this report.

2.1 Carrier Frequency and Channel

Frequency Band	Channel	Freq. (MHz)	Channel	Freq. (MHz)
5725-5850 MHz Band 4 (U-NII-3)	149	5745	157	5785
	151*	5755	159*	5795
	153	5765	161	5805
	155#	5775	165	5825

Note:

- 1. The above Frequency and Channel in "*" were 802.11n HT40 and 802.11ac VHT40.
- 2. The above Frequency and Channel in "#n" were 802.11ac VHT80.

2.2 Test Mode

Final test modes are considering the modulation and worse data rates as below table.

Modulation	Data Rate
802.11n HT40	MCS0

Ch. #		Band IV : 5725-5850 MHz
		802.11ac VHT80
L	Low	-
M	Middle	-
H	High	155

2.3 Connection Diagram of Test System

<WLAN Tx Mode>

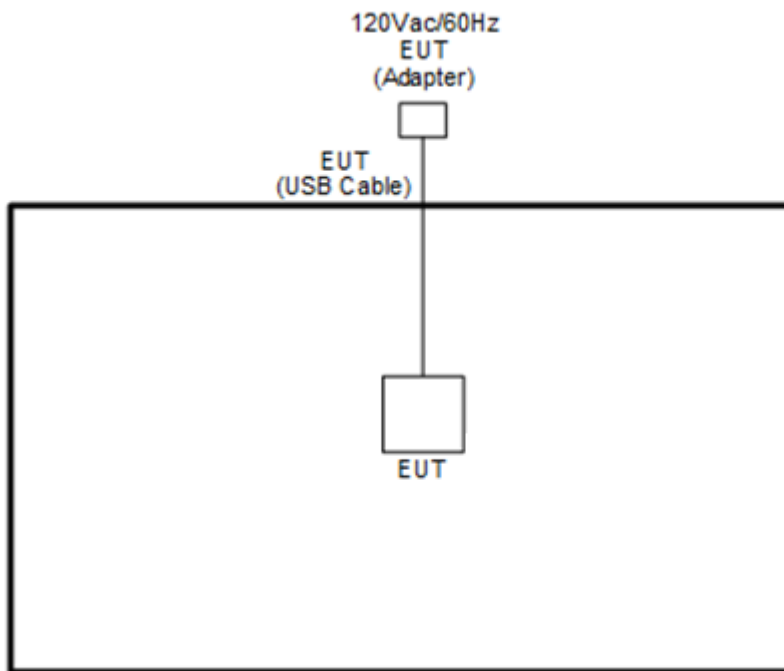

2.4 EUT Operation Test Setup

The RF test items, utility “Tera Term” was installed in Notebook which was programmed in order to make the EUT get into the engineering modes to provide channel selection, power level, data rate and the application type and for continuous transmitting signals.

3 Test Result

3.1 Maximum Conducted Output Power Measurement

3.1.1 Limit of Maximum Conducted Output Power

For the band 5.725–5.85 GHz, the maximum conducted output power over the frequency band of operation shall not exceed 1 W.

If transmitting antennas of directional gain greater than 6 dBi are used, the peak output power shall be reduced by the amount in dB that the directional gain of the antenna exceeds 6 dBi.

3.1.2 Measuring Instruments

See list of measuring equipment of this test report.

3.1.3 Test Procedures

The testing follows Method PM-G of FCC KDB 789033 D02 General UNII Test Procedures New Rules v02r01 for TXBF modes.

Method PM-G (Measurement using a gated RF average power meter):

1. Measurement is performed using a wideband RF power meter.
2. The EUT is configured to transmit at its maximum power control level.
3. Measure the average power of the transmitter
4. Since the measurement is made only during the ON time of the transmitter, no duty cycle correction factor is required.

3.1.4 Test Setup

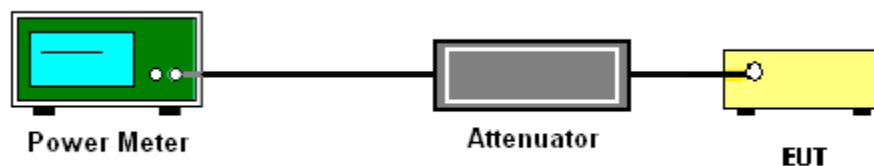

3.1.5 Test Result of Maximum Conducted Output Power

Please refer to Appendix A.



3.2 Unwanted Emissions Measurement

This section is to measure unwanted emissions through radiated measurement for band edge spurious emissions and out of band emissions measurement.

3.2.1 Limit of Unwanted Emissions

- (1) For transmitters operating in the 5.725-5.85 GHz band:
 15.407(b)(4)(i) All emissions shall be limited to a level of -27 dBm/MHz at 75 MHz or more above or below the band edge increasing linearly to 10 dBm/MHz at 25 MHz above or below the band edge, and from 25 MHz above or below the band edge increasing linearly to a level of 15.6 dBm/MHz at 5 MHz above or below the band edge, and from 5 MHz above or below the band edge increasing linearly to a level of 27 dBm/MHz at the band edge.
- (2) Unwanted spurious emissions fallen in restricted bands shall comply with the general field strength limits as below table,

Frequency (MHz)	Field Strength (microvolts/meter)	Measurement Distance (meters)
0.009 – 0.490	2400/F(kHz)	300
0.490 – 1.705	24000/F(kHz)	30
1.705 – 30.0	30	30
30 – 88	100	3
88 – 216	150	3
216 - 960	200	3
Above 960	500	3

Note: The following formula is used to convert the EIRP to field strength.

$$E = \frac{1000000\sqrt{30P}}{3} \text{ } \mu\text{V/m, where P is the eirp (Watts)}$$



EIRP (dBm)	Field Strength at 3m (dBµV/m)
- 27	68.3

(3) KDB789033 D02 v02r01 G)2)c)

- (i) Section 15.407(b)(1) to (b)(3) specify the unwanted emission limits for the U-NII-1 and U-NII-2 bands. As specified, emissions above 1000 MHz that are outside of the restricted bands are subject to a peak emission limit of -27 dBm/MHz.³
- (ii) Section 15.407(b)(4) specifies the unwanted emission limit for the U-NII-3 band. A band emissions mask is specified in Section 15.407(b)(4)(i). The emission limits are in terms of a Peak detector. An alternative to the band emissions mask is specified in Section 15.407(b)(4)(ii). The alternative limits are based on the highest antenna gain specified in the filing. There are also marketing and importation restrictions for the devices using the alternative limit.⁴

Note 3: An out-of-band emission that complies with both the average and peak limits of Section 15.209 is not required to satisfy the -27 dBm/MHz peak emission limit.

Note 4: Only devices with antenna gains of 10 dBi or less may be approved using the emission limits specified in Section 15.247(d) till March 2, 2018; all other devices operating in this band must use the mask specified in Section 15.407(b)(4)(i).

3.2.2 Measuring Instruments

See list of measuring equipment of this test report.

3.2.3 Test Procedures

1. The testing follows FCC KDB 789033 D02 General UNII Test Procedures New Rules v02r01. Section G) Unwanted emissions measurement.
 - (1) Procedure for Unwanted Emissions Measurements Below 1000MHz
 - RBW = 120 kHz
 - VBW = 300 kHz
 - Detector = Peak
 - Trace mode = max hold
 - (2) Procedure for Peak Unwanted Emissions Measurements Above 1000 MHz
 - RBW = 1 MHz
 - VBW ≥ 3 MHz
 - Detector = Peak
 - Sweep time = auto
 - Trace mode = max hold



(3) Procedures for Average Unwanted Emissions Measurements Above 1000MHz

- RBW = 1 MHz
 - VBW = 10 Hz, when duty cycle is no less than 98 percent.
 - $VBW \geq 1/T$, when duty cycle is less than 98 percent where T is the minimum transmission duration over which the transmitter is on and is transmitting at its maximum power control level for the tested mode of operation.
2. The EUT was placed on a turntable with 0.8 meter for frequency below 1GHz and 1.5 meter for frequency above 1GHz respectively above ground.
 3. The EUT was set 3 meters from the interference receiving antenna which was mounted on the top of a variable height antenna tower.
 4. The antenna is a broadband antenna and its height is adjusted between one meter and four meters above ground to find the maximum value of the field strength for both horizontal polarization and vertical polarization of the antenna.
 5. For each suspected emission, the EUT was arranged to its worst case and then adjust the antenna tower (from 1 m to 4 m) and turntable (from 0 degree to 360 degrees) to find the maximum reading.
 6. For testing below 1GHz, if the emission level of the EUT in peak mode was 3 dB lower than the limit specified, then peak values of EUT will be reported, otherwise, the emissions will be repeated one by one using the CISPR quasi-peak method and reported.
 7. For testing above 1GHz, the emission level of the EUT in peak mode was 20dB lower than average limit (that means the emission level in average mode also complies with the limit in average mode), then peak values of EUT will be reported, otherwise, the emissions will be measured in average mode again and reported.

3.2.4 Test Setup

For radiated emissions below 30MHz

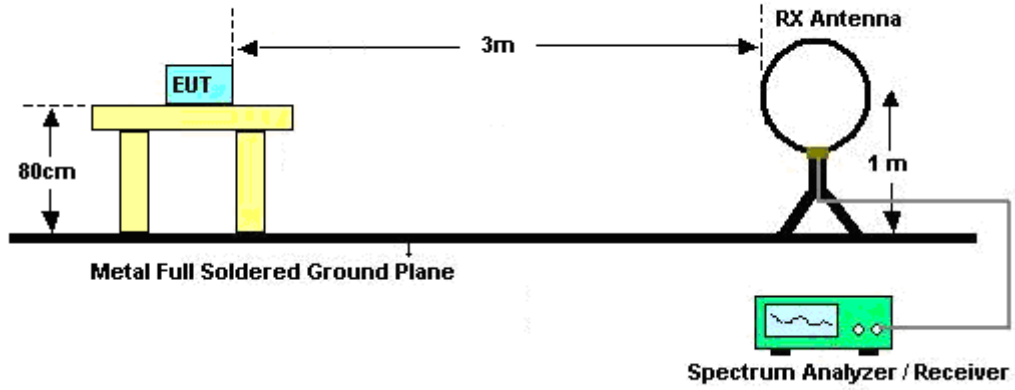

For radiated emissions from 30MHz to 1GHz

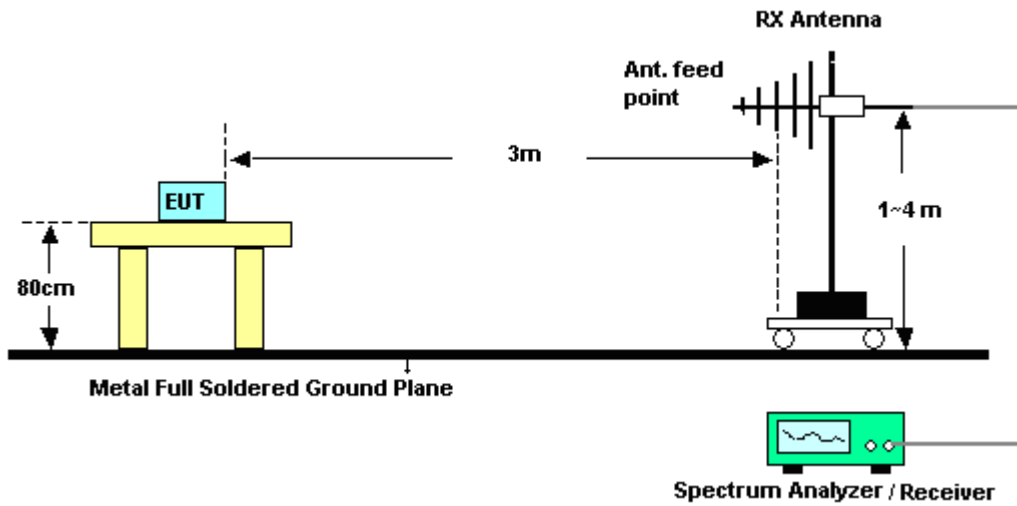

For radiated emissions above 1GHz

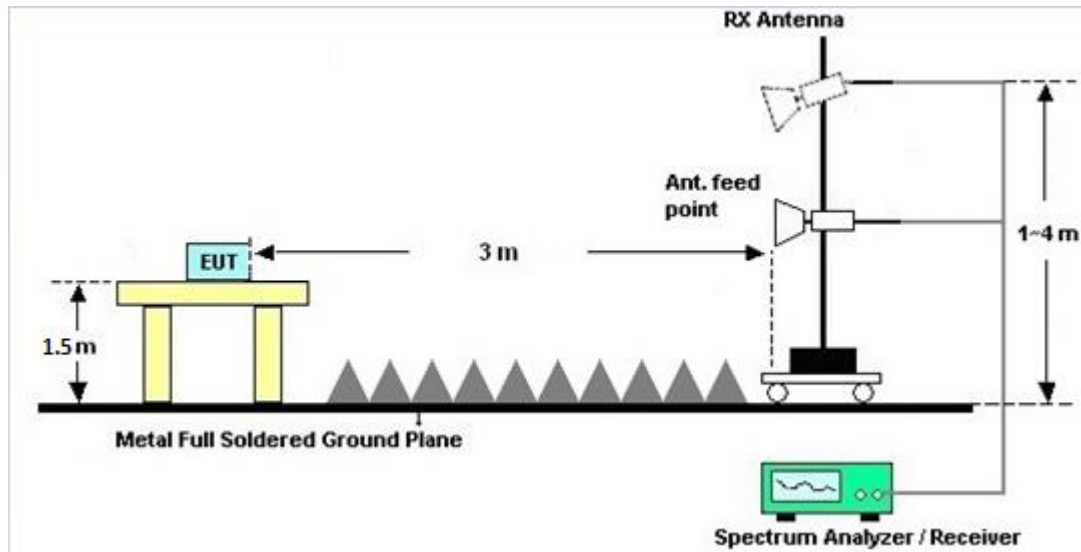

3.2.5 Test Results of Radiated Emissions (9 kHz ~ 30 MHz)

The low frequency, which started from 9 kHz to 30MHz, was pre-scanned and the result which was 20dB lower than the limit line was not reported.

There is a comparison data of both open-field test site and alternative test site - semi-Anechoic chamber according to 414788 D01 Radiated Test Site v01r01, and the result came out very similar.

3.2.6 Test Result of Radiated Band Edges

Please refer to Appendix B and C.

3.2.7 Duty Cycle

Please refer to Appendix D.

3.2.8 Test Result of Unwanted Radiated Emission (30MHz ~ 10th Harmonic)

Please refer to Appendix B and C.



3.3 Antenna Requirements

3.3.1 Standard Applicable

If transmitting antenna directional gain is greater than 6 dBi, both the peak transmit power and the peak power spectral density shall be reduced by the amount in dB that the directional gain of the antenna exceeds 6 dBi.

3.3.2 Antenna Anti-Replacement Construction

An embedded-in antenna design is used.

3.3.3 Antenna Gain

<CDD Modes >

FCC KDB 662911 D01 Multiple Transmitter Output v02r01

For CDD transmissions, directional gain is calculated as

Directional gain = GANT + Array Gain, where Array Gain is as follows.

For power spectral density (PSD) measurements on all devices,

Array Gain = 10 log(NANT/NSS=1) dB.

For power measurements on IEEE 802.11 devices,

Array Gain = 0 dB (i.e., no array gain) for NANT ≤ 4.

Directional gain may be calculated by using the formulas applicable to equal gain antennas with GANT set equal to the gain of the antenna having the highest gain;

The EUT supports CDD mode.

For power, the directional gain G_{ANT} is set equal to the antenna having the highest gain, i.e., F)2)f)i).

For PSD, the directional gain calculation is following F)2)f)ii) of KDB 662911 D01 v02r01.

The power and PSD limit should be modified if the directional gain of EUT is over 6 dBi,

The directional gain "DG" is calculated as following table.

<CDD Modes>						
			DG	DG	Power	PSD
			for	for	Limit	Limit
	Ant. 1	Ant. 2	Power	PSD	Reduction	Reduction
	(dBi)	(dBi)	(dBi)	(dBi)	(dB)	(dB)
Band IV	-5.90	1.20	1.20	1.37	0.00	0.00

$Power\ Limit\ Reduction = DG(Power) - 6dBi, (min = 0)$

$PSD\ Limit\ Reduction = DG(PSD) - 6dBi, (min = 0)$



4 List of Measuring Equipment

Instrument	Manufacturer	Model No.	Serial No.	Characteristics	Calibration Date	Test Date	Due Date	Remark
Hygrometer	Testo	HTC-1	4	N/A	May 12, 2018	Apr. 16, 2019	May 11, 2019	Conducted (TH05-HY)
Power Sensor	DARE	RPR3006W	15100041SN O10	10MHz~6GHz	May 07, 2018	Apr. 16, 2019	May 06, 2019	Conducted (TH05-HY)
Switch Box & RF Cable	Burgeon	ETF-058	EC1300484	N/A	Feb. 28, 2019	Apr. 16, 2019	Feb. 27, 2020	Conducted (TH05-HY)
Programmable Power Supply	GW Instek	PSS-2005	EL890094	1V~20V 0.5A~5A	Oct. 02, 2018	Apr. 16, 2019	Oct. 01, 2019	Conducted (TH05-HY)
Loop Antenna	Rohde & Schwarz	HFH2-Z2	100488	9 kHz~30 MHz	Jan. 07, 2019	Apr. 20, 2019~ Apr. 26, 2019	Jan. 06, 2020	Radiation (03CH12-HY)
Bilog Antenna	TESEQ	CBL 6111D&00800 N1D01N-06	37059&01	30MHz~1GHz	Oct. 13, 2018	Apr. 20, 2019~ Apr. 26, 2019	Oct. 12, 2019	Radiation (03CH12-HY)
Horn Antenna	SCHWARZBECK	BBHA 9120D	9120D-1328	1GHz ~ 18GHz	Oct. 19, 2018	Apr. 20, 2019~ Apr. 26, 2019	Oct. 18, 2019	Radiation (03CH12-HY)
SHF-EHF Horn Antenna	SCHWARZBECK	BBHA 9170	BBHA917057 6	18GHz ~ 40GHz	May 08, 2018	Apr. 20, 2019~ Apr. 26, 2019	May 07, 2019	Radiation (03CH12-HY)
Preamplifier	SONOMA	310N	187312	9kHz~1GHz	Dec. 04, 2018	Apr. 20, 2019~ Apr. 26, 2019	Dec. 03, 2019	Radiation (03CH12-HY)
Preamplifier	Agilent	8449B	3008A02375	1GHz~26.5GHz	May 28, 2018	Apr. 20, 2019~ Apr. 26, 2019	May 27, 2019	Radiation (03CH12-HY)
Preamplifier	Jet-Power	JPA0118-55-3 03	1710001800 055007	1GHz~18GHz	Apr. 01, 2019	Apr. 20, 2019~ Apr. 26, 2019	Mar. 31, 2020	Radiation (03CH12-HY)
Preamplifier	MITEQ	TTA1840-35-H G	1864481	18GHz ~ 40GHz	Aug. 24, 2018	Apr. 20, 2019~ Apr. 26, 2019	Aug. 23, 2019	Radiation (03CH12-HY)
EMI Test Receiver	Rohde & Schwarz	FSV30	103738	9kHz~30GHz	May 22, 2018	Apr. 20, 2019~ Apr. 26, 2019	May 21, 2019	Radiation (03CH12-HY)
Hygrometer	TECPEL	DTM-303B	TP161243	N/A	May 12, 2018	Apr. 20, 2019~ Apr. 26, 2019	May 11, 2019	Radiation (03CH12-HY)
Filter	Wainwright	WLK4-1000-15 30-8000-40SS	SN12	1GHz Low Pass	Sep. 17, 2018	Apr. 20, 2019~ Apr. 26, 2019	Sep. 16, 2019	Radiation (03CH12-HY)
Filter	Wainwright	WHKX8-5872. 5-6750-18000- 40ST	SN3	6.75GHz High Pass	Sep. 17, 2018	Apr. 20, 2019~ Apr. 26, 2019	Sep. 16, 2019	Radiation (03CH12-HY)
Filter	Wainwright	WHKX12-2700 -3000-18000-6 0ST	SN2	3GHz High Pass	Sep. 17, 2018	Apr. 20, 2019~ Apr. 26, 2019	Sep. 16, 2019	Radiation (03CH12-HY)
RF Cable	HUBER + SUHNER	SUCOFLEX 126E	0058/126E	30M-18G	Mar. 13, 2019	Apr. 20, 2019~ Apr. 26, 2019	Mar. 12, 2020	Radiation (03CH12-HY)
RF Cable	HUBER + SUHNER	SUCOFLEX 102	505134/2	30M~40GHz	Oct. 16, 2018	Apr. 20, 2019~ Apr. 26, 2019	Oct. 15, 2019	Radiation (03CH12-HY)
RF Cable	HUBER + SUHNER	SUCOFLEX 102	800740/2	30M~40GHz	Oct. 16, 2018	Apr. 20, 2019~ Apr. 26, 2019	Oct. 15, 2019	Radiation (03CH12-HY)



Instrument	Manufacturer	Model No.	Serial No.	Characteristics	Calibration Date	Test Date	Due Date	Remark
Controller	EMEC	EM1000	N/A	Control Turn table & Ant Mast	N/A	Apr. 20, 2019~ Apr. 26, 2019	N/A	Radiation (03CH12-HY)
Antenna Mast	EMEC	AM-BS-4500-B	N/A	1m~4m	N/A	Apr. 20, 2019~ Apr. 26, 2019	N/A	Radiation (03CH12-HY)
Turn Table	EMEC	TT2000	N/A	0~360 Degree	N/A	Apr. 20, 2019~ Apr. 26, 2019	N/A	Radiation (03CH12-HY)
Software	Audix	E3 6.2009-8-24	RK-000989	N/A	N/A	Apr. 20, 2019~ Apr. 26, 2019	N/A	Radiation (03CH12-HY)



5 Uncertainty of Evaluation

Uncertainty of Radiated Emission Measurement (30 MHz ~ 1000 MHz)

Measuring Uncertainty for a Level of Confidence of 95% ($U = 2Uc(y)$)	5.10
---	------

Uncertainty of Radiated Emission Measurement (1000 MHz ~ 18000 MHz)

Measuring Uncertainty for a Level of Confidence of 95% ($U = 2Uc(y)$)	5.20
---	------

Uncertainty of Radiated Emission Measurement (18000 MHz ~ 40000 MHz)

Measuring Uncertainty for a Level of Confidence of 95% ($U = 2Uc(y)$)	4.70
---	------

Appendix A. Test Result of Conducted Test Items

Test Engineer:	Richard Qiu	Temperature:	21~25	°C
Test Date:	2019/4/16	Relative Humidity:	51~54	%

TEST RESULTS DATA
Average Power Table

Band IV												
Mod.	Data Rate	NTX	CH.	Freq. (MHz)	Average Conducted Power (dBm)			FCC Conducted Power Limit (dBm)		DG (dBi)		Pass/Fail
					Ant 1	Ant 2	SUM	Ant 1	Ant 2	Ant 1	Ant 2	
11a	6Mbps	1	149	5745	13.50	11.50		30.00	30.00	-5.90	1.20	Pass
11a	6Mbps	1	157	5785	13.60	11.50		30.00	30.00	-5.90	1.20	Pass
11a	6Mbps	1	165	5825	13.50	11.70		30.00	30.00	-5.90	1.20	Pass
HT20	MCS0	1	149	5745	13.50	11.70		30.00	30.00	-5.90	1.20	Pass
HT20	MCS0	1	157	5785	13.60	11.60		30.00	30.00	-5.90	1.20	Pass
HT20	MCS0	1	165	5825	13.60	11.70		30.00	30.00	-5.90	1.20	Pass
HT40	MCS0	1	151	5755	13.50	11.40		30.00	30.00	-5.90	1.20	Pass
HT40	MCS0	1	159	5795	13.60	11.60		30.00	30.00	-5.90	1.20	Pass
VHT20	MCS0	1	149	5745	13.50	11.60		30.00	30.00	-5.90	1.20	Pass
VHT20	MCS0	1	157	5785	13.30	11.50		30.00	30.00	-5.90	1.20	Pass
VHT20	MCS0	1	165	5825	13.40	11.60		30.00	30.00	-5.90	1.20	Pass
VHT40	MCS0	1	151	5755	13.40	11.30		30.00	30.00	-5.90	1.20	Pass
VHT40	MCS0	1	159	5795	13.30	11.50		30.00	30.00	-5.90	1.20	Pass
VHT80	MCS0	1	155	5775	13.30	11.40		30.00	30.00	-5.90	1.20	Pass
11a	6Mbps	2	149	5745	13.70	11.20	15.64	30.00		1.20		Pass
11a	6Mbps	2	157	5785	13.70	11.70	15.82	30.00		1.20		Pass
11a	6Mbps	2	165	5825	13.50	11.70	15.70	30.00		1.20		Pass
HT20	MCS0	2	149	5745	13.70	11.20	15.64	30.00		1.20		Pass
HT20	MCS0	2	157	5785	13.70	11.70	15.82	30.00		1.20		Pass
HT20	MCS0	2	165	5825	13.70	11.70	15.82	30.00		1.20		Pass
HT40	MCS0	2	151	5755	13.70	11.20	15.64	30.00		1.20		Pass
HT40	MCS0	2	159	5795	13.50	11.80	15.74	30.00		1.20		Pass
VHT20	MCS0	2	149	5745	13.70	11.00	15.57	30.00		1.20		Pass
VHT20	MCS0	2	157	5785	13.60	11.60	15.72	30.00		1.20		Pass
VHT20	MCS0	2	165	5825	13.60	11.60	15.72	30.00		1.20		Pass
VHT40	MCS0	2	151	5755	13.60	11.20	15.57	30.00		1.20		Pass
VHT40	MCS0	2	159	5795	13.60	11.70	15.76	30.00		1.20		Pass
VHT80	MCS0	2	155	5775	13.50	11.60	15.66	30.00		1.20		Pass



Appendix B. Radiated Spurious Emission

Test Engineer :	Jack Cheng, Lance Chiang, Chuan Chu	Temperature :	22~24°C
		Relative Humidity :	56~60%

Band 4 - 5725~5850MHz

WIFI 802.11ac VHT80 (Band Edge @ 3m)

WIFI	Note	Frequency	Level	Over	Limit	Read	Antenna	Path	Preamp	Ant	Table	Peak	Pol.
Ant.				Limit	Line	Level	Factor	Loss	Factor	Pos	Pos	Avg.	
1+2		(MHz)	(dBμV/m)	(dB)	(dBμV/m)	(dBμV)	(dB/m)	(dB)	(dB)	(cm)	(deg)	(P/A)	(H/V)
802.11ac VHT80 CH 155 5775MHz		5643	60.21	-7.99	68.2	51.5	31.71	10.45	33.45	103	5	P	H
		5700	73.73	-31.47	105.2	64.7	32	10.49	33.46	103	5	P	H
		5718.8	73.71	-36.75	110.46	64.63	32.04	10.5	33.46	103	5	P	H
		5720	74.39	-36.41	110.8	65.31	32.04	10.5	33.46	103	5	P	H
	*	5775	101.8	-	-	92.59	32.15	10.53	33.47	103	5	P	H
	*	5775	90.67	-	-	81.46	32.15	10.53	33.47	103	5	A	H
		5851	72.37	-47.55	119.92	62.96	32.3	10.59	33.48	103	5	P	H
		5866.8	71.87	-35.62	107.49	62.42	32.33	10.6	33.48	103	5	P	H
		5876	66.19	-38.27	104.46	56.71	32.35	10.61	33.48	103	5	P	H
		5942.8	56.22	-11.98	68.2	46.47	32.57	10.67	33.49	103	5	P	H
		5646	54.51	-13.69	68.2	45.79	31.71	10.46	33.45	380	335	P	V
		5700	67.28	-37.92	105.2	58.25	32	10.49	33.46	380	335	P	V
		5711.2	64.13	-44.21	108.34	55.08	32.02	10.49	33.46	380	335	P	V
		5720	67.81	-42.99	110.8	58.73	32.04	10.5	33.46	380	335	P	V
	*	5775	94.98	-	-	85.77	32.15	10.53	33.47	380	335	P	V
	*	5775	84.62	-	-	75.41	32.15	10.53	33.47	380	335	A	V
		5850	61.88	-60.32	122.2	52.47	32.3	10.59	33.48	380	335	P	V
		5858.8	64.52	-45.21	109.73	55.09	32.32	10.59	33.48	380	335	P	V
	5875.8	59.24	-45.37	104.61	49.76	32.35	10.61	33.48	380	335	P	V	
	5941.8	55	-13.2	68.2	45.25	32.57	10.67	33.49	380	335	P	V	

Remark

- No other spurious found.
- All results are PASS against Peak and Average limit line.



**Band 4 5725~5850MHz
WIFI 802.11ac VHT80 (Harmonic @ 3m)**

WIFI Ant. 1+2	Note	Frequency (MHz)	Level (dBμV/m)	Over Limit (dB)	Limit Line (dBμV/m)	Read Level (dBμV)	Antenna Factor (dB/m)	Path Loss (dB)	Preamp Factor (dB)	Ant Pos (cm)	Table Pos (deg)	Peak Avg. (P/A)	Pol. (H/V)	
802.11ac VHT80 CH 155 5775MHz		11550	46.81	-27.19	74	52.3	39.7	17.05	62.24	100	0	P	H	
		17325	48.73	-19.47	68.2	44.19	41.12	22.3	58.88	100	0	P	H	
													H	
													H	
			11550	45.53	-28.47	74	51.79	39.7	16.28	62.24	100	0	P	V
			17325	46.73	-21.47	68.2	43.51	41.12	20.98	58.88	100	0	P	V
														V
														V
Remark	1. No other spurious found. 2. All results are PASS against Peak and Average limit line.													



Emission below 1GHz

5GHz WIFI 802.11ac VHT80 (LF @ 3m)

WIFI	Note	Frequency	Level	Over	Limit	Read	Antenna	Path	Preamp	Ant	Table	Peak	Pol.	
Ant.				Limit	Line	Level	Factor	Loss	Factor	Pos	Pos	Avg.		
1+2		(MHz)	(dBμV/m)	(dB)	(dBμV/m)	(dBμV)	(dB/m)	(dB)	(dB)	(cm)	(deg)	(P/A)	(H/V)	
5GHz 802.11ac VHT80 LF		43.58	24.18	-15.82	40	36.16	17.45	0.95	30.38			P	H	
		152.22	28.28	-15.22	43.5	39.81	17.08	1.76	30.37			P	H	
		193.93	22.97	-20.53	43.5	36.42	14.91	1.97	30.33			P	H	
		722.58	35	-11	46	33.51	27.2	3.76	29.47			P	H	
		881.66	34.13	-11.87	46	30	29.1	4.2	29.17			P	H	
		951.5	35.63	-10.37	46	29.6	30.58	4.44	28.99	100	0	P	H	
													H	
													H	
													H	
													H	
													H	
													H	
													H	
													H	
													H	
			43.58	33.48	-6.52	40	45.46	17.45	0.95	30.38	100	0	P	V
			153.19	31.78	-11.72	43.5	43.36	17.03	1.76	30.37			P	V
			188.11	25.82	-17.68	43.5	39.37	14.82	1.96	30.33			P	V
		713.85	32	-14	46	30.81	26.94	3.74	29.49			P	V	
		814.73	33.47	-12.53	46	30.55	28.17	4.02	29.27			P	V	
		890.39	34.91	-11.09	46	30.78	29.05	4.23	29.15			P	V	
													V	
													V	
													V	
													V	
													V	
													V	
Remark	1. No other spurious found. 2. All results are PASS against limit line.													



Note symbol

*	Fundamental Frequency which can be ignored. However, the level of any unwanted emissions shall not exceed the level of the fundamental frequency.
!	Test result is over limit line.
P/A	Peak or Average
H/V	Horizontal or Vertical



A calculation example for radiated spurious emission is shown as below:

WIFI	Note	Frequency	Level	Over	Limit	Read	Antenna	Path	Preamp	Ant	Table	Peak	Pol.
Ant.				Limit	Line	Level	Factor	Loss	Factor	Pos	Pos	Avg.	
1+2		(MHz)	(dBμV/m)	(dB)	(dBμV/m)	(dBμV)	(dB/m)	(dB)	(dB)	(cm)	(deg)	(P/A)	(H/V)
802.11b		2390	55.45	-18.55	74	54.51	32.22	4.58	35.86	103	308	P	H
CH 01		2390	43.54	-10.46	54	42.6	32.22	4.58	35.86	103	308	A	H
2412MHz													

1. Path Loss(dB) = Cable loss(dB) + Filter loss(dB) + Attenuator loss(dB)
2. Level(dBμV/m) = Antenna Factor(dB/m) + Path Loss(dB) + Read Level(dBμV) - Preamp Factor(dB)
3. Over Limit(dB) = Level(dBμV/m) – Limit Line(dBμV/m)

For Peak Limit @ 2390MHz:

1. Level(dBμV/m)
= Antenna Factor(dB/m) + Path Loss(dB) + Read Level(dBμV) - Preamp Factor(dB)
= 32.22(dB/m) + 4.58(dB) + 54.51(dBμV) – 35.86 (dB)
= 55.45 (dBμV/m)
2. Over Limit(dB)
= Level(dBμV/m) – Limit Line(dBμV/m)
= 55.45(dBμV/m) – 74(dBμV/m)
= -18.55(dB)

For Average Limit @ 2390MHz:

1. Level(dBμV/m)
= Antenna Factor(dB/m) + Path Loss(dB) + Read Level(dBμV) - Preamp Factor(dB)
= 32.22(dB/m) + 4.58(dB) + 42.6(dBμV) – 35.86 (dB)
= 43.54 (dBμV/m)
2. Over Limit(dB) = Level(dBμV/m) – Limit Line(dBμV/m)
= 43.54(dBμV/m) – 54(dBμV/m)
= -10.46(dB)

Both peak and average measured complies with the limit line, so test result is “PASS”.



Appendix C. Radiated Spurious Emission Plots

Test Engineer :	Jack Cheng, Lance Chiang, Chuan Chu	Temperature :	22~24°C
		Relative Humidity :	56~60%

Note symbol

-L	Low channel location
-R	High channel location



Band 4 - 5725~5850MHz
WIFI 802.11ac VHT80 (Band Edge @ 3m)

WIFI	Band 4 5725~5850MHz Band Edge @ 3m	
ANT	802.11ac VHT80 CH155 5775MHz	
1+2	Horizontal	Fundamental
Peak	<p>Site : 03CH12-1HY Condition : PEAK_BE(B4)_16-24 3m HORN_9120D_1328 HORIZONTAL RBW:1000.0000kHz VBW:3000.0000Hz SWT:Auto Detector : Peak Project : 802421-03 Mode : 5 Setting : 23</p>	<p>Site : 03CH12-1HY Condition : PEAK(FUN1) 3m HORN_9120D_1328 HORIZONTAL RBW:1000.0000kHz VBW:3000.0000Hz SWT:Auto Detector : Peak Project : 802421-03 Mode : 5 Setting : 23</p>
Peak	<p>Site : 03CH12-1HY Condition : PEAK_BE(B4)_16-24 3m HORN_9120D_1328 HORIZONTAL RBW:1000.0000kHz VBW:3000.0000Hz SWT:Auto Detector : Peak Project : 802421-03 Mode : 5 Setting : 23</p>	Left blank

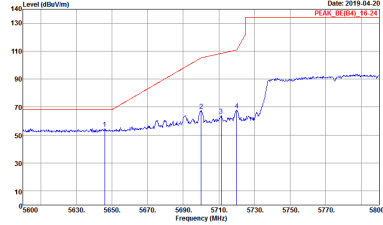
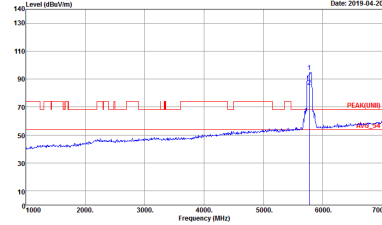
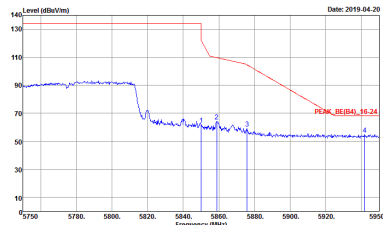

WIFI	Band 4 5725-5850MHz Band Edge @ 3m	
ANT	802.11ac VHT80 CH155 5775MHz	
1+2	Vertical	Fundamental
Peak	 <p>Site : 03CH12-HY Condition : PEAK_BE(B4)_16-24 3m HORN_9120D_1328 VERTICAL Detector : Peak Project : 802421-03 Mode : 5 Setting : 23</p>	 <p>Site : 03CH12-HY Condition : PEAK(UNIT) 3m HORN_9120D_1328 VERTICAL Detector : Peak Project : 802421-03 Mode : 5 Setting : 23</p>
Peak	 <p>Site : 03CH12-HY Condition : PEAK_BE(B4)_16-24 3m HORN_9120D_1328 VERTICAL Detector : Peak Project : 802421-03 Mode : 5 Setting : 23</p>	Left blank



Band 4 - 5725~5850MHz
WIFI 802.11ac VHT80 (Harmonic @ 3m)

WIFI	Band 4 5725~5850MHz Harmonic @ 3m	
ANT	802.11ac VHT80 CH155 5775MHz	
1+2	Horizontal	Vertical
Peak Avg.	<p>Site : 03CH12-HY Condition : PEAK(UNIT) 3m HORN_91200_1328 HORIZONTAL Detector : Peak Project : 802421-03 Mode : 43 Setting : 23</p>	<p>Site : 03CH12-HY Condition : PEAK(UNIT) 3m HORN_91200_1328 VERTICAL Detector : Peak Project : 802421-03 Mode : 43 Setting : 23</p>



Emission below 1GHz
5GHz WIFI 802.11ac VHT80 (LF)

WIFI	5GHz 5725~5850MHz	
ANT	802.11ac VHT80 LF	
1+2	Horizontal	Vertical
QP / Peak	<p>Site : 03CH12-HY Condition : QP 3m BIL05_6111D_37059 HORIZONTAL Detector : Peak Project : 802421-03 Mode : 6</p>	<p>Site : 03CH12-HY Condition : QP 3m BIL05_6111D_37059 VERTICAL Detector : Peak Project : 802421-03 Mode : 6</p>



Appendix D. Duty Cycle Plots

Antenna	Band	Duty Cycle(%)	T(us)	1/T(kHz)	VBW Setting	Duty Factor(dB)
1+2	5GHz 802.11ac VHT80 for Ant. 1	93.65	590	1.69	3kHz	0.29
1+2	5GHz 802.11ac VHT80 for Ant. 2	92.06	580	1.72	3kHz	0.36



MIMO <Ant. 1>

802.11ac VHT80

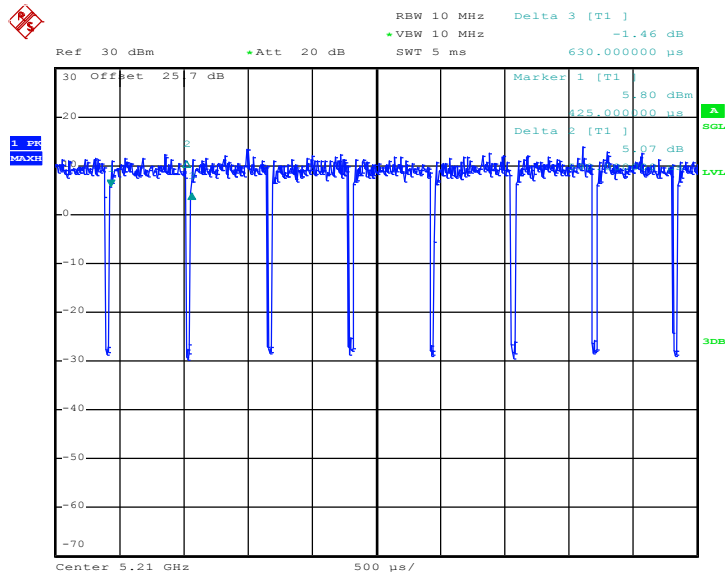

Date: 16.APR.2019 17:02:24

MIMO <Ant. 2>

802.11ac VHT80

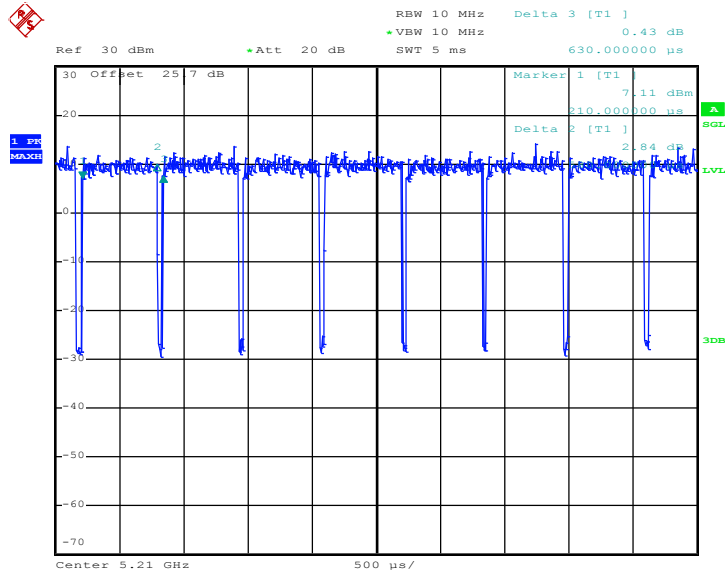

Date: 16.APR.2019 17:06:47

—————THE END—————