



# FCC RADIO TEST REPORT

**FCC ID** : PY7-48130K  
**Equipment** : GSM/WCDMA/LTE Phone with BT, DTS/UNII  
a/b/g/n/ac, GPS and NFC  
**Brand Name** : Sony  
**Applicant** : Sony Mobile Communications Inc.  
4-12-3 Higashi-Shinagawa, Shinagawa-ku,  
Tokyo, 140-0002, Japan  
**Manufacturer** : Sony Mobile Communications Inc.  
4-12-3 Higashi-Shinagawa, Shinagawa-ku,  
Tokyo, 140-0002, Japan  
**Standard** : FCC Part 15 Subpart E §15.407

The product was received on Nov. 01, 2018 and testing was started from Apr. 15, 2019 and completed on Apr. 22, 2019. We, SPORTON INTERNATIONAL INC. EMC & Wireless Communications Laboratory, would like to declare that the tested sample has been evaluated in accordance with the test procedures and has been in compliance with the applicable technical standards.

The report must not be used by the client to claim product certification, approval, or endorsement by TAF or any agency of government.

The test results in this variant report apply exclusively to the tested model / sample. Without written approval of SPORTON INTERNATIONAL INC. EMC & Wireless Communications Laboratory, the test report shall not be reproduced except in full.

Approved by: Jones Tsai

**SPORTON INTERNATIONAL INC. EMC & Wireless Communications Laboratory**

No. 52, Huaya 1st Rd., Guishan Dist., Taoyuan City, Taiwan (R.O.C.)



## Table of Contents

**History of this test report..... 3**

**Summary of Test Result..... 4**

**1 General Description ..... 5**

    1.1 Product Feature of Equipment Under Test..... 5

    1.2 Modification of EUT ..... 5

    1.3 Testing Location ..... 6

    1.4 Applicable Standards..... 6

**2 Test Configuration of Equipment Under Test ..... 7**

    2.1 Carrier Frequency and Channel ..... 7

    2.2 Test Mode ..... 8

    2.3 Connection Diagram of Test System ..... 9

    2.4 EUT Operation Test Setup ..... 9

**3 Test Result ..... 10**

    3.1 Maximum Conducted Output Power Measurement ..... 10

    3.2 Unwanted Emissions Measurement ..... 12

    3.3 Antenna Requirements ..... 17

**4 List of Measuring Equipment..... 18**

**5 Uncertainty of Evaluation ..... 20**

**Appendix A. Conducted Test Results**

**Appendix B. Radiated Spurious Emission**

**Appendix C. Radiated Spurious Emission Plots**

**Appendix D. Duty Cycle Plots**





### Summary of Test Result

Report Clause	Ref Std. Clause	Test Items	Result (PASS/FAIL)	Remark
-	15.403(i)	26dB Bandwidth	Not Required	-
-	2.1049	99% Occupied Bandwidth	Not Required	-
3.1	15.407(a)	Maximum Conducted Output Power	Pass	-
-	15.407(a)	Power Spectral Density	Not Required	-
3.2	15.407(b)	Unwanted Emissions	Pass	Under limit 3.20 dB at 5350.080 MHz
-	15.207	AC Conducted Emission	Not Required	-
-	15.407(c)	Automatically Discontinue Transmission	Not Required	-
3.3	15.203 15.407(a)	Antenna Requirement	Pass	-

**Remark:**

1. Not required means after assessing, test items are not necessary to carry out.
2. This is a variant report. All the test cases were performed on original report which can be referred to Sporton Report Number FR802417-03E.
3. The spot-check data performed in this report are chosen from the worst case of the original FCC ID report and the spot-check data summary is included in the another spot check data report.

**Declaration of Conformity:**

The test results with all measurement uncertainty excluded are presented in accordance with the regulation limits or requirements declared by manufacturers.

**Comments and Explanations:**

The declared of product specification for EUT presented in the report are provided by the manufacturer, and the manufacturer takes all the responsibilities for the accuracy of product specification.

Reviewed by: Wii Chang

Report Producer: Natasha Hsieh



# 1 General Description

## 1.1 Product Feature of Equipment Under Test

GSM/WCDMA/LTE, Bluetooth, DTS/UNII a/b/g/n/ac, NFC, and GNSS.

Standards-related Product Specification	
Antenna Type	<Ant. 1>: Loop Antenna <Ant. 2>: Monopole Antenna
Antenna Gain	<5150 MHz ~ 5250 MHz> <Ant. 1>: -5.7 dBi <Ant. 2>: -7.3 dBi <5250 MHz ~ 5350 MHz> <Ant. 1>: -5.3 dBi <Ant. 2>: -4.9 dBi <5470 MHz ~ 5725 MHz> <Ant. 1>: -5.7 dBi <Ant. 2>: 1.3 dBi

EUT Information List			
HW Version	SW Version	S/N	Performed Test Item
A	2.37	QV71006R1S	RF conducted measurement
		QV71002F1S	Radiated Spurious Emission

Accessory List	
AC Adapter	Model Name : UCH32
	S/N : 6218W30200106
Earphone	Model Name.: MH750
	S/N : N/A
USB Cable	Model Name.: UCB24
	S/N : N/A
2 in 1 USB Audio Cable	Model Name: EC270
	S/N : N/A

**Note:**

1. Above EUT list used are electrically identical per declared by manufacturer.
2. Above the accessories list are used to exercise the EUT during test, and the serial number of each type of accessories is listed in each section of this report. .
3. For other wireless features of this EUT, test report will be issued separately.

## 1.2 Modification of EUT

No modifications are made to the EUT during all test items.



### 1.3 Testing Location

<b>Test Site</b>	SPORTON INTERNATIONAL INC.
<b>Test Site Location</b>	No.58, Aly. 75, Ln. 564, Wenhua 3rd, Rd., Guishan Dist., Taoyuan City, Taiwan (R.O.C.) TEL: +886-3-327-0868 FAX: +886-3-327-0855
<b>Test Site No.</b>	<b>Sporton Site No.</b>
	03CH13-HY

**Note:** The test site complies with ANSI C63.4 2014 requirement.

FCC Designation No.: TW0007

### 1.4 Applicable Standards

According to the specifications of the manufacturer, the EUT must comply with the requirements of the following standards:

- ♦ FCC Part 15 Subpart E
- ♦ FCC KDB 789033 D02 General UNII Test Procedures New Rules v02r01.
- ♦ FCC KDB 414788 D01 Radiated Test Site v01r01.
- ♦ FCC KDB 662911 D01 Multiple Transmitter Output v02r01.
- ♦ ANSI C63.10-2013

**Remark:**

1. All test items were verified and recorded according to the standards and without any deviation during the test.
2. This EUT has also been tested and complied with the requirements of FCC Part 15, Subpart B, recorded in a separate test report.



## 2 Test Configuration of Equipment Under Test

- a. The EUT has been associated with peripherals and configuration operated in a manner tended to maximize its emission characteristics in a typical application. Frequency range investigated: radiation emission (9 kHz to the 10th harmonic of the highest fundamental frequency or to 40 GHz, whichever is lower). For radiated measurement, pre-scanned in three orthogonal panels, X, Y, Z. The worst cases (Y plane) were recorded in this report.

### 2.1 Carrier Frequency and Channel

Frequency Band	Channel	Freq. (MHz)	Channel	Freq. (MHz)
5150-5250 MHz Band 1 (U-NII-1)	36	5180	44	5220
	38*	5190	46*	5230
	40	5200	48	5240
	42 <sup>#</sup>	5210		

Frequency Band	Channel	Freq. (MHz)	Channel	Freq. (MHz)
5250-5350 MHz Band 2 (U-NII-2A)	52	5260	60	5300
	54*	5270	62*	5310
	56	5280	64	5320
	58 <sup>#</sup>	5290		

Frequency Band	Channel	Freq. (MHz)	Channel	Freq. (MHz)
5470-5725 MHz Band 3 (U-NII-2C)	100	5500	112	5560
	102*	5510	116	5580
	104	5520	132	5660
	106 <sup>#</sup>	5530	134*	5670
	108	5540	136	5680
	110*	5550	140	5700



Frequency Band	Channel	Freq. (MHz)	Channel	Freq. (MHz)
TDWR Channel	118*	5590	124	5620
	120	5600	126*	5630
	122 <sup>#</sup>	5610	128	5640

Frequency Band	Channel	Freq. (MHz)	Channel	Freq. (MHz)
Straddle Channel	138 <sup>#</sup>	5690	144	5720
	142*	5710		

Note:

1. The above Frequency and Channel in "\*" were 802.11n HT40 and 802.11ac VHT40.
2. The above Frequency and Channel in "<sup>#</sup>" were 802.11ac VHT80.

## 2.2 Test Mode

Final test modes are considering the modulation and worse data rates as below table.

Modulation	Data Rate
802.11n HT20	MCS0
802.11n HT40	MCS0
802.11ac VHT80	MCS0

Ch. #		Band I : 5150-5250 MHz	Band II : 5250-5350 MHz	Band III : 5470-5725MHz
		802.11n HT40	802.11ac VHT80	802.11n HT20
L	Low	-	-	-
M	Middle	-	58	-
H	High	46	-	140
Straddle			-	-



## 2.3 Connection Diagram of Test System

<WLAN Tx Mode>

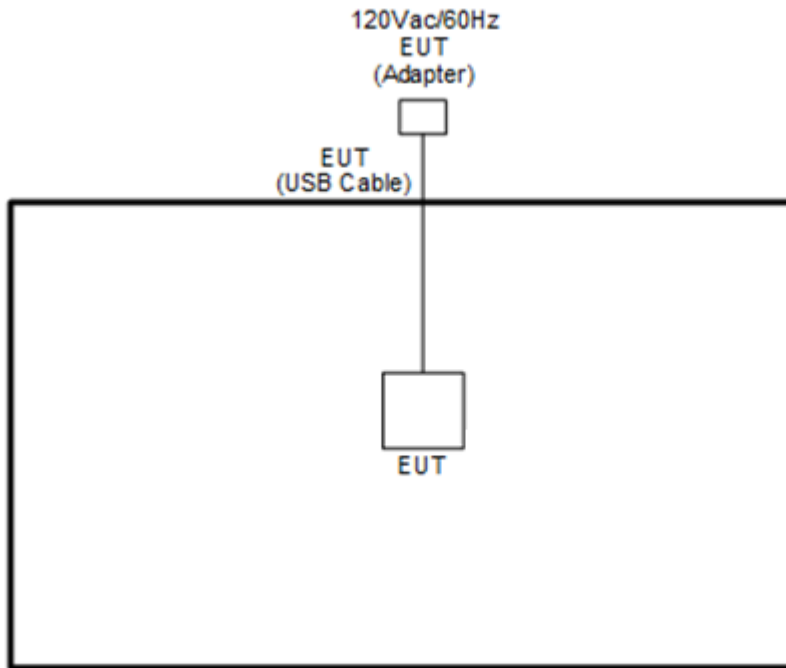

## 2.4 EUT Operation Test Setup

The RF test items, utility “Tera Term” was installed in Notebook which was programmed in order to make the EUT get into the engineering modes to provide channel selection, power level, data rate and the application type and for continuous transmitting signals.



### 3 Test Result

#### 3.1 Maximum Conducted Output Power Measurement

##### 3.1.1 Limit of Maximum Conducted Output Power

<FCC 14-30 CFR 15.407>

**For the 5.15–5.25 GHz bands:**

- For mobile and portable client devices in the 5.15–5.25 GHz band, the maximum conducted output power over the frequency band of operation shall not exceed 250 mW. For an indoor access point operating in the band 5.15-5.25 GHz, the maximum conducted output power over the frequency band of operation shall not exceed 1 W.

**For the 5.25–5.725 GHz bands:**

- The maximum conducted output power over the frequency bands of operation shall not exceed the lesser of 250 mW or  $11 \text{ dBm} + 10 \log B$ , where B is the 26 dB emission bandwidth in megahertz.

For Straddle Channel, according to KDB 789033 D02 General UNII Test Procedures New Rules v02r01, if the power and PSD of the devices are uniform and comply with the lower limits specified for the U-NII-2 bands, a single measurement over the entire emission bandwidth can be performed to show compliance.

If transmitting antennas of directional gain greater than 6 dBi are used, the peak output power shall be reduced by the amount in dB that the directional gain of the antenna exceeds 6 dBi.

Note that U-NII-2 band, devices with a maximum e.i.r.p. greater than 500 mW shall implement TPC in order to have the capability to operate at least 6 dB below the maximum permitted e.i.r.p. of 1 W.

##### 3.1.2 Measuring Instruments

See list of measuring equipment of this test report.

### 3.1.3 Test Procedures

The testing follows Method PM-G of FCC KDB 789033 D02 General UNII Test Procedures New Rules v02r01 for TXBF modes.

Method PM-G (Measurement using a gated RF average power meter):

1. Measurement is performed using a wideband RF power meter.
2. The EUT is configured to transmit at its maximum power control level.
3. Measure the average power of the transmitter
4. Since the measurement is made only during the ON time of the transmitter, no duty cycle correction factor is required.

For Straddle Channel, according to KDB 789033 D02 General UNII Test Procedures New Rules v02r01, if the power and PSD of the devices are uniform and comply with the lower limits specified for the U-NII-2 bands, a single measurement over the entire emission bandwidth can be performed to show compliance.

### 3.1.4 Test Setup

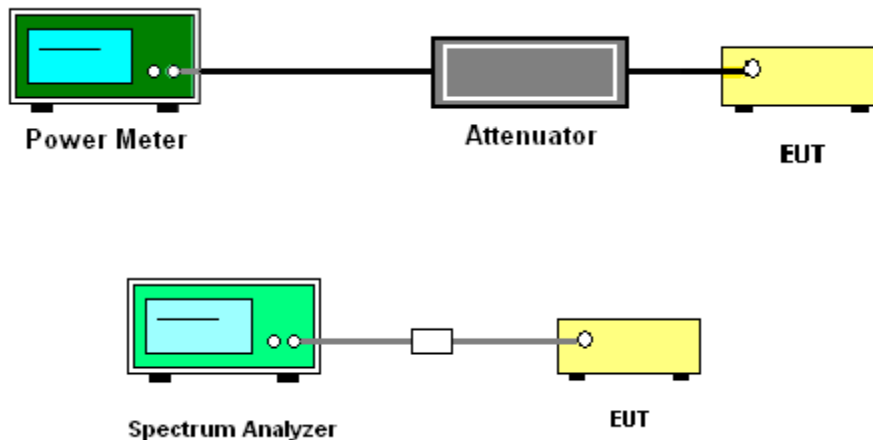

### 3.1.5 Test Result of Maximum Conducted Output Power

Please refer to Appendix A.



### 3.2 Unwanted Emissions Measurement

This section is to measure unwanted emissions through radiated measurement for band edge spurious emissions and out of band emissions measurement.

#### 3.2.1 Limit of Unwanted Emissions

- (1) For transmitters operating in the 5150-5250 MHz band: all emissions outside of the 5150-5350 MHz band shall not exceed an EIRP of -27dBm/MHz.

For transmitters operating in the 5250-5350 MHz band: all emissions outside of the 5150-5350 MHz band shall not exceed an EIRP of -27 dBm/MHz. Devices operating in the 5250-5350 MHz band that generate emissions in the 5150-5250 MHz band must meet all applicable technical requirements for operation in the 5150-5250 MHz band (including indoor use) or alternatively meet an out-of-band emission EIRP limit of -27 dBm/MHz in the 5150-5250 MHz band.

For transmitters operating in the 5470-5600 MHz and 5650-5725MHz band: all emissions outside of the 5470-5600 MHz and 5650-5725MHz band shall not exceed an EIRP of -27 dBm/MHz.

- (2) Unwanted spurious emissions fallen in restricted bands shall comply with the general field strength limits as below table,

Frequency (MHz)	Field Strength (microvolts/meter)	Measurement Distance (meters)
0.009 – 0.490	2400/F(kHz)	300
0.490 – 1.705	24000/F(kHz)	30
1.705 – 30.0	30	30
30 – 88	100	3
88 – 216	150	3
216 - 960	200	3
Above 960	500	3

**Note:** The following formula is used to convert the EIRP to field strength.

$$E = \frac{1000000\sqrt{30P}}{3} \mu\text{V/m, where P is the eirp (Watts)}$$



EIRP (dBm)	Field Strength at 3m (dBµV/m)
- 27	68.3

(3) KDB789033 D02 v02r01 G)2)c)

- (i) Section 15.407(b)(1) to (b)(3) specify the unwanted emission limits for the U-NII-1 and U-NII-2 bands. As specified, emissions above 1000 MHz that are outside of the restricted bands are subject to a peak emission limit of -27 dBm/MHz.<sup>3</sup>
- (ii) Section 15.407(b)(4) specifies the unwanted emission limit for the U-NII-3 band. A band emissions mask is specified in Section 15.407(b)(4)(i). The emission limits are in terms of a Peak detector. An alternative to the band emissions mask is specified in Section 15.407(b)(4)(ii). The alternative limits are based on the highest antenna gain specified in the filing. There are also marketing and importation restrictions for the devices using the alternative limit.<sup>4</sup>

**Note 3:** An out-of-band emission that complies with both the average and peak limits of Section 15.209 is not required to satisfy the -27 dBm/MHz peak emission limit.

**Note 4:** Only devices with antenna gains of 10 dBi or less may be approved using the emission limits specified in Section 15.247(d) till March 2, 2018; all other devices operating in this band must use the mask specified in Section 15.407(b)(4)(i).

### 3.2.2 Measuring Instruments

See list of measuring equipment of this test report.

### 3.2.3 Test Procedures

1. The testing follows FCC KDB 789033 D02 General UNII Test Procedures New Rules v02r01. Section G) Unwanted emissions measurement.
  - (1) Procedure for Unwanted Emissions Measurements Below 1000MHz
    - RBW = 120 kHz
    - VBW = 300 kHz
    - Detector = Peak
    - Trace mode = max hold
  - (2) Procedure for Peak Unwanted Emissions Measurements Above 1000 MHz
    - RBW = 1 MHz
    - VBW ≥ 3 MHz
    - Detector = Peak
    - Sweep time = auto
    - Trace mode = max hold



(3) Procedures for Average Unwanted Emissions Measurements Above 1000MHz

- RBW = 1 MHz
  - VBW = 10 Hz, when duty cycle is no less than 98 percent.
  - $VBW \geq 1/T$ , when duty cycle is less than 98 percent where T is the minimum transmission duration over which the transmitter is on and is transmitting at its maximum power control level for the tested mode of operation.
2. The EUT was placed on a turntable with 0.8 meter for frequency below 1GHz and 1.5 meter for frequency above 1GHz respectively above ground.
  3. The EUT was set 3 meters from the interference receiving antenna which was mounted on the top of a variable height antenna tower.
  4. The antenna is a broadband antenna and its height is adjusted between one meter and four meters above ground to find the maximum value of the field strength for both horizontal polarization and vertical polarization of the antenna.
  5. For each suspected emission, the EUT was arranged to its worst case and then adjust the antenna tower (from 1 m to 4 m) and turntable (from 0 degree to 360 degrees) to find the maximum reading.
  6. For testing below 1GHz, if the emission level of the EUT in peak mode was 3 dB lower than the limit specified, then peak values of EUT will be reported, otherwise, the emissions will be repeated one by one using the CISPR quasi-peak method and reported.
  7. For testing above 1GHz, the emission level of the EUT in peak mode was 20dB lower than average limit (that means the emission level in average mode also complies with the limit in average mode), then peak values of EUT will be reported, otherwise, the emissions will be measured in average mode again and reported.

### 3.2.4 Test Setup

For radiated emissions below 30MHz

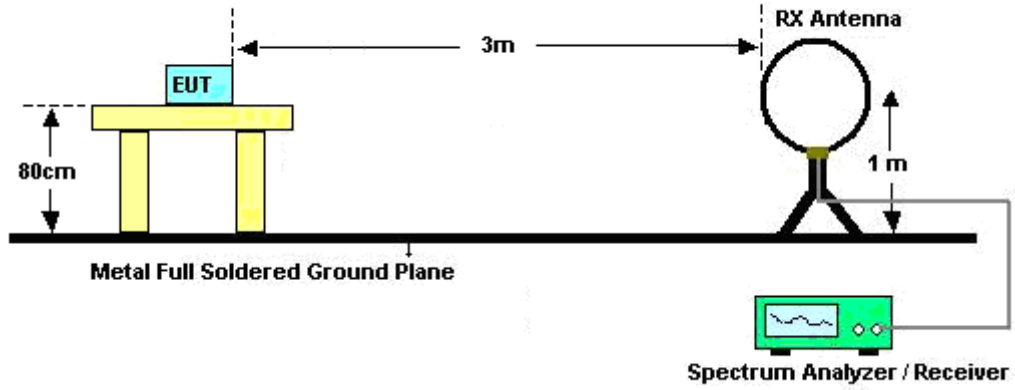

For radiated emissions from 30MHz to 1GHz

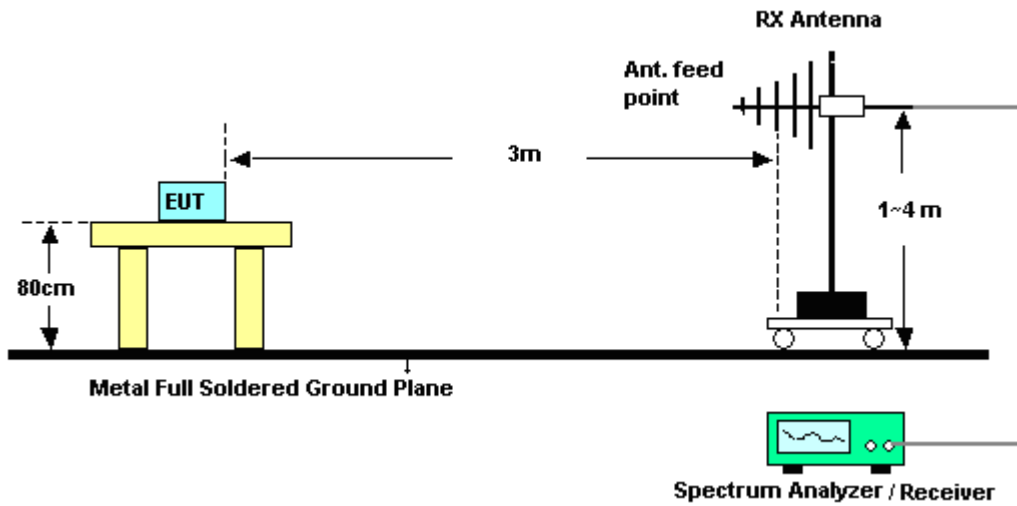

For radiated emissions above 1GHz

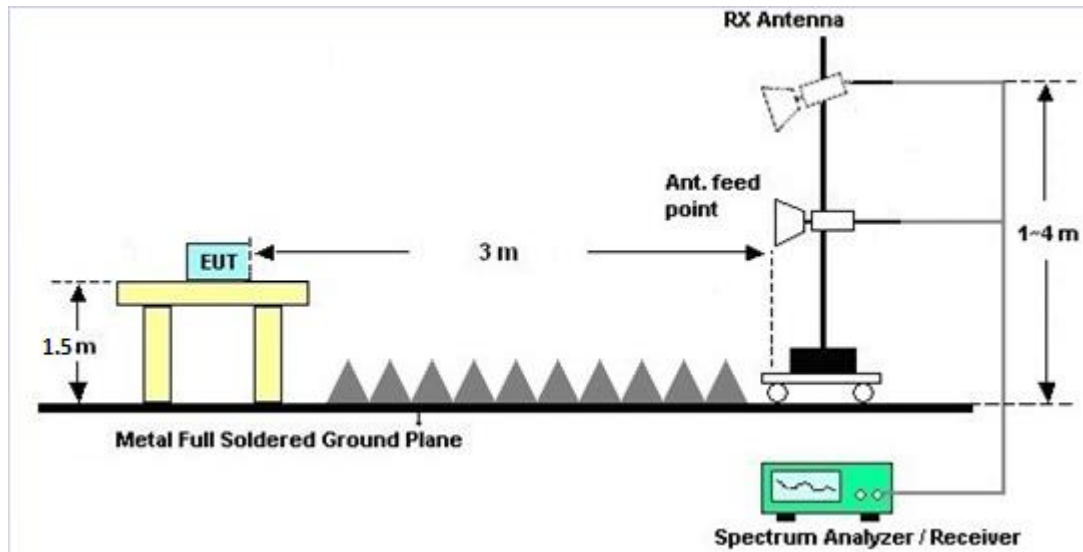

### 3.2.5 Test Results of Radiated Spurious Emissions (9 kHz ~ 30 MHz)

The low frequency, which started from 9 kHz to 30MHz, was pre-scanned and the result which was 20dB lower than the limit line was not reported.

There is a comparison data of both open-field test site and alternative test site - semi-Anechoic chamber according to 414788 D01 Radiated Test Site v01r01, and the result came out very similar.

### 3.2.6 Test Result of Radiated Spurious at Band Edges

Please refer to Appendix B and C.

### 3.2.7 Duty Cycle

Please refer to Appendix D.

### 3.2.8 Test Result of Radiated Spurious Emissions (30MHz ~ 10th Harmonic)

Please refer to Appendix B and C.





### 3.3 Antenna Requirements

#### 3.3.1 Standard Applicable

If transmitting antenna directional gain is greater than 6 dBi, both the peak transmit power and the peak power spectral density shall be reduced by the amount in dB that the directional gain of the antenna exceeds 6 dBi.

#### 3.3.2 Antenna Anti-Replacement Construction

An embedded-in antenna design is used.

#### 3.3.3 Antenna Gain

<CDD Modes >

FCC KDB 662911 D01 Multiple Transmitter Output v02r01

For CDD transmissions, directional gain is calculated as

Directional gain = GANT + Array Gain, where Array Gain is as follows.

For power spectral density (PSD) measurements on all devices,

Array Gain = 10 log(NANT/NSS=1) dB.

For power measurements on IEEE 802.11 devices,

Array Gain = 0 dB (i.e., no array gain) for NANT ≤ 4.

Directional gain may be calculated by using the formulas applicable to equal gain antennas with GANT set equal to the gain of the antenna having the highest gain;

The EUT supports CDD mode.

For power, the directional gain GANT is set equal to the antenna having the highest gain, i.e., F)2)f)i).

For PSD, the directional gain calculation is following F)2)f)ii) of KDB 662911 D01 v02r01.

The power and PSD limit should be modified if the directional gain of EUT is over 6 dBi,

The directional gain "DG" is calculated as following table.

<CDD Modes>						
	Ant. 1	Ant. 2	DG	DG	Power	PSD
	(dBi)	(dBi)	for	for	Limit	Limit
			Power	PSD	Reduction	Reduction
	(dBi)	(dBi)	(dBi)	(dBi)	(dB)	(dB)
Band I	-5.70	-7.30	-5.70	-3.45	0.00	0.00
Band II	-5.30	-4.90	-4.90	-2.09	0.00	0.00
Band III	-5.70	1.30	1.30	1.50	0.00	0.00

Power limit reduction = Composite gain – 6dBi, ( min = 0 )

PSD limit reduction = Composite gain + PSD Array gain – 6dBi, ( min = 0 )



## 4 List of Measuring Equipment

Instrument	Manufacturer	Model No.	Serial No.	Characteristics	Calibration Date	Test Date	Due Date	Remark
Hygrometer	Testo	HTC-1	4	N/A	May 12, 2018	Apr. 15, 2019	May 11, 2019	Conducted (TH05-HY)
Power Sensor	DARE	RPR3006W	15100041SN O10	10MHz~6GHz	May 07, 2018	Apr. 15, 2019	May 06, 2019	Conducted (TH05-HY)
Switch Box & RF Cable	Burgeon	ETF-058	EC1300484	N/A	Feb. 28, 2019	Apr. 15, 2019	Feb. 27, 2020	Conducted (TH05-HY)
Programmable Power Supply	GW Instek	PSS-2005	EL890094	1V~20V 0.5A~5A	Oct. 02, 2018	Apr. 15, 2019	Oct. 01, 2019	Conducted (TH05-HY)
Loop Antenna	Rohde & Schwarz	HFH2-Z2	100488	9 kHz~30 MHz	Jan. 07, 2019	Apr. 19, 2019~ Apr. 22, 2019	Jan. 06, 2020	Radiation (03CH13-HY)
Bilog Antenna	TESEQ	CBL 6111D&00800 N1D01N-06	37059&01	30MHz~1GHz	Oct. 13, 2018	Apr. 19, 2019~ Apr. 22, 2019	Oct. 12, 2019	Radiation (03CH13-HY)
Horn Antenna	SCHWARZBECK	BBHA 9120 D	9120D-1241	1GHz ~ 18GHz	Jun. 29, 2018	Apr. 19, 2019~ Apr. 22, 2019	Jun. 28, 2019	Radiation (03CH13-HY)
SHF-EHF Horn Antenna	SCHWARZBECK	BBHA 9170	BBHA917058 4	18GHz- 40GHz	Dec. 05, 2018	Apr. 19, 2019~ Apr. 22, 2019	Dec. 04, 2019	Radiation (03CH13-HY)
Preamplifier	Keysight	83017A	MY53270080	1GHz~26.5GHz	Nov. 14, 2018	Apr. 19, 2019~ Apr. 22, 2019	Nov. 13, 2020	Radiation (03CH13-HY)
Preamplifier	MITEQ	AMF-7D-0010 1800-30-10P	1590074	1GHz~18GHz	May 21, 2018	Apr. 19, 2019~ Apr. 22, 2019	May 20, 2019	Radiation (03CH13-HY)
Amplifier	Sonoma-Instrument	310 N	187282	9KHz~1GHz	Dec. 18, 2018	Apr. 19, 2019~ Apr. 22, 2019	Dec. 17, 2019	Radiation (03CH13-HY)
Amplifier	MITEQ	TTA1840-35-HG	1871923	18GHz~40GHz, VSWR : 2.5:1 max	Jul. 16, 2018	Apr. 19, 2019~ Apr. 22, 2019	Jul. 15, 2019	Radiation (03CH13-HY)
Spectrum Analyzer	Keysight	N9010A	MY55370526	10Hz~44GHz	Mar. 19, 2019	Apr. 19, 2019~ Apr. 22, 2019	Mar. 18, 2020	Radiation (03CH13-HY)
EMI Test Receiver	Keysight	N9038A(MXE)	MY54130085	20Hz ~ 8.4GHz	Nov. 01, 2018	Apr. 19, 2019~ Apr. 22, 2019	Oct. 31, 2019	Radiation (03CH13-HY)
Hygrometer	TECPEL	DTM-303B	TP157151	N/A	May 19, 2018	Apr. 19, 2019~ Apr. 22, 2019	May 18, 2019	Radiation (03CH13-HY)
Filter	Wainwright	WHKX12-1080 -1200-15000-6 OST	SN3	1.2G Low Pass	Jul. 05, 2018	Apr. 19, 2019~ Apr. 22, 2019	Jul. 04, 2019	Radiation (03CH13-HY)
Filter	Wainwright	WHKX8-5872. 5-6750-18000- 40ST	SN3	6.75 GHz Highpass	Sep. 16, 2018	Apr. 19, 2019~ Apr. 22, 2019	Sep. 15, 2019	Radiation (03CH13-HY)
Filter	Wainwright	WHKX12-2700 -3000-18000-6 OSS	SN2	3G High Pass	Jul. 16, 2018	Apr. 19, 2019~ Apr. 22, 2019	Jul. 15, 2019	Radiation (03CH13-HY)



Instrument	Manufacturer	Model No.	Serial No.	Characteristics	Calibration Date	Test Date	Due Date	Remark
RF Cable	HUBER + SUHNER	SUCOFLEX 126E	0030/126E	30M-18G	Feb. 13, 2019	Apr. 19, 2019~ Apr. 22, 2019	Feb. 12, 2020	Radiation (03CH13-HY)
RF Cable	HUBER + SUHNER	SUCOFLEX 104	804793/4	30M-18G	Feb. 13, 2019	Apr. 19, 2019~ Apr. 22, 2019	Feb. 12, 2020	Radiation (03CH13-HY)
RF Cable	HUBER + SUHNER	SUCOFLEX 104	MY24961/4	30M-18G	Feb. 13, 2019	Apr. 19, 2019~ Apr. 22, 2019	Feb. 12, 2020	Radiation (03CH13-HY)
RF Cable	HUBER + SUHNER	SUCOFLEX 102	MY2859/2	30M~40GHz	Mar. 13, 2019	Apr. 19, 2019~ Apr. 22, 2019	Mar. 12, 2020	Radiation (03CH13-HY)
RF Cable	HUBER + SUHNER	SUCOFLEX 102	MY4274/2	30M~40GHz	Mar. 13, 2019	Apr. 19, 2019~ Apr. 22, 2019	Mar. 12, 2020	Radiation (03CH13-HY)
Controller	EMEC	EM1000	N/A	Control Turn table & Ant Mast	N/A	Apr. 19, 2019~ Apr. 22, 2019	N/A	Radiation (03CH13-HY)
Antenna Mast	EMEC	AM-BS-4500-B	N/A	1m~4m	N/A	Apr. 19, 2019~ Apr. 22, 2019	N/A	Radiation (03CH13-HY)
Turn Table	EMEC	TT2000	N/A	0~360 Degree	N/A	Apr. 19, 2019~ Apr. 22, 2019	N/A	Radiation (03CH13-HY)
Software	AUDIX	E3 6.2009-8-24c	RK-001124	N/A	N/A	Apr. 19, 2019~ Apr. 22, 2019	N/A	Radiation (03CH13-HY)



## 5 Uncertainty of Evaluation

### Uncertainty of Radiated Emission Measurement (30 MHz ~ 1000 MHz)

Measuring Uncertainty for a Level of Confidence of 95% ( $U = 2Uc(y)$ )	4.90
---	------

### Uncertainty of Radiated Emission Measurement (1000 MHz ~ 18000 MHz)

Measuring Uncertainty for a Level of Confidence of 95% ( $U = 2Uc(y)$ )	5.40
---	------

### Uncertainty of Radiated Emission Measurement (18000 MHz ~ 40000 MHz)

Measuring Uncertainty for a Level of Confidence of 95% ( $U = 2Uc(y)$ )	4.30
---	------

**Appendix A. Test Result of Conducted Test Items**

Test Engineer:	Richard Qiu	Temperature:	21~25	°C
Test Date:	2019/4/15	Relative Humidity:	51~54	%

**TEST RESULTS DATA**  
**Average Power Table**

FCC Band I												
Mod.	Data Rate	NTX	CH.	Freq. (MHz)	Average Conducted Power (dBm)			FCC Conducted Power Limit (dBm)		DG (dBi)		Pass/Fail
					Ant 1	Ant 2	SUM	Ant 1	Ant 2	Ant 1	Ant 2	
11a	6Mbps	1	36	5180	13.60	11.50		24.00	24.00	-5.70	-7.30	Pass
11a	6Mbps	1	44	5220	13.60	11.40		24.00	24.00	-5.70	-7.30	Pass
11a	6Mbps	1	48	5240	13.40	11.70		24.00	24.00	-5.70	-7.30	Pass
HT20	MCS0	1	36	5180	13.70	11.60		24.00	24.00	-5.70	-7.30	Pass
HT20	MCS0	1	44	5220	13.70	11.50		24.00	24.00	-5.70	-7.30	Pass
HT20	MCS0	1	48	5240	13.60	11.40		24.00	24.00	-5.70	-7.30	Pass
HT40	MCS0	1	38	5190	13.70	11.60		24.00	24.00	-5.70	-7.30	Pass
HT40	MCS0	1	46	5230	13.70	11.70		24.00	24.00	-5.70	-7.30	Pass
VHT20	MCS0	1	36	5180	13.60	11.50		24.00	24.00	-5.70	-7.30	Pass
VHT20	MCS0	1	44	5220	13.60	11.40		24.00	24.00	-5.70	-7.30	Pass
VHT20	MCS0	1	48	5240	13.50	11.40		24.00	24.00	-5.70	-7.30	Pass
VHT40	MCS0	1	38	5190	13.60	11.50		24.00	24.00	-5.70	-7.30	Pass
VHT40	MCS0	1	46	5230	13.60	11.60		24.00	24.00	-5.70	-7.30	Pass
VHT80	MCS0	1	42	5210	13.60	11.60		24.00	24.00	-5.70	-7.30	Pass
11a	6Mbps	2	36	5180	13.80	11.30	15.74	24.00		-5.70		Pass
11a	6Mbps	2	44	5220	13.80	11.10	15.67	24.00		-5.70		Pass
11a	6Mbps	2	48	5240	13.70	11.20	15.64	24.00		-5.70		Pass
HT20	MCS0	2	36	5180	13.80	11.70	15.89	24.00		-5.70		Pass
HT20	MCS0	2	44	5220	13.80	11.80	15.92	24.00		-5.70		Pass
HT20	MCS0	2	48	5240	13.80	11.30	15.74	24.00		-5.70		Pass
HT40	MCS0	2	38	5190	13.70	11.60	15.79	24.00		-5.70		Pass
HT40	MCS0	2	46	5230	13.70	11.80	15.86	24.00		-5.70		Pass
VHT20	MCS0	2	36	5180	13.70	11.70	15.82	24.00		-5.70		Pass
VHT20	MCS0	2	44	5220	13.60	11.50	15.69	24.00		-5.70		Pass
VHT20	MCS0	2	48	5240	13.70	11.40	15.71	24.00		-5.70		Pass
VHT40	MCS0	2	38	5190	13.60	11.50	15.69	24.00		-5.70		Pass
VHT40	MCS0	2	46	5230	13.60	11.70	15.76	24.00		-5.70		Pass
VHT80	MCS0	2	42	5210	13.90	11.50	15.87	24.00		-5.70		Pass

**TEST RESULTS DATA**  
**Average Power Table**

FCC Band II													
Mod.	Data Rate	NTX	CH.	Freq. (MHz)	Average Conducted Power (dBm)			FCC Conducted Power Limit (dBm)		DG (dBi)		EIRP Power Limit (dBm)	Pass/Fail
					Ant 1	Ant 2	SUM	Ant 1	Ant 2	Ant 1	Ant 2		
11a	6Mbps	1	52	5260	13.30	11.50		23.98	23.98	-5.30	-4.00	26.99	Pass
11a	6Mbps	1	60	5300	13.50	11.50		23.98	23.98	-5.30	-4.00	26.99	Pass
11a	6Mbps	1	64	5320	13.50	11.50		23.98	23.98	-5.30	-4.00	26.99	Pass
HT20	MCS0	1	52	5260	13.60	11.50		23.98	23.98	-5.30	-4.00	26.99	Pass
HT20	MCS0	1	60	5300	13.70	11.60		23.98	23.98	-5.30	-4.00	26.99	Pass
HT20	MCS0	1	64	5320	13.70	11.60		23.98	23.98	-5.30	-4.00	26.99	Pass
HT40	MCS0	1	54	5270	13.60	11.60		23.98	23.98	-5.30	-4.00	26.99	Pass
HT40	MCS0	1	62	5310	13.70	11.60		23.98	23.98	-5.30	-4.00	26.99	Pass
VHT20	MCS0	1	52	5260	13.50	11.40		23.98	23.98	-5.30	-4.00	26.99	Pass
VHT20	MCS0	1	60	5300	13.60	11.50		23.98	23.98	-5.30	-4.00	26.99	Pass
VHT20	MCS0	1	64	5320	13.60	11.30		23.98	23.98	-5.30	-4.00	26.99	Pass
VHT40	MCS0	1	54	5270	13.50	11.50		23.98	23.98	-5.30	-4.00	26.99	Pass
VHT40	MCS0	1	62	5310	13.60	11.50		23.98	23.98	-5.30	-4.00	26.99	Pass
VHT80	MCS0	1	58	5290	13.60	11.40		23.98	23.98	-5.30	-4.00	26.99	Pass
11a	6Mbps	2	52	5260	13.80	11.30	15.74	23.98		-4.00		26.99	Pass
11a	6Mbps	2	60	5300	13.80	11.70	15.89	23.98		-4.00		26.99	Pass
11a	6Mbps	2	64	5320	13.70	11.10	15.60	23.98		-4.00		26.99	Pass
HT20	MCS0	2	52	5260	13.70	11.70	15.82	23.98		-4.00		26.99	Pass
HT20	MCS0	2	60	5300	13.80	11.70	15.89	23.98		-4.00		26.99	Pass
HT20	MCS0	2	64	5320	13.80	11.80	15.92	23.98		-4.00		26.99	Pass
HT40	MCS0	2	54	5270	13.70	11.50	15.75	23.98		-4.00		26.99	Pass
HT40	MCS0	2	62	5310	13.80	11.70	15.89	23.98		-4.00		26.99	Pass
VHT20	MCS0	2	52	5260	13.50	11.70	15.70	23.98		-4.00		26.99	Pass
VHT20	MCS0	2	60	5300	13.80	11.70	15.89	23.98		-4.00		26.99	Pass
VHT20	MCS0	2	64	5320	13.80	11.70	15.89	23.98		-4.00		26.99	Pass
VHT40	MCS0	2	54	5270	13.60	11.50	15.69	23.98		-4.00		26.99	Pass
VHT40	MCS0	2	62	5310	13.70	11.70	15.82	23.98		-4.00		26.99	Pass
VHT80	MCS0	2	58	5290	13.80	11.60	15.85	23.98		-4.00		26.99	Pass

**TEST RESULTS DATA**  
**Average Power Table**

FCC Band III													
Mod.	Data Rate	NTX	CH.	Freq. (MHz)	Average Conducted Power (dBm)			FCC Conducted Power Limit (dBm)		DG (dBi)		EIRP Power Limit (dBm)	Pass/Fail
					Ant 1	Ant 2	SUM	Ant 1	Ant 2	Ant 1	Ant 2		
11a	6Mbps	1	100	5500	13.40	11.70		23.98	23.98	-5.70	1.30	26.99	Pass
11a	6Mbps	1	116	5580	13.40	11.50		23.98	23.98	-5.70	1.30	26.99	Pass
11a	6Mbps	1	140	5700	11.30	11.50		23.98	23.98	-5.70	1.30	26.99	Pass
11a	6Mbps	1	144	5720	13.30	11.40		23.98	23.98	-5.70	1.30	26.99	Pass
HT20	MCS0	1	100	5500	13.60	11.70		23.98	23.98	-5.70	1.30	26.99	Pass
HT20	MCS0	1	116	5580	13.60	11.40		23.98	23.98	-5.70	1.30	26.99	Pass
HT20	MCS0	1	140	5700	12.30	11.60		23.98	23.98	-5.70	1.30	26.99	Pass
HT20	MCS0	1	144	5720	13.40	11.60		23.98	23.98	-5.70	1.30	26.99	Pass
HT40	MCS0	1	102	5510	13.60	11.60		23.98	23.98	-5.70	1.30	26.99	Pass
HT40	MCS0	1	110	5550	13.60	11.50		23.98	23.98	-5.70	1.30	26.99	Pass
HT40	MCS0	1	134	5670	13.70	11.60		23.98	23.98	-5.70	1.30	26.99	Pass
HT40	MCS0	1	142	5710	13.40	11.60		23.98	23.98	-5.70	1.30	26.99	Pass
VHT20	MCS0	1	100	5500	13.30	11.50		23.98	23.98	-5.70	1.30	26.99	Pass
VHT20	MCS0	1	116	5580	13.50	11.40		23.98	23.98	-5.70	1.30	26.99	Pass
VHT20	MCS0	1	140	5700	12.30	11.30		23.98	23.98	-5.70	1.30	26.99	Pass
VHT20	MCS0	1	144	5720	13.40	11.50		23.98	23.98	-5.70	1.30	26.99	Pass
VHT40	MCS0	1	102	5510	13.30	11.50		23.98	23.98	-5.70	1.30	26.99	Pass
VHT40	MCS0	1	110	5550	13.30	11.40		23.98	23.98	-5.70	1.30	26.99	Pass
VHT40	MCS0	1	134	5670	13.40	11.50		23.98	23.98	-5.70	1.30	26.99	Pass
VHT40	MCS0	1	142	5710	13.50	11.50		23.98	23.98	-5.70	1.30	26.99	Pass
VHT80	MCS0	1	106	5530	13.50	11.60		23.98	23.98	-5.70	1.30	26.99	Pass
VHT80	MCS0	1	122	5610	13.70	11.70		23.98	23.98	-5.70	1.30	26.99	Pass
VHT80	MCS0	1	138	5690	13.50	11.60		23.98	23.98	-5.70	1.30	26.99	Pass



FCC Band III													
Mod.	Data Rate	NTX	CH.	Freq. (MHz)	Average Conducted Power (dBm)			FCC Conducted Power Limit (dBm)		DG (dBi)		EIRP Power Limit (dBm)	Pass/Fail
					Ant 1	Ant 2	SUM	Ant 1	Ant 2	Ant 1	Ant 2		
11a	6Mbps	2	100	5500	13.60	11.40	15.65	23.98	1.30	26.99	Pass		
11a	6Mbps	2	116	5580	13.70	11.50	15.75	23.98	1.30	26.99	Pass		
11a	6Mbps	2	140	5700	11.20	11.40	14.31	23.98	1.30	26.99	Pass		
11a	6Mbps	2	144	5720	13.40	11.70	15.64	23.98	1.30	26.99	Pass		
HT20	MCS0	2	100	5500	13.90	11.90	16.02	23.98	1.30	26.99	Pass		
HT20	MCS0	2	116	5580	13.90	11.90	16.02	23.98	1.30	26.99	Pass		
HT20	MCS0	2	140	5700	12.10	11.40	14.77	23.98	1.30	26.99	Pass		
HT20	MCS0	2	144	5720	13.40	11.70	15.64	23.98	1.30	26.99	Pass		
HT40	MCS0	2	102	5510	13.70	11.80	15.86	23.98	1.30	26.99	Pass		
HT40	MCS0	2	110	5550	13.60	11.50	15.69	23.98	1.30	26.99	Pass		
HT40	MCS0	2	134	5670	13.80	11.60	15.85	23.98	1.30	26.99	Pass		
HT40	MCS0	2	142	5710	13.40	11.60	15.60	23.98	1.30	26.99	Pass		
VHT20	MCS0	2	100	5500	13.60	11.70	15.76	23.98	1.30	26.99	Pass		
VHT20	MCS0	2	116	5580	13.70	11.60	15.79	23.98	1.30	26.99	Pass		
VHT20	MCS0	2	140	5700	11.80	11.50	14.66	23.98	1.30	26.99	Pass		
VHT20	MCS0	2	144	5720	13.20	10.70	15.14	23.98	1.30	26.99	Pass		
VHT40	MCS0	2	102	5510	13.70	11.60	15.79	23.98	1.30	26.99	Pass		
VHT40	MCS0	2	110	5550	13.70	11.20	15.64	23.98	1.30	26.99	Pass		
VHT40	MCS0	2	134	5670	13.70	11.60	15.79	23.98	1.30	26.99	Pass		
VHT40	MCS0	2	142	5710	13.30	11.50	15.50	23.98	1.30	26.99	Pass		
VHT80	MCS0	2	106	5530	13.80	11.80	15.92	23.98	1.30	26.99	Pass		
VHT80	MCS0	2	122	5610	13.70	11.70	15.82	23.98	1.30	26.99	Pass		
VHT80	MCS0	2	138	5690	13.40	11.60	15.60	23.98	1.30	26.99	Pass		



## Appendix B. Radiated Spurious Emission

Test Engineer :	Alex Jheng, JC Liang, Wiolson Wu	Temperature :	24.5~24.6°C
		Relative Humidity :	50~51%

### Band 1 - 5150~5250MHz

#### WIFI 802.11n HT40 (Band Edge @ 3m)

WIFI Ant. 1+2	Note	Frequency ( MHz )	Level ( dBμV/m )	Over Limit ( dB )	Limit Line ( dBμV/m )	Read Level ( dBμV )	Antenna Factor ( dB/m )	Path Loss ( dB )	Preamp Factor ( dB )	Ant Pos ( cm )	Table Pos ( deg )	Peak Avg. ( P/A )	Pol. ( H/V )
802.11n HT40 CH 46 5230MHz		5132.6	49.92	-24.08	74	41.65	31.68	6.07	29.48	140	346	P	H
		5102.18	40.47	-13.53	54	32.23	31.66	6.06	29.48	140	346	A	H
	*	5230	98.97	-	-	90.62	31.74	6.11	29.5	140	346	P	H
	*	5230	90.76	-	-	82.41	31.74	6.11	29.5	140	346	A	H
		5354.72	49.08	-24.92	74	40.67	31.81	6.12	29.52	140	346	P	H
		5453.56	39.86	-14.14	54	31.36	31.87	6.17	29.54	140	346	A	H
		5017.94	49.6	-24.4	74	41.44	31.61	6.01	29.46	166	341	P	V
		5149.5	40.53	-13.47	54	32.25	31.69	6.08	29.49	166	341	A	V
	*	5230	99.01	-	-	90.66	31.74	6.11	29.5	166	341	P	V
	*	5230	91.13	-	-	82.78	31.74	6.11	29.5	166	341	A	V
		5387.76	48.07	-25.93	74	39.65	31.83	6.12	29.53	166	341	P	V
	5452.72	39.92	-14.08	54	31.42	31.87	6.17	29.54	166	341	A	V	
Remark	1. No other spurious found. 2. All results are PASS against Peak and Average limit line.												



**Band 1 5150~5250MHz  
WIFI 802.11n HT40 (Harmonic @ 3m)**

WIFI Ant. 1+2	Note	Frequency ( MHz )	Level ( dBμV/m )	Over Limit ( dB )	Limit Line ( dBμV/m )	Read Level (dBμV)	Antenna Factor ( dB/m )	Path Loss ( dB )	Preamp Factor ( dB )	Ant Pos ( cm )	Table Pos ( deg )	Peak Avg. (P/A)	Pol. (H/V)	
802.11n HT40 CH 46 5230MHz		10460	47.77	-20.43	68.2	54.82	39.91	9.96	56.92	100	0	P	H	
		15690	43.82	-30.18	74	49.33	38.24	12.72	56.47	100	0	P	H	
													H	
													H	
			10460	46.38	-21.82	68.2	53.43	39.91	9.96	56.92	100	0	P	V
			15690	44.09	-29.91	74	49.6	38.24	12.72	56.47	100	0	P	V
														V
														V
<b>Remark</b>	1. No other spurious found. 2. All results are PASS against Peak and Average limit line.													



**Band 2 - 5250~5350MHz**

**WIFI 802.11ac VHT80 (Band Edge @ 3m)**

WIFI	Note	Frequency	Level	Over	Limit	Read	Antenna	Path	Preamp	Ant	Table	Peak	Pol.
Ant.				Limit	Line	Level	Factor	Loss	Factor	Pos	Pos	Avg.	
1+2		( MHz )	( dBμV/m )	( dB )	( dBμV/m )	( dBμV )	( dB/m )	( dB )	( dB )	( cm )	( deg )	( P/A )	( H/V )
<b>802.11ac VHT80 CH 58 5290MHz</b>		5028.56	48.89	-25.11	74	40.72	31.62	6.02	29.47	133	336	P	H
		5111.52	40.88	-13.12	54	32.63	31.67	6.06	29.48	133	336	A	H
	*	5290	98.78	-	-	90.41	31.77	6.11	29.51	133	336	P	H
	*	5290	90.11	-	-	81.74	31.77	6.11	29.51	133	336	A	H
		5355.36	62.95	-11.05	74	54.54	31.81	6.12	29.52	133	336	P	H
		5350.08	50.8	-3.2	54	42.39	31.81	6.12	29.52	133	336	A	H
		5101.32	48.97	-25.03	74	40.73	31.66	6.06	29.48	182	334	P	V
		5028.22	40.92	-13.08	54	32.75	31.62	6.02	29.47	182	334	A	V
	*	5290	98.1	-	-	89.73	31.77	6.11	29.51	182	334	P	V
	*	5290	88.98	-	-	80.61	31.77	6.11	29.51	182	334	A	V
		5387.04	60.18	-13.82	74	51.76	31.83	6.12	29.53	182	334	P	V
	5351.28	50.7	-3.3	54	42.29	31.81	6.12	29.52	182	334	P	V	
<b>Remark</b>	1. No other spurious found. 2. All results are PASS against Peak and Average limit line.												



**Band 2 5250~5350MHz  
WIFI 802.11ac VHT80 (Harmonic @ 3m)**

WIFI Ant. 1+2	Note	Frequency ( MHz )	Level ( dBμV/m )	Over Limit ( dB )	Limit Line ( dBμV/m )	Read Level (dBμV)	Antenna Factor ( dB/m )	Path Loss ( dB )	Preamp Factor ( dB )	Ant Pos ( cm )	Table Pos ( deg )	Peak Avg. (P/A)	Pol. (H/V)	
802.11ac VHT80 CH 58 5290MHz		10580	46.57	-21.63	68.2	53.29	40.09	10.03	56.84	100	0	P	H	
		15870	44.8	-29.2	74	50.45	37.79	12.82	56.26	100	0	P	H	
													H	
													H	
			10580	46.85	-21.35	68.2	53.57	40.09	10.03	56.84	100	0	P	V
			15870	44.35	-29.65	74	50	37.79	12.82	56.26	100	0	P	V
														V
														V
<b>Remark</b>	1. No other spurious found. 2. All results are PASS against Peak and Average limit line.													



Band 3 - 5470~5725MHz

WIFI 802.11n HT20 (Band Edge @ 3m)

WIFI	Note	Frequency	Level	Over	Limit	Read	Antenna	Path	Preamp	Ant	Table	Peak	Pol.
Ant.				Limit	Line	Level	Factor	Loss	Factor	Pos	Pos	Avg.	
1+2		( MHz )	( dBμV/m )	( dB )	( dBμV/m )	( dBμV )	( dB/m )	( dB )	( dB )	( cm )	( deg )	( P/A )	( H/V )
802.11n HT20 CH 140 5700MHz	*	5700	105.95	-	-	96.97	32.17	6.36	29.55	113	9	P	H
	*	5700	96.61	-	-	87.63	32.17	6.36	29.55	113	9	A	H
		5726.6	62.05	-6.15	68.2	53.02	32.21	6.37	29.55	113	9	P	H
													H
													H
													H
	*	5700	99.42	-	-	90.44	32.17	6.36	29.55	231	311	P	V
	*	5700	90.53	-	-	81.55	32.17	6.36	29.55	231	311	A	V
		5726.68	54.82	-13.38	68.2	45.79	32.21	6.37	29.55	231	311	P	V
													V
												V	
												V	
<b>Remark</b>	1. No other spurious found. 2. All results are PASS against Peak and Average limit line.												



**Band 3 - 5470~5725MHz  
WIFI 802.11n HT20 (Harmonic @ 3m)**

WIFI Ant. 1+2	Note	Frequency ( MHz )	Level ( dBμV/m )	Over Limit ( dB )	Limit Line ( dBμV/m )	Read Level (dBμV)	Antenna Factor ( dB/m )	Path Loss ( dB )	Preamp Factor ( dB )	Ant Pos ( cm )	Table Pos ( deg )	Peak Avg. (P/A)	Pol. (H/V)	
802.11n HT20 CH 140 5700MHz		11400	46.34	-27.66	74	52.24	40.02	10.42	56.34	100	0	P	H	
		17100	47.67	-20.53	68.2	50.81	40.36	12.8	56.3	100	0	P	H	
													H	
													H	
			11400	46.78	-27.22	74	52.68	40.02	10.42	56.34	100	0	P	V
			17100	48.02	-20.18	68.2	51.16	40.36	12.8	56.3	100	0	P	V
														V
														V
<b>Remark</b>	1. No other spurious found. 2. All results are PASS against Peak and Average limit line.													



Emission below 1GHz  
WIFI 802.11ac VHT80 (LF @ 3m)

WIFI	Note	Frequency	Level	Over	Limit	Read	Antenna	Path	Preamp	Ant	Table	Peak	Pol.	
Ant.				Limit	Line	Level	Factor	Loss	Factor	Pos	Pos	Avg.		
1+2		( MHz )	( dBμV/m )	( dB )	( dBμV/m )	( dBμV )	( dB/m )	( dB )	( dB )	( cm )	( deg )	( P/A )	( H/V )	
802.11ac VHT80 LF		30	23.95	-16.05	40	31.61	24.17	0.46	32.29			P	H	
		101.78	27.04	-16.46	43.5	42.31	16.09	0.85	32.21			P	H	
		155.13	25.88	-17.62	43.5	40.04	16.94	1.07	32.17			P	H	
		179.38	26.69	-16.81	43.5	42.61	15.06	1.17	32.15			P	H	
		838.98	32.01	-13.99	46	32.27	28.86	2.58	31.7			P	H	
		955.38	33.74	-12.26	46	31.3	30.71	2.67	30.94	100	0	P	H	
													H	
													H	
													H	
													H	
													H	
													H	
													H	
			40.67	33.4	-6.6	40	46.3	18.87	0.52	32.29	100	0	P	V
			70.74	23.97	-16.03	40	43.3	12.27	0.66	32.26			P	V
			104.69	28.9	-14.6	43.5	43.73	16.52	0.86	32.21			P	V
			179.38	25.79	-17.71	43.5	41.71	15.06	1.17	32.15			P	V
			806.97	31.32	-14.68	46	32.63	28.09	2.46	31.86			P	V
			949.56	33.41	-12.59	46	31.22	30.52	2.66	30.99			P	V
													V	
												V		
												V		
												V		
												V		
												V		
												V		
<b>Remark</b>	1. No other spurious found. 2. All results are PASS against limit line.													





**Note symbol**

*	<b>Fundamental Frequency</b> which can be ignored. However, the level of any unwanted emissions shall not exceed the level of the fundamental frequency.
!	Test result is <b>over limit</b> line.
P/A	<b>Peak</b> or <b>Average</b>
H/V	<b>Horizontal</b> or <b>Vertical</b>



A calculation example for radiated spurious emission is shown as below:

WIFI	Note	Frequency	Level	Over	Limit	Read	Antenna	Path	Preamp	Ant	Table	Peak	Pol.
Ant.				Limit	Line	Level	Factor	Loss	Factor	Pos	Pos	Avg.	
1+2		( MHz )	( dBμV/m )	( dB )	( dBμV/m )	( dBμV )	( dB/m )	( dB )	( dB )	( cm )	( deg )	( P/A )	( H/V )
802.11b		2390	55.45	-18.55	74	54.51	32.22	4.58	35.86	103	308	P	H
CH 01													
2412MHz		2390	43.54	-10.46	54	42.6	32.22	4.58	35.86	103	308	A	H

1. Path Loss(dB) = Cable loss(dB) + Filter loss(dB) + Attenuator loss(dB)
2. Level(dBμV/m) = Antenna Factor(dB/m) + Path Loss(dB) + Read Level(dBμV) - Preamp Factor(dB)
3. Over Limit(dB) = Level(dBμV/m) – Limit Line(dBμV/m)

**For Peak Limit @ 2390MHz:**

1. Level(dBμV/m)  
= Antenna Factor(dB/m) + Path Loss(dB) + Read Level(dBμV) - Preamp Factor(dB)  
= 32.22(dB/m) + 4.58(dB) + 54.51(dBμV) – 35.86 (dB)  
= 55.45 (dBμV/m)
2. Over Limit(dB)  
= Level(dBμV/m) – Limit Line(dBμV/m)  
= 55.45(dBμV/m) – 74(dBμV/m)  
= -18.55(dB)

**For Average Limit @ 2390MHz:**

1. Level(dBμV/m)  
= Antenna Factor(dB/m) + Path Loss(dB) + Read Level(dBμV) - Preamp Factor(dB)  
= 32.22(dB/m) + 4.58(dB) + 42.6(dBμV) – 35.86 (dB)  
= 43.54 (dBμV/m)
2. Over Limit(dB) = Level(dBμV/m) – Limit Line(dBμV/m)  
= 43.54(dBμV/m) – 54(dBμV/m)  
= -10.46(dB)

**Both peak and average measured complies with the limit line, so test result is “PASS”.**



## Appendix C. Radiated Spurious Emission

Test Engineer :	Alex Jheng, JC Liang, Wilson Wu	Temperature :	24.5~24.6°C
		Relative Humidity :	50~51%

### Note symbol

-L	Low channel location
-R	High channel location



**Band 1 - 5150~5250MHz**  
**WIFI 802.11n HT40 (Band Edge @ 3m)**

WIFI	Band 1 5150~5250MHz Band Edge @ 3m	
ANT	802.11n HT40 CH46 5230MHz - L	
1+2	Horizontal	Fundamental
<b>Peak</b>	<p>Site : 03CH13-HY            Condition : PEAK_BE_74 3m HORN_91200_1241 HORIZONTAL            Detector : Peak            Project : 802421-03            Mode : 1            Power : 0x1E</p>	<p>Site : 03CH13-HY            Condition : PEAK(LINE) 3m HORN_91200_1241 HORIZONTAL            Detector : Peak            Project : 802421-03            Mode : 1            Power : 0x1E</p>
<b>Avg.</b>	<p>Site : 03CH13-HY            Condition : AV6_BE_54 3m HORN_91200_1241 HORIZONTAL            Detector : Peak            Project : 802421-03            Mode : 1            Power : 0x1E</p>	Left blank

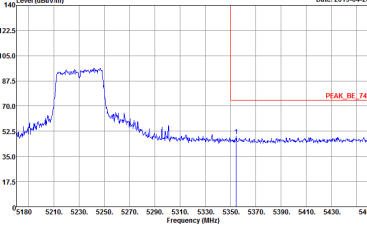
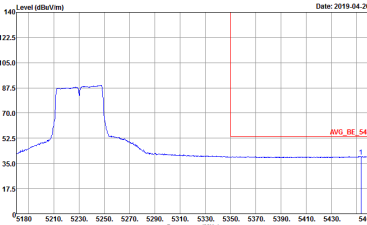

WIFI	Band 1 5150~5250MHz Band Edge @ 3m	
ANT	802.11n HT40 CH46 5230MHz - R	
1+2	Horizontal	Fundamental
<p><b>Peak</b></p>	 <p>Site : 03CH13-HY            Condition : PEAK_BE_74 3m HORN_91200_1241 HORIZONTAL            Detector : Peak            Project : 802421-03            Mode : 1            Power : 0x1E</p>	<p>Left blank</p>
<p><b>Avg.</b></p>	 <p>Site : 03CH13-HY            Condition : AVG_BE_54 3m HORN_91200_1241 HORIZONTAL            Detector : Peak            Project : 802421-03            Mode : 1            Power : 0x1E</p>	<p>Left blank</p>

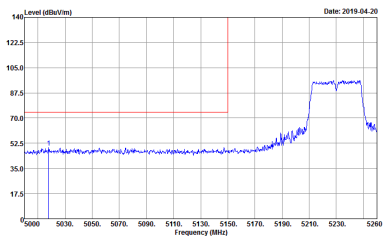
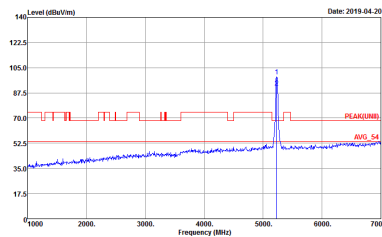
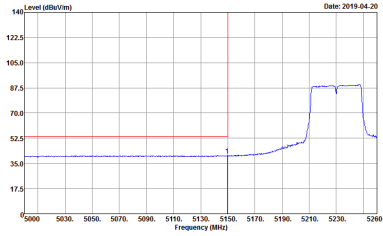

WIFI	Band 1 5150~5250MHz Band Edge @ 3m	
ANT	802.11n HT40 CH46 5230MHz - L	
1+2	Vertical	Fundamental
Peak	 <p>Site : 03CH13-HY          Condition : PEAK_BE_74 3m HORN_91200_1241 VERTICAL          Detector : Peak          Project : 802421-03          Mode : 1          Power : 0x1E</p>	 <p>Site : 03CH13-HY          Condition : PEAK(LINII) 3m HORN_91200_1241 VERTICAL          Detector : Peak          Project : 802421-03          Mode : 1          Power : 0x1E</p>
Avg.	 <p>Site : 03CH13-HY          Condition : AVG_BE_54 3m HORN_91200_1241 VERTICAL          Detector : Peak          Project : 802421-03          Mode : 1          Power : 0x1E</p>	Left blank

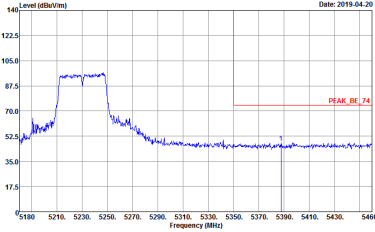
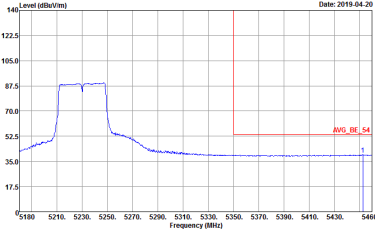

WIFI	Band 1 5150~5250MHz Band Edge @ 3m	
ANT	802.11n HT40 CH46 5230MHz - R	
1+2	Vertical	Fundamental
<p><b>Peak</b></p>	 <p>Site : 03CH13-HY            Condition : PEAK_BE_74 3m HORN_9120D_1241 VERTICAL            Detector : Peak            Project : 802421-03            Mode : 1            Power : 0x1E</p>	<p>Left blank</p>
<p><b>Avg.</b></p>	 <p>Site : 03CH13-HY            Condition : AVG_BE_54 3m HORN_9120D_1241 VERTICAL            Detector : Peak            Project : 802421-03            Mode : 1            Power : 0x1E</p>	<p>Left blank</p>



**Band 1 - 5150~5250MHz**  
**WIFI 802.11n HT40 (Harmonic @ 3m)**

<b>WIFI</b>	<b>Band 1 5150~5250MHz Harmonic @ 3m</b>	
<b>ANT</b>	<b>802.11n HT40 CH46 5230MHz</b>	
<b>1+2</b>	<b>Horizontal</b>	<b>Vertical</b>
<b>Peak</b> <b>Avg.</b>		





**Band 2 - 5250~5350MHz**  
**WIFI 802.11ac VHT80 (Band Edge @ 3m)**

WIFI	Band 2 5250~5350MHz Band Edge @ 3m	
ANT	802.11ac VHT80 CH58 5290MHz - L	
1+2	Horizontal	Fundamental
<b>Peak</b>	<p>Site : 03CH13-HY            Condition : PEAK_BE_74 3m HORN_91200_1241 HORIZONTAL            RBW:1000.000KHz VBW:3000.000KHz SWT:Auto            Detector : Peak            Project : 802421-03            Mode : 2            Power : 0x1F</p>	<p>Site : 03CH13-HY            Condition : PEAK(LINE) 3m HORN_91200_1241 HORIZONTAL            RBW:1000.000KHz VBW:3000.000KHz SWT:Auto            Detector : Peak            Project : 802421-03            Mode : 2            Power : 0x1F</p>
<b>Avg.</b>	<p>Site : 03CH13-HY            Condition : AV6_BE_54 3m HORN_91200_1241 HORIZONTAL            RBW:1000.000KHz VBW:3.000KHz SWT:Auto            Detector : Peak            Project : 802421-03            Mode : 2            Power : 0x1F</p>	Left blank

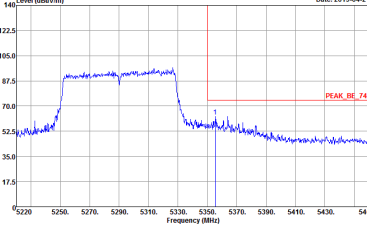
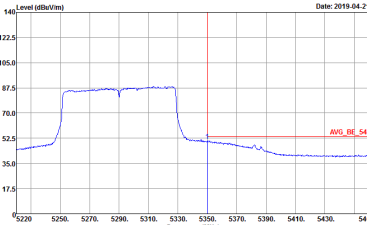

WIFI	Band 2 5250~5350MHz Band Edge @ 3m	
ANT	802.11ac VHT80 CH58 5290MHz - R	
1+2	Horizontal	Fundamental
<p><b>Peak</b></p>	 <p>Site : 03CH13-HY            Condition : PEAK_BE_74 3m HORN_91200_1241 HORIZONTAL            Detector : Peak            Project : 802421-03            Mode : 2            Power : 0x1F</p>	<p>Left blank</p>
<p><b>Avg.</b></p>	 <p>Site : 03CH13-HY            Condition : AVG_BE_54 3m HORN_91200_1241 HORIZONTAL            Detector : Peak            Project : 802421-03            Mode : 2            Power : 0x1F</p>	<p>Left blank</p>

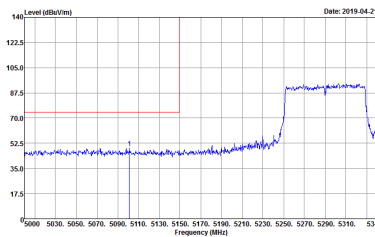
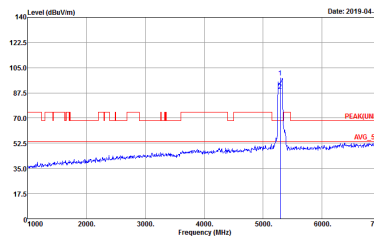
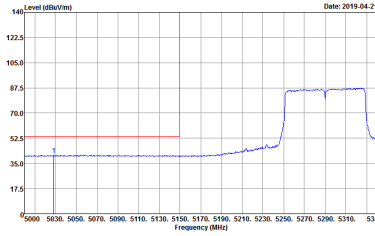

WIFI	Band 2 5250~5350MHz Band Edge @ 3m	
ANT	802.11ac VHT80 CH58 5290MHz - L	
1+2	Vertical	Fundamental
<p><b>Peak</b></p>	 <p>Date: 2019-04-21</p> <p>Site : 03CH13-HY            Condition : PEAK_BE_74 3m HORN_91200_1241 VERTICAL            RBW:1000.000KHz VBW:3000.000KHz SWT:Auto            Detector : Peak            Project : 802421-03            Mode : 2            Power : 0x1F</p>	 <p>Date: 2019-04-21</p> <p>Site : 03CH13-HY            Condition : PEAK(LINB) 3m HORN_91200_1241 VERTICAL            RBW:1000.000KHz VBW:3000.000KHz SWT:Auto            Detector : Peak            Project : 802421-03            Mode : 2            Power : 0x1F</p>
<p><b>Avg.</b></p>	 <p>Date: 2019-04-21</p> <p>Site : 03CH13-HY            Condition : AVG_BE_54 3m HORN_91200_1241 VERTICAL            RBW:1000.000KHz VBW:3000.000KHz SWT:Auto            Detector : Peak            Project : 802421-03            Mode : 2            Power : 0x1F</p>	<p><b>Left blank</b></p>

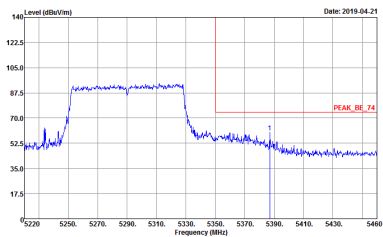
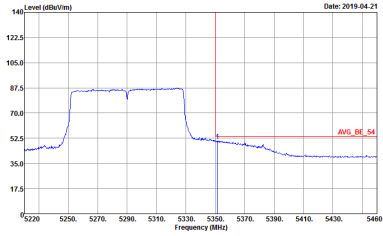

WIFI	Band 2 5250~5350MHz Band Edge @ 3m	
ANT	802.11ac VHT80 CH58 5290MHz - R	
1+2	Vertical	Fundamental
<p><b>Peak</b></p>	 <p>Site : 03CH13-HY            Condition : PEAK_BE_74 3m HORN_91200_1241 VERTICAL            Detector : Peak            Project : 802421-03            Mode : 2            Power : 0x1F</p>	<p>Left blank</p>
<p><b>Avg.</b></p>	 <p>Site : 03CH13-HY            Condition : AVG_BE_54 3m HORN_91200_1241 VERTICAL            Detector : Peak            Project : 802421-03            Mode : 2            Power : 0x1F</p>	<p>Left blank</p>



Band 2 - 5250~5350MHz
WIFI 802.11ac VHT80 (Harmonic @ 3m)

Table with 2 columns: Horizontal and Vertical. Each column contains a spectral plot of Level (dBV/m) vs Frequency (MHz) with technical details like Site, Condition, Detector, Project, Mode, and Power.



**Band 3 - 5470~5725MHz**  
**WIFI 802.11n HT20 (Band Edge @ 3m)**

<b>WIFI</b>	<b>Band 3 5470~5725MHz Band Edge @ 3m</b>	
<b>ANT</b>	<b>802.11n HT20 CH140 5700MHz</b>	
<b>1+2</b>	<b>Horizontal</b>	<b>Fundamental</b>
<b>Peak</b>	<p>Site : 03CH13-HY          Condition : PEAK_BE(LINE)_B3 3m HORN_91200_1241 HORIZONTAL          Detector : Peak          Project : 802421-03          Mode : 3          Power : 0x1F</p>	<p>Site : 03CH13-HY          Condition : PEAK(LINE) 3m HORN_91200_1241 HORIZONTAL          Detector : Peak          Project : 802421-03          Mode : 3          Power : 0x1F</p>



WIFI	Band 3 5470~5725MHz Band Edge @ 3m	
ANT	802.11n HT20 CH140 5700MHz	
1+2	Vertical	Fundamental
<b>Peak.</b>	<p>Site : 03CH13-11Y Condition : PEAK_BE[UNII], B3 3m HORN_91200_1241 VERTICAL Detector : Peak Project : 802421-03 Mode : 3 Power : 0x1F</p>	<p>Site : 03CH13-11Y Condition : PEAK[UNII] 3m HORN_91200_1241 VERTICAL Detector : Peak Project : 802421-03 Mode : 3 Power : 0x1F</p>



**Band 3 - 5470~5725MHz**  
**WIFI 802.11n HT20 (Harmonic @ 3m)**

<b>WIFI</b>	<b>Band 3 5470~5725MHz Harmonic @ 3m</b>	
<b>ANT</b>	<b>802.11n HT20 CH140 5700MHz</b>	
<b>1+2</b>	<b>Horizontal</b>	<b>Vertical</b>
<b>Peak</b> <b>Avg.</b>	<p>Site : 03CH13-HY          Condition : PEAQ(UNIT) 3m HORN_91200_1241 HORIZONTAL          Detector : Peak          Project : 802421-03          Mode : 3          Power : 0x1F</p>	<p>Site : 03CH13-HY          Condition : PEAQ(UNIT) 3m HORN_91200_1241 VERTICAL          Detector : Peak          Project : 802421-03          Mode : 3          Power : 0x1F</p>





Emission below 1GHz  
5GHz WIFI 802.11ac VHT80 (LF)

WIFI	5GHz WIFI	
ANT	802.11ac VHT80 LF	
1+2	Horizontal	Vertical
QP / Peak	<p>Site : 03CH13-HY Condition : 1 QP 3m BIL06_37059401 HORIZONTAL Detector : Peak Project : 802421-03 Mode : 4</p>	<p>Site : 03CH13-HY Condition : 1 QP 3m BIL06_37059401 VERTICAL Detector : Peak Project : 802421-03 Mode : 4</p>



### Appendix D. Duty Cycle Plots

Antenna	Band	Duty Cycle(%)	T(us)	1/T(kHz)	VBW Setting	Duty Factor(dB)
1+2	5GHz 802.11n HT20 for Ant. 1	97.10	2010	0.50	1kHz	0.13
1+2	5GHz 802.11n HT20 for Ant. 2	97.34	2015	0.50	1kHz	0.12
1+2	5GHz 802.11n HT40 for Ant. 1	96.09	1230	0.81	1kHz	0.17
1+2	5GHz 802.11n HT40 for Ant. 2	97.24	1235	0.81	1kHz	0.12
1+2	5GHz 802.11ac VHT80 for Ant. 1	93.65	590	1.69	3kHz	0.29
1+2	5GHz 802.11ac VHT80 for Ant. 2	92.06	580	1.72	3kHz	0.36



MIMO <Ant. 1>

802.11n HT20

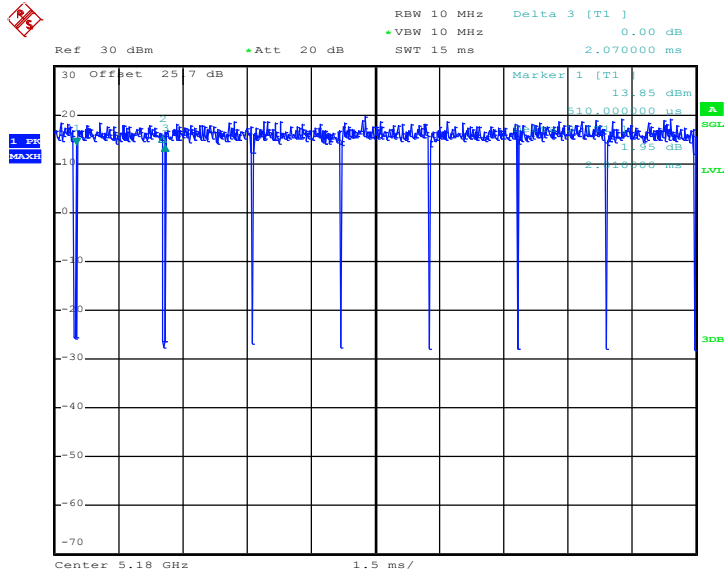

Date: 15.APR.2019 13:39:39

802.11n HT40

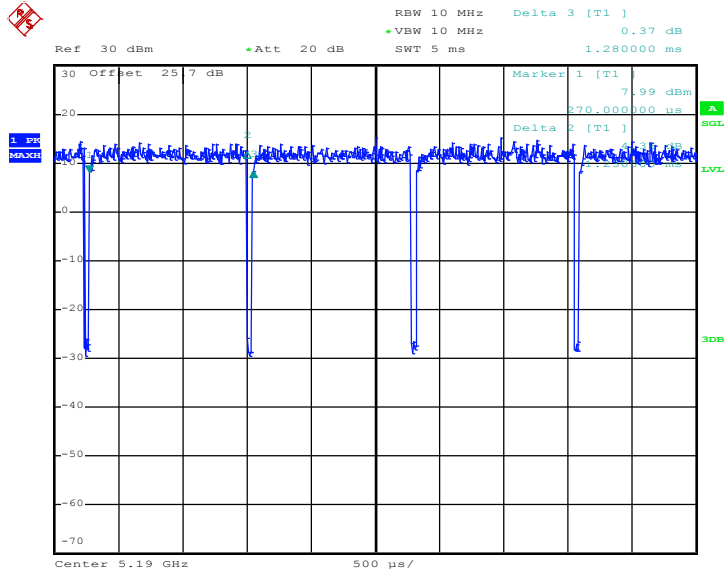

Date: 16.APR.2019 13:04:14



802.11ac VHT80

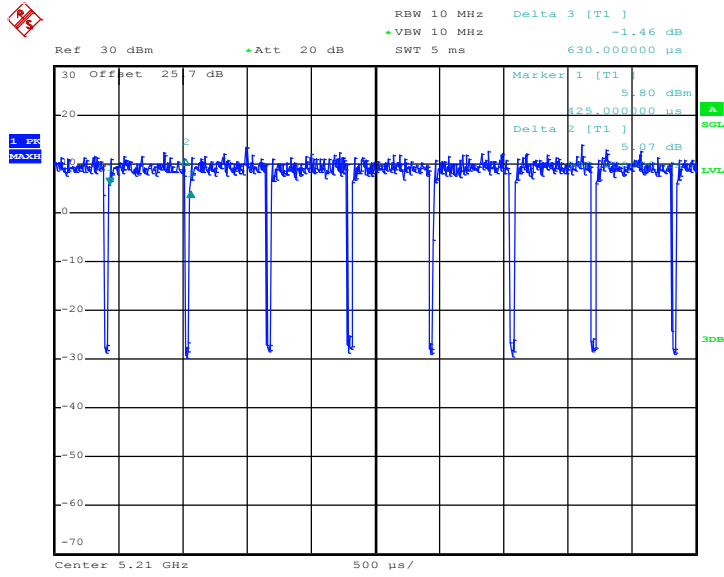

Date: 16.APR.2019 17:02:24

MIMO <Ant. 2>

802.11n HT20

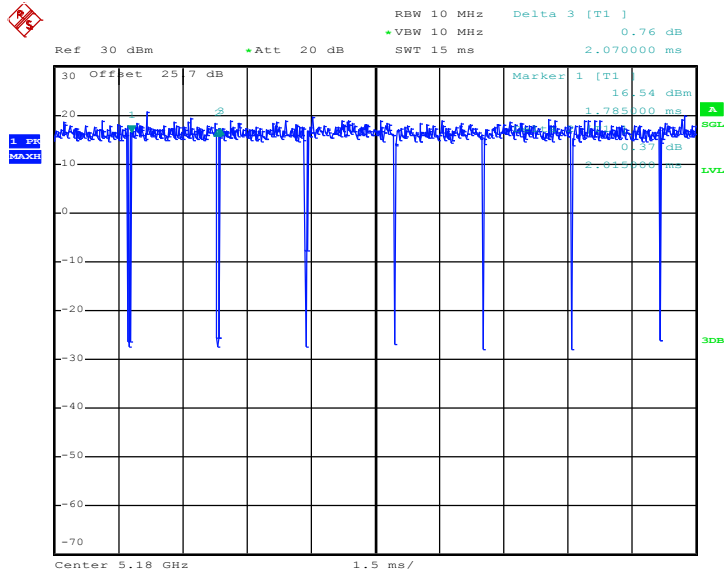

Date: 15.APR.2019 13:40:20



802.11n HT40

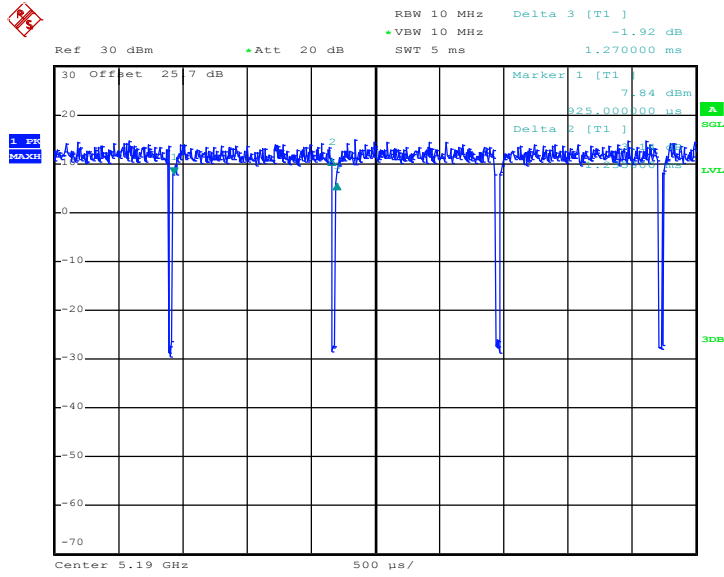

Date: 16.APR.2019 13:04:57

802.11ac VHT80

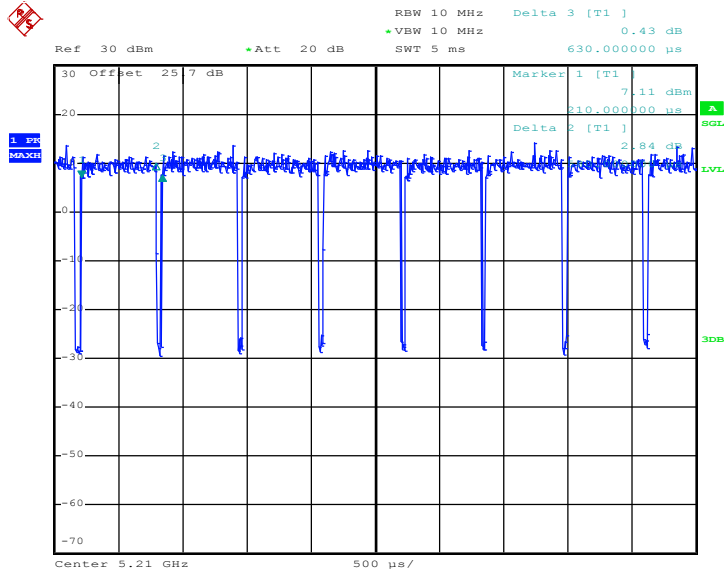

Date: 16.APR.2019 17:06:47

—THE END—