



FCC RADIO TEST REPORT

FCC ID : PY7-24117P
Equipment : GSM/WCDMA/LTE Phone with BT, DTS/UNII
a/b/g/n/ac, GPS and NFC
Brand Name : Sony
Applicant : Sony Mobile Communications Inc.
4-12-3 Higashi-Shinagawa, Shinagawa-ku,
Tokyo, 140-0002, Japan
Manufacturer : Sony Mobile Communications Inc.
4-12-3 Higashi-Shinagawa, Shinagawa-ku,
Tokyo, 140-0002, Japan
Standard : FCC Part 15 Subpart E §15.407

The product was received on Nov. 01, 2018 and testing was started from Feb. 04, 2019 and completed on Mar. 09, 2019. We, SPORTON INTERNATIONAL INC. EMC & Wireless Communications Laboratory, would like to declare that the tested sample has been evaluated in accordance with the test procedures and has been in compliance with the applicable technical standards.

The report must not be used by the client to claim product certification, approval, or endorsement by TAF or any agency of government.

The test results in this report apply exclusively to the tested model / sample. Without written approval of SPORTON INTERNATIONAL INC. EMC & Wireless Communications Laboratory, the test report shall not be reproduced except in full.

Approved by: Jones Tsai

SPORTON INTERNATIONAL INC. EMC & Wireless Communications Laboratory

No. 52, Huaya 1st Rd., Guishan Dist., Taoyuan City, Taiwan (R.O.C.)



Table of Contents

History of this test report3

Summary of Test Result4

1 General Description.....5

 1.1 Product Feature of Equipment Under Test5

 1.2 Modification of EUT5

 1.3 Testing Location6

 1.4 Applicable Standards6

2 Test Configuration of Equipment Under Test.....7

 2.1 Carrier Frequency and Channel.....7

 2.2 Test Mode.....8

 2.3 Connection Diagram of Test System10

 2.4 Support Unit used in test configuration and system.....11

 2.5 EUT Operation Test Setup11

 2.6 Measurement Results Explanation Example11

3 Test Result.....12

 3.1 26dB & 99% Occupied Bandwidth Measurement12

 3.2 Maximum Conducted Output Power Measurement14

 3.3 Power Spectral Density Measurement.....16

 3.4 Unwanted Emissions Measurement.....18

 3.5 AC Conducted Emission Measurement23

 3.6 Automatically Discontinue Transmission.....25

 3.7 Antenna Requirements.....27

4 List of Measuring Equipment28

5 Uncertainty of Evaluation.....30

Appendix A. Conducted Test Results

Appendix B. AC Conducted Emission Test Result

Appendix C. Radiated Spurious Emission

Appendix D. Radiated Spurious Emission Plots

Appendix E. Duty Cycle Plots



Summary of Test Result

Report Clause	Ref Std. Clause	Test Items	Result (PASS/FAIL)	Remark
3.1	15.403(i)	26dB Bandwidth	Pass	-
3.1	2.1049	99% Occupied Bandwidth	Reporting only	-
3.2	15.407(a)	Maximum Conducted Output Power	Pass	-
3.3	15.407(a)	Power Spectral Density	Pass	-
3.4	15.407(b)	Unwanted Emissions	Pass	Under limit 3.55 dB at 5725.960 MHz
3.5	15.207	AC Conducted Emission	Pass	Under limit 9.90 dB at 0.564 MHz
3.6	15.407(c)	Automatically Discontinue Transmission	Pass	-
3.7	15.203 15.407(a)	Antenna Requirement	Pass	-

Declaration of Conformity:

The test results with all measurement uncertainty excluded are presented in accordance with the regulation limits or requirements declared by manufacturers.

Comments and Explanations:

The declared of product specification for EUT presented in the report are provided by the manufacturer, and the manufacturer takes all the responsibilities for the accuracy of product specification.

Reviewed by: Wii Chang

Report Producer: Natasha Hsieh



1 General Description

1.1 Product Feature of Equipment Under Test

GSM/WCDMA/LTE, Bluetooth, DTS/UNII a/b/g/n/ac, NFC, and GNSS.

Standards-related Product Specification	
Antenna Type / Gain	<Ant. 1>: Loop Antenna <Ant. 2>: Monopole Antenna
Antenna Gain	<5150 MHz ~ 5250 MHz> <Ant. 1>: -5.7 dBi <Ant. 2>: -7.3 dBi <5250 MHz ~ 5350 MHz> <Ant. 1>: -5.3 dBi <Ant. 2>: -4.9 dBi <5470 MHz ~ 5725 MHz> <Ant. 1>: -5.7 dBi <Ant. 2>: 1.3 dBi

EUT Information List			
HW Version	SW Version	S/N	Performed Test Item
A	1.63	BH97006BFU	RF conducted measurement
		BH9700K3FU	Radiated Spurious Emission
		BH97006GFR	AC Conducted Emission

Accessory List	
AC Adapter	Model Name : UCH32
	S/N: 6218W30200106 (for radiated emission) 6218W30200197 (for conducted emission)
Earphone	Model No.: MH750
	S/N : N/A
USB Cable	Model No.: UCB24
	S/N : N/A
2 in 1 USB Audio Cable	Model No.: EC270
	S/N : N/A

Note:

1. Above EUT list used are electrically identical per declared by manufacturer.
2. Above the accessories list are used to exercise the EUT during test, and the serial number of each type of accessories is listed in each section of this report. .
3. For other wireless features of this EUT, test report will be issued separately.
4. The antenna 1 and antenna 2 in this test report are equivalent to WLAN chain 0 and chain 1 in Antenna Specification by manufacturer.

1.2 Modification of EUT

No modifications are made to the EUT during all test items.



1.3 Testing Location

Test Site	SPORTON INTERNATIONAL INC.	
Test Site Location	No.52, Huaya 1st Rd., Guishan Dist., Taoyuan City, Taiwan (R.O.C.) TEL: +886-3-327-3456 FAX: +886-3-328-4978	
Test Site No.	Sporton Site No.	
	TH05-HY	CO05-HY

Note: The test site complies with ANSI C63.4 2014 requirement.

Test Site	SPORTON INTERNATIONAL INC.	
Test Site Location	No.58, Aly. 75, Ln. 564, Wenhua 3rd, Rd., Guishan Dist., Taoyuan City, Taiwan (R.O.C.) TEL: +886-3-327-0868 FAX: +886-3-327-0855	
Test Site No.	Sporton Site No.	
	03CH13-HY	

Note: The test site complies with ANSI C63.4 2014 requirement.

FCC Designation No.: TW1190 and TW0007

1.4 Applicable Standards

According to the specifications of the manufacturer, the EUT must comply with the requirements of the following standards:

- ♦ FCC Part 15 Subpart E
- ♦ FCC KDB 789033 D02 General UNII Test Procedures New Rules v02r01.
- ♦ FCC KDB 414788 D01 Radiated Test Site v01r01.
- ♦ FCC KDB 662911 D01 Multiple Transmitter Output v02r01.
- ♦ ANSI C63.10-2013

Remark:

1. All test items were verified and recorded according to the standards and without any deviation during the test.
2. This EUT has also been tested and complied with the requirements of FCC Part 15, Subpart B, recorded in a separate test report.



2 Test Configuration of Equipment Under Test

- a. The EUT has been associated with peripherals and configuration operated in a manner tended to maximize its emission characteristics in a typical application. Frequency range investigated: conduction emission (150 kHz to 30 MHz), radiation emission (9 kHz to the 10th harmonic of the highest fundamental frequency or to 40 GHz, whichever is lower). For radiated measurement, pre-scanned in three orthogonal panels, X, Y, Z. The worst cases (Y plane) were recorded in this report.
- b. AC power line Conducted Emission was tested under maximum output power.

2.1 Carrier Frequency and Channel

Frequency Band	Channel	Freq. (MHz)	Channel	Freq. (MHz)
5150-5250 MHz Band 1 (U-NII-1)	36	5180	44	5220
	38*	5190	46*	5230
	40	5200	48	5240
	42 [#]	5210		

Frequency Band	Channel	Freq. (MHz)	Channel	Freq. (MHz)
5250-5350 MHz Band 2 (U-NII-2A)	52	5260	60	5300
	54*	5270	62*	5310
	56	5280	64	5320
	58 [#]	5290		

Frequency Band	Channel	Freq. (MHz)	Channel	Freq. (MHz)
5470-5725 MHz Band 3 (U-NII-2C)	100	5500	112	5560
	102*	5510	116	5580
	104	5520	132	5660
	106 [#]	5530	134*	5670
	108	5540	136	5680
	110*	5550	140	5700



Frequency Band	Channel	Freq. (MHz)	Channel	Freq. (MHz)
TDWR Channel	118*	5590	124	5620
	120	5600	126*	5630
	122 [#]	5610	128	5640

Frequency Band	Channel	Freq. (MHz)	Channel	Freq. (MHz)
Straddle Channel	138 [#]	5690	144	5720
	142*	5710		

Note:

1. The above Frequency and Channel in "*" were 802.11n HT40 and 802.11ac VHT40.
2. The above Frequency and Channel in "[#]" were 802.11ac VHT80.

2.2 Test Mode

Final test modes are considering the modulation and worse data rates as below table.

Modulation	Data Rate
802.11a	6 Mbps
802.11n HT20	MCS0
802.11n HT40	MCS0
802.11ac VHT20 (Covered by HT20)	MCS0
802.11ac VHT40 (Covered by HT40)	MCS0
802.11ac VHT80	MCS0

Test Cases	
AC Conducted Emission	Mode 1 : GSM850 (Low Channel) Idle + Bluetooth Link + WLAN (5GHz) Link + Camera (Rear) + Battery + USB Cable (Charging from Adapter)



Ch. #		Band I : 5150-5250 MHz	Band II : 5250-5350 MHz	Band III : 5470-5725MHz
		802.11a	802.11a	802.11a
L	Low	36	52	100
M	Middle	44	60	116
H	High	48	64	140
Straddle		-	-	144

Ch. #		Band I : 5150-5250 MHz	Band II : 5250-5350 MHz	Band III : 5470-5725MHz
		802.11n HT20	802.11n HT20	802.11n HT20
L	Low	36	52	100
M	Middle	44	60	116
H	High	48	64	140
Straddle		-	-	144

Ch. #		Band I : 5150-5250 MHz	Band II : 5250-5350 MHz	Band III : 5470-5725MHz
		802.11n HT40	802.11n HT40	802.11n HT40
L	Low	38	54	102
M	Middle	-	-	110
H	High	46	62	134
Straddle		-	-	142

Ch. #		Band I : 5150-5250 MHz	Band II : 5250-5350 MHz	Band III : 5470-5725MHz
		802.11ac VHT80	802.11ac VHT80	802.11ac VHT80
L	Low	-	-	106
M	Middle	42	58	122
H	High	-	-	-
Straddle		-	-	138

2.3 Connection Diagram of Test System

<WLAN Tx Mode>

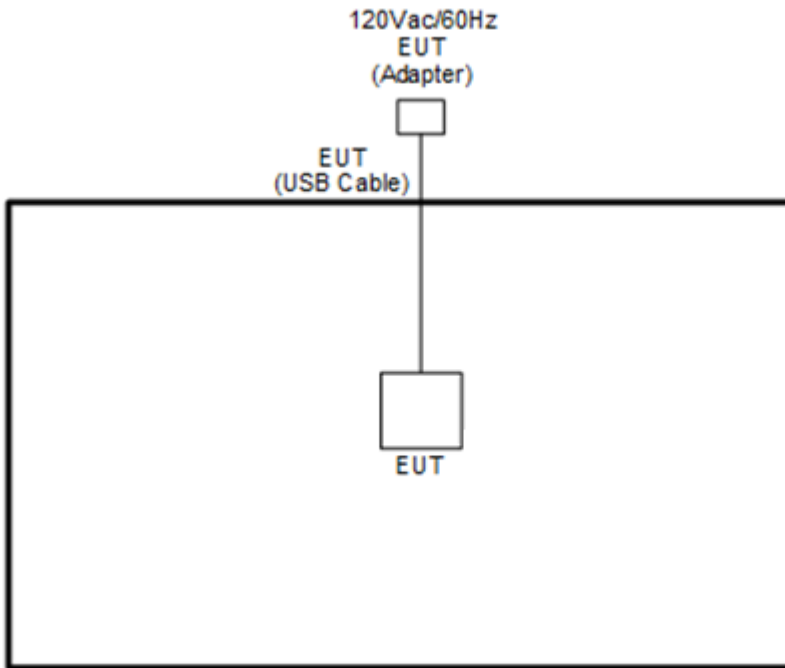

<AC Conducted Emission Mode>

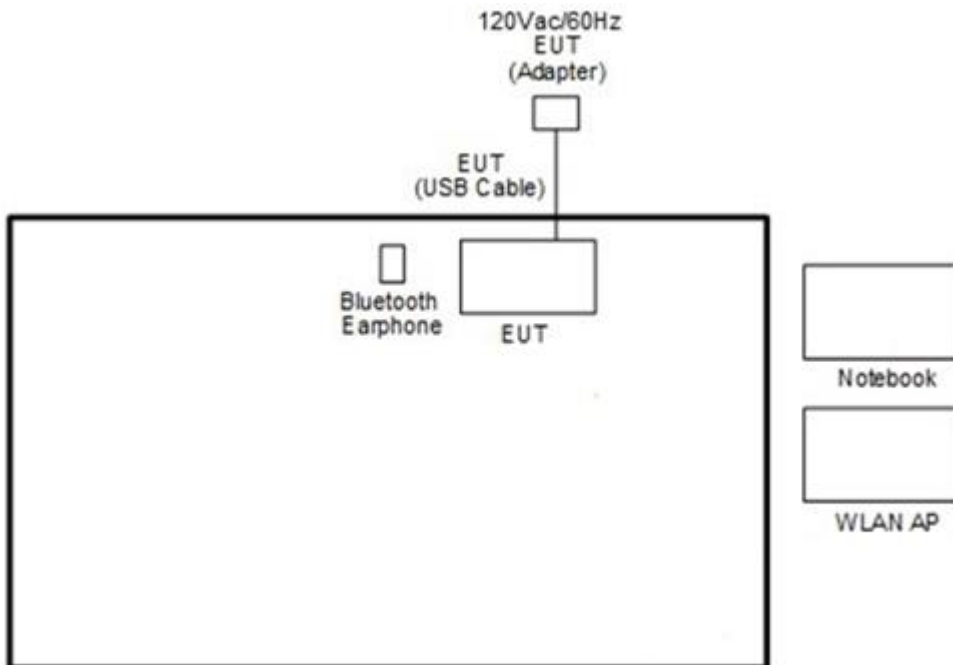

2.4 Support Unit used in test configuration and system

Item	Equipment	Trade Name	Model Name	FCC ID	Data Cable	Power Cord
1.	System simulator	Anritsu	MT8820C	N/A	N/A	Unshielded, 1.8 m
2.	WLAN AP	ASUS	RT-AC66U	MSQ-RTAC66U	N/A	Unshielded, 1.8 m
3.	Bluetooth Earphone	Sony	SBH20	PY7-RD0010	N/A	N/A
4.	Notebook	DELL	Latitude E6320	FCC DoC	N/A	AC I/P: Unshielded, 1.2 m DC O/P: Shielded, 1.8 m
5.	SD Card	SanDisk	MicroSD HC	FCC DoC	N/A	N/A

2.5 EUT Operation Test Setup

The RF test items, utility “Tera Term” was installed in Notebook which was programmed in order to make the EUT get into the engineering modes to provide channel selection, power level, data rate and the application type and for continuous transmitting signals.

2.6 Measurement Results Explanation Example

For all conducted test items:

The offset level is set in the spectrum analyzer to compensate the RF cable loss and attenuator factor between EUT conducted output port and spectrum analyzer. With the offset compensation, the spectrum analyzer reading level is exactly the EUT RF output level.

Example :

The spectrum analyzer offset is derived from RF cable loss and attenuator factor.

Offset = RF cable loss + attenuator factor.

Following shows an offset computation example with cable loss 4.2 dB and 10dB attenuator.

$$\begin{aligned}
 \text{Offset(dB)} &= \text{RF cable loss(dB)} + \text{attenuator factor(dB)}. \\
 &= 4.2 + 10 = 14.2 \text{ (dB)}
 \end{aligned}$$

3 Test Result

3.1 26dB & 99% Occupied Bandwidth Measurement

3.1.1 Description of 26dB & 99% Occupied Bandwidth

This section is for reporting purpose only.

There is no restriction limits for bandwidth.

For Straddle Channel, according to KDB 789033 D02 General UNII Test Procedures New Rules v02r01, if the power and PSD of the devices are uniform and comply with the lower limits specified for the U-NII-2 bands, a single measurement over the entire emission bandwidth can be performed to show compliance.

3.1.2 Measuring Instruments

See list of measuring equipment of this test report.

3.1.3 Test Procedures

1. The testing follows FCC KDB 789033 D02 General UNII Test Procedures New Rules v02r01. Section C) Emission bandwidth
2. Set RBW = approximately 1% of the emission bandwidth.
3. Set the VBW > RBW.
4. Detector = Peak.
5. Trace mode = max hold
6. Measure the maximum width of the emission that is 26 dB down from the peak of the emission. Compare this with the RBW setting of the analyzer. Readjust RBW and repeat measurement as needed until the RBW/EBW ratio is approximately 1%.
7. For 99% Bandwidth Measurement, the spectrum analyzer's resolution bandwidth (RBW) is set 1-5% of the emission bandwidth and set the Video bandwidth (VBW) $\geq 3 * RBW$.
8. Measure and record the results in the test report.

3.1.4 Test Setup

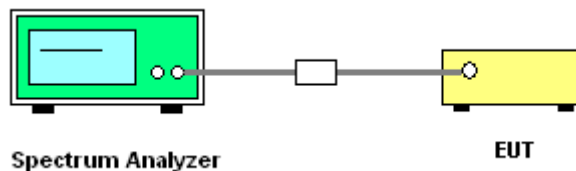

3.1.5 Test Result of 26dB & 99% Occupied Bandwidth

Please refer to Appendix A.

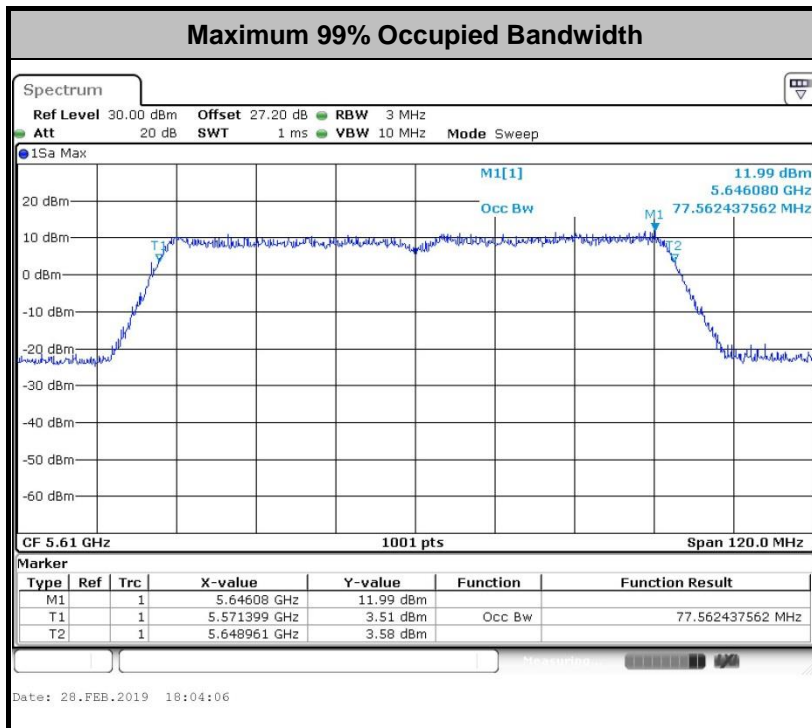
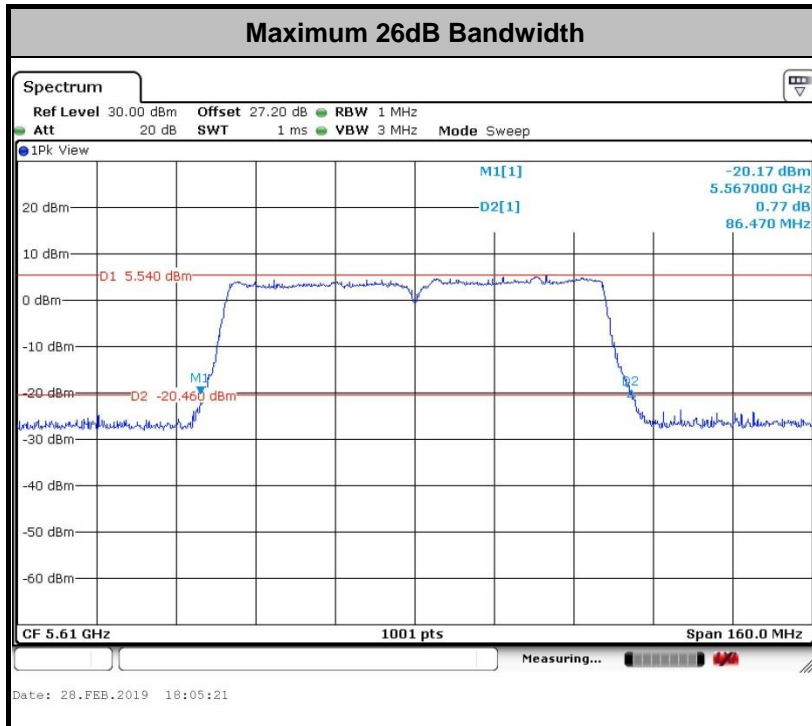

Note: The occupied channel bandwidth is maintained within the band of operation for all of the modulations.



3.2 Maximum Conducted Output Power Measurement

3.2.1 Limit of Maximum Conducted Output Power

<FCC 14-30 CFR 15.407>

For the 5.15–5.25 GHz bands:

- For mobile and portable client devices in the 5.15–5.25 GHz band, the maximum conducted output power over the frequency band of operation shall not exceed 250 mW. For an indoor access point operating in the band 5.15-5.25 GHz, the maximum conducted output power over the frequency band of operation shall not exceed 1 W.

For the 5.25–5.725 GHz bands:

- The maximum conducted output power over the frequency bands of operation shall not exceed the lesser of 250 mW or $11 \text{ dBm} + 10 \log B$, where B is the 26 dB emission bandwidth in megahertz.

For Straddle Channel, according to KDB 789033 D02 General UNII Test Procedures New Rules v02r01, if the power and PSD of the devices are uniform and comply with the lower limits specified for the U-NII-2 bands, a single measurement over the entire emission bandwidth can be performed to show compliance.

If transmitting antennas of directional gain greater than 6 dBi are used, the peak output power shall be reduced by the amount in dB that the directional gain of the antenna exceeds 6 dBi.

Note that U-NII-2 band, devices with a maximum e.i.r.p. greater than 500 mW shall implement TPC in order to have the capability to operate at least 6 dB below the maximum permitted e.i.r.p. of 1 W.

3.2.2 Measuring Instruments

See list of measuring equipment of this test report.

3.2.3 Test Procedures

The testing follows Method PM of FCC KDB 789033 D02 General UNII Test Procedures New Rules v02r01.

Method PM (Measurement using an RF average power meter):

1. Measurement is performed using a wideband RF power meter.
2. The EUT is configured to transmit continuously with a consistent duty cycle at its maximum power control level.
3. Measure the average power of the transmitter, and the average power is corrected with duty factor, $10 \log(1/x)$, where x is the duty cycle.

For Straddle Channel, according to KDB 789033 D02 General UNII Test Procedures New Rules v02r01, if the power and PSD of the devices are uniform and comply with the lower limits specified for the U-NII-2 bands, a single measurement over the entire emission bandwidth can be performed to show compliance.

3.2.4 Test Setup

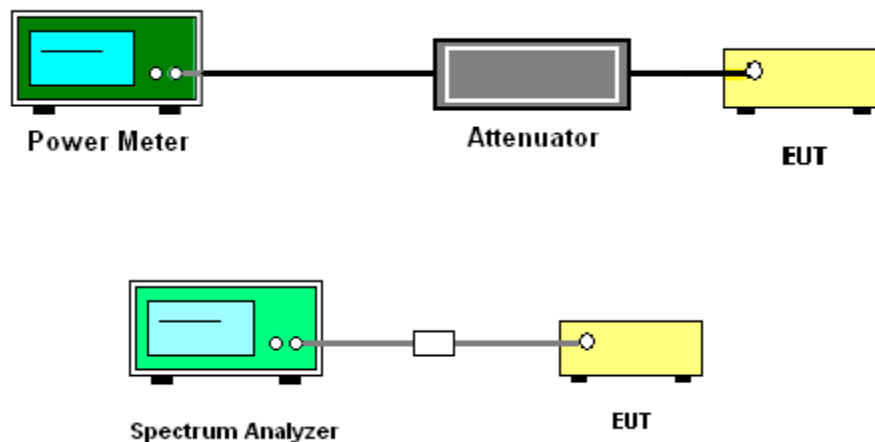

3.2.5 Test Result of Maximum Conducted Output Power

Please refer to Appendix A.



3.3 Power Spectral Density Measurement

3.3.1 Limit of Power Spectral Density

<FCC 14-30 CFR 15.407>

For the 5.15–5.25 GHz bands:

For mobile and portable client devices in the 5.15–5.25 GHz band, the maximum power spectral density shall not exceed 11 dBm in any 1.0 MHz band. For an indoor access point operating in the band 5.15-5.25 GHz, the maximum power spectral density shall not exceed 17 dBm in any 1.0 MHz band.

For the 5.25–5.725 GHz bands:

The maximum power spectral density shall not exceed 11 dBm in any 1.0 MHz band.

For Straddle Channel, according to KDB 789033 D02 General UNII Test Procedures New Rules v02r01, if the power and PSD of the devices are uniform and comply with the lower limits specified for the U-NII-2 bands, a single measurement over the entire emission bandwidth can be performed to show compliance.

If transmitting antennas of directional gain greater than 6 dBi are used, the peak output power shall be reduced by the amount in dB that the directional gain of the antenna exceeds 6 dBi.

3.3.2 Measuring Instruments

See list of measuring equipment of this test report.

3.3.3 Test Procedures

The testing follows FCC KDB 789033 D02 General UNII Test Procedures New Rules v02r01. Section F) Maximum power spectral density.

Method SA-2

(trace averaging across on and off times of the EUT transmissions, followed by duty cycle correction).

- Measure the duty cycle.
- Set span to encompass the entire emission bandwidth (EBW) of the signal.
- Set RBW = 1 MHz.
- Set VBW \geq 3 MHz.
- Number of points in sweep \geq 2 Span / RBW.
- Sweep time = auto.
- Detector = RMS
- Trace average at least 100 traces in power averaging mode.
- Add $10 \log(1/x)$, where x is the duty cycle, to the measured power in order to compute the average power during the actual transmission times. For example, add $10 \log(1/0.25) = 6$ dB if the duty cycle is 25 percent.

1. The RF output of EUT was connected to the spectrum analyzer by a low loss cable.
2. Each plot has already offset with cable loss, and attenuator loss. Measure the PPSD and record it.
3. For MIMO mode, calculation method follows FCC KDB 662911 D01 Multiple Transmitter Output v02r01.

Method (a): Measure and sum the spectra across the outputs.

The total final Power Spectral Density is from a device with 2 transmitter outputs. The spectrum measurements of the individual outputs are all performed with the same span and number of points; the spectrum value in the first spectral bin of output 1 is summed with that in the first spectral bin of output 2 to obtain the value for the first frequency bin of the summed spectrum.

3.3.4 Test Setup

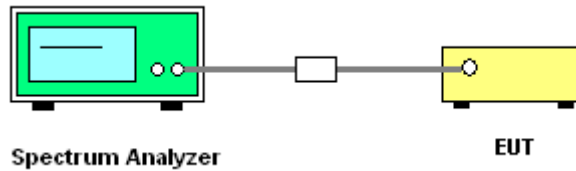

3.3.5 Test Result of Power Spectral Density

Please refer to Appendix A.

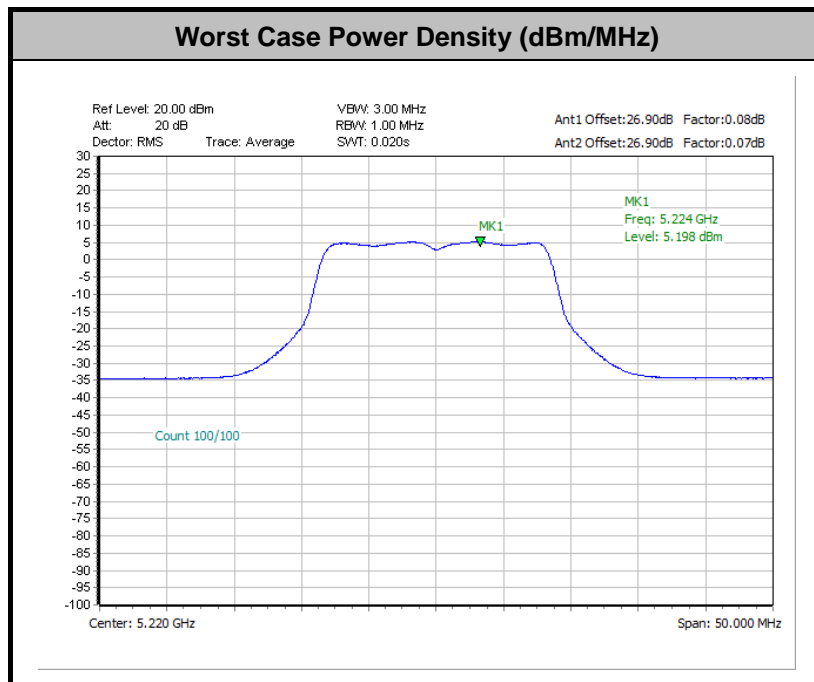

Note: Average Power Density (dB) = Measured value+ Duty Factor



3.4 Unwanted Emissions Measurement

This section is to measure unwanted emissions through radiated measurement for band edge spurious emissions and out of band emissions measurement.

3.4.1 Limit of Unwanted Emissions

- (1) For transmitters operating in the 5150-5250 MHz band: all emissions outside of the 5150-5350 MHz band shall not exceed an EIRP of -27dBm/MHz.

For transmitters operating in the 5250-5350 MHz band: all emissions outside of the 5150-5350 MHz band shall not exceed an EIRP of -27 dBm/MHz. Devices operating in the 5250-5350 MHz band that generate emissions in the 5150-5250 MHz band must meet all applicable technical requirements for operation in the 5150-5250 MHz band (including indoor use) or alternatively meet an out-of-band emission EIRP limit of -27 dBm/MHz in the 5150-5250 MHz band.

For transmitters operating in the 5470-5600 MHz and 5650-5725MHz band: all emissions outside of the 5470-5600 MHz and 5650-5725MHz band shall not exceed an EIRP of -27 dBm/MHz.

- (2) Unwanted spurious emissions fallen in restricted bands shall comply with the general field strength limits as below table,

Frequency (MHz)	Field Strength (microvolts/meter)	Measurement Distance (meters)
0.009 – 0.490	2400/F(kHz)	300
0.490 – 1.705	24000/F(kHz)	30
1.705 – 30.0	30	30
30 – 88	100	3
88 – 216	150	3
216 - 960	200	3
Above 960	500	3

Note: The following formula is used to convert the EIRP to field strength.

$$E = \frac{1000000\sqrt{30P}}{3} \mu\text{V/m, where P is the eirp (Watts)}$$



EIRP (dBm)	Field Strength at 3m (dBμV/m)
- 27	68.3

(3) KDB789033 D02 v02r01 G)2)c)

- (i) Section 15.407(b)(1) to (b)(3) specify the unwanted emission limits for the U-NII-1 and U-NII-2 bands. As specified, emissions above 1000 MHz that are outside of the restricted bands are subject to a peak emission limit of -27 dBm/MHz.³
- (ii) Section 15.407(b)(4) specifies the unwanted emission limit for the U-NII-3 band. A band emissions mask is specified in Section 15.407(b)(4)(i). The emission limits are in terms of a Peak detector. An alternative to the band emissions mask is specified in Section 15.407(b)(4)(ii). The alternative limits are based on the highest antenna gain specified in the filing. There are also marketing and importation restrictions for the devices using the alternative limit.⁴

Note 3: An out-of-band emission that complies with both the average and peak limits of Section 15.209 is not required to satisfy the -27 dBm/MHz peak emission limit.

Note 4: Only devices with antenna gains of 10 dBi or less may be approved using the emission limits specified in Section 15.247(d) till March 2, 2018; all other devices operating in this band must use the mask specified in Section 15.407(b)(4)(i).

3.4.2 Measuring Instruments

See list of measuring equipment of this test report.

3.4.3 Test Procedures

1. The testing follows FCC KDB 789033 D02 General UNII Test Procedures New Rules v02r01. Section G) Unwanted emissions measurement.
 - (1) Procedure for Unwanted Emissions Measurements Below 1000MHz
 - RBW = 120 kHz
 - VBW = 300 kHz
 - Detector = Peak
 - Trace mode = max hold
 - (2) Procedure for Peak Unwanted Emissions Measurements Above 1000 MHz
 - RBW = 1 MHz
 - VBW ≥ 3 MHz
 - Detector = Peak
 - Sweep time = auto
 - Trace mode = max hold



(3) Procedures for Average Unwanted Emissions Measurements Above 1000MHz

- RBW = 1 MHz
 - VBW = 10 Hz, when duty cycle is no less than 98 percent.
 - $VBW \geq 1/T$, when duty cycle is less than 98 percent where T is the minimum transmission duration over which the transmitter is on and is transmitting at its maximum power control level for the tested mode of operation.
2. The EUT was placed on a turntable with 0.8 meter for frequency below 1GHz and 1.5 meter for frequency above 1GHz respectively above ground.
 3. The EUT was set 3 meters from the interference receiving antenna which was mounted on the top of a variable height antenna tower.
 4. The antenna is a broadband antenna and its height is adjusted between one meter and four meters above ground to find the maximum value of the field strength for both horizontal polarization and vertical polarization of the antenna.
 5. For each suspected emission, the EUT was arranged to its worst case and then adjust the antenna tower (from 1 m to 4 m) and turntable (from 0 degree to 360 degrees) to find the maximum reading.
 6. For testing below 1GHz, if the emission level of the EUT in peak mode was 3 dB lower than the limit specified, then peak values of EUT will be reported, otherwise, the emissions will be repeated one by one using the CISPR quasi-peak method and reported.
 7. For testing above 1GHz, the emission level of the EUT in peak mode was 20dB lower than average limit (that means the emission level in average mode also complies with the limit in average mode), then peak values of EUT will be reported, otherwise, the emissions will be measured in average mode again and reported.

3.4.4 Test Setup

For radiated emissions below 30MHz

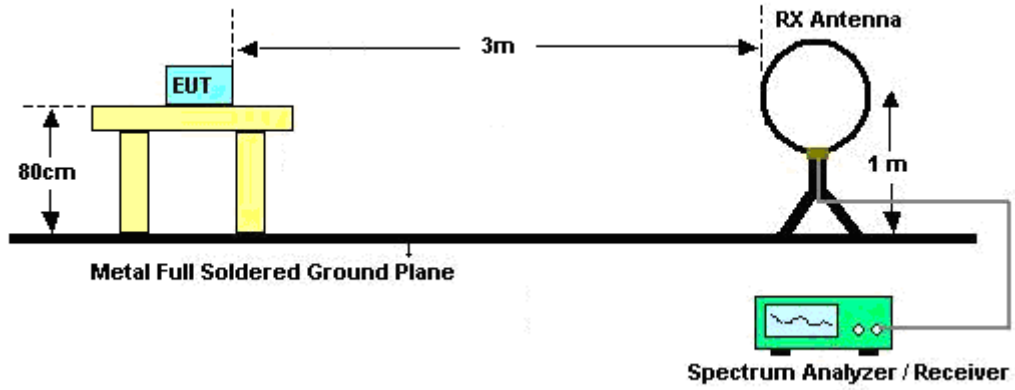

For radiated emissions from 30MHz to 1GHz

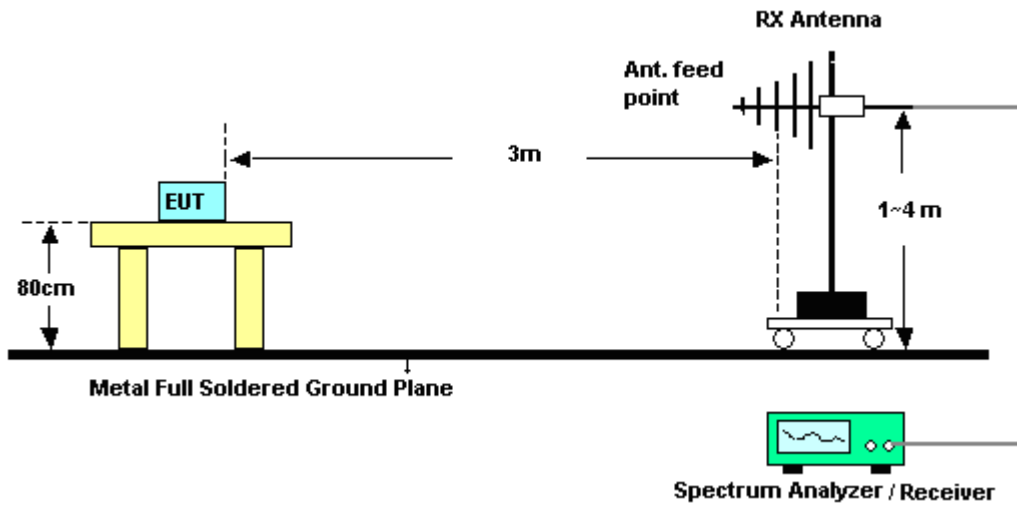

For radiated emissions above 1GHz

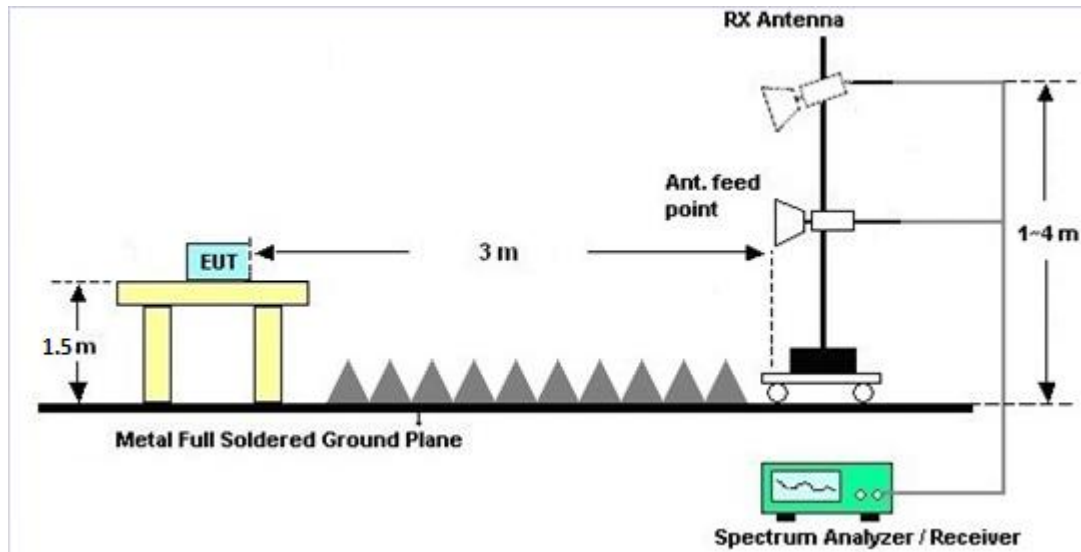

3.4.5 Test Results of Radiated Spurious Emissions (9 kHz ~ 30 MHz)

The low frequency, which started from 9 kHz to 30MHz, was pre-scanned and the result which was 20dB lower than the limit line was not reported.

There is a comparison data of both open-field test site and alternative test site - semi-Anechoic chamber according to 414788 D01 Radiated Test Site v01r01, and the result came out very similar.

3.4.6 Test Result of Radiated Spurious at Band Edges

Please refer to Appendix C and D.

3.4.7 Duty Cycle

Please refer to Appendix E.

3.4.8 Test Result of Radiated Spurious Emissions (30MHz ~ 10th Harmonic)

Please refer to Appendix C and D.



3.5 AC Conducted Emission Measurement

3.5.1 Limit of AC Conducted Emission

For equipment that is designed to be connected to the public utility (AC) power line, the radio frequency voltage that is conducted back onto the AC power line on any frequency or frequencies within the band 150 kHz to 30 MHz shall not exceed the limits in the following table.

Frequency of emission (MHz)	Conducted limit (dB μ V)	
	Quasi-peak	Average
0.15-0.5	66 to 56*	56 to 46*
0.5-5	56	46
5-30	60	50

*Decreases with the logarithm of the frequency.

3.5.2 Measuring Instruments

See list of measuring equipment of this test report.

3.5.3 Test Procedures

1. The EUT was placed 0.4 meter from the conducting wall of the shielding room was kept at least 80 centimeters from any other grounded conducting surface.
2. Connect EUT to the power mains through a line impedance stabilization network (LISN).
3. All the support units are connecting to the other LISN.
4. The LISN provides 50 ohm coupling impedance for the measuring instrument.
5. The FCC states that a 50 ohm, 50 microhenry LISN should be used.
6. Both sides of AC line were checked for maximum conducted interference.
7. The frequency range from 150 kHz to 30 MHz was searched.
8. Set the test-receiver system to Peak Detect Function and specified bandwidth with Maximum Hold Mode.

3.5.4 Test Setup

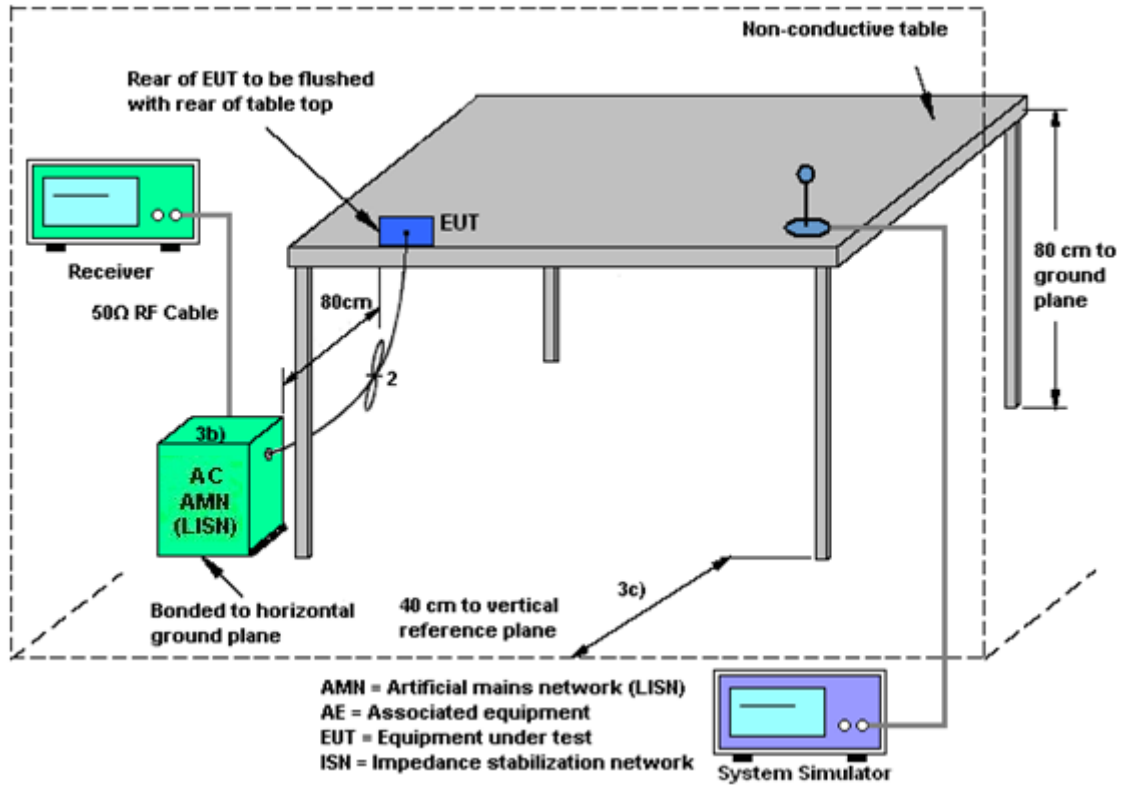

3.5.5 Test Result of AC Conducted Emission

Please refer to Appendix B.



3.6 Automatically Discontinue Transmission

3.6.1 Limit of Automatically Discontinue Transmission

The device shall automatically discontinue transmission in case of either absence of information to transmit or operational failure. These provisions are not intended to preclude the transmission of control or signaling information or the use of repetitive codes used by certain digital technologies to complete frame or burst intervals. Applicants shall include in their application for equipment authorization to describe how this requirement is met.

3.6.2 Measuring Instruments

See list of measuring equipment of this test report.

3.6.3 Test Result of Automatically Discontinue Transmission

EUT is verified this characteristic during the function check of normal sample associated with an access point:

- A. Information start: make EUT supply information to the access point.
- B. Information stop: stop supplying information to the access point.

While the EUT is not transmitting any information, the EUT can automatically discontinue transmission and become standby mode for power saving.

- C. Information start: make EUT supply information to the access point again.

The EUT can detect the controlling signal of ACK message transmitting from remote device and verify whether it shall resend or discontinue transmission.

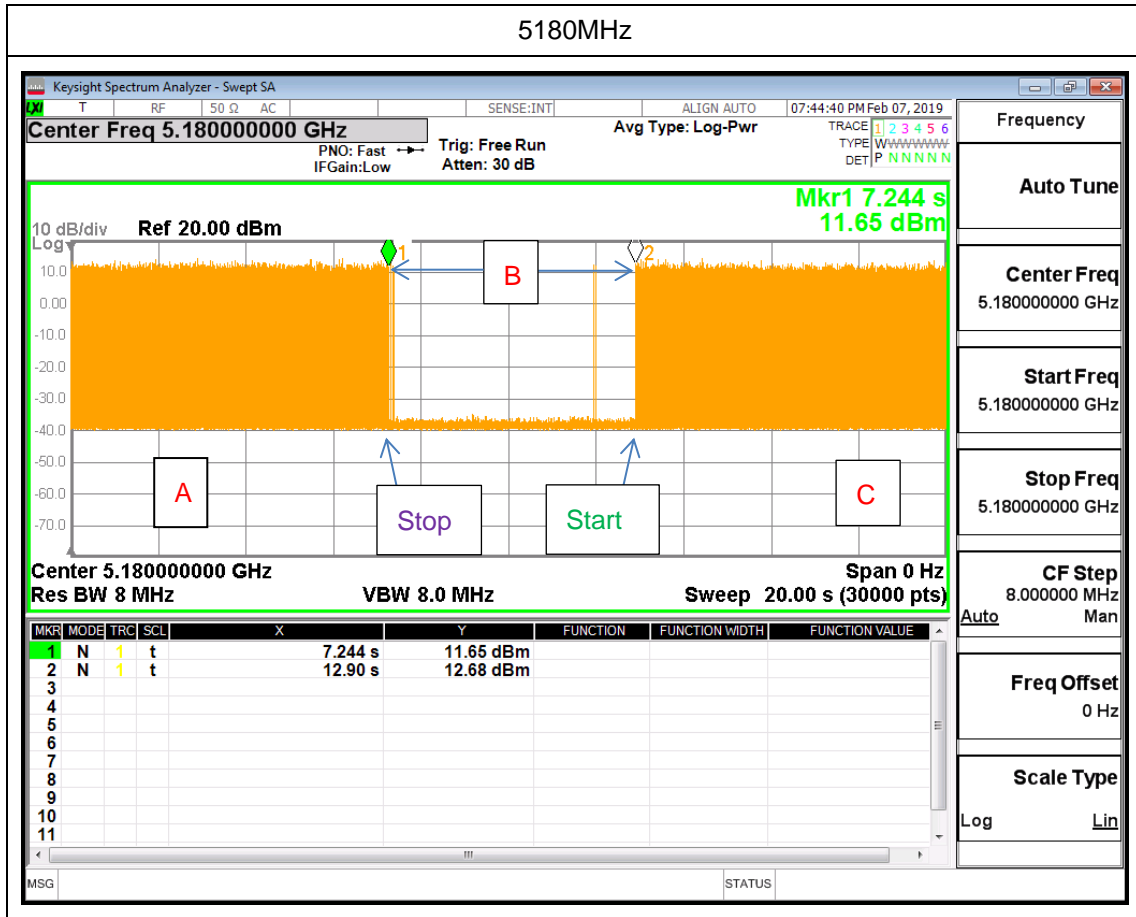

Note: The control / signalling information during the period B is precluded.



3.7 Antenna Requirements

3.7.1 Standard Applicable

If transmitting antenna directional gain is greater than 6 dBi, both the peak transmit power and the peak power spectral density shall be reduced by the amount in dB that the directional gain of the antenna exceeds 6 dBi.

3.7.2 Antenna Anti-Replacement Construction

An embedded-in antenna design is used.

3.7.3 Antenna Gain

<CDD Modes >

FCC KDB 662911 D01 Multiple Transmitter Output v02r01

For CDD transmissions, directional gain is calculated as

Directional gain = GANT + Array Gain, where Array Gain is as follows.

For power spectral density (PSD) measurements on all devices,

Array Gain = 10 log(NANT/NSS=1) dB.

For power measurements on IEEE 802.11 devices,

Array Gain = 0 dB (i.e., no array gain) for NANT ≤ 4.

Directional gain may be calculated by using the formulas applicable to equal gain antennas with GANT set equal to the gain of the antenna having the highest gain;

The EUT supports CDD mode.

For power, the directional gain GANT is set equal to the antenna having the highest gain, i.e., F)2)f)i).

For PSD, the directional gain calculation is following F)2)f)ii) of KDB 662911 D01 v02r01.

The power and PSD limit should be modified if the directional gain of EUT is over 6 dBi,

The directional gain "DG" is calculated as following table.

<CDD Modes>						
	Ant. 1	Ant. 2	DG for Power	DG for PSD	Power Limit Reduction	PSD Limit Reduction
	(dBi)	(dBi)	(dBi)	(dBi)	(dB)	(dB)
Band I	-5.70	-7.30	-5.70	-3.45	0.00	0.00
Band II	-5.30	-4.90	-4.90	-2.09	0.00	0.00
Band III	-5.70	1.30	1.30	1.50	0.00	0.00

Power limit reduction = Composite gain – 6dBi, (min = 0)

PSD limit reduction = Composite gain + PSD Array gain – 6dBi, (min = 0)



4 List of Measuring Equipment

Instrument	Manufacturer	Model No.	Serial No.	Characteristics	Calibration Date	Test Date	Due Date	Remark
Hygrometer	Testo	DTM-303A	TP157075	N/A	Mar. 06, 2018	Feb. 04, 2019~ Mar. 01, 2019	Mar. 05, 2019	Conducted (TH05-HY)
Hygrometer	Testo	DTM-303A	TP157075	N/A	Mar. 05, 2019	Mar. 09, 2019	Mar. 04, 2020	Conducted (TH05-HY)
Power Sensor	DARE	RPR3006W	15I00041SN O10	10MHz~6GHz	May 07, 2018	Feb. 04, 2019~ Mar. 09, 2019	May 06, 2019	Conducted (TH05-HY)
Spectrum Analyzer	Rohde & Schwarz	FSV 30	100895	9kHz~30GHz	Apr. 20, 2018	Feb. 04, 2019~ Mar. 09, 2019	Apr. 19, 2019	Conducted (TH05-HY)
Switch Box & RF Cable	Burgeon	ETF-058	EC1300484	N/A	Mar. 01, 2018	Feb. 04, 2019~ Feb. 27, 2019	Feb. 28, 2019	Conducted (TH05-HY)
Switch Box & RF Cable	Burgeon	ETF-058	EC1300484	N/A	Feb. 28, 2019	Feb. 28, 2019~ Mar. 09, 2019	Feb. 27, 2020	Conducted (TH05-HY)
Programmable Power Supply	GW Instek	PSS-2005	EL890094	1V~20V 0.5A~5A	Oct. 02, 2018	Feb. 04, 2019~ Mar. 09, 2019	Oct. 01, 2019	Conducted (TH05-HY)
AC Power Source	ChainTek	APC-1000W	N/A	N/A	N/A	Feb. 21, 2019	N/A	Conduction (CO05-HY)
EMI Test Receiver	Rohde & Schwarz	ESR3	102388	9KHz~3.6GHz	Nov. 12, 2018	Feb. 21, 2019	Nov. 11, 2019	Conduction (CO05-HY)
Hygrometer	Testo	608-H1	34913912	N/A	Mar. 06, 2018	Feb. 21, 2019	Mar. 05, 2019	Conduction (CO05-HY)
LISN	Rohde & Schwarz	ENV216	100080	9kHz~30MHz	Nov. 14, 2018	Feb. 21, 2019	Nov. 13, 2019	Conduction (CO05-HY)
LISN	Rohde & Schwarz	ENV216	100081	9kHz~30MHz	Nov. 09, 2018	Feb. 21, 2019	Nov. 08, 2019	Conduction (CO05-HY)
Software	Rohde & Schwarz	EMC32 V10.30	N/A	N/A	N/A	Feb. 21, 2019	N/A	Conduction (CO05-HY)
RF Cable	HUBER + SUHNER	RG 214/U	1358175	9kHz~30MHz	Sep. 14, 2018	Feb. 21, 2019	Sep. 13, 2019	Conduction (CO05-HY)
Pulse Limiter	SCHWARZBECK	VTSD 9561-F N	9561-F N00373	9kHz-200MHz	Nov. 08, 2018	Feb. 21, 2019	Nov. 07, 2019	Conduction (CO05-HY)
Loop Antenna	Rohde & Schwarz	HFH2-Z2	100488	9 kHz~30 MHz	Jan. 07, 2019	Feb. 20, 2019~ Feb. 27, 2019	Jan. 06, 2020	Radiation (03CH13-HY)
Bilog Antenna	TESEQ	CBL 6111D&00800 N1D01N-06	37059&01	30MHz~1GHz	Oct. 13, 2018	Feb. 20, 2019~ Feb. 27, 2019	Oct. 12, 2019	Radiation (03CH13-HY)
Horn Antenna	SCHWARZBECK	BBHA 9120 D	9120D-1241	1GHz ~ 18GHz	Jun. 29, 2018	Feb. 20, 2019~ Feb. 27, 2019	Jun. 28, 2019	Radiation (03CH13-HY)
SHF-EHF Horn Antenna	SCHWARZBECK	BBHA 9170	BBHA917058 4	18GHz- 40GHz	Dec. 05, 2018	Feb. 20, 2019~ Feb. 27, 2019	Dec. 04, 2019	Radiation (03CH13-HY)
Amplifier	Sonoma-Instrument	310 N	187282	9KHz~1GHz	Dec. 18, 2018	Feb. 20, 2019~ Feb. 27, 2019	Dec. 17, 2019	Radiation (03CH13-HY)
Preamplifier	Keysight	83017A	MY53270080	1GHz~26.5GHz	Nov. 14, 2018	Feb. 20, 2019~ Feb. 27, 2019	Nov. 13, 2020	Radiation (03CH13-HY)
Preamplifier	MITEQ	AMF-7D-0010 1800-30-10P	1590074	1GHz~18GHz	May. 21, 2018	Feb. 20, 2019~ Feb. 27, 2019	May. 20, 2019	Radiation (03CH13-HY)
Amplifier	MITEQ	TTA1840-35-H G	1871923	18GHz~40GHz, VSWR : 2.5:1 max	Jul. 16, 2018	Feb. 20, 2019~ Feb. 27, 2019	Jul. 15, 2019	Radiation (03CH13-HY)



Instrument	Manufacturer	Model No.	Serial No.	Characteristics	Calibration Date	Test Date	Due Date	Remark
Spectrum Analyzer	Keysight	N9010A	MY55370526	10Hz~44GHz	Mar. 15, 2018	Feb. 20, 2019~ Feb. 27, 2019	Mar. 14, 2019	Radiation (03CH13-HY)
EMI Test Receiver	Keysight	N9038A(MXE)	MY54130085	20Hz ~ 8.4GHz	Nov. 01, 2018	Feb. 20, 2019~ Feb. 27, 2019	Oct. 31, 2019	Radiation (03CH13-HY)
Hygrometer	TECPEL	DTM-303B	TP157151	N/A	May. 19, 2018	Feb. 20, 2019~ Feb. 27, 2019	May. 18, 2019	Radiation (03CH13-HY)
Filter	Wainwright	WLKS1200-12 SS	SN2	1.2GHz Low Pass	Mar. 21, 2018	Feb. 20, 2019~ Feb. 27, 2019	Mar. 20, 2019	Radiation (03CH13-HY)
Filter	Wainwright	WHKX12-270 0-3000-18000- 60ST	SN2	3GHz High Pass	Mar. 21, 2018	Feb. 20, 2019~ Feb. 27, 2019	Mar. 20, 2019	Radiation (03CH13-HY)
Filter	Woken	WHKX8-5272. 5-6750-18000- 40ST	SN2	6.75G Highpass	Mar. 21, 2018	Feb. 20, 2019~ Feb. 27, 2019	Mar. 20, 2019	Radiation (03CH13-HY)
RF Cable	HUBER + SUHNER	SUCOFLEX 126E	0030/126E	30M-18G	Feb. 13, 2019	Feb. 20, 2019~ Feb. 27, 2019	Feb. 12, 2020	Radiation (03CH13-HY)
RF Cable	HUBER + SUHNER	SUCOFLEX 104	804793/4	30M-18G	Feb. 13, 2019	Feb. 20, 2019~ Feb. 27, 2019	Feb. 12, 2020	Radiation (03CH13-HY)
RF Cable	HUBER + SUHNER	SUCOFLEX 104	MY24961/4	30M-18G	Feb. 13, 2019	Feb. 20, 2019~ Feb. 27, 2019	Feb. 12, 2020	Radiation (03CH13-HY)
RF Cable	HUBER + SUHNER	SUCOFLEX 102	MY2859/2	30M~40GHz	Mar. 14, 2018	Feb. 20, 2019~ Feb. 27, 2019	Mar. 13, 2019	Radiation (03CH13-HY)
RF Cable	HUBER + SUHNER	SUCOFLEX 102	MY4274/2	30M~40GHz	Mar. 14, 2018	Feb. 20, 2019~ Feb. 27, 2019	Mar. 13, 2019	Radiation (03CH13-HY)
Controller	EMEC	EM1000	N/A	Control Turn table & Ant Mast	N/A	Feb. 20, 2019~ Feb. 27, 2019	N/A	Radiation (03CH13-HY)
Antenna Mast	EMEC	AM-BS-4500- B	N/A	1m~4m	N/A	Feb. 20, 2019~ Feb. 27, 2019	N/A	Radiation (03CH13-HY)
Turn Table	EMEC	TT2000	N/A	0~360 Degree	N/A	Feb. 20, 2019~ Feb. 27, 2019	N/A	Radiation (03CH13-HY)
Software	AUDIX	E3 6.2009-8-24c	RK-001124	N/A	N/A	Feb. 20, 2019~ Feb. 27, 2019	N/A	Radiation (03CH13-HY)



5 Uncertainty of Evaluation

Uncertainty of Conducted Emission Measurement (150kHz ~ 30MHz)

Measuring Uncertainty for a Level of Confidence of 95% ($U = 2Uc(y)$)	2.20
---	------

Uncertainty of Radiated Emission Measurement (30 MHz ~ 1000 MHz)

Measuring Uncertainty for a Level of Confidence of 95% ($U = 2Uc(y)$)	4.90
---	------

Uncertainty of Radiated Emission Measurement (1000 MHz ~ 18000 MHz)

Measuring Uncertainty for a Level of Confidence of 95% ($U = 2Uc(y)$)	5.40
---	------

Uncertainty of Radiated Emission Measurement (18000 MHz ~ 40000 MHz)

Measuring Uncertainty for a Level of Confidence of 95% ($U = 2Uc(y)$)	4.30
---	------

Appendix A. Test Result of Conducted Test Items

Test Engineer:	Shiming Liu / Howard Lin / Kai Liao	Temperature:	21~25	°C
Test Date:	2019/2/4 ~ 2019/3/9	Relative Humidity:	51~54	%

TEST RESULTS DATA
26dB and 99% OBW

Band I									
Mod.	Data Rate	NTX	CH.	Freq. (MHz)	99% Bandwidth (MHz)		26 dB Bandwidth (MHz)		Note
					Ant 1	Ant 2	Ant 1	Ant 2	
11a	6Mbps	2	36	5180	16.88	16.73	24.53	23.63	
11a	6Mbps	2	44	5220	17.03	16.78	25.77	23.88	
11a	6Mbps	2	48	5240	16.88	16.78	24.73	24.03	
HT20	MCS0	2	36	5180	18.08	17.88	25.82	25.38	
HT20	MCS0	2	44	5220	18.08	17.88	25.97	24.83	
HT20	MCS0	2	48	5240	18.08	17.88	26.27	24.88	
HT40	MCS0	2	38	5190	37.16	36.96	43.43	43.07	
HT40	MCS0	2	46	5230	37.16	37.06	43.79	43.07	
VHT80	MCS0	2	42	5210	77.20	76.96	85.67	83.28	

TEST RESULTS DATA
Average Power Table

FCC Band I												
Mod.	Data Rate	NTX	CH.	Freq. (MHz)	Average Conducted Power (dBm)			FCC Conducted Power Limit (dBm)		DG (dBi)		Pass/Fail
					Ant 1	Ant 2	SUM	Ant 1	Ant 2	Ant 1	Ant 2	
11a	6Mbps	1	36	5180	13.80	11.60		24.00	24.00	-5.70	-7.30	Pass
11a	6Mbps	1	44	5220	13.80	11.60		24.00	24.00	-5.70	-7.30	Pass
11a	6Mbps	1	48	5240	13.60	11.80		24.00	24.00	-5.70	-7.30	Pass
HT20	MCS0	1	36	5180	13.80	11.70		24.00	24.00	-5.70	-7.30	Pass
HT20	MCS0	1	44	5220	13.80	11.70		24.00	24.00	-5.70	-7.30	Pass
HT20	MCS0	1	48	5240	13.70	11.70		24.00	24.00	-5.70	-7.30	Pass
HT40	MCS0	1	38	5190	13.80	11.70		24.00	24.00	-5.70	-7.30	Pass
HT40	MCS0	1	46	5230	13.80	11.80		24.00	24.00	-5.70	-7.30	Pass
VHT20	MCS0	1	36	5180	13.70	11.60		24.00	24.00	-5.70	-7.30	Pass
VHT20	MCS0	1	44	5220	13.70	11.60		24.00	24.00	-5.70	-7.30	Pass
VHT20	MCS0	1	48	5240	13.60	11.60		24.00	24.00	-5.70	-7.30	Pass
VHT40	MCS0	1	38	5190	13.70	11.60		24.00	24.00	-5.70	-7.30	Pass
VHT40	MCS0	1	46	5230	13.70	11.70		24.00	24.00	-5.70	-7.30	Pass
VHT80	MCS0	1	42	5210	13.70	11.80		24.00	24.00	-5.70	-7.30	Pass
11a	6Mbps	2	36	5180	13.90	11.40	15.84	24.00		-5.70		Pass
11a	6Mbps	2	44	5220	13.90	11.40	15.84	24.00		-5.70		Pass
11a	6Mbps	2	48	5240	13.80	11.40	15.77	24.00		-5.70		Pass
HT20	MCS0	2	36	5180	13.90	11.90	16.02	24.00		-5.70		Pass
HT20	MCS0	2	44	5220	13.90	11.90	16.02	24.00		-5.70		Pass
HT20	MCS0	2	48	5240	13.90	11.50	15.87	24.00		-5.70		Pass
HT40	MCS0	2	38	5190	13.80	11.70	15.89	24.00		-5.70		Pass
HT40	MCS0	2	46	5230	13.90	11.90	16.02	24.00		-5.70		Pass
VHT20	MCS0	2	36	5180	13.80	11.80	15.92	24.00		-5.70		Pass
VHT20	MCS0	2	44	5220	13.80	11.80	15.92	24.00		-5.70		Pass
VHT20	MCS0	2	48	5240	13.80	11.50	15.81	24.00		-5.70		Pass
VHT40	MCS0	2	38	5190	13.70	11.60	15.79	24.00		-5.70		Pass
VHT40	MCS0	2	46	5230	13.80	11.80	15.92	24.00		-5.70		Pass
VHT80	MCS0	2	42	5210	14.00	11.60	15.97	24.00		-5.70		Pass

TEST RESULTS DATA
Power Spectral Density

FCC Band I														
Mod.	Data Rate	NTX	CH.	Freq. (MHz)	Duty Factor (dB)		Average Power Density (dBm/MHz)			Average PSD Limit (dBm/MHz)		DG (dBi)		Pass /Fail
					Ant 1	Ant 2	Ant 1	Ant 2	SUM	Ant 1	Ant 2	Ant 1	Ant 2	
11a	6Mbps	2	36	5180	0.08	0.07			5.02	11.00		-3.45	Pass	
11a	6Mbps	2	44	5220	0.08	0.07			5.20	11.00		-3.45	Pass	
11a	6Mbps	2	48	5240	0.08	0.07			5.02	11.00		-3.45	Pass	
HT20	MCS0	2	36	5180	0.07	0.07			4.60	11.00		-3.45	Pass	
HT20	MCS0	2	44	5220	0.07	0.07			4.64	11.00		-3.45	Pass	
HT20	MCS0	2	48	5240	0.07	0.07			4.40	11.00		-3.45	Pass	
HT40	MCS0	2	38	5190	0.12	0.12			2.08	11.00		-3.45	Pass	
HT40	MCS0	2	46	5230	0.12	0.12			1.81	11.00		-3.45	Pass	
VHT80	MCS0	2	42	5210	0.26	0.27			-0.63	11.00		-3.45	Pass	

TEST RESULTS DATA
26dB and 99% OBW

Band II											
Mod.	Data Rate	NTX	CH.	Freq. (MHz)	99% Bandwidth (MHz)		26 dB Bandwidth (MHz)		FCC 26dB Bandwidth Power Limit (dBm)		Note
					Ant 1	Ant 2	Ant 1	Ant 2	Ant 1	Ant 2	
11a	6Mbps	2	52	5260	16.98	16.78	24.68	23.73	23.98		
11a	6Mbps	2	60	5300	16.98	16.78	25.23	24.18	23.98		
11a	6Mbps	2	64	5320	16.93	16.78	25.48	23.88	23.98		
HT20	MCS0	2	52	5260	18.08	17.88	26.32	25.03	23.98		
HT20	MCS0	2	60	5300	18.13	17.88	26.02	24.83	23.98		
HT20	MCS0	2	64	5320	18.08	17.88	26.52	24.53	23.98		
HT40	MCS0	2	54	5270	37.26	36.96	43.61	42.80	23.98		
HT40	MCS0	2	62	5310	37.26	37.06	43.52	43.16	23.98		
VHT80	MCS0	2	58	5290	77.20	76.96	85.99	83.92	23.98		

TEST RESULTS DATA
Average Power Table

FCC Band II												
Mod.	Data Rate	NTX	CH.	Freq. (MHz)	Average Conducted Power (dBm)			FCC Conducted Power Limit (dBm)		DG (dBi)		Pass/Fail
					Ant 1	Ant 2	SUM	Ant 1	Ant 2	Ant 1	Ant 2	
11a	6Mbps	1	52	5260	13.70	11.80		23.98	23.98	-5.30	-4.90	Pass
11a	6Mbps	1	60	5300	13.80	11.60		23.98	23.98	-5.30	-4.90	Pass
11a	6Mbps	1	64	5320	13.80	11.80		23.98	23.98	-5.30	-4.90	Pass
HT20	MCS0	1	52	5260	13.70	11.80		23.98	23.98	-5.30	-4.90	Pass
HT20	MCS0	1	60	5300	13.80	11.70		23.98	23.98	-5.30	-4.90	Pass
HT20	MCS0	1	64	5320	13.80	11.70		23.98	23.98	-5.30	-4.90	Pass
HT40	MCS0	1	54	5270	13.70	11.70		23.98	23.98	-5.30	-4.90	Pass
HT40	MCS0	1	62	5310	13.80	11.70		23.98	23.98	-5.30	-4.90	Pass
VHT20	MCS0	1	52	5260	13.60	11.70		23.98	23.98	-5.30	-4.90	Pass
VHT20	MCS0	1	60	5300	13.70	11.60		23.98	23.98	-5.30	-4.90	Pass
VHT20	MCS0	1	64	5320	13.70	11.60		23.98	23.98	-5.30	-4.90	Pass
VHT40	MCS0	1	54	5270	13.60	11.60		23.98	23.98	-5.30	-4.90	Pass
VHT40	MCS0	1	62	5310	13.70	11.60		23.98	23.98	-5.30	-4.90	Pass
VHT80	MCS0	1	58	5290	13.70	11.60		23.98	23.98	-5.30	-4.90	Pass
11a	6Mbps	2	52	5260	13.90	11.50	15.87	23.98		-4.90		Pass
11a	6Mbps	2	60	5300	13.90	11.80	15.99	23.98		-4.90		Pass
11a	6Mbps	2	64	5320	13.80	11.40	15.77	23.98		-4.90		Pass
HT20	MCS0	2	52	5260	13.90	11.90	16.02	23.98		-4.90		Pass
HT20	MCS0	2	60	5300	14.00	11.80	16.05	23.98		-4.90		Pass
HT20	MCS0	2	64	5320	14.00	11.90	16.09	23.98		-4.90		Pass
HT40	MCS0	2	54	5270	13.80	11.80	15.92	23.98		-4.90		Pass
HT40	MCS0	2	62	5310	13.90	11.90	16.02	23.98		-4.90		Pass
VHT20	MCS0	2	52	5260	13.80	11.90	15.96	23.98		-4.90		Pass
VHT20	MCS0	2	60	5300	13.90	11.80	15.99	23.98		-4.90		Pass
VHT20	MCS0	2	64	5320	13.90	11.90	16.02	23.98		-4.90		Pass
VHT40	MCS0	2	54	5270	13.70	11.70	15.82	23.98		-4.90		Pass
VHT40	MCS0	2	62	5310	13.80	11.80	15.92	23.98		-4.90		Pass
VHT80	MCS0	2	58	5290	14.00	11.90	16.09	23.98		-4.90		Pass

TEST RESULTS DATA
Power Spectral Density

Band II														
Mod.	Data Rate	NTX	CH.	Freq. (MHz)	Duty Factor (dB)		Average Power Density (dBm/MHz)			Average PSD Limit (dBm/MHz)		DG (dBi)		Pass /Fail
					Ant 1	Ant 2	Ant 1	Ant 2	SUM	Ant 1	Ant 2	Ant 1	Ant 2	
11a	6Mbps	2	52	5260	0.08	0.07			5.06	11.00		-2.09	Pass	
11a	6Mbps	2	60	5300	0.08	0.07			5.17	11.00		-2.09	Pass	
11a	6Mbps	2	64	5320	0.08	0.07			5.07	11.00		-2.09	Pass	
HT20	MCS0	2	52	5260	0.07	0.07			4.38	11.00		-2.09	Pass	
HT20	MCS0	2	60	5300	0.07	0.07			4.48	11.00		-2.09	Pass	
HT20	MCS0	2	64	5320	0.07	0.07			4.49	11.00		-2.09	Pass	
HT40	MCS0	2	54	5270	0.12	0.12			2.04	11.00		-2.09	Pass	
HT40	MCS0	2	62	5310	0.12	0.12			1.80	11.00		-2.09	Pass	
VHT80	MCS0	2	58	5290	0.26	0.27			-1.17	11.00		-2.09	Pass	

TEST RESULTS DATA
26dB and 99% OBW

Band III												
Mod.	Data Rate	NTX	CH.	Freq. (MHz)	99% Bandwidth In U-NII 2C (MHz)		26 dB Bandwidth In U-NII 2C (MHz)		FCC 26dB Bandwidth Power Limit (dBm)		6 dB Bandwidth for Straddle Channel (MHz)	
					Ant 1	Ant 2	Ant 1	Ant 2	Ant 1	Ant 2	Ant 1	Ant 2
11a	6Mbps	2	100	5500	16.93	16.78	24.98	24.08	23.98			
11a	6Mbps	2	116	5580	16.98	16.73	25.03	23.83	23.98			
11a	6Mbps	2	140	5700	16.93	16.78	25.33	23.68	23.98			
11a	6Mbps	2	144	5720	13.44	13.39	17.49	16.89	23.28	3.142	3.142	
HT20	MCS0	2	100	5500	18.08	17.83	26.17	24.88	23.98			
HT20	MCS0	2	116	5580	18.13	17.83	25.97	25.18	23.98			
HT20	MCS0	2	140	5700	18.18	17.93	27.02	25.28	23.98			
HT20	MCS0	2	144	5720	14.09	13.94	17.89	17.59	23.45	3.741	3.791	
HT40	MCS0	2	102	5510	37.36	37.16	43.88	43.34	23.98			
HT40	MCS0	2	110	5550	37.46	37.06	43.61	43.25	23.98			
HT40	MCS0	2	134	5670	37.26	37.16	43.43	43.25	23.98			
HT40	MCS0	2	142	5710	33.68	33.48	36.67	36.58	23.98	3.08	3.162	
VHT80	MCS0	2	106	5530	77.32	77.08	85.83	85.35	23.98			
VHT80	MCS0	2	122	5610	77.56	77.08	86.47	85.51	23.98			
VHT80	MCS0	2	138	5690	73.48	73.48	77.52	77.68	23.98	3.2	3.2	

TEST RESULTS DATA
Average Power Table

FCC Band III												
Mod.	Data Rate	NTX	CH.	Freq. (MHz)	Average Conducted Power (dBm)			FCC Conducted Power Limit (dBm)		DG (dBi)		Pass/Fail
					Ant 1	Ant 2	SUM	Ant 1	Ant 2	Ant 1	Ant 2	
11a	6Mbps	1	100	5500	13.60	11.80		23.98	23.98	-5.70	1.30	Pass
11a	6Mbps	1	116	5580	13.60	11.80		23.98	23.98	-5.70	1.30	Pass
11a	6Mbps	1	140	5700	11.40	11.80		23.98	23.98	-5.70	1.30	Pass
11a	6Mbps	1	144	5720	13.60	11.70		23.98	23.98	-5.70	1.30	Pass
HT20	MCS0	1	100	5500	13.70	11.80		23.98	23.98	-5.70	1.30	Pass
HT20	MCS0	1	116	5580	13.70	11.70		23.98	23.98	-5.70	1.30	Pass
HT20	MCS0	1	140	5700	12.40	11.70		23.98	23.98	-5.70	1.30	Pass
HT20	MCS0	1	144	5720	13.60	11.90		23.98	23.98	-5.70	1.30	Pass
HT40	MCS0	1	102	5510	13.70	11.70		23.98	23.98	-5.70	1.30	Pass
HT40	MCS0	1	110	5550	13.70	11.80		23.98	23.98	-5.70	1.30	Pass
HT40	MCS0	1	134	5670	13.80	11.70		23.98	23.98	-5.70	1.30	Pass
HT40	MCS0	1	142	5710	13.70	11.70		23.98	23.98	-5.70	1.30	Pass
VHT20	MCS0	1	100	5500	13.60	11.70		23.98	23.98	-5.70	1.30	Pass
VHT20	MCS0	1	116	5580	13.60	11.60		23.98	23.98	-5.70	1.30	Pass
VHT20	MCS0	1	140	5700	12.40	11.60		23.98	23.98	-5.70	1.30	Pass
VHT20	MCS0	1	144	5720	13.50	11.80		23.98	23.98	-5.70	1.30	Pass
VHT40	MCS0	1	102	5510	13.60	11.60		23.98	23.98	-5.70	1.30	Pass
VHT40	MCS0	1	110	5550	13.60	11.70		23.98	23.98	-5.70	1.30	Pass
VHT40	MCS0	1	134	5670	13.70	11.60		23.98	23.98	-5.70	1.30	Pass
VHT40	MCS0	1	142	5710	13.60	11.60		23.98	23.98	-5.70	1.30	Pass
VHT80	MCS0	1	106	5530	13.60	11.70		23.98	23.98	-5.70	1.30	Pass
VHT80	MCS0	1	122	5610	13.80	11.80		23.98	23.98	-5.70	1.30	Pass
VHT80	MCS0	1	138	5690	13.70	11.70		23.98	23.98	-5.70	1.30	Pass

FCC Band III												
Mod.	Data Rate	NTX	CH.	Freq. (MHz)	Average Conducted Power (dBm)			FCC Conducted Power Limit (dBm)		DG (dBi)		Pass/Fail
					Ant 1	Ant 2	SUM	Ant 1	Ant 2	Ant 1	Ant 2	
11a	6Mbps	2	100	5500	13.90	11.70	15.95	23.98		1.30		Pass
11a	6Mbps	2	116	5580	13.80	11.60	15.85	23.98		1.30		Pass
11a	6Mbps	2	140	5700	11.50	11.50	14.51	23.98		1.30		Pass
11a	6Mbps	2	144	5720	13.70	11.80	15.86	23.28		1.30		Pass
HT20	MCS0	2	100	5500	14.00	12.00	16.12	23.98		1.30		Pass
HT20	MCS0	2	116	5580	14.00	12.00	16.12	23.98		1.30		Pass
HT20	MCS0	2	140	5700	12.20	11.60	14.92	23.98		1.30		Pass
HT20	MCS0	2	144	5720	13.50	11.80	15.74	23.45		1.30		Pass
HT40	MCS0	2	102	5510	13.90	11.90	16.02	23.98		1.30		Pass
HT40	MCS0	2	110	5550	13.90	11.60	15.91	23.98		1.30		Pass
HT40	MCS0	2	134	5670	13.90	11.80	15.99	23.98		1.30		Pass
HT40	MCS0	2	142	5710	13.50	11.90	15.78	23.98		1.30		Pass
VHT20	MCS0	2	100	5500	13.80	11.80	15.92	23.98		1.30		Pass
VHT20	MCS0	2	116	5580	13.80	11.70	15.89	23.98		1.30		Pass
VHT20	MCS0	2	140	5700	12.10	11.60	14.87	23.98		1.30		Pass
VHT20	MCS0	2	144	5720	13.30	11.00	15.31	23.45		1.30		Pass
VHT40	MCS0	2	102	5510	13.80	11.80	15.92	23.98		1.30		Pass
VHT40	MCS0	2	110	5550	13.80	11.50	15.81	23.98		1.30		Pass
VHT40	MCS0	2	134	5670	13.80	11.70	15.89	23.98		1.30		Pass
VHT40	MCS0	2	142	5710	13.40	11.80	15.68	23.98		1.30		Pass
VHT80	MCS0	2	106	5530	13.90	11.90	16.02	23.98		1.30		Pass
VHT80	MCS0	2	122	5610	14.00	11.80	16.05	23.98		1.30		Pass
VHT80	MCS0	2	138	5690	13.60	11.90	15.84	23.98		1.30		Pass

TEST RESULTS DATA
Power Spectral Density

Band III														
Mod.	Data Rate	NTX	CH.	Freq. (MHz)	Duty Factor (dB)		Average Power Density (dBm/MHz)			Average PSD Limit (dBm/MHz)		DG (dBi)		Pass /Fail
					Ant 1	Ant 2	Ant 1	Ant 2	SUM	Ant 1	Ant 2	Ant 1	Ant 2	
11a	6Mbps	2	100	5500	0.08	0.07			5.03	11.00		1.50	Pass	
11a	6Mbps	2	116	5580	0.08	0.07			4.74	11.00		1.50	Pass	
11a	6Mbps	2	140	5700	0.08	0.07			5.04	11.00		1.50	Pass	
11a	6Mbps	2	144	5720	0.08	0.07			5.07	11.00		1.50	Pass	
HT20	MCS0	2	100	5500	0.07	0.07			5.13	11.00		1.50	Pass	
HT20	MCS0	2	116	5580	0.07	0.07			4.40	11.00		1.50	Pass	
HT20	MCS0	2	140	5700	0.07	0.07			2.53	11.00		1.50	Pass	
HT20	MCS0	2	144	5720	0.07	0.07			4.62	11.00		1.50	Pass	
HT40	MCS0	2	102	5510	0.12	0.12			1.90	11.00		1.50	Pass	
HT40	MCS0	2	110	5550	0.12	0.12			1.84	11.00		1.50	Pass	
HT40	MCS0	2	134	5670	0.12	0.12			1.42	11.00		1.50	Pass	
HT40	MCS0	2	142	5710	0.12	0.12			1.26	11.00		1.50	Pass	
VHT80	MCS0	2	106	5530	0.26	0.27			-1.07	11.00		1.50	Pass	
VHT80	MCS0	2	122	5610	0.26	0.27			-1.09	11.00		1.50	Pass	
VHT80	MCS0	2	138	5690	0.26	0.27			-1.52	11.00		1.50	Pass	



Appendix B. AC Conducted Emission Test Results

Test Engineer :	Jimmy Chang	Temperature :	24~26°C
		Relative Humidity :	51~53%

EUT Information

Report NO : 8O2417-03
 Test Mode : Mode 1
 Test Voltage : 120Vac/60Hz
 Phase : Line

Full Spectrum

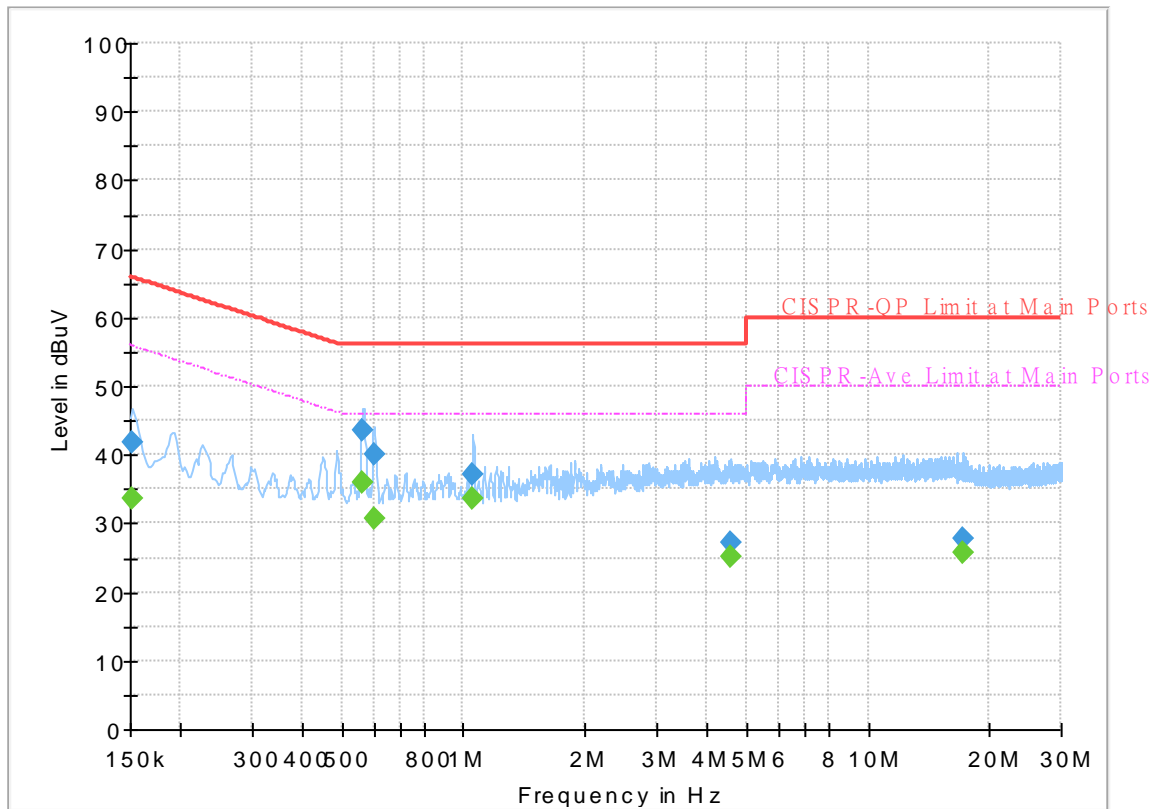

Final_Result

Frequency (MHz)	QuasiPeak (dBuV)	CAverage (dBuV)	Limit (dBuV)	Margin (dB)	Line	Filter	Corr. (dB)
0.152250	---	33.64	55.88	22.24	L1	OFF	19.5
0.152250	41.94	---	65.88	23.94	L1	OFF	19.5
0.564000	---	36.10	46.00	9.90	L1	OFF	19.5
0.564000	43.46	---	56.00	12.54	L1	OFF	19.5
0.600000	---	30.75	46.00	15.25	L1	OFF	19.6
0.600000	40.07	---	56.00	15.93	L1	OFF	19.6
1.054500	---	33.50	46.00	12.50	L1	OFF	19.6
1.054500	37.04	---	56.00	18.96	L1	OFF	19.6
4.553250	---	25.06	46.00	20.94	L1	OFF	19.7
4.553250	27.27	---	56.00	28.73	L1	OFF	19.7
17.173500	---	25.61	50.00	24.39	L1	OFF	20.2
17.173500	27.68	---	60.00	32.32	L1	OFF	20.2

EUT Information

Report NO : 8O2417-03
 Test Mode : Mode 1
 Test Voltage : 120Vac/60Hz
 Phase : Neutral

Full Spectrum

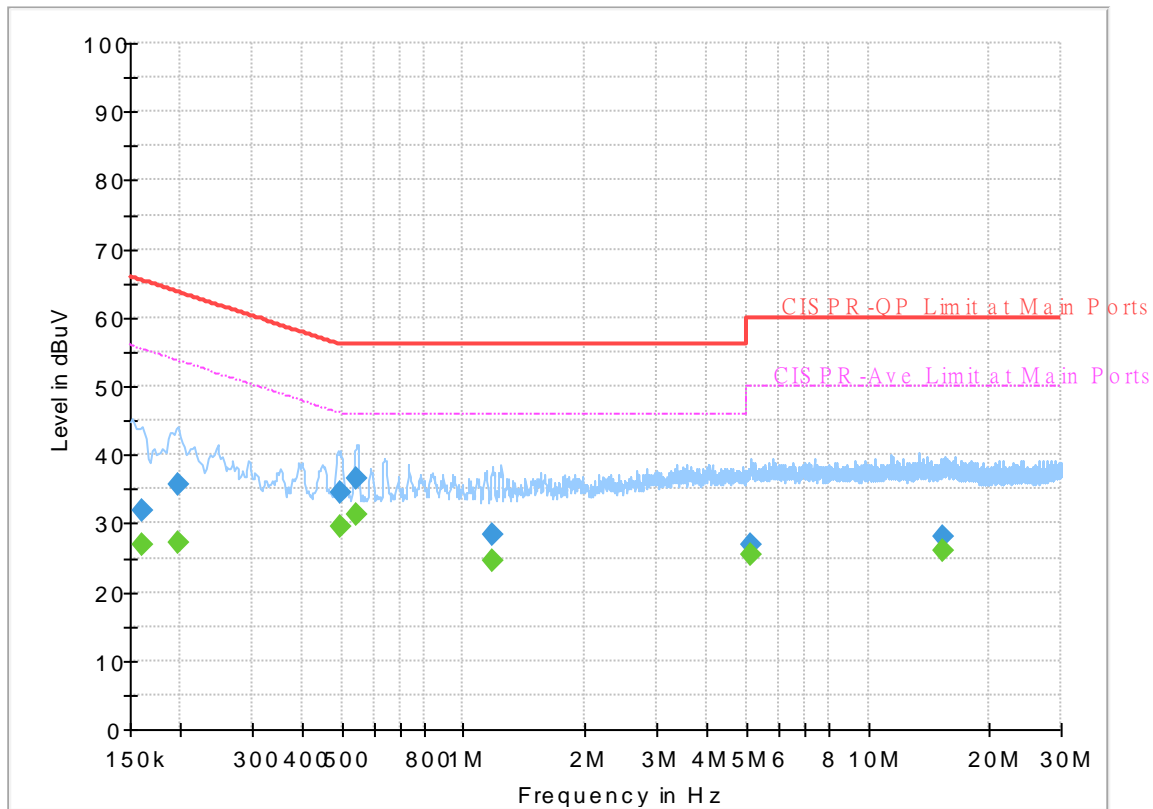

Final Result

Frequency (MHz)	QuasiPeak (dBuV)	CAverage (dBuV)	Limit (dBuV)	Margin (dB)	Line	Filter	Corr. (dB)
0.161250	---	26.84	55.40	28.56	N	OFF	19.5
0.161250	31.90	---	65.40	33.50	N	OFF	19.5
0.197250	---	27.19	53.73	26.54	N	OFF	19.5
0.197250	35.76	---	63.73	27.97	N	OFF	19.5
0.494250	---	29.50	46.10	16.60	N	OFF	19.5
0.494250	34.58	---	56.10	21.52	N	OFF	19.5
0.546000	---	31.15	46.00	14.85	N	OFF	19.5
0.546000	36.50	---	56.00	19.50	N	OFF	19.5
1.176000	---	24.47	46.00	21.53	N	OFF	19.6
1.176000	28.22	---	56.00	27.78	N	OFF	19.6
5.149500	---	25.35	50.00	24.65	N	OFF	19.7
5.149500	27.04	---	60.00	32.96	N	OFF	19.7
15.335250	---	25.93	50.00	24.07	N	OFF	20.1
15.335250	28.20	---	60.00	31.80	N	OFF	20.1



Appendix C. Radiated Spurious Emission

Test Engineer :	Alex Jheng , Fu Chen , Wilson Wu	Temperature :	24.5~25.3°C
		Relative Humidity :	49~55%

Band 1 - 5150~5250MHz
WIFI 802.11a (Band Edge @ 3m)

WIFI Ant.	Note	Frequency	Level	Over Limit	Limit Line	Read Level	Antenna Factor	Path Loss	Preamp Factor	Ant Pos	Table Pos	Peak Avg.	Pol.	
1+2		(MHz)	(dBμV/m)	(dB)	(dBμV/m)	(dBμV)	(dB/m)	(dB)	(dB)	(cm)	(deg)	(P/A)	(H/V)	
802.11a CH 36 5180MHz		5142.22	57.08	-16.92	74	48.8	31.69	6.08	29.49	190	307	P	H	
		5148.2	39.81	-14.19	54	31.53	31.69	6.08	29.49	190	307	A	H	
	*	5180	102.27	-	-	93.95	31.71	6.1	29.49	190	307	P	H	
	*	5180	94.33	-	-	86.01	31.71	6.1	29.49	190	307	A	H	
													H	
			5146.38	57.35	-16.65	74	49.07	31.69	6.08	29.49	202	2	P	V
			5149.76	40.28	-13.72	54	32	31.69	6.08	29.49	202	2	A	V
	*		5180	102.47	-	-	94.15	31.71	6.1	29.49	202	2	P	V
	*		5180	94.68	-	-	86.36	31.71	6.1	29.49	202	2	A	V
														V
802.11a CH 44 5220MHz		5069.94	49.55	-24.45	74	41.34	31.64	6.04	29.47	189	305	P	H	
		5070.46	39.24	-14.76	54	31.03	31.64	6.04	29.47	189	305	A	H	
	*	5220	102.32	-	-	93.98	31.73	6.11	29.5	189	305	P	H	
	*	5220	94.81	-	-	86.47	31.73	6.11	29.5	189	305	A	H	
			5454.12	48.83	-25.17	74	40.33	31.87	6.17	29.54	189	305	P	H
			5452.16	39.75	-14.25	54	31.25	31.87	6.17	29.54	189	305	A	H
			5052	51.13	-22.87	74	42.94	31.63	6.03	29.47	202	2	P	V
			5107.9	39.35	-14.65	54	31.1	31.67	6.06	29.48	202	2	A	V
	*		5220	102.4	-	-	94.06	31.73	6.11	29.5	202	2	P	V
	*		5220	94.94	-	-	86.6	31.73	6.11	29.5	202	2	A	V
			5440.12	49.03	-24.97	74	40.55	31.86	6.16	29.54	202	2	P	V
			5452.72	38.89	-15.11	54	30.39	31.87	6.17	29.54	202	2	A	V



802.11a CH 48 5240MHz		5057.2	49.62	-24.38	74	41.42	31.64	6.03	29.47	187	306	P	H
		5049.92	39.26	-14.74	54	31.07	31.63	6.03	29.47	187	306	A	H
	*	5240	102.75	-	-	94.4	31.74	6.11	29.5	187	306	P	H
	*	5240	95.55	-	-	87.2	31.74	6.11	29.5	187	306	A	H
		5399.52	50.13	-23.87	74	41.7	31.84	6.12	29.53	187	306	P	H
		5352.2	40.85	-13.15	54	32.44	31.81	6.12	29.52	187	306	A	H
		5090.48	49.1	-24.9	74	40.87	31.66	6.05	29.48	188	2	P	V
		5049.4	39.26	-14.74	54	31.07	31.63	6.03	29.47	188	2	A	V
	*	5240	102.89	-	-	94.54	31.74	6.11	29.5	188	2	P	V
	*	5240	95.33	-	-	86.98	31.74	6.11	29.5	188	2	A	V
		5411.84	48.28	-25.72	74	39.83	31.85	6.13	29.53	188	2	P	V
		5352.48	39.81	-14.19	54	31.4	31.81	6.12	29.52	188	2	A	V
Remark	1. No other spurious found. 2. All results are PASS against Peak and Average limit line.												



Band 1 5150~5250MHz
WIFI 802.11a (Harmonic @ 3m)

WIFI Ant. 1+2	Note	Frequency (MHz)	Level (dBμV/m)	Over Limit (dB)	Limit Line (dBμV/m)	Read Level (dBμV)	Antenna Factor (dB/m)	Path Loss (dB)	Preamp Factor (dB)	Ant Pos (cm)	Table Pos (deg)	Peak Avg. (P/A)	Pol. (H/V)
802.11a CH 36 5180MHz		10360	46.71	-21.49	68.2	54	39.76	9.91	56.96	100	0	P	H
		15540	45.82	-28.18	74	51.2	38.62	12.65	56.65	100	0	P	H
													H
													H
		10360	46.45	-21.75	68.2	53.74	39.76	9.91	56.96	100	0	P	V
		15540	46.42	-27.58	74	51.8	38.62	12.65	56.65	100	0	P	V
													V
													V
802.11a CH 44 5220MHz		10440	47.65	-20.55	68.2	54.74	39.88	9.95	56.92	100	0	P	H
		15660	45.21	-28.79	74	50.67	38.33	12.72	56.51	100	0	P	H
													H
													H
		10440	46.66	-21.54	68.2	53.75	39.88	9.95	56.92	100	0	P	V
		15660	44.55	-29.45	74	50.01	38.33	12.72	56.51	100	0	P	V
													V
													V
802.11a CH 48 5240MHz		10480	47.53	-20.67	68.2	54.5	39.97	9.97	56.91	100	0	P	H
		15720	46.94	-27.06	74	52.48	38.16	12.74	56.44	100	0	P	H
													H
													H
		10480	47.32	-20.88	68.2	54.29	39.97	9.97	56.91	100	0	P	V
		15720	45.6	-28.4	74	51.14	38.16	12.74	56.44	100	0	P	V
													V
													V
Remark	1. No other spurious found. 2. All results are PASS against Peak and Average limit line.												



Band 1 5150~5250MHz
WIFI 802.11n HT20 (Band Edge @ 3m)

WIFI Ant. 1+2	Note	Frequency (MHz)	Level (dBμV/m)	Over Limit (dB)	Limit Line (dBμV/m)	Read Level (dBμV)	Antenna Factor (dB/m)	Path Loss (dB)	Preamp Factor (dB)	Ant Pos (cm)	Table Pos (deg)	Peak Avg. (P/A)	Pol. (H/V)	
802.11n HT20 CH 36 5180MHz		5144.82	53.06	-20.94	74	44.78	31.69	6.08	29.49	183	305	P	H	
		5149.76	39.43	-14.57	54	31.15	31.69	6.08	29.49	183	305	A	H	
	*	5180	100.1	-	-	91.78	31.71	6.1	29.49	183	305	P	H	
	*	5180	90.94	-	-	82.62	31.71	6.1	29.49	183	305	A	H	
													H	
														H
			5148.72	55.53	-18.47	74	47.25	31.69	6.08	29.49	202	335	P	V
			5149.24	40.56	-13.44	54	32.28	31.69	6.08	29.49	202	335	A	V
		*	5180	101.56	-	-	93.24	31.71	6.1	29.49	202	335	P	V
		*	5180	92.91	-	-	84.59	31.71	6.1	29.49	202	335	A	V
													V	
													V	
802.11n HT20 CH 44 5220MHz		5082.16	50.3	-23.7	74	42.07	31.65	6.05	29.47	188	306	P	H	
		5057.98	39.26	-14.74	54	31.06	31.64	6.03	29.47	188	306	A	H	
	*	5220	101.64	-	-	93.3	31.73	6.11	29.5	188	306	P	H	
	*	5220	92.41	-	-	84.07	31.73	6.11	29.5	188	306	A	H	
			5448.24	49.28	-24.72	74	40.78	31.87	6.17	29.54	188	306	P	H
			5451.6	39.57	-14.43	54	31.07	31.87	6.17	29.54	188	306	A	H
			5132.34	49.62	-24.38	74	41.35	31.68	6.07	29.48	199	2	P	V
			5107.9	39.29	-14.71	54	31.04	31.67	6.06	29.48	199	2	A	V
		*	5220	101.28	-	-	92.94	31.73	6.11	29.5	199	2	P	V
		*	5220	92.72	-	-	84.38	31.73	6.11	29.5	199	2	A	V
		5439.56	48.28	-25.72	74	39.8	31.86	6.16	29.54	199	2	P	V	
		5451.6	38.74	-15.26	54	30.24	31.87	6.17	29.54	199	2	A	V	



802.11n HT20 CH 48 5240MHz		5021.06	49.73	-24.27	74	41.56	31.62	6.01	29.46	188	307	P	H
		5058.76	39.24	-14.76	54	31.04	31.64	6.03	29.47	188	307	A	H
	*	5240	102	-	-	93.65	31.74	6.11	29.5	188	307	P	H
	*	5240	92.98	-	-	84.63	31.74	6.11	29.5	188	307	A	H
		5351.64	49.64	-24.36	74	41.23	31.81	6.12	29.52	188	307	P	H
		5351.64	40.8	-13.2	54	32.39	31.81	6.12	29.52	188	307	A	H
		5068.9	49.74	-24.26	74	41.53	31.64	6.04	29.47	188	3	P	V
		5072.28	39.25	-14.75	54	31.03	31.65	6.04	29.47	188	3	A	V
	*	5240	101.64	-	-	93.29	31.74	6.11	29.5	188	3	P	V
	*	5240	92.86	-	-	84.51	31.74	6.11	29.5	188	3	A	V
		5371.52	48.69	-25.31	74	40.28	31.82	6.12	29.53	188	3	P	V
		5351.64	39.44	-14.56	54	31.03	31.81	6.12	29.52	188	3	A	V
Remark	1. No other spurious found. 2. All results are PASS against Peak and Average limit line.												



Band 1 5150~5250MHz
WIFI 802.11n HT20 (Harmonic @ 3m)

WIFI Ant. 1+2	Note	Frequency (MHz)	Level (dBμV/m)	Over Limit (dB)	Limit Line (dBμV/m)	Read Level (dBμV)	Antenna Factor (dB/m)	Path Loss (dB)	Preamp Factor (dB)	Ant Pos (cm)	Table Pos (deg)	Peak Avg. (P/A)	Pol. (H/V)
802.11n HT20 CH 36 5180MHz		10360	46.47	-21.73	68.2	53.76	39.76	9.91	56.96	100	0	P	H
		15540	46.01	-27.99	74	51.39	38.62	12.65	56.65	100	0	P	H
													H
													H
		10360	47.01	-21.19	68.2	54.3	39.76	9.91	56.96	100	0	P	V
		15540	46.34	-27.66	74	51.72	38.62	12.65	56.65	100	0	P	V
													V
802.11n HT20 CH 44 5220MHz		10440	47.61	-20.59	68.2	54.7	39.88	9.95	56.92	100	0	P	H
		15660	44.81	-29.19	74	50.27	38.33	12.72	56.51	100	0	P	H
													H
													H
		10440	47.14	-21.06	68.2	54.23	39.88	9.95	56.92	100	0	P	V
		15660	45.21	-28.79	74	50.67	38.33	12.72	56.51	100	0	P	V
													V
802.11n HT20 CH 48 5240MHz		10480	47.44	-20.76	68.2	54.41	39.97	9.97	56.91	100	0	P	H
		15720	45.45	-28.55	74	50.99	38.16	12.74	56.44	100	0	P	H
													H
													H
		10480	47.37	-20.83	68.2	54.34	39.97	9.97	56.91	100	0	P	V
		15720	45.64	-28.36	74	51.18	38.16	12.74	56.44	100	0	P	V
													V
Remark	1. No other spurious found.												
	2. All results are PASS against Peak and Average limit line.												



Band 1 5150~5250MHz
WIFI 802.11n HT40 (Band Edge @ 3m)

Table with 14 columns: WIFI Ant. 1+2, Note, Frequency (MHz), Level (dBµV/m), Over Limit (dB), Limit Line (dBµV/m), Read Level (dBµV), Antenna Factor (dB/m), Path Loss (dB), Preamp Factor (dB), Ant Pos (cm), Table Pos (deg), Peak Avg. (P/A), Pol. (H/V). Rows include data for 802.11n HT40 CH 38 (5190MHz) and 802.11n HT40 CH 46 (5230MHz).

Remark
1. No other spurious found.
2. All results are PASS against Peak and Average limit line.



**Band 1 5150~5250MHz
WIFI 802.11n HT40 (Harmonic @ 3m)**

WIFI Ant. 1+2	Note	Frequency (MHz)	Level (dBμV/m)	Over Limit (dB)	Limit Line (dBμV/m)	Read Level (dBμV)	Antenna Factor (dB/m)	Path Loss (dB)	Preamp Factor (dB)	Ant Pos (cm)	Table Pos (deg)	Peak Avg. (P/A)	Pol. (H/V)
802.11n HT40 CH 38 5190MHz		10380	46.62	-21.58	68.2	53.86	39.79	9.92	56.95	100	0	P	H
		15570	46.34	-27.66	74	51.77	38.53	12.66	56.62	100	0	P	H
													H
													H
		10380	46.36	-21.84	68.2	53.6	39.79	9.92	56.95	100	0	P	V
		15570	46.19	-27.81	74	51.62	38.53	12.66	56.62	100	0	P	V
													V
													V
802.11n HT40 CH 46 5230MHz		10460	47.56	-20.64	68.2	54.61	39.91	9.96	56.92	100	0	P	H
		15690	45.82	-28.18	74	51.33	38.24	12.72	56.47	100	0	P	H
													H
													H
		10460	47.04	-21.16	68.2	54.09	39.91	9.96	56.92	100	0	P	V
		15690	46.02	-27.98	74	51.53	38.24	12.72	56.47	100	0	P	V
													V
													V
Remark	1. No other spurious found. 2. All results are PASS against Peak and Average limit line.												



Band 1 5150~5250MHz
WIFI 802.11ac VHT80 (Band Edge @ 3m)

Table with 14 columns: WIFI Ant. 1+2, Note, Frequency (MHz), Level (dBµV/m), Over Limit (dB), Limit Line (dBµV/m), Read Level (dBµV), Antenna Factor (dB/m), Path Loss (dB), Preamp Factor (dB), Ant Pos (cm), Table Pos (deg), Peak Avg. (P/A), Pol. (H/V). Rows include test results for 802.11ac VHT80 CH 42 5210MHz and a Remark section.



**Band 1 5150~5250MHz
WIFI 802.11ac VHT80 (Harmonic @ 3m)**

WIFI Ant. 1+2	Note	Frequency (MHz)	Level (dBμV/m)	Over Limit (dB)	Limit Line (dBμV/m)	Read Level (dBμV)	Antenna Factor (dB/m)	Path Loss (dB)	Preamp Factor (dB)	Ant Pos (cm)	Table Pos (deg)	Peak Avg. (P/A)	Pol. (H/V)	
802.11ac VHT80 CH 42 5210MHz		10420	47.68	-20.52	68.2	54.82	39.85	9.94	56.93	100	0	P	H	
		15630	45.1	-28.9	74	50.57	38.37	12.7	56.54	100	0	P	H	
													H	
													H	
			10420	47.08	-21.12	68.2	54.22	39.85	9.94	56.93	100	0	P	V
			15630	44.39	-29.61	74	49.86	38.37	12.7	56.54	100	0	P	V
														V
														V
Remark	1. No other spurious found. 2. All results are PASS against Peak and Average limit line.													



Band 2 - 5250~5350MHz
WIFI 802.11a (Band Edge @ 3m)

WIFI Ant. 1+2	Note	Frequency (MHz)	Level (dBμV/m)	Over Limit (dB)	Limit Line (dBμV/m)	Read Level (dBμV)	Antenna Factor (dB/m)	Path Loss (dB)	Preamp Factor (dB)	Ant Pos (cm)	Table Pos (deg)	Peak Avg. (P/A)	Pol. (H/V)
802.11a CH 52 5260MHz		5048.62	50.71	-23.29	74	42.52	31.63	6.03	29.47	185	307	P	H
		5049.64	39.24	-14.76	54	31.05	31.63	6.03	29.47	185	307	A	H
	*	5260	103.26	-	-	94.9	31.76	6.11	29.51	185	307	P	H
	*	5260	95.64	-	-	87.28	31.76	6.11	29.51	185	307	A	H
		5353.2	51.81	-22.19	74	43.4	31.81	6.12	29.52	185	307	P	H
		5372.88	39.88	-14.12	54	31.47	31.82	6.12	29.53	185	307	A	H
		5063.24	50.25	-23.75	74	42.05	31.64	6.03	29.47	183	2	P	V
		5075.48	39.25	-14.75	54	31.03	31.65	6.04	29.47	183	2	A	V
	*	5260	102.59	-	-	94.23	31.76	6.11	29.51	183	2	P	V
	*	5260	95.18	-	-	86.82	31.76	6.11	29.51	183	2	A	V
		5350.32	49.79	-24.21	74	41.38	31.81	6.12	29.52	183	2	P	V
		5372.16	38.76	-15.24	54	30.35	31.82	6.12	29.53	183	2	A	V
802.11a CH 60 5300MHz		5038.42	49.21	-24.79	74	41.03	31.63	6.02	29.47	182	306	P	H
		5049.64	39.26	-14.74	54	31.07	31.63	6.03	29.47	182	306	A	H
	*	5300	104.55	-	-	96.17	31.78	6.11	29.51	182	306	P	H
	*	5300	96.77	-	-	88.39	31.78	6.11	29.51	182	306	A	H
		5352.48	58.1	-15.9	74	49.69	31.81	6.12	29.52	182	306	P	H
		5412.24	40.79	-13.21	54	32.34	31.85	6.13	29.53	182	306	A	H
		5095.88	49.69	-24.31	74	41.46	31.66	6.05	29.48	190	2	P	V
		5049.98	39.23	-14.77	54	31.04	31.63	6.03	29.47	190	2	A	V
	*	5300	103.03	-	-	94.65	31.78	6.11	29.51	190	2	P	V
	*	5300	95.36	-	-	86.98	31.78	6.11	29.51	190	2	A	V
		5355.6	52.03	-21.97	74	43.62	31.81	6.12	29.52	190	2	P	V
		5412.48	39.26	-14.74	54	30.81	31.85	6.13	29.53	190	2	A	V



802.11a CH 64 5320MHz	*	5320	105.17	-	-	96.78	31.79	6.12	29.52	177	307	P	H
	*	5320	97.32	-	-	88.93	31.79	6.12	29.52	177	307	A	H
		5352.64	60.29	-13.71	74	51.88	31.81	6.12	29.52	177	307	P	H
		5352	43.27	-10.73	54	34.86	31.81	6.12	29.52	177	307	A	H
													H
													H
	*	5320	103.14	-	-	94.75	31.79	6.12	29.52	204	339	P	V
	*	5320	96.69	-	-	88.3	31.79	6.12	29.52	204	339	A	V
		5355.84	54.41	-19.59	74	46	31.81	6.12	29.52	204	339	P	V
		5352.32	41.19	-12.81	54	32.78	31.81	6.12	29.52	204	339	A	V
													V
													V
Remark	1. No other spurious found. 2. All results are PASS against Peak and Average limit line.												



Band 2 5250~5350MHz
WIFI 802.11a (Harmonic @ 3m)

WIFI Ant. 1+2	Note	Frequency (MHz)	Level (dBμV/m)	Over Limit (dB)	Limit Line (dBμV/m)	Read Level (dBμV)	Antenna Factor (dB/m)	Path Loss (dB)	Preamp Factor (dB)	Ant Pos (cm)	Table Pos (deg)	Peak Avg. (P/A)	Pol. (H/V)	
802.11a CH 52 5260MHz		10520	48.48	-19.72	68.2	55.34	40.02	10	56.88	100	0	P	H	
		15780	45.1	-28.9	74	50.64	38.04	12.78	56.36	100	0	P	H	
													H	
													H	
			10520	47.82	-20.38	68.2	54.68	40.02	10	56.88	100	0	P	V
			15780	46.14	-27.86	74	51.68	38.04	12.78	56.36	100	0	P	V
														V
														V
802.11a CH 60 5300MHz		10600	47.35	-26.65	74	54.03	40.1	10.04	56.82	100	0	P	H	
		15900	45.56	-28.44	74	51.19	37.75	12.84	56.22	100	0	P	H	
													H	
													H	
			10600	47.79	-26.21	74	54.47	40.1	10.04	56.82	100	0	P	V
			15900	44.87	-29.13	74	50.5	37.75	12.84	56.22	100	0	P	V
														V
														V
802.11a CH 64 5320MHz		10640	47.93	-26.07	74	54.53	40.14	10.05	56.79	100	0	P	H	
		15960	46.47	-27.53	74	52.17	37.58	12.87	56.15	100	0	P	H	
													H	
													H	
			10640	47.21	-26.79	74	53.81	40.14	10.05	56.79	100	0	P	V
			15960	44.99	-29.01	74	50.69	37.58	12.87	56.15	100	0	P	V
														V
														V
Remark	1. No other spurious found. 2. All results are PASS against Peak and Average limit line.													



Band 2 5250~5350MHz
WIFI 802.11n HT20 (Band Edge @ 3m)

WIFI Ant. 1+2	Note	Frequency (MHz)	Level (dBμV/m)	Over Limit (dB)	Limit Line (dBμV/m)	Read Level (dBμV)	Antenna Factor (dB/m)	Path Loss (dB)	Preamp Factor (dB)	Ant Pos (cm)	Table Pos (deg)	Peak Avg. (P/A)	Pol. (H/V)
802.11n HT20 CH 52 5260MHz		5058.82	50.77	-23.23	74	42.57	31.64	6.03	29.47	182	307	P	H
		5062.22	39.24	-14.76	54	31.04	31.64	6.03	29.47	182	307	A	H
	*	5260	102.68	-	-	94.32	31.76	6.11	29.51	182	307	P	H
	*	5260	93.54	-	-	85.18	31.76	6.11	29.51	182	307	A	H
		5358.48	51.72	-22.28	74	43.31	31.81	6.12	29.52	182	307	P	H
		5371.68	40.67	-13.33	54	32.26	31.82	6.12	29.53	182	307	A	H
		5091.8	50.5	-23.5	74	42.27	31.66	6.05	29.48	183	2	P	V
		5053.72	39.24	-14.76	54	31.05	31.63	6.03	29.47	183	2	A	V
	*	5260	101.34	-	-	92.98	31.76	6.11	29.51	183	2	P	V
	*	5260	92.69	-	-	84.33	31.76	6.11	29.51	183	2	A	V
		5355.12	51.97	-22.03	74	43.56	31.81	6.12	29.52	183	2	P	V
		5371.68	39.21	-14.79	54	30.8	31.82	6.12	29.53	183	2	A	V
802.11n HT20 CH 60 5300MHz		5009.86	50.19	-23.81	74	42.03	31.61	6.01	29.46	182	307	P	H
		5051	39.25	-14.75	54	31.06	31.63	6.03	29.47	182	307	A	H
	*	5300	103.5	-	-	95.12	31.78	6.11	29.51	182	307	P	H
	*	5300	94.65	-	-	86.27	31.78	6.11	29.51	182	307	A	H
		5352.24	57.9	-16.1	74	49.49	31.81	6.12	29.52	182	307	P	H
		5350.8	40.67	-13.33	54	32.26	31.81	6.12	29.52	182	307	A	H
		5041.14	49.06	-24.94	74	40.88	31.63	6.02	29.47	192	2	P	V
		5039.1	39.25	-14.75	54	31.07	31.63	6.02	29.47	192	2	A	V
	*	5300	101.82	-	-	93.44	31.78	6.11	29.51	192	2	P	V
	*	5300	92.91	-	-	84.53	31.78	6.11	29.51	192	2	A	V
	5363.76	49.17	-24.83	74	40.76	31.82	6.12	29.53	192	2	P	V	
	5352.24	39.18	-14.82	54	30.77	31.81	6.12	29.52	192	2	A	V	



802.11n HT20 CH 64 5320MHz	*	5320	104.51	-	-	96.12	31.79	6.12	29.52	179	306	P	H
	*	5320	95.24	-	-	86.85	31.79	6.12	29.52	179	306	A	H
		5352.32	62.02	-11.98	74	53.61	31.81	6.12	29.52	179	306	P	H
		5350.08	41.18	-12.82	54	32.77	31.81	6.12	29.52	179	306	A	H
													H
													H
	*	5320	101.73	-	-	93.34	31.79	6.12	29.52	190	337	P	V
	*	5320	93.35	-	-	84.96	31.79	6.12	29.52	190	337	A	V
		5353.92	59.7	-14.3	74	51.29	31.81	6.12	29.52	190	337	P	V
		5352.48	39.81	-14.19	54	31.4	31.81	6.12	29.52	190	337	A	V
													V
													V
Remark	1. No other spurious found. 2. All results are PASS against Peak and Average limit line.												



Band 2 5250~5350MHz
WIFI 802.11n HT20 (Harmonic @ 3m)

WIFI Ant. 1+2	Note	Frequency (MHz)	Level (dBμV/m)	Over Limit (dB)	Limit Line (dBμV/m)	Read Level (dBμV)	Antenna Factor (dB/m)	Path Loss (dB)	Preamp Factor (dB)	Ant Pos (cm)	Table Pos (deg)	Peak Avg. (P/A)	Pol. (H/V)	
802.11n HT20 CH 52 5260MHz		10520	48.46	-19.74	68.2	55.32	40.02	10	56.88	100	0	P	H	
		15780	44.47	-29.53	74	50.01	38.04	12.78	56.36	100	0	P	H	
													H	
													H	
			10520	48.92	-19.28	68.2	55.78	40.02	10	56.88	100	0	P	V
			15780	44.8	-29.2	74	50.34	38.04	12.78	56.36	100	0	P	V
														V
802.11n HT20 CH 60 5300MHz		10600	46.99	-27.01	74	53.67	40.1	10.04	56.82	100	0	P	H	
		15900	44.82	-29.18	74	50.45	37.75	12.84	56.22	100	0	P	H	
													H	
													H	
			10600	47.29	-26.71	74	53.97	40.1	10.04	56.82	100	0	P	V
			15900	44.89	-29.11	74	50.52	37.75	12.84	56.22	100	0	P	V
														V
802.11n HT20 CH 64 5320MHz		10640	47.44	-26.56	74	54.04	40.14	10.05	56.79	100	0	P	V	
		15960	45.65	-28.35	74	51.35	37.58	12.87	56.15	100	0	P	V	
													H	
													H	
			10640	47.69	-26.31	74	54.29	40.14	10.05	56.79	100	0	P	V
			15960	44.75	-29.25	74	50.45	37.58	12.87	56.15	100	0	P	V
														V
Remark	1. No other spurious found.													
	2. All results are PASS against Peak and Average limit line.													



Band 2 5250~5350MHz
WIFI 802.11n HT40 (Band Edge @ 3m)

WIFI Ant. 1+2	Note	Frequency (MHz)	Level (dBμV/m)	Over Limit (dB)	Limit Line (dBμV/m)	Read Level (dBμV)	Antenna Factor (dB/m)	Path Loss (dB)	Preamp Factor (dB)	Ant Pos (cm)	Table Pos (deg)	Peak Avg. (P/A)	Pol. (H/V)
802.11n HT40 CH 54 5270MHz		5070.04	49.89	-24.11	74	41.68	31.64	6.04	29.47	184	306	P	H
		5071.06	40.25	-13.75	54	32.04	31.64	6.04	29.47	184	306	A	H
	*	5270	100.57	-	-	92.21	31.76	6.11	29.51	184	306	P	H
	*	5270	92	-	-	83.64	31.76	6.11	29.51	184	306	A	H
		5373.84	57.68	-16.32	74	49.27	31.82	6.12	29.53	184	306	P	H
		5372.88	49.44	-4.56	54	41.03	31.82	6.12	29.53	184	306	A	H
		5031.62	49.84	-24.16	74	41.67	31.62	6.02	29.47	195	2	P	V
		5097.58	40.27	-13.73	54	32.04	31.66	6.05	29.48	195	2	A	V
	*	5270	98.9	-	-	90.54	31.76	6.11	29.51	195	2	P	V
	*	5270	91.12	-	-	82.76	31.76	6.11	29.51	195	2	A	V
		5373.84	55.28	-18.72	74	46.87	31.82	6.12	29.53	195	2	P	V
		5373.84	46.59	-7.41	54	38.18	31.82	6.12	29.53	195	2	A	V
802.11n HT40 CH 62 5310MHz		5031.62	49.45	-24.55	74	41.28	31.62	6.02	29.47	178	307	P	H
		5021.08	40.32	-13.68	54	32.15	31.62	6.01	29.46	178	307	A	H
	*	5310	101.58	-	-	93.19	31.79	6.12	29.52	178	307	P	H
	*	5310	93.34	-	-	84.95	31.79	6.12	29.52	178	307	A	H
		5358.96	61.26	-12.74	74	52.85	31.81	6.12	29.52	178	307	P	H
		5413.2	49.31	-4.69	54	40.86	31.85	6.13	29.53	178	307	A	H
		5037.4	49.31	-24.69	74	41.14	31.62	6.02	29.47	203	337	P	V
		5073.78	40.29	-13.71	54	32.07	31.65	6.04	29.47	203	337	A	V
	*	5310	99.45	-	-	91.06	31.79	6.12	29.52	203	337	P	V
	*	5310	91.31	-	-	82.92	31.79	6.12	29.52	203	337	A	V
	5350.56	57.31	-16.69	74	48.9	31.81	6.12	29.52	203	337	P	V	
	5412.72	45.98	-8.02	54	37.53	31.85	6.13	29.53	203	337	A	V	
Remark	1. No other spurious found. 2. All results are PASS against Peak and Average limit line.												



Band 2 5250~5350MHz
WIFI 802.11n HT40 (Harmonic @ 3m)

WIFI Ant. 1+2	Note	Frequency (MHz)	Level (dBμV/m)	Over Limit (dB)	Limit Line (dBμV/m)	Read Level (dBμV)	Antenna Factor (dB/m)	Path Loss (dB)	Preamp Factor (dB)	Ant Pos (cm)	Table Pos (deg)	Peak Avg. (P/A)	Pol. (H/V)	
802.11n HT40 CH 54 5270MHz		10540	47.5	-20.7	68.2	54.33	40.03	10.01	56.87	100	0	P	H	
		15810	44.64	-29.36	74	50.21	37.96	12.8	56.33	100	0	P	H	
													H	
													H	
			10540	47.11	-21.09	68.2	53.94	40.03	10.01	56.87	100	0	P	V
			15810	45.15	-28.85	74	50.72	37.96	12.8	56.33	100	0	P	V
														V
802.11n HT40 CH 62 5310MHz		10620	46.83	-27.17	74	53.47	40.12	10.04	56.8	100	0	P	H	
		15930	44.34	-29.66	74	49.99	37.67	12.86	56.18	100	0	P	H	
													H	
													H	
			10620	47.69	-26.31	74	54.33	40.12	10.04	56.8	100	0	P	V
			15930	44.84	-29.16	74	50.49	37.67	12.86	56.18	100	0	P	V
														V
Remark	1. No other spurious found.													
	2. All results are PASS against Peak and Average limit line.													



Band 2 5250~5350MHz
WIFI 802.11ac VHT80 (Band Edge @ 3m)

WIFI Ant. 1+2	Note	Frequency (MHz)	Level (dBμV/m)	Over Limit (dB)	Limit Line (dBμV/m)	Read Level (dBμV)	Antenna Factor (dB/m)	Path Loss (dB)	Preamp Factor (dB)	Ant Pos (cm)	Table Pos (deg)	Peak Avg. (P/A)	Pol. (H/V)
802.11ac VHT80 CH 58 5290MHz		5091.46	49.65	-24.35	74	41.42	31.66	6.05	29.48	179	307	P	H
		5078.54	40.99	-13.01	54	32.77	31.65	6.04	29.47	179	307	A	H
	*	5290	99.72	-	-	91.35	31.77	6.11	29.51	179	307	P	H
	*	5290	91.36	-	-	82.99	31.77	6.11	29.51	179	307	A	H
		5382.72	62.51	-11.49	74	54.09	31.83	6.12	29.53	179	307	P	H
		5369.04	49.63	-4.37	54	41.22	31.82	6.12	29.53	179	307	A	H
		5032.64	50.22	-23.78	74	42.05	31.62	6.02	29.47	204	339	P	V
		5124.1	40.96	-13.04	54	32.69	31.68	6.07	29.48	204	339	A	V
	*	5290	97.45	-	-	89.08	31.77	6.11	29.51	204	339	P	V
	*	5290	89.26	-	-	80.89	31.77	6.11	29.51	204	339	A	V
		5354.64	62.2	-11.8	74	53.79	31.81	6.12	29.52	204	339	P	V
	5353.68	48.15	-5.85	54	39.74	31.81	6.12	29.52	204	339	A	V	
Remark	1. No other spurious found. 2. All results are PASS against Peak and Average limit line.												



Band 2 5250~5350MHz

WIFI 802.11ac VHT80 (Harmonic @ 3m)

WIFI Ant. 1+2	Note	Frequency (MHz)	Level (dBμV/m)	Over Limit (dB)	Limit Line (dBμV/m)	Read Level (dBμV)	Antenna Factor (dB/m)	Path Loss (dB)	Preamp Factor (dB)	Ant Pos (cm)	Table Pos (deg)	Peak Avg. (P/A)	Pol. (H/V)	
802.11ac VHT80 CH 58 5290MHz		10580	46.64	-21.56	68.2	53.36	40.09	10.03	56.84	100	0	P	H	
		15870	45.28	-28.72	74	50.93	37.79	12.82	56.26	100	0	P	H	
													H	
													H	
			10580	46.96	-21.24	68.2	53.68	40.09	10.03	56.84	100	0	P	V
			15870	45.22	-28.78	74	50.87	37.79	12.82	56.26	100	0	P	V
														V
														V
Remark	1. No other spurious found. 2. All results are PASS against Peak and Average limit line.													



Band 3 - 5470~5725MHz
WIFI 802.11a (Band Edge @ 3m)

WIFI Ant. 1+2	Note	Frequency (MHz)	Level (dBμV/m)	Over Limit (dB)	Limit Line (dBμV/m)	Read Level (dBμV)	Antenna Factor (dB/m)	Path Loss (dB)	Preamp Factor (dB)	Ant Pos (cm)	Table Pos (deg)	Peak Avg. (P/A)	Pol. (H/V)	
802.11a CH 100 5500MHz		5456.72	54.02	-19.98	74	45.51	31.87	6.18	29.54	137	10	P	H	
		5470	59.41	-8.79	68.2	50.88	31.88	6.19	29.54	137	10	P	H	
		5459.12	41.52	-12.48	54	33.01	31.87	6.18	29.54	137	10	A	H	
	*	5500	107.62	-	-	99.05	31.9	6.22	29.55	137	10	P	H	
	*	5500	99.86	-	-	91.29	31.9	6.22	29.55	137	10	A	H	
														H
			5458.48	53.87	-20.13	74	45.36	31.87	6.18	29.54	366	360	P	V
			5469.2	55.94	-12.26	68.2	47.41	31.88	6.19	29.54	366	360	P	V
			5457.84	39.57	-14.43	54	31.06	31.87	6.18	29.54	366	360	A	V
	*		5500	103.59	-	-	95.02	31.9	6.22	29.55	366	360	P	V
	*		5500	96.07	-	-	87.5	31.9	6.22	29.55	366	360	A	V
														V
802.11a CH 116 5580MHz		5407.84	48.65	-25.35	74	40.21	31.84	6.13	29.53	120	8	P	H	
		5467.6	49.22	-18.98	68.2	40.69	31.88	6.19	29.54	120	8	P	H	
		5452.72	39.07	-14.93	54	30.57	31.87	6.17	29.54	120	8	A	H	
	*	5580	107.65	-	-	98.9	32	6.3	29.55	120	8	P	H	
	*	5580	100.25	-	-	91.5	32	6.3	29.55	120	8	A	H	
			5727.515	48.39	-19.81	68.2	39.36	32.21	6.37	29.55	120	8	P	H
			5423.44	48.86	-25.14	74	40.41	31.85	6.14	29.54	357	0	P	V
			5467.84	48.31	-19.89	68.2	39.78	31.88	6.19	29.54	357	0	P	V
			5452.24	38.62	-15.38	54	30.12	31.87	6.17	29.54	357	0	A	V
	*		5580	102.6	-	-	93.85	32	6.3	29.55	357	0	P	V
	*		5580	95.27	-	-	86.52	32	6.3	29.55	357	0	A	V
			5765	48.71	-19.49	68.2	39.62	32.26	6.39	29.56	357	0	P	V



802.11a CH 140 5700MHz	*	5700	109.41	-	-	100.43	32.17	6.36	29.55	125	7	P	H
	*	5700	100.82	-	-	91.84	32.17	6.36	29.55	125	7	A	H
		5727.24	64.07	-4.13	68.2	55.04	32.21	6.37	29.55	125	7	P	H
													H
													H
													H
	*	5700	102.68	-	-	93.7	32.17	6.36	29.55	281	346	P	V
	*	5700	95.05	-	-	86.07	32.17	6.36	29.55	281	346	A	V
		5726.52	59.89	-8.31	68.2	50.86	32.21	6.37	29.55	281	346	P	V
													V
													V
													V
	Remark	1. No other spurious found. 2. All results are PASS against Peak and Average limit line.											



**Band 3 - 5470~5725MHz
WIFI 802.11a (Harmonic @ 3m)**

WIFI Ant. 1+2	Note	Frequency (MHz)	Level (dBµV/m)	Over Limit (dB)	Limit Line (dBµV/m)	Read Level (dBµV)	Antenna Factor (dB/m)	Path Loss (dB)	Preamp Factor (dB)	Ant Pos (cm)	Table Pos (deg)	Peak Avg. (P/A)	Pol. (H/V)	
802.11a CH 100 5500MHz		11000	47.19	-26.81	74	52.97	40.5	10.22	56.5	100	0	P	H	
		16500	46.86	-21.34	68.2	50.37	39.4	12.79	55.7	100	0	P	H	
													H	
													H	
			11000	47.84	-26.16	74	53.62	40.5	10.22	56.5	100	0	P	V
			16500	47.31	-20.89	68.2	50.82	39.4	12.79	55.7	100	0	P	V
														V
														V
802.11a CH 116 5580MHz		11160	46.79	-27.21	74	52.63	40.3	10.3	56.44	100	0	P	H	
		16740	46.86	-21.34	68.2	50.32	39.69	12.74	55.89	100	0	P	H	
													H	
													H	
			11160	47.72	-26.28	74	53.56	40.3	10.3	56.44	100	0	P	V
			16740	47.47	-20.73	68.2	50.93	39.69	12.74	55.89	100	0	P	V
														V
														V
802.11a CH 140 5700MHz		11400	47.37	-26.63	74	53.27	40.02	10.41	56.34	100	0	P	H	
		17100	48.83	-19.37	68.2	51.97	40.36	12.8	56.3	100	0	P	H	
													H	
													H	
			11400	47.54	-26.46	74	53.44	40.02	10.42	56.34	100	0	P	V
			17100	48.85	-19.35	68.2	51.99	40.36	12.8	56.3	100	0	P	V
														V
														V
Remark	1. No other spurious found. 2. All results are PASS against Peak and Average limit line.													



Band 3 - 5470~5725MHz
WIFI 802.11n HT20 (Band Edge @ 3m)

WIFI Ant. 1+2	Note	Frequency (MHz)	Level (dBμV/m)	Over Limit (dB)	Limit Line (dBμV/m)	Read Level (dBμV)	Antenna Factor (dB/m)	Path Loss (dB)	Preamp Factor (dB)	Ant Pos (cm)	Table Pos (deg)	Peak Avg. (P/A)	Pol. (H/V)	
802.11n HT20 CH 100 5500MHz		5457.84	61.34	-12.66	74	52.83	31.87	6.18	29.54	116	7	P	H	
		5466.32	63.39	-4.81	68.2	54.86	31.88	6.19	29.54	116	7	P	H	
		5460	41.62	-12.38	54	33.11	31.87	6.18	29.54	116	7	A	H	
	*	5500	106.88	-	-	98.31	31.9	6.22	29.55	116	7	P	H	
	*	5500	98.32	-	-	89.75	31.9	6.22	29.55	116	7	A	H	
														H
			5459.44	58.08	-15.92	74	49.57	31.87	6.18	29.54	367	360	P	V
			5461.2	59.62	-8.58	68.2	51.11	31.87	6.18	29.54	367	360	P	V
			5459.92	39.57	-14.43	54	31.06	31.87	6.18	29.54	367	360	A	V
	*		5500	102.62	-	-	94.05	31.9	6.22	29.55	367	360	P	V
	*		5500	93.62	-	-	85.05	31.9	6.22	29.55	367	360	A	V
														V
802.11n HT20 CH 116 5580MHz		5452.24	49.18	-24.82	74	40.68	31.87	6.17	29.54	113	6	P	H	
		5460.64	48.61	-19.59	68.2	40.1	31.87	6.18	29.54	113	6	P	H	
		5451.76	38.85	-15.15	54	30.35	31.87	6.17	29.54	113	6	A	H	
	*	5580	106.6	-	-	97.85	32	6.3	29.55	113	6	P	H	
	*	5580	98.08	-	-	89.33	32	6.3	29.55	113	6	A	H	
			5738.54	50.5	-17.7	68.2	41.43	32.24	6.38	29.55	113	6	P	H
			5458.72	49.52	-24.48	74	41.01	31.87	6.18	29.54	354	341	P	V
			5464.96	48.12	-20.08	68.2	39.6	31.88	6.18	29.54	354	341	P	V
			5453.44	38.45	-15.55	54	29.95	31.87	6.17	29.54	354	341	A	V
	*		5580	101.15	-	-	92.4	32	6.3	29.55	354	341	P	V
	*		5580	92.69	-	-	83.94	32	6.3	29.55	354	341	A	V
			5748.62	48.58	-19.62	68.2	39.51	32.24	6.38	29.55	354	341	P	V



802.11n HT20 CH 140 5700MHz	*	5700	105.13	-	-	96.15	32.17	6.36	29.55	124	8	P	H
	*	5700	96.42	-	-	87.44	32.17	6.36	29.55	124	8	A	H
		5725.96	64.65	-3.55	68.2	55.62	32.21	6.37	29.55	124	8	P	H
													H
													H
													H
	*	5700	98.17	-	-	89.19	32.17	6.36	29.55	278	345	P	V
	*	5700	89.56	-	-	80.58	32.17	6.36	29.55	278	345	A	V
		5726.76	55.19	-13.01	68.2	46.16	32.21	6.37	29.55	278	345	P	V
													V
													V
												V	
Remark	1. No other spurious found. 2. All results are PASS against Peak and Average limit line.												



Band 3 - 5470~5725MHz
WIFI 802.11n HT20 (Harmonic @ 3m)

WIFI Ant. 1+2	Note	Frequency (MHz)	Level (dBμV/m)	Over Limit (dB)	Limit Line (dBμV/m)	Read Level (dBμV)	Antenna Factor (dB/m)	Path Loss (dB)	Preamp Factor (dB)	Ant Pos (cm)	Table Pos (deg)	Peak Avg. (P/A)	Pol. (H/V)
802.11n HT20 CH 100 5500MHz		11000	48.34	-25.66	74	54.12	40.5	10.22	56.5	100	0	P	H
		16500	47.51	-20.69	68.2	51.02	39.4	12.79	55.7	100	0	P	H
													H
													H
		11000	48.02	-25.98	74	53.8	40.5	10.22	56.5	100	0	P	V
		16500	46.38	-21.82	68.2	49.89	39.4	12.79	55.7	100	0	P	V
													V
													V
802.11n HT20 CH 116 5580MHz		11160	48.2	-25.8	74	54.04	40.3	10.3	56.44	100	0	P	H
		16740	46.33	-21.87	68.2	49.79	39.69	12.74	55.89	100	0	P	H
													H
													H
		11160	47.37	-26.63	74	53.21	40.3	10.3	56.44	100	0	P	V
		16740	46.38	-21.82	68.2	49.84	39.69	12.74	55.89	100	0	P	V
													V
													V
802.11n HT20 CH 140 5700MHz		11400	47.43	-26.57	74	53.33	40.02	10.42	56.34	100	0	P	H
		17100	48.07	-20.13	68.2	51.21	40.36	12.8	56.3	100	0	P	H
													H
													H
		11400	47.54	-26.46	74	53.44	40.02	10.42	56.34	100	0	P	V
		17100	48.05	-20.15	68.2	51.19	40.36	12.8	56.3	100	0	P	V
													V
													V
Remark	1. No other spurious found. 2. All results are PASS against Peak and Average limit line.												



Band 3 - 5470~5725MHz
WIFI 802.11n HT40 (Band Edge @ 3m)

WIFI Ant. 1+2	Note	Frequency (MHz)	Level (dBμV/m)	Over Limit (dB)	Limit Line (dBμV/m)	Read Level (dBμV)	Antenna Factor (dB/m)	Path Loss (dB)	Preamp Factor (dB)	Ant Pos (cm)	Table Pos (deg)	Peak Avg. (P/A)	Pol. (H/V)
802.11n HT40 CH 102 5510MHz		5456.56	62.61	-11.39	74	54.1	31.87	6.18	29.54	121	12	P	H
		5470	63.78	-4.42	68.2	55.25	31.88	6.19	29.54	121	12	P	H
		5407.12	45.99	-8.01	54	37.55	31.84	6.13	29.53	121	12	A	H
	*	5510	104.08	-	-	95.5	31.9	6.23	29.55	121	12	P	H
	*	5510	95.09	-	-	86.51	31.9	6.23	29.55	121	12	A	H
		5733.185	54.06	-14.14	68.2	45.03	32.21	6.37	29.55	121	12	P	H
		5459.2	58.88	-15.12	74	50.37	31.87	6.18	29.54	316	355	P	V
		5468.56	60.45	-7.75	68.2	51.92	31.88	6.19	29.54	316	355	P	V
		5407.12	43.18	-10.82	54	34.74	31.84	6.13	29.53	316	355	A	V
	*	5510	100.04	-	-	91.46	31.9	6.23	29.55	316	355	P	V
	*	5510	91.27	-	-	82.69	31.9	6.23	29.55	316	355	A	V
		5734.76	51.04	-17.16	68.2	41.98	32.24	6.37	29.55	316	355	P	V
802.11n HT40 CH 110 5550MHz		5447.44	55.14	-18.86	74	46.64	31.87	6.17	29.54	117	12	P	H
		5465.68	56.8	-11.4	68.2	48.27	31.88	6.19	29.54	117	12	P	H
		5446.96	46.99	-7.01	54	38.49	31.87	6.17	29.54	117	12	A	H
	*	5550	105.44	-	-	96.75	31.97	6.27	29.55	117	12	P	H
	*	5550	96.22	-	-	87.53	31.97	6.27	29.55	117	12	A	H
		5741.69	51.24	-16.96	68.2	42.17	32.24	6.38	29.55	117	12	P	H
		5446.48	54.01	-19.99	74	45.51	31.87	6.17	29.54	194	339	P	V
		5469.04	54.74	-13.46	68.2	46.21	31.88	6.19	29.54	194	339	P	V
		5446	44.34	-9.66	54	35.84	31.87	6.17	29.54	194	339	A	V
	*	5550	100.7	-	-	92.01	31.97	6.27	29.55	194	339	P	V
	*	5550	91.23	-	-	82.54	31.97	6.27	29.55	194	339	A	V
		5735.075	49.1	-19.1	68.2	40.04	32.24	6.37	29.55	194	339	P	V



802.11n HT40 CH 134 5670MHz		5447.65	49.47	-24.53	74	40.97	31.87	6.17	29.54	174	307	P	H
		5460.95	48.29	-19.91	68.2	39.78	31.87	6.18	29.54	174	307	P	H
		5447.3	41.32	-12.68	54	32.82	31.87	6.17	29.54	174	307	A	H
	*	5670	105.79	-	-	96.85	32.14	6.35	29.55	174	307	P	H
	*	5670	96.73	-	-	87.79	32.14	6.35	29.55	174	307	A	H
		5726.255	61.5	-6.7	68.2	52.47	32.21	6.37	29.55	174	307	P	H
		5444.5	49.02	-24.98	74	40.54	31.86	6.16	29.54	213	309	P	V
		5464.8	48.87	-19.33	68.2	40.35	31.88	6.18	29.54	213	309	P	V
		5447.65	39.82	-14.18	54	31.32	31.87	6.17	29.54	213	309	A	V
	*	5670	99.99	-	-	91.05	32.14	6.35	29.55	213	309	P	V
	*	5670	90.96	-	-	82.02	32.14	6.35	29.55	213	309	A	V
		5725	60.11	-8.09	68.2	51.08	32.21	6.37	29.55	213	309	P	V
Remark	1. No other spurious found. 2. All results are PASS against Peak and Average limit line.												



Band 3 - 5470~5725MHz
WIFI 802.11n HT40 (Harmonic @ 3m)

WIFI Ant. 1+2	Note	Frequency (MHz)	Level (dBµV/m)	Over Limit (dB)	Limit Line (dBµV/m)	Read Level (dBµV)	Antenna Factor (dB/m)	Path Loss (dB)	Preamp Factor (dB)	Ant Pos (cm)	Table Pos (deg)	Peak Avg. (P/A)	Pol. (H/V)	
802.11n HT40 CH 102 5510MHz		11020	48	-26	74	53.78	40.48	10.23	56.49	100	0	P	H	
		16530	47.79	-20.41	68.2	51.28	39.44	12.79	55.72	100	0	P	H	
													H	
													H	
			11020	47.48	-26.52	74	53.26	40.48	10.23	56.49	100	0	P	V
			16530	47.18	-21.02	68.2	50.67	39.44	12.79	55.72	100	0	P	V
														V
802.11n HT40 CH 110 5550MHz		11100	48.08	-25.92	74	53.89	40.38	10.27	56.46	100	0	P	H	
		16650	47.02	-21.18	68.2	50.48	39.59	12.77	55.82	100	0	P	H	
													H	
													H	
			11100	48.24	-25.76	74	54.05	40.38	10.27	56.46	100	0	P	V
			16650	47.14	-21.06	68.2	50.6	39.59	12.77	55.82	100	0	P	V
														V
802.11n HT40 CH 134 5670MHz		11340	48.4	-25.6	74	54.27	40.1	10.39	56.36	100	0	P	H	
		17010	48.37	-19.83	68.2	51.73	40.06	12.7	56.12	100	0	P	H	
													H	
													H	
			11340	46.37	-27.63	74	52.24	40.1	10.39	56.36	100	0	P	V
			17010	49.18	-19.02	68.2	52.54	40.06	12.7	56.12	100	0	P	V
														V
Remark	1. No other spurious found.													
	2. All results are PASS against Peak and Average limit line.													



Band 3 - 5470~5725MHz
WIFI 802.11ac VHT80 (Band Edge @ 3m)

WIFI Ant. 1+2	Note	Frequency (MHz)	Level (dBμV/m)	Over Limit (dB)	Limit Line (dBμV/m)	Read Level (dBμV)	Antenna Factor (dB/m)	Path Loss (dB)	Preamp Factor (dB)	Ant Pos (cm)	Table Pos (deg)	Peak Avg. (P/A)	Pol. (H/V)
802.11ac VHT80 CH 106 5530MHz		5457.04	62.47	-11.53	74	53.96	31.87	6.18	29.54	177	307	P	H
		5465.92	63.15	-5.05	68.2	54.62	31.88	6.19	29.54	177	307	P	H
		5458.72	49.23	-4.77	54	40.72	31.87	6.18	29.54	177	307	A	H
	*	5530	103.64	-	-	95.02	31.92	6.25	29.55	177	307	P	H
	*	5530	95.07	-	-	86.45	31.92	6.25	29.55	177	307	A	H
		5742.95	50.06	-18.14	68.2	40.99	32.24	6.38	29.55	177	307	P	H
		5459.2	56.02	-17.98	74	47.51	31.87	6.18	29.54	310	354	P	V
		5462.32	58.7	-9.5	68.2	50.19	31.87	6.18	29.54	310	354	P	V
		5458	43.91	-10.09	54	35.4	31.87	6.18	29.54	310	354	A	V
	*	5530	98.89	-	-	90.27	31.92	6.25	29.55	310	354	P	V
	*	5530	89.57	-	-	80.95	31.92	6.25	29.55	310	354	A	V
	5739.17	49.77	-18.43	68.2	40.7	32.24	6.38	29.55	310	354	P	V	
802.11ac VHT80 CH 122 5610MHz		5434	50.1	-23.9	74	41.63	31.86	6.15	29.54	176	309	P	H
		5464.72	51.24	-16.96	68.2	42.72	31.88	6.18	29.54	176	309	P	H
		5455.12	40.93	-13.07	54	32.42	31.87	6.18	29.54	176	309	A	H
	*	5610	104.03	-	-	95.22	32.04	6.32	29.55	176	309	P	H
	*	5610	94.84	-	-	86.03	32.04	6.32	29.55	176	309	A	H
		5735.075	57.75	-10.45	68.2	48.69	32.24	6.37	29.55	176	309	P	H
		5446	49.04	-24.96	74	40.54	31.87	6.17	29.54	300	354	P	V
		5468.32	48.41	-19.79	68.2	39.88	31.88	6.19	29.54	300	354	P	V
		5451.76	40.09	-13.91	54	31.59	31.87	6.17	29.54	300	354	A	V
	*	5610	98.1	-	-	89.29	32.04	6.32	29.55	300	354	P	V
	*	5610	88.86	-	-	80.05	32.04	6.32	29.55	300	354	A	V
	5731.925	51.61	-16.59	68.2	42.58	32.21	6.37	29.55	300	354	P	V	
Remark	1. No other spurious found. 2. All results are PASS against Peak and Average limit line.												



Band 3 5470~5725MHz
WIFI 802.11ac VHT80 (Harmonic @ 3m)

WIFI Ant. 1+2	Note	Frequency (MHz)	Level (dBμV/m)	Over Limit (dB)	Limit Line (dBμV/m)	Read Level (dBμV)	Antenna Factor (dB/m)	Path Loss (dB)	Preamp Factor (dB)	Ant Pos (cm)	Table Pos (deg)	Peak Avg. (P/A)	Pol. (H/V)	
802.11ac VHT80 CH 106 5530MHz		11060	48.08	-25.92	74	53.89	40.42	10.25	56.48	100	0	P	H	
		16590	48	-20.2	68.2	51.5	39.5	12.77	55.77	100	0	P	H	
													H	
													H	
			11060	47.53	-26.47	74	53.34	40.42	10.25	56.48	100	0	P	V
			16590	46.84	-21.36	68.2	50.34	39.5	12.77	55.77	100	0	P	V
														V
802.11ac VHT80 CH 122 5610MHz		11220	48	-26	74	53.84	40.24	10.33	56.41	100	0	P	H	
		16830	48.06	-20.14	68.2	51.5	39.79	12.73	55.96	100	0	P	H	
													H	
													H	
			11220	48.35	-25.65	74	54.19	40.24	10.33	56.41	100	0	P	V
			16830	47.62	-20.58	68.2	51.06	39.79	12.73	55.96	100	0	P	V
														V
Remark	1. No other spurious found.													
	2. All results are PASS against Peak and Average limit line.													



Band 3 - Straddle Channel
WIFI 802.11a (Band Edge @ 3m)

WIFI Ant. 1+2	Note	Frequency (MHz)	Level (dBμV/m)	Over Limit (dB)	Limit Line (dBμV/m)	Read Level (dBμV)	Antenna Factor (dB/m)	Path Loss (dB)	Preamp Factor (dB)	Ant Pos (cm)	Table Pos (deg)	Peak Avg. (P/A)	Pol. (H/V)
802.11a CH 144 5720MHz		5367.94	48.41	-25.59	74	40	31.82	6.12	29.53	177	307	P	H
		5462.32	48.86	-19.34	68.2	40.35	31.87	6.18	29.54	177	307	P	H
		5457.25	38.6	-15.4	54	30.09	31.87	6.18	29.54	177	307	A	H
	*	5720	108.14	-	-	99.11	32.21	6.37	29.55	177	307	P	H
	*	5720	99.89	-	-	90.86	32.21	6.37	29.55	177	307	A	H
		5899.5	50.9	-17.3	68.2	41.52	32.46	6.48	29.56	177	307	P	H
		5399.92	48.83	-25.17	74	40.4	31.84	6.12	29.53	201	309	P	V
		5465.44	47.42	-20.78	68.2	38.89	31.88	6.19	29.54	201	309	P	V
		5456.08	38.47	-15.53	54	29.96	31.87	6.18	29.54	201	309	A	V
	*	5720	102.63	-	-	93.6	32.21	6.37	29.55	201	309	P	V
	*	5720	94.57	-	-	85.54	32.21	6.37	29.55	201	309	A	V
		5901.5	51.14	-17.06	68.2	41.76	32.46	6.48	29.56	201	309	P	V
Remark	1. No other spurious found. 2. All results are PASS against Peak and Average limit line.												



Band 3 - Straddle Channel
WIFI 802.11a (Harmonic @ 3m)

Table with 14 columns: WIFI Ant. 1+2, Note, Frequency (MHz), Level (dBµV/m), Over Limit (dB), Limit Line (dBµV/m), Read Level (dBµV), Antenna Factor (dB/m), Path Loss (dB), Preamp Factor (dB), Ant Pos (cm), Table Pos (deg), Peak Avg. (P/A), Pol. (H/V). Rows include data for 802.11a CH 144 5720MHz and a Remark section.



**Band 3 - Straddle Channel
WIFI 802.11n HT20 (Band Edge @ 3m)**

WIFI Ant. 1+2	Note	Frequency (MHz)	Level (dBμV/m)	Over Limit (dB)	Limit Line (dBμV/m)	Read Level (dBμV)	Antenna Factor (dB/m)	Path Loss (dB)	Preamp Factor (dB)	Ant Pos (cm)	Table Pos (deg)	Peak Avg. (P/A)	Pol. (H/V)
802.11n HT20 CH 144 5720MHz		5449.06	50.06	-23.94	74	41.56	31.87	6.17	29.54	177	360	P	H
		5461.93	48.86	-19.34	68.2	40.35	31.87	6.18	29.54	177	360	P	H
		5459.98	38.59	-15.41	54	30.08	31.87	6.18	29.54	177	360	A	H
	*	5720	106.85	-	-	97.82	32.21	6.37	29.55	177	360	P	H
	*	5720	97.9	-	-	88.87	32.21	6.37	29.55	177	360	A	H
		5856.25	51.67	-16.53	68.2	42.37	32.41	6.45	29.56	177	360	P	H
		5455.3	49.3	-24.7	74	40.79	31.87	6.18	29.54	336	308	P	V
		5469.34	48.84	-19.36	68.2	40.31	31.88	6.19	29.54	336	308	P	V
		5459.59	38.44	-15.56	54	29.93	31.87	6.18	29.54	336	308	A	V
	*	5720	100.59	-	-	91.56	32.21	6.37	29.55	336	308	P	V
	*	5720	91.86	-	-	82.83	32.21	6.37	29.55	336	308	A	V
		5871.5	50.22	-17.98	68.2	40.89	32.43	6.46	29.56	336	308	P	V
Remark	1. No other spurious found. 2. All results are PASS against Peak and Average limit line.												



**Band 3 - Straddle Channel
WIFI 802.11n HT20 (Harmonic @ 3m)**

WIFI Ant. 1+2	Note	Frequency (MHz)	Level (dBμV/m)	Over Limit (dB)	Limit Line (dBμV/m)	Read Level (dBμV)	Antenna Factor (dB/m)	Path Loss (dB)	Preamp Factor (dB)	Ant Pos (cm)	Table Pos (deg)	Peak Avg. (P/A)	Pol. (H/V)	
802.11n HT20 CH 144 5720MHz		11440	46.86	-27.14	74	52.77	39.98	10.43	56.32	100	0	P	H	
		17160	48.92	-19.28	68.2	51.88	40.6	12.86	56.42	100	0	P	H	
													H	
													H	
			11440	46.59	-27.41	74	52.5	39.98	10.43	56.32	100	0	P	V
			17160	48.63	-19.57	68.2	51.59	40.6	12.86	56.42	100	0	P	V
														V
														V
Remark	1. No other spurious found. 2. All results are PASS against Peak and Average limit line.													



Band 3 - Straddle Channel
WIFI 802.11n HT40 (Band Edge @ 3m)

Table with 14 columns: WIFI Ant. 1+2, Note, Frequency (MHz), Level (dBµV/m), Over Limit (dB), Limit Line (dBµV/m), Read Level (dBµV), Antenna Factor (dB/m), Path Loss (dB), Preamp Factor (dB), Ant Pos (cm), Table Pos (deg), Peak Avg. (P/A), Pol. (H/V). Rows include frequencies like 5455.69, 5463.49, 5452.57, 5710, 5905.25, 5424.88, 5469.73, 5443.99, 5710, 5710, 5914.

Remark

- 1. No other spurious found.
2. All results are PASS against Peak and Average limit line.



**Band 3 - Straddle Channel
WIFI 802.11n HT40 (Harmonic @ 3m)**

WIFI Ant. 1+2	Note	Frequency (MHz)	Level (dBµV/m)	Over Limit (dB)	Limit Line (dBµV/m)	Read Level (dBµV)	Antenna Factor (dB/m)	Path Loss (dB)	Preamp Factor (dB)	Ant Pos (cm)	Table Pos (deg)	Peak Avg. (P/A)	Pol. (H/V)	
802.11n HT40 CH 142 5710MHz		11420	47.84	-26.16	74	53.75	40	10.42	56.33	100	0	P	H	
		17130	48.13	-20.07	68.2	51.17	40.48	12.84	56.36	100	0	P	H	
													H	
													H	
			11420	47.51	-26.49	74	53.42	40	10.42	56.33	100	0	P	V
			17130	48.75	-19.45	68.2	51.79	40.48	12.84	56.36	100	0	P	V
														V
Remark	1. No other spurious found.													
	2. All results are PASS against Peak and Average limit line.													



Band 3 - Straddle Channel
WIFI 802.11ac VHT80 (Band Edge @ 3m)

WIFI Ant. 1+2	Note	Frequency (MHz)	Level (dBμV/m)	Over Limit (dB)	Limit Line (dBμV/m)	Read Level (dBμV)	Antenna Factor (dB/m)	Path Loss (dB)	Preamp Factor (dB)	Ant Pos (cm)	Table Pos (deg)	Peak Avg. (P/A)	Pol. (H/V)
802.11ac VHT80 CH 138 5690MHz		5456.08	49.12	-24.88	74	40.61	31.87	6.18	29.54	176	306	P	H
		5461.54	48.49	-19.71	68.2	39.98	31.87	6.18	29.54	176	306	P	H
		5427.61	40.07	-13.93	54	31.61	31.85	6.15	29.54	176	306	A	H
	*	5690	101.86	-	-	92.88	32.17	6.36	29.55	176	306	P	H
	*	5690	93	-	-	84.02	32.17	6.36	29.55	176	306	A	H
		5921.8	50.69	-17.51	68.2	41.25	32.5	6.5	29.56	176	306	P	H
		5458.81	48.21	-25.79	74	39.7	31.87	6.18	29.54	298	344	P	V
		5465.83	47.79	-20.41	68.2	39.26	31.88	6.19	29.54	298	344	P	V
		5459.98	39.8	-14.2	54	31.29	31.87	6.18	29.54	298	344	A	V
	*	5690	96.59	-	-	87.61	32.17	6.36	29.55	298	344	P	V
	*	5690	87.18	-	-	78.2	32.17	6.36	29.55	298	344	A	V
		5851	49.43	-18.77	68.2	40.17	32.38	6.44	29.56	298	344	P	V
Remark	1. No other spurious found. 2. All results are PASS against Peak and Average limit line.												



**Band 3 - Straddle Channel
WIFI 802.11ac VHT80 (Harmonic @ 3m)**

WIFI Ant. 1+2	Note	Frequency (MHz)	Level (dBμV/m)	Over Limit (dB)	Limit Line (dBμV/m)	Read Level (dBμV)	Antenna Factor (dB/m)	Path Loss (dB)	Preamp Factor (dB)	Ant Pos (cm)	Table Pos (deg)	Peak Avg. (P/A)	Pol. (H/V)	
802.11ac VHT80 CH 138 5690MHz		11380	47.61	-26.39	74	53.51	40.04	10.41	56.35	100	0	P	H	
		17070	46.84	-21.36	68.2	50.07	40.24	12.77	56.24	100	0	P	H	
													H	
													H	
			11380	46.44	-27.56	74	52.34	40.04	10.41	56.35	100	0	P	V
			17070	47.47	-20.73	68.2	50.7	40.24	12.77	56.24	100	0	P	V
														V
														V
Remark	1. No other spurious found. 2. All results are PASS against Peak and Average limit line.													



Emission below 1GHz
WIFI 802.11n HT20 (LF @ 3m)

WIFI Ant. 1+2	Note	Frequency (MHz)	Level (dBμV/m)	Over Limit (dB)	Limit Line (dBμV/m)	Read Level (dBμV)	Antenna Factor (dB/m)	Path Loss (dB)	Preamp Factor (dB)	Ant Pos (cm)	Table Pos (deg)	Peak Avg. (P/A)	Pol. (H/V)	
802.11n HT20 LF		102.75	27.72	-15.78	43.5	42.76	16.24	0.93	32.21			P	H	
		176.47	26.67	-16.83	43.5	42.46	15.24	1.13	32.16			P	H	
		216.24	27.33	-18.67	46	43.11	15.13	1.23	32.14			P	H	
		833.16	35.13	-10.87	46	35.67	28.66	2.53	31.73	100	0	P	H	
		884.57	32.62	-13.38	46	32.45	29.08	2.57	31.48			P	H	
		958.29	34.49	-11.51	46	31.99	30.81	2.6	30.91			P	H	
														H
														H
														H
														H
														H
														H
			30.97	29.83	-10.17	40	37.95	23.74	0.43	32.29			P	V
			45.52	31.11	-8.89	40	46.39	16.49	0.52	32.29	100	0	P	V
			91.11	28.48	-15.02	43.5	44.94	14.96	0.8	32.22			P	V
			773.99	30.67	-15.33	46	32.17	28.1	2.34	31.94			P	V
			866.14	32.2	-13.8	46	31.97	29.23	2.57	31.57			P	V
			935.01	33.69	-12.31	46	32.23	29.99	2.58	31.11			P	V
														V
														V
													V	
													V	
													V	
													V	
Remark	1. No other spurious found. 2. All results are PASS against limit line.													



Note symbol

*	Fundamental Frequency which can be ignored. However, the level of any unwanted emissions shall not exceed the level of the fundamental frequency.
!	Test result is over limit line.
P/A	Peak or Average
H/V	Horizontal or Vertical



A calculation example for radiated spurious emission is shown as below:

WIFI	Note	Frequency	Level	Over	Limit	Read	Antenna	Path	Preamp	Ant	Table	Peak	Pol.
Ant.				Limit	Line	Level	Factor	Loss	Factor	Pos	Pos	Avg.	
1+2		(MHz)	(dBμV/m)	(dB)	(dBμV/m)	(dBμV)	(dB/m)	(dB)	(dB)	(cm)	(deg)	(P/A)	(H/V)
802.11b		2390	55.45	-18.55	74	54.51	32.22	4.58	35.86	103	308	P	H
CH 01													
2412MHz		2390	43.54	-10.46	54	42.6	32.22	4.58	35.86	103	308	A	H

1. Path Loss(dB) = Cable loss(dB) + Filter loss(dB) + Attenuator loss(dB)
2. Level(dBμV/m) = Antenna Factor(dB/m) + Path Loss(dB) + Read Level(dBμV) - Preamp Factor(dB)
3. Over Limit(dB) = Level(dBμV/m) – Limit Line(dBμV/m)

For Peak Limit @ 2390MHz:

1. Level(dBμV/m)
= Antenna Factor(dB/m) + Path Loss(dB) + Read Level(dBμV) - Preamp Factor(dB)
= 32.22(dB/m) + 4.58(dB) + 54.51(dBμV) – 35.86 (dB)
= 55.45 (dBμV/m)
2. Over Limit(dB)
= Level(dBμV/m) – Limit Line(dBμV/m)
= 55.45(dBμV/m) – 74(dBμV/m)
= -18.55(dB)

For Average Limit @ 2390MHz:

1. Level(dBμV/m)
= Antenna Factor(dB/m) + Path Loss(dB) + Read Level(dBμV) - Preamp Factor(dB)
= 32.22(dB/m) + 4.58(dB) + 42.6(dBμV) – 35.86 (dB)
= 43.54 (dBμV/m)
2. Over Limit(dB) = Level(dBμV/m) – Limit Line(dBμV/m)
= 43.54(dBμV/m) – 54(dBμV/m)
= -10.46(dB)

Both peak and average measured complies with the limit line, so test result is “PASS”.



Appendix D. Radiated Spurious Emission

Test Engineer :	Alex Jheng , Fu Chen , Wilson Wu	Temperature :	24.5~25.3°C
		Relative Humidity :	49~55%

Note symbol

-L	Low channel location
-R	High channel location

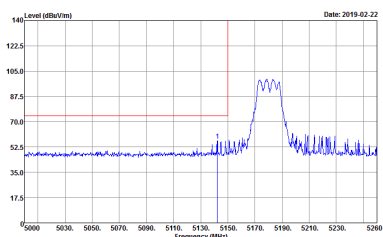
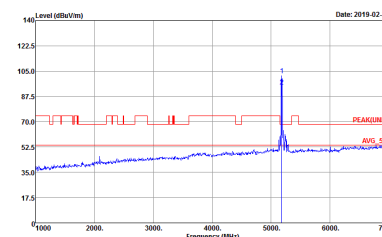
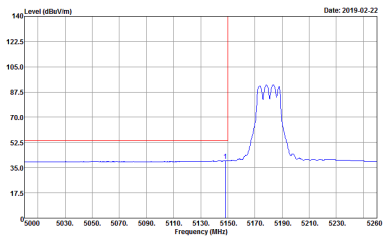

Band 1 - 5150~5250MHz
WIFI 802.11a (Band Edge @ 3m)

WIFI	Band 1 5150~5250MHz Band Edge @ 3m	
ANT	802.11a CH36 5180MHz	
1+2	Horizontal	Fundamental
Peak	 <p>Site : 03CH13-HY Condition : PEAK_BE_74 3m HORN_9120D_1241 HORIZONTAL : RBW:1000.000KHz VBW:3000.000KHz SWT:Auto</p>	 <p>Site : 03CH13-HY Condition : PEAK(UNIT) 3m HORN_9120D_1241 HORIZONTAL : RBW:1000.000KHz VBW:3000.000KHz SWT:Auto</p>
Avg.	 <p>Site : 03CH13-HY Condition : AVG_BE_54 3m HORN_9120D_1241 HORIZONTAL : RBW:1000.000KHz VBW:0.010KHz SWT:Auto</p>	Left blank

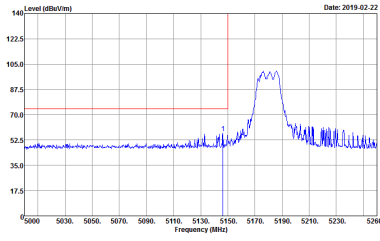
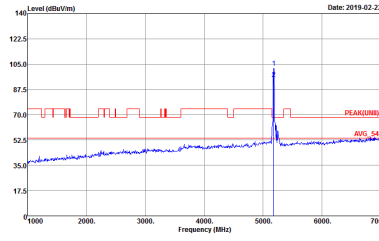
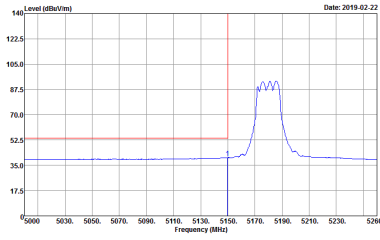

WIFI	Band 1 5150~5250MHz Band Edge @ 3m	
ANT	802.11a CH36 5180MHz	
1+2	Vertical	Fundamental
<p>Peak</p>	 <p>Site : 03CH13-HY Condition : PEAK_BE_74 3m HORN_9120D_1241 VERTICAL : RBW:1000.000KHz VBW:3000.000KHz SWT:Auto</p>	 <p>Site : 03CH13-HY Condition : PEAK(UNIT) 3m HORN_9120D_1241 VERTICAL : RBW:1000.000KHz VBW:3000.000KHz SWT:Auto</p>
<p>Avg.</p>	 <p>Site : 03CH13-HY Condition : AVG_BE_54 3m HORN_9120D_1241 VERTICAL : RBW:1000.000KHz VBW:0.010KHz SWT:Auto</p>	<p>Left blank</p>



WIFI	Band 1 5150~5250MHz Band Edge @ 3m	
ANT	802.11a CH44 5220MHz - L	
1+2	Horizontal	Fundamental
<p>Peak</p>	<p>Site : 03CH13-HY Condition : PEAK_BE_74 3m HORN_9120D_1241 HORIZONTAL : RBW:1000.000KHz VBW:3000.000KHz SWT:Auto</p>	<p>Site : 03CH13-HY Condition : PEAK(UNIT) 3m HORN_9120D_1241 HORIZONTAL : RBW:1000.000KHz VBW:3000.000KHz SWT:Auto</p>
<p>Avg.</p>	<p>Site : 03CH13-HY Condition : AVG_BE_54 3m HORN_9120D_1241 HORIZONTAL : RBW:1000.000KHz VBW:0.010KHz SWT:Auto</p>	<p>Left blank</p>



WIFI	Band 1 5150~5250MHz Band Edge @ 3m	
ANT	802.11a CH44 5220MHz - R	
1+2	Horizontal	Fundamental
<p>Peak</p>	<p>Site : 03CH13-FY Condition : PEAK_BE_74 3m HORN_91200_1241 HORIZONTAL : RBW:1000.000KHz VBW:3000.000KHz SWT:Auto</p>	<p>Left blank</p>
<p>Avg.</p>	<p>Site : 03CH13-FY Condition : AVG_BE_54 3m HORN_91200_1241 HORIZONTAL : RBW:1000.000KHz VBW:0.010KHz SWT:Auto</p>	<p>Left blank</p>



WIFI	Band 1 5150~5250MHz Band Edge @ 3m	
ANT	802.11a CH44 5220MHz - L	
1+2	Vertical	Fundamental
<p>Peak</p>	<p>Site : 03CH13-HY Condition : PEAK_BE_74 3m HORN_9120D_1241 VERTICAL : RBW:1000.000KHz VBW:3000.000KHz SWT:Auto</p>	<p>Site : 03CH13-HY Condition : PEAK(UNIT) 3m HORN_9120D_1241 VERTICAL : RBW:1000.000KHz VBW:3000.000KHz SWT:Auto</p>
<p>Avg.</p>	<p>Site : 03CH13-HY Condition : AVG_BE_54 3m HORN_9120D_1241 VERTICAL : RBW:1000.000KHz VBW:0.010KHz SWT:Auto</p>	<p>Left blank</p>

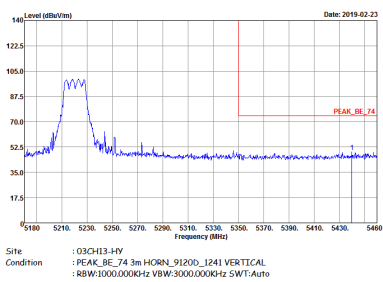
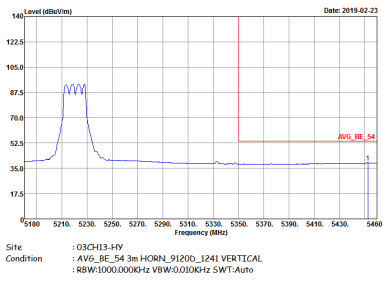

WIFI	Band 1 5150~5250MHz Band Edge @ 3m	
ANT	802.11a CH44 5220MHz - R	
1+2	Vertical	Fundamental
Peak	 <p>Site : 03CH13-FY Condition : PEAK_BE_74 3m HORN_91200_1241 VERTICAL RBW:1000.000KHz VBW:3000.000KHz SWT:Auto</p>	Left blank
Avg.	 <p>Site : 03CH13-FY Condition : AVG_BE_54 3m HORN_91200_1241 VERTICAL RBW:1000.000KHz VBW:0.010KHz SWT:Auto</p>	Left blank



WIFI	Band 1 5150~5250MHz Band Edge @ 3m	
ANT	802.11a CH48 5240MHz - L	
1+2	Horizontal	Fundamental
<p>Peak</p>	<p>Site : 03CH13-HY Condition : PEAK_BE_74 3m HORN_9120D_1241 HORIZONTAL : RBW:1000.000KHz VBW:3000.000KHz SWT:Auto</p>	<p>Site : 03CH13-HY Condition : PEAK(UNIT) 3m HORN_9120D_1241 HORIZONTAL : RBW:1000.000KHz VBW:3000.000KHz SWT:Auto</p>
<p>Avg.</p>	<p>Site : 03CH13-HY Condition : AVG_BE_54 3m HORN_9120D_1241 HORIZONTAL : RBW:1000.000KHz VBW:0.010KHz SWT:Auto</p>	<p>Left blank</p>



WIFI	Band 1 5150~5250MHz Band Edge @ 3m	
ANT	802.11a CH48 5240MHz - R	
1+2	Horizontal	Fundamental
Peak	<p>Site : 03CH13-FY Condition : PEAK_BE_74 3m HORN_91200_1241 HORIZONTAL : RBW:1000.000kHz VBW:3000.000kHz SWF:Auto</p>	Left blank
Avg.	<p>Site : 03CH13-FY Condition : AVG_BE_54 3m HORN_91200_1241 HORIZONTAL : RBW:1000.000kHz VBW:0.010kHz SWF:Auto</p>	Left blank



WIFI	Band 1 5150~5250MHz Band Edge @ 3m	
ANT	802.11a CH48 5240MHz - L	
1+2	Vertical	Fundamental
<p>Peak</p>	<p>Site : 03CH13-HY Condition : PEAK_BE_74 3m HORN_9120D_1241 VERTICAL : RBW:1000.000KHz VBW:3000.000KHz SWT:Auto</p>	<p>Site : 03CH13-HY Condition : PEAK(UNIT) 3m HORN_9120D_1241 VERTICAL : RBW:1000.000KHz VBW:3000.000KHz SWT:Auto</p>
<p>Avg.</p>	<p>Site : 03CH13-HY Condition : AVG_BE_54 3m HORN_9120D_1241 VERTICAL : RBW:1000.000KHz VBW:0.010KHz SWT:Auto</p>	<p>Left blank</p>

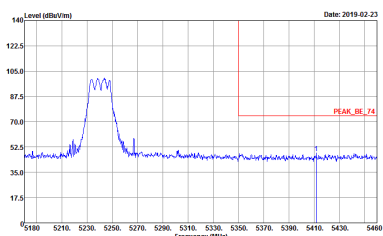
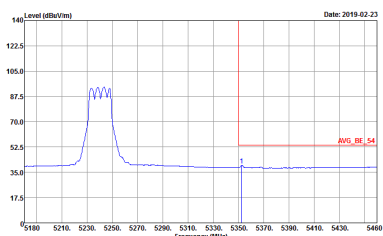

WIFI	Band 1 5150~5250MHz Band Edge @ 3m	
ANT	802.11a CH48 5240MHz - R	
1+2	Vertical	Fundamental
<p>Peak</p>	 <p>Site : 03CH13-FY Condition : PEAK_BE_74 3m HORN_91200_1241 VERTICAL : RBW:1000.000KHz VBW:3000.000KHz SWT:Auto</p>	<p>Left blank</p>
<p>Avg.</p>	 <p>Site : 03CH13-FY Condition : AVG_BE_54 3m HORN_91200_1241 VERTICAL : RBW:1000.000KHz VBW:0.010KHz SWT:Auto</p>	<p>Left blank</p>

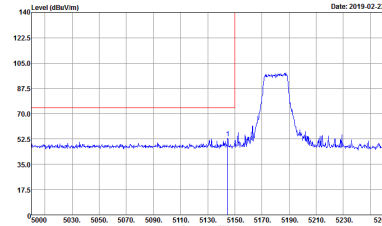
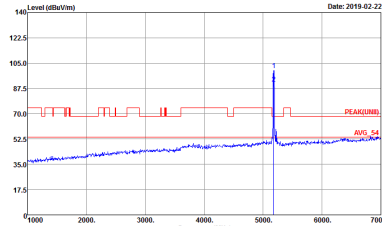
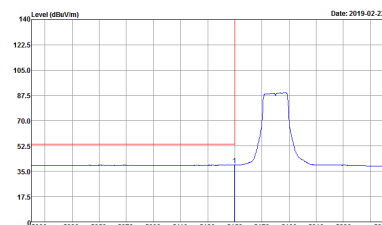

**Band 1 5150~5250MHz
WIFI 802.11n HT20 (Band Edge @ 3m)**

WIFI	Band 1 5150~5250MHz Band Edge @ 3m	
ANT	802.11n HT20 CH36 5180MHz	
1+2	Horizontal	Fundamental
<p align="center">Peak</p>	 <p>Site : 03CH13-HY Condition : PEAK_BE_74 3m HORN_91200_1241 HORIZONTAL : RBW:1000.000KHz VBW:3000.000KHz SWT:Auto</p>	 <p>Site : 03CH13-HY Condition : PEAK(LINE) 3m HORN_91200_1241 HORIZONTAL : RBW:1000.000KHz VBW:3000.000KHz SWT:Auto</p>
<p align="center">Avg.</p>	 <p>Site : 03CH13-HY Condition : AVG_BE_54 3m HORN_91200_1241 HORIZONTAL : RBW:1000.000KHz VBW:0.010KHz SWT:Auto</p>	<p align="center">Left blank</p>

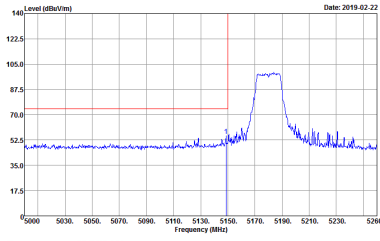
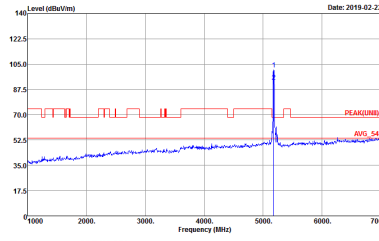
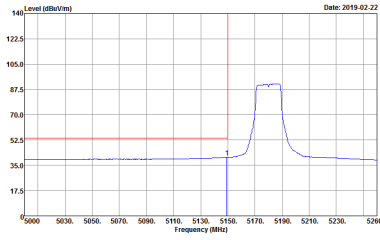

WIFI	Band 1 5150~5250MHz Band Edge @ 3m	
ANT	802.11n HT20 CH36 5180MHz	
1+2	Vertical	Fundamental
Peak	 <p>Site : 03CH13-HY Condition : PEAK_BE_74 3m HORN_9120D_1241 VERTICAL : RBW:1000.000KHz VBW:3000.000KHz SWT:Auto</p>	 <p>Site : 03CH13-HY Condition : PEAK(UNIT) 3m HORN_9120D_1241 VERTICAL : RBW:1000.000KHz VBW:3000.000KHz SWT:Auto</p>
Avg.	 <p>Site : 03CH13-HY Condition : AVG_BE_54 3m HORN_9120D_1241 VERTICAL : RBW:1000.000KHz VBW:0.010KHz SWT:Auto</p>	Left blank

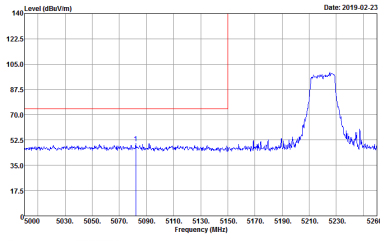
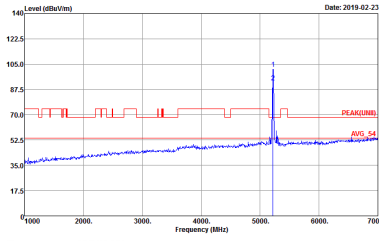
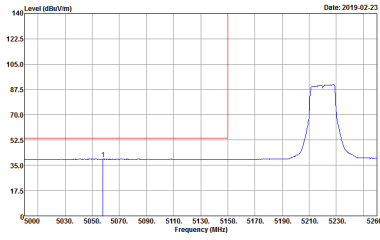

WIFI	Band 1 5150~5250MHz Band Edge @ 3m	
ANT	802.11n HT20 CH44 5220MHz - L	
1+2	Horizontal	Fundamental
<p>Peak</p>	 <p>Site : 03CH13-HY Condition : PEAK_BE_74 3m HORN_91200_1241 HORIZONTAL : RBW:1000.000KHz VBW:3000.000KHz SWT:Auto</p>	 <p>Site : 03CH13-HY Condition : PEAK(UNIT) 3m HORN_91200_1241 HORIZONTAL : RBW:1000.000KHz VBW:3000.000KHz SWT:Auto</p>
<p>Avg.</p>	 <p>Site : 03CH13-HY Condition : AVG_BE_54 3m HORN_91200_1241 HORIZONTAL : RBW:1000.000KHz VBW:0.010KHz SWT:Auto</p>	<p>Left blank</p>

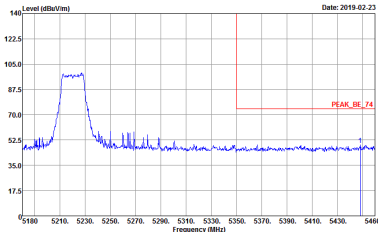
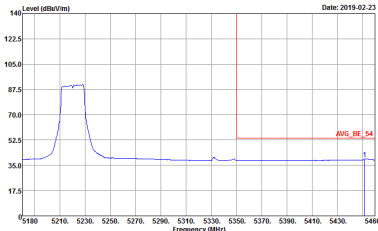

WIFI	Band 1 5150~5250MHz Band Edge @ 3m	
ANT	802.11n HT20 CH44 5220MHz - R	
1+2	Horizontal	Fundamental
<p>Peak</p>	 <p>Site : 03CH13-FY Condition : PEAK_BE_74 3m HORN_91200_1241 HORIZONTAL : RBW:1000.000KHz VBW:3000.000KHz SWT:Auto</p>	<p>Left blank</p>
<p>Avg.</p>	 <p>Site : 03CH13-FY Condition : AVG_BE_54 3m HORN_91200_1241 HORIZONTAL : RBW:1000.000KHz VBW:0.010KHz SWT:Auto</p>	<p>Left blank</p>



WIFI	Band 1 5150~5250MHz Band Edge @ 3m	
ANT	802.11n HT20 CH44 5220MHz - L	
1+2	Vertical	Fundamental
Peak	<p>Site : 03CH13-HY Condition : PEAK_BE_74 3m HORN_9120D_1241 VERTICAL : RBW:1000.000KHz VBW:3000.000KHz SWT:Auto</p>	<p>Site : 03CH13-HY Condition : PEAK(UNIT) 3m HORN_9120D_1241 VERTICAL : RBW:1000.000KHz VBW:3000.000KHz SWT:Auto</p>
Avg.	<p>Site : 03CH13-HY Condition : AVG_BE_54 3m HORN_9120D_1241 VERTICAL : RBW:1000.000KHz VBW:0.010KHz SWT:Auto</p>	Left blank



WIFI	Band 1 5150~5250MHz Band Edge @ 3m	
ANT	802.11n HT20 CH44 5220MHz - R	
1+2	Vertical	Fundamental
<p>Peak</p>	<p>Site : 03CH13-FY Condition : PEAK_BE_74 3m HORN_91200_1241 VERTICAL : RBW:1000.000KHz VBW:3000.000KHz SWT:Auto</p>	<p>Left blank</p>
<p>Avg.</p>	<p>Site : 03CH13-FY Condition : AVG_BE_54 3m HORN_91200_1241 VERTICAL : RBW:1000.000KHz VBW:0.010KHz SWT:Auto</p>	<p>Left blank</p>



WIFI	Band 1 5150~5250MHz Band Edge @ 3m	
ANT	802.11n HT20 CH48 5240MHz - L	
1+2	Horizontal	Fundamental
<p>Peak</p>	<p>Site : 03CH13-HY Condition : PEAK_BE_74 3m HORN_9120D_1241 HORIZONTAL : RBW:1000.000KHz VBW:3000.000KHz SWT:Auto</p>	<p>Site : 03CH13-HY Condition : PEAK(UNIT) 3m HORN_9120D_1241 HORIZONTAL : RBW:1000.000KHz VBW:3000.000KHz SWT:Auto</p>
<p>Avg.</p>	<p>Site : 03CH13-HY Condition : AVG_BE_54 3m HORN_9120D_1241 HORIZONTAL : RBW:1000.000KHz VBW:0.010KHz SWT:Auto</p>	<p>Left blank</p>



WIFI	Band 1 5150~5250MHz Band Edge @ 3m	
ANT	802.11n HT20 CH48 5240MHz - R	
1+2	Horizontal	Fundamental
Peak	<p>Site : 03CH13-FY Condition : PEAK_BE_74 3m HORN_91200_1241 HORIZONTAL : RBW:1000.000KHz VBW:3000.000KHz SWF:Auto</p>	Left blank
Avg.	<p>Site : 03CH13-FY Condition : AVG_BE_54 3m HORN_91200_1241 HORIZONTAL : RBW:1000.000KHz VBW:0.010KHz SWF:Auto</p>	Left blank



WIFI	Band 1 5150~5250MHz Band Edge @ 3m	
ANT	802.11n HT20 CH48 5240MHz - L	
1+2	Vertical	Fundamental
Peak	<p>Site : 03CH13-HY Condition : PEAK_BE_74 3m HORN_9120D_1241 VERTICAL : RBW:1000.000KHz VBW:3000.000KHz SWT:Auto</p>	<p>Site : 03CH13-HY Condition : PEAK(UNIT) 3m HORN_9120D_1241 VERTICAL : RBW:1000.000KHz VBW:3000.000KHz SWT:Auto</p>
Avg.	<p>Site : 03CH13-HY Condition : AVG_BE_54 3m HORN_9120D_1241 VERTICAL : RBW:1000.000KHz VBW:0.010KHz SWT:Auto</p>	Left blank

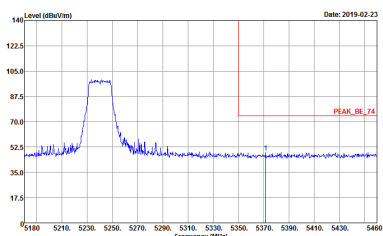
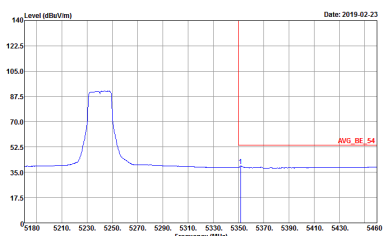

WIFI	Band 1 5150~5250MHz Band Edge @ 3m	
ANT	802.11n HT20 CH48 5240MHz - R	
1+2	Vertical	Fundamental
<p>Peak</p>	 <p>Site : 03CH13-FY Condition : PEAK_BE_74 3m HORN_91200_1241 VERTICAL : RBW:1000.000KHz VBW:3000.000KHz SWT:Auto</p>	<p>Left blank</p>
<p>Avg.</p>	 <p>Site : 03CH13-FY Condition : AVG_BE_54 3m HORN_91200_1241 VERTICAL : RBW:1000.000KHz VBW:0.010KHz SWT:Auto</p>	<p>Left blank</p>



**Band 1 5150~5250MHz
WIFI 802.11n HT40 (Band Edge @ 3m)**

WIFI	Band 1 5150~5250MHz Band Edge @ 3m	
ANT	802.11n HT40 CH38 5190MHz - L	
1+2	Horizontal	Fundamental
Peak	<p>Site : 03CH13-HY Condition : PEAK_BE_74 3m HORN_91200_1241 HORIZONTAL : RBW:1000.000KHz VBW:3000.000KHz SWT:Auto</p>	<p>Site : 03CH13-HY Condition : PEAK(FUND) 3m HORN_91200_1241 HORIZONTAL : RBW:1000.000KHz VBW:3000.000KHz SWT:Auto</p>
Avg.	<p>Site : 03CH13-HY Condition : AVG_BE_54 3m HORN_91200_1241 HORIZONTAL : RBW:1000.000KHz VBW:1.000KHz SWT:Auto</p>	Left blank



WIFI	Band 1 5150~5250MHz Band Edge @ 3m	
ANT	802.11n HT40 CH38 5190MHz - R	
1+2	Horizontal	Fundamental
Peak	<p>Site : 03CH13-FY Condition : PEAK_BE_74 3m HORN_91200_1241 HORIZONTAL : RBW:1000.000KHz VBW:3000.000KHz SWT:Auto</p>	Left blank
Avg.	<p>Site : 03CH13-FY Condition : AVG_BE_54 3m HORN_91200_1241 HORIZONTAL : RBW:1000.000KHz VBW:1.000KHz SWT:Auto</p>	Left blank



WIFI	Band 1 5150~5250MHz Band Edge @ 3m	
ANT	802.11n HT40 CH38 5190MHz - L	
1+2	Vertical	Fundamental
Peak	<p>Site : 03CH13-HY Condition : PEAK_BE_74 3m HORN_9120D_1241 VERTICAL : RBW:1000.000KHz VBW:3000.000KHz SWT:Auto</p>	<p>Site : 03CH13-HY Condition : PEAK(UNIT) 3m HORN_9120D_1241 VERTICAL : RBW:1000.000KHz VBW:3000.000KHz SWT:Auto</p>
Avg.	<p>Site : 03CH13-HY Condition : AVG_BE_54 3m HORN_9120D_1241 VERTICAL : RBW:1000.000KHz VBW:1.000KHz SWT:Auto</p>	Left blank

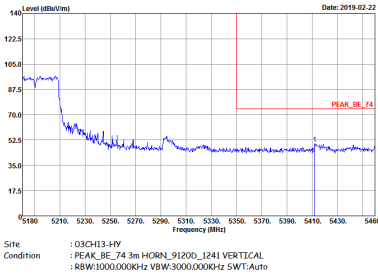
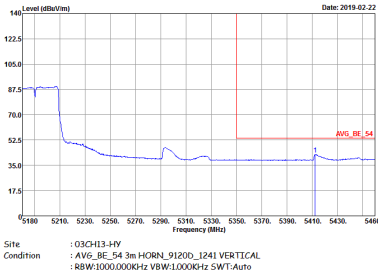

WIFI	Band 1 5150~5250MHz Band Edge @ 3m	
ANT	802.11n HT40 CH38 5190MHz - R	
1+2	Vertical	Fundamental
Peak	 <p>Site : 03CH13-FY Condition : PEAK_BE_74 3m HORN_9120D_1241 VERTICAL : RBW:1000.000KHz VBW:3000.000KHz SWT:Auto</p>	Left blank
Avg.	 <p>Site : 03CH13-FY Condition : AVG_BE_54 3m HORN_9120D_1241 VERTICAL : RBW:1000.000KHz VBW:1.000KHz SWT:Auto</p>	Left blank



WIFI	Band 1 5150~5250MHz Band Edge @ 3m	
ANT	802.11n HT40 CH46 5230MHz - L	
1+2	Horizontal	Fundamental
<p>Peak</p>	<p>Site : 03CH13-HY Condition : PEAK_BE_74 3m HORN_9120D_1241 HORIZONTAL : RBW:1000.000KHz VBW:3000.000KHz SWT:Auto</p>	<p>Site : 03CH13-HY Condition : PEAK(UNIT) 3m HORN_9120D_1241 HORIZONTAL : RBW:1000.000KHz VBW:3000.000KHz SWT:Auto</p>
<p>Avg.</p>	<p>Site : 03CH13-HY Condition : AVG_BE_54 3m HORN_9120D_1241 HORIZONTAL : RBW:1000.000KHz VBW:1.000KHz SWT:Auto</p>	<p>Left blank</p>



WIFI	Band 1 5150~5250MHz Band Edge @ 3m	
ANT	802.11n HT40 CH46 5230MHz - R	
1+2	Horizontal	Fundamental
Peak	<p>Site : 03CH13-FY Condition : PEAK_BE_74 3m HORN_9120D_1241 HORIZONTAL : RBW:1000.000KHz VBW:3000.000KHz SWT:Auto</p>	Left blank
Avg.	<p>Site : 03CH13-FY Condition : AVG_BE_54 3m HORN_9120D_1241 HORIZONTAL : RBW:1000.000KHz VBW:1.000KHz SWT:Auto</p>	Left blank



WIFI	Band 1 5150~5250MHz Band Edge @ 3m	
ANT	802.11n HT40 CH46 5230MHz - L	
1+2	Vertical	Fundamental
<p>Peak</p>	<p>Site : 03CH13-HY Condition : PEAK_BE_74 3m HORN_9120D_1241 VERTICAL : RBW:1000.000KHz VBW:3000.000KHz SWT:Auto</p>	<p>Site : 03CH13-HY Condition : PEAK(UNIT) 3m HORN_9120D_1241 VERTICAL : RBW:1000.000KHz VBW:3000.000KHz SWT:Auto</p>
<p>Avg.</p>	<p>Site : 03CH13-HY Condition : AVG_BE_54 3m HORN_9120D_1241 VERTICAL : RBW:1000.000KHz VBW:1.000KHz SWT:Auto</p>	<p>Left blank</p>

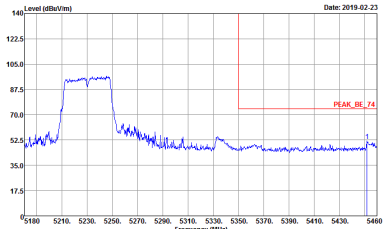
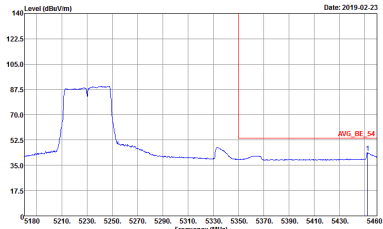

WIFI	Band 1 5150~5250MHz Band Edge @ 3m	
ANT	802.11n HT40 CH46 5230MHz - R	
1+2	Vertical	Fundamental
<p>Peak</p>	 <p>Site : 03CH13-FY Condition : PEAK_BE_74 3m HORN_9120D_1241 VERTICAL : RBW:1000.000KHz VBW:3000.000KHz SWT:Auto</p>	<p>Left blank</p>
<p>Avg.</p>	 <p>Site : 03CH13-FY Condition : AVG_BE_54 3m HORN_9120D_1241 VERTICAL : RBW:1000.000KHz VBW:1.000KHz SWT:Auto</p>	<p>Left blank</p>



Band 1 5150~5250MHz
WIFI 802.11ac VHT80 (Band Edge @ 3m)

WIFI	Band 1 5150~5250MHz Band Edge @ 3m	
ANT	802.11ac VHT80 CH42 5210MHz - L	
1+2	Horizontal	Fundamental
Peak	<p>Site : 03CH13-HY Condition : PEAK_BE_74 3m HORN_91200_1241 HORIZONTAL : RBW:1000.000KHz VBW:3000.000KHz SWT:Auto</p>	<p>Site : 03CH13-HY Condition : PEAK(FUND) 3m HORN_91200_1241 HORIZONTAL : RBW:1000.000KHz VBW:3000.000KHz SWT:Auto</p>
Avg.	<p>Site : 03CH13-HY Condition : AVG_BE_54 3m HORN_91200_1241 HORIZONTAL : RBW:1000.000KHz VBW:3.000KHz SWT:Auto</p>	Left blank



WIFI	Band 1 5150~5250MHz Band Edge @ 3m	
ANT	802.11ac VHT80 CH42 5210MHz - R	
1+2	Horizontal	Fundamental
Peak	<p>Site : 03CH13-FY Condition : PEAK_BE_74 3m HORN_91200_1241 HORIZONTAL : RBW:1000.000kHz VBW:3000.000kHz SWT:Auto</p>	Left blank
Avg.	<p>Site : 03CH13-FY Condition : AVG_BE_54 3m HORN_91200_1241 HORIZONTAL : RBW:1000.000kHz VBW:3.000kHz SWT:Auto</p>	Left blank



WIFI	Band 1 5150~5250MHz Band Edge @ 3m	
ANT	802.11ac VHT80 CH42 5210MHz - L	
1+2	Vertical	Fundamental
<p>Peak</p>	<p>Site : 03CH13-HY Condition : PEAK_BE_74 3m HORN_9120D_1241 VERTICAL : RBW:1000.000KHz VBW:3000.000KHz SWT:Auto</p>	<p>Site : 03CH13-HY Condition : PEAK(UNIT) 3m HORN_9120D_1241 VERTICAL : RBW:1000.000KHz VBW:3000.000KHz SWT:Auto</p>
<p>Avg.</p>	<p>Site : 03CH13-HY Condition : AVG_BE_54 3m HORN_9120D_1241 VERTICAL : RBW:1000.000KHz VBW:3.000KHz SWT:Auto</p>	<p>Left blank</p>



WIFI	Band 1 5150~5250MHz Band Edge @ 3m	
ANT	802.11ac VHT80 CH42 5210MHz - R	
1+2	Vertical	Fundamental
<p>Peak</p>	<p>Site : 03CH13-FY Condition : PEAK_BE_74 3m HORN_91200_1241 VERTICAL : RBW:1000.000kHz VBW:3000.000kHz SWT:Auto</p>	<p>Left blank</p>
<p>Avg.</p>	<p>Site : 03CH13-FY Condition : AVG_BE_54 3m HORN_91200_1241 VERTICAL : RBW:1000.000kHz VBW:3.000kHz SWT:Auto</p>	<p>Left blank</p>



**Band 1 - 5150~5250MHz
WIFI 802.11a (Harmonic @ 3m)**

WIFI	Band 1 5150~5250MHz Harmonic @ 3m	
ANT	802.11a CH36 5180MHz	
1+2	Horizontal	Vertical
Peak Avg.	<p>Site : 03CH13-HY Condition : PEAK(LINEI) 3m HORN_9120D_1241 HORIZONTAL Detector : Peak</p>	<p>Site : 03CH13-HY Condition : PEAK(LINEI) 3m HORN_9120D_1241 VERTICAL Detector : Peak</p>

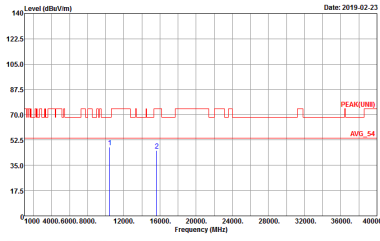
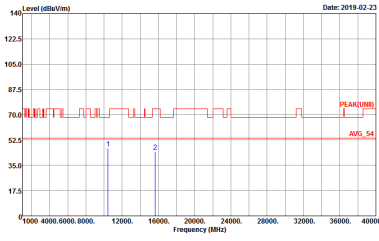

WIFI	Band 1 5150~5250MHz Harmonic @ 3m	
ANT	802.11a CH44 5220MHz	
1+2	Horizontal	Vertical
<p>Peak</p> <p>Avg.</p>	 <p>Site : 03CH13-HY Condition : PEAK(LINE) 3m HORN_91200_1241 HORIZONTAL Detector : Peak</p>	 <p>Site : 03CH13-HY Condition : PEAK(LINE) 3m HORN_91200_1241 VERTICAL Detector : Peak</p>

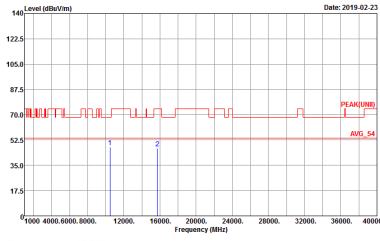
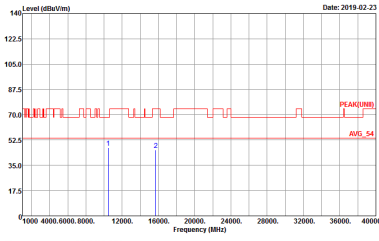

WIFI	Band 1 5150~5250MHz Harmonic @ 3m	
ANT	802.11a CH48 5240MHz	
1+2	Horizontal	Vertical
<p>Peak</p> <p>Avg.</p>	 <p>Site : 03CH13-HY Condition : PEAK(LINEI) 3m HORN_91200_1241 HORIZONTAL Detector : Peak</p>	 <p>Site : 03CH13-HY Condition : PEAK(LINEI) 3m HORN_91200_1241 VERTICAL Detector : Peak</p>

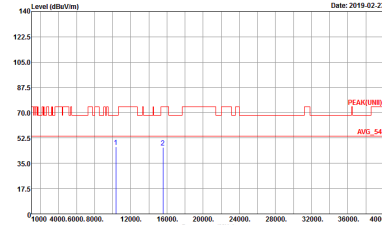
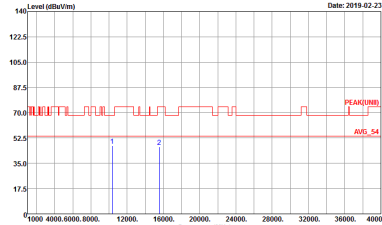

**Band 1 5150~5250MHz
WIFI 802.11n HT20 (Harmonic @ 3m)**

WIFI	Band 1 5150~5250MHz Harmonic @ 3m	
ANT	802.11n HT20 CH36 5180MHz	
1+2	Horizontal	Vertical
<p>Peak Avg.</p>	 <p>Site : 03CH13-HY Condition : PEAK(LINE1) 3m HORN_91200_1241 HORIZONTAL Detector : Peak</p>	 <p>Site : 03CH13-HY Condition : PEAK(LINE1) 3m HORN_91200_1241 VERTICAL Detector : Peak</p>



WIFI	Band 1 5150~5250MHz Harmonic @ 3m	
ANT	802.11n HT20 CH44 5220MHz	
1+2	Horizontal	Vertical
Peak Avg.	<p>Site : 03CH13-HY Condition : PEAK(LINE) 3m HORN_91200_1241 HORIZONTAL Detector : Peak</p>	<p>Site : 03CH13-HY Condition : PEAK(LINE) 3m HORN_91200_1241 VERTICAL Detector : Peak</p>

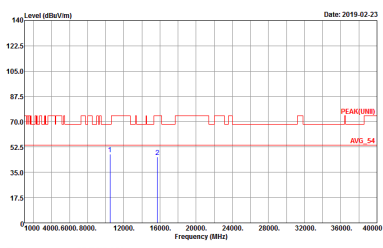
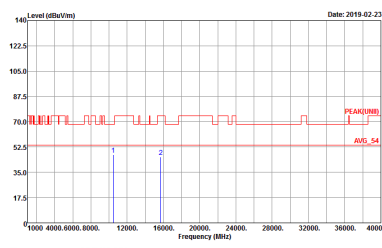

WIFI	Band 1 5150~5250MHz Harmonic @ 3m	
ANT	802.11n HT20 CH48 5240MHz	
1+2	Horizontal	Vertical
<p>Peak</p> <p>Avg.</p>	 <p>Site : 03CH13-HY Condition : PEAK(LINE) 3m HORN_91200_1241 HORIZONTAL Detector : Peak</p>	 <p>Site : 03CH13-HY Condition : PEAK(LINE) 3m HORN_91200_1241 VERTICAL Detector : Peak</p>

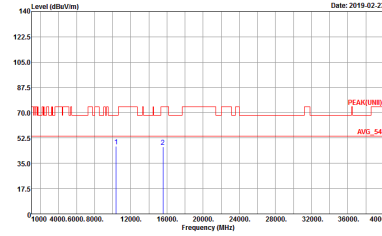
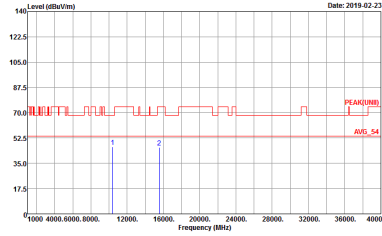

**Band 1 5150~5250MHz
WIFI 802.11n HT40 (Harmonic @ 3m)**

WIFI	Band 1 5150~5250MHz Harmonic @ 3m	
ANT	802.11n HT40 CH38 5190MHz	
1+2	Horizontal	Vertical
<p>Peak Avg.</p>	 <p>Site : 03CH13-HY Condition : PEAK(LINE) 3m HORN_91200_1241 HORIZONTAL Detector : Peak</p>	 <p>Site : 03CH13-HY Condition : PEAK(LINE) 3m HORN_91200_1241 VERTICAL Detector : Peak</p>



WIFI	Band 1 5150~5250MHz Harmonic @ 3m	
ANT	802.11n HT40 CH46 5230MHz	
1+2	Horizontal	Vertical
Peak Avg.	<p>Site : 03CH13-HY Condition : PEAK(LINE) 3m HORN_91200_1241 HORIZONTAL Detector : Peak</p>	<p>Site : 03CH13-HY Condition : PEAK(LINE) 3m HORN_91200_1241 VERTICAL Detector : Peak</p>



**Band 1 5150~5250MHz
WIFI 802.11ac VHT80 (Harmonic @ 3m)**

WIFI	Band 1 5150~5250MHz Harmonic @ 3m	
ANT	802.11ac VHT80 CH42 5210MHz	
1+2	Horizontal	Vertical
Peak Avg.	<p>Site : 03CH13-HY Condition : PEAK(LINE1) 3m HORN_91200_1241 HORIZONTAL Detector : Peak</p>	<p>Site : 03CH13-HY Condition : PEAK(LINE1) 3m HORN_91200_1241 VERTICAL Detector : Peak</p>



Band 2 - 5250~5350MHz
WIFI 802.11a (Band Edge @ 3m)

WIFI	Band 2 5250~5350MHz Band Edge @ 3m	
ANT	802.11a CH52 5260MHz - L	
1+2	Horizontal	Fundamental
Peak	<p>Site : 03CH13-HY Condition : PEAK_BE_74 3m HORN_9120D_1241 HORIZONTAL : RBW:1000.000KHz VBW:3000.000KHz SWT:Auto</p>	<p>Site : 03CH13-HY Condition : PEAK(UNIT) 3m HORN_9120D_1241 HORIZONTAL : RBW:1000.000KHz VBW:3000.000KHz SWT:Auto</p>
Avg.	<p>Site : 03CH13-HY Condition : AVG_BE_54 3m HORN_9120D_1241 HORIZONTAL : RBW:1000.000KHz VBW:0.010KHz SWT:Auto</p>	Left blank



WIFI	Band 2 5250~5350MHz Band Edge @ 3m	
ANT	802.11a CH52 5260MHz - R	
1+2	Horizontal	Fundamental
Peak	<p>Site : 03CH13-FY Condition : PEAK_BE_74 3m HORN_91200_1241 HORIZONTAL : RBW:1000.000kHz VBW:3000.000kHz SWF:Auto</p>	Left blank
Avg.	<p>Site : 03CH13-FY Condition : AVG_BE_54 3m HORN_91200_1241 HORIZONTAL : RBW:1000.000kHz VBW:0.010kHz SWF:Auto</p>	Left blank



WIFI	Band 2 5250~5350MHz Band Edge @ 3m	
ANT	802.11a CH52 5260MHz - L	
1+2	Vertical	Fundamental
<p>Peak</p>	<p>Site : 03CH13-HY Condition : PEAK_BE_74 3m HORN_9120D_1241 VERTICAL : RBW:1000.000KHz VBW:3000.000KHz SWT:Auto</p>	<p>Site : 03CH13-HY Condition : PEAK(UNIT) 3m HORN_9120D_1241 VERTICAL : RBW:1000.000KHz VBW:3000.000KHz SWT:Auto</p>
<p>Avg.</p>	<p>Site : 03CH13-HY Condition : AVG_BE_54 3m HORN_9120D_1241 VERTICAL : RBW:1000.000KHz VBW:0.010KHz SWT:Auto</p>	<p>Left blank</p>

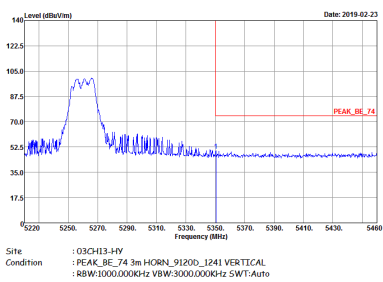
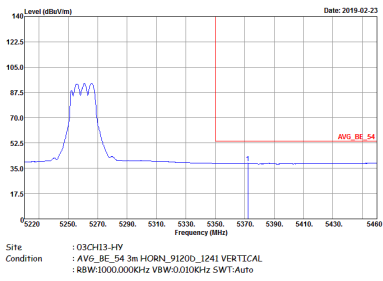

WIFI	Band 2 5250~5350MHz Band Edge @ 3m	
ANT	802.11a CH52 5260MHz - R	
1+2	Vertical	Fundamental
Peak	 <p>Site : 03CH13-HY Condition : PEAK_BE_74 3m HORN_91200_1241 VERTICAL : RBW:1000.000KHz VBW:3000.000KHz SWT:Auto</p>	Left blank
Avg.	 <p>Site : 03CH13-HY Condition : AVG_BE_54 3m HORN_91200_1241 VERTICAL : RBW:1000.000KHz VBW:0.010KHz SWT:Auto</p>	Left blank



WIFI	Band 2 5250~5350MHz Band Edge @ 3m	
ANT	802.11a CH60 5300MHz - L	
1+2	Horizontal	Fundamental
<p>Peak</p>	<p>Site : 03CH13-HY Condition : PEAK_BE_74 3m HORN_9120D_1241 HORIZONTAL : RBW:1000.000KHz VBW:3000.000KHz SWT:Auto</p>	<p>Site : 03CH13-HY Condition : PEAK(UNIT) 3m HORN_9120D_1241 HORIZONTAL : RBW:1000.000KHz VBW:3000.000KHz SWT:Auto</p>
<p>Avg.</p>	<p>Site : 03CH13-HY Condition : AVG_BE_54 3m HORN_9120D_1241 HORIZONTAL : RBW:1000.000KHz VBW:0.010KHz SWT:Auto</p>	<p>Left blank</p>

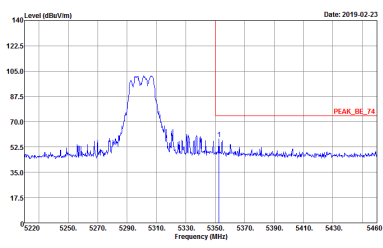
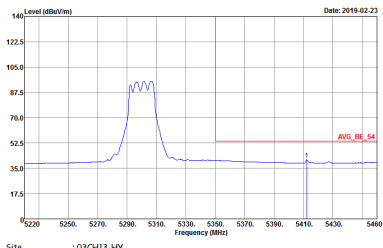

WIFI	Band 2 5250~5350MHz Band Edge @ 3m	
ANT	802.11a CH60 5300MHz - R	
1+2	Horizontal	Fundamental
Peak	 <p>Site : 03CH13-FY Condition : PEAK_BE_74 3m HORN_91200_1241 HORIZONTAL : RBW:1000.000kHz VBW:3000.000kHz SWF:Auto</p>	Left blank
Avg.	 <p>Site : 03CH13-FY Condition : AVG_BE_54 3m HORN_91200_1241 HORIZONTAL : RBW:1000.000kHz VBW:0.010kHz SWF:Auto</p>	Left blank



WIFI	Band 2 5250~5350MHz Band Edge @ 3m	
ANT	802.11a CH60 5300MHz - L	
1+2	Vertical	Fundamental
Peak	<p>Site : 03CH13-HY Condition : PEAK_BE_74 3m HORN_9120D_1241 VERTICAL : RBW:1000.000KHz VBW:3000.000KHz SWT:Auto</p>	<p>Site : 03CH13-HY Condition : PEAK(UNIT) 3m HORN_9120D_1241 VERTICAL : RBW:1000.000KHz VBW:3000.000KHz SWT:Auto</p>
Avg.	<p>Site : 03CH13-HY Condition : AVG_BE_54 3m HORN_9120D_1241 VERTICAL : RBW:1000.000KHz VBW:0.010KHz SWT:Auto</p>	Left blank



WIFI	Band 2 5250~5350MHz Band Edge @ 3m	
ANT	802.11a CH60 5300MHz - R	
1+2	Vertical	Fundamental
<p>Peak</p>		<p>Left blank</p>
<p>Avg.</p>		<p>Left blank</p>

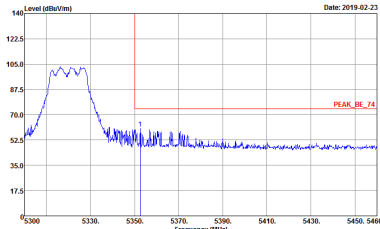
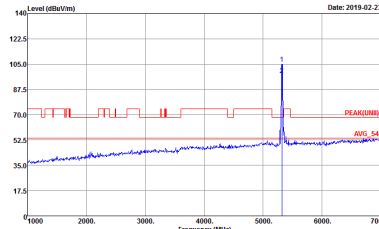
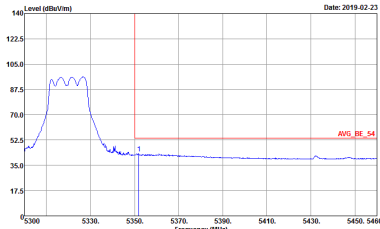

WIFI	Band 2 5250~5350MHz Band Edge @ 3m	
ANT	802.11a CH64 5320MHz	
1+2	Horizontal	Fundamental
<p>Peak</p>	 <p>Site : 03CH13-HY Condition : PEAK_BE_74 3m HORN_9120D_1241 HORIZONTAL : RBW:1000.000KHz VBW:3000.000KHz SWT:Auto</p>	 <p>Site : 03CH13-HY Condition : PEAK(UNIT) 3m HORN_9120D_1241 HORIZONTAL : RBW:1000.000KHz VBW:3000.000KHz SWT:Auto</p>
<p>Avg.</p>	 <p>Site : 03CH13-HY Condition : AVG_BE_54 3m HORN_9120D_1241 HORIZONTAL : RBW:1000.000KHz VBW:1.000KHz SWT:Auto</p>	<p>Left blank</p>

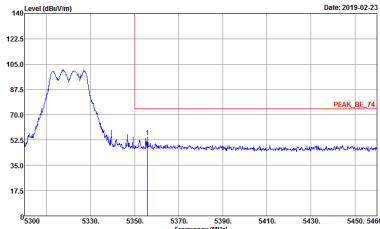
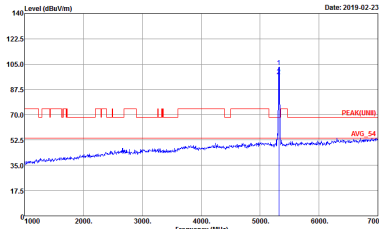
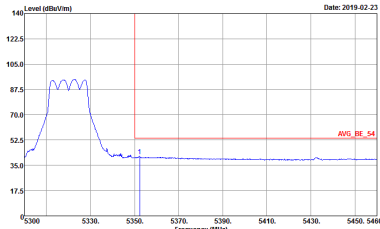

WIFI	Band 2 5250~5350MHz Band Edge @ 3m	
ANT	802.11a CH64 5320MHz	
1+2	Vertical	Fundamental
<p>Peak</p>	 <p>Site : 03CH13-HY Condition : PEAK_BE_74 3m HORN_9120D_1241 VERTICAL : RBW:1000.000KHz VBW:3000.000KHz SWT:Auto</p>	 <p>Site : 03CH13-HY Condition : PEAK(UNIT) 3m HORN_9120D_1241 VERTICAL : RBW:1000.000KHz VBW:3000.000KHz SWT:Auto</p>
<p>Avg.</p>	 <p>Site : 03CH13-HY Condition : AVG_BE_54 3m HORN_9120D_1241 VERTICAL : RBW:1000.000KHz VBW:1.000KHz SWT:Auto</p>	<p>Left blank</p>



**Band 2 5250~5350MHz
WIFI 802.11n HT20 (Band Edge @ 3m)**

WIFI	Band 2 5250~5350MHz Band Edge @ 3m	
ANT	802.11n HT20 CH52 5260MHz - L	
1+2	Horizontal	Fundamental
Peak	<p>Site : 03CH13-HY Condition : PEAK_BE_74 3m HORN_91200_1241 HORIZONTAL : RBW:1000.000KHz VBW:3000.000KHz SWT:Auto</p>	<p>Site : 03CH13-HY Condition : PEAK(LINE) 3m HORN_91200_1241 HORIZONTAL : RBW:1000.000KHz VBW:3000.000KHz SWT:Auto</p>
Avg.	<p>Site : 03CH13-HY Condition : AVG_BE_54 3m HORN_91200_1241 HORIZONTAL : RBW:1000.000KHz VBW:0.010KHz SWT:Auto</p>	Left blank

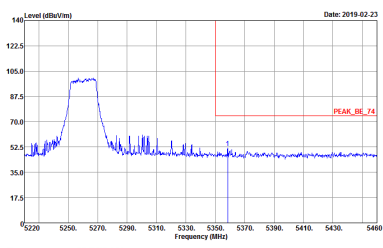
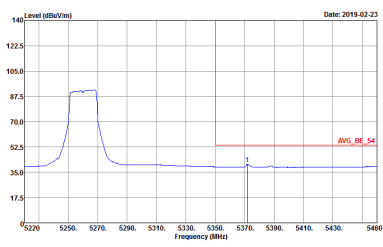

WIFI	Band 2 5250~5350MHz Band Edge @ 3m	
ANT	802.11n HT20 CH52 5260MHz - R	
1+2	Horizontal	Fundamental
<p>Peak</p>		<p>Left blank</p>
<p>Avg.</p>		<p>Left blank</p>



WIFI	Band 2 5250~5350MHz Band Edge @ 3m	
ANT	802.11n HT20 CH52 5260MHz - L	
1+2	Vertical	Fundamental
Peak	<p>Site : 03CH13-HY Condition : PEAK_BE_74 3m HORN_9120D_1241 VERTICAL : RBW:1000.000KHz VBW:3000.000KHz SWT:Auto</p>	<p>Site : 03CH13-HY Condition : PEAK(UNIT) 3m HORN_9120D_1241 VERTICAL : RBW:1000.000KHz VBW:3000.000KHz SWT:Auto</p>
Avg.	<p>Site : 03CH13-HY Condition : AVG_BE_54 3m HORN_9120D_1241 VERTICAL : RBW:1000.000KHz VBW:0.010KHz SWT:Auto</p>	Left blank

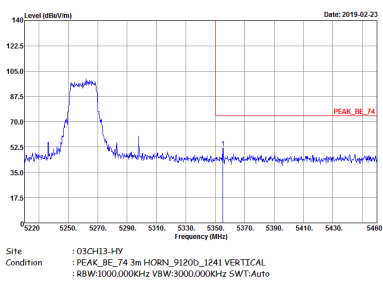
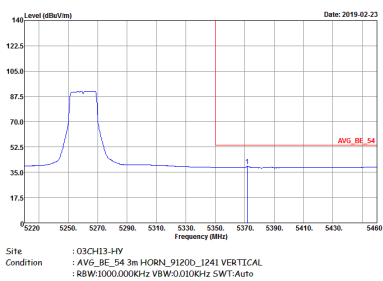

WIFI	Band 2 5250~5350MHz Band Edge @ 3m	
ANT	802.11n HT20 CH52 5260MHz - R	
1+2	Vertical	Fundamental
<p>Peak</p>		<p>Left blank</p>
<p>Avg.</p>		<p>Left blank</p>

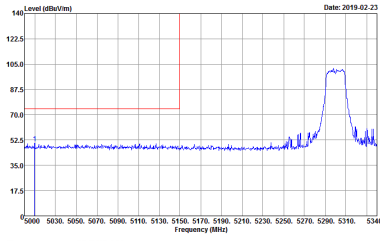
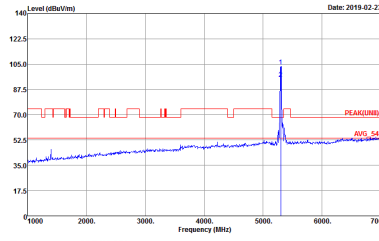
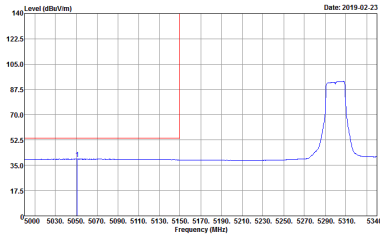

WIFI	Band 2 5250~5350MHz Band Edge @ 3m	
ANT	802.11n HT20 CH60 5300MHz - L	
1+2	Horizontal	Fundamental
<p>Peak</p>	 <p>Site : 03CH13-HY Condition : PEAK_BE_74 3m HORN_9120D_1241 HORIZONTAL : RBW:1000.000KHz VBW:3000.000KHz SWT:Auto</p>	 <p>Site : 03CH13-HY Condition : PEAK(UNIT) 3m HORN_9120D_1241 HORIZONTAL : RBW:1000.000KHz VBW:3000.000KHz SWT:Auto</p>
<p>Avg.</p>	 <p>Site : 03CH13-HY Condition : AVG_BE_54 3m HORN_9120D_1241 HORIZONTAL : RBW:1000.000KHz VBW:0.010KHz SWT:Auto</p>	<p>Left blank</p>



WIFI	Band 2 5250~5350MHz Band Edge @ 3m	
ANT	802.11n HT20 CH60 5300MHz - R	
1+2	Horizontal	Vertical
Peak	<p>Site : 03CH13-FY Condition : PEAK_BE_74 3m HORN_91200_1241 HORIZONTAL : RBW:1000.000KHz VBW:3000.000KHz SWT:Auto</p>	Left blank
Avg.	<p>Site : 03CH13-FY Condition : AVG_BE_54 3m HORN_91200_1241 HORIZONTAL : RBW:1000.000KHz VBW:0.010KHz SWT:Auto</p>	Left blank



WIFI	Band 2 5250~5350MHz Band Edge @ 3m	
ANT	802.11n HT20 CH60 5300MHz - L	
1+2	Vertical	Fundamental
<p>Peak</p>	<p>Site : 03CH13-HY Condition : PEAK_BE_74 3m HORN_9120D_1241 VERTICAL : RBW:1000.000KHz VBW:3000.000KHz SWT:Auto</p>	<p>Site : 03CH13-HY Condition : PEAK(UNIT) 3m HORN_9120D_1241 VERTICAL : RBW:1000.000KHz VBW:3000.000KHz SWT:Auto</p>
<p>Avg.</p>	<p>Site : 03CH13-HY Condition : AVG_BE_54 3m HORN_9120D_1241 VERTICAL : RBW:1000.000KHz VBW:0.010KHz SWT:Auto</p>	<p>Left blank</p>

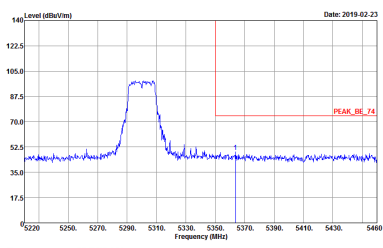
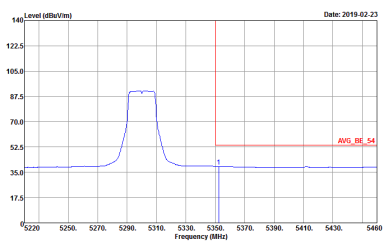

WIFI	Band 2 5250~5350MHz Band Edge @ 3m	
ANT	802.11n HT20 CH60 5300MHz - R	
1+2	Vertical	Fundamental
<p>Peak</p>	 <p>Site : 03CH13-HY Condition : PEAK_BE_74 3m HORN_91200_1241 VERTICAL : RBW:1000.000KHz VBW:3000.000KHz SWT:Auto</p>	<p>Left blank</p>
<p>Avg.</p>	 <p>Site : 03CH13-HY Condition : AVG_BE_54 3m HORN_91200_1241 VERTICAL : RBW:1000.000KHz VBW:0.010KHz SWT:Auto</p>	<p>Left blank</p>



WIFI	Band 2 5250~5350MHz Band Edge @ 3m	
ANT	802.11n HT20 CH64 5320MHz	
1+2	Horizontal	Fundamental
<p>Peak</p>	<p>Site Condition : 03CH13-HY : PEAK_BE_74 3m HORN_91200_1241 HORIZONTAL : RBW:1000.000KHz VBW:3000.000KHz SWT:Auto</p>	<p>Site Condition : 03CH13-HY : PEAK(UNIT) 3m HORN_91200_1241 HORIZONTAL : RBW:1000.000KHz VBW:3000.000KHz SWT:Auto</p>
<p>Avg.</p>	<p>Site Condition : 03CH13-HY : AVG_BE_54 3m HORN_91200_1241 HORIZONTAL : RBW:1000.000KHz VBW:0.010KHz SWT:Auto</p>	<p>Left blank</p>

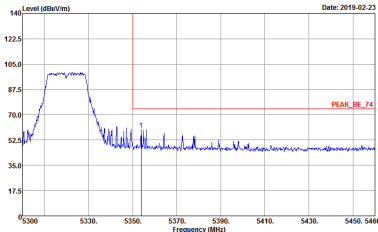
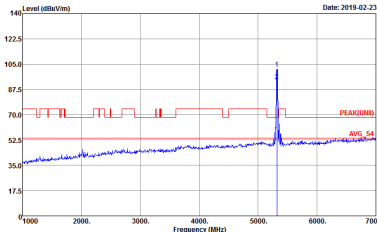
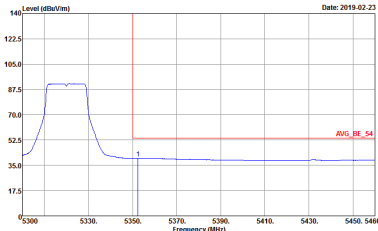

WIFI	Band 2 5250~5350MHz Band Edge @ 3m	
ANT	802.11n HT20 CH64 5320MHz	
1+2	Vertical	Fundamental
<p>Peak</p>	 <p>Site : 03CH13-HY Condition : PEAK_BE_74 3m HORN_9120D_1241 VERTICAL : RBW:1000.000KHz VBW:3000.000KHz SWT:Auto</p>	 <p>Site : 03CH13-HY Condition : PEAK(UNIT) 3m HORN_9120D_1241 VERTICAL : RBW:1000.000KHz VBW:3000.000KHz SWT:Auto</p>
<p>Avg.</p>	 <p>Site : 03CH13-HY Condition : AVG_BE_54 3m HORN_9120D_1241 VERTICAL : RBW:1000.000KHz VBW:0.010KHz SWT:Auto</p>	<p>Left blank</p>



**Band 2 5250~5350MHz
WIFI 802.11n HT40 (Band Edge @ 3m)**

WIFI	Band 2 5250~5350MHz Band Edge @ 3m	
ANT	802.11n HT40 CH54 5270MHz - L	
1+2	Horizontal	Fundamental
Peak	<p>Site : 03CH13-HY Condition : PEAK_BE_74 3m HORN_91200_1241 HORIZONTAL : RBW:1000.000KHz VBW:3000.000KHz SWT:Auto</p>	<p>Site : 03CH13-HY Condition : PEAK(FUND) 3m HORN_91200_1241 HORIZONTAL : RBW:1000.000KHz VBW:3000.000KHz SWT:Auto</p>
Avg.	<p>Site : 03CH13-HY Condition : AVG_BE_54 3m HORN_91200_1241 HORIZONTAL : RBW:1000.000KHz VBW:1.000KHz SWT:Auto</p>	Left blank

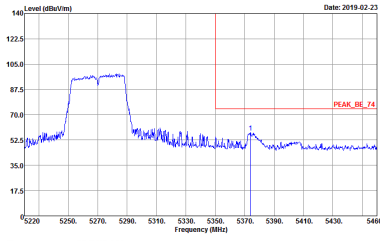
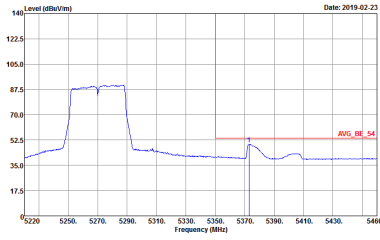

WIFI	Band 2 5250~5350MHz Band Edge @ 3m	
ANT	802.11n HT40 CH54 5270MHz - R	
1+2	Horizontal	Fundamental
Peak	 <p>Site : 03CH13-FY Condition : PEAK_BE_74 3m HORN_9120D_1241 HORIZONTAL : RBW:1000.000KHz VBW:3000.000KHz SWT:Auto</p>	Left blank
Avg.	 <p>Site : 03CH13-FY Condition : AVG_BE_54 3m HORN_9120D_1241 HORIZONTAL : RBW:1000.000KHz VBW:1.000KHz SWT:Auto</p>	Left blank

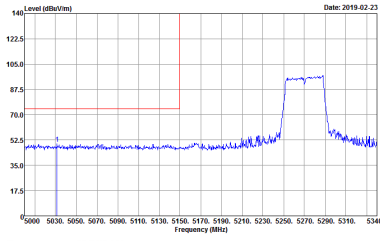
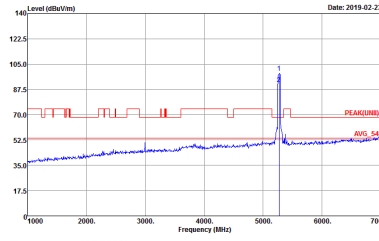
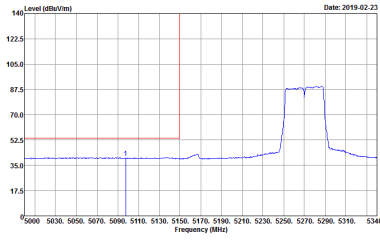

WIFI	Band 2 5250~5350MHz Band Edge @ 3m	
ANT	802.11n HT40 CH54 5270MHz - L	
1+2	Vertical	Vertical
<p>Peak</p>	 <p>Site : 03CH13-HY Condition : PEAK_BE_74 3m HORN_9120D_1241 VERTICAL : RBW:1000.000KHz VBW:3000.000KHz SWT:Auto</p>	 <p>Site : 03CH13-HY Condition : PEAK(UNIT) 3m HORN_9120D_1241 VERTICAL : RBW:1000.000KHz VBW:3000.000KHz SWT:Auto</p>
<p>Avg.</p>	 <p>Site : 03CH13-HY Condition : AVG_BE_54 3m HORN_9120D_1241 VERTICAL : RBW:1000.000KHz VBW:1.000KHz SWT:Auto</p>	<p>Left blank</p>



WIFI	Band 2 5250~5350MHz Band Edge @ 3m	
ANT	802.11n HT40 CH54 5270MHz - R	
1+2	Vertical	Vertical
<p>Peak</p>		<p>Left blank</p>
<p>Avg.</p>		<p>Left blank</p>

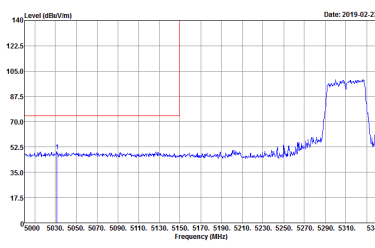
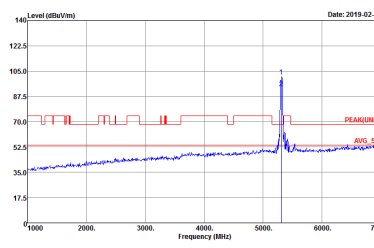
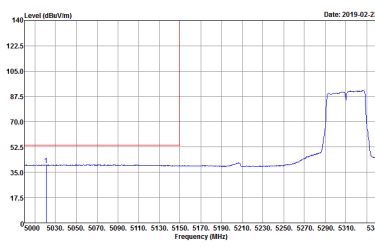

WIFI	Band 2 5250~5350MHz Band Edge @ 3m	
ANT	802.11n HT40 CH62 5310MHz - L	
1+2	Horizontal	Fundamental
<p>Peak</p>	 <p>Site : 03CH13-HY Condition : PEAK_BE_74 3m HORN_9120D_1241 HORIZONTAL : RBW:1000.000KHz VBW:3000.000KHz SWT:Auto</p>	 <p>Site : 03CH13-HY Condition : PEAK(UNIT) 3m HORN_9120D_1241 HORIZONTAL : RBW:1000.000KHz VBW:3000.000KHz SWT:Auto</p>
<p>Avg.</p>	 <p>Site : 03CH13-HY Condition : AVG_BE_54 3m HORN_9120D_1241 HORIZONTAL : RBW:1000.000KHz VBW:1.000KHz SWT:Auto</p>	<p>Left blank</p>



WIFI	Band 2 5250~5350MHz Band Edge @ 3m	
ANT	802.11n HT40 CH62 5310MHz - R	
1+2	Horizontal	Fundamental
Peak	<p>Site : 03CH13-FY Condition : PEAK_BE_74 3m HORN_91200_1241 HORIZONTAL : RBW:1000.000kHz VBW:3000.000kHz SWF:Auto</p>	Left blank
Avg.	<p>Site : 03CH13-FY Condition : AVG_BE_54 3m HORN_91200_1241 HORIZONTAL : RBW:1000.000kHz VBW:1.000kHz SWF:Auto</p>	Left blank



WIFI	Band 2 5250~5350MHz Band Edge @ 3m	
ANT	802.11n HT40 CH62 5310MHz - L	
1+2	Vertical	Fundamental
<p>Peak</p>	<p>Site : 03CH13-HY Condition : PEAK_BE_74 3m HORN_9120D_1241 VERTICAL : RBW:1000.000KHz VBW:3000.000KHz SWT:Auto</p>	<p>Site : 03CH13-HY Condition : PEAK(UNIT) 3m HORN_9120D_1241 VERTICAL : RBW:1000.000KHz VBW:3000.000KHz SWT:Auto</p>
<p>Avg.</p>	<p>Site : 03CH13-HY Condition : AVG_BE_54 3m HORN_9120D_1241 VERTICAL : RBW:1000.000KHz VBW:1.000KHz SWT:Auto</p>	<p>Left blank</p>



WIFI	Band 2 5250~5350MHz Band Edge @ 3m	
ANT	802.11n HT40 CH62 5310MHz - R	
1+2	Vertical	Fundamental
<p>Peak</p>		<p>Left blank</p>
<p>Avg.</p>		<p>Left blank</p>

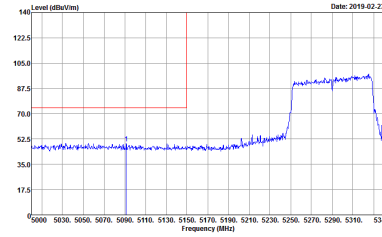
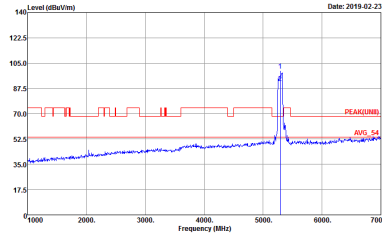
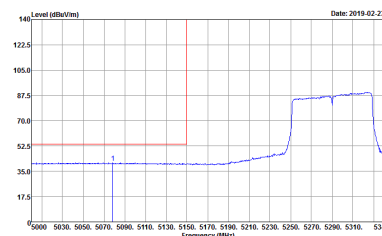

Band 2 5250~5350MHz
WIFI 802.11ac VHT80 (Band Edge @ 3m)

WIFI	Band 2 5250~5350MHz Band Edge @ 3m	
ANT	802.11ac VHT80 CH58 5290MHz - L	
1+2	Horizontal	Fundamental
<p align="center">Peak</p>	 <p>Site : 03CH13-HY Condition : PEAK_BE_74 3m HORN_91200_1241 HORIZONTAL : RBW:1000.000KHz VBW:3000.000KHz SWF:Auto</p>	 <p>Site : 03CH13-HY Condition : PEAK(FUNDT) 3m HORN_91200_1241 HORIZONTAL : RBW:1000.000KHz VBW:3000.000KHz SWF:Auto</p>
<p align="center">Avg.</p>	 <p>Site : 03CH13-HY Condition : AVG_BE_54 3m HORN_91200_1241 HORIZONTAL : RBW:1000.000KHz VBW:3.000KHz SWF:Auto</p>	<p align="center">Left blank</p>



WIFI	Band 2 5250~5350MHz Band Edge @ 3m	
ANT	802.11ac VHT80 CH58 5290MHz - R	
1+2	Horizontal	Fundamental
Peak	<p>Site : 03CH13-FY Condition : PEAK_BE_74 3m HORN_91200_1241 HORIZONTAL : RBW:1000.000kHz VBW:3000.000kHz SWT:Auto</p>	Left blank
Avg.	<p>Site : 03CH13-FY Condition : AVG_BE_54 3m HORN_91200_1241 HORIZONTAL : RBW:1000.000kHz VBW:3.000kHz SWT:Auto</p>	Left blank

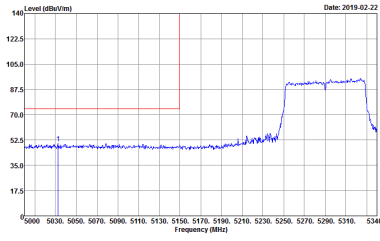
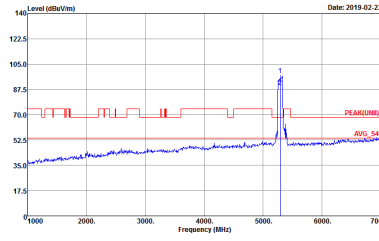
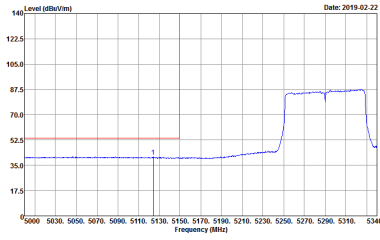

WIFI	Band 2 5250~5350MHz Band Edge @ 3m	
ANT	802.11ac VHT80 CH58 5290MHz - L	
1+2	Vertical	Fundamental
<p>Peak</p>	 <p>Site : 03CH13-HY Condition : PEAK_BE_74 3m HORN_9120D_1241 VERTICAL : RBW:1000.000KHz VBW:3000.000KHz SWT:Auto</p>	 <p>Site : 03CH13-HY Condition : PEAK(UNIT) 3m HORN_9120D_1241 VERTICAL : RBW:1000.000KHz VBW:3000.000KHz SWT:Auto</p>
<p>Avg.</p>	 <p>Site : 03CH13-HY Condition : AVG_BE_54 3m HORN_9120D_1241 VERTICAL : RBW:1000.000KHz VBW:3000.000KHz SWT:Auto</p>	<p>Left blank</p>



WIFI	Band 2 5250~5350MHz Band Edge @ 3m	
ANT	802.11ac VHT80 CH58 5290MHz - R	
1+2	Vertical	Fundamental
<p>Peak</p>	<p>Site : 03CH13-HY Condition : PEAK_BE_74 3m HORN_91200_1241 VERTICAL : RBW:1000.000kHz VBW:3000.000kHz SWT:Auto</p>	<p>Left blank</p>
<p>Avg.</p>	<p>Site : 03CH13-HY Condition : AVG_BE_54 3m HORN_91200_1241 VERTICAL : RBW:1000.000kHz VBW:3.000kHz SWT:Auto</p>	<p>Left blank</p>



Band 2 - 5250~5350MHz
WIFI 802.11a (Harmonic @ 3m)

WIFI	Band 2 5250~5350MHz Harmonic @ 3m	
ANT	802.11a CH52 5260MHz	
1+2	Horizontal	Vertical
Peak Avg.	<p>Site : 03CH13-HY Condition : PEAK(LINEI) 3m HORN_9120D_1241 HORIZONTAL Detector : Peak</p>	<p>Site : 03CH13-HY Condition : PEAK(LINEI) 3m HORN_9120D_1241 VERTICAL Detector : Peak</p>



WIFI	Band 2 5250~5350MHz Harmonic @ 3m	
ANT	802.11a CH60 5300MHz	
1+2	Horizontal	Vertical
Peak Avg.	<p>Site : 03CH13-HY Condition : PEAK(UNII) 3m HORN_91200_1241 HORIZONTAL Detector : Peak</p>	<p>Site : 03CH13-HY Condition : PEAK(UNII) 3m HORN_91200_1241 VERTICAL Detector : Peak</p>



WIFI	Band 2 5250~5350MHz Harmonic @ 3m	
ANT	802.11a CH64 5320MHz	
1+2	Horizontal	Vertical
Peak Avg.	<p>Site : 03CH13-HY Condition : PEAK(UNII) 3m HORN_91200_1241 HORIZONTAL Detector : Peak</p>	<p>Site : 03CH13-HY Condition : PEAK(UNII) 3m HORN_91200_1241 VERTICAL Detector : Peak</p>



Band 2 5250~5350MHz
WIFI 802.11n HT20 (Harmonic @ 3m)

WIFI	Band 2 5250~5350MHz Harmonic @ 3m	
ANT	802.11n HT20 CH52 5260MHz	
1+2	Horizontal	Vertical
<p>Peak</p> <p>Avg.</p>	<p>Site : 03CH13-HY Condition : PEAK(LINE1) 3m HORN_91200_1241 HORIZONTAL Detector : Peak</p>	<p>Site : 03CH13-HY Condition : PEAK(LINE1) 3m HORN_91200_1241 VERTICAL Detector : Peak</p>



WIFI	Band 2 5250~5350MHz Harmonic @ 3m	
ANT	802.11n HT20 CH60 5300MHz	
1+2	Horizontal	Vertical
Peak Avg.	<p>Site : 03CH13-HY Condition : PEAK(LINEI) 3m HORN_91200_1241 HORIZONTAL Detector : Peak</p>	<p>Site : 03CH13-HY Condition : PEAK(LINEI) 3m HORN_91200_1241 VERTICAL Detector : Peak</p>



WIFI	Band 2 5250~5350MHz Harmonic @ 3m	
ANT	802.11n HT20 CH64 5320MHz	
1+2	Horizontal	Vertical
Peak Avg.	<p>Site : 03CH13-HY Condition : PEAK(UNII) 3m HORN_91200_1241 VERTICAL Detector : Peak</p>	<p>Site : 03CH13-HY Condition : PEAK(UNII) 3m HORN_91200_1241 VERTICAL Detector : Peak</p>

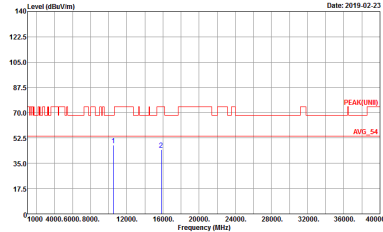
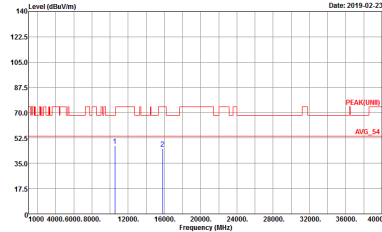

Band 2 5250~5350MHz
WIFI 802.11n HT40 (Harmonic @ 3m)

WIFI	Band 2 5250~5350MHz Harmonic @ 3m	
ANT	802.11n HT40 CH54 5270MHz	
1+2	Horizontal	Vertical
<p>Peak</p> <p>Avg.</p>	 <p>Site : 03CH13-HY Condition : PEAK(LINE1) 3m HORN_91200_1241 HORIZONTAL Detector : Peak</p>	 <p>Site : 03CH13-HY Condition : PEAK(LINE1) 3m HORN_91200_1241 VERTICAL Detector : Peak</p>



WIFI	Band 2 5250~5350MHz Harmonic @ 3m	
ANT	802.11n HT40 CH62 5310MHz	
1+2	Horizontal	Vertical
Peak Avg.	<p>Site : 03CH13-HY Condition : PEAK(LINEI) 3m HORN_91200_1241 HORIZONTAL Detector : Peak</p>	<p>Site : 03CH13-HY Condition : PEAK(LINEI) 3m HORN_91200_1241 VERTICAL Detector : Peak</p>



Band 2 5250~5350MHz
WIFI 802.11ac VHT80 (Harmonic @ 3m)

WIFI	Band 2 5250~5350MHz Harmonic @ 3m	
ANT	802.11ac VHT80 CH58 5290MHz	
1+2	Horizontal	Vertical
<p>Peak</p> <p>Avg.</p>	<p>Site : 03CH13-HY Condition : PEAK(LINE1) 3m HORN_91200_1241 HORIZONTAL Detector : Peak</p>	<p>Site : 03CH13-HY Condition : PEAK(LINE1) 3m HORN_91200_1241 VERTICAL Detector : Peak</p>

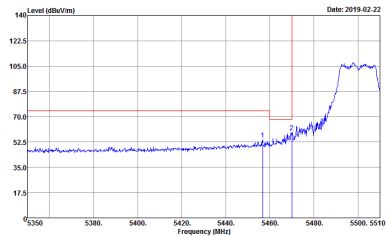
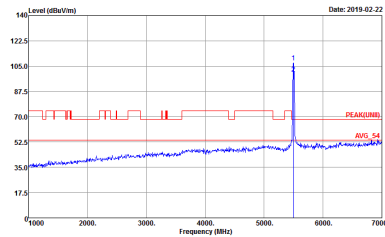
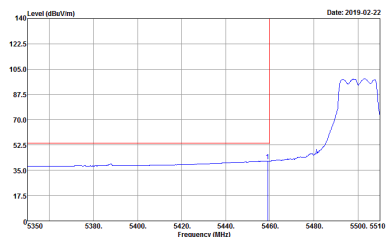

Band 3 - 5470~5725MHz
WIFI 802.11a (Band Edge @ 3m)

WIFI	Band 3 5470~5725MHz Band Edge @ 3m	
ANT	802.11a CH100 5500MHz	
1+2	Horizontal	Fundamental
<p align="center">Peak</p>	 <p>Site Condition : 03CH13-HY : PEAK_BE(UNIT)_B3 3m HORN_91200_1241 HORIZONTAL : RBW:1000.000KHz VBW:3000.000KHz SWT:Auto</p>	 <p>Site Condition : 03CH13-HY : PEAK(UNIT) 3m HORN_91200_1241 HORIZONTAL : RBW:1000.000KHz VBW:3000.000KHz SWT:Auto</p>
<p align="center">Avg.</p>	 <p>Site Condition : 03CH13-HY : AVG_BE(UNIT)_B3 3m HORN_91200_1241 HORIZONTAL : RBW:1000.000KHz VBW:0.010KHz SWT:Auto</p>	<p align="center">Left blank</p>



WIFI	Band 3 5470~5725MHz Band Edge @ 3m	
ANT	802.11a CH100 5500MHz	
1+2	Vertical	Fundamental
<p>Peak</p>	<p>Site : 03CH13-HY Condition : PEAK_BE(UNIT)_B3 3m HORN_91200_1241 VERTICAL : RBW:1000.000KHz VBW:3000.000KHz SWT:Auto</p>	<p>Site : 03CH13-HY Condition : PEAK(UNIT) 3m HORN_91200_1241 VERTICAL : RBW:1000.000KHz VBW:3000.000KHz SWT:Auto</p>
<p>Avg.</p>	<p>Site : 03CH13-HY Condition : AVG_BE(UNIT)_B3 3m HORN_91200_1241 VERTICAL : RBW:1000.000KHz VBW:0.010KHz SWT:Auto</p>	<p>Left blank</p>

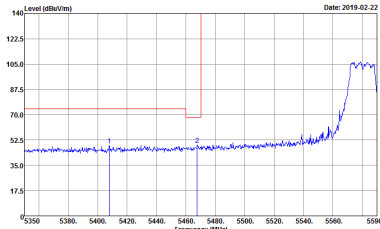
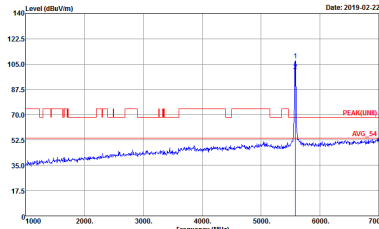
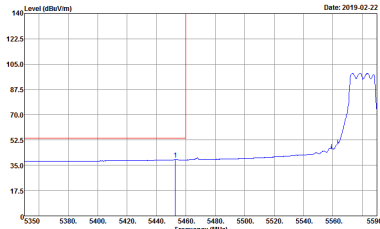

WIFI	Band 3 5470~5725MHz Band Edge @ 3m	
ANT	802.11a CH116 5580MHz - L	
1+2	Horizontal	Fundamental
<p>Peak</p>	 <p>Site : 03CH13-HY Condition : PEAK_BE(UNIT)_B3 3m HORN_91200_1241 HORIZONTAL : RBW:1000.000KHz VBW:3000.000KHz SWT:Auto</p>	 <p>Site : 03CH13-HY Condition : PEAK(UNIT) 3m HORN_91200_1241 HORIZONTAL : RBW:1000.000KHz VBW:3000.000KHz SWT:Auto</p>
<p>Avg.</p>	 <p>Site : 03CH13-HY Condition : AVG_BE(UNIT)_B3 3m HORN_91200_1241 HORIZONTAL : RBW:1000.000KHz VBW:0.010KHz SWT:Auto</p>	<p>Left blank</p>



WIFI	Band 3 5470~5725MHz Band Edge @ 3m	
ANT	802.11a CH116 5580MHz - R	
1+2	Horizontal	Fundamental
Peak	<p>Site : 03CH13-FY Condition : PEAK_BE(UNIT)_B3 3m HORN_91200_1241 HORIZONTAL : RBW:1000.000KHz VBW:3000.000KHz SWT:Auto</p>	Left blank

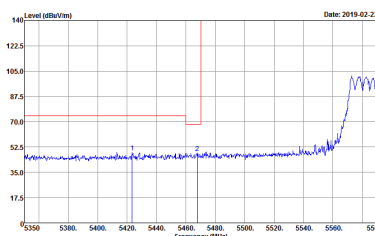
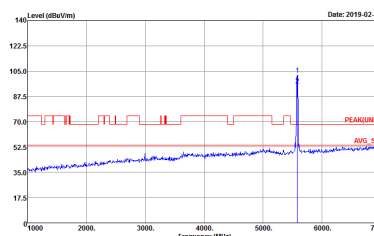
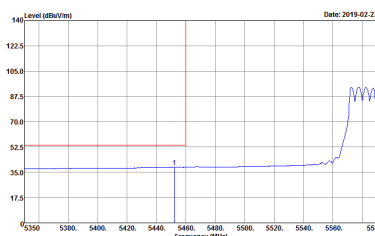

WIFI	Band 3 5470~5725MHz Band Edge @ 3m	
ANT	802.11a CH116 5580MHz - L	
1+2	Vertical	Fundamental
Peak	 <p>Site : 03CH13-HY Condition : PEAK_BE(UNIT)_B3 3m HORN_91200_1241 VERTICAL : RBW:1000.000KHz VBW:3000.000KHz SWT:Auto</p>	 <p>Site : 03CH13-HY Condition : PEAK(UNIT) 3m HORN_91200_1241 VERTICAL : RBW:1000.000KHz VBW:3000.000KHz SWT:Auto</p>
Avg.	 <p>Site : 03CH13-HY Condition : AVG_BE(UNIT)_B3 3m HORN_91200_1241 VERTICAL : RBW:1000.000KHz VBW:0.010KHz SWT:Auto</p>	Left blank

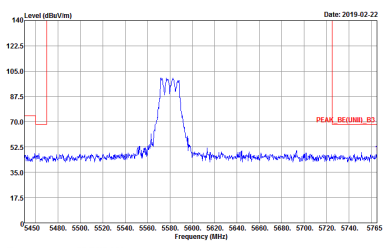

WIFI	Band 3 5470~5725MHz Band Edge @ 3m	
ANT	802.11a CH116 5580MHz - R	
1+2	Vertical	Fundamental
Peak	 <p>Site : 03CH13-HY Condition : PEAK_BE(UNIT1)_B3 3m HORN_91200_1241 VERTICAL : RBW:1000.000KHz VBW:3000.000KHz SWT:Auto</p>	Left blank



WIFI	Band 3 5470~5725MHz Band Edge @ 3m	
ANT	802.11a CH140 5700MHz	
1+2	Horizontal	Fundamental
Peak	<p>Site : 03CH13-HY Condition : PEAK_BE(UNIT)_B3 3m HORN_91200_1241 HORIZONTAL : RBW:1000.000KHz VBW:3000.000KHz SWT:Auto</p>	<p>Site : 03CH13-HY Condition : PEAK(UNIT) 3m HORN_91200_1241 HORIZONTAL : RBW:1000.000KHz VBW:3000.000KHz SWT:Auto</p>

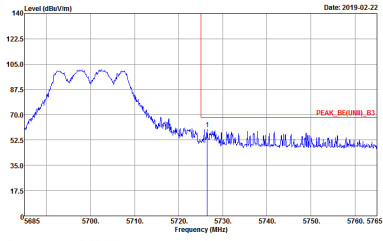
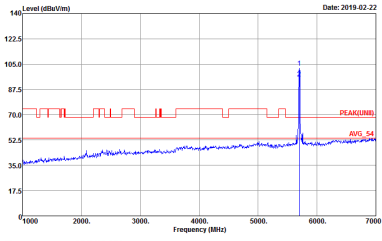

WIFI	Band 3 5470~5725MHz Band Edge @ 3m	
ANT	802.11a CH140 5700MHz	
1+2	Vertical	Fundamental
Peak	 <p>Site : 03CH13-HY Condition : PEAK_BE(UNIT)_B3 3m HORN_91200_1241 VERTICAL : RBW:1000.000KHz VBW:3000.000KHz SWT:Auto</p>	 <p>Site : 03CH13-HY Condition : PEAK(UNIT)_B3 3m HORN_91200_1241 VERTICAL : RBW:1000.000KHz VBW:3000.000KHz SWT:Auto</p>

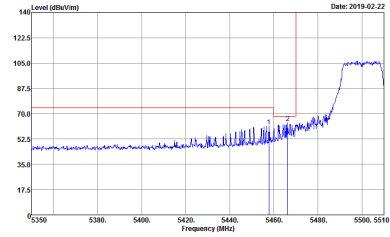
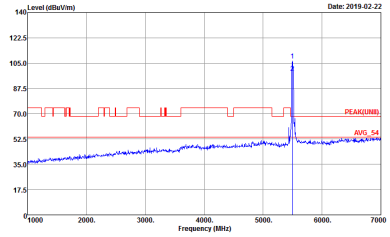
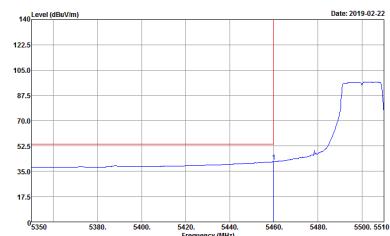

**Band 3 5470~5725MHz
WIFI 802.11n HT20 (Band Edge @ 3m)**

WIFI	Band 3 5470~5725MHz Band Edge @ 3m	
ANT	802.11n HT20 CH100 5500MHz	
1+2	Horizontal	Fundamental
<p align="center">Peak</p>	 <p>Site : 03CH13-HY Condition : PEAK_BE(UNIT)_B3 3m HORN_91200_1241 HORIZONTAL : RBW:1000.000KHz VBW:3000.000KHz SWT:Auto</p>	 <p>Site : 03CH13-HY Condition : PEAK(UNIT) 3m HORN_91200_1241 HORIZONTAL : RBW:1000.000KHz VBW:3000.000KHz SWT:Auto</p>
<p align="center">Avg.</p>	 <p>Site : 03CH13-HY Condition : AVG_BE(UNIT)_B3 3m HORN_91200_1241 HORIZONTAL : RBW:1000.000KHz VBW:0.010KHz SWT:Auto</p>	<p align="center">Left blank</p>

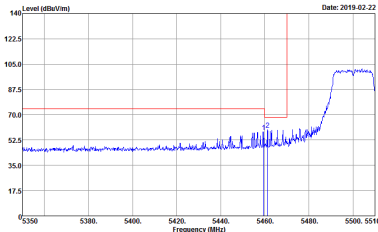
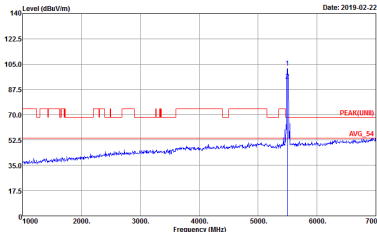
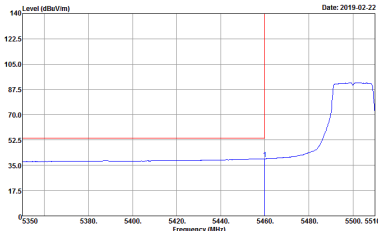

WIFI	Band 3 5470~5725MHz Band Edge @ 3m	
ANT	802.11n HT20 CH100 5500MHz	
1+2	Vertical	Fundamental
Peak	 <p>Site : 03CH13-HY Condition : PEAK_BE(UNIT)_B3 3m HORN_91200_1241 VERTICAL : RBW:1000.000KHz VBW:3000.000KHz SWT:Auto</p>	 <p>Site : 03CH13-HY Condition : PEAK(UNIT) 3m HORN_91200_1241 VERTICAL : RBW:1000.000KHz VBW:3000.000KHz SWT:Auto</p>
Avg.	 <p>Site : 03CH13-HY Condition : AVG_BE(UNIT)_B3 3m HORN_91200_1241 VERTICAL : RBW:1000.000KHz VBW:0.010KHz SWT:Auto</p>	Left blank



WIFI	Band 3 5470~5725MHz Band Edge @ 3m	
ANT	802.11n HT20 CH116 5580MHz - L	
1+2	Horizontal	Fundamental
Peak	<p>Site : 03CH13-HY Condition : PEAK_BE(UNIT)_B3 3m HORN_91200_1241 HORIZONTAL : RBW:1000.000KHz VBW:3000.000KHz SWT:Auto</p>	<p>Site : 03CH13-HY Condition : PEAK(UNIT) 3m HORN_91200_1241 HORIZONTAL : RBW:1000.000KHz VBW:3000.000KHz SWT:Auto</p>
Avg.	<p>Site : 03CH13-HY Condition : AVG_BE(UNIT)_B3 3m HORN_91200_1241 HORIZONTAL : RBW:1000.000KHz VBW:0.010KHz SWT:Auto</p>	Left blank



WIFI	Band 3 5470~5725MHz Band Edge @ 3m	
ANT	802.11n HT20 CH116 5580MHz - R	
1+2	Horizontal	Fundamental
Peak	<p>Site : 03CH13-HY Condition : PEAK_BE(UNIT)_B3 3m HORN_91200_1241 HORIZONTAL : RBW:1000.000KHz VBW:3000.000KHz SWT:Auto</p>	Left blank



WIFI	Band 3 5470~5725MHz Band Edge @ 3m	
ANT	802.11n HT20 CH116 5580MHz - L	
1+2	Vertical	Fundamental
<p>Peak</p>	<p>Site : 03CH13-HY Condition : PEAK_BE(UNIT)_B3 3m HORN_91200_1241 VERTICAL : RBW:1000.000KHz VBW:3000.000KHz SWT:Auto</p>	<p>Site : 03CH13-HY Condition : PEAK(UNIT) 3m HORN_91200_1241 VERTICAL : RBW:1000.000KHz VBW:3000.000KHz SWT:Auto</p>
<p>Avg.</p>	<p>Site : 03CH13-HY Condition : AVG_BE(UNIT)_B3 3m HORN_91200_1241 VERTICAL : RBW:1000.000KHz VBW:0.010KHz SWT:Auto</p>	<p>Left blank</p>



WIFI	Band 3 5470~5725MHz Band Edge @ 3m	
ANT	802.11n HT20 CH116 5580MHz - R	
1+2	Vertical	Fundamental
Peak	<p>Site : 03CH13-HY Condition : PEAK_BE(UNIT)_B3 3m HORN_91200_1241 VERTICAL : RBW:1000.000KHz VBW:3000.000KHz SWT:Auto</p>	Left blank

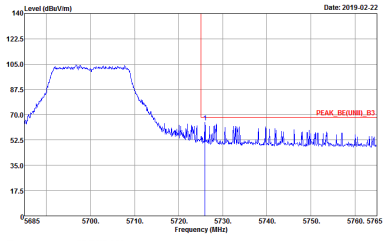
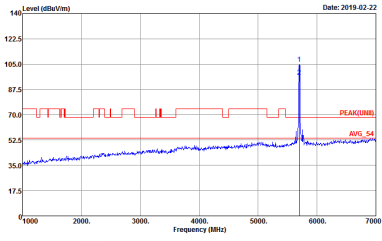

WIFI	Band 3 5470~5725MHz Band Edge @ 3m	
ANT	802.11n HT20 CH140 5700MHz	
1+2	Horizontal	Fundamental
Peak	 <p>Site : 03CH13-HY Condition : PEAK_BE(UNIT)_B3 3m HORN_91200_1241 HORIZONTAL : RBW:1000.000KHz VBW:3000.000KHz SWT:Auto</p>	 <p>Site : 03CH13-HY Condition : PEAK(UNIT)_B3 3m HORN_91200_1241 HORIZONTAL : RBW:1000.000KHz VBW:3000.000KHz SWT:Auto</p>

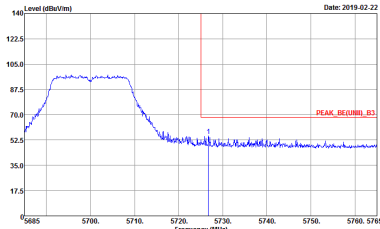
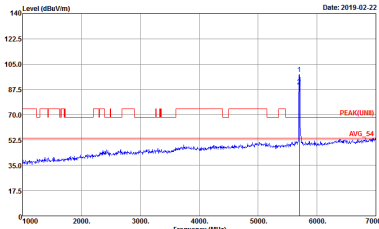

WIFI	Band 3 5470~5725MHz Band Edge @ 3m	
ANT	802.11n HT20 CH140 5700MHz	
1+2	Vertical	Fundamental
Peak.	 <p>Site : 03CH13-HY Condition : PEAK_BE(UNIT)_B3 3m HORN_91200_1241 VERTICAL : RBW:1000.000KHz VBW:3000.000KHz SWT:Auto</p>	 <p>Site : 03CH13-HY Condition : PEAK(UNIT) 3m HORN_91200_1241 VERTICAL : RBW:1000.000KHz VBW:3000.000KHz SWT:Auto</p>



**Band 3 5470~5725MHz
WIFI 802.11n HT40 (Band Edge @ 3m)**

WIFI	Band 3 5470~5725MHz Band Edge @ 3m	
ANT	802.11n HT40 CH102 5510MHz - L	
1+2	Horizontal	Fundamental
<p align="center">Peak</p>		
<p align="center">Avg.</p>		<p align="center">Left blank</p>



WIFI	Band 3 5470~5725MHz Band Edge @ 3m	
ANT	802.11n HT40 CH102 5510MHz - R	
1+2	Horizontal	Fundamental
Peak	<p>Site : 03CH13-FY Condition : PEAK_BE(UNIT1)_B3 3m HORN_91200_1241 HORIZONTAL : RBW:1000.000KHz VBW:3000.000KHz SWT:Auto</p>	Left blank

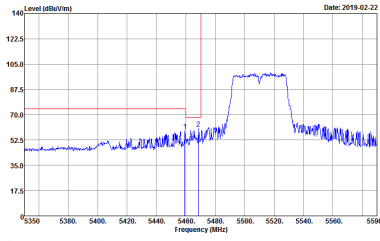
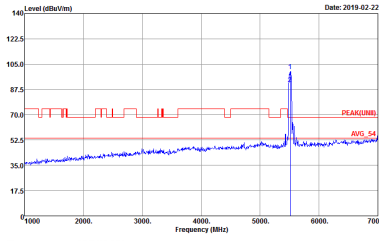
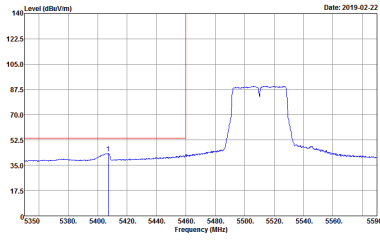

WIFI	Band 3 5470~5725MHz Band Edge @ 3m	
ANT	802.11n HT40 CH102 5510MHz - L	
1+2	Vertical	Fundamental
Peak	 <p>Site : 03CH13-HY Condition : PEAK_BE(UNIT)_B3 3m HORN_91200_1241 VERTICAL : RBW:1000.000KHz VBW:3000.000KHz SWT:Auto</p>	 <p>Site : 03CH13-HY Condition : PEAK(UNIT) 3m HORN_91200_1241 VERTICAL : RBW:1000.000KHz VBW:3000.000KHz SWT:Auto</p>
Avg.	 <p>Site : 03CH13-HY Condition : AVG_BE(UNIT)_B3 3m HORN_91200_1241 VERTICAL : RBW:1000.000KHz VBW:1.000KHz SWT:Auto</p>	Left blank



WIFI	Band 3 5470~5725MHz Band Edge @ 3m	
ANT	802.11n HT40 CH102 5510MHz - R	
1+2	Vertical	Fundamental
Peak	<p>Site : 03CH13-FY Condition : PEAK_BE(UNIT1)_B3 3m HORN_91200_1241 VERTICAL : RBW:1000.000KHz VBW:3000.000KHz SWT:Auto</p>	Left blank

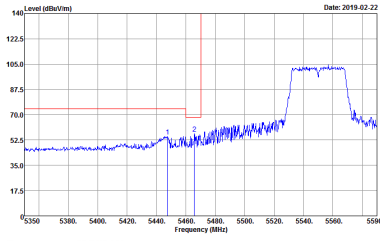
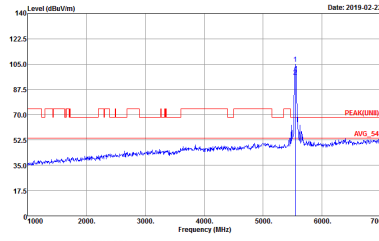
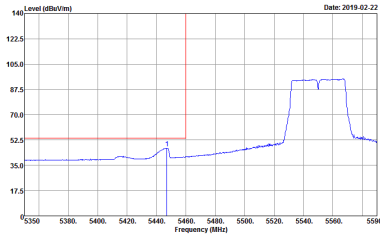

WIFI	Band 3 5470~5725MHz Band Edge @ 3m	
ANT	802.11n HT40 CH110 5550MHz - L	
1+2	Horizontal	Fundamental
<p>Peak</p>	 <p>Site : 03CH13-HY Condition : PEAK_BE(UNIT)_B3 3m HORN_91200_1241 HORIZONTAL : RBW:1000.000KHz VBW:3000.000KHz SWT:Auto</p>	 <p>Site : 03CH13-HY Condition : PEAK(UNIT) 3m HORN_91200_1241 HORIZONTAL : RBW:1000.000KHz VBW:3000.000KHz SWT:Auto</p>
<p>Avg.</p>	 <p>Site : 03CH13-HY Condition : AVG_BE(UNIT)_B3 3m HORN_91200_1241 HORIZONTAL : RBW:1000.000KHz VBW:1.000KHz SWT:Auto</p>	<p>Left blank</p>



WIFI	Band 3 5470~5725MHz Band Edge @ 3m	
ANT	802.11n HT40 CH110 5550MHz - R	
1+2	Horizontal	Fundamental
Peak	<p>Site : 03CH13-FY Condition : PEAK_BE(UNIT1)_B3 3m HORN_91200_1241 HORIZONTAL : RBW:1000.000KHz VBW:3000.000KHz SWT:Auto</p>	Left blank



WIFI	Band 3 5470~5725MHz Band Edge @ 3m	
ANT	802.11n HT40 CH110 5550MHz - L	
1+2	Vertical	Fundamental
Peak	<p>Site : 03CH13-HY Condition : PEAK_BE(UNIT)_B3 3m HORN_91200_1241 VERTICAL : RBW:1000.000KHz VBW:3000.000KHz SWT:Auto</p>	<p>Site : 03CH13-HY Condition : PEAK(UNIT) 3m HORN_91200_1241 VERTICAL : RBW:1000.000KHz VBW:3000.000KHz SWT:Auto</p>
Avg.	<p>Site : 03CH13-HY Condition : AVG_BE(UNIT)_B3 3m HORN_91200_1241 VERTICAL : RBW:1000.000KHz VBW:1.000KHz SWT:Auto</p>	Left blank



WIFI	Band 3 5470~5725MHz Band Edge @ 3m	
ANT	802.11n HT40 CH110 5550MHz - R	
1+2	Vertical	Fundamental
Peak	<p>Site : 03CH13-HY Condition : PEAK_BE(UNIT)_B3 3m HORN_91200_1241 VERTICAL : RBW:1000.000KHz VBW:3000.000KHz SWT:Auto</p>	Left blank

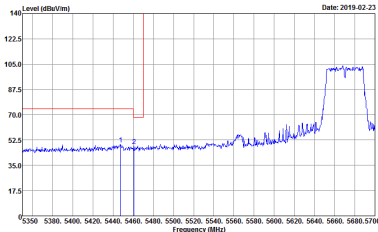
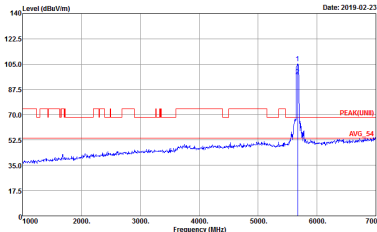
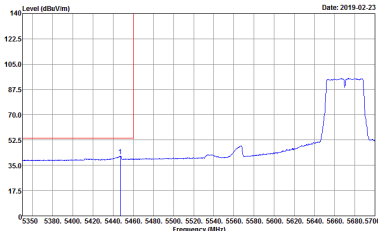

WIFI	Band 3 5470~5725MHz Band Edge @ 3m	
ANT	802.11n HT40 CH134 5670MHz - L	
1+2	Horizontal	Fundamental
<p>Peak</p>	 <p>Site : 03CH13-HY Condition : PEAK_BE(UNIT)_B3 3m HORN_91200_1241 HORIZONTAL : RBW:1000.000KHz VBW:3000.000KHz SWT:Auto</p>	 <p>Site : 03CH13-HY Condition : PEAK(UNIT) 3m HORN_91200_1241 HORIZONTAL : RBW:1000.000KHz VBW:3000.000KHz SWT:Auto</p>
<p>Avg.</p>	 <p>Site : 03CH13-HY Condition : AVG_BE(UNIT)_B3 3m HORN_91200_1241 HORIZONTAL : RBW:1000.000KHz VBW:1.000KHz SWT:Auto</p>	<p>Left blank</p>



WIFI	Band 3 5470~5725MHz Band Edge @ 3m	
ANT	802.11n HT40 CH134 5670MHz - R	
1+2	Horizontal	Fundamental
Peak	<p>Site : 03CH13-FY Condition : PEAK_BE(UNIT)_B3 3m HORN_91200_1241 HORIZONTAL : RBW:1000.000KHz VBW:3000.000KHz SWT:Auto</p>	Left blank

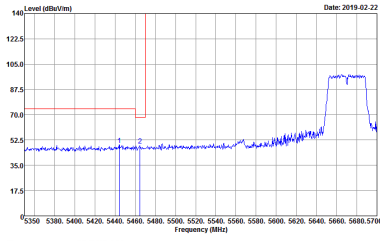
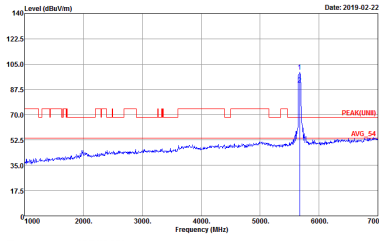
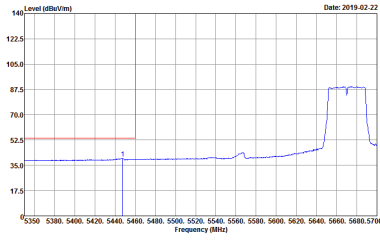

WIFI	Band 3 5470~5725MHz Band Edge @ 3m	
ANT	802.11n HT40 CH134 5670MHz - L	
1+2	Vertical	Fundamental
<p>Peak</p>	 <p>Site : 03CH13-HY Condition : PEAK_BE(UNIT)_B3 3m HORN_91200_1241 VERTICAL : RBW:1000.000KHz VBW:3000.000KHz SWT:Auto</p>	 <p>Site : 03CH13-HY Condition : PEAK(UNIT) 3m HORN_91200_1241 VERTICAL : RBW:1000.000KHz VBW:3000.000KHz SWT:Auto</p>
<p>Avg.</p>	 <p>Site : 03CH13-HY Condition : AVG_BE(UNIT)_B3 3m HORN_91200_1241 VERTICAL : RBW:1000.000KHz VBW:1.000KHz SWT:Auto</p>	<p>Left blank</p>



WIFI	Band 3 5470~5725MHz Band Edge @ 3m	
ANT	802.11n HT40 CH134 5670MHz - R	
1+2	Vertical	Fundamental
Peak	<p>Site : 03CH13-FY Condition : PEAK_BE(UNIT)_B3 3m HORN_91200_1241 VERTICAL : RBW:1000.000KHz VBW:3000.000KHz SWT:Auto</p>	Left blank

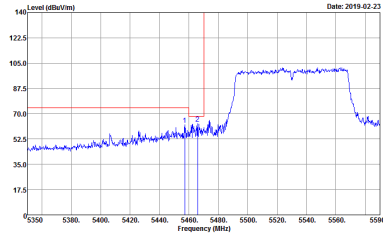
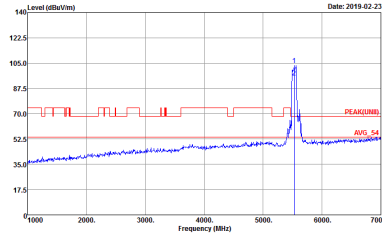
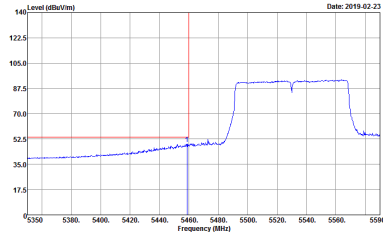

**Band 3 5470~5725MHz
WIFI 802.11ac VHT80 (Band Edge @ 3m)**

WIFI	Band 3 5470~5725MHz Band Edge @ 3m	
ANT	802.11ac VHT80 CH106 5530MHz - L	
1+2	Horizontal	Fundamental
<p align="center">Peak</p>	 <p>Site : 03CH13-HY Condition : PEAK_BE(UNIT)_B3 3m HORN_91200_1241 HORIZONTAL : RBW:1000.000KHz VBW:3000.000KHz SWF:Auto</p>	 <p>Site : 03CH13-HY Condition : PEAK(UNIT) 3m HORN_91200_1241 HORIZONTAL : RBW:1000.000KHz VBW:3000.000KHz SWT:Auto</p>
<p align="center">Avg.</p>	 <p>Site : 03CH13-HY Condition : AVG_BE(UNIT)_B3 3m HORN_91200_1241 HORIZONTAL : RBW:1000.000KHz VBW:3.000KHz SWF:Auto</p>	<p align="center">Left blank</p>



WIFI	Band 3 5470~5725MHz Band Edge @ 3m	
ANT	802.11ac VHT80 CH106 5530MHz - R	
1+2	Horizontal	Fundamental
Peak	<p>Site : 03CH13-FY Condition : PEAK_BE(UNIT1)_B3 3m HORN_91200_1241 HORIZONTAL : RBW:1000.000KHz VBW:3000.000KHz SWT:Auto</p>	Left blank

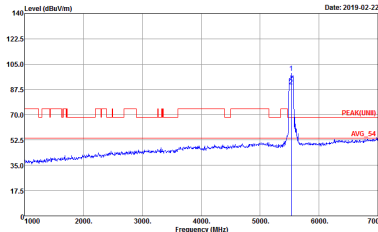
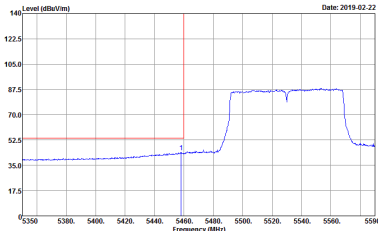

WIFI	Band 3 5470~5725MHz Band Edge @ 3m	
ANT	802.11ac VHT80 CH106 5530MHz - L	
1+2	Vertical	Fundamental
Peak	 <p>Site : 03CH13-HY Condition : PEAK_BE(UNIT)_B3 3m HORN_91200_1241 VERTICAL : RBW:1000.000KHz VBW:3000.000KHz SWT:Auto</p>	 <p>Site : 03CH13-HY Condition : PEAK(UNIT) 3m HORN_91200_1241 VERTICAL : RBW:1000.000KHz VBW:3000.000KHz SWT:Auto</p>
Avg.	 <p>Site : 03CH13-HY Condition : AVG_BE(UNIT)_B3 3m HORN_91200_1241 VERTICAL : RBW:1000.000KHz VBW:3000.000KHz SWT:Auto</p>	Left blank

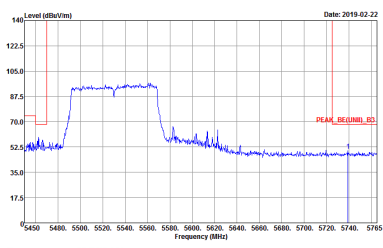

WIFI	Band 3 5470~5725MHz Band Edge @ 3m	
ANT	802.11ac VHT80 CH106 5530MHz - R	
1+2	Vertical	Fundamental
Peak	 <p>Site : 03CH13-FY Condition : PEAK_BE(UNIT)_B3 3m HORN_91200_1241 VERTICAL : RBW:1000.000KHz VBW:3000.000KHz SWT:Auto</p>	Left blank



WIFI	Band 3 5470~5725MHz Band Edge @ 3m	
ANT	802.11ac VHT80 CH122 5610MHz - L	
1+2	Horizontal	Fundamental
Peak	<p>Site : 03CH13-HY Condition : PEAK_BE(UNIT)_B3 3m HORN_91200_1241 HORIZONTAL : RBW:1000.000KHz VBW:3000.000KHz SWT:Auto</p>	<p>Site : 03CH13-HY Condition : PEAK(UNIT) 3m HORN_91200_1241 HORIZONTAL : RBW:1000.000KHz VBW:3000.000KHz SWT:Auto</p>
Avg.	<p>Site : 03CH13-HY Condition : AVG_BE(UNIT)_B3 3m HORN_91200_1241 HORIZONTAL : RBW:1000.000KHz VBW:3.000KHz SWT:Auto</p>	Left blank

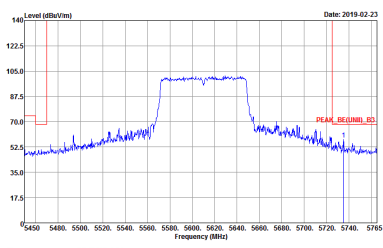

WIFI	Band 3 5470~5725MHz Band Edge @ 3m	
ANT	802.11ac VHT80 CH122 5610MHz - R	
1+2	Horizontal	Fundamental
Peak	 <p>Site : 03CH13-HY Condition : PEAK_BE(UNIT)_B3 3m HORN_91200_1241 HORIZONTAL : RBW:1000.000KHz VBW:3000.000KHz SWT:Auto</p>	Left blank



WIFI	Band 3 5470~5725MHz Band Edge @ 3m	
ANT	802.11ac VHT80 CH122 5610MHz - L	
1+2	Vertical	Fundamental
Peak	<p>Site : 03CH13-HY Condition : PEAK_BE(UNIT)_B3 3m HORN_91200_1241 VERTICAL : RBW:1000.000KHz VBW:3000.000KHz SWT:Auto</p>	<p>Site : 03CH13-HY Condition : PEAK(UNIT) 3m HORN_91200_1241 VERTICAL : RBW:1000.000KHz VBW:3000.000KHz SWT:Auto</p>
Avg.	<p>Site : 03CH13-HY Condition : AVG_BE(UNIT)_B3 3m HORN_91200_1241 VERTICAL : RBW:1000.000KHz VBW:3000.000KHz SWT:Auto</p>	Left blank



WIFI	Band 3 5470~5725MHz Band Edge @ 3m	
ANT	802.11ac VHT80 CH122 5610MHz - R	
1+2	Vertical	Fundamental
Peak	<p>Site : 03CH13-HY Condition : PEAK_BE(UNIT)_B3 3m HORN_91200_1241 VERTICAL : RBW:1000.000KHz VBW:3000.000KHz SWT:Auto</p>	Left blank



**Band 3 - 5470~5725MHz
WIFI 802.11a (Harmonic @ 3m)**

WIFI	Band 3 5470~5725MHz Harmonic @ 3m	
ANT	802.11a CH100 5500MHz	
1+2	Horizontal	Vertical
Peak Avg.	<p>Site : 03CH13-HY Condition : PEAK(LINEI) 3m HORN_9120D_1241 HORIZONTAL Detector : Peak</p>	<p>Site : 03CH13-HY Condition : PEAK(LINEI) 3m HORN_9120D_1241 VERTICAL Detector : Peak</p>

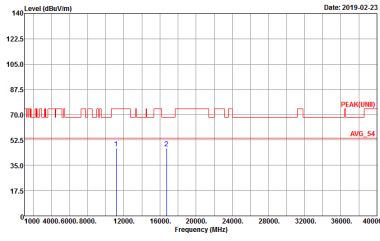
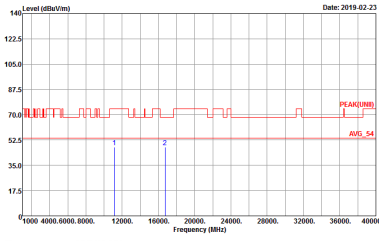

WIFI	Band 3 5470~5725MHz Harmonic @ 3m	
ANT	802.11a CH116 5580MHz	
1+2	Horizontal	Vertical
<p>Peak</p> <p>Avg.</p>	 <p>Site : 03CH13-HY Condition : PEAK(LINE1) 3m HORN_91200_1241 HORIZONTAL Detector : Peak</p>	 <p>Site : 03CH13-HY Condition : PEAK(LINE1) 3m HORN_91200_1241 VERTICAL Detector : Peak</p>



WIFI	Band 3 5470~5725MHz Harmonic @ 3m	
ANT	802.11a CH140 5700MHz	
1+2	Horizontal	Vertical
Peak Avg.	<p>Site : 03CH13-HY Condition : PEAK(UNIT) 3m HORN_9120D_1241 HORIZONTAL Detector : Peak</p>	<p>Site : 03CH13-HY Condition : PEAK(UNIT) 3m HORN_9120D_1241 VERTICAL Detector : Peak</p>



Band 3 5470~5725MHz
WIFI 802.11n HT20 (Harmonic @ 3m)

WIFI	Band 3 5470~5725MHz Harmonic @ 3m	
ANT	802.11n HT20 CH100 5500MHz	
1+2	Horizontal	Vertical
Peak Avg.	<p>Site : 03CH13-HY Condition : PEAK(LINE1) 3m HORN_91200_1241 HORIZONTAL Detector : Peak</p>	<p>Site : 03CH13-HY Condition : PEAK(LINE1) 3m HORN_91200_1241 VERTICAL Detector : Peak</p>



WIFI	Band 3 5470~5725MHz Harmonic @ 3m	
ANT	802.11n HT20 CH116 5580MHz	
1+2	Horizontal	Vertical
Peak Avg.	<p>Site : 03CH13-HY Condition : PEAK(LINEI) 3m HORN_91200_1241 HORIZONTAL Detector : Peak</p>	<p>Site : 03CH13-HY Condition : PEAK(LINEI) 3m HORN_91200_1241 VERTICAL Detector : Peak</p>



WIFI	Band 3 5470~5725MHz Harmonic @ 3m	
ANT	802.11n HT20 CH140 5700MHz	
1+2	Horizontal	Vertical
Peak Avg.	<p>Site : 03CH13-HY Condition : PEAK(LINEI) 3m HORN_9120D_1241 HORIZONTAL Detector : Peak</p>	<p>Site : 03CH13-HY Condition : PEAK(LINEI) 3m HORN_9120D_1241 VERTICAL Detector : Peak</p>



**Band 3 5470~5725MHz
WIFI 802.11n HT40 (Harmonic @ 3m)**

WIFI	Band 3 5470~5725MHz Harmonic @ 3m	
ANT	802.11n HT40 CH102 5510MHz	
1+2	Horizontal	Vertical
<p>Peak Avg.</p>	<p>Site : 03CH13-HY Condition : PEAK(LINE1) 3m HORN_91200_1241 HORIZONTAL Detector : Peak</p>	<p>Site : 03CH13-HY Condition : PEAK(LINE1) 3m HORN_91200_1241 VERTICAL Detector : Peak</p>



WIFI	Band 3 5470~5725MHz Harmonic @ 3m	
ANT	802.11n HT40 CH110 5550MHz	
1+2	Horizontal	Vertical
Peak Avg.	<p>Site : 03CH13-HY Condition : PEAK(UNII) 3m HORN_91200_1241 HORIZONTAL Detector : Peak</p>	<p>Site : 03CH13-HY Condition : PEAK(UNII) 3m HORN_91200_1241 VERTICAL Detector : Peak</p>



WIFI	Band 3 5470~5725MHz Harmonic @ 3m	
ANT	802.11n HT40 CH134 5670MHz	
1+2	Horizontal	Vertical
Peak Avg.	<p>Site : 03CH13-HY Condition : PEAK(LINE) 3m HORN_91200_1241 HORIZONTAL Detector : Peak</p>	<p>Site : 03CH13-HY Condition : PEAK(LINE) 3m HORN_91200_1241 VERTICAL Detector : Peak</p>



Band 3 5470~5725MHz
WIFI 802.11ac VHT80 (Harmonic @ 3m)

Table with 2 columns: Horizontal and Vertical. Each column contains a spectral plot of Level (dBuV/m) vs Frequency (MHz) with peak and average values indicated. Includes site and condition details for both orientations.



WIFI	Band 3 5470~5725MHz Harmonic @ 3m	
ANT	802.11ac VHT80 CH122 5610MHz	
1+2	Horizontal	Vertical
Peak Avg.	<p>Site : 03CH13-HY Condition : PEAK(LINE1) 3m HORN_91200_1241 HORIZONTAL Detector : Peak</p>	<p>Site : 03CH13-HY Condition : PEAK(LINE1) 3m HORN_91200_1241 VERTICAL Detector : Peak</p>

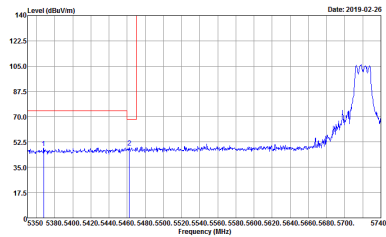
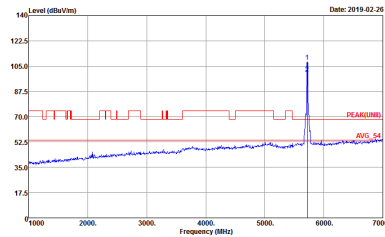
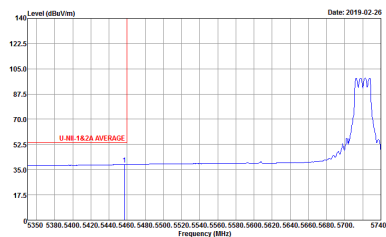

Band 3 - Straddle Channel
WIFI 802.11a (Fundamental @ 3m)

WIFI	Band 3 5470~5725MHz Band Edge @ 3m	
ANT	802.11a CH144 5720MHz - L	
1+2	Horizontal	Fundamental
<p align="center">Peak</p>	 <p>Site : 03CH13-HY Condition : STRADDLES U-NII-1A2A 3m HORN_9120D_I241 HORIZONTAL : RBW:1000.000KHz VBW:3000.000KHz SWT:Auto</p>	 <p>Site : 03CH13-HY Condition : PEAK(UNIT) 3m HORN_9120D_I241 HORIZONTAL : RBW:1000.000KHz VBW:3000.000KHz SWT:Auto</p>
<p align="center">Avg.</p>	 <p>Site : 03CH13-HY Condition : U-NII-1A2A AVERAGE 3m HORN_9120D_I241 HORIZONTAL : RBW:1000.000KHz VBW:0.010KHz SWT:Auto</p>	<p align="center">Left blank</p>

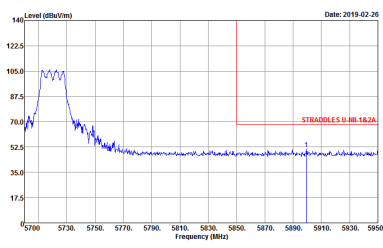

WIFI	Band 3 5470~5725MHz Band Edge @ 3m	
ANT	802.11a CH144 5720MHz - R	
1+2	Horizontal	Fundamental
Peak	 <p>Site : 03CH13-HY Condition : STRADDLES U-NII-142A 3m HORN_9120B_1241 HORIZONTAL : RBW:1000.000KHz VBW:3000.000KHz SWT:Auto</p>	Left blank



WIFI	Band 3 5470~5725MHz Band Edge @ 3m	
ANT	802.11a CH144 5720MHz - L	
1+2	Vertical	Fundamental
<p>Peak</p>	<p>Site : 03CH13-HY Condition : STRADDLES U-NII-142A 3m HORN_9120D_I241 VERTICAL : RBW:1000.000KHz VBW:3000.000KHz SWT:Auto</p>	<p>Site : 03CH13-HY Condition : PEAK(UNIT) 3m HORN_9120D_I241 VERTICAL : RBW:1000.000KHz VBW:3000.000KHz SWT:Auto</p>
<p>Avg.</p>	<p>Site : 03CH13-HY Condition : U-NII-142A AVERAGE 3m HORN_9120D_I241 VERTICAL : RBW:1000.000KHz VBW:0.010KHz SWT:Auto</p>	<p>Left blank</p>

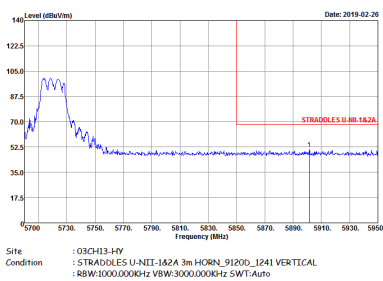

WIFI	Band 3 5470~5725MHz Band Edge @ 3m	
ANT	802.11a CH144 5720MHz - R	
1+2	Vertical	Fundamental
Peak	 <p>Site : 03CH13-HY Condition : STRADDLES U-NII-142A 3m HORN_9120B_1241 VERTICAL :RBW:1000.000KHz VBW:3000.000KHz SWT:Auto</p>	Left blank

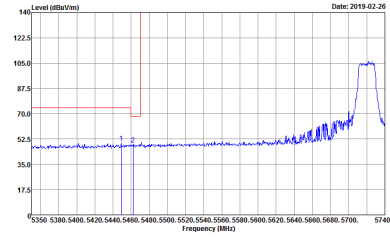
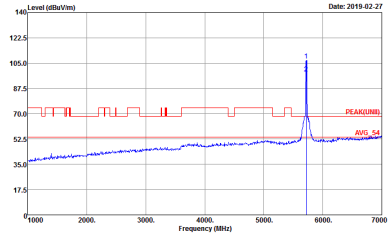
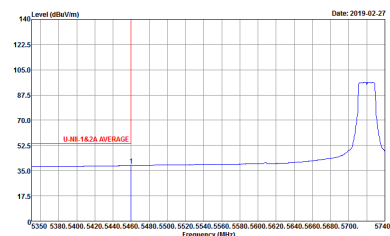

**Band 3 – Straddle Channel
WIFI 802.11n HT20 (Fundamental @ 3m)**

WIFI	Band 3 5470~5725MHz Band Edge @ 3m	
ANT	802.11n HT20 CH144 5720MHz - L	
1+2	Horizontal	Fundamental
<p align="center">Peak</p>	 <p>Site : 03CH13-HY Condition : STRADDLES U-NIT-1A2A 3m HORN_9120D_1241 HORIZONTAL : RBW:1000.000KHz VBW:3000.000KHz SWT:Auto</p>	 <p>Site : 03CH13-HY Condition : PEAKLINE1 3m HORN_9120D_1241 HORIZONTAL : RBW:1000.000KHz VBW:3000.000KHz SWT:Auto</p>
<p align="center">Avg.</p>	 <p>Site : 03CH13-HY Condition : U-NIT-1A2A AVERAGE 3m HORN_9120D_1241 HORIZONTAL : RBW:1000.000KHz VBW:0.010KHz SWT:Auto</p>	<p align="center">Left blank</p>

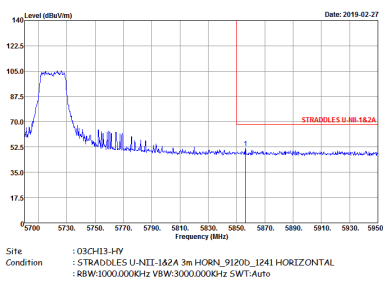

WIFI	Band 3 5470~5725MHz Band Edge @ 3m	
ANT	802.11n HT20 CH144 5720MHz - R	
1+2	Horizontal	Fundamental
Peak	 <p>Site : 03CH13-HY Condition : STRADDLES U-NII-142A 3m HORN_9120B_1241 HORIZONTAL : RBW:1000.000KHz VBW:3000.000KHz SWT:Auto</p>	Left blank

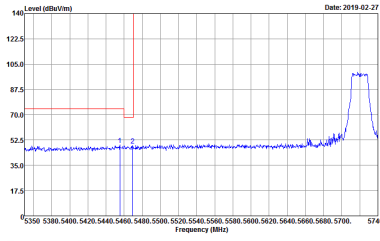
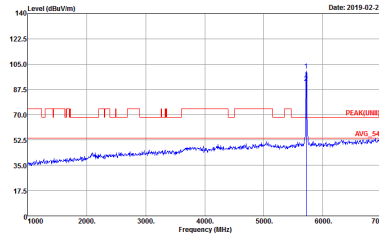
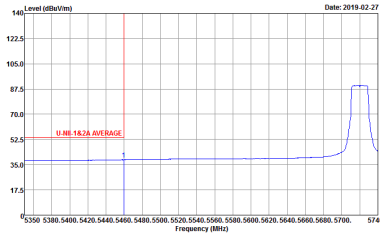

WIFI	Band 3 5470~5725MHz Band Edge @ 3m	
ANT	802.11n HT20 CH144 5720MHz - L	
1+2	Vertical	Fundamental
<p>Peak</p>	 <p>Site : 03CH13-HY Condition : STRADDLES U-NII-142A 3m HORN_9120D_I241 VERTICAL : RBW:1000.000KHz VBW:3000.000KHz SWT:Auto</p>	 <p>Site : 03CH13-HY Condition : PEAK(UNIT) 3m HORN_9120D_I241 VERTICAL : RBW:1000.000KHz VBW:3000.000KHz SWT:Auto</p>
<p>Avg.</p>	 <p>Site : 03CH13-HY Condition : U-NII-142A AVERAGE 3m HORN_9120D_I241 VERTICAL : RBW:1000.000KHz VBW:0.010KHz SWT:Auto</p>	<p>Left blank</p>

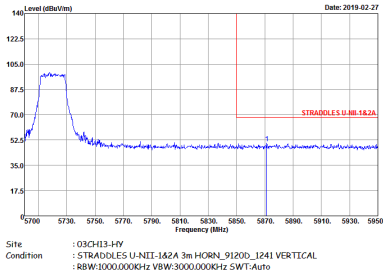

WIFI	Band 3 5470~5725MHz Band Edge @ 3m	
ANT	802.11n HT20 CH144 5720MHz - R	
1+2	Vertical	Fundamental
Peak	 <p>Site : 03CH13-HY Condition : STRADDLES U-NII-142A 3m HORN_9120B_1241 VERTICAL RBW:1000.000KHz VBW:3000.000KHz SWT:Auto</p>	Left blank

**Band 3 – Straddle Channel
WIFI 802.11n HT40 (Fundamental @ 3m)**

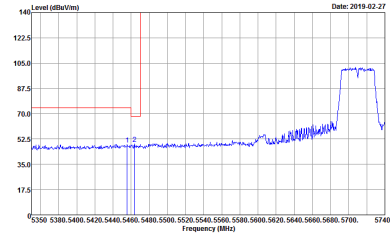
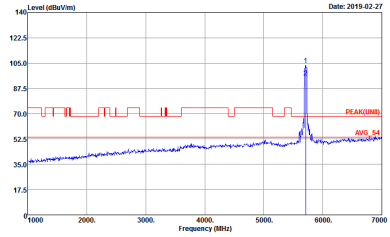
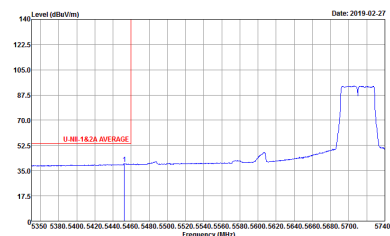
WIFI	Band 3 5470~5725MHz Band Edge @ 3m	
ANT	802.11n HT40 CH142 5710MHz - L	
1+2	Horizontal	Fundamental
<p align="center">Peak</p>	 <p>Site : 03CH13-HY Condition : STRADDLES U-NIT-1A2A 3m HORN_9120D_1241 HORIZONTAL : RBW:1000.000KHz VBW:3000.000KHz SWT:Auto</p>	 <p>Site : 03CH13-HY Condition : PEAKLINE1 3m HORN_9120D_1241 HORIZONTAL : RBW:1000.000KHz VBW:3000.000KHz SWT:Auto</p>
<p align="center">Avg.</p>	 <p>Site : 03CH13-HY Condition : U-NIT-1A2A AVERAGE 3m HORN_9120D_1241 HORIZONTAL : RBW:1000.000KHz VBW:1000KHz SWT:Auto</p>	<p align="center">Left blank</p>



WIFI	Band 3 5470~5725MHz Band Edge @ 3m	
ANT	802.11n HT40 CH142 5710MHz - R	
1+2	Horizontal	Fundamental
Peak	<p>Site : 03CH13-HY Condition : STRADDLES U-NII-142A 3m HORN_9120B_1241 HORIZONTAL : RBW:1000.000KHz VBW:3000.000KHz SWT:Auto</p>	Left blank



WIFI	Band 3 5470~5725MHz Band Edge @ 3m	
ANT	802.11n HT40 CH142 5710MHz - L	
1+2	Vertical	Fundamental
<p>Peak</p>		
<p>Avg.</p>		<p>Left blank</p>