



FCC RADIO TEST REPORT

FCC ID : PY7-48130K
Equipment : GSM/WCDMA/LTE Phone with BT, DTS/UNII
a/b/g/n/ac, GPS and NFC
Brand Name : Sony
Applicant : Sony Mobile Communications Inc.
4-12-3 Higashi-Shinagawa, Shinagawa-ku,
Tokyo, 140-0002, Japan
Manufacturer : Sony Mobile Communications Inc.
4-12-3 Higashi-Shinagawa, Shinagawa-ku,
Tokyo, 140-0002, Japan
Standard : FCC Part 15 Subpart C §15.247

The product was received on Nov. 01, 2018 and testing was started from Apr. 15, 2019 and completed on Apr. 22, 2019. We, SPORTON INTERNATIONAL INC. EMC & Wireless Communications Laboratory, would like to declare that the tested sample has been evaluated in accordance with the test procedures and has been in compliance with the applicable technical standards.

The report must not be used by the client to claim product certification, approval, or endorsement by TAF or any agency of government.

The test results in this variant report apply exclusively to the tested model / sample. Without written approval of SPORTON INTERNATIONAL INC. EMC & Wireless Communications Laboratory, the test report shall not be reproduced except in full.

Approved by: Jones Tsai

SPORTON INTERNATIONAL INC. EMC & Wireless Communications Laboratory
No. 52, Huaya 1st Rd., Guishan Dist., Taoyuan City, Taiwan (R.O.C.)



Table of Contents

History of this test report.....	3
Summary of Test Result.....	4
1 General Description	5
1.1 Product Feature of Equipment Under Test.....	5
1.2 Modification of EUT	5
1.3 Testing Location	6
1.4 Applicable Standards.....	6
2 Test Configuration of Equipment Under Test	7
2.1 Carrier Frequency and Channel	7
2.2 Test Mode.....	7
2.3 Connection Diagram of Test System.....	8
2.4 EUT Operation Test Setup	8
3 Test Result	9
3.1 Output Power Measurement.....	9
3.2 Radiated Band Edges and Spurious Emission Measurement	10
3.3 Antenna Requirements	14
4 List of Measuring Equipment.....	15
5 Uncertainty of Evaluation	17
Appendix A. Conducted Test Results	
Appendix B. Radiated Spurious Emission	
Appendix C. Radiated Spurious Emission Plots	
Appendix D. Duty Cycle Plots	



Summary of Test Result

Report Clause	Ref Std. Clause	Test Items	Result (PASS/FAIL)	Remark
-	15.247(a)(2)	6dB Bandwidth	Not Required	-
-	2.1049	99% Occupied Bandwidth	Not Required	-
3.1	15.247(b)	Power Output Measurement	Pass	-
-	15.247(e)	Power Spectral Density	Not Required	-
-	15.247(d)	Conducted Band Edges	Not Required	-
		Conducted Spurious Emission	Not Required	-
3.2	15.247(d)	Radiated Band Edges and Radiated Spurious Emission	Pass	Under limit 4.33 dB at 2483.52 MHz
-	15.207	AC Conducted Emission	Not Required	-
3.3	15.203 & 15.247(b)	Antenna Requirement	Pass	-

Remark:

1. Not required means after assessing, test items are not necessary to carry out.
2. This is a variant report. All the test cases were performed on original report which can be referred to Sporton Report Number FR802417-03C.
3. The spot-check data performed in this report are chosen from the worst case of the original FCC ID report and the spot-check data summary is included in the another spot check data report.

Declaration of Conformity:

The test results with all measurement uncertainty excluded are presented in accordance with the regulation limits or requirements declared by manufacturers.

Comments and Explanations:

The declared of product specification for EUT presented in the report are provided by the manufacturer, and the manufacturer takes all the responsibilities for the accuracy of product specification.

Reviewed by: Wii Chang

Report Producer: Natasha Hsieh



1 General Description

1.1 Product Feature of Equipment Under Test

GSM/WCDMA/LTE, Bluetooth, DTS/UNII a/b/g/n/ac, NFC, and GNSS.

Standards-related Product Specification	
Antenna Type / Gain	<Ant. 1>: Loop Antenna with gain -2.0 dBi <Ant. 2>: Inverted-F Antenna with gain -3.0 dBi

EUT Information List			
HW Version	SW Version	S/N	Performed Test Item
A	2.37	QV71006R1S	RF conducted measurement
		QV71007L1S	Radiated Spurious Emission

Accessory List	
AC Adapter	Model Name : UCH32
	S/N : 6218W30200106
Earphone	Model Name.: MH750
	S/N : N/A
USB Cable	Model Name.: UCB24
	S/N : N/A
2 in 1 USB Audio Cable	Model Name: EC270
	S/N : N/A

Note:

1. Above EUT list used are electrically identical per declared by manufacturer.
2. Above the accessories list are used to exercise the EUT during test, and the serial number of each type of accessories is listed in each section of this report.
3. For other wireless features of this EUT, test report will be issued separately.

1.2 Modification of EUT

No modifications are made to the EUT during all test items.



1.3 Testing Location

Test Site	SPORTON INTERNATIONAL INC.
Test Site Location	No.58, Aly. 75, Ln. 564, Wenhua 3rd, Rd., Guishan Dist., Taoyuan City, Taiwan (R.O.C.) TEL: +886-3-327-0868 FAX: +886-3-327-0855
Test Site No.	Sporton Site No.
	03CH13-HY

Note: The test site complies with ANSI C63.4 2014 requirement.

FCC Designation No.: TW0007

1.4 Applicable Standards

According to the specifications of the manufacturer, the EUT must comply with the requirements of the following standards:

- ♦ FCC Part 15 Subpart C §15.247
- ♦ FCC KDB Publication No. 558074 D01 DTS Meas. Guidance v05r02
- ♦ FCC KDB 414788 D01 Radiated Test Site v01r01.
- ♦ FCC KDB 662911 D01 Multiple Transmitter Output v02r01.
- ♦ ANSI C63.10-2013

Remark:

1. All test items were verified and recorded according to the standards and without any deviation during the test.
2. This EUT has also been tested and complied with the requirements of FCC Part 15, Subpart B, recorded in a separate test report.



2 Test Configuration of Equipment Under Test

- a. The EUT has been associated with peripherals and configuration operated in a manner tended to maximize its emission characteristics in a typical application. Frequency range investigated: radiation emission (9 kHz to the 10th harmonic of the highest fundamental frequency or to 40 GHz, whichever is lower). For radiated measurement, pre-scanned in three orthogonal panels, X, Y, Z. The worst cases (Y plane) were recorded in this report.

2.1 Carrier Frequency and Channel

Frequency Band	Channel	Freq. (MHz)	Channel	Freq. (MHz)
2400-2483.5 MHz	1	2412	8	2447
	2	2417	9	2452
	3	2422	10	2457
	4	2427	11	2462
	5	2432	12	2467
	6	2437	13	2472
	7	2442		

2.2 Test Mode

Final test modes are considering the modulation and worse data rates as below table.

Modulation	Data Rate
802.11b	1 Mbps
802.11g	6 Mbps

2.3 Connection Diagram of Test System

<WLAN Tx Mode>

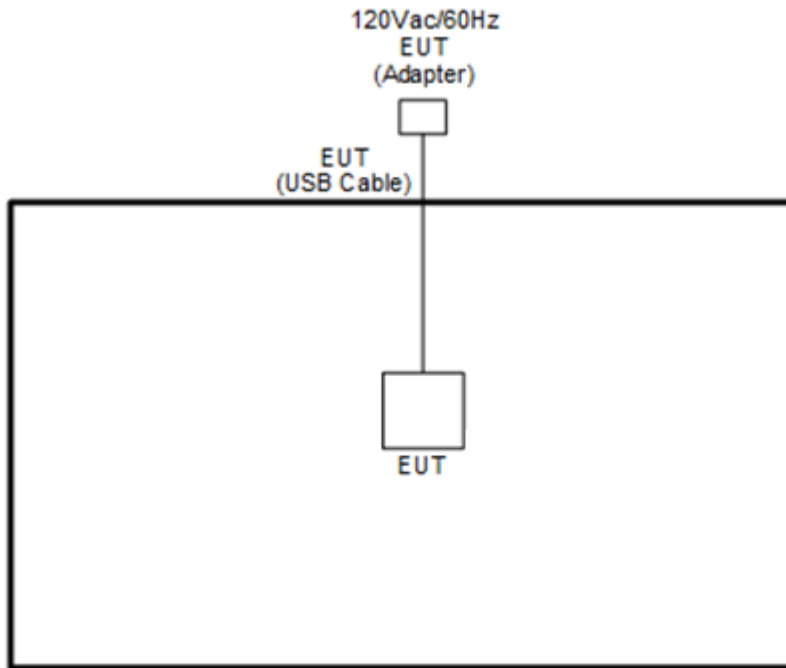

2.4 EUT Operation Test Setup

The RF test items, utility “Tera Term” was installed in Notebook which was programmed in order to make the EUT get into the engineering modes to provide channel selection, power level, data rate and the application type and for continuous transmitting signals.

3 Test Result

3.1 Output Power Measurement

3.1.1 Limit of Output Power

For systems using digital modulation in the 2400-2483.5MHz, the limit for peak output power is 30dBm. If transmitting antenna with directional gain greater than 6dBi is used, the peak output power from the intentional radiator shall be reduced below the above stated value by the amount in dB that the directional gain of the antenna exceeds 6 dBi. In case of point-to-point operation, the limit has to be reduced by 1dB for every 3dB that the directional gain of the antenna exceeds 6dBi.

3.1.2 Measuring Instruments

See list of measuring equipment of this test report.

3.1.3 Test Procedures

1. For Average Power, the testing follows ANSI C63.10 Section 11.9.2.3.2 Method AVGPM-G.
2. The RF output of EUT was connected to the power meter by RF cable and attenuator. The path loss was compensated to the results for each measurement.
3. Set to the maximum power setting and enable the EUT transmit continuously.
4. Measure the conducted output power and record the results in the test report.
5. For MIMO mode, calculation method follows FCC KDB 662911 D01 Multiple Transmitter Output v02r01.

3.1.4 Test Setup

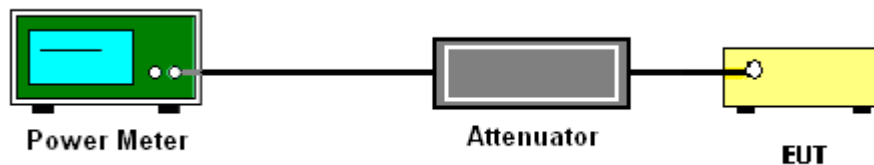

3.1.5 Test Result of Average output Power

Please refer to Appendix A.



3.2 Radiated Band Edges and Spurious Emission Measurement

3.2.1 Limit of Radiated band edge and Spurious Emission Measurement

In any 100 kHz bandwidth outside the intentional radiator frequency band, all harmonics/spurious must be at least 20 dB below the highest emission level within the authorized band. If the output power of this device was measured by spectrum analyzer, the attenuation under this paragraph shall be 30 dB instead of 20 dB. In addition, radiated emissions which fall in the restricted bands must also comply with the limits as below.

Frequency (MHz)	Field Strength (microvolts/meter)	Measurement Distance (meters)
0.009 – 0.490	2400/F(kHz)	300
0.490 – 1.705	24000/F(kHz)	30
1.705 – 30.0	30	30
30 – 88	100	3
88 – 216	150	3
216 - 960	200	3
Above 960	500	3

3.2.2 Measuring Instruments

See list of measuring equipment of this test report.



3.2.3 Test Procedures

1. The testing follows the ANSI C63.10 Section 11.12.1 Radiated emission measurements.
2. The EUT was arranged to its worst case and then tune the antenna tower (from 1 m to 4 m) and turntable (from 0 degree to 360 degrees) to find the maximum reading. A pre-amp and a high pass filter are used for the test in order to get better signal level.
3. The EUT was placed on a turntable with 0.8 meter for frequency below 1GHz and 1.5 meter for frequency above 1GHz respectively above ground.
4. The EUT was set 3 meters from the interference receiving antenna, which was mounted on the top of a variable height antenna tower.
5. Corrected Reading: Antenna Factor + Cable Loss + Read Level - Preamp Factor = Level
6. For testing below 1GHz, if the emission level of the EUT in peak mode was 3 dB lower than the limit specified, then peak values of EUT will be reported, otherwise, the emissions will be repeated one by one using the CISPR quasi-peak method and reported.
7. For testing above 1GHz, the emission level of the EUT in peak mode was 20dB lower than average limit (that means the emission level in average mode also complies with the limit in average mode), then peak values of EUT will be reported, otherwise, the emissions will be measured in average mode again and reported.
8. Use the following spectrum analyzer settings:
 - (1) Span shall wide enough to fully capture the emission being measured;
 - (2) Set RBW=100 kHz for $f < 1$ GHz; VBW \geq RBW; Sweep = auto; Detector function = peak; Trace = max hold;
 - (3) Set RBW = 1 MHz, VBW= 3MHz for $f \geq 1$ GHz for peak measurement.
For average measurement:
 - VBW = 10 Hz, when duty cycle is no less than 98 percent.
 - VBW $\geq 1/T$, when duty cycle is less than 98 percent where T is the minimum transmission duration over which the transmitter is on and is transmitting at its maximum power control level for the tested mode of operation.

3.2.4 Test Setup

For radiated emissions below 30MHz

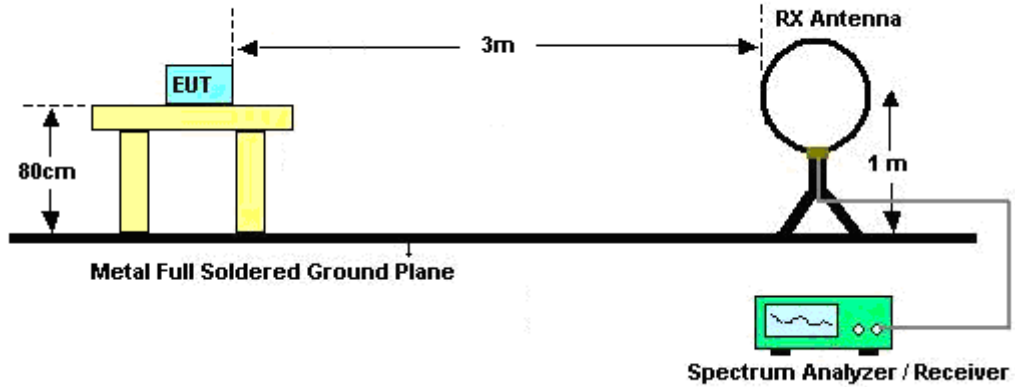

For radiated emissions from 30MHz to 1GHz

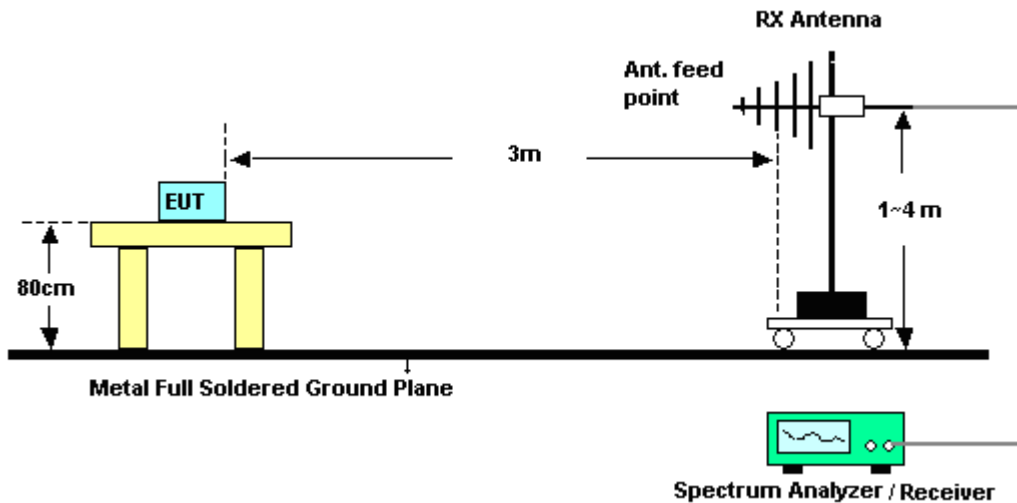

For radiated emissions above 1GHz

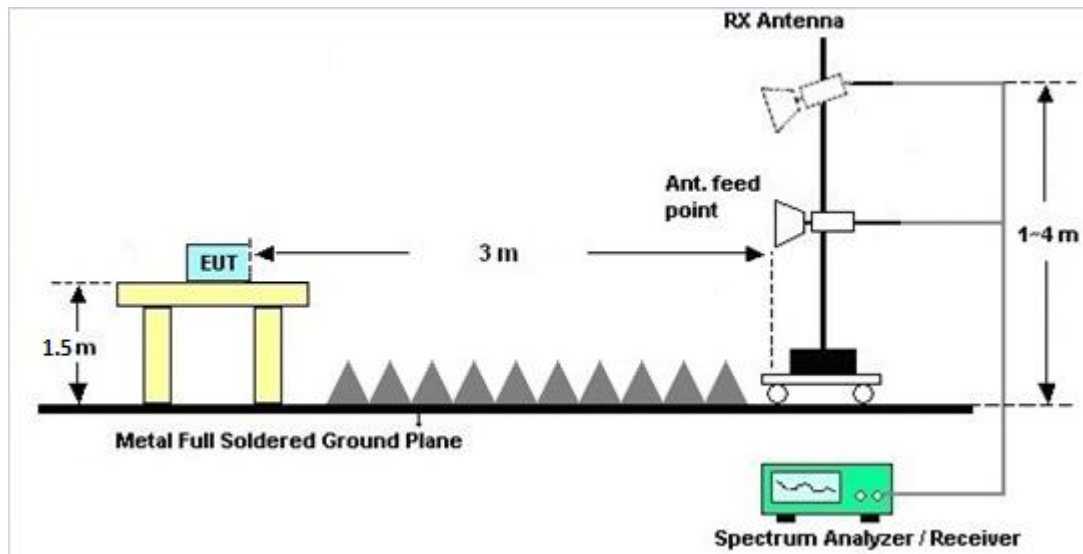

3.2.5 Test Results of Radiated Spurious Emissions (9kHz ~ 30MHz)

The low frequency, which started from 9 kHz to 30MHz, was pre-scanned and the result which was 20dB lower than the limit line was not reported.

There is a comparison data of both open-field test site and alternative test site - semi-Anechoic chamber according to 414788 D01 Radiated Test Site v01r01, and the result came out very similar.

3.2.6 Test Result of Radiated Spurious at Band Edges

Please refer to Appendix B and C.

3.2.7 Duty Cycle

Please refer to Appendix D.

3.2.8 Test Result of Radiated Spurious Emission (30MHz ~ 10th Harmonic)

Please refer to Appendix B and C.



3.3 Antenna Requirements

3.3.1 Standard Applicable

If directional gain of transmitting Antennas is greater than 6dBi, the power shall be reduced by the same level in dB comparing to gain minus 6dBi. The use of a permanently attached Antenna or of an Antenna that uses a unique coupling to the intentional radiator shall be considered sufficient to comply with the rule.

3.3.2 Antenna Anti-Replacement Construction

An embedded-in antenna design is used.

3.3.3 Antenna Gain

<CDD Modes >

FCC KDB 662911 D01 Multiple Transmitter Output v02r01

For CDD transmissions, directional gain is calculated as

Directional gain = G_{ANT} + Array Gain, where Array Gain is as follows.

For power spectral density (PSD) measurements on all devices,

Array Gain = $10 \log(N_{ANT}/N_{SS}=1)$ dB.

For power measurements on IEEE 802.11 devices,

Array Gain = 0 dB (i.e., no array gain) for $N_{ANT} \leq 4$.

Directional gain may be calculated by using the formulas applicable to equal gain antennas with G_{ANT} set equal to the gain of the antenna having the highest gain;

The EUT supports CDD mode.

For power, the directional gain G_{ANT} is set equal to the antenna having the highest gain, i.e., F)2)f)i).

For PSD, the directional gain calculation is following F)2)f)ii) of KDB 662911 D01 v02r01.

The power and PSD limit should be modified if the directional gain of EUT is over 6 dBi,

The directional gain "DG" is calculated as following table.

<CDD Modes>						
			DG	DG	Power	PSD
			for	for	Limit	Limit
	Ant. 1	Ant. 2	Power	PSD	Reduction	Reduction
	(dBi)	(dBi)	(dBi)	(dBi)	(dB)	(dB)
2.4 GHz	-2.00	-3.00	-2.00	0.52	0.00	0.00

$Power\ Limit\ Reduction = DG(Power) - 6dBi, (min = 0)$

$PSD\ Limit\ Reduction = DG(PSD) - 6dBi, (min = 0)$



4 List of Measuring Equipment

Instrument	Manufacturer	Model No.	Serial No.	Characteristics	Calibration Date	Test Date	Due Date	Remark
Hygrometer	Testo	HTC-1	4	N/A	May 12, 2018	Apr. 15, 2019	May 11, 2019	Conducted (TH05-HY)
Power Sensor	DARE	RPR3006W	15100041SN O10	10MHz~6GHz	May 07, 2018	Apr. 15, 2019	May 06, 2019	Conducted (TH05-HY)
Switch Box & RF Cable	Burgeon	ETF-058	EC1300484	N/A	Feb. 28, 2019	Apr. 15, 2019	Feb. 27, 2020	Conducted (TH05-HY)
Programmable Power Supply	GW Instek	PSS-2005	EL890094	1V~20V 0.5A~5A	Oct. 02, 2018	Apr. 15, 2019	Oct. 01, 2019	Conducted (TH05-HY)
Loop Antenna	Rohde & Schwarz	HFH2-Z2	100488	9 kHz~30 MHz	Jan. 07, 2019	Apr. 19, 2019~ Apr. 22, 2019	Jan. 06, 2020	Radiation (03CH13-HY)
Bilog Antenna	TESEQ	CBL 6111D&00800 N1D01N-06	37059&01	30MHz~1GHz	Oct. 13, 2018	Apr. 19, 2019~ Apr. 22, 2019	Oct. 12, 2019	Radiation (03CH13-HY)
Horn Antenna	SCHWARZBECK	BBHA 9120 D	9120D-1241	1GHz ~ 18GHz	Jun. 29, 2018	Apr. 19, 2019~ Apr. 22, 2019	Jun. 28, 2019	Radiation (03CH13-HY)
SHF-EHF Horn Antenna	SCHWARZBECK	BBHA 9170	BBHA917058 4	18GHz- 40GHz	Dec. 05, 2018	Apr. 19, 2019~ Apr. 22, 2019	Dec. 04, 2019	Radiation (03CH13-HY)
Preamplifier	Keysight	83017A	MY53270080	1GHz~26.5GHz	Nov. 14, 2018	Apr. 19, 2019~ Apr. 22, 2019	Nov. 13, 2020	Radiation (03CH13-HY)
Preamplifier	MITEQ	AMF-7D-0010 1800-30-10P	1590074	1GHz~18GHz	May 21, 2018	Apr. 19, 2019~ Apr. 22, 2019	May 20, 2019	Radiation (03CH13-HY)
Amplifier	Sonoma-Instrument	310 N	187282	9KHz~1GHz	Dec. 18, 2018	Apr. 19, 2019~ Apr. 22, 2019	Dec. 17, 2019	Radiation (03CH13-HY)
Amplifier	MITEQ	TTA1840-35-HG	1871923	18GHz~40GHz, VSWR : 2.5:1 max	Jul. 16, 2018	Apr. 19, 2019~ Apr. 22, 2019	Jul. 15, 2019	Radiation (03CH13-HY)
Spectrum Analyzer	Keysight	N9010A	MY55370526	10Hz~44GHz	Mar. 19, 2019	Apr. 19, 2019~ Apr. 22, 2019	Mar. 18, 2020	Radiation (03CH13-HY)
EMI Test Receiver	Keysight	N9038A(MXE)	MY54130085	20Hz ~ 8.4GHz	Nov. 01, 2018	Apr. 19, 2019~ Apr. 22, 2019	Oct. 31, 2019	Radiation (03CH13-HY)
Hygrometer	TECPEL	DTM-303B	TP157151	N/A	May 19, 2018	Apr. 19, 2019~ Apr. 22, 2019	May 18, 2019	Radiation (03CH13-HY)
Filter	Wainwright	WHKX12-1080 -1200-15000-6 OST	SN3	1.2G Low Pass	Jul. 05, 2018	Apr. 19, 2019~ Apr. 22, 2019	Jul. 04, 2019	Radiation (03CH13-HY)
Filter	Wainwright	WHKX12-2700 -3000-18000-6 OSS	SN2	3G High Pass	Jul. 16, 2018	Apr. 19, 2019~ Apr. 22, 2019	Jul. 15, 2019	Radiation (03CH13-HY)
RF Cable	HUBER + SUHNER	SUCOFLEX 126E	0030/126E	30M-18G	Feb. 13, 2019	Apr. 19, 2019~ Apr. 22, 2019	Feb. 12, 2020	Radiation (03CH13-HY)
RF Cable	HUBER + SUHNER	SUCOFLEX 104	804793/4	30M-18G	Feb. 13, 2019	Apr. 19, 2019~ Apr. 22, 2019	Feb. 12, 2020	Radiation (03CH13-HY)
RF Cable	HUBER + SUHNER	SUCOFLEX 104	MY24961/4	30M-18G	Feb. 13, 2019	Apr. 19, 2019~ Apr. 22, 2019	Feb. 12, 2020	Radiation (03CH13-HY)
RF Cable	HUBER + SUHNER	SUCOFLEX 102	MY2859/2	30M~40GHz	Mar. 13, 2019	Apr. 19, 2019~ Apr. 22, 2019	Mar. 12, 2020	Radiation (03CH13-HY)
RF Cable	HUBER + SUHNER	SUCOFLEX 102	MY4274/2	30M~40GHz	Mar. 13, 2019	Apr. 19, 2019~ Apr. 22, 2019	Mar. 12, 2020	Radiation (03CH13-HY)



Instrument	Manufacturer	Model No.	Serial No.	Characteristics	Calibration Date	Test Date	Due Date	Remark
Controller	EMEC	EM1000	N/A	Control Turn table & Ant Mast	N/A	Apr. 19, 2019~ Apr. 22, 2019	N/A	Radiation (03CH13-HY)
Antenna Mast	EMEC	AM-BS-4500-B	N/A	1m~4m	N/A	Apr. 19, 2019~ Apr. 22, 2019	N/A	Radiation (03CH13-HY)
Turn Table	EMEC	TT2000	N/A	0~360 Degree	N/A	Apr. 19, 2019~ Apr. 22, 2019	N/A	Radiation (03CH13-HY)
Software	AUDIX	E3 6.2009-8-24c	RK-001124	N/A	N/A	Apr. 19, 2019~ Apr. 22, 2019	N/A	Radiation (03CH13-HY)



5 Uncertainty of Evaluation

Uncertainty of Radiated Emission Measurement (30 MHz ~ 1000 MHz)

Measuring Uncertainty for a Level of Confidence of 95% ($U = 2Uc(y)$)	4.90
---	------

Uncertainty of Radiated Emission Measurement (1000 MHz ~ 18000 MHz)

Measuring Uncertainty for a Level of Confidence of 95% ($U = 2Uc(y)$)	5.40
---	------

Uncertainty of Radiated Emission Measurement (18000 MHz ~ 40000 MHz)

Measuring Uncertainty for a Level of Confidence of 95% ($U = 2Uc(y)$)	4.30
---	------

Appendix A. Test Result of Conducted Test Items

Test Engineer:	Richard Qiu	Temperature:	21~25	°C
Test Date:	2019/4/15	Relative Humidity:	51~54	%

TEST RESULTS DATA
Average Output Power

2.4GHz Band																
Mod.	Data Rate	NTx	CH.	Freq. (MHz)	Average Conducted Power (dBm)			Conducted Power Limit (dBm)		DG (dBi)		EIRP Power (dBm)		EIRP Power Limit (dBm)		Pass /Fail
					Ant 1	Ant 2	SUM	Ant 1	Ant 2	Ant 1	Ant 2	Ant 1	Ant 2	Ant 1	Ant 2	
11b	1Mbps	1	1	2412	14.10	13.60		30.00	30.00	-2.00	-3.00	12.10	10.60	36.00	36.00	Pass
11b	1Mbps	1	6	2437	14.10	13.70		30.00	30.00	-2.00	-3.00	12.10	10.70	36.00	36.00	Pass
11b	1Mbps	1	11	2462	14.00	13.50		30.00	30.00	-2.00	-3.00	12.00	10.50	36.00	36.00	Pass
11b	1Mbps	1	12	2467	14.00	13.70		30.00	30.00	-2.00	-3.00	12.00	10.70	36.00	36.00	Pass
11b	1Mbps	1	13	2472	11.20	10.10		30.00	30.00	-2.00	-3.00	9.20	7.10	36.00	36.00	Pass
11g	6Mbps	1	1	2412	10.10	8.40		30.00	30.00	-2.00	-3.00	8.10	5.40	36.00	36.00	Pass
11g	6Mbps	1	6	2437	14.70	14.40		30.00	30.00	-2.00	-3.00	12.70	11.40	36.00	36.00	Pass
11g	6Mbps	1	11	2462	14.20	14.20	-	30.00	30.00	-2.00	-3.00	12.20	11.20	36.00	36.00	Pass
11g	6Mbps	1	12	2467	11.70	8.70		30.00	30.00	-2.00	-3.00	9.70	5.70	36.00	36.00	Pass
11g	6Mbps	1	13	2472	4.30	4.20		30.00	30.00	-2.00	-3.00	2.30	1.20	36.00	36.00	Pass
HT20	MCS0	1	1	2412	3.50	2.40		30.00	30.00	-2.00	-3.00	1.50	-0.60	36.00	36.00	Pass
HT20	MCS0	1	6	2437	14.70	14.30		30.00	30.00	-2.00	-3.00	12.70	11.30	36.00	36.00	Pass
HT20	MCS0	1	11	2462	13.70	13.70		30.00	30.00	-2.00	-3.00	11.70	10.70	36.00	36.00	Pass
HT20	MCS0	1	12	2467	9.10	10.50		30.00	30.00	-2.00	-3.00	7.10	7.50	36.00	36.00	Pass
HT20	MCS0	1	13	2472	1.80	1.00		30.00	30.00	-2.00	-3.00	-0.20	-2.00	36.00	36.00	Pass
11b	1Mbps	2	1	2412	14.20	13.70	16.97	30.00		-2.00		14.97		36.00		Pass
11b	1Mbps	2	6	2437	14.30	13.70	17.02	30.00		-2.00		15.02		36.00		Pass
11b	1Mbps	2	11	2462	14.10	13.60	16.87	30.00		-2.00		14.87		36.00		Pass
11b	1Mbps	2	12	2467	14.00	13.50	16.77	30.00		-2.00		14.77		36.00		Pass
11b	1Mbps	2	13	2472	12.30	10.30	14.42	30.00		-2.00		12.42		36.00		Pass
11g	6Mbps	2	1	2412	10.20	8.70	12.52	30.00		-2.00		10.52		36.00		Pass
11g	6Mbps	2	6	2437	14.80	14.10	17.47	30.00		-2.00		15.47		36.00		Pass
11g	6Mbps	2	11	2462	14.60	14.10	17.37	30.00		-2.00		15.37		36.00		Pass
11g	6Mbps	2	12	2467	11.50	9.00	13.44	30.00		-2.00		11.44		36.00		Pass
11g	6Mbps	2	13	2472	4.40	3.90	7.17	30.00		-2.00		5.17		36.00		Pass
HT20	MCS0	2	1	2412	4.00	2.20	6.20	30.00		-2.00		4.20		36.00		Pass
HT20	MCS0	2	6	2437	14.60	14.00	17.32	30.00		-2.00		15.32		36.00		Pass
HT20	MCS0	2	11	2462	13.90	13.50	16.71	30.00		-2.00		14.71		36.00		Pass
HT20	MCS0	2	12	2467	8.90	10.30	12.67	30.00		-2.00		10.67		36.00		Pass
HT20	MCS0	2	13	2472	1.60	1.30	4.46	30.00		-2.00		2.46		36.00		Pass

Note: Measured power (dBm) has offset with cable loss.



Appendix B. Radiated Spurious Emission

Test Engineer :	Alex Jheng, JC Liang, Wiolson Wu	Temperature :	24.5~24.6°C
		Relative Humidity :	50~51%

2.4GHz 2400~2483.5MHz

WIFI 802.11b (Band Edge @ 3m)

WIFI	Note	Frequency	Level	Over	Limit	Read	Antenna	Path	Preamp	Ant	Table	Peak	Pol.
Ant. 1+2		(MHz)	(dBμV/m)	(dB)	Line (dBμV/m)	Level (dBμV)	Factor (dB/m)	Loss (dB)	Factor (dB)	Pos (cm)	Pos (deg)	Avg. (P/A)	(H/V)
802.11b CH 13 2472MHz	*	2472	92.05	-	-	80.17	27.46	13.99	29.57	251	271	P	H
	*	2472	88.75	-	-	76.87	27.46	13.99	29.57	251	271	A	H
		2483.72	52.84	-21.16	74	40.95	27.46	14	29.57	251	271	P	H
		2483.52	43.07	-10.93	54	31.18	27.46	14	29.57	251	271	A	H
													H
													H
	*	2472	100.74	-	-	88.86	27.46	13.99	29.57	301	24	P	V
	*	2472	97.93	-	-	86.05	27.46	13.99	29.57	301	24	A	V
		2489.48	52.57	-21.43	74	40.63	27.5	14.01	29.57	301	24	P	V
		2483.52	42.07	-11.93	54	30.18	27.46	14	29.57	301	24	A	V
													V
													V
Remark	1. No other spurious found. 2. All results are PASS against Peak and Average limit line.												



2.4GHz 2400~2483.5MHz
WIFI 802.11b (Harmonic @ 3m)

WIFI	Note	Frequency	Level	Over	Limit	Read	Antenna	Path	Preamp	Ant	Table	Peak	Pol.	
Ant.				Limit	Line	Level	Factor	Loss	Factor	Pos	Pos	Avg.		
1+2		(MHz)	(dBμV/m)	(dB)	(dBμV/m)	(dBμV)	(dB/m)	(dB)	(dB)	(cm)	(deg)	(P/A)	(H/V)	
802.11b CH 13 2472MHz		4944	38.11	-35.89	74	57.16	31.5	6.76	57.31	100	0	P	H	
		7416	44.03	-29.97	74	56.86	36.41	8.16	57.4	100	0	P	H	
													H	
													H	
		4944	38.09	-35.91	74	57.14	31.5	6.76	57.31	100	0	P	V	
		7416	43.74	-30.26	74	56.57	36.41	8.16	57.4	100	0	P	V	
														V
														V
Remark	1. No other spurious found. 2. All results are PASS against Peak and Average limit line.													



**2.4GHz 2400~2483.5MHz
WIFI 802.11g (Band Edge @ 3m)**

WIFI	Note	Frequency	Level	Over	Limit	Read	Antenna	Path	Preamp	Ant	Table	Peak	Pol.
Ant.				Limit	Line	Level	Factor	Loss	Factor	Pos	Pos	Avg.	
1+2		(MHz)	(dBμV/m)	(dB)	(dBμV/m)	(dBμV)	(dB/m)	(dB)	(dB)	(cm)	(deg)	(P/A)	(H/V)
802.11g CH 11 2462MHz	*	2467	100.47	-	-	88.64	27.41	13.99	29.57	284	280	P	H
	*	2467	92.5	-	-	80.67	27.41	13.99	29.57	284	280	A	H
		2484.8	57.94	-16.06	74	46.05	27.46	14	29.57	284	280	P	H
		2484.92	43.03	-10.97	54	31.14	27.46	14	29.57	284	280	A	H
													H
													H
	*	2467	108.12	-	-	96.29	27.41	13.99	29.57	309	15	P	V
	*	2467	100.29	-	-	88.46	27.41	13.99	29.57	309	15	A	V
		2483.64	68.12	-5.88	74	56.23	27.46	14	29.57	309	15	P	V
		2483.52	49.67	-4.33	54	37.78	27.46	14	29.57	309	15	A	V
													V
													V
Remark	1. No other spurious found. 2. All results are PASS against Peak and Average limit line.												



**2.4GHz 2400~2483.5MHz
WIFI 802.11g (Harmonic @ 3m)**

WIFI	Note	Frequency	Level	Over	Limit	Read	Antenna	Path	Preamp	Ant	Table	Peak	Pol.	
Ant.				Limit	Line	Level	Factor	Loss	Factor	Pos	Pos	Avg.		
1+2		(MHz)	(dBμV/m)	(dB)	(dBμV/m)	(dBμV)	(dB/m)	(dB)	(dB)	(cm)	(deg)	(P/A)	(H/V)	
802.11g CH 11 2462MHz		4924	39	-35	74	58.19	31.46	6.7	57.35	100	0	P	H	
		7386	43.49	-30.51	74	56.34	36.37	8.14	57.36	100	0	P	H	
													H	
													H	
		4924	38.4	-35.6	74	57.59	31.46	6.7	57.35	100	0	P	V	
		7386	44.1	-29.9	74	56.95	36.37	8.14	57.36	100	0	P	V	
														V
														V
Remark	1. No other spurious found. 2. All results are PASS against Peak and Average limit line.													



Emission below 1GHz
2.4GHz WIFI 802.11g (LF)

WIFI	Note	Frequency	Level	Over	Limit	Read	Antenna	Path	Preamp	Ant	Table	Peak	Pol.	
Ant.				Limit	Line	Level	Factor	Loss	Factor	Pos	Pos	Avg.		
1+2		(MHz)	(dBμV/m)	(dB)	(dBμV/m)	(dBμV)	(dB/m)	(dB)	(dB)	(cm)	(deg)	(P/A)	(H/V)	
2.4GHz 802.11g LF		31.94	23.05	-16.95	40	31.56	23.32	0.46	32.29			P	H	
		91.11	25.6	-17.9	43.5	42.1	14.96	0.76	32.22			P	H	
		155.13	25.56	-17.94	43.5	39.72	16.94	1.07	32.17			P	H	
		180.35	26.58	-16.92	43.5	42.55	15.01	1.17	32.15			P	H	
		854.5	32.79	-13.21	46	32.63	29.17	2.62	31.63			P	H	
		944.71	33.77	-12.23	46	31.79	30.35	2.66	31.03	100	0	P	H	
													H	
													H	
													H	
													H	
													H	
													H	
													H	
			38.73	33.34	-6.66	40	45.23	19.9	0.5	32.29	100	0	P	V
			112.45	30.92	-12.58	43.5	45.29	16.92	0.91	32.2			P	V
			147.37	24.6	-18.9	43.5	38.49	17.25	1.04	32.18			P	V
			179.38	25.54	-17.96	43.5	41.46	15.06	1.17	32.15			P	V
			427.7	27.68	-18.32	46	35.37	22.7	1.77	32.16			P	V
			952.47	33.82	-12.18	46	31.51	30.61	2.66	30.96			P	V
													V	
												V		
												V		
												V		
												V		
												V		
Remark	1. No other spurious found. 2. All results are PASS against limit line.													



Note symbol

*	Fundamental Frequency which can be ignored. However, the level of any unwanted emissions shall not exceed the level of the fundamental frequency.
!	Test result is over limit line.
P/A	Peak or Average
H/V	Horizontal or Vertical



A calculation example for radiated spurious emission is shown as below:

WIFI Ant. 1+2	Note	Frequency (MHz)	Level (dBμV/m)	Over Limit (dB)	Limit Line (dBμV/m)	Read Level (dBμV)	Antenna Factor (dB/m)	Path Loss (dB)	Preamp Factor (dB)	Ant Pos (cm)	Table Pos (deg)	Peak Avg. (P/A)	Pol. (H/V)
802.11b CH 01		2390	55.45	-18.55	74	54.51	32.22	4.58	35.86	103	308	P	H
2412MHz		2390	43.54	-10.46	54	42.6	32.22	4.58	35.86	103	308	A	H

1. Path Loss(dB) = Cable loss(dB) + Filter loss(dB) + Attenuator loss(dB)
2. Level(dBμV/m) =
Antenna Factor(dB/m) + Path Loss(dB) + Read Level(dBμV) - Preamp Factor(dB)
3. Over Limit(dB) = Level(dBμV/m) – Limit Line(dBμV/m)

For Peak Limit @ 2390MHz:

1. Level(dBμV/m)
= Antenna Factor(dB/m) + Path Loss(dB) + Read Level(dBμV) - Preamp Factor(dB)
= 32.22(dB/m) + 4.58(dB) + 54.51(dBμV) – 35.86 (dB)
= 55.45 (dBμV/m)
2. Over Limit(dB)
= Level(dBμV/m) – Limit Line(dBμV/m)
= 55.45(dBμV/m) – 74(dBμV/m)
= -18.55(dB)

For Average Limit @ 2390MHz:

1. Level(dBμV/m)
= Antenna Factor(dB/m) + Path Loss(dB) + Read Level(dBμV) - Preamp Factor(dB)
= 32.22(dB/m) + 4.58(dB) + 42.6(dBμV) – 35.86 (dB)
= 43.54 (dBμV/m)
2. Over Limit(dB)
= Level(dBμV/m) – Limit Line(dBμV/m)
= 43.54(dBμV/m) – 54(dBμV/m)
= -10.46(dB)

Both peak and average measured complies with the limit line, so test result is “PASS”.



Appendix C. Radiated Spurious Emission Plots

Test Engineer :	Alex Jheng, JC Liang, Wilson Wu	Temperature :	24.5~24.6°C
		Relative Humidity :	50~51%

Note symbol

-L	Low channel location
-R	High channel location

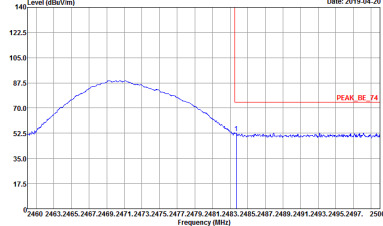
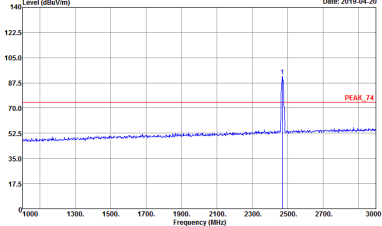
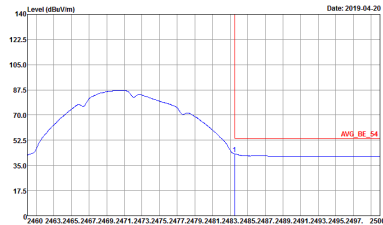
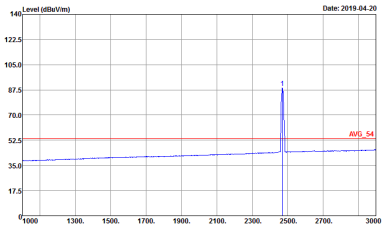

2.4GHz 2400~2483.5MHz
WIFI 802.11b (Band Edge @ 3m)

WIFI	2.4GHz 2400~2483.5MHz Band Edge @ 3m	
ANT	802.11b CH13 2472MHz	
1+2	Horizontal	Fundamental
Peak	 <p>Site : 03CH13-HY Condition : PEAK_BE_74 3m HORN_91200_1241 HORIZONTAL Detector : Peak Project : 802421-03 Mode : 5 Power : 0x14</p>	 <p>Site : 03CH13-HY Condition : PEAK_74 3m HORN_91200_1241 HORIZONTAL Detector : Peak Project : 802421-03 Mode : 5 Power : 0x14</p>
Avg.	 <p>Site : 03CH13-HY Condition : AVG_BE_54 3m HORN_91200_1241 HORIZONTAL Detector : Peak Project : 802421-03 Mode : 5 Power : 0x14</p>	 <p>Site : 03CH13-HY Condition : AVG_54 3m HORN_91200_1241 HORIZONTAL Detector : Peak Project : 802421-03 Mode : 5 Power : 0x14</p>



WIFI	2.4GHz 2400~2483.5MHz Band Edge @ 3m	
ANT	802.11b CH13 2472MHz	
1+2	Vertical	Fundamental
<p>Peak</p>	<p>Site : 03CH13-HY Condition : PEAK_BE_74 3m HORN_91200_1241 VERTICAL RBW:1000.000KHz VBW:3000.000KHz SWT:Auto Detector : Peak Project : 802421-03 Mode : 5 Power : 0x14</p>	<p>Site : 03CH13-HY Condition : PEAK_74 3m HORN_91200_1241 VERTICAL RBW:1000.000KHz VBW:3000.000KHz SWT:Auto Detector : Peak Project : 802421-03 Mode : 5 Power : 0x14</p>
<p>Avg.</p>	<p>Site : 03CH13-HY Condition : AVG_BE_54 3m HORN_91200_1241 VERTICAL RBW:1000.000KHz VBW:0.010KHz SWT:Auto Detector : Peak Project : 802421-03 Mode : 5 Power : 0x14</p>	<p>Site : 03CH13-HY Condition : AVG_54 3m HORN_91200_1241 VERTICAL RBW:1000.000KHz VBW:0.010KHz SWT:Auto Detector : Peak Project : 802421-03 Mode : 5 Power : 0x14</p>

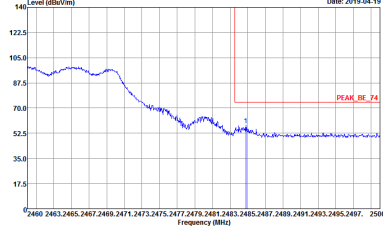
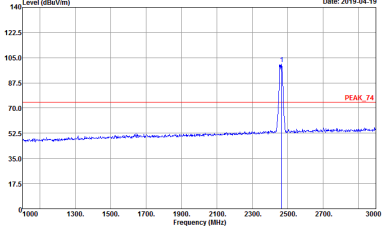
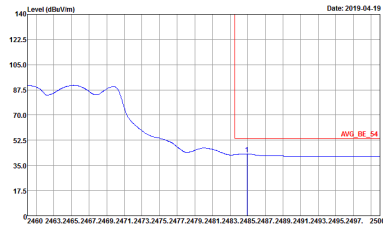
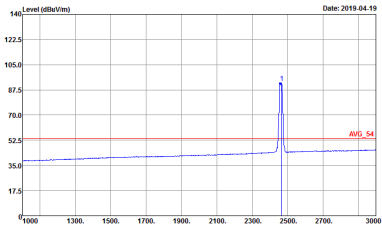

2.4GHz 2400~2483.5MHz
WIFI 802.11g (Band Edge @ 3m)

WIFI	2.4GHz 2400~2483.5MHz Band Edge @ 3m	
ANT	802.11g CH11 2462MHz	
1+2	Horizontal	Fundamental
Peak	 <p>Site : 03CH13-HY Condition : PEAK_BE_74 3m HORN_91200_1241 HORIZONTAL Detector : Peak Project : 802421-03 Mode : 6 Power : 0x1E</p>	 <p>Site : 03CH13-HY Condition : PEAK_74 3m HORN_91200_1241 HORIZONTAL Detector : Peak Project : 802421-03 Mode : 6 Power : 0x1E</p>
Avg.	 <p>Site : 03CH13-HY Condition : AVG_BE_54 3m HORN_91200_1241 HORIZONTAL Detector : Peak Project : 802421-03 Mode : 6 Power : 0x1E</p>	 <p>Site : 03CH13-HY Condition : AVG_54 3m HORN_91200_1241 HORIZONTAL Detector : Peak Project : 802421-03 Mode : 6 Power : 0x1E</p>

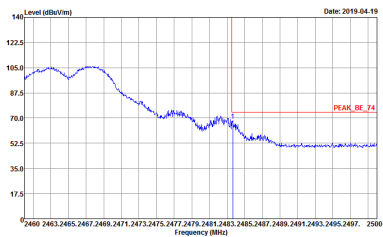
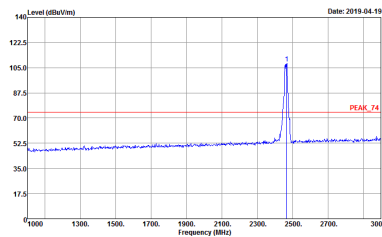
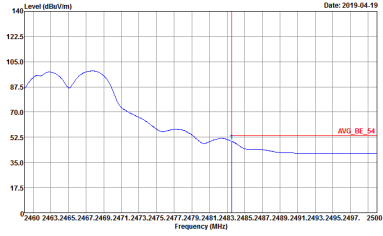
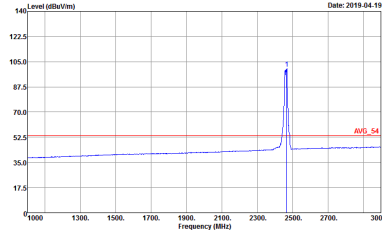

WIFI	2.4GHz 2400~2483.5MHz Band Edge @ 3m	
ANT	802.11g CH11 2462MHz	
1+2	Vertical	Fundamental
<p>Peak</p>	 <p>Site : 03CH13-HY Condition : PEAK_BE_74 3m HORN_91200_1241 VERTICAL Detector : Peak Project : 802421-03 Mode : 6 Power : 0x1E</p>	 <p>Site : 03CH13-HY Condition : PEAK_74 3m HORN_91200_1241 VERTICAL Detector : Peak Project : 802421-03 Mode : 6 Power : 0x1E</p>
<p>Avg.</p>	 <p>Site : 03CH13-HY Condition : AVG_BE_54 3m HORN_91200_1241 VERTICAL Detector : Peak Project : 802421-03 Mode : 6 Power : 0x1E</p>	 <p>Site : 03CH13-HY Condition : AVG_54 3m HORN_91200_1241 VERTICAL Detector : Peak Project : 802421-03 Mode : 6 Power : 0x1E</p>



2.4GHz 2400~2483.5MHz

WIFI 802.11b (Harmonic @ 3m)

WIFI	2.4GHz 2400~2483.5MHz Harmonic @ 3m	
ANT	802.11b CH13 2472MHz	
1+2	Horizontal	Vertical
<p>Peak</p> <p>Avg.</p>	<p>Site : 03CH13-HV Condition : PEAK_74 3m HORN_91200_1241 HORIZONTAL Detector : Peak Project : 802421-03 Mode : S Power : 0x14</p>	<p>Site : 03CH13-HV Condition : PEAK_74 3m HORN_91200_1241 VERTICAL Detector : Peak Project : 802421-03 Mode : S Power : 0x14</p>



2.4GHz 2400~2483.5MHz

WIFI 802.11g (Harmonic @ 3m)

WIFI	2.4GHz 2400~2483.5MHz Harmonic @ 3m	
ANT	802.11g CH11 2462MHz	
1+2	Horizontal	Vertical
Peak Avg.		



Emission below 1GHz
2.4GHz WIFI 802.11g (LF)

Table with 4 columns: WIFI (2.4GHz 2400~2483.5MHz), ANT (802.11g LF), 1+2 (Horizontal/Vertical), and QP/ Peak. It contains two spectral plots: Horizontal and Vertical, showing Level (dBuV/m) vs Frequency (MHz) with associated test parameters.



Appendix D. Duty Cycle Plots

Antenna	Band	Duty Cycle(%)	T(us)	1/T(kHz)	VBW Setting	Duty Factor(dB)
1+2	802.11b for Ant. 1	100	-	-	10Hz	0.00
1+2	802.11b for Ant. 2	100	-	-	10Hz	0.00
1+2	2.4GHz 802.11g for Ant. 1	98.35	-	-	10Hz	0.07
1+2	2.4GHz 802.11g for Ant. 2	98.35	-	-	10Hz	0.07



MIMO <Ant. 1>

802.11b

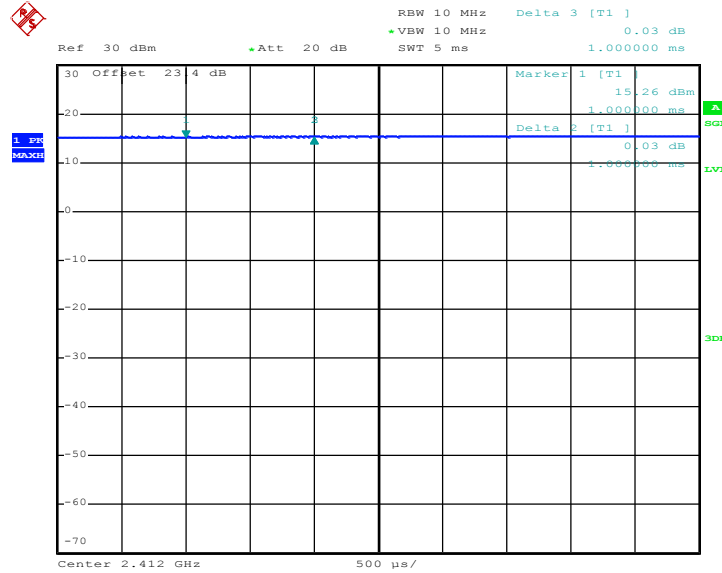

Date: 15.APR.2019 12:53:56

802.11g

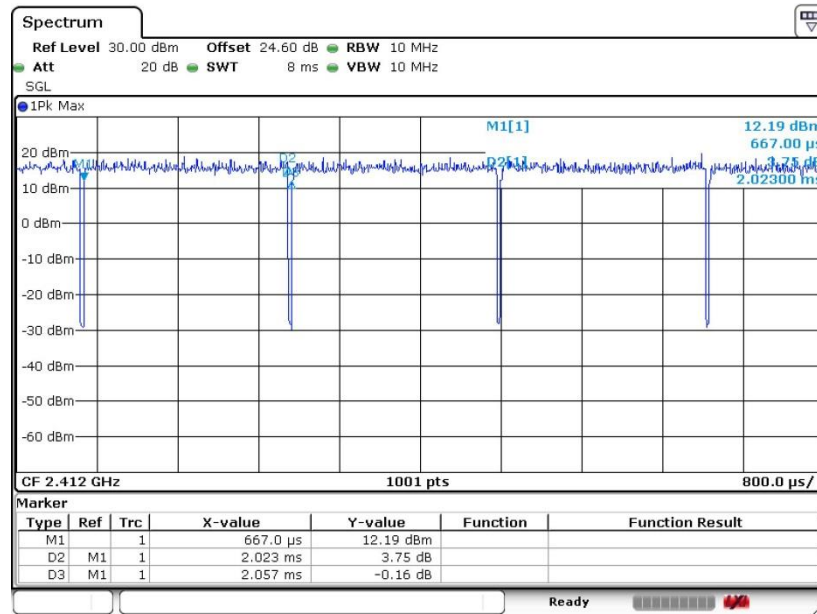

Date: 6.FEB.2019 18:59:59



MIMO <Ant. 2>

802.11b

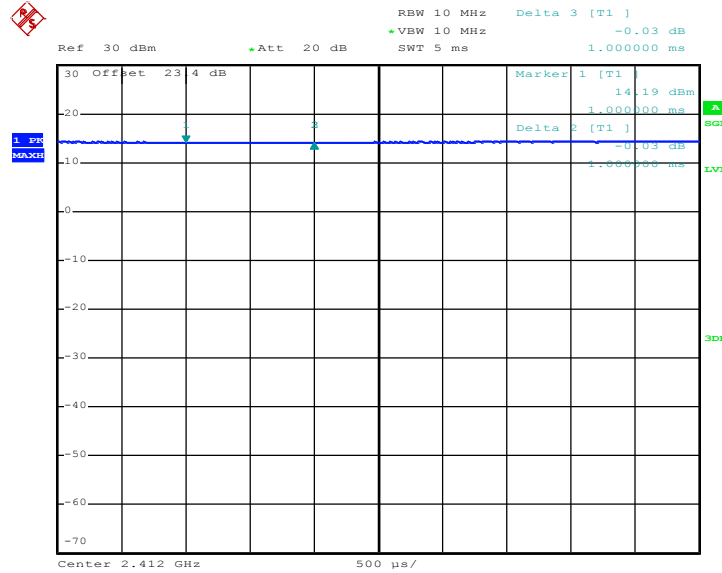

Date: 15.APR.2019 12:54:25

802.11g

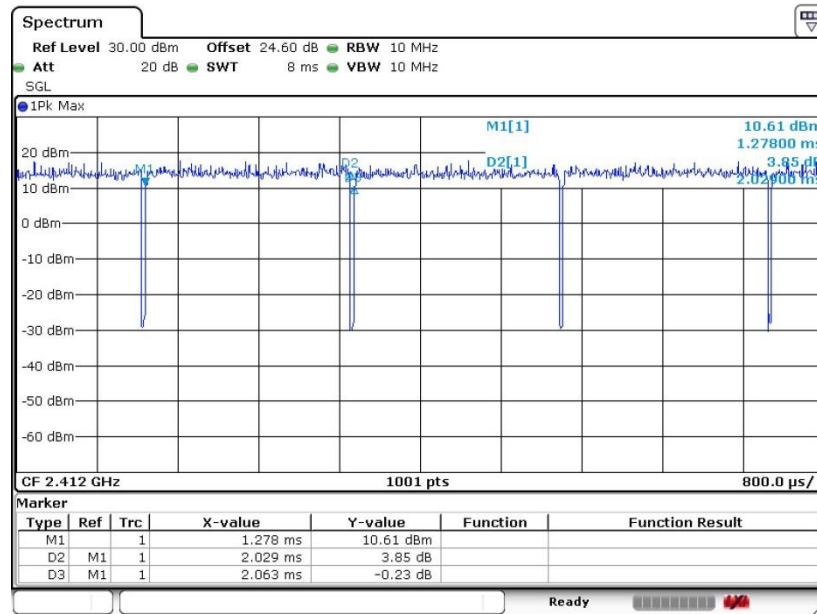

Date: 6.FEB.2019 19:02:20

—THE END—