



# FCC RADIO TEST REPORT

**FCC ID** : PY7-48130K  
**Equipment** : GSM/WCDMA/LTE Phone with BT, DTS/UNII a/b/g/n/ac, GPS and NFC  
**Brand Name** : Sony  
**Applicant** : Sony Mobile Communications Inc.  
4-12-3 Higashi-Shinagawa, Shinagawa-ku,  
Tokyo, 140-0002, Japan  
**Manufacturer** : Sony Mobile Communications Inc.  
4-12-3 Higashi-Shinagawa, Shinagawa-ku,  
Tokyo, 140-0002, Japan  
**Standard** : FCC Part 15 Subpart C §15.247

The product was received on Nov. 01, 2018 and testing was started from Apr. 16, 2019 and completed on Apr. 26, 2019. We, SPORTON INTERNATIONAL INC. EMC & Wireless Communications Laboratory, would like to declare that the tested sample has been evaluated in accordance with the test procedures and has been in compliance with the applicable technical standards.

The report must not be used by the client to claim product certification, approval, or endorsement by TAF or any agency of government.

The test results in this variant report apply exclusively to the tested model / sample. Without written approval of SPORTON INTERNATIONAL INC. EMC & Wireless Communications Laboratory, the test report shall not be reproduced except in full.

Approved by: Jones Tsai

**SPORTON INTERNATIONAL INC. EMC & Wireless Communications Laboratory**  
No. 52, Huaya 1st Rd., Guishan Dist., Taoyuan City, Taiwan (R.O.C.)



## Table of Contents

History of this test report.....	3
Summary of Test Result.....	4
<b>1 General Description.....</b>	<b>5</b>
1.1 Product Feature of Equipment Under Test.....	5
1.2 Modification of EUT .....	5
1.3 Testing Location .....	6
1.4 Applicable Standards.....	6
<b>2 Test Configuration of Equipment Under Test .....</b>	<b>7</b>
2.1 Carrier Frequency Channel .....	7
2.2 Test Mode.....	8
2.3 Connection Diagram of Test System.....	9
2.4 EUT Operation Test Setup .....	9
<b>3 Test Result.....</b>	<b>10</b>
3.1 Output Power Measurement.....	10
3.2 Radiated Band Edges and Spurious Emission Measurement .....	11
3.3 Antenna Requirements .....	15
<b>4 List of Measuring Equipment .....</b>	<b>16</b>
<b>5 Uncertainty of Evaluation.....</b>	<b>18</b>
<b>Appendix A. AC Conducted Emission Test Result</b>	
<b>Appendix B. Radiated Spurious Emission</b>	
<b>Appendix C. Radiated Spurious Emission Plots</b>	
<b>Appendix D. Duty Cycle Plots</b>	



### History of this test report

Report No.	Version	Description	Issued Date
FR8O2421-03B	01	Initial issue of report	Apr. 30, 2019
FR8O2421-03B	02	Add the description of accessing spot check test plan in Summary of Test Result	May 15, 2019



### Summary of Test Result

Report Clause	Ref Std. Clause	Test Items	Result (PASS/FAIL)	Remark
-	15.247(a)(2)	6dB Bandwidth	Not Required	-
-	2.1049	99% Occupied Bandwidth	Not Required	-
3.1	15.247(b)(3)	Output Power	Pass	-
-	15.247(e)	Power Spectral Density	Not Required	-
-	15.247(d)	Conducted Band Edges and Spurious Emission	Not Required	-
3.2	15.247(d)	Radiated Band Edges and Spurious Emission	Pass	Under limit 5.36 dB at 43.580 MHz
-	15.207	AC Conducted Emission	Not Required	-
3.3	15.203 & 15.247(b)	Antenna Requirement	Pass	-

**Remark:**

1. Not required means after assessing, test items are not necessary to carry out.
2. This is a variant report. All the test cases were performed on original report which can be referred to Sporton Report Number FR8O2417-03B.
3. The spot-check data performed in this report are chosen from the worst case of the original FCC ID report and the spot-check data summary is included in the another spot check data report.

**Declaration of Conformity:**

The test results with all measurement uncertainty excluded are presented in accordance with the regulation limits or requirements declared by manufacturers.

**Comments and Explanations:**

The declared of product specification for EUT presented in the report are provided by the manufacturer, and the manufacturer takes all the responsibilities for the accuracy of product specification.

**Reviewed by: Wii Chang**

**Report Producer: Natasha Hsieh**



# 1 General Description

## 1.1 Product Feature of Equipment Under Test

GSM/WCDMA/LTE, Bluetooth, DTS/UNII a/b/g/n/ac, NFC, and GNSS.

Standards-related Product Specification	
Antenna Type / Gain	Loop Antenna with gain -2.0 dBi

EUT Information List			
HW Version	SW Version	S/N	Performed Test Item
A	2.37	QV71006R1S	RF conducted measurement
		QV71007L1S	Radiated Spurious Emission

Accessory List	
AC Adapter	Model Name : UCH32
	S/N : 6218W30200106
Earphone	Model Name.: MH750
	S/N : N/A
USB Cable	Model Name.: UCB24
	S/N : N/A
2 in 1 USB Audio Cable	Model Name: EC270
	S/N : N/A

**Note:**

1. Above EUT list used are electrically identical per declared by manufacturer.
2. Above the accessories list are used to exercise the EUT during test, and the serial number of each type of accessories is listed in each section of this report. .
3. For other wireless features of this EUT, test report will be issued separately.

## 1.2 Modification of EUT

No modifications are made to the EUT during all test items.



### 1.3 Testing Location

<b>Test Site</b>	SPORTON INTERNATIONAL INC.
<b>Test Site Location</b>	No.58, Aly. 75, Ln. 564, Wenhua 3rd, Rd., Guishan Dist., Taoyuan City, Taiwan (R.O.C.) TEL: +886-3-327-0868 FAX: +886-3-327-0855
<b>Test Site No.</b>	<b>Sporton Site No.</b>
	03CH12-HY

**Note:** The test site complies with ANSI C63.4 2014 requirement.

FCC Designation No.: TW0007

### 1.4 Applicable Standards

According to the specifications of the manufacturer, the EUT must comply with the requirements of the following standards:

- ♦ FCC Part 15 Subpart C §15.247
- ♦ FCC KDB Publication No. 558074 D01 DTS Meas. Guidance v05r02
- ♦ FCC KDB 414788 D01 Radiated Test Site v01r01.
- ♦ ANSI C63.10-2013

**Remark:**

1. All test items were verified and recorded according to the standards and without any deviation during the test.
2. This EUT has also been tested and complied with the requirements of FCC Part 15, Subpart B, recorded in a separate test report.



## 2 Test Configuration of Equipment Under Test

### 2.1 Carrier Frequency Channel

Frequency Band	Channel	Freq. (MHz)	Channel	Freq. (MHz)
2400-2483.5 MHz	0	2402	21	2444
	1	2404	22	2446
	2	2406	23	2448
	3	2408	24	2450
	4	2410	25	2452
	5	2412	26	2454
	6	2414	27	2456
	7	2416	28	2458
	8	2418	29	2460
	9	2420	30	2462
	10	2422	31	2464
	11	2424	32	2466
	12	2426	33	2468
	13	2428	34	2470
	14	2430	35	2472
	15	2432	36	2474
	16	2434	37	2476
	17	2436	38	2478
	18	2438	39	2480
	19	2440	-	-
20	2442	-	-	



## 2.2 Test Mode

- a. The EUT has been associated with peripherals and configuration operated in a manner tended to maximize its emission characteristics in a typical application. Frequency range investigated: radiation emission (9 kHz to the 10th harmonic of the highest fundamental frequency or to 40 GHz, whichever is lower). For radiated measurement, pre-scanned in three orthogonal panels, X, Y, Z. The worst cases (X plane) were recorded in this report.

The following summary table is showing all test modes to demonstrate in compliance with the standard.

Summary table of Test Cases	
Test Item	Data Rate / Modulation
	Bluetooth – LE / GFSK
Radiated Test Cases	Mode 1: Bluetooth Tx CH00_2402 MHz_2Mbps



## 2.3 Connection Diagram of Test System

<Bluetooth-LE Tx Mode>

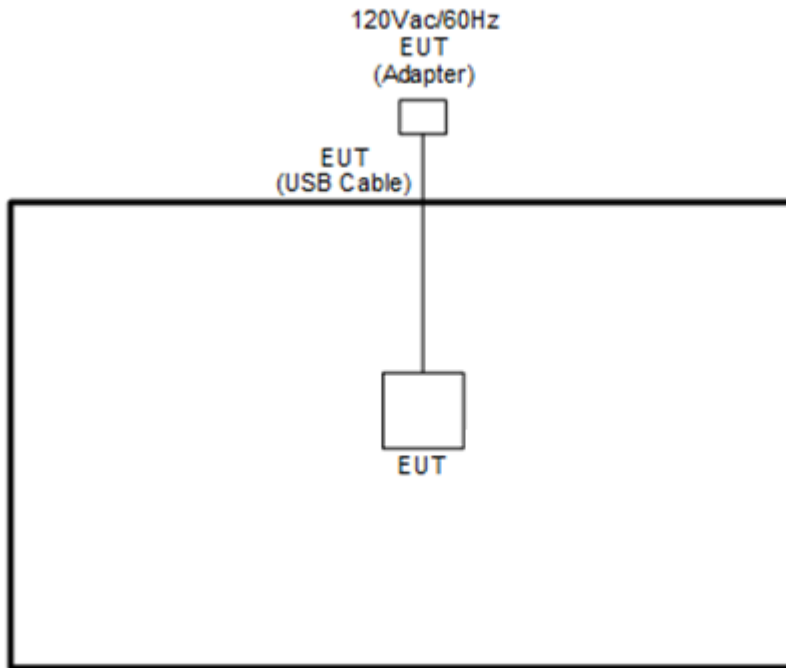

## 2.4 EUT Operation Test Setup

The RF test items, utility “Tera Term” was installed in Notebook which was programmed in order to make the EUT get into the engineering modes to provide channel selection, power level, data rate and the application type and for continuous transmitting signals.

### 3 Test Result

#### 3.1 Output Power Measurement

##### 3.1.1 Limit of Output Power

For systems using digital modulation in the 2400-2483.5MHz, the limit for peak output power is 30dBm. If transmitting antenna of directional gain greater than 6dBi is used, the peak output power from the intentional radiator shall be reduced below the above stated value by the amount in dB that the directional gain of the antenna exceeds 6 dBi. In case of point-to-point operation, the limit has to be reduced by 1dB for every 3dB that the directional gain of the antenna exceeds 6dBi.

##### 3.1.2 Measuring Instruments

See list of measuring equipment of this test report.

##### 3.1.3 Test Procedures

1. For Average Power, the testing follows ANSI C63.10 Section 11.9.2.3.2 Method AVGP-M-G.
2. The RF output of EUT was connected to the power meter by RF cable and attenuator.
3. The path loss was compensated to the results for each measurement.
4. Set to the maximum power setting and enable the EUT transmit continuously.
5. Measure the conducted output power and record the results in the test report.

##### 3.1.4 Test Setup

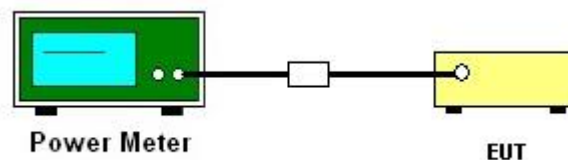

##### 3.1.5 Test Result of Average Output Power

Please refer to Appendix A.



## 3.2 Radiated Band Edges and Spurious Emission Measurement

### 3.2.1 Limit of Radiated Band Edges and Spurious Emission

In any 100 kHz bandwidth outside the intentional radiator frequency band, all harmonics/spurious must be at least 20 dB below the highest emission level within the authorized band. If the output power of this device was measured by spectrum analyzer, the attenuation under this paragraph shall be 30 dB instead of 20 dB. In addition, radiated emissions which fall in the restricted bands must also comply with the limits as below.

Frequency (MHz)	Field Strength (microvolts/meter)	Measurement Distance (meters)
0.009 – 0.490	2400/F(kHz)	300
0.490 – 1.705	24000/F(kHz)	30
1.705 – 30.0	30	30
30 – 88	100	3
88 – 216	150	3
216 - 960	200	3
Above 960	500	3

### 3.2.2 Measuring Instruments

See list of measuring equipment of this test report.



### 3.2.3 Test Procedures

1. The testing follows the ANSI C63.10 Section 11.12.1 Radiated emission measurements.
2. The EUT was arranged to its worst case and then tune the antenna tower (from 1 m to 4 m) and turntable (from 0 degree to 360 degrees) to find the maximum reading. A pre-amp and a high pass filter are used for the test in order to get better signal level.
3. The EUT was placed on a turntable with 0.8 meter for frequency below 1GHz and 1.5 meter for frequency above 1GHz respectively above ground.
4. The EUT was set 3 meters from the interference receiving antenna, which was mounted on the top of a variable height antenna tower.
5. Corrected Reading: Antenna Factor + Cable Loss + Read Level - Preamp Factor = Level
6. For testing below 1GHz, if the emission level of the EUT in peak mode was 3 dB lower than the limit specified, then peak values of EUT will be reported, otherwise, the emissions will be repeated one by one using the CISPR quasi-peak method and reported.
7. For testing above 1GHz, the emission level of the EUT in peak mode was 20dB lower than average limit (that means the emission level in average mode also complies with the limit in average mode), then peak values of EUT will be reported, otherwise, the emissions will be measured in average mode again and reported.
8. Use the following spectrum analyzer settings:
  - (1) Span shall wide enough to fully capture the emission being measured;
  - (2) Set RBW=100 kHz for  $f < 1$  GHz;  $VBW \geq RBW$ ; Sweep = auto; Detector function = peak; Trace = max hold;
  - (3) Set RBW = 1 MHz, VBW= 3MHz for  $f \geq 1$  GHz for peak measurement.  
For average measurement:
    - $VBW = 10$  Hz, when duty cycle is no less than 98 percent.
    - $VBW \geq 1/T$ , when duty cycle is less than 98 percent where T is the minimum transmission duration over which the transmitter is on and is transmitting at its maximum power control level for the tested mode of operation.

### 3.2.4 Test Setup

For radiated emissions below 30MHz

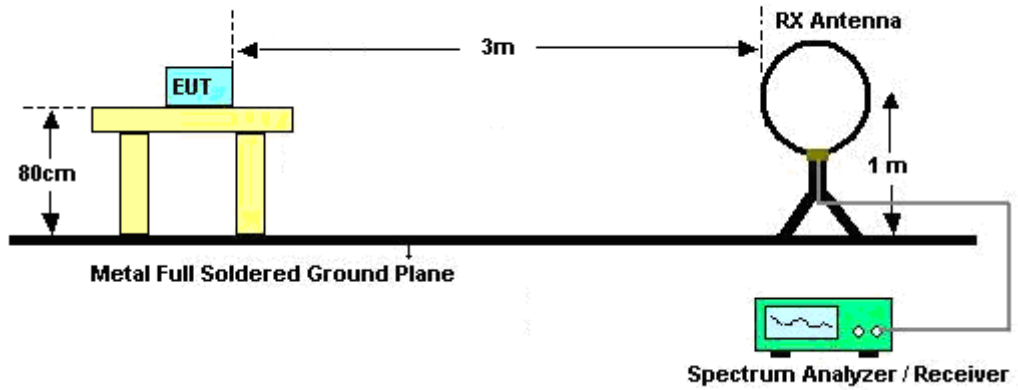

For radiated emissions from 30MHz to 1GHz

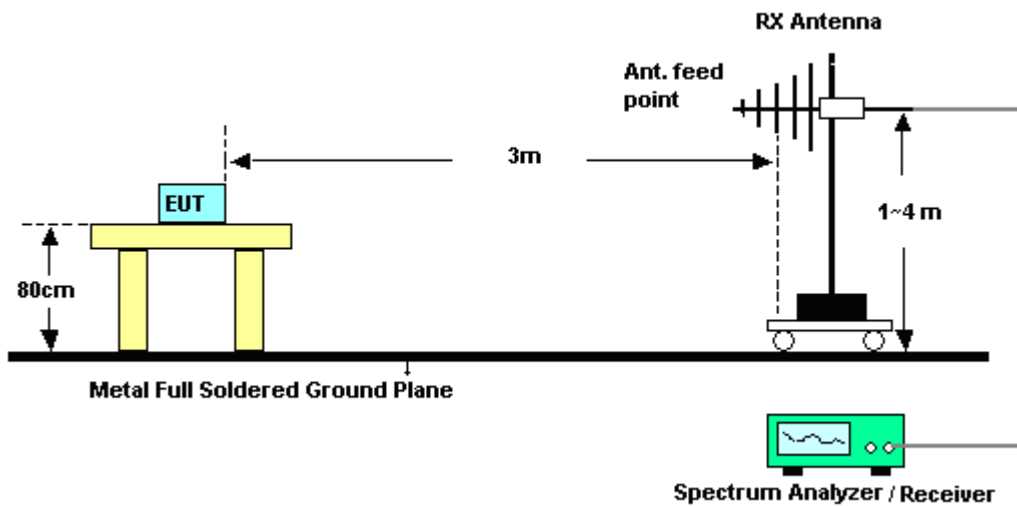

For radiated emissions above 1GHz

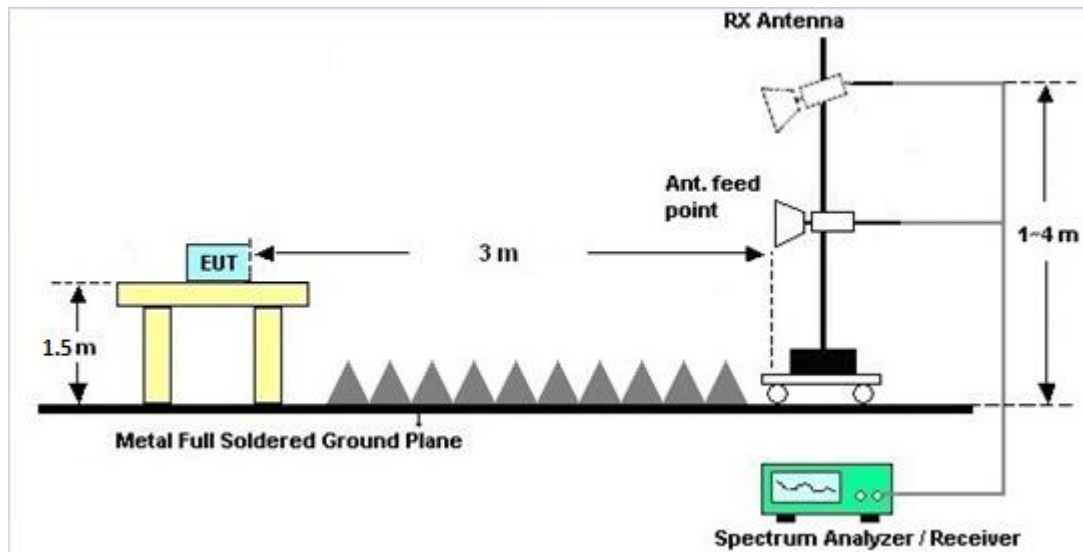

### 3.2.5 Test Results of Radiated Spurious Emissions (9 kHz ~ 30 MHz)

The low frequency, which started from 9 kHz to 30MHz, was pre-scanned and the result which was 20dB lower than the limit line was not reported.

There is a comparison data of both open-field test site and alternative test site - semi-Anechoic chamber according to 414788 D01 Radiated Test Site v01r01, and the result came out very similar.

### 3.2.6 Test Result of Radiated Spurious at Band Edges

Please refer to Appendix B and C.

### 3.2.7 Duty Cycle

Please refer to Appendix D.

### 3.2.8 Test Result of Radiated Spurious Emission (30MHz ~ 10th Harmonic)

Please refer to Appendix B and C.



### **3.3 Antenna Requirements**

#### **3.3.1 Standard Applicable**

If directional gain of transmitting antennas is greater than 6dBi, the power shall be reduced by the same level in dB comparing to gain minus 6dBi. The use of a permanently attached antenna or of an antenna that uses a unique coupling to the intentional radiator shall be considered sufficient to comply with the rule.

#### **3.3.2 Antenna Anti-Replacement Construction**

An embedded-in antenna design is used.

#### **3.3.3 Antenna Gain**

The antenna peak gain of EUT is less than 6 dBi. Therefore, it is not necessary to reduce maximum peak output power limit.



## 4 List of Measuring Equipment

Instrument	Manufacturer	Model No.	Serial No.	Characteristics	Calibration Date	Test Date	Due Date	Remark
Hygrometer	Testo	HTC-1	4	N/A	May 12, 2018	Apr. 16, 2019	May 11, 2019	Conducted (TH05-HY)
Power Sensor	DARE	RPR3006W	15100041SN O10	10MHz~6GHz	May 07, 2018	Apr. 16, 2019	May 06, 2019	Conducted (TH05-HY)
Switch Box & RF Cable	Burgeon	ETF-058	EC1300484	N/A	Feb. 28, 2019	Apr. 16, 2019	Feb. 27, 2020	Conducted (TH05-HY)
Programmable Power Supply	GW Instek	PSS-2005	EL890094	1V~20V 0.5A~5A	Oct. 02, 2018	Apr. 16, 2019	Oct. 01, 2019	Conducted (TH05-HY)
Loop Antenna	Rohde & Schwarz	HFH2-Z2	100488	9 kHz~30 MHz	Jan. 07, 2019	Apr. 20, 2019~ Apr. 26, 2019	Jan. 06, 2020	Radiation (03CH12-HY)
Bilog Antenna	TESEQ	CBL 6111D&00800 N1D01N-06	37059&01	30MHz~1GHz	Oct. 13, 2018	Apr. 20, 2019~ Apr. 26, 2019	Oct. 12, 2019	Radiation (03CH12-HY)
Horn Antenna	SCHWARZBECK	BBHA 9120D	9120D-1328	1GHz ~ 18GHz	Oct. 19, 2018	Apr. 20, 2019~ Apr. 26, 2019	Oct. 18, 2019	Radiation (03CH12-HY)
SHF-EHF Horn Antenna	SCHWARZBECK	BBHA 9170	BBHA917057 6	18GHz ~ 40GHz	May 08, 2018	Apr. 20, 2019~ Apr. 26, 2019	May 07, 2019	Radiation (03CH12-HY)
Preamplifier	SONOMA	310N	187312	9kHz~1GHz	Dec. 04, 2018	Apr. 20, 2019~ Apr. 26, 2019	Dec. 03, 2019	Radiation (03CH12-HY)
Preamplifier	Agilent	8449B	3008A02375	1GHz~26.5GHz	May 28, 2018	Apr. 20, 2019~ Apr. 26, 2019	May 27, 2019	Radiation (03CH12-HY)
Preamplifier	Jet-Power	JPA0118-55-3 03	1710001800 055007	1GHz~18GHz	Apr. 01, 2019	Apr. 20, 2019~ Apr. 26, 2019	Mar. 31, 2020	Radiation (03CH12-HY)
Preamplifier	MITEQ	TTA1840-35-H G	1864481	18GHz ~ 40GHz	Aug. 24, 2018	Apr. 20, 2019~ Apr. 26, 2019	Aug. 23, 2019	Radiation (03CH12-HY)
EMI Test Receiver	Rohde & Schwarz	FSV30	103738	9kHz~30GHz	May 22, 2018	Apr. 20, 2019~ Apr. 26, 2019	May 21, 2019	Radiation (03CH12-HY)
Hygrometer	TECPEL	DTM-303B	TP161243	N/A	May 12, 2018	Apr. 20, 2019~ Apr. 26, 2019	May 11, 2019	Radiation (03CH12-HY)
Filter	Wainwright	WHKX12-2700 -3000-18000-6 0ST	SN2	3GHz High Pass	Sep. 17, 2018	Apr. 20, 2019~ Apr. 26, 2019	Sep. 16, 2019	Radiation (03CH12-HY)
Filter	Wainwright	WLK4-1000-15 30-8000-40SS	SN12	1GHz Low Pass	Sep. 17, 2018	Apr. 20, 2019~ Apr. 26, 2019	Sep. 16, 2019	Radiation (03CH12-HY)
RF Cable	HUBER + SUHNER	SUCOFLEX 126E	0058/126E	30M-18G	Mar. 13, 2019	Apr. 20, 2019~ Apr. 26, 2019	Mar. 12, 2020	Radiation (03CH12-HY)
RF Cable	HUBER + SUHNER	SUCOFLEX 102	505134/2	30M~40GHz	Oct. 16, 2018	Apr. 20, 2019~ Apr. 26, 2019	Oct. 15, 2019	Radiation (03CH12-HY)
RF Cable	HUBER + SUHNER	SUCOFLEX 102	800740/2	30M~40GHz	Oct. 16, 2018	Apr. 20, 2019~ Apr. 26, 2019	Oct. 15, 2019	Radiation (03CH12-HY)





Instrument	Manufacturer	Model No.	Serial No.	Characteristics	Calibration Date	Test Date	Due Date	Remark
Controller	EMEC	EM1000	N/A	Control Turn table & Ant Mast	N/A	Apr. 20, 2019~ Apr. 26, 2019	N/A	Radiation (03CH12-HY)
Antenna Mast	EMEC	AM-BS-4500-B	N/A	1m~4m	N/A	Apr. 20, 2019~ Apr. 26, 2019	N/A	Radiation (03CH12-HY)
Turn Table	EMEC	TT2000	N/A	0~360 Degree	N/A	Apr. 20, 2019~ Apr. 26, 2019	N/A	Radiation (03CH12-HY)
Software	Audix	E3 6.2009-8-24	RK-000989	N/A	N/A	Apr. 20, 2019~ Apr. 26, 2019	N/A	Radiation (03CH12-HY)



## 5 Uncertainty of Evaluation

### Uncertainty of Radiated Emission Measurement (30 MHz ~ 1000 MHz)

Measuring Uncertainty for a Level of Confidence of 95% ( $U = 2Uc(y)$ )	5.10
---	------

### Uncertainty of Radiated Emission Measurement (1000 MHz ~ 18000 MHz)

Measuring Uncertainty for a Level of Confidence of 95% ( $U = 2Uc(y)$ )	5.20
---	------

### Uncertainty of Radiated Emission Measurement (18000 MHz ~ 40000 MHz)

Measuring Uncertainty for a Level of Confidence of 95% ( $U = 2Uc(y)$ )	4.70
---	------

**Appendix A. Test Result of Conducted Test Items**

Test Engineer:	Richard Qiu	Temperature:	21~25	°C
Test Date:	2019/4/16	Relative Humidity:	51~54	%

&lt;1Mbps&gt;

**TEST RESULTS DATA**  
**Average Power Table**

Mod.	Data Rate	N <sub>TX</sub>	CH.	Freq. (MHz)	Average Conducted Power (dBm)
BLE	1Mbps	1	0	2402	4.90
BLE	1Mbps	1	19	2440	5.30
BLE	1Mbps	1	39	2480	4.50

Test Engineer:	Richard Qiu	Temperature:	21~25	°C
Test Date:	2019/4/16	Relative Humidity:	51~54	%

&lt;2Mbps&gt;

**TEST RESULTS DATA****Average Power Table**

Mod.	Data Rate	NTX	CH.	Freq. (MHz)	Average Conducted Power (dBm)
BLE	2Mbps	1	0	2402	5.10
BLE	2Mbps	1	19	2440	5.40
BLE	2Mbps	1	39	2480	4.60



## Appendix B. Radiated Spurious Emission

Test Engineer :	Jack Cheng , Lance Chiang ,Chuan Chu	Temperature :	22~24°C
		Relative Humidity :	56~60%

### 2.4GHz 2400~2483.5MHz

#### BLE 2Mbps (Band Edge @ 3m)

BLE	Note	Frequency ( MHz )	Level ( dBμV/m )	Over Limit ( dB )	Limit Line ( dBμV/m )	Read Level ( dBμV )	Antenna Factor ( dB/m )	Path Loss ( dB )	Preamp Factor ( dB )	Ant Pos ( cm )	Table Pos ( deg )	Peak Avg. ( P/A )	Pol. ( H/V )	
BLE CH 00 2402MHz		2319.555	56.65	-17.35	74	45.4	27.78	16.54	33.07	153	28	P	H	
		2315.565	43.09	-10.91	54	31.81	27.81	16.54	33.07	153	28	A	H	
	*	2402	99.03	-	-	88.06	27.5	16.64	33.17	153	28	P	H	
	*	2402	96.52	-	-	85.55	27.5	16.64	33.17	153	28	A	H	
													H	
														H
			2354.52	56.77	-17.23	74	45.71	27.59	16.59	33.12	301	45	P	V
			2347.065	43.04	-10.96	54	31.95	27.62	16.58	33.11	301	45	A	V
	*		2402	91.87	-	-	80.9	27.5	16.64	33.17	301	45	P	V
	*		2402	89.64	-	-	78.67	27.5	16.64	33.17	301	45	A	V
														V
													V	
Remark	1. No other spurious found. 2. All results are PASS against Peak and Average limit line.													



2.4GHz 2400~2483.5MHz  
BLE 2Mbps (Harmonic @ 3m)

BLE	Note	Frequency	Level	Over Limit	Limit Line	Read Level	Antenna Factor	Path Loss	Preamp Factor	Ant Pos	Table Pos	Peak Avg.	Pol.	
		( MHz )	( dB $\mu$ V/m )	( dB )	( dB $\mu$ V/m )	( dB $\mu$ V )	( dB/m )	( dB )	( dB )	( cm )	( deg )	( P/A )	( H/V )	
BLE CH 00 2402MHz		4804	36.38	-37.62	74	53.42	31.1	11.02	59.16	100	0	P	H	
													H	
													H	
													H	
			4804	36.42	-37.58	74	53.46	31.1	11.02	59.16	100	0	P	V
														V
														V
														V
<b>Remark</b>	1. No other spurious found. 2. All results are PASS against Peak and Average limit line.													



Emission below 1GHz

2.4GHz BLE (LF)

BLE	Note	Frequency	Level	Over Limit	Limit Line	Read Level	Antenna Factor	Path Loss	Preamp Factor	Ant Pos	Table Pos	Peak Avg.	Pol.	
		( MHz )	( dBμV/m )	( dB )	( dBμV/m )	( dBμV )	( dB/m )	( dB )	( dB )	( cm )	( deg )	( P/A )	( H/V )	
2.4GHz BLE LF		43.58	23.44	-16.56	40	35.42	17.45	0.95	30.38			P	H	
		150.28	23.76	-19.74	43.5	35.22	17.17	1.74	30.37			P	H	
		205.57	26.35	-17.15	43.5	39.57	15.09	2	30.31			P	H	
		714.82	32.45	-13.55	46	31.23	26.97	3.74	29.49			P	H	
		722.58	39.69	-6.31	46	38.2	27.2	3.76	29.47	100	0	P	H	
		954.41	36.96	-9.04	46	30.81	30.68	4.45	28.98			P	H	
														H
														H
														H
														H
														H
														H
			43.58	34.64	-5.36	40	46.62	17.45	0.95	30.38	100	0	P	V
			79.47	27.63	-12.37	40	43.52	13.25	1.31	30.45			P	V
			102.75	25.13	-18.37	43.5	37.86	16.24	1.46	30.43			P	V
			718.7	37.86	-8.14	46	36.52	27.07	3.75	29.48			P	V
			881.66	33.88	-12.12	46	29.75	29.1	4.2	29.17			P	V
			935.01	35.76	-10.24	46	30.42	29.99	4.39	29.04			P	V
														V
														V
													V	
													V	
													V	
													V	
Remark	1. No other spurious found. 2. All results are PASS against limit line.													



**Note symbol**

*	<b>Fundamental Frequency</b> which can be ignored. However, the level of any unwanted emissions shall not exceed the level of the fundamental frequency.
!	Test result is <b>over limit</b> line.
P/A	<b>Peak</b> or <b>Average</b>
H/V	<b>Horizontal</b> or <b>Vertical</b>





A calculation example for radiated spurious emission is shown as below:

BLE	Note	Frequency	Level	Over	Limit	Read	Antenna	Path	Preamp	Ant	Table	Peak	Pol.
		( MHz )	( dBμV/m )	( dB )	Limit Line	Level	Factor	Loss	Factor	Pos	Pos	Avg.	
					( dBμV/m )	( dBμV )	( dB/m )	( dB )	( dB )	( cm )	( deg )	( P/A )	( H/V )
BLE		2390	55.45	-18.55	74	54.51	32.22	4.58	35.86	103	308	P	H
CH 00		2390	43.54	-10.46	54	42.6	32.22	4.58	35.86	103	308	A	H
2402MHz													

1. Path Loss(dB) = Cable loss(dB) + Filter loss(dB) + Attenuator loss(dB)
2. Level(dBμV/m) =  
Antenna Factor(dB/m) + Path Loss(dB) + Read Level(dBμV) - Preamp Factor(dB)
3. Over Limit(dB) = Level(dBμV/m) – Limit Line(dBμV/m)

**For Peak Limit @ 2390MHz:**

1. Level(dBμV/m)  
= Antenna Factor(dB/m) + Path Loss(dB) + Read Level(dBμV) - Preamp Factor(dB)  
= 32.22(dB/m) + 4.58(dB) + 54.51(dBμV) – 35.86 (dB)  
= 55.45 (dBμV/m)
2. Over Limit(dB)  
= Level(dBμV/m) – Limit Line(dBμV/m)  
= 55.45(dBμV/m) – 74(dBμV/m)  
= -18.55(dB)

**For Average Limit @ 2390MHz:**

1. Level(dBμV/m)  
= Antenna Factor(dB/m) + Path Loss(dB) + Read Level(dBμV) - Preamp Factor(dB)  
= 32.22(dB/m) + 4.58(dB) + 42.6(dBμV) – 35.86 (dB)  
= 43.54 (dBμV/m)
2. Over Limit(dB)  
= Level(dBμV/m) – Limit Line(dBμV/m)  
= 43.54(dBμV/m) – 54(dBμV/m)  
= -10.46(dB)

**Both peak and average measured complies with the limit line, so test result is “PASS”.**



### Appendix C. Radiated Spurious Emission Plots

Test Engineer :	Jack Cheng , Lance Chiang ,Chuan Chu	Temperature :	22~24°C
		Relative Humidity :	56~60%

#### Note symbol

-L	Low channel location
-R	High channel location

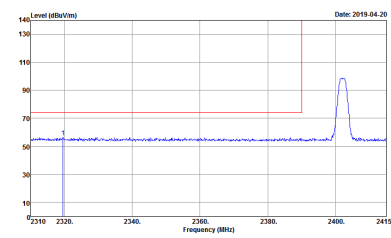
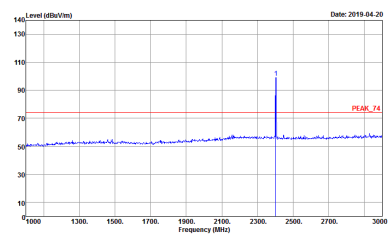
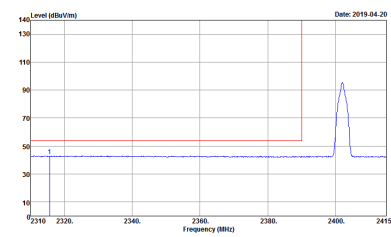
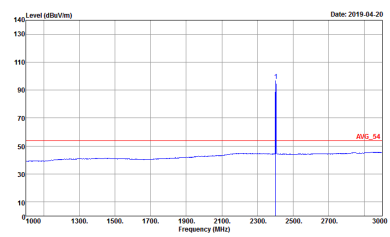

2.4GHz 2400~2483.5MHz  
BLE 2Mbps (Band Edge @ 3m)

BLE	2.4GHz 2400~2483.5MHz Band Edge @ 3m	
	BLE CH00 2402MHz	
	Horizontal	Fundamental
Peak	 <p>Site : 03CH12-HY Condition : PEAK_BE_74 3m HORN_91200_1328 HORIZONTAL Detector : Peak Project : 802421-03 Mode : 3</p>	 <p>Site : 03CH12-HY Condition : PEAK_74 3m HORN_91200_1328 HORIZONTAL Detector : Peak Project : 802421-03 Mode : 3</p>
Avg.	 <p>Site : 03CH12-HY Condition : AVG_BE_54 3m HORN_91200_1328 HORIZONTAL Detector : Peak Project : 802421-03 Mode : 3</p>	 <p>Site : 03CH12-HY Condition : AVG_54 3m HORN_91200_1328 HORIZONTAL Detector : Peak Project : 802421-03 Mode : 3</p>

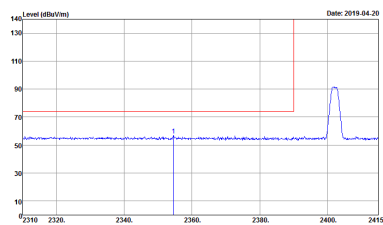
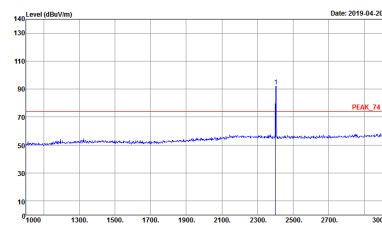
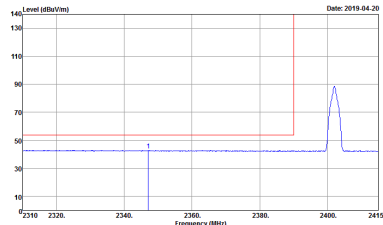
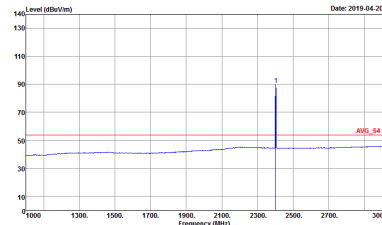

BLE	2.4GHz 2400~2483.5MHz Band Edge @ 3m	
BLE CH00 2402MHz		
Vertical		Fundamental
Peak	 <p>Site : 03CH12-HY            Condition : PEAK_BE_74 3m HORN_9120D_1328 VERTICAL            Detector : Peak            Project : 802421-03            Mode : 3</p>	 <p>Site : 03CH12-HY            Condition : PEAK_74 3m HORN_9120D_1328 VERTICAL            Detector : Peak            Project : 802421-03            Mode : 3</p>
Avg	 <p>Site : 03CH12-HY            Condition : AV6_BE_54 3m HORN_9120D_1328 VERTICAL            Detector : Peak            Project : 802421-03            Mode : 3</p>	 <p>Site : 03CH12-HY            Condition : AV6_54 3m HORN_9120D_1328 VERTICAL            Detector : Peak            Project : 802421-03            Mode : 3</p>



2.4GHz 2400~2483.5MHz
BLE 2Mbps (Harmonic @ 3m)

Table with 2 columns: Horizontal and Vertical. Each column contains a spectral plot showing Level (dBW/m) vs Frequency (MHz) with a peak at approximately 4.8 MHz. The table also includes a 'Peak Avg.' label and detailed test parameters for both orientations.



Emission below 1GHz

2.4GHz BLE (LF)

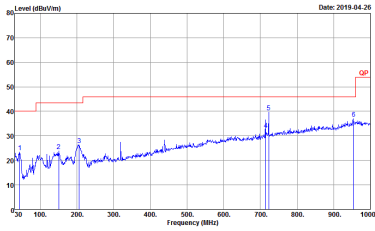
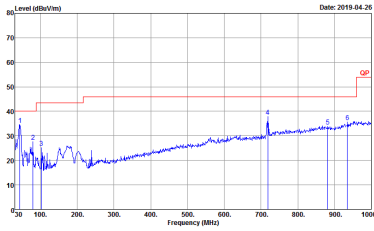
BLE	2.4GHz 2400~2483.5MHz	
	BLE LF	
	Horizontal	Vertical
<p>QP / Peak</p>	 <p>Site : 03CH12-HY  Condition : QP 3m BIL06_6111D_37059 HORIZONTAL  Detector : Peak  Project : 802421-03  Mode : 4</p>	 <p>Site : 03CH12-HY  Condition : QP 3m BIL06_6111D_37059 VERTICAL  Detector : Peak  Project : 802421-03  Mode : 4</p>



### Appendix D. Duty Cycle Plots

Band	Duty Cycle(%)	T(us)	1/T(kHz)	VBW Setting	Duty Factor(dB)
Bluetooth LE for 2 Mbps	57.03	1075	0.93	1kHz	2.44

#### Bluetooth - LE <2 Mbps>

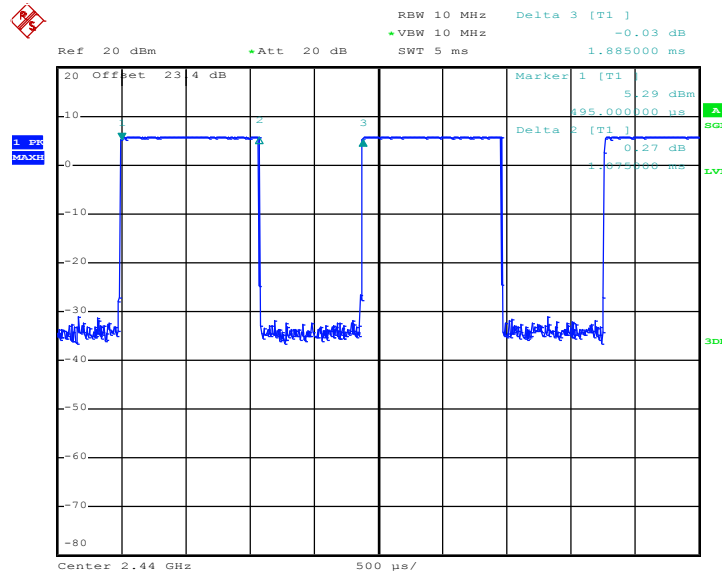

Date: 16.APR.2019 22:05:37

—————THE END—————