



# FCC RADIO TEST REPORT

**FCC ID** : PY7-24117P  
**Equipment** : GSM/WCDMA/LTE Phone with BT, DTS/UNII a/b/g/n/ac, GPS and NFC  
**Brand Name** : Sony  
**Applicant** : Sony Mobile Communications Inc.  
4-12-3 Higashi-Shinagawa, Shinagawa-ku,  
Tokyo, 140-0002, Japan  
**Manufacturer** : Sony Mobile Communications Inc.  
4-12-3 Higashi-Shinagawa, Shinagawa-ku,  
Tokyo, 140-0002, Japan  
**Standard** : FCC Part 15 Subpart C §15.247

The product was received on Nov. 01, 2018 and testing was started from Jan. 31, 2019 and completed on Mar. 13, 2019. We, SPORTON INTERNATIONAL INC. EMC & Wireless Communications Laboratory, would like to declare that the tested sample has been evaluated in accordance with the test procedures and has been in compliance with the applicable technical standards.

The report must not be used by the client to claim product certification, approval, or endorsement by TAF or any agency of government.

The test results in this report apply exclusively to the tested model / sample. Without written approval of SPORTON INTERNATIONAL INC. EMC & Wireless Communications Laboratory, the test report shall not be reproduced except in full.

Approved by: Jones Tsai

**SPORTON INTERNATIONAL INC. EMC & Wireless Communications Laboratory**

No. 52, Huaya 1st Rd., Guishan Dist., Taoyuan City, Taiwan (R.O.C.)



## Table of Contents

|   |           |
|---|-----------|
| History of this test report .....                               | 3         |
| Summary of Test Result .....                                    | 4         |
| <b>1 General Description.....</b>                               | <b>5</b>  |
| 1.1 Product Feature of Equipment Under Test .....               | 5         |
| 1.2 Modification of EUT .....                                   | 5         |
| 1.3 Testing Location .....                                      | 6         |
| 1.4 Applicable Standards .....                                  | 6         |
| <b>2 Test Configuration of Equipment Under Test.....</b>        | <b>7</b>  |
| 2.1 Carrier Frequency and Channel.....                          | 7         |
| 2.2 Test Mode.....  | 7         |
| 2.3 Connection Diagram of Test System .....                     | 8         |
| 2.4 Support Unit used in test configuration and system.....     | 9         |
| 2.5 EUT Operation Test Setup .....                              | 9         |
| 2.6 Measurement Results Explanation Example .....               | 9         |
| <b>3 Test Result.....</b>                                       | <b>10</b> |
| 3.1 6dB and 99% Bandwidth Measurement.....                      | 10        |
| 3.2 Output Power Measurement .....                              | 12        |
| 3.3 Power Spectral Density Measurement.....                     | 13        |
| 3.4 Conducted Band Edges and Spurious Emission Measurement..... | 15        |
| 3.5 Radiated Band Edges and Spurious Emission Measurement ..... | 46        |
| 3.6 AC Conducted Emission Measurement .....                     | 50        |
| 3.7 Antenna Requirements.....                                   | 52        |
| <b>4 List of Measuring Equipment .....</b>                      | <b>53</b> |
| <b>5 Uncertainty of Evaluation.....</b>                         | <b>55</b> |
| <b>Appendix A. Conducted Test Results</b>                       |           |
| <b>Appendix B. AC Conducted Emission Test Result</b>            |           |
| <b>Appendix C. Radiated Spurious Emission</b>                   |           |
| <b>Appendix D. Radiated Spurious Emission Plots</b>             |           |
| <b>Appendix E. Duty Cycle Plots</b>                             |           |



### History of this test report

| Report No.   | Version | Description                                 | Issued Date   |
|--------------|---------|---|---------------|
| FR802417-03C | 01      | Initial issue of report                     | Mar. 15, 2019 |
| FR802417-03C | 02      | Add the description and revising test data. | Mar. 22, 2019 |
|              |         |   |               |
|              |         |   |               |
|              |         |   |               |
|              |         |   |               |
|              |         |   |               |
|              |         |   |               |
|              |         |   |               |
|              |         |   |               |
|              |         |   |               |
|              |         |   |               |
|              |         |   |               |
|              |         |   |               |
|              |         |   |               |
|              |         |   |               |
|              |         |   |               |
|              |         |   |               |
|              |         |   |               |
|              |         |   |               |



### Summary of Test Result

| Report Clause | Ref Std. Clause    | Test Items   | Result (PASS/FAIL) | Remark                                    |
|---------------|--------------------|--|--------------------|---|
| 3.1           | 15.247(a)(2)       | 6dB Bandwidth                                      | Pass               | -   |
| 3.1           | 2.1049             | 99% Occupied Bandwidth                             | Reporting only     | -   |
| 3.2           | 15.247(b)          | Power Output Measurement                           | Pass               | -   |
| 3.3           | 15.247(e)          | Power Spectral Density                             | Pass               | -   |
| 3.4           | 15.247(d)          | Conducted Band Edges                               | Pass               | -   |
|               |                    | Conducted Spurious Emission                        | Pass               | -   |
| 3.5           | 15.247(d)          | Radiated Band Edges and Radiated Spurious Emission | Pass               | Under limit<br>3.14 dB at<br>2483.520 MHz |
| 3.6           | 15.207             | AC Conducted Emission                              | Pass               | Under limit<br>10.26 dB at<br>1.050 MHz   |
| 3.7           | 15.203 & 15.247(b) | Antenna Requirement                                | Pass               | -   |

|  |
|--|
| <b>Declaration of Conformity:</b>  |
| The test results with all measurement uncertainty excluded are presented in accordance with the regulation limits or requirements declared by manufacturers.   |
| <b>Comments and Explanations:</b>  |
| The declared of product specification for EUT presented in the report are provided by the manufacturer, and the manufacturer takes all the responsibilities for the accuracy of product specification. |

Reviewed by: Wii Chang

Report Producer: Natasha Hsieh

# 1 General Description

## 1.1 Product Feature of Equipment Under Test

GSM/WCDMA/LTE, Bluetooth, DTS/UNII a/b/g/n/ac, NFC, and GNSS.

| Standards-related Product Specification |  |
|---|--|
| Antenna Type / Gain                     | <Ant. 1>: Loop Antenna with gain -2.0 dBi<br><Ant. 2>: Inverted-F Antenna with gain -3.0 dBi |

| EUT Information List |            |            |                            |
|----------------------|------------|------------|----------------------------|
| HW Version           | SW Version | S/N        | Performed Test Item        |
| A                    | 1.63       | BH97006BFU | RF conducted measurement   |
|                      |            | BH9700K3FU | Radiated Spurious Emission |
|                      |            | BH97006GFR | AC Conducted Emission      |

| Accessory List         |   |
|------------------------|---|
| AC Adapter             | Model Name : UCH32  |
|                        | S/N:<br>6218W30200106 (for radiated emission)<br>6218W30200197 (for conducted emission) |
|                        |   |
| Earphone               | Model No.: MH750  |
|                        | S/N : N/A   |
| USB Cable              | Model No.: UCB24  |
|                        | S/N : N/A   |
| 2 in 1 USB Audio Cable | Model No.: EC270  |
|                        | S/N : N/A   |

**Note:**

- Above EUT list used are electrically identical per declared by manufacturer.
- Above the accessories list are used to exercise the EUT during test, and the serial number of each type of accessories is listed in each section of this report. .
- For other wireless features of this EUT, test report will be issued separately.
- The antenna 1 and antenna 2 in this test report are equivalent to WLAN chain 0 and chain 1 in Antenna Specification by manufacturer.

## 1.2 Modification of EUT

No modifications are made to the EUT during all test items.



### 1.3 Testing Location

|                           |   |         |
|---------------------------|---|---------|
| <b>Test Site</b>          | SPORTON INTERNATIONAL INC.  |         |
| <b>Test Site Location</b> | No.52, Huaya 1st Rd., Guishan Dist.,<br>Taoyuan City, Taiwan (R.O.C.)<br>TEL: +886-3-327-3456<br>FAX: +886-3-328-4978 |         |
| <b>Test Site No.</b>      | <b>Sporton Site No.</b>   |         |
|                           | TH05-HY   | CO05-HY |

**Note:** The test site complies with ANSI C63.4 2014 requirement.

|                           |   |  |
|---------------------------|---|--|
| <b>Test Site</b>          | SPORTON INTERNATIONAL INC.  |  |
| <b>Test Site Location</b> | No.58, Aly. 75, Ln. 564, Wenhua 3rd, Rd., Guishan Dist.,<br>Taoyuan City, Taiwan (R.O.C.)<br>TEL: +886-3-327-0868<br>FAX: +886-3-327-0855 |  |
| <b>Test Site No.</b>      | <b>Sporton Site No.</b>   |  |
|                           | 03CH13-HY   |  |

**Note:** The test site complies with ANSI C63.4 2014 requirement.

FCC Designation No.: TW1190 and TW0007

### 1.4 Applicable Standards

According to the specifications of the manufacturer, the EUT must comply with the requirements of the following standards:

- ♦ FCC Part 15 Subpart C §15.247
- ♦ FCC KDB Publication No. 558074 D01 DTS Meas. Guidance v05r01
- ♦ FCC KDB 414788 D01 Radiated Test Site v01r01.
- ♦ FCC KDB 662911 D01 Multiple Transmitter Output v02r01.
- ♦ ANSI C63.10-2013

**Remark:**

1. All test items were verified and recorded according to the standards and without any deviation during the test.
2. This EUT has also been tested and complied with the requirements of FCC Part 15, Subpart B, recorded in a separate test report.



## 2 Test Configuration of Equipment Under Test

- a. The EUT has been associated with peripherals and configuration operated in a manner tended to maximize its emission characteristics in a typical application. Frequency range investigated: conduction emission (150 kHz to 30 MHz), radiation emission (9 kHz to the 10th harmonic of the highest fundamental frequency or to 40 GHz, whichever is lower). For radiated measurement, pre-scanned in three orthogonal panels, X, Y, Z. The worst cases (X plane) were recorded in this report.
- b. AC power line Conducted Emission was tested under maximum output power.

### 2.1 Carrier Frequency and Channel

| Frequency Band  | Channel | Freq. (MHz) | Channel | Freq. (MHz) |
|-----------------|---------|-------------|---------|-------------|
| 2400-2483.5 MHz | 1       | 2412        | 8       | 2447        |
|                 | 2       | 2417        | 9       | 2452        |
|                 | 3       | 2422        | 10      | 2457        |
|                 | 4       | 2427        | 11      | 2462        |
|                 | 5       | 2432        | 12      | 2467        |
|                 | 6       | 2437        | 13      | 2472        |
|                 | 7       | 2442        |         |             |

### 2.2 Test Mode

Final test modes are considering the modulation and worse data rates as below table.

| Modulation   | Data Rate |
|--------------|-----------|
| 802.11b      | 1 Mbps    |
| 802.11g      | 6 Mbps    |
| 802.11n HT20 | MCS0      |

| Test Cases            |   |
|-----------------------|---|
| AC Conducted Emission | Mode 1 :GSM850 (Low Channel) Idle + Bluetooth Link + WLAN (2.4GHz) Link + Camera (Rear) + Battery + USB Cable (Charging from Adapter) |

## 2.3 Connection Diagram of Test System

<WLAN Tx Mode>

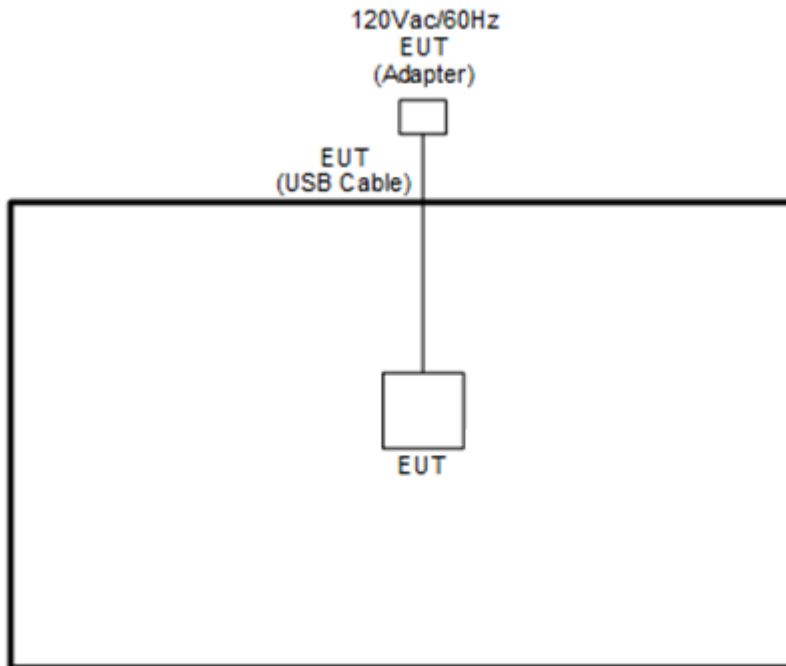

<AC Conducted Emission Mode>

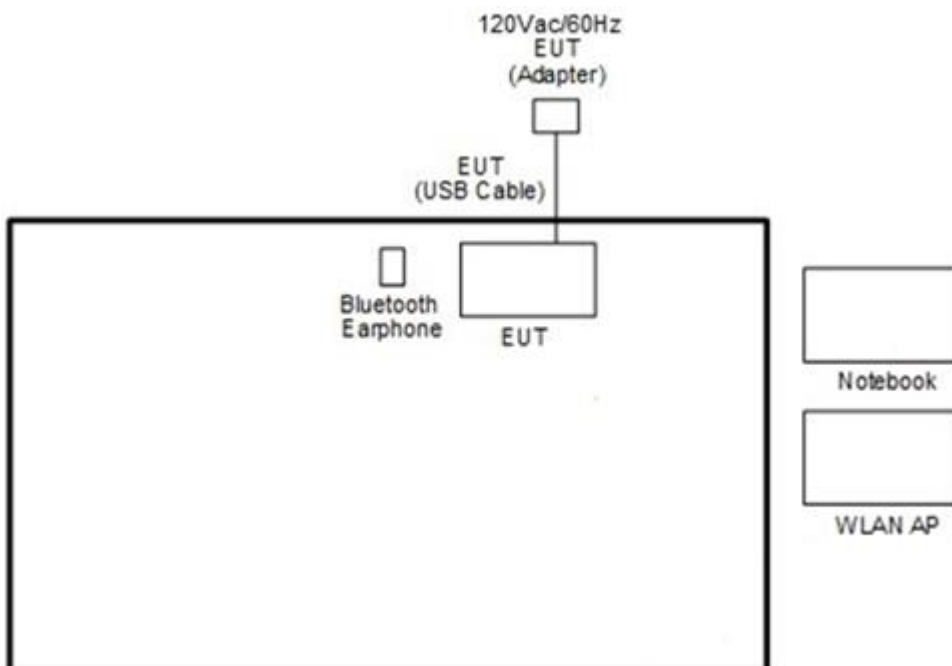



## 2.4 Support Unit used in test configuration and system

| Item | Equipment          | Trade Name | Model Name     | FCC ID      | Data Cable | Power Cord   |
|------|--------------------|------------|----------------|-------------|------------|--|
| 1.   | System simulator   | Anritsu    | MT8820C        | N/A         | N/A        | Unshielded, 1.8 m                                    |
| 2.   | WLAN AP            | ASUS       | RT-AC66U       | MSQ-RTAC66U | N/A        | Unshielded, 1.8 m                                    |
| 3.   | Bluetooth Earphone | Sony       | SBH20          | PY7-RD0010  | N/A        | N/A  |
| 4.   | Notebook           | DELL       | Latitude E6320 | FCC DoC     | N/A        | AC I/P: Unshielded, 1.2 m<br>DC O/P: Shielded, 1.8 m |
| 5.   | SD Card            | SanDisk    | MicroSD HC     | FCC DoC     | N/A        | N/A  |

## 2.5 EUT Operation Test Setup

The RF test items, utility “Tera Term” was installed in Notebook which was programmed in order to make the EUT get into the engineering modes to provide channel selection, power level, data rate and the application type and for continuous transmitting signals.

## 2.6 Measurement Results Explanation Example

**For all conducted test items:**

The offset level is set in the spectrum analyzer to compensate the RF cable loss and attenuator factor between EUT conducted output port and spectrum analyzer. With the offset compensation, the spectrum analyzer reading level is exactly the EUT RF output level.

Example:

The spectrum analyzer offset is derived from RF cable loss and attenuator factor.

*Offset = RF cable loss + attenuator factor.*

Following shows an offset computation example with cable loss 4.2 dB and 10dB attenuator.

$$\begin{aligned}
 \text{Offset(dB)} &= \text{RF cable loss(dB)} + \text{attenuator factor(dB)} \\
 &= 4.2 + 10 = 14.2 \text{ (dB)}
 \end{aligned}$$

### 3 Test Result

#### 3.1 6dB and 99% Bandwidth Measurement

##### 3.1.1 Limit of 6dB and 99% Bandwidth

The minimum 6 dB bandwidth shall be at least 500 kHz.

##### 3.1.2 Measuring Instruments

See list of measuring equipment of this test report.

##### 3.1.3 Test Procedures

1. The testing follows the ANSI C63.10 Section 6.9.3 (OBW) and 11.8.1 (6dB BW).
2. The RF output of EUT was connected to the spectrum analyzer by RF cable and attenuator. The path loss was compensated to the results for each measurement.
3. Set to the maximum power setting and enable the EUT transmit continuously.
4. Make the measurement with the spectrum analyzer's resolution bandwidth (RBW) = 100 kHz. Set the Video bandwidth (VBW) = 300 kHz. In order to make an accurate measurement. The 6 dB bandwidth must be greater than 500 kHz.
5. For 99% Bandwidth Measurement, the spectrum analyzer's resolution bandwidth (RBW) is set 1-5% of the emission bandwidth and set the Video bandwidth (VBW)  $\geq 3 * RBW$ .
6. Measure and record the results in the test report.

##### 3.1.4 Test Setup

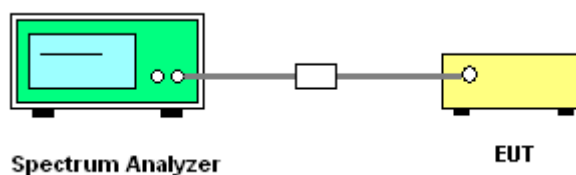



### 3.1.5 Test Result of 6dB and 99% Occupied Bandwidth

Please refer to Appendix A.

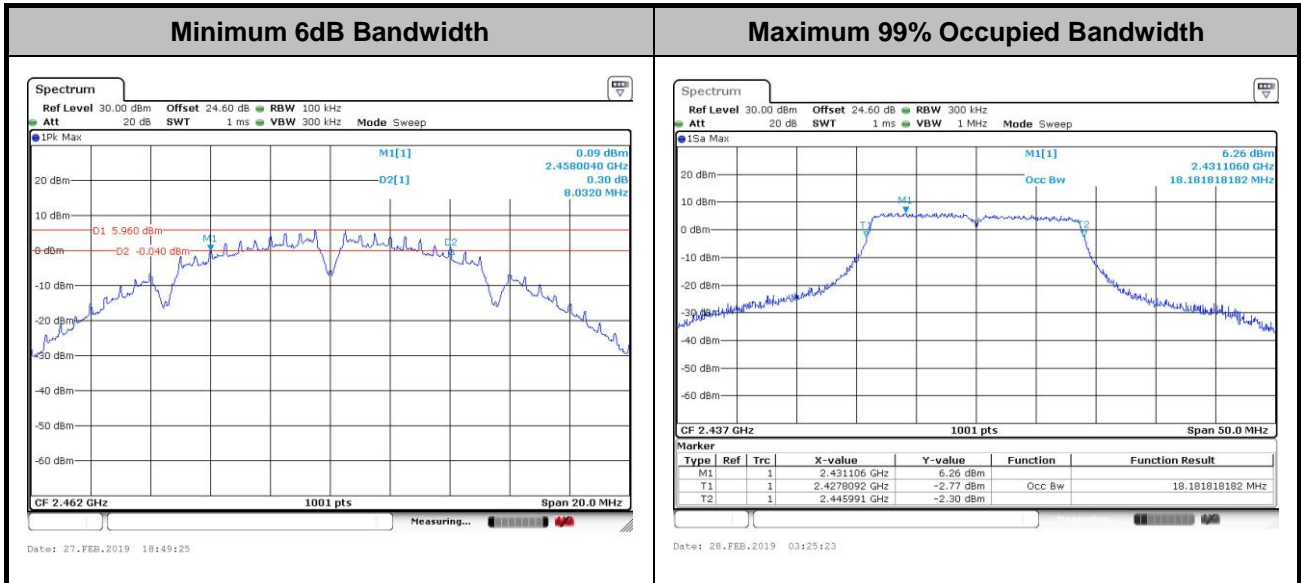

Note: The occupied channel bandwidth is maintained within the band of operation for all of the modulations.

## 3.2 Output Power Measurement

### 3.2.1 Limit of Output Power

For systems using digital modulation in the 2400-2483.5MHz, the limit for peak output power is 30dBm. If transmitting antenna with directional gain greater than 6dBi is used, the peak output power from the intentional radiator shall be reduced below the above stated value by the amount in dB that the directional gain of the antenna exceeds 6 dBi. In case of point-to-point operation, the limit has to be reduced by 1dB for every 3dB that the directional gain of the antenna exceeds 6dBi.

### 3.2.2 Measuring Instruments

See list of measuring equipment of this test report.

### 3.2.3 Test Procedures

1. For Average Power, the testing follows ANSI C63.10 Section 11.9.2.3.2 Method AVGPM-G.
2. The RF output of EUT was connected to the power meter by RF cable and attenuator. The path loss was compensated to the results for each measurement.
3. Set to the maximum power setting and enable the EUT transmit continuously.
4. Measure the conducted output power and record the results in the test report.
5. For MIMO mode, calculation method follows FCC KDB 662911 D01 Multiple Transmitter Output v02r01.

### 3.2.4 Test Setup

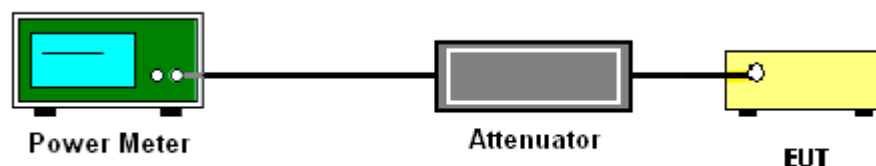

### 3.2.5 Test Result of Average output Power

Please refer to Appendix A.



### 3.3 Power Spectral Density Measurement

#### 3.3.1 Limit of Power Spectral Density

The peak power spectral density shall not be greater than 8dBm in any 3kHz band at any time interval of continuous transmission.

#### 3.3.2 Measuring Instruments

See list of measuring equipment of this test report.

#### 3.3.3 Test Procedures

1. The testing follows the ANSI C63.10 Section 11.10.2 Method PKPSD.
2. The RF output of EUT was connected to the spectrum analyzer by RF cable and attenuator. The path loss was compensated to the results for each measurement.
3. Set to the maximum power setting and enable the EUT transmit continuously.
4. Make the measurement with the spectrum analyzer's resolution bandwidth (RBW) = 3 kHz. Video bandwidth VBW = 10 kHz In order to make an accurate measurement, set the span to 1.5 times DTS Channel Bandwidth. (6dB BW)
5. Detector = peak, Sweep time = auto couple, Trace mode = max hold, Allow trace to fully stabilize. Use the peak marker function to determine the maximum power level.
6. Measure and record the results in the test report.
7. For MIMO mode, calculation method follows FCC KDB 662911 D01 Multiple Transmitter Output v02r01.

If measurements performed using method (2) plus  $10 \log(N)$  exceeds the emission limit, the test should choose method (1) before declaring that the device fails the emission limit.

Method (1): Measure and sum the spectra across the outputs.

The total final Power Spectral Density is from a device with 2 transmitter outputs. The spectrum measurements of the individual outputs are all performed with the same span and number of points, the spectrum value in the first spectral bin of output 1 is summed with that in the first spectral bin of output 2 to obtain the value for the first frequency bin of the summed spectrum.

Method (2): Measure and add  $10 \log(N)$  dB, where N is the number of outputs. (N=2)

### 3.3.4 Test Setup

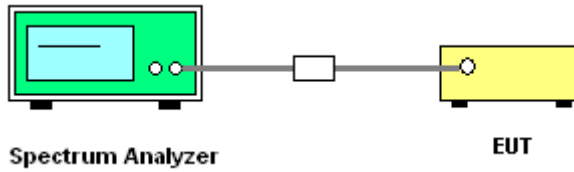

### 3.3.5 Test Result of Power Spectral Density

Please refer to Appendix A.

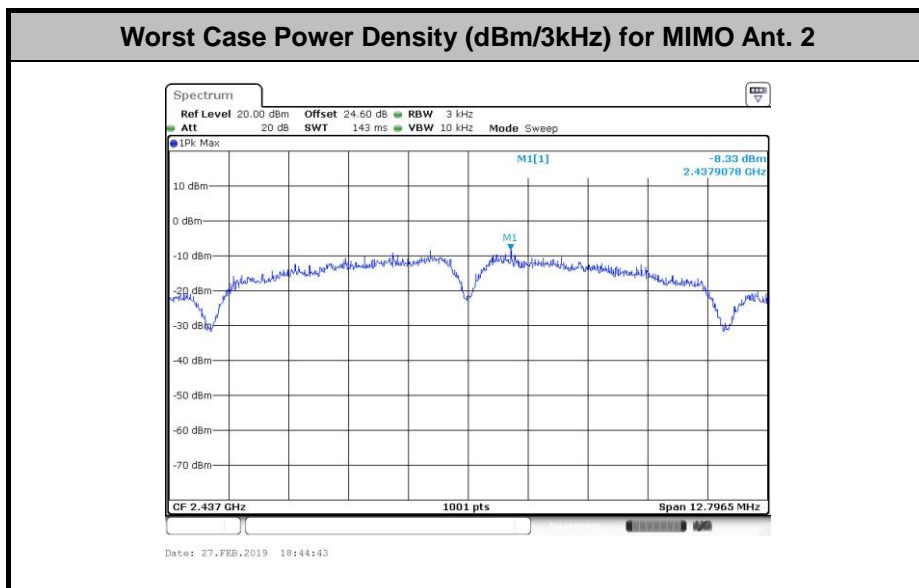
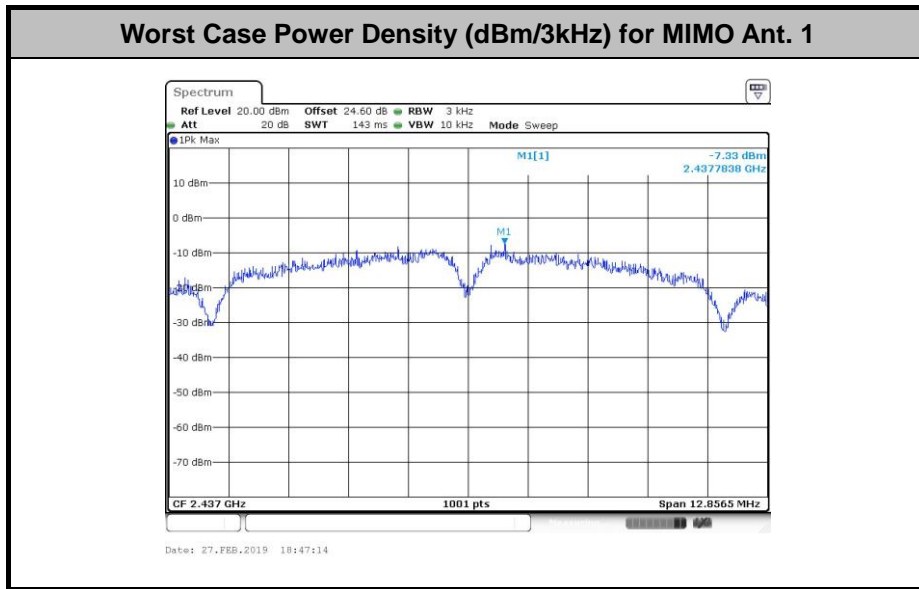

## 3.4 Conducted Band Edges and Spurious Emission Measurement

### 3.4.1 Limit of Conducted Band Edges and Spurious Emission Measurement

In any 100 kHz bandwidth outside of the authorized frequency band, the emissions which fall in the non-restricted bands shall be attenuated at least 20 dB / 30dB relative to the maximum PSD level in 100 kHz by RF conducted measurement.

### 3.4.2 Measuring Instruments

See list of measuring equipment of this test report.

### 3.4.3 Test Procedures

1. The testing follows the ANSI C63.10 Section 11.11.3 Emission level measurement.
2. The RF output of EUT was connected to the spectrum analyzer by RF cable and attenuator. The path loss was compensated to the results for each measurement.
3. Set to the maximum power setting and enable the EUT transmit continuously.
4. Set RBW = 100 kHz, VBW=300 kHz, Peak Detector. Unwanted Emissions measured in any 100 kHz bandwidth outside of the authorized frequency band shall be attenuated by at least 20 dB relative to the maximum in-band peak PSD level in 100 kHz when maximum peak conducted output power procedure is used. If the transmitter complies with the conducted power limits based on the use of RMS averaging over a time interval, the attenuation required under this paragraph shall be 30 dB instead of 20 dB per 15.247(d).
5. Measure and record the results in the test report.
6. The RF fundamental frequency should be excluded against the limit line in the operating frequency band.

### 3.4.4 Test Setup

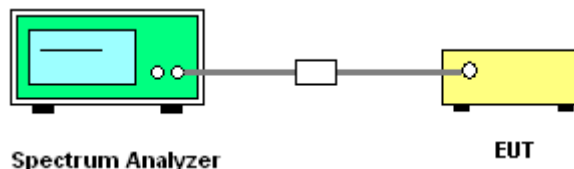



3.4.5 Test Result of Conducted Band Edges and Spurious Emission

|                 |  |                     |         |
|-----------------|--|---------------------|---------|
| Test Engineer : | Shiming Liu, Howard Lin, Kai Liao, and Tommy Lee | Temperature :       | 21~25°C |
|                 |  | Relative Humidity : | 51~54%  |

Number of TX = 2, Ant. 1 (Measured)

|             |         |                |    |
|-------------|---------|----------------|----|
| Test Mode : | 802.11b | Test Channel : | 01 |
|-------------|---------|----------------|----|

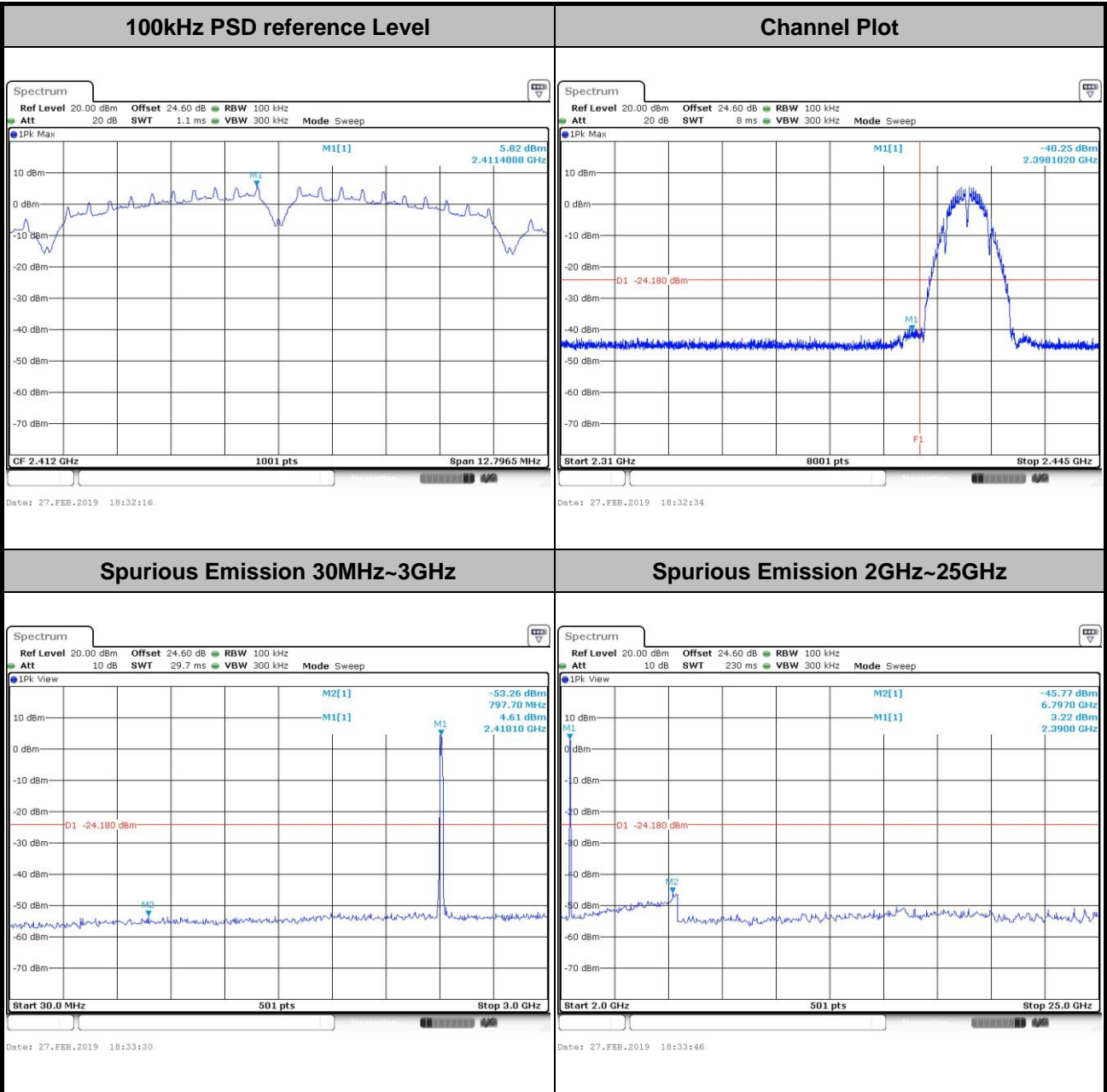





Test Mode : 802.11b Test Channel : 06

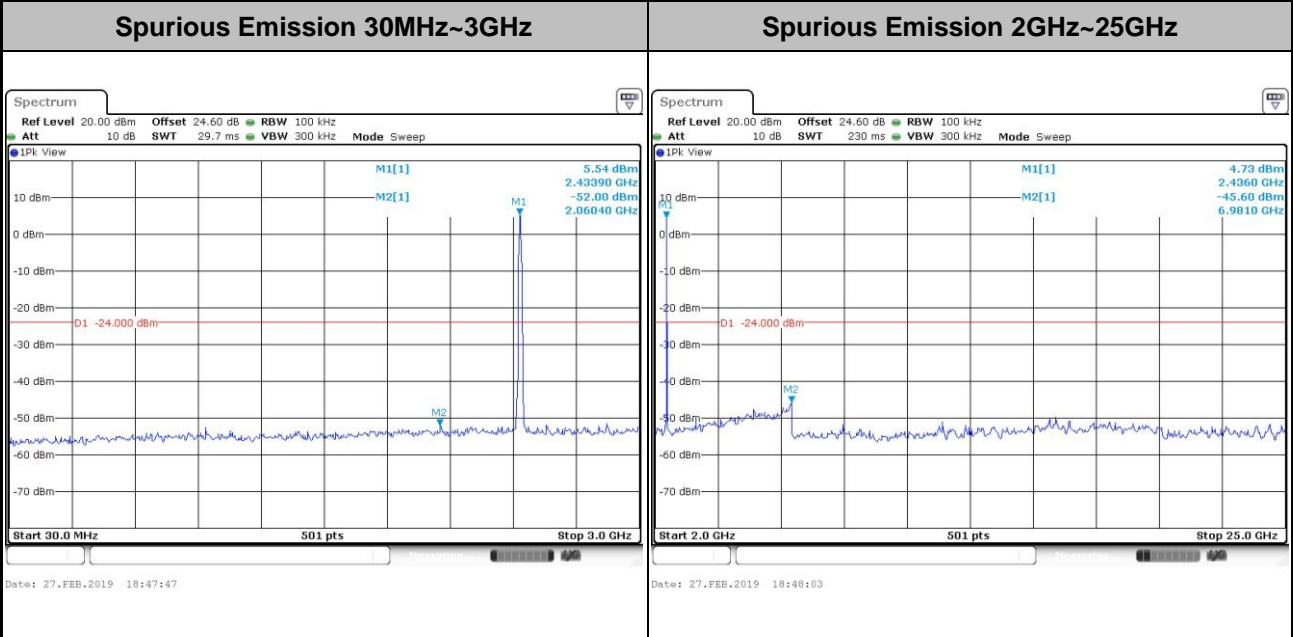
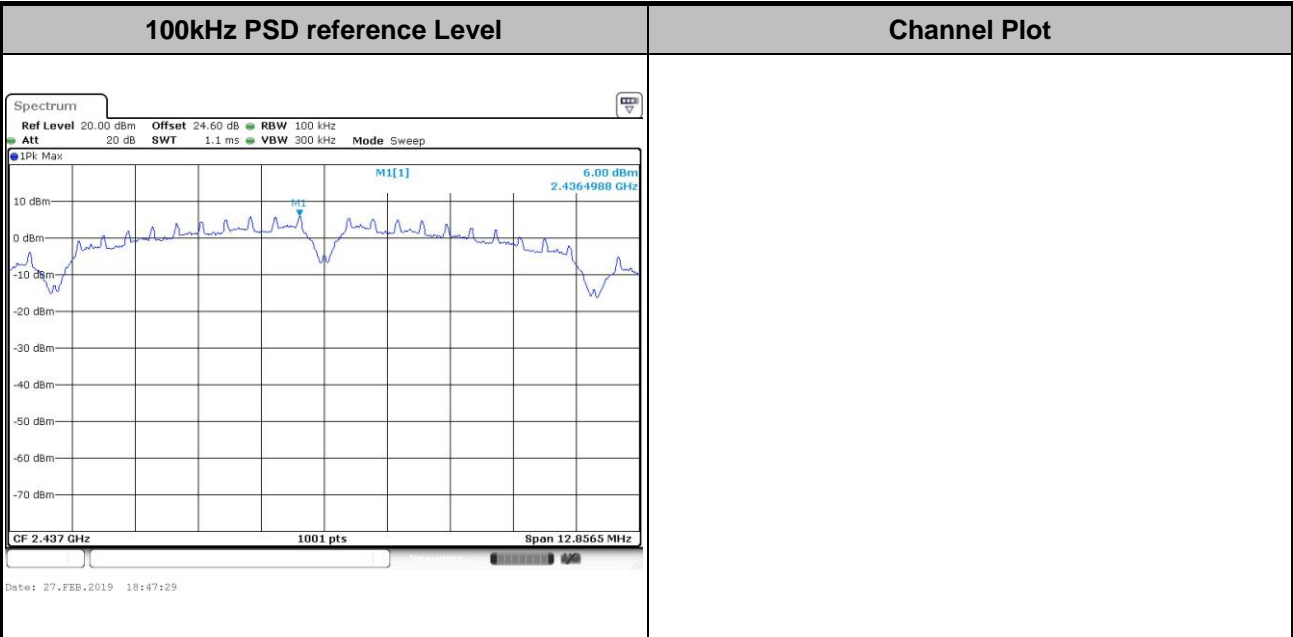



|             |         |                |    |
|-------------|---------|----------------|----|
| Test Mode : | 802.11b | Test Channel : | 11 |
|-------------|---------|----------------|----|

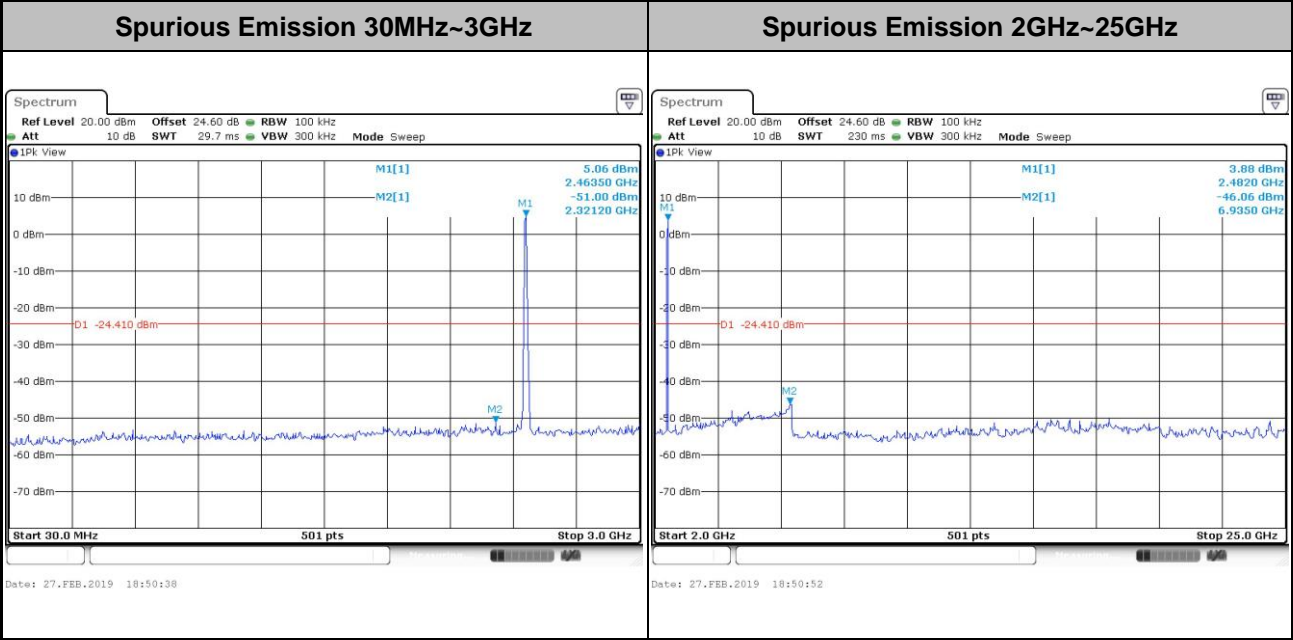
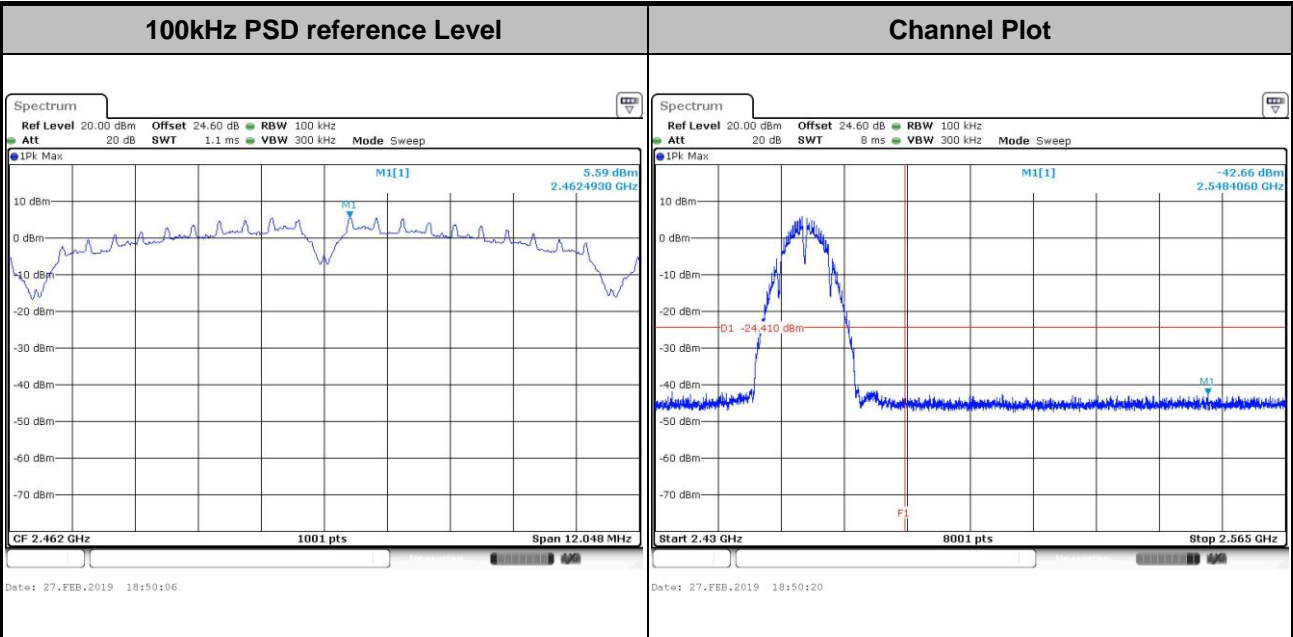



|             |         |                |    |
|-------------|---------|----------------|----|
| Test Mode : | 802.11b | Test Channel : | 12 |
|-------------|---------|----------------|----|

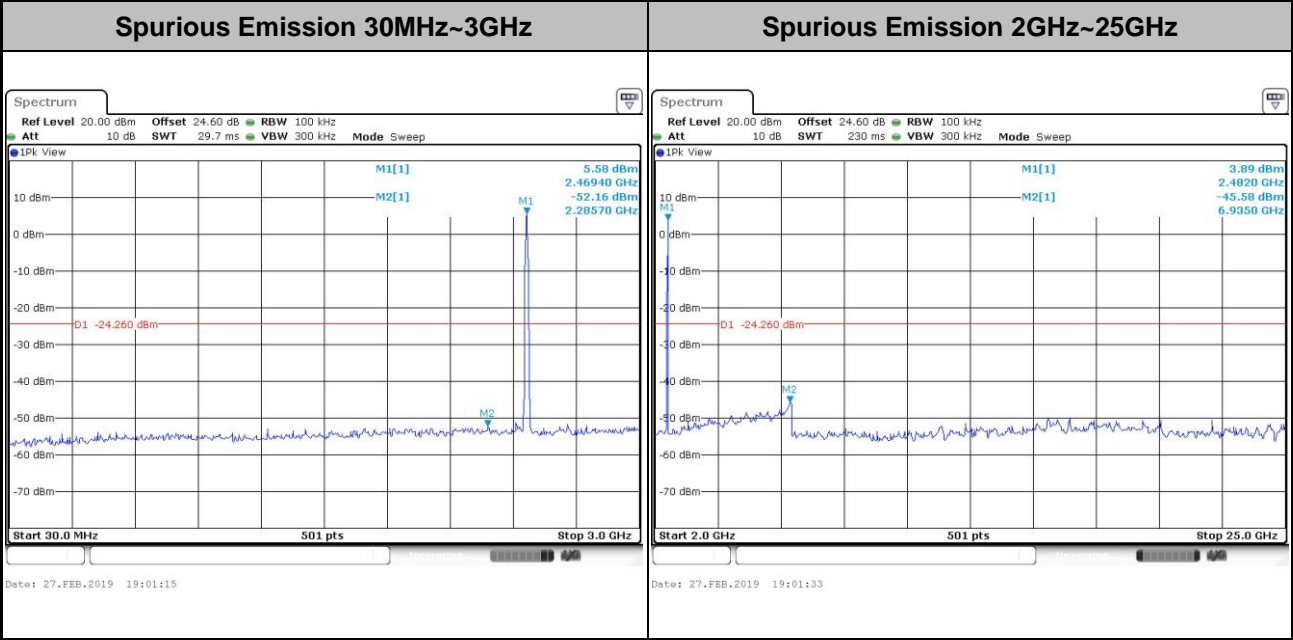
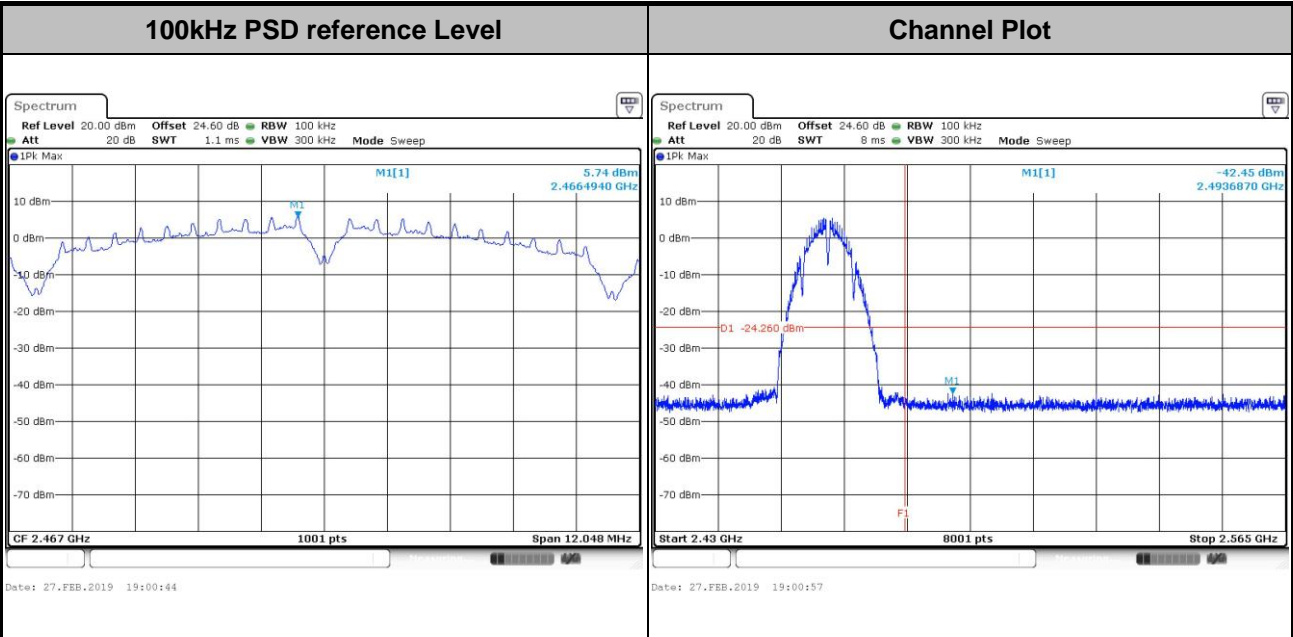



Test Mode : 802.11b      Test Channel : 13

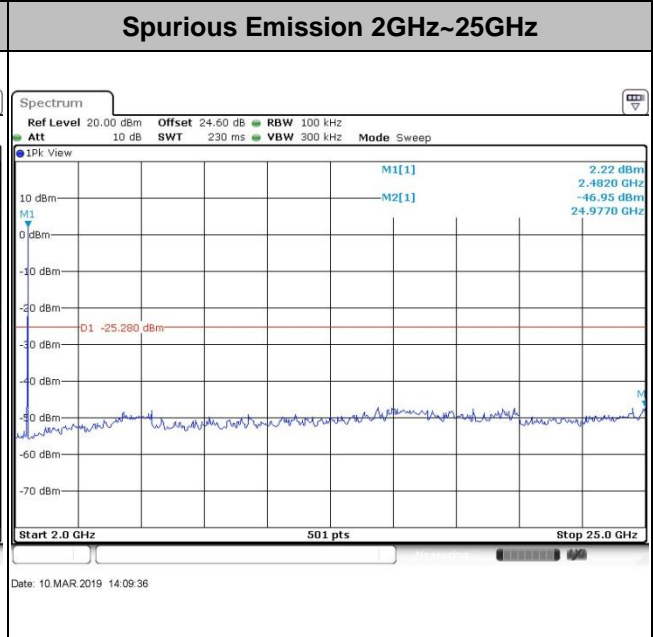
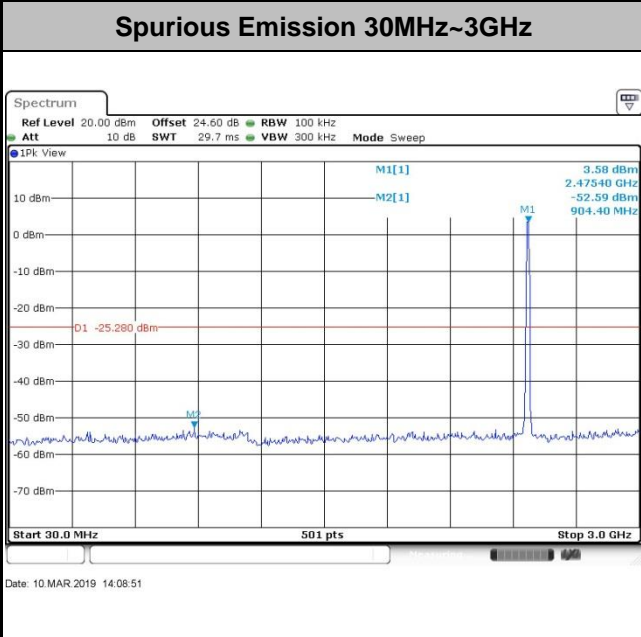
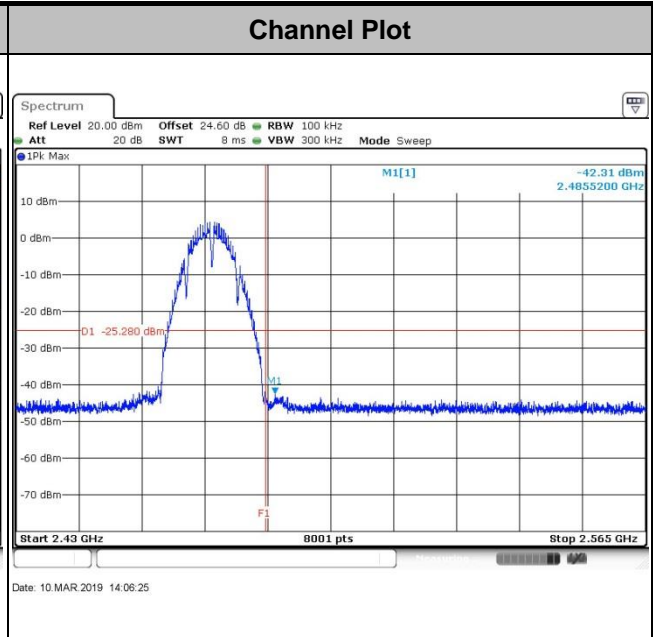
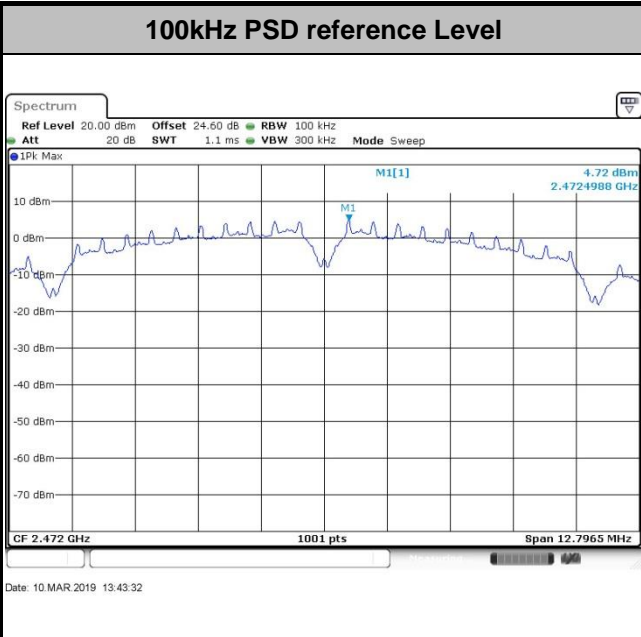



Test Mode : 802.11g Test Channel : 01

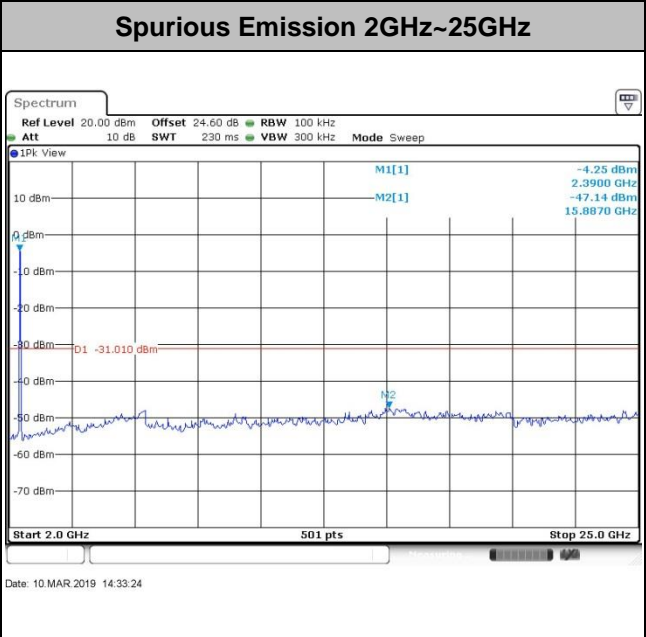
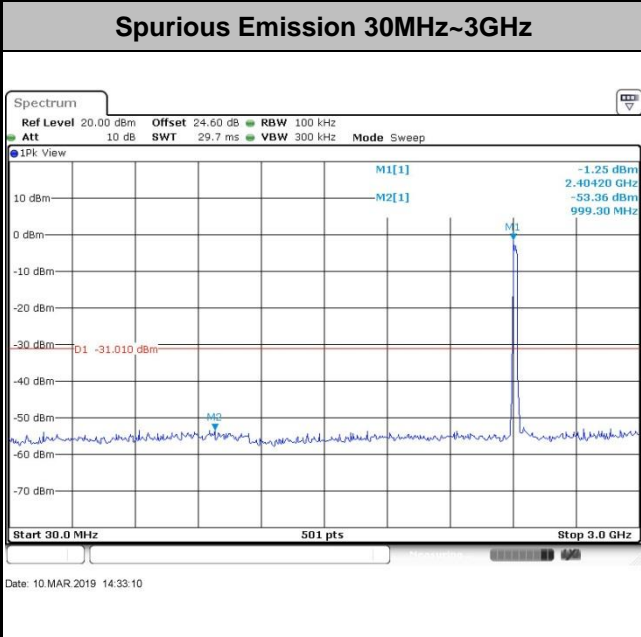
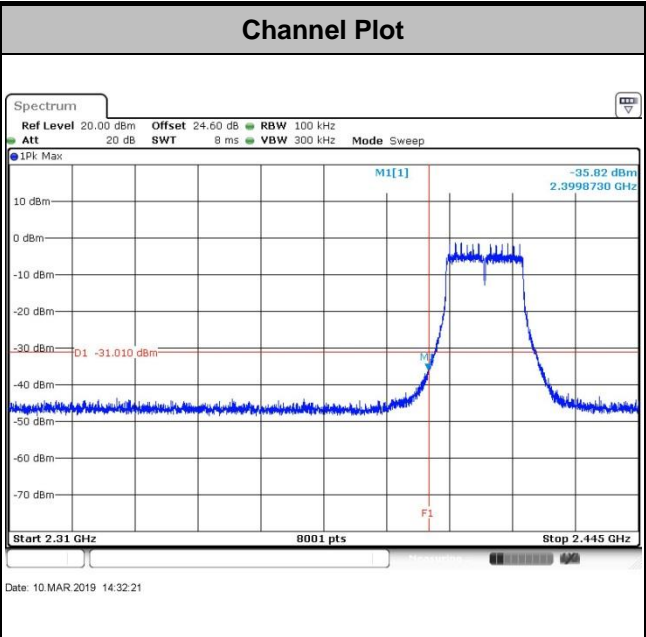
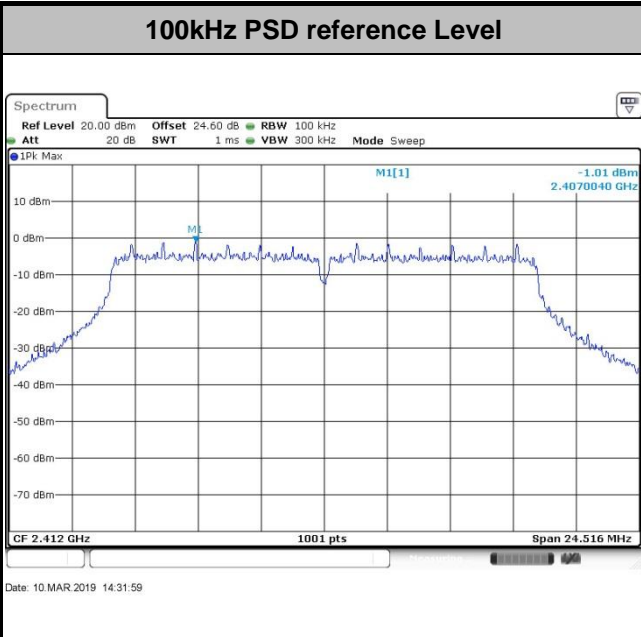



|             |         |                |    |
|-------------|---------|----------------|----|
| Test Mode : | 802.11g | Test Channel : | 06 |
|-------------|---------|----------------|----|

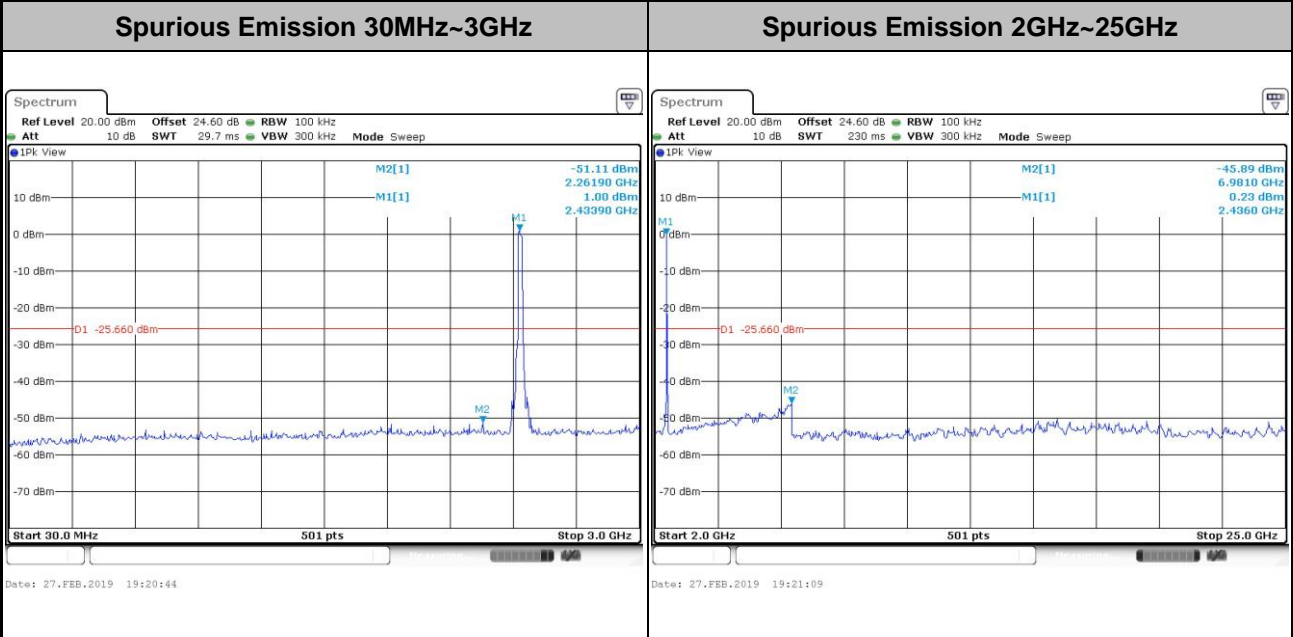
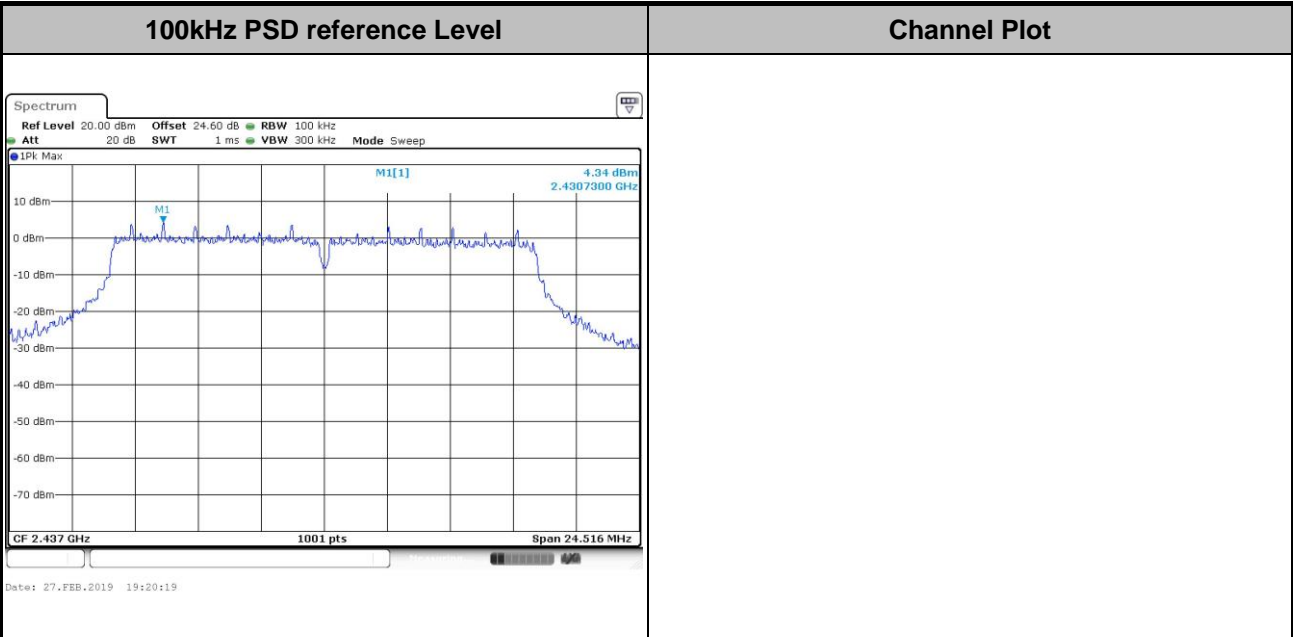



Test Mode : 802.11g      Test Channel : 11

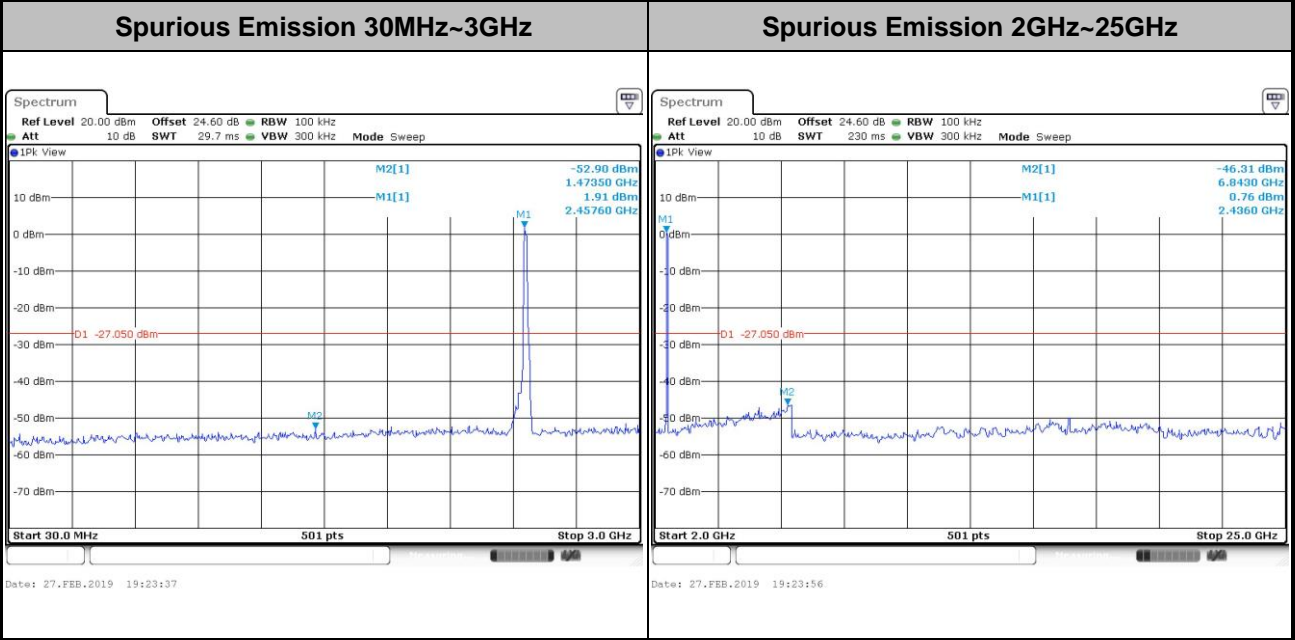
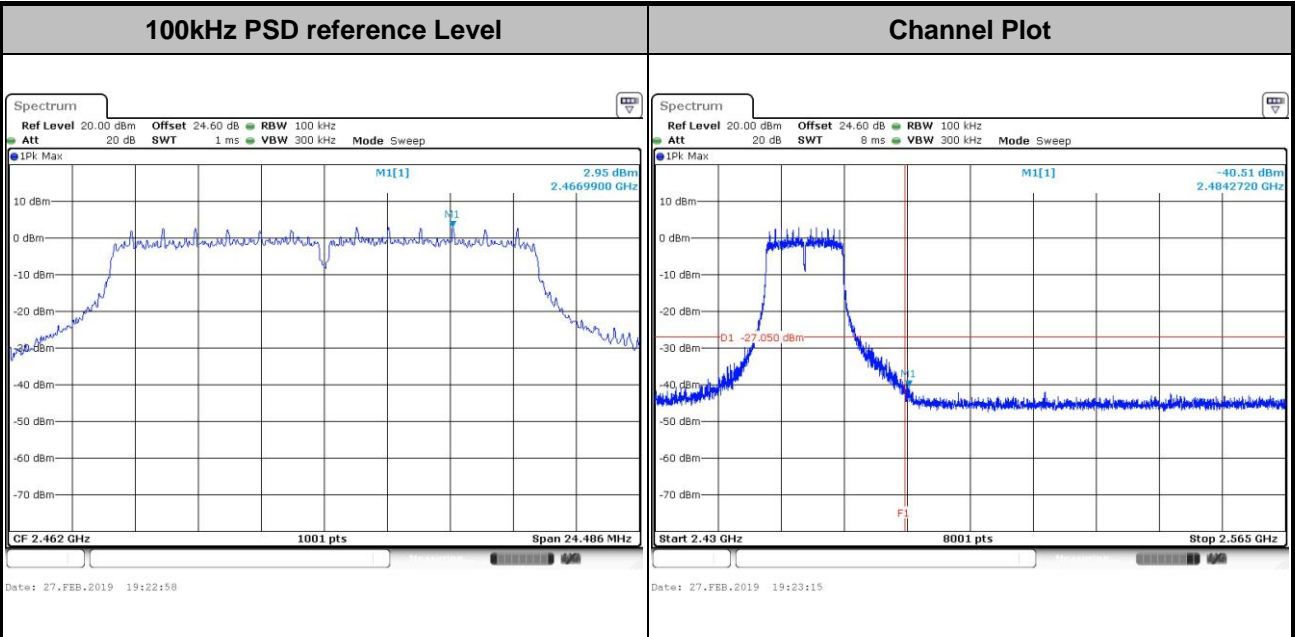



|             |         |                |    |
|-------------|---------|----------------|----|
| Test Mode : | 802.11g | Test Channel : | 12 |
|-------------|---------|----------------|----|

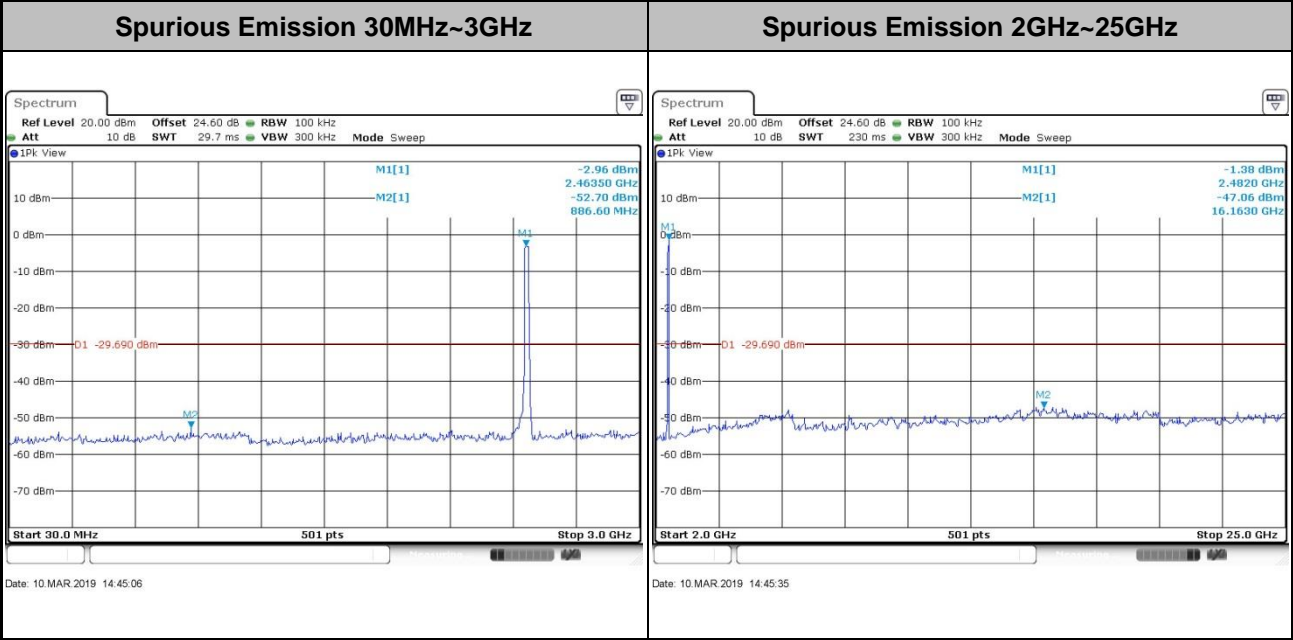
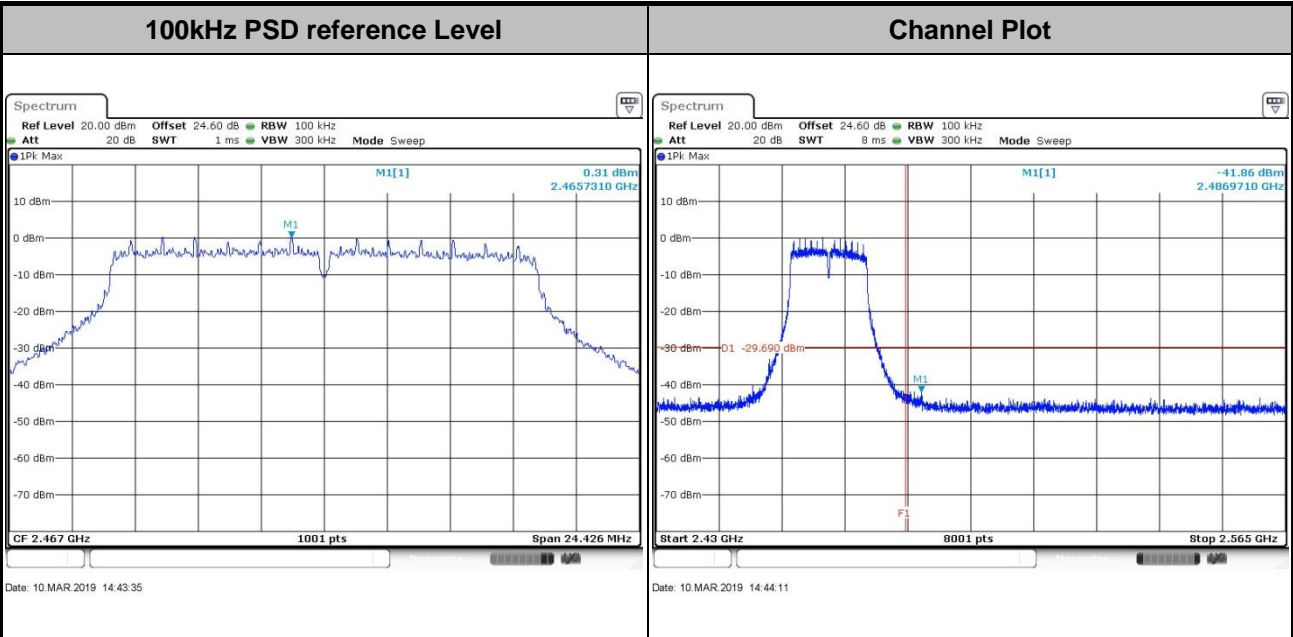





|             |         |                |    |
|-------------|---------|----------------|----|
| Test Mode : | 802.11g | Test Channel : | 13 |
|-------------|---------|----------------|----|

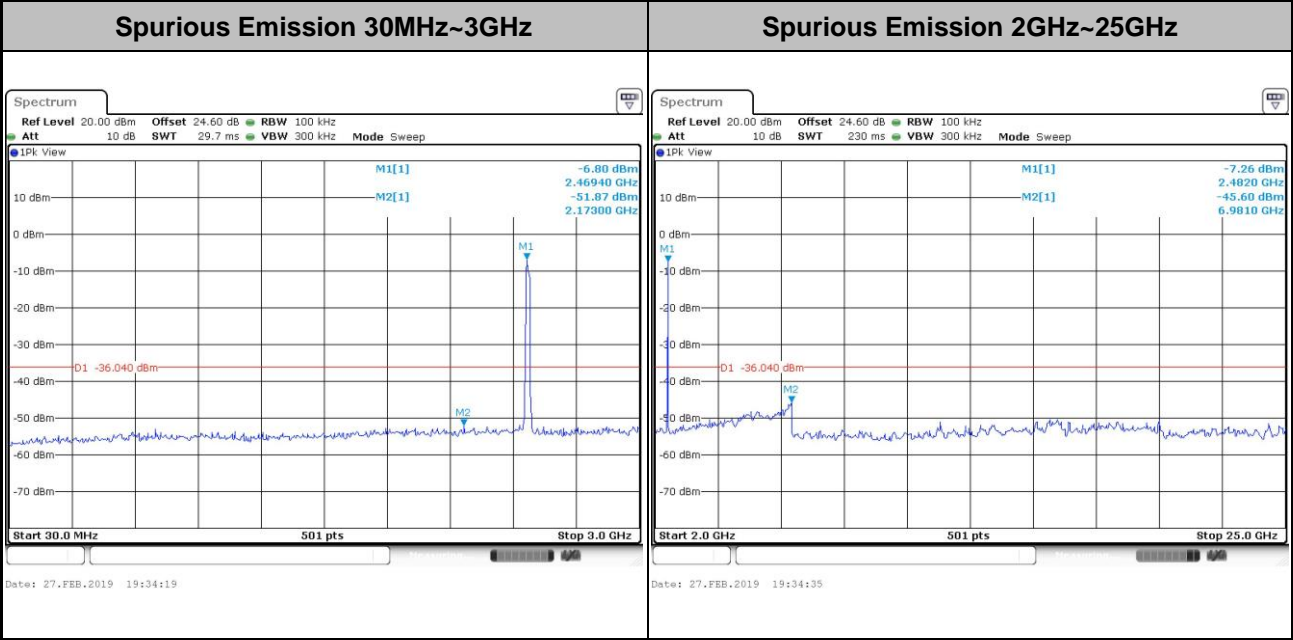
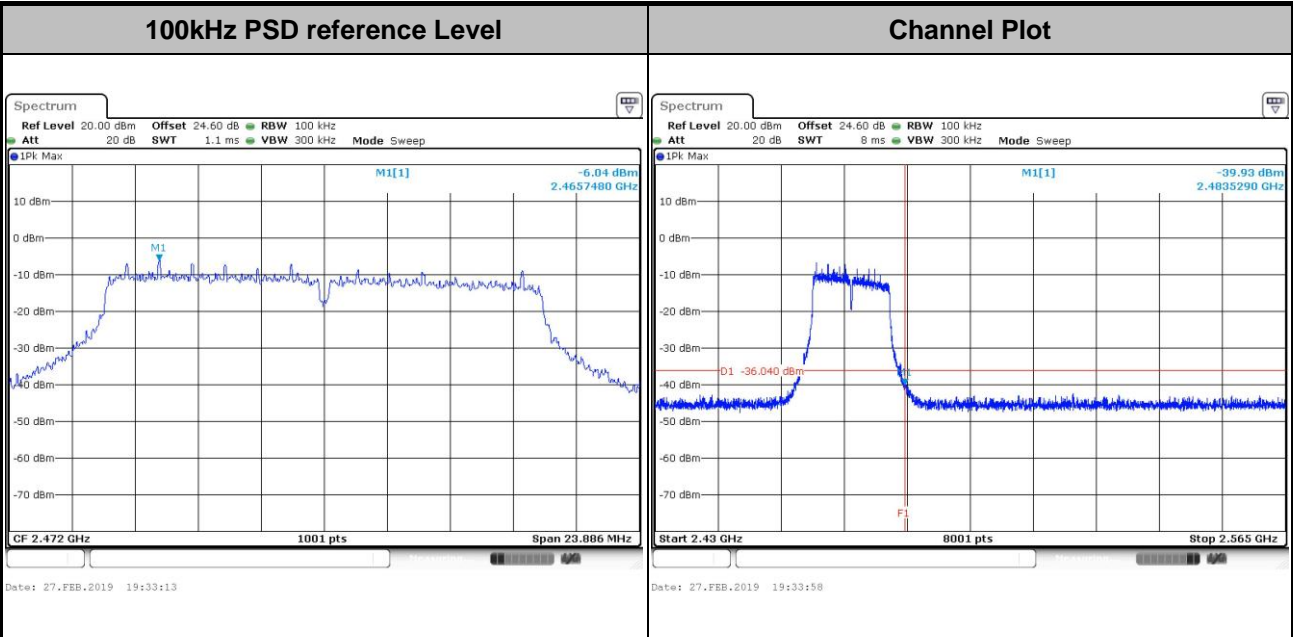



Test Mode : 802.11n HT20 Test Channel : 01

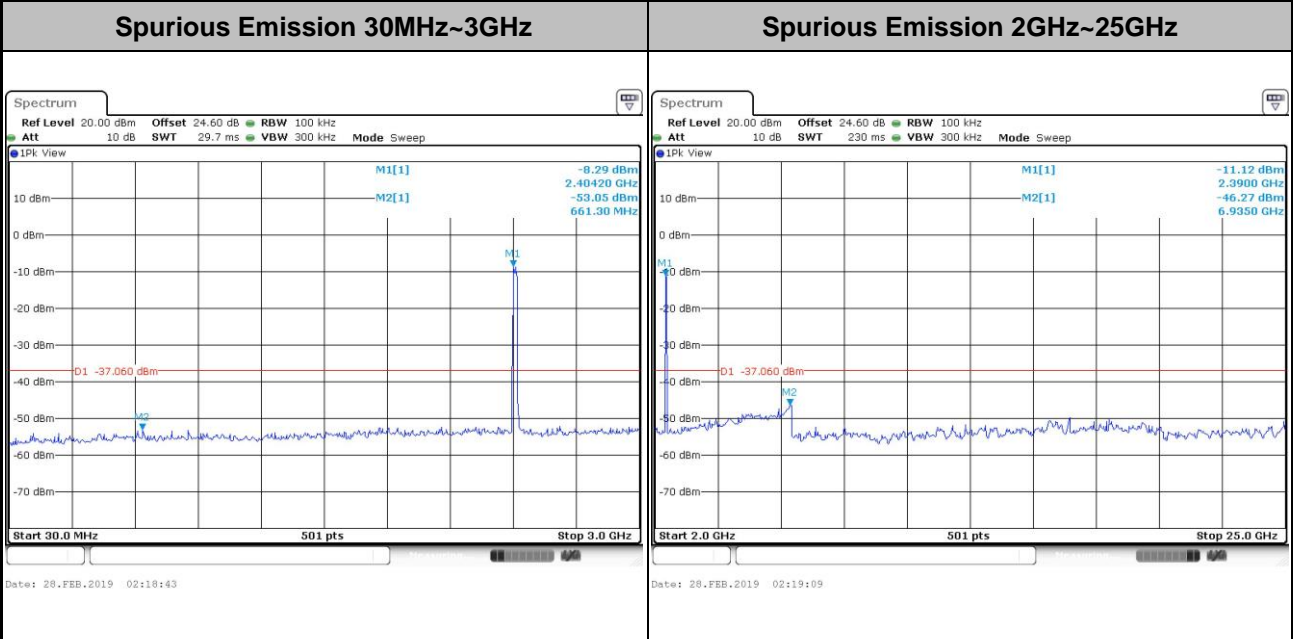
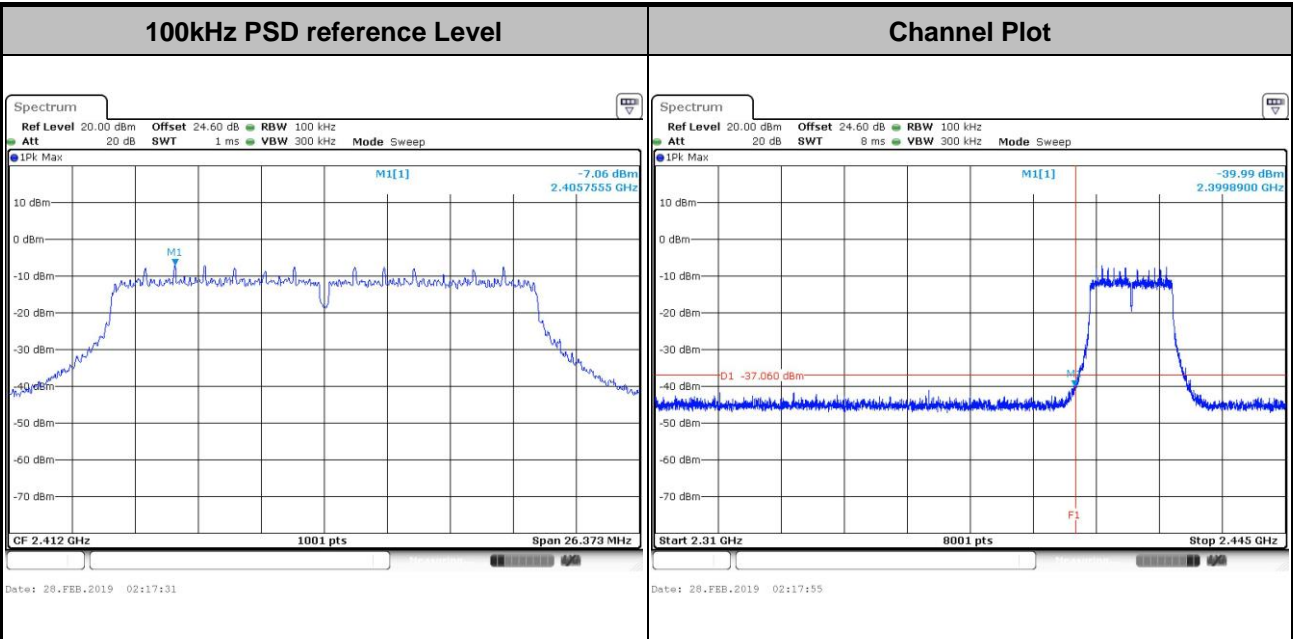



|             |              |                |    |
|-------------|--------------|----------------|----|
| Test Mode : | 802.11n HT20 | Test Channel : | 06 |
|-------------|--------------|----------------|----|

|                                   |                     |
|-----------------------------------|---------------------|
| <b>100kHz PSD reference Level</b> | <b>Channel Plot</b> |
|-----------------------------------|---------------------|

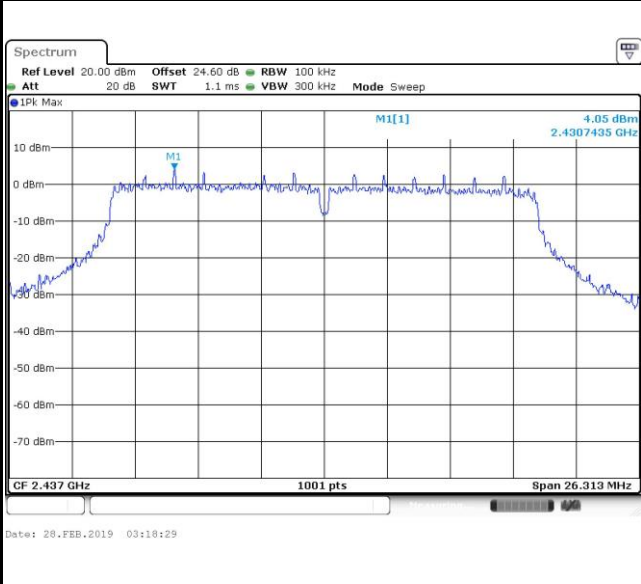

|                                     |                                     |
|-------------------------------------|-------------------------------------|
| <b>Spurious Emission 30MHz~3GHz</b> | <b>Spurious Emission 2GHz~25GHz</b> |
|-------------------------------------|-------------------------------------|

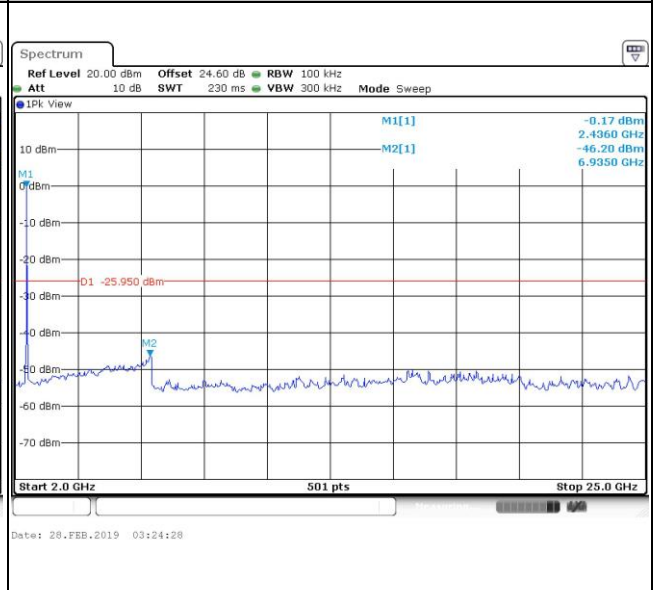
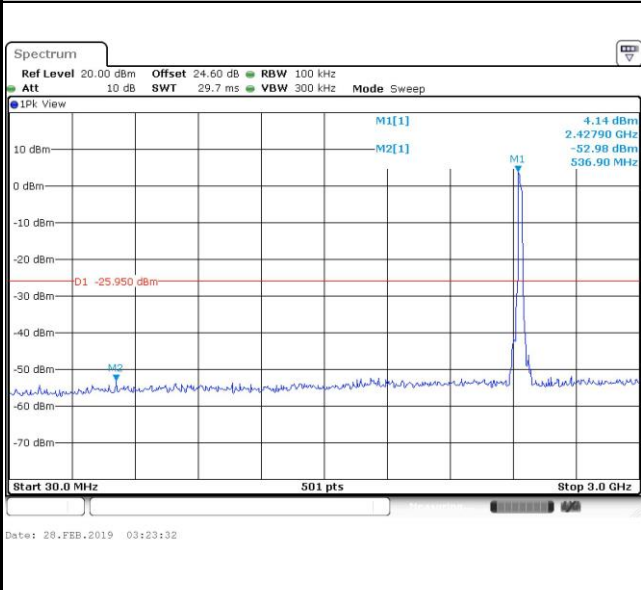



|             |              |                |    |
|-------------|--------------|----------------|----|
| Test Mode : | 802.11n HT20 | Test Channel : | 11 |
|-------------|--------------|----------------|----|

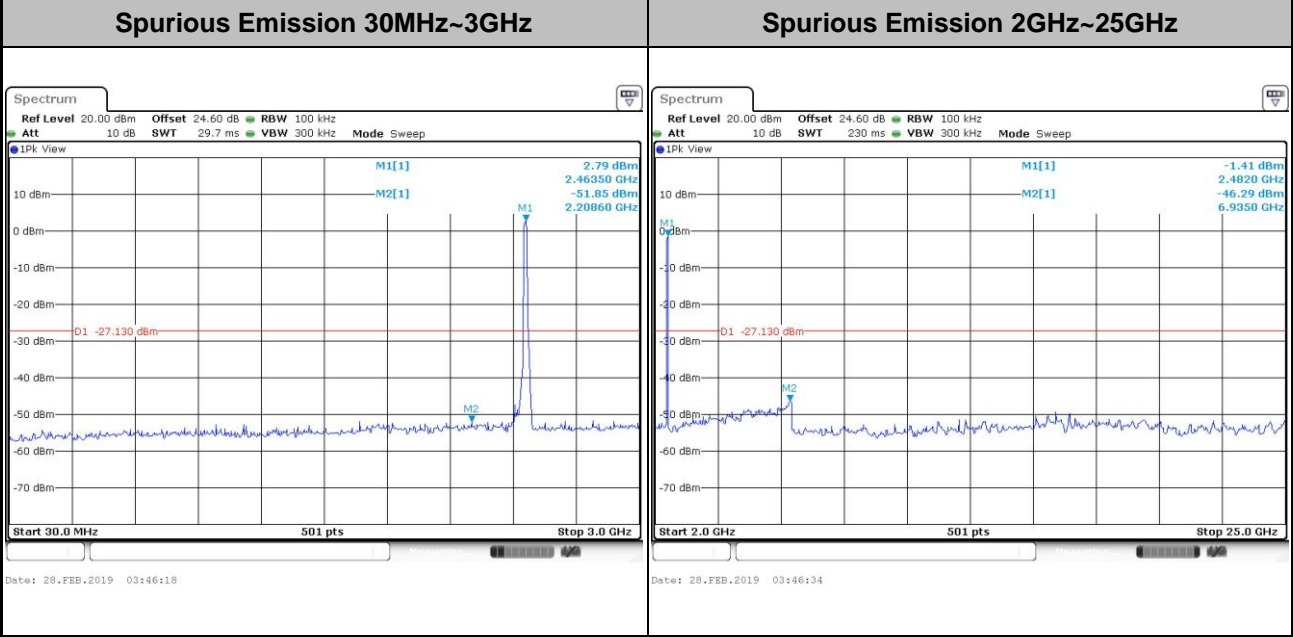
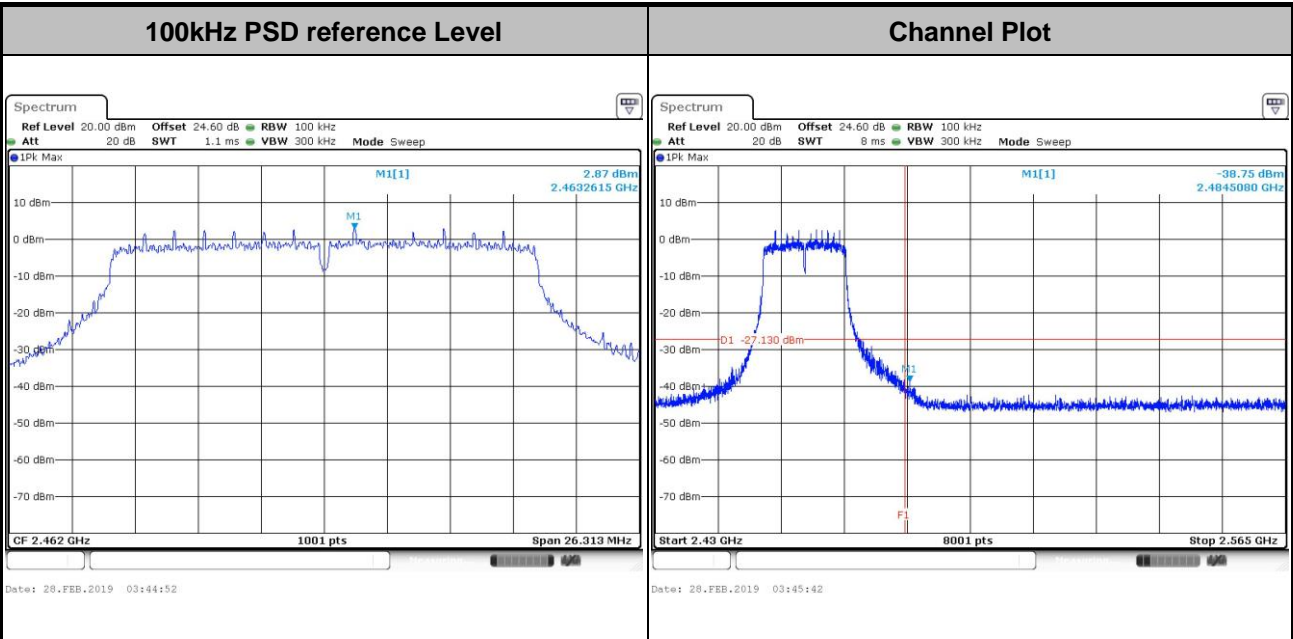



|             |              |                |    |
|-------------|--------------|----------------|----|
| Test Mode : | 802.11n HT20 | Test Channel : | 12 |
|-------------|--------------|----------------|----|

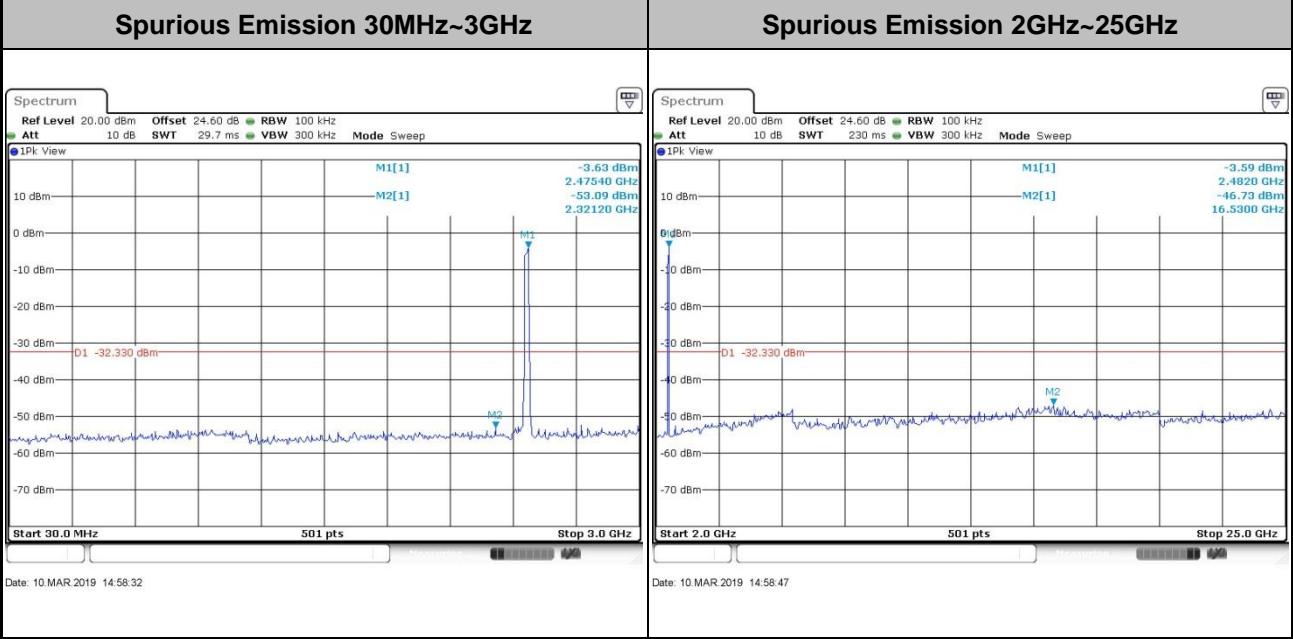
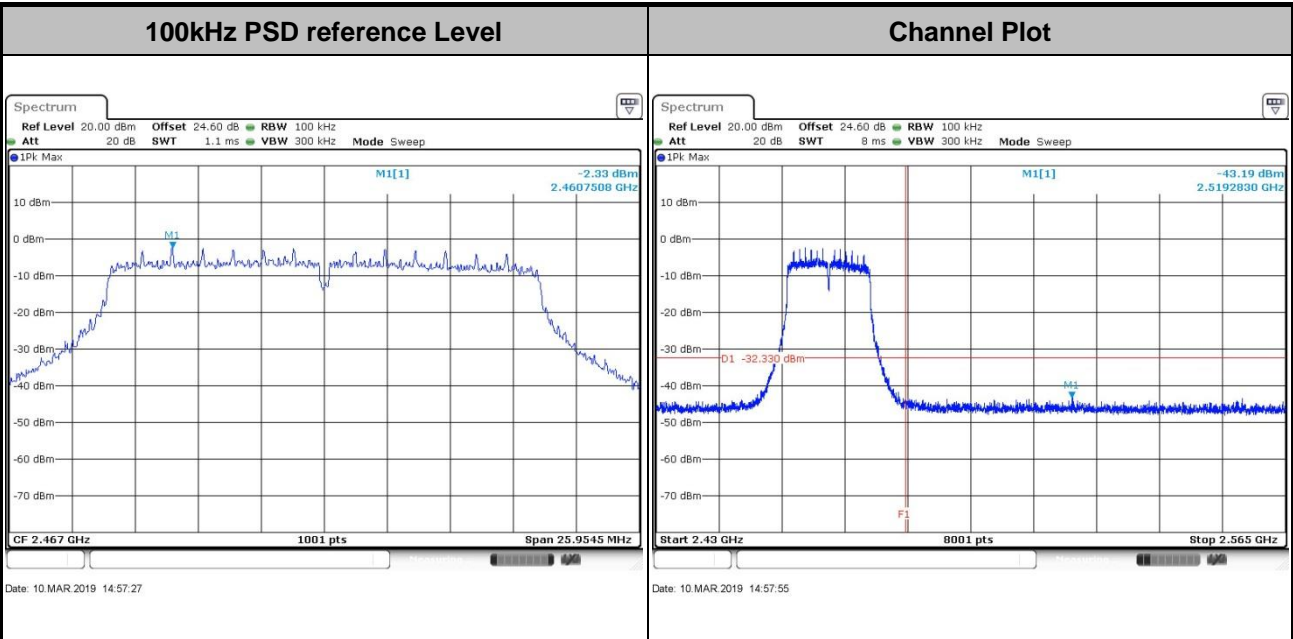



Test Mode : 802.11n HT20 Test Channel : 13

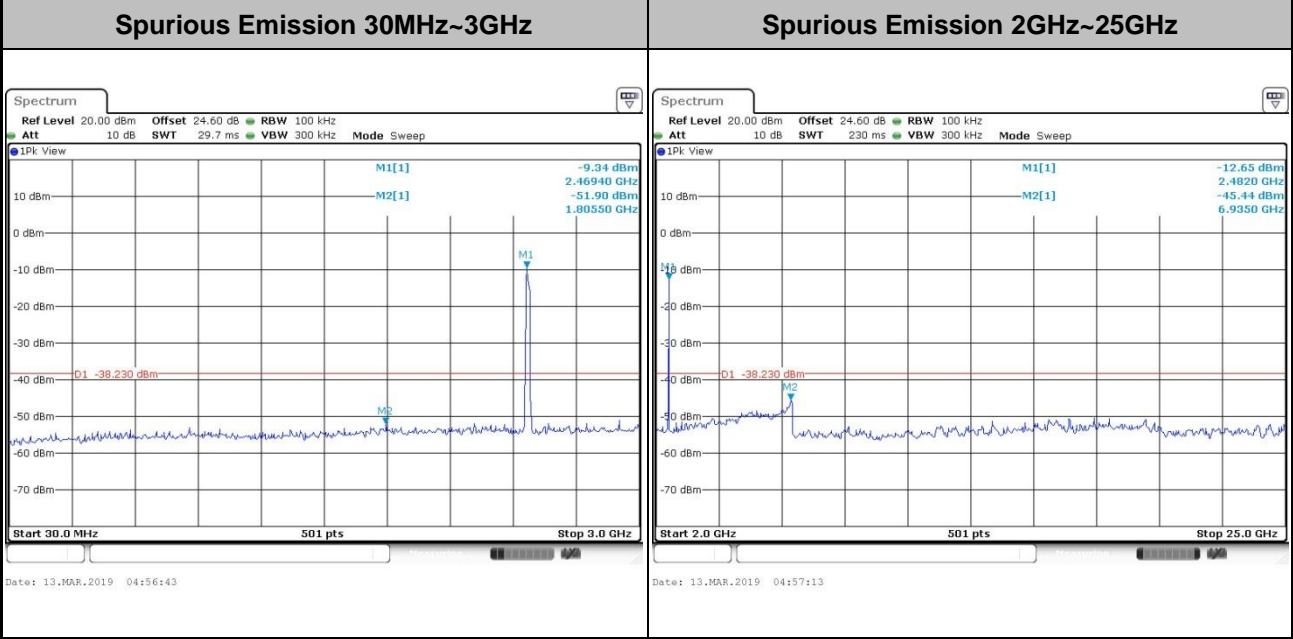
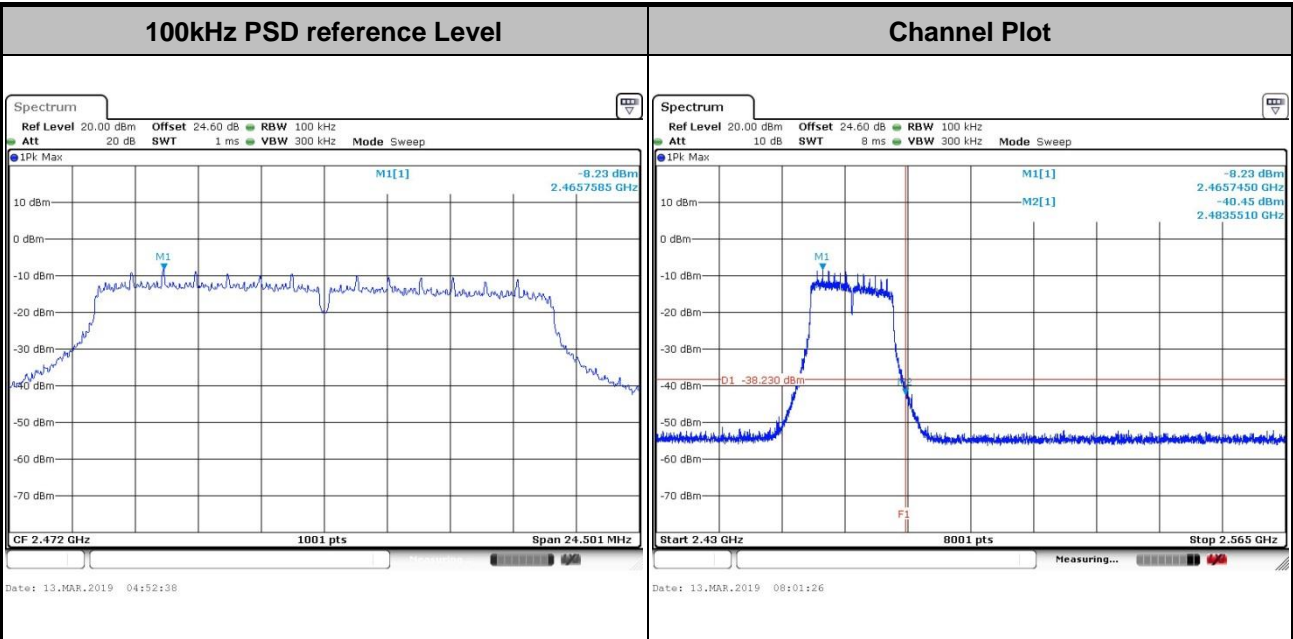



Number of TX = 2, Ant. 2 (Measured)

|             |         |                |    |
|-------------|---------|----------------|----|
| Test Mode : | 802.11b | Test Channel : | 01 |
|-------------|---------|----------------|----|

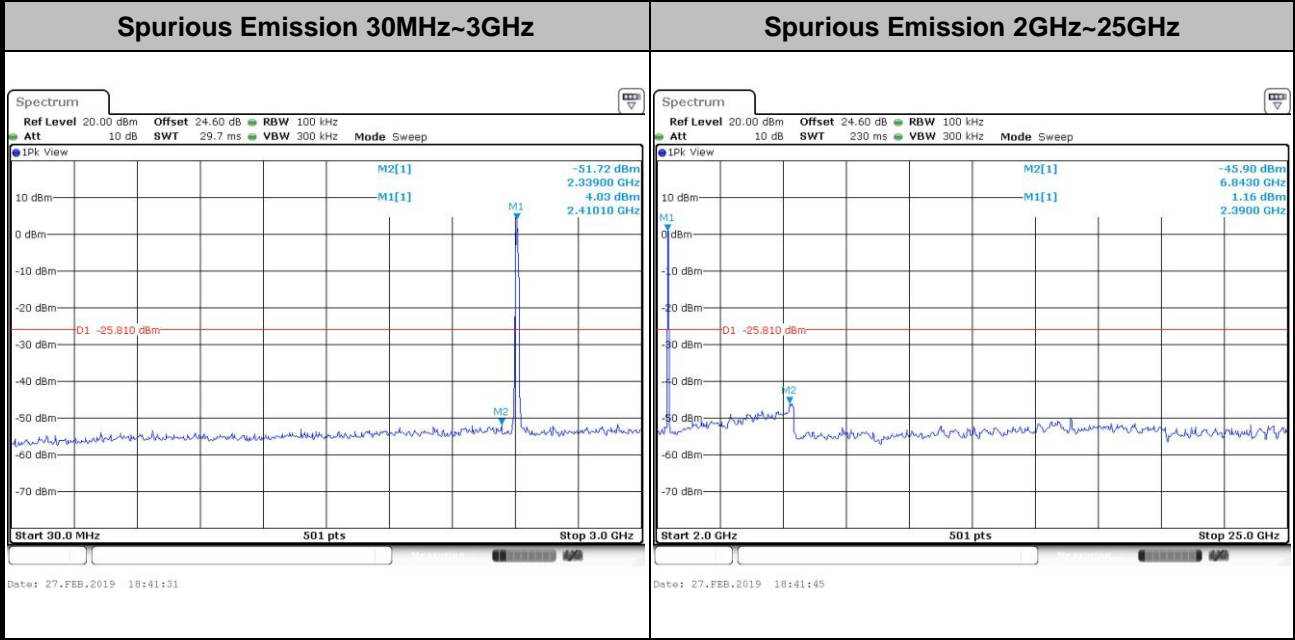
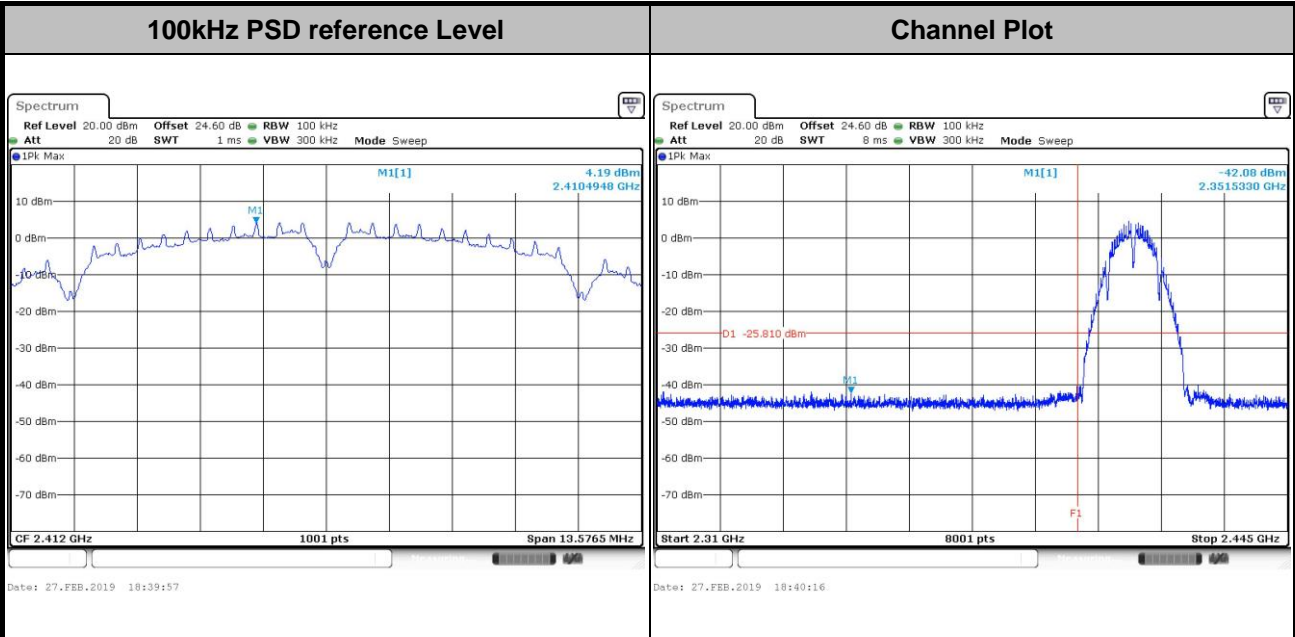



|             |         |                |    |
|-------------|---------|----------------|----|
| Test Mode : | 802.11b | Test Channel : | 06 |
|-------------|---------|----------------|----|

|                                   |                     |
|-----------------------------------|---------------------|
| <b>100kHz PSD reference Level</b> | <b>Channel Plot</b> |
|-----------------------------------|---------------------|

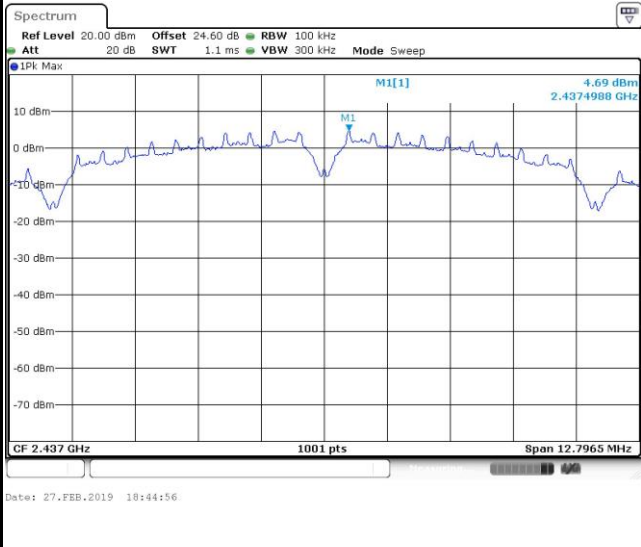

**Spurious Emission 30MHz~3GHz**

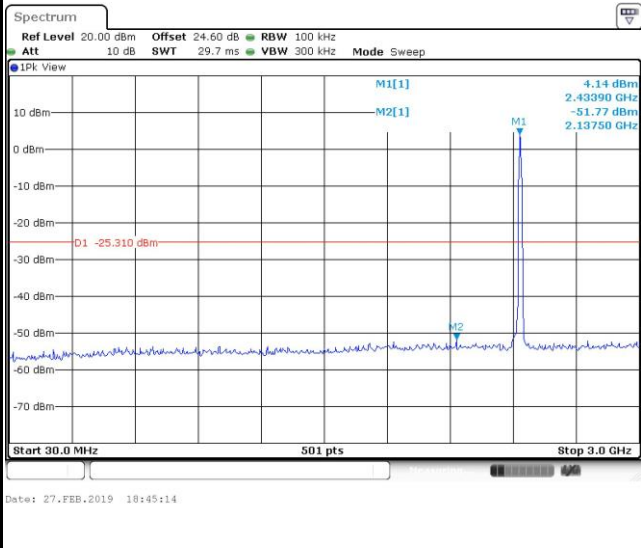

**Spurious Emission 2GHz~25GHz**

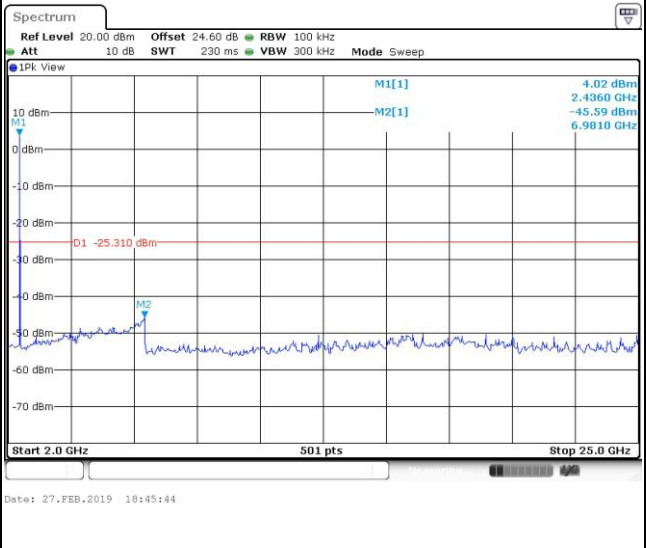





|             |         |                |    |
|-------------|---------|----------------|----|
| Test Mode : | 802.11b | Test Channel : | 11 |
|-------------|---------|----------------|----|

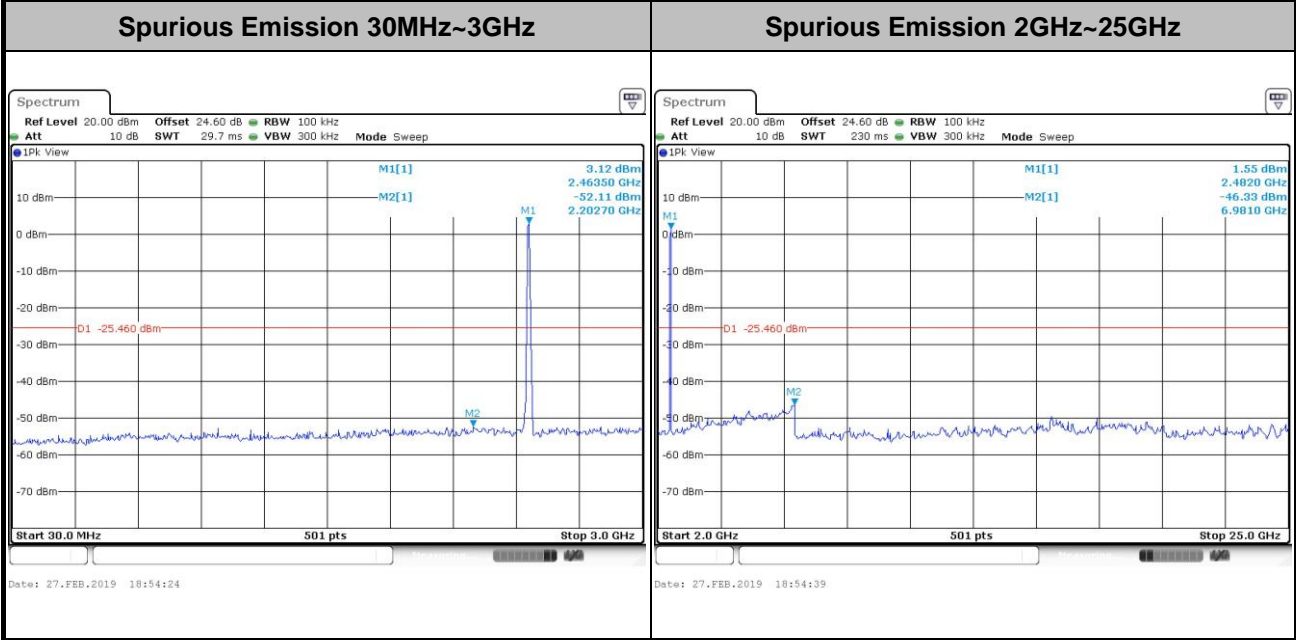
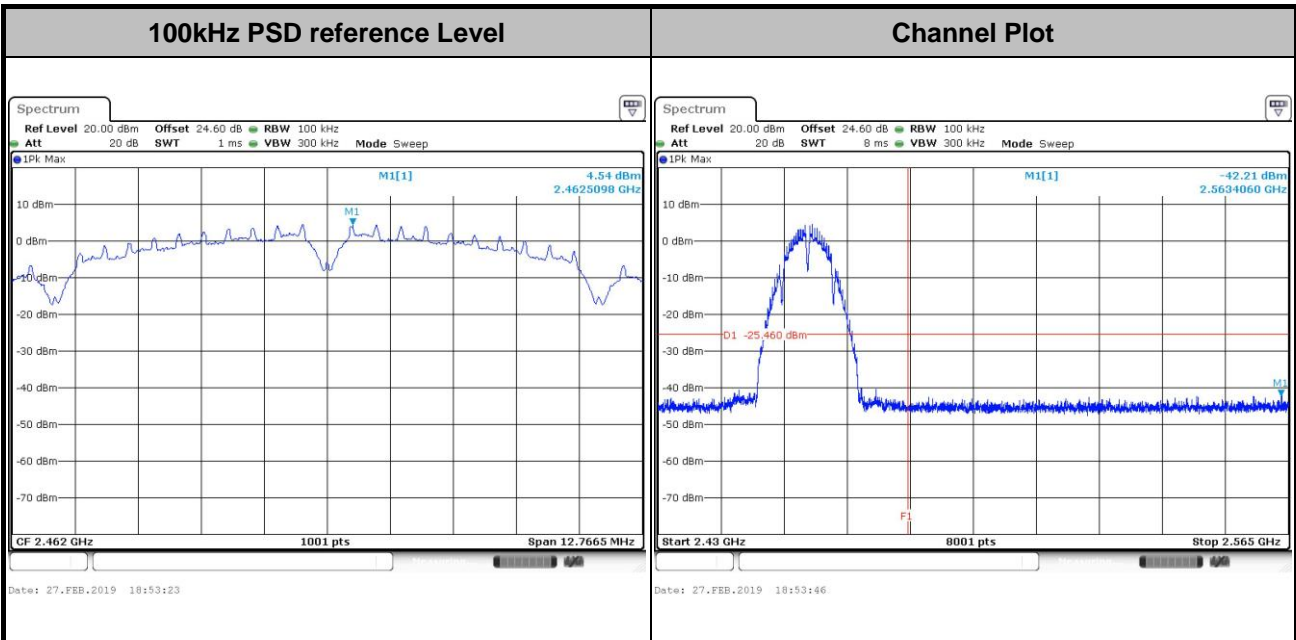



|             |         |                |    |
|-------------|---------|----------------|----|
| Test Mode : | 802.11b | Test Channel : | 12 |
|-------------|---------|----------------|----|

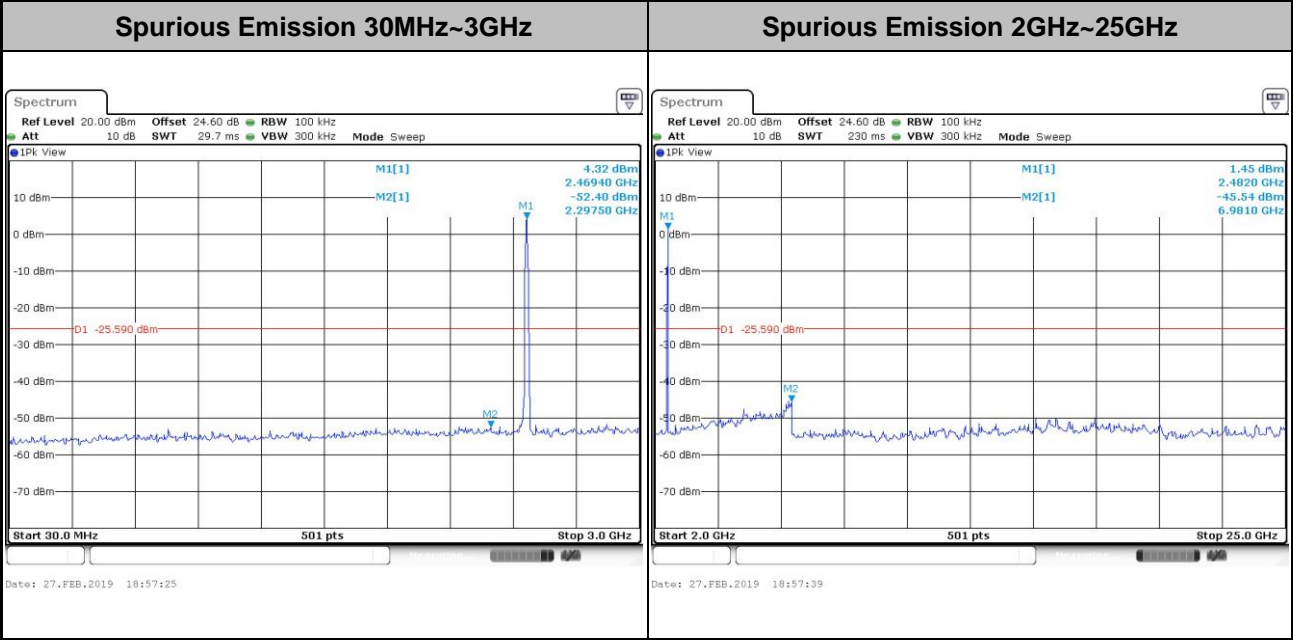
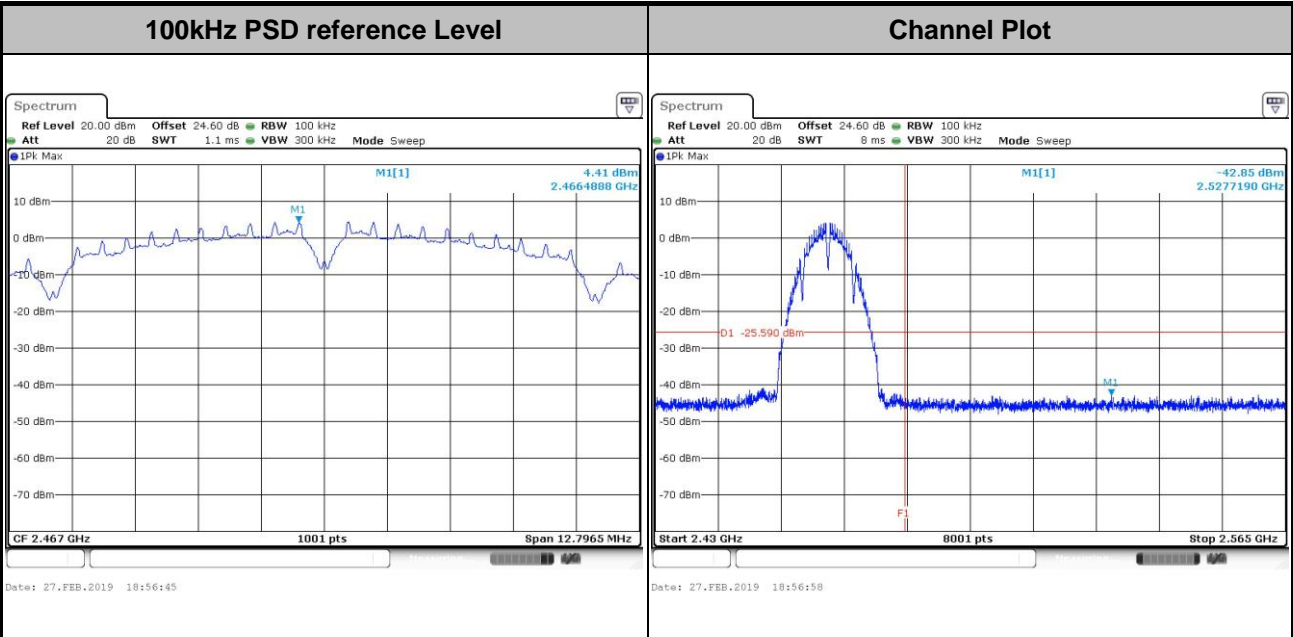



|             |         |                |    |
|-------------|---------|----------------|----|
| Test Mode : | 802.11b | Test Channel : | 13 |
|-------------|---------|----------------|----|

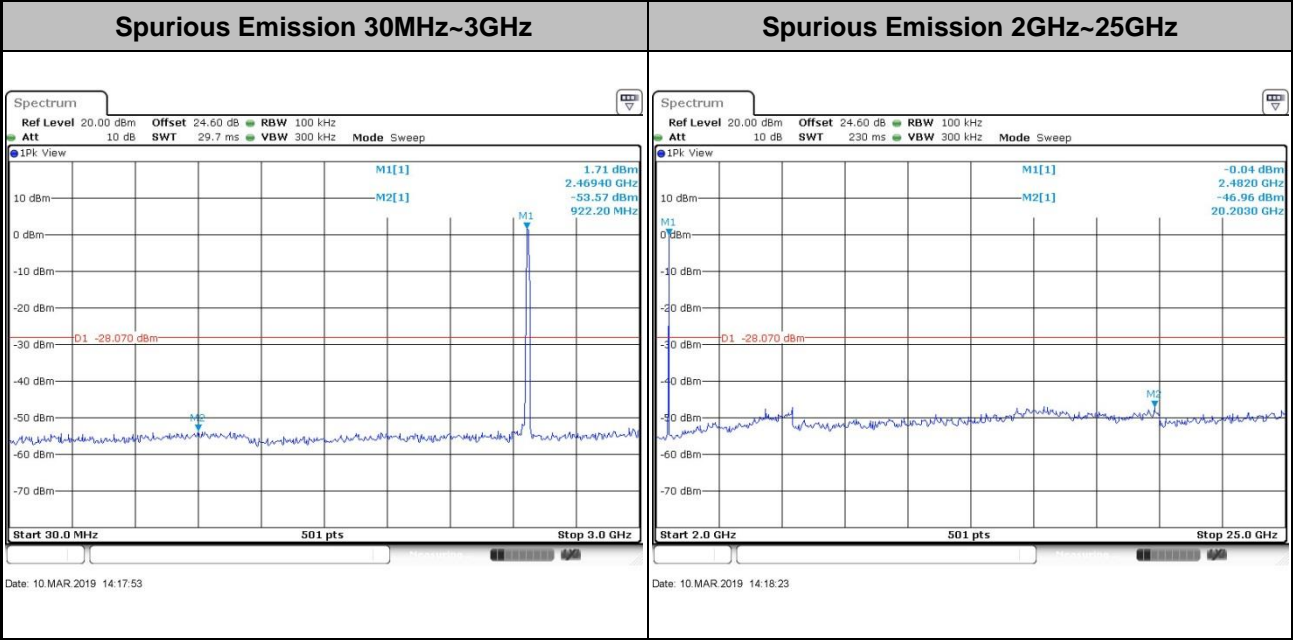
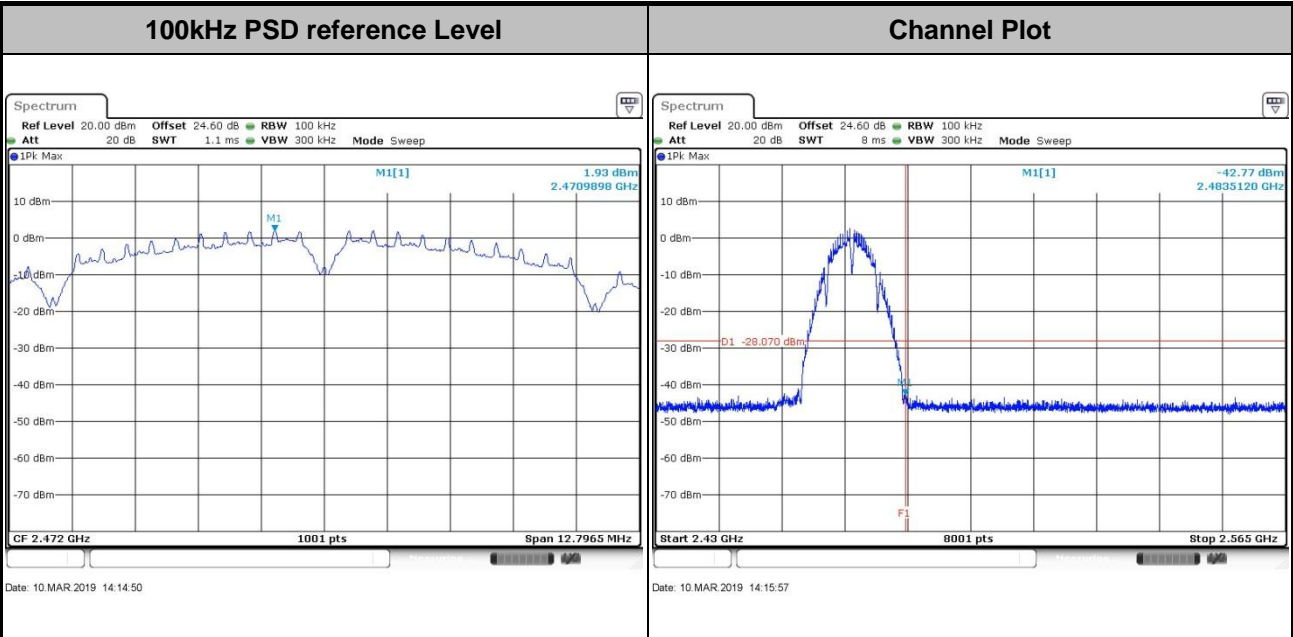



Test Mode : 802.11g Test Channel : 01

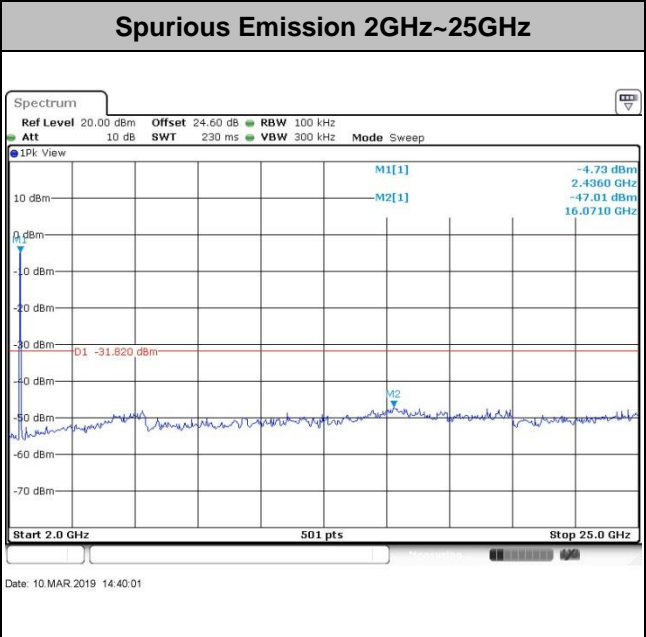
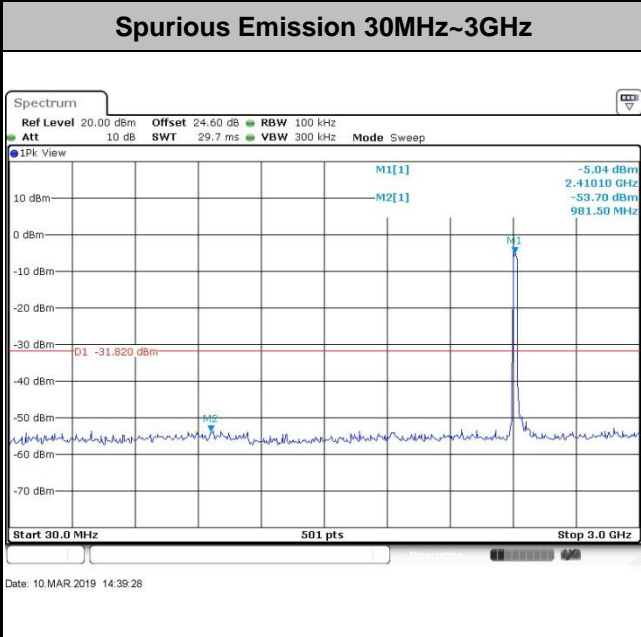
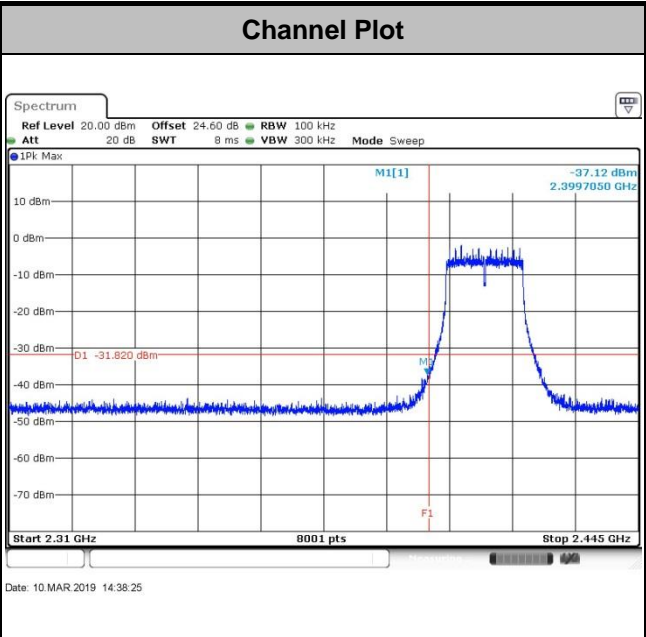
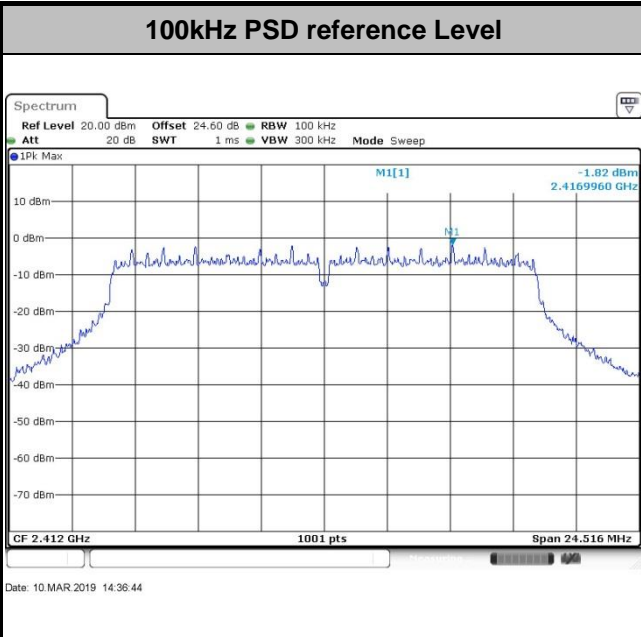



|             |         |                |    |
|-------------|---------|----------------|----|
| Test Mode : | 802.11g | Test Channel : | 06 |
|-------------|---------|----------------|----|

| 100kHz PSD reference Level | Channel Plot |
|----------------------------|--------------|
|----------------------------|--------------|

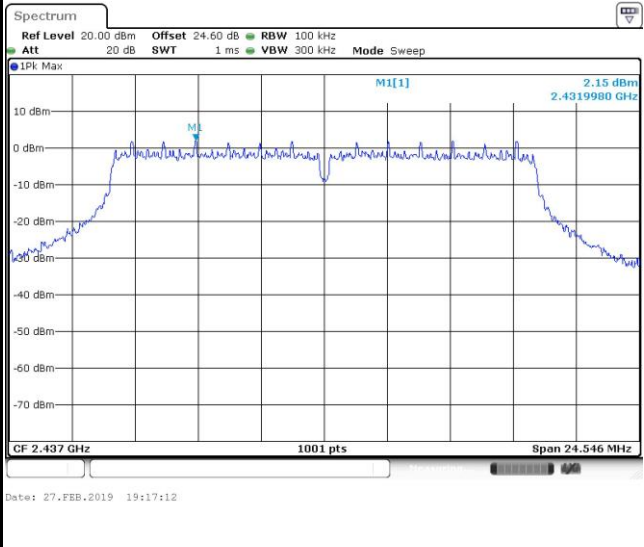

| Spurious Emission 30MHz~3GHz |
|------------------------------|
|------------------------------|

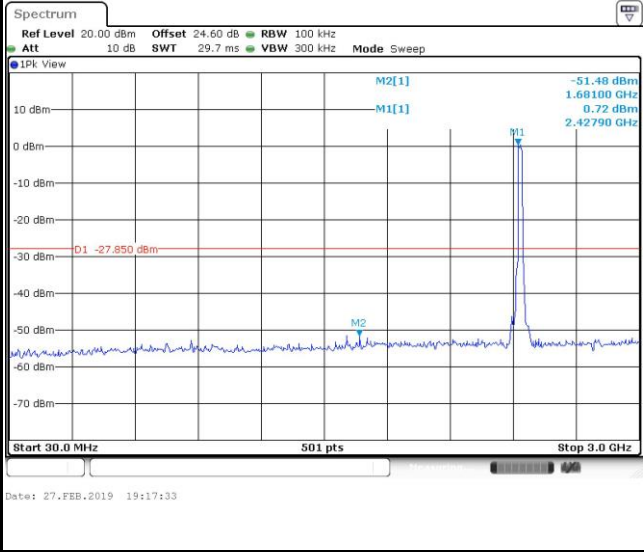

| Spurious Emission 2GHz~25GHz |
|------------------------------|
|------------------------------|

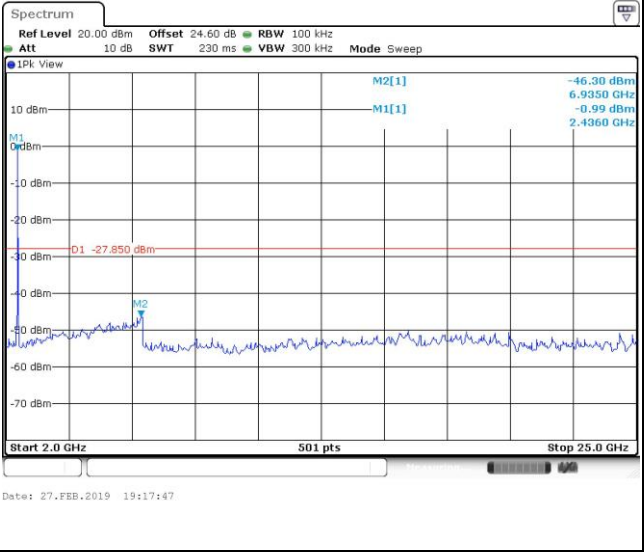



Test Mode : 802.11g      Test Channel : 11

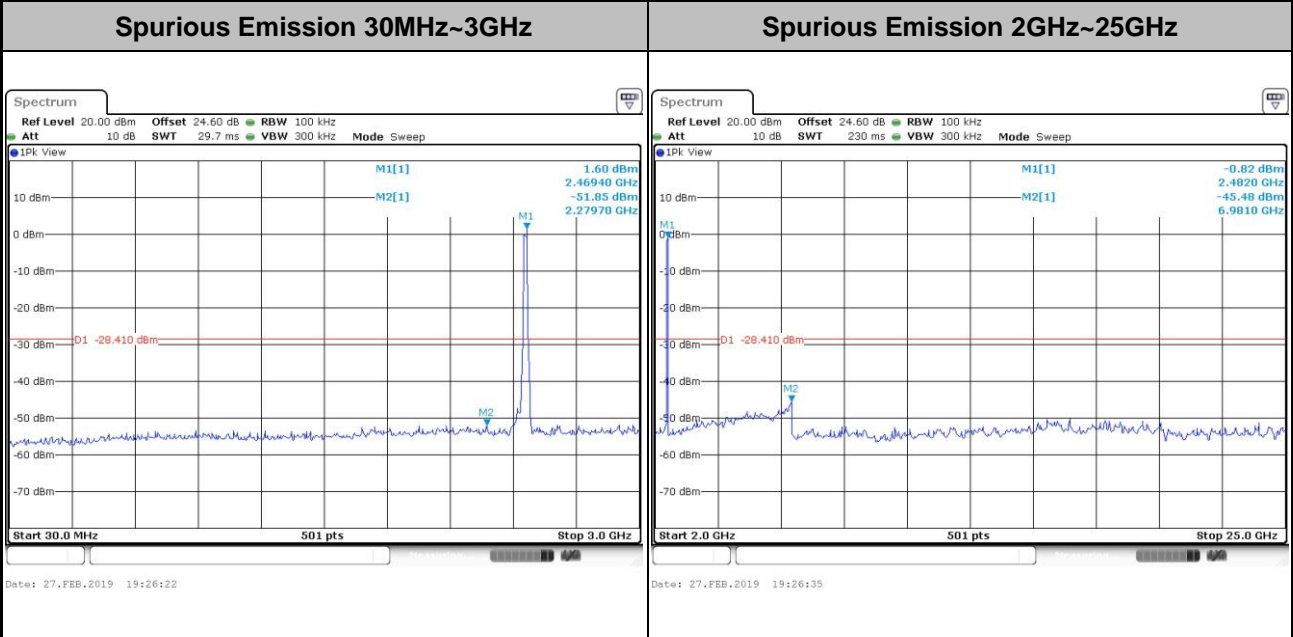
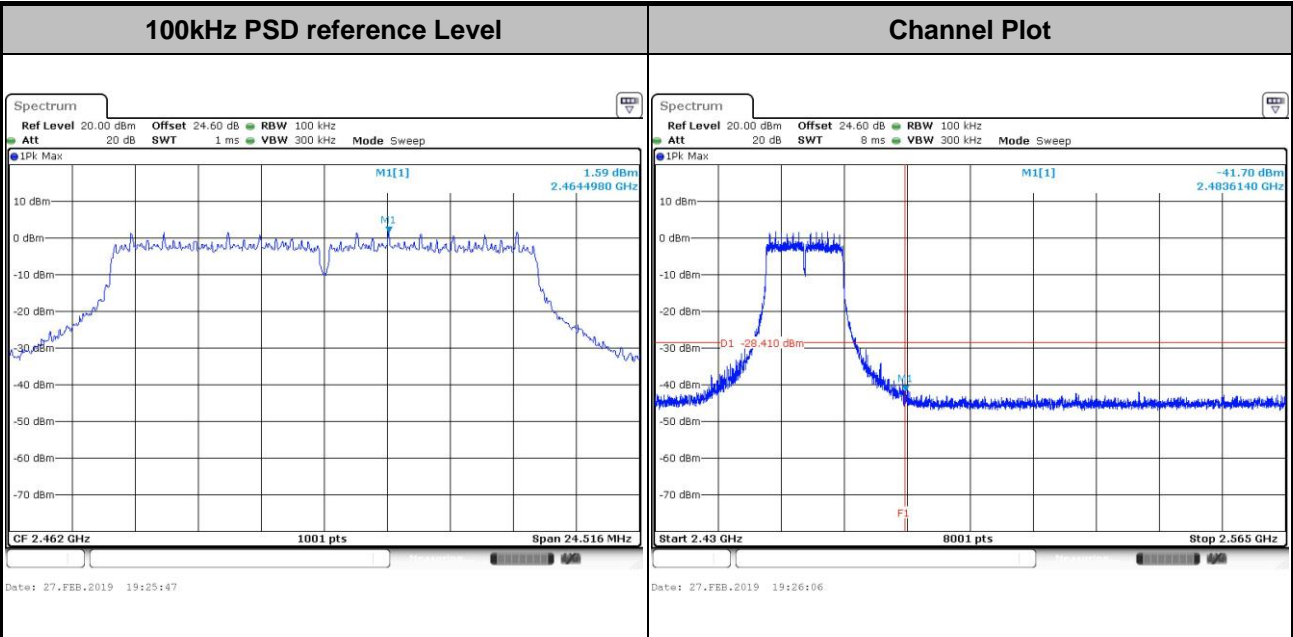



|             |         |                |    |
|-------------|---------|----------------|----|
| Test Mode : | 802.11g | Test Channel : | 12 |
|-------------|---------|----------------|----|

