



FCC RF Test Report

APPLICANT : Sony Mobile Communications Inc.
EQUIPMENT : GSM/WCDMA/LTE Phone+Bluetooth,
DTS/UNII a/b/g/n and NFC
BRAND NAME : Sony
FCC ID : PY7-02885J
STANDARD : FCC Part 15 Subpart C §15.247
CLASSIFICATION : (DTS) Digital Transmission System

The product was received on Apr. 28, 2017 and testing was completed on May 31, 2017. We, SPORTON INTERNATIONAL INC., would like to declare that the tested sample has been evaluated in accordance with the test procedures and has been in compliance with the applicable technical standards.

The test results in this report apply exclusively to the tested model / sample. Without written approval of SPORTON INTERNATIONAL INC., the test report shall not be reproduced except in full.

Reviewed by: Joseph Lin / Supervisor

Approved by: Jones Tsai / Manager



SPORTON INTERNATIONAL INC.

No. 52, Hwa Ya 1st Rd., Hwa Ya Technology Park, Kwei-Shan District, Tao Yuan City, Taiwan, R.O.C.

SPORTON INTERNATIONAL INC.

TEL : 886-3-327-3456

FAX : 886-3-328-4978

FCC ID : PY7-02885J

Page Number : 1 of 39

Report Issued Date : Jul. 10, 2017

Report Version : Rev. 02

Report Template No.: BU5-FR15CBT4.0 Version 1.3



TABLE OF CONTENTS

REVISION HISTORY..... 3

SUMMARY OF TEST RESULT 4

1 GENERAL DESCRIPTION..... 5

 1.1 Applicant 5

 1.2 Manufacturer..... 5

 1.3 Product Feature of Equipment Under Test..... 5

 1.4 Modification of EUT 6

 1.5 Testing Location 7

 1.6 Applicable Standards..... 7

2 TEST CONFIGURATION OF EQUIPMENT UNDER TEST..... 8

 2.1 Carrier Frequency Channel 8

 2.2 Descriptions of Test Mode 9

 2.3 Test Mode 9

 2.4 Connection Diagram of Test System 10

 2.5 Support Unit used in test configuration and system 11

 2.6 EUT Operation Test Setup 11

 2.7 Measurement Results Explanation Example..... 11

3 TEST RESULT 12

 3.1 6dB and 99% Bandwidth Measurement 12

 3.2 Peak Output Power Measurement 17

 3.3 Power Spectral Density Measurement 18

 3.4 Conducted Band Edges and Spurious Emission Measurement 23

 3.5 Radiated Band Edges and Spurious Emission Measurement 28

 3.6 AC Conducted Emission Measurement..... 32

 3.7 Antenna Requirements 36

4 LIST OF MEASURING EQUIPMENT..... 37

5 UNCERTAINTY OF EVALUATION..... 39

APPENDIX A. CONDUCTED TEST RESULTS

APPENDIX B. RADIATED SPURIOUS EMISSION

APPENDIX C. RADIATED SPURIOUS EMISSION PLOTS

APPENDIX D. DUTY CYCLE PLOTS



SUMMARY OF TEST RESULT

Report Section	FCC Rule	Description	Limit	Result	Remark
3.1	15.247(a)(2)	6dB Bandwidth	$\geq 0.5\text{MHz}$	Pass	-
3.1	-	99% Bandwidth	-	Pass	-
3.2	15.247(b)(3)	Peak Output Power	$\leq 30\text{dBm}$	Pass	-
3.3	15.247(e)	Power Spectral Density	$\leq 8\text{dBm}/3\text{kHz}$	Pass	-
3.4	15.247(d)	Conducted Band Edges and Spurious Emission	$\leq 20\text{dBc}$	Pass	-
3.5	15.247(d)	Radiated Band Edges and Spurious Emission	15.209(a) & 15.247(d)	Pass	Under limit 7.59 dB at 139.350 MHz
3.6	15.207	AC Conducted Emission	15.207(a)	Pass	Under limit 12.80 dB at 0.606 MHz
3.7	15.203 & 15.247(b)	Antenna Requirement	N/A	Pass	-



1 General Description

1.1 Applicant

Sony Mobile Communications Inc.

4-12-3 Higashi-Shinagawa, Shinagawa-ku, Tokyo, 140-0002, Japan

1.2 Manufacturer

Sony Mobile Communications Inc.

4-12-3 Higashi-Shinagawa, Shinagawa-ku, Tokyo, 140-0002, Japan

1.3 Product Feature of Equipment Under Test

GSM/WCDMA/LTE, Bluetooth, DTS/UNII, a/b/g/n, NFC, and GPS

Standards-related Product Specification	
Antenna Type / Gain	PIFA Antenna type with gain -2.2 dBi

EUT Information List			
HW Version	SW Version	S/N	Performed Test Item
A	0.32	RQ3004QXCU	RF conducted measurement
		RQ3004QXE8	Radiated Spurious Emission
		RQ3004R9RH	Conducted Emission



Accessory List	
AC Adapter 1	Model No. : UCH20
	S/N :
	1215W48600059 (for radiated spurious emission) 1215W48600011 (for conducted emission)
Earphone 1	Model No. : MH410c
	S/N: 1632A86600000E0
USB Cable	Model No. : UCB20
	S/N :
	1625A9110003BFA (for radiated spurious emission) 1625A9100003A98 (for conducted emission)

Note:

1. Above EUT list and accessory list used are electrically identical per declared by manufacturer.
2. Above the accessories list are used to exercise the EUT during test.
3. For other wireless features of this EUT, test report will be issued separately.

1.4 Modification of EUT

No modifications are made to the EUT during all test items.



1.5 Testing Location

Sporton Lab is accredited to ISO 17025 by Taiwan Accreditation Foundation (TAF code : 1190) and the FCC designation No. TW0007 under the FCC 2.948(e) by Mutual Recognition Agreement (MRA) in FCC Test.

Test Site	SPORTON INTERNATIONAL INC.	
Test Site Location	No. 52, Hwa Ya 1 st Rd., Hwa Ya Technology Park, Kwei-Shan District, Tao Yuan City, Taiwan, R.O.C. TEL: +886-3-327-3456 FAX: +886-3-328-4978	
Test Site No.	Sporton Site No.	
	TH05-HY	CO05-HY

Note: The test site complies with ANSI C63.4 2014 requirement.

Test Site	SPORTON INTERNATIONAL INC.	
Test Site Location	No.58, Aly. 75, Ln. 564, Wenhua 3rd Rd. Guishan Dist, Taoyuan City, Taiwan (R.O.C.) TEL: +886-3-327-0868 FAX: +886-3-327-0855	
Test Site No.	Sporton Site No.	
	03CH13-HY	

Note: The test site complies with ANSI C63.4 2014 requirement.

1.6 Applicable Standards

According to the specifications of the manufacturer, the EUT must comply with the requirements of the following standards:

- ♦ FCC Part 15 Subpart C §15.247
- ♦ FCC KDB Publication No. 558074 D01 DTS Meas. Guidance v04
- ♦ ANSI C63.10-2013

Remark:

1. All test items were verified and recorded according to the standards and without any deviation during the test.
2. This EUT has also been tested and complied with the requirements of FCC Part 15, Subpart B, recorded in a separate test report.



2 Test Configuration of Equipment Under Test

2.1 Carrier Frequency Channel

Frequency Band	Channel	Freq. (MHz)	Channel	Freq. (MHz)
2400-2483.5 MHz	0	2402	21	2444
	1	2404	22	2446
	2	2406	23	2448
	3	2408	24	2450
	4	2410	25	2452
	5	2412	26	2454
	6	2414	27	2456
	7	2416	28	2458
	8	2418	29	2460
	9	2420	30	2462
	10	2422	31	2464
	11	2424	32	2466
	12	2426	33	2468
	13	2428	34	2470
	14	2430	35	2472
	15	2432	36	2474
	16	2434	37	2476
	17	2436	38	2478
	18	2438	39	2480
	19	2440	-	-
20	2442	-	-	



2.2 Descriptions of Test Mode

The RF output power was recorded in the following table:

Channel	Frequency	Bluetooth – LE RF Output Power	
		Data Rate / Modulation	
		GFSK	
		1Mbps	
Ch00	2402MHz	-0.75 dBm	
Ch19	2440MHz	0.45 dBm	
Ch39	2480MHz	-1.95 dBm	

- a. The EUT has been associated with peripherals and configuration operated in a manner tended to maximize its emission characteristics in a typical application. Frequency range investigated: conduction (150 kHz to 30 MHz), radiation (9 kHz to the 10th harmonic of the highest fundamental frequency or to 40 GHz, whichever is lower). Pre-scanned tests, X, Y, Z in three orthogonal panels to determine the final configuration (X plane as worst plane) from all possible combinations.
- b. AC power line Conducted Emission was tested under maximum output power.

2.3 Test Mode

The following summary table is showing all test modes to demonstrate in compliance with the standard.

Summary table of Test Cases	
Test Item	Data Rate / Modulation
	Bluetooth – LE / GFSK
Conducted TCs	Mode 1: Bluetooth Tx CH00_2402 MHz_1Mbps Mode 2: Bluetooth Tx CH19_2440 MHz_1Mbps Mode 3: Bluetooth Tx CH39_2480 MHz_1Mbps
Radiated TCs	Mode 1: Bluetooth Tx CH00_2402 MHz_1Mbps Mode 2: Bluetooth Tx CH19_2440 MHz_1Mbps Mode 3: Bluetooth Tx CH39_2480 MHz_1Mbps
AC Conducted Emission	Mode 1: GSM1900 Idle + Bluetooth Link + WLAN (2.4GHz) Link + MP3 + Earphone 1 + Battery + USB Cable (Charging from Adapter 1)

2.4 Connection Diagram of Test System

<Bluetooth – LE Tx Mode>

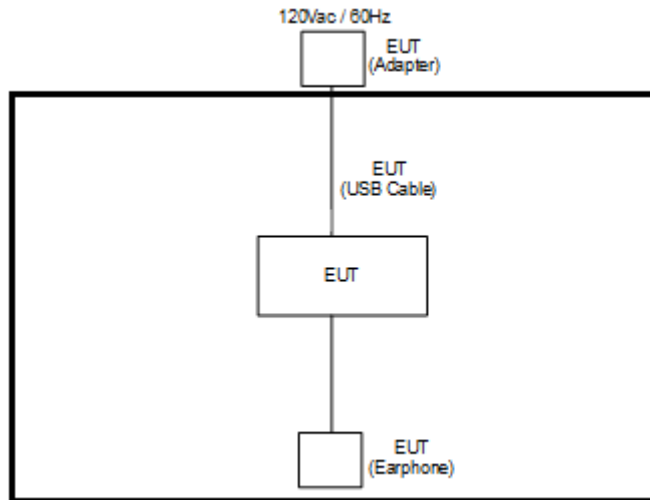

<AC Conducted Emission Mode>

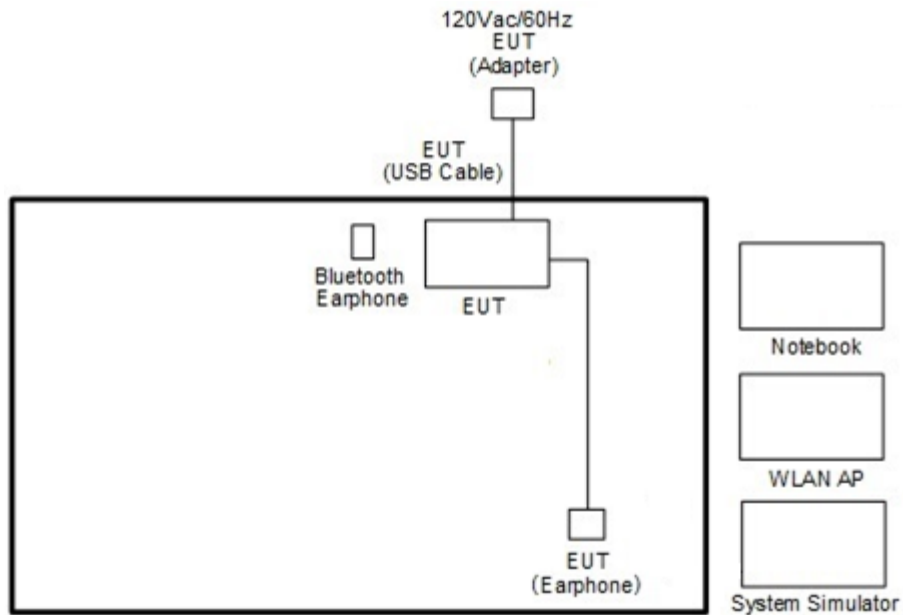



2.5 Support Unit used in test configuration and system

Item	Equipment	Trade Name	Model Name	FCC ID	Data Cable	Power Cord
1.	System Simulator	Anritsu	MT8820C	N/A	N/A	Unshielded, 1.8 m
2.	WLAN AP	ASUS	RT-AC66U	MSQ-RTAC66U	N/A	Unshielded, 1.8m
3.	Notebook	DELL	Latitude E6320	FCC DoC/ Contains FCC ID: QDS-BRCM1054	N/A	AC I/P: Unshielded, 1.2 m DC O/P: Shielded, 1.8 m
4.	Bluetooth Earphone	Sony	SBH20	PY7-RD0010	N/A	N/A
5.	SD Card	SanDisk	MicroSD HC	FCC DoC	N/A	N/A

2.6 EUT Operation Test Setup

For RF test items, an engineering test program was provided and enabled to make EUT transmitting signals.

2.7 Measurement Results Explanation Example

For all conducted test items:

The offset level is set in the spectrum analyzer to compensate the RF cable loss and attenuator factor between EUT conducted output port and spectrum analyzer. With the offset compensation, the spectrum analyzer reading level is exactly the EUT RF output level.

Example :

The spectrum analyzer offset is derived from RF cable loss and attenuator factor.

Offset = RF cable loss + attenuator factor.

Following shows an offset computation example with cable loss 4.2 dB and 10dB attenuator.

$$\begin{aligned} \text{Offset(dB)} &= \text{RF cable loss(dB)} + \text{attenuator factor(dB)}. \\ &= 4.2 + 10 = 14.2 \text{ (dB)} \end{aligned}$$

3 Test Result

3.1 6dB and 99% Bandwidth Measurement

3.1.1 Limit of 6dB and 99% Bandwidth

The minimum 6 dB bandwidth shall be at least 500 kHz.

3.1.2 Measuring Instruments

The section 4.0 of List of Measuring Equipment of this test report is used for test.

3.1.3 Test Procedures

1. The testing follows FCC KDB Publication No. 558074 D01 DTS Meas. Guidance v04.
2. The RF output of EUT was connected to the spectrum analyzer by RF cable and attenuator. The path loss was compensated to the results for each measurement.
3. Set to the maximum power setting and enable the EUT transmit continuously.
4. Make the measurement with the spectrum analyzer's resolution bandwidth (RBW) = 100 kHz. Set the Video bandwidth (VBW) = 300 kHz. In order to make an accurate measurement. The 6 dB bandwidth must be greater than 500 kHz.
5. For 99% Bandwidth Measurement, the spectrum analyzer's resolution bandwidth (RBW) is set 30kHz and set the Video bandwidth (VBW) = 100kHz.
6. Measure and record the results in the test report.

3.1.4 Test Setup

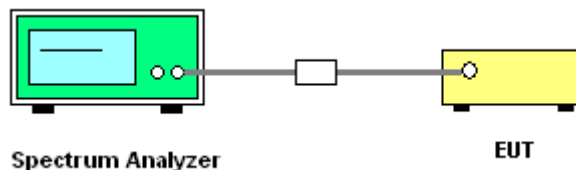

3.1.5 Test Result of 6dB Bandwidth

Please refer to Appendix A.



6 dB Bandwidth Plot on Channel 00

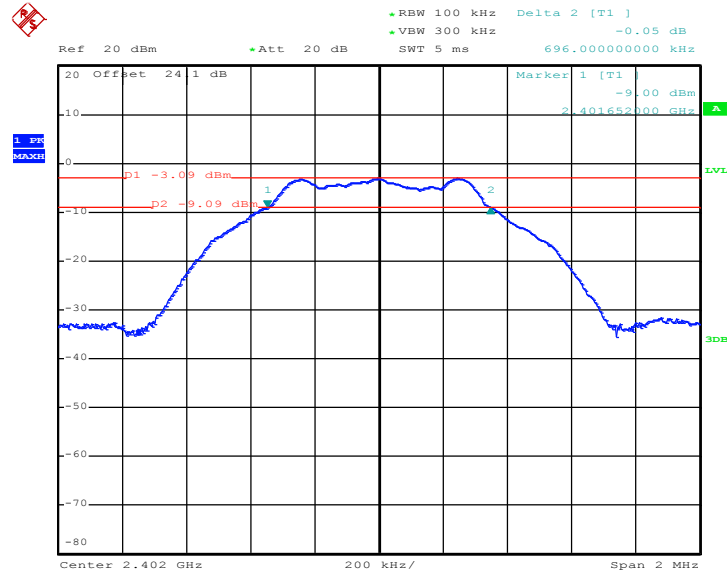

Date: 26.MAY.2017 08:01:53

6 dB Bandwidth Plot on Channel 19

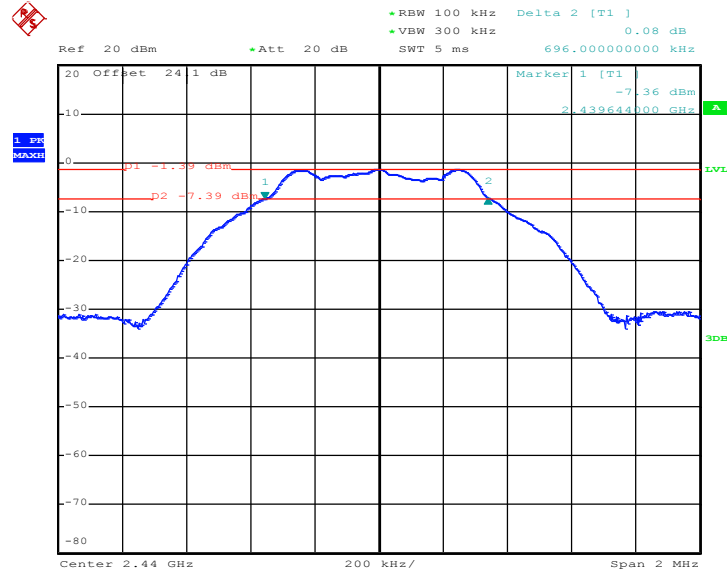

Date: 26.MAY.2017 08:04:07



6 dB Bandwidth Plot on Channel 39

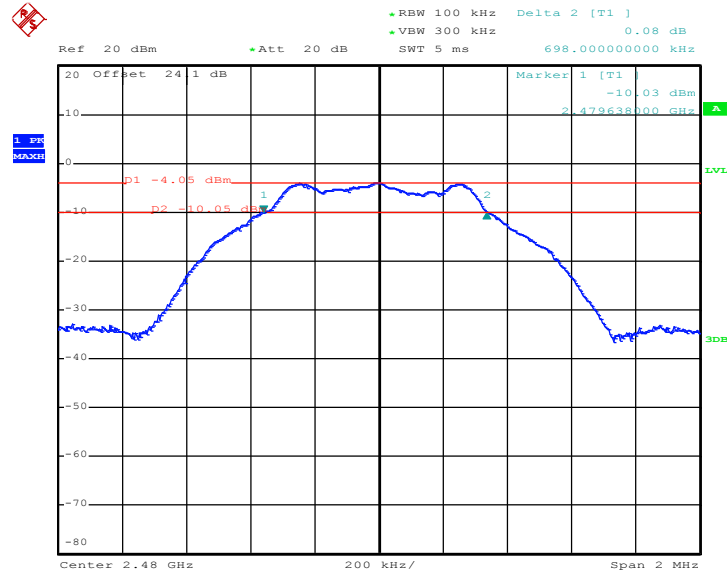

Date: 26.MAY.2017 08:06:11



3.1.6 Test Result of 99% Occupied Bandwidth

Please refer to Appendix A.

99% Bandwidth Plot on Channel 00

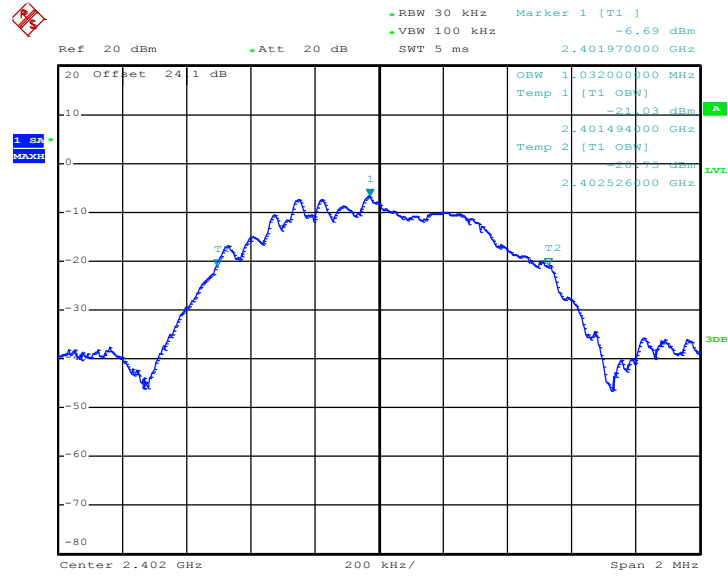

Date: 26.MAY.2017 08:03:07



99% Occupied Bandwidth Plot on Channel 19

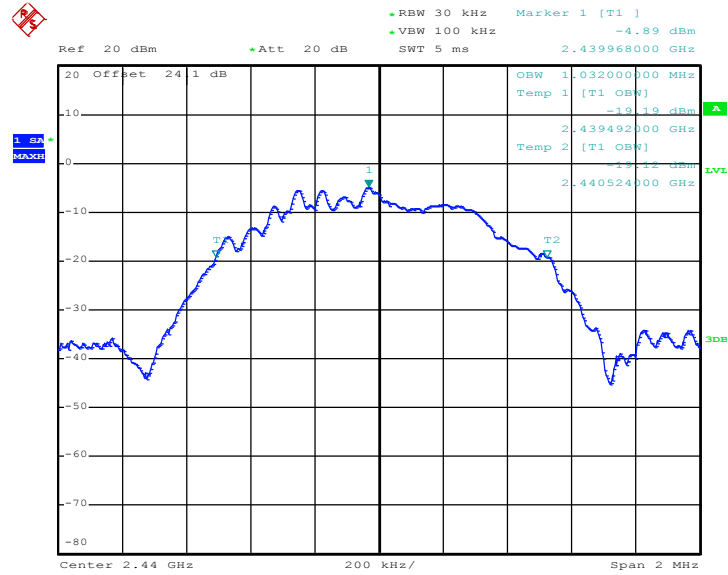

Date: 26.MAY.2017 08:05:10

99% Occupied Bandwidth Plot on Channel 39

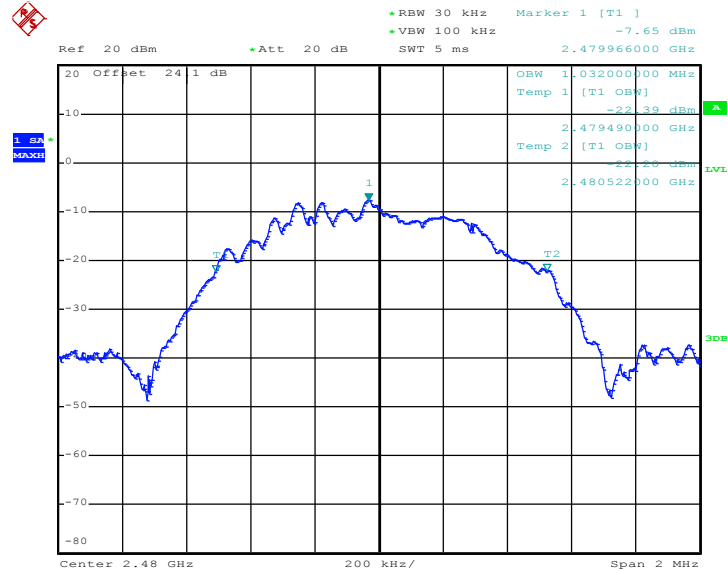

Date: 26.MAY.2017 08:07:52

Note: The occupied channel bandwidth is maintained within the band of operation for all of the modulations.

3.2 Peak Output Power Measurement

3.2.1 Limit of Peak Output Power

For systems using digital modulation in the 2400-2483.5MHz, the limit for peak output power is 30dBm. If transmitting antenna of directional gain greater than 6dBi is used, the peak output power from the intentional radiator shall be reduced below the above stated value by the amount in dB that the directional gain of the antenna exceeds 6 dBi. In case of point-to-point operation, the limit has to be reduced by 1dB for every 3dB that the directional gain of the antenna exceeds 6dBi.

3.2.2 Measuring Instruments

The section 4.0 of List of Measuring Equipment of this test report is used for test.

3.2.3 Test Procedures

1. The testing follows the Measurement Procedure of FCC KDB No. 558074 DTS D01 Meas. Guidance v04 section 9.1.3 PKPM1 Peak power meter method.
2. The RF output of EUT was connected to the power meter by RF cable and attenuator. The path loss was compensated to the results for each measurement.
3. Set to the maximum power setting and enable the EUT transmit continuously.
4. Measure the conducted output power and record the results in the test report.

3.2.4 Test Setup

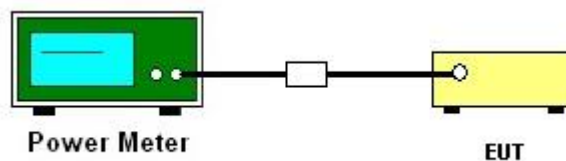

3.2.5 Test Result of Peak Output Power

Please refer to Appendix A.

3.3 Power Spectral Density Measurement

3.3.1 Limit of Power Spectral Density

The peak power spectral density shall not be greater than 8dBm in any 3kHz band at any time interval of continuous transmission.

3.3.2 Measuring Instruments

The section 4.0 of List of Measuring Equipment of this test report is used for test.

3.3.3 Test Procedures

1. The testing follows Measurement Procedure 10.2 Method PKPSD of FCC KDB Publication No. 558074 D01 DTS Meas. Guidance v04
2. The RF output of EUT was connected to the spectrum analyzer by RF cable and attenuator. The path loss was compensated to the results for each measurement.
3. Set to the maximum power setting and enable the EUT transmit continuously.
4. Make the measurement with the spectrum analyzer's resolution bandwidth (RBW) = 3 kHz. Video bandwidth VBW = 10 kHz In order to make an accurate measurement, set the span to 1.5 times DTS Channel Bandwidth. (6dB BW)
5. Detector = peak, Sweep time = auto couple, Trace mode = max hold, Allow trace to fully stabilize. Use the peak marker function to determine the maximum power level.
6. Measure and record the results in the test report.
7. The Measured power density (dBm)/ 100kHz is a reference level and used as 20dBc down limit line for Conducted Band Edges and Conducted Spurious Emission.

3.3.4 Test Setup

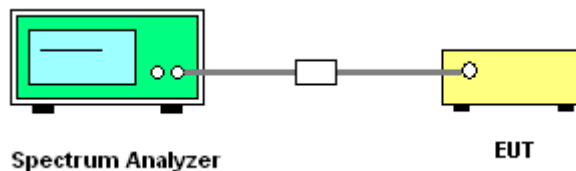

3.3.5 Test Result of Power Spectral Density

Please refer to Appendix A.



3.3.6 Test Result of Power Spectral Density Plots (100kHz)

PSD 100kHz Plot on Channel 00

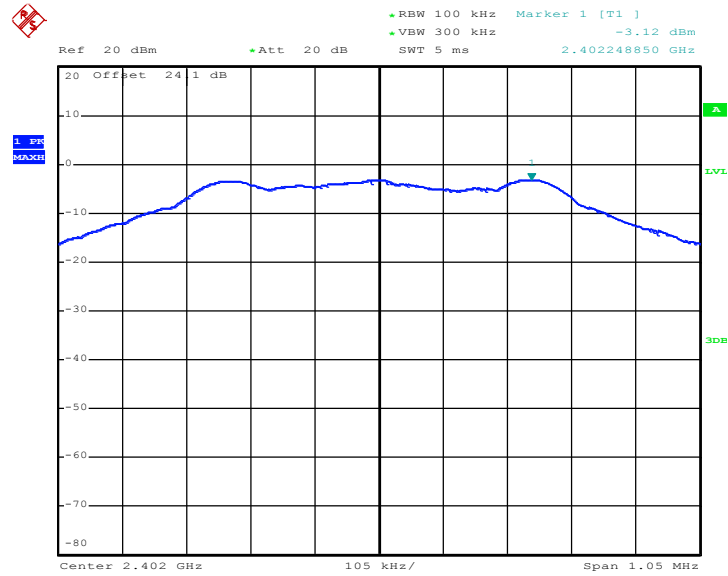

Date: 26.MAY.2017 08:02:18

PSD 100kHz Plot on Channel 19

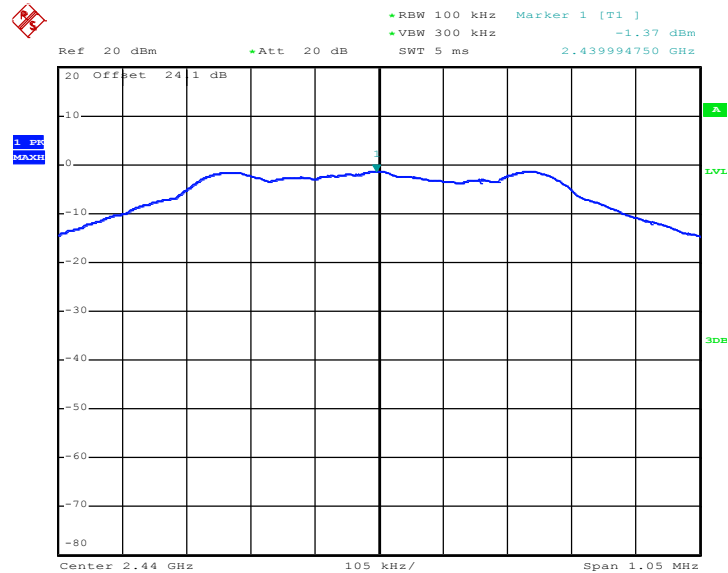

Date: 26.MAY.2017 08:04:31



PSD 100kHz Plot on Channel 39

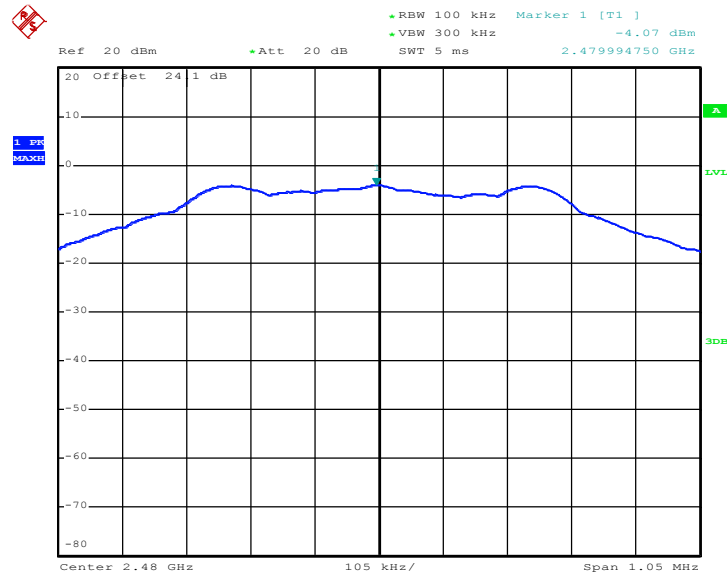

Date: 26.MAY.2017 08:06:57



3.3.7 Test Result of Power Spectral Density Plots (3kHz)

PSD 3kHz Plot on Channel 00

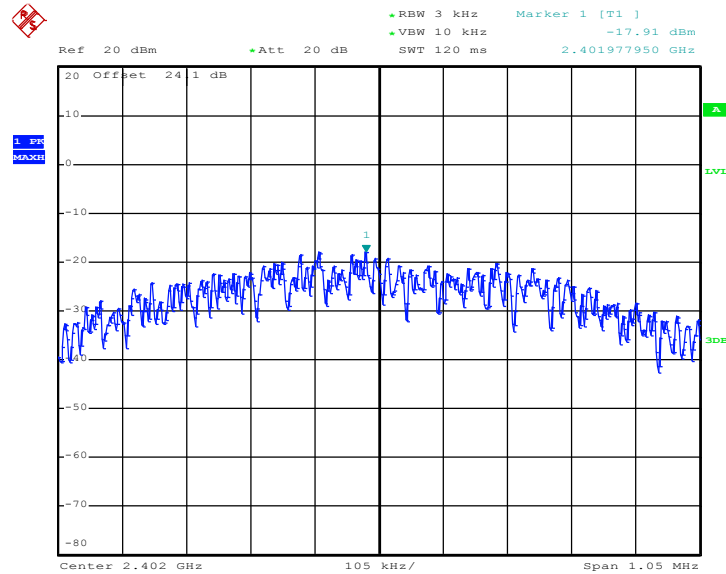

Date: 26.MAY.2017 08:02:03

PSD 3kHz Plot on Channel 19

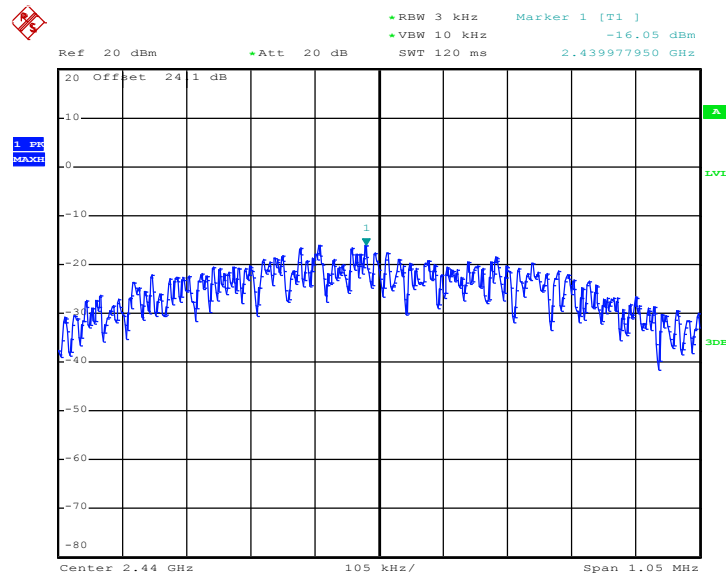

Date: 26.MAY.2017 08:04:19



PSD 3kHz Plot on Channel 39

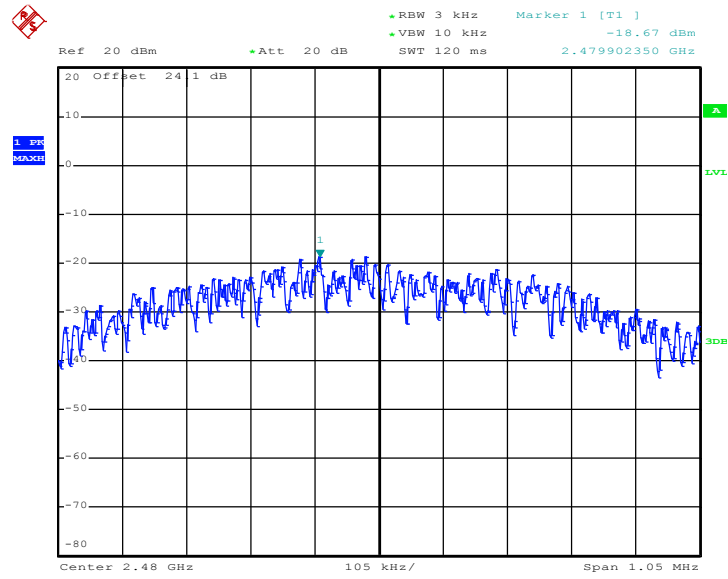

Date: 26.MAY.2017 08:06:38

3.4 Conducted Band Edges and Spurious Emission Measurement

3.4.1 Limit of Conducted Band Edges and Spurious Emission

All harmonics/spurious must be at least 20 dB down from the highest emission level within the authorized band.

3.4.2 Measuring Instruments

The section 4.0 of List of Measuring Equipment of this test report is used for test.

3.4.3 Test Procedure

1. The testing follows FCC KDB Publication No. 558074 D01 DTS Meas. Guidance v04.
2. The RF output of EUT was connected to the spectrum analyzer by RF cable and attenuator. The path loss was compensated to the results for each measurement.
3. Set to the maximum power setting and enable the EUT transmit continuously.
4. Set RBW = 100 kHz, VBW=300 kHz, Peak Detector. Unwanted Emissions measured in any 100 kHz bandwidth outside of the authorized frequency band shall be attenuated by at least 20 dB relative to the maximum in-band peak PSD level in 100 kHz when maximum peak conducted output power procedure is used. If the transmitter complies with the conducted power limits based on the use of RMS averaging over a time interval, the attenuation required under this paragraph shall be 30 dB instead of 20 dB.
5. Measure and record the results in the test report.
6. The RF fundamental frequency should be excluded against the limit line in the operating frequency band.

3.4.4 Test Setup





Conducted Spurious Emission Plot on Bluetooth LE 1Mbps GFSK Channel 19

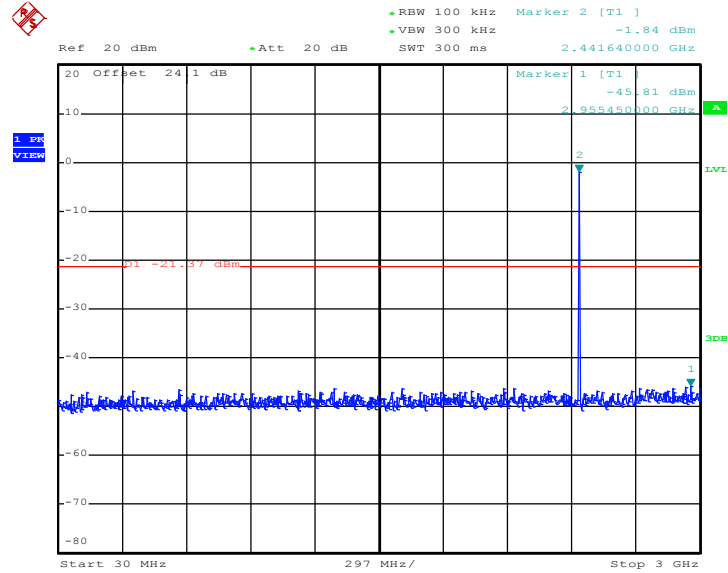

Date: 26.MAY.2017 08:04:43

Conducted Spurious Emission Plot on Bluetooth LE 1Mbps GFSK Channel 19

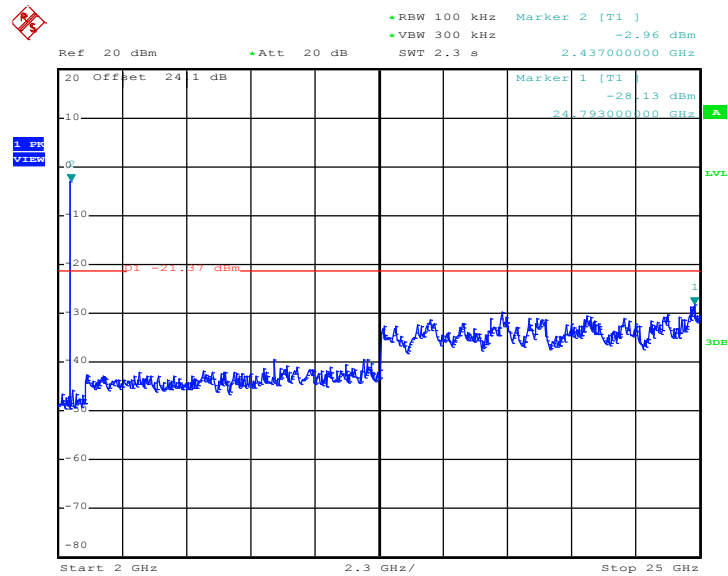

Date: 26.MAY.2017 08:04:51



Conducted Spurious Emission Plot on Bluetooth LE 1Mbps GFSK Channel 39

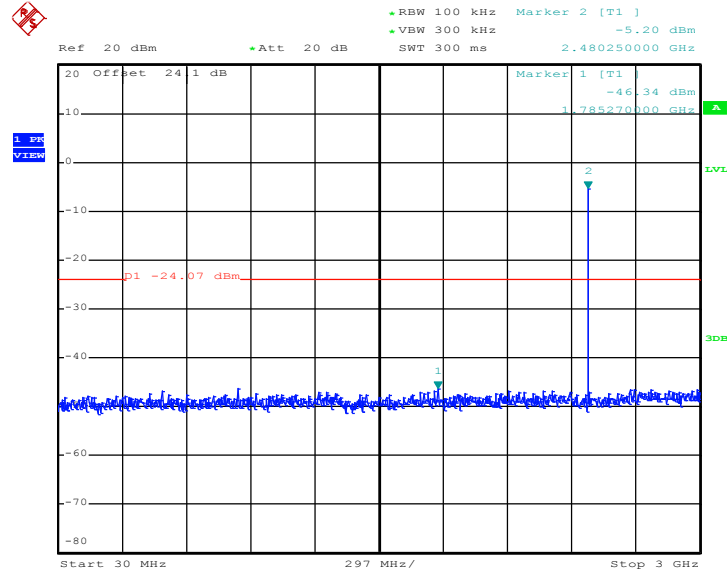

Date: 26.MAY.2017 08:07:30

Conducted Spurious Emission Plot on Bluetooth LE 1Mbps GFSK Channel 39

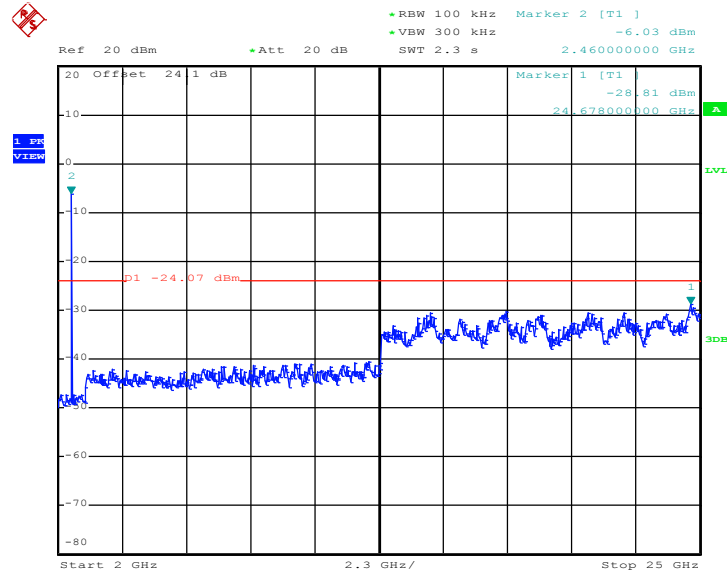

Date: 26.MAY.2017 08:07:38



3.5 Radiated Band Edges and Spurious Emission Measurement

3.5.1 Limit of Radiated Band Edges and Spurious Emission

In any 100 kHz bandwidth outside the intentional radiator frequency band, all harmonics/spurious must be at least 20 dB below the highest emission level within the authorized band. If the output power of this device was measured by spectrum analyzer, the attenuation under this paragraph shall be 30 dB instead of 20 dB. In addition, radiated emissions which fall in the restricted bands must also comply with the limits as below.

Frequency (MHz)	Field Strength (microvolts/meter)	Measurement Distance (meters)
0.009 – 0.490	2400/F(kHz)	300
0.490 – 1.705	24000/F(kHz)	30
1.705 – 30.0	30	30
30 – 88	100	3
88 – 216	150	3
216 - 960	200	3
Above 960	500	3

3.5.2 Measuring Instruments

The section 4.0 of List of Measuring Equipment of this test report is used for test.



3.5.3 Test Procedures

1. The testing follows FCC KDB Publication No. 558074 D01 DTS Meas. Guidance v04.
2. The EUT was arranged to its worst case and then tune the antenna tower (from 1 m to 4 m) and turntable (from 0 degree to 360 degrees) to find the maximum reading. A pre-amp and a high pass filter are used for the test in order to get better signal level.
3. The EUT was placed on a turntable with 0.8 meter for frequency below 1GHz and 1.5 meter for frequency above 1GHz respectively above ground.
4. The EUT was set 3 meters from the interference receiving antenna, which was mounted on the top of a variable height antenna tower.
5. Corrected Reading: Antenna Factor + Cable Loss + Read Level - Preamp Factor = Level
6. For testing below 1GHz, if the emission level of the EUT in peak mode was 3 dB lower than the limit specified, then peak values of EUT will be reported, otherwise, the emissions will be repeated one by one using the CISPR quasi-peak method and reported.
7. For testing above 1GHz, the emission level of the EUT in peak mode was 20dB lower than average limit (that means the emission level in average mode also complies with the limit in average mode), then peak values of EUT will be reported, otherwise, the emissions will be measured in average mode again and reported.
8. Use the following spectrum analyzer settings:
 - (1) Span shall wide enough to fully capture the emission being measured;
 - (2) Set RBW=100 kHz for $f < 1$ GHz; VBW \geq RBW; Sweep = auto; Detector function = peak; Trace = max hold;
 - (3) Set RBW = 1 MHz, VBW= 3MHz for $f \geq 1$ GHz for peak measurement.
For average measurement:
 - VBW = 10 Hz, when duty cycle is no less than 98 percent.
 - VBW $\geq 1/T$, when duty cycle is less than 98 percent where T is the minimum transmission duration over which the transmitter is on and is transmitting at its maximum power control level for the tested mode of operation.

3.5.4 Test Setup

For radiated emissions below 30MHz



For radiated emissions from 30MHz to 1GHz

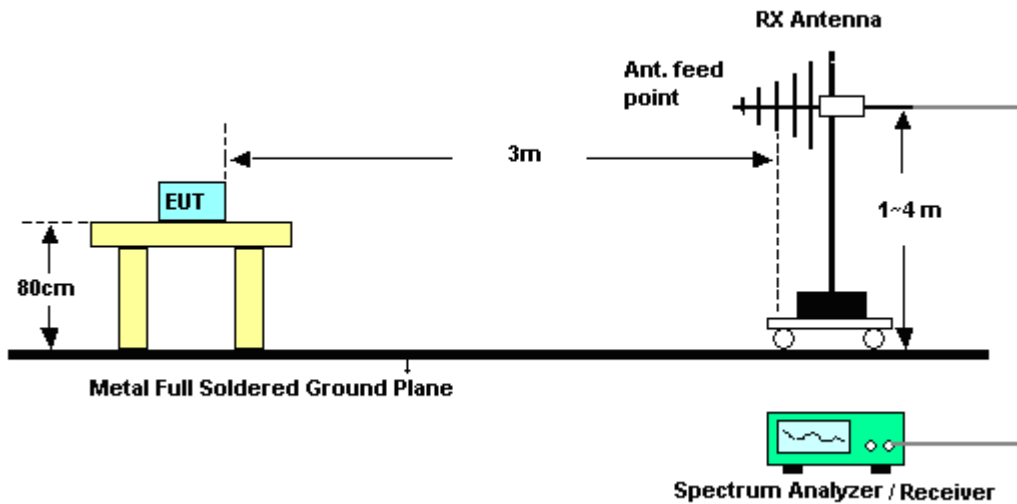

For radiated emissions above 1GHz

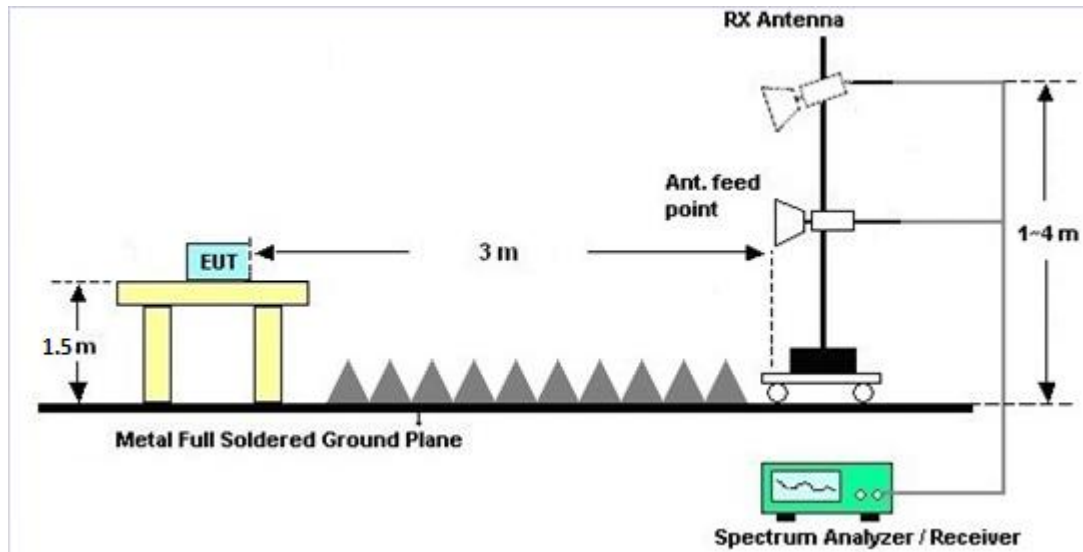

3.5.5 Test Results of Radiated Spurious Emissions (9 kHz ~ 30 MHz)

The low frequency, which started from 9 kHz to 30MHz, was pre-scanned and the result which was 20dB lower than the limit line was not reported.

There is a comparison data of both open-field test site and semi-Anechoic chamber, and the result came out very similar.

3.5.6 Test Result of Radiated Spurious at Band Edges

Please refer to Appendix B and C.

3.5.7 Duty Cycle

Please refer to Appendix D.

3.5.8 Test Result of Radiated Spurious Emission (30MHz ~ 10th Harmonic)

Please refer to Appendix B and C.



3.6 AC Conducted Emission Measurement

3.6.1 Limit of AC Conducted Emission

For equipment that is designed to be connected to the public utility (AC) power line, the radio frequency voltage that is conducted back onto the AC power line on any frequency or frequencies within the band 150 kHz to 30 MHz shall not exceed the limits in the following table.

Frequency of emission (MHz)	Conducted limit (dBµV)	
	Quasi-peak	Average
0.15-0.5	66 to 56*	56 to 46*
0.5-5	56	46
5-30	60	50

*Decreases with the logarithm of the frequency.

3.6.2 Measuring Instruments

The section 4.0 of List of Measuring Equipment of this test report is used for test.

3.6.3 Test Procedures

1. The EUT was placed 0.4 meter from the conducting wall of the shielding room was kept at least 80 centimeters from any other grounded conducting surface.
2. Connect EUT to the power mains through a line impedance stabilization network (LISN).
3. All the support units are connecting to the other LISN.
4. The LISN provides 50 ohm coupling impedance for the measuring instrument.
5. The FCC states that a 50 ohm, 50 microhenry LISN should be used.
6. Both sides of AC line were checked for maximum conducted interference.
7. The frequency range from 150 kHz to 30 MHz was searched.
8. Set the test-receiver system to Peak Detect Function and specified bandwidth (IF Bandwidth = 9kHz) with Maximum Hold Mode. Then measurement is also conducted by Average Detector and Quasi-Peak Detector Function respectively.

3.6.4 Test Setup





3.6.5 Test Result of AC Conducted Emission

Test Mode :	Mode 1	Temperature :	22~25°C
Test Engineer :	Arthur Hsieh	Relative Humidity :	51~55%
Test Voltage :	120Vac / 60Hz	Phase :	Line
Function Type :	GSM1900 Idle + Bluetooth Link + WLAN (2.4GHz) Link + MP3 + Earphone 1 + Battery + USB Cable (Charging from Adapter 1)		

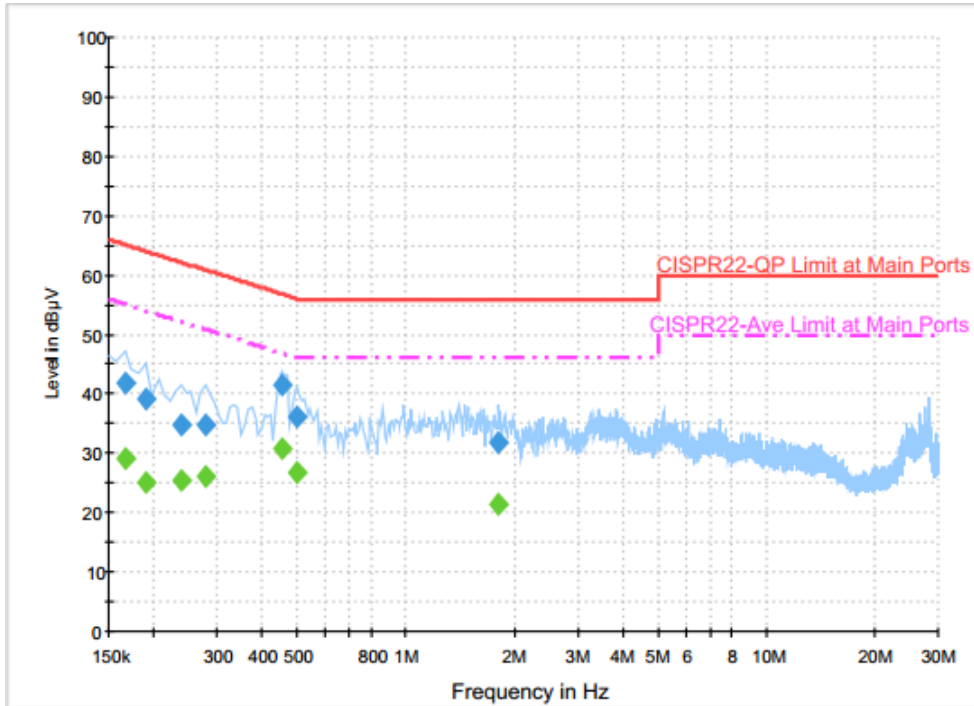

Final Result : Quasi-Peak

Frequency (MHz)	Quasi-Peak (dBµV)	Filter	Line	Corr. (dB)	Margin (dB)	Limit (dBµV)
0.166000	41.9	Off	L1	19.6	23.3	65.2
0.190000	39.2	Off	L1	19.6	24.8	64.0
0.238000	34.7	Off	L1	19.6	27.5	62.2
0.278000	34.9	Off	L1	19.6	26.0	60.9
0.454000	41.6	Off	L1	19.6	15.2	56.8
0.502000	36.1	Off	L1	19.6	19.9	56.0
1.814000	31.9	Off	L1	19.6	24.1	56.0

Final Result : Average

Frequency (MHz)	Average (dBµV)	Filter	Line	Corr. (dB)	Margin (dB)	Limit (dBµV)
0.166000	29.2	Off	L1	19.6	26.0	55.2
0.190000	25.0	Off	L1	19.6	29.0	54.0
0.238000	25.5	Off	L1	19.6	26.7	52.2
0.278000	26.0	Off	L1	19.6	24.9	50.9
0.454000	30.7	Off	L1	19.6	16.1	46.8
0.502000	26.7	Off	L1	19.6	19.3	46.0
1.814000	21.3	Off	L1	19.6	24.7	46.0



Test Mode :	Mode 1	Temperature :	22~25°C
Test Engineer :	Arthur Hsieh	Relative Humidity :	51~55%
Test Voltage :	120Vac / 60Hz	Phase :	Neutral
Function Type :	GSM1900 Idle + Bluetooth Link + WLAN (2.4GHz) Link + MP3 + Earphone 1 + Battery + USB Cable (Charging from Adapter 1)		

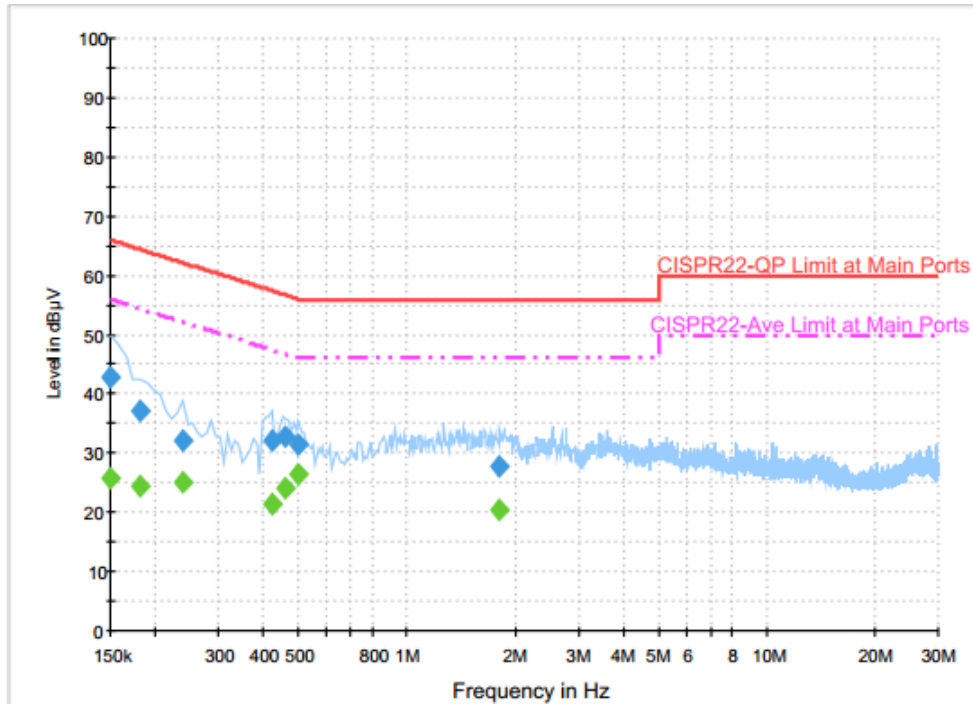

Final Result : Quasi-Peak

Frequency (MHz)	Quasi-Peak (dBµV)	Filter	Line	Corr. (dB)	Margin (dB)	Limit (dBµV)
0.150000	42.9	Off	N	19.5	23.1	66.0
0.182000	37.0	Off	N	19.5	27.4	64.4
0.238000	32.2	Off	N	19.5	30.0	62.2
0.422000	32.2	Off	N	19.5	25.2	57.4
0.462000	32.7	Off	N	19.5	24.0	56.7
0.502000	31.3	Off	N	19.5	24.7	56.0
1.814000	27.9	Off	N	19.6	28.1	56.0

Final Result : Average

Frequency (MHz)	Average (dBµV)	Filter	Line	Corr. (dB)	Margin (dB)	Limit (dBµV)
0.150000	25.8	Off	N	19.5	30.2	56.0
0.182000	24.6	Off	N	19.5	29.8	54.4
0.238000	25.0	Off	N	19.5	27.2	52.2
0.422000	21.6	Off	N	19.5	25.8	47.4
0.462000	24.1	Off	N	19.5	22.6	46.7
0.502000	26.5	Off	N	19.5	19.5	46.0
1.814000	20.4	Off	N	19.6	25.6	46.0



3.7 Antenna Requirements

3.7.1 Standard Applicable

If directional gain of transmitting antennas is greater than 6dBi, the power shall be reduced by the same level in dB comparing to gain minus 6dBi. The use of a permanently attached antenna or of an antenna that uses a unique coupling to the intentional radiator shall be considered sufficient to comply with the rule.

3.7.2 Antenna Anti-Replacement Construction

An embedded-in antenna design is used.

3.7.3 Antenna Gain

The antenna peak gain of EUT is less than 6 dBi. Therefore, it is not necessary to reduce maximum peak output power limit.



4 List of Measuring Equipment

Instrument	Manufacturer	Model No.	Serial No.	Characteristics	Calibration Date	Test Date	Due Date	Remark
Spectrum Analyzer	Rohde & Schwarz	FSP40	100055	9kHz-40GHz	Jul. 17, 2016	May 16, 2017~ May 25, 2017	Jul. 16, 2017	Conducted (TH05-HY)
Power Meter	Agilent	E4416A	GB412923 44	300MHz~40GHz	Dec. 26, 2016	May 16, 2017~ May 25, 2017	Dec. 25, 2017	Conducted (TH05-HY)
Power Sensor	Agilent	E9327A	US4044154 8	300MHz~40GHz	Dec. 26, 2016	May 16, 2017~ May 25, 2017	Dec. 25, 2017	Conducted (TH05-HY)
Hygrometer	Testo	608-H2	41410069	N/A	Aug. 28, 2016	May 16, 2017~ May 25, 2017	Aug. 27, 2017	Conducted (TH05-HY)
RF Cable	HUBER + SUHNER	SUCOFLEX 104	MY842095 21	1GHz~26GHz	Dec. 02, 2016	May 16, 2017~ May 25, 2017	Dec. 01, 2017	Conducted (TH05-HY)
AC Power Source	ChainTek	APC-1000W	N/A	N/A	N/A	May 14, 2017	N/A	Conduction (CO05-HY)
EMI Test Receiver	Rohde & Schwarz	ESCI 7	100724	9kHz~7GHz	Aug. 30, 2016	May 14, 2017	Aug. 29, 2017	Conduction (CO05-HY)
Hygrometer	Testo	608-H1	34913912	N/A	May 02, 2017	May 14, 2017	May 01, 2018	Conduction (CO05-HY)
LISN	Rohde & Schwarz	ENV216	100080	9kHz~30MHz	Nov. 29, 2016	May 14, 2017	Nov. 28, 2017	Conduction (CO05-HY)
LF Cable	HUBER + SUHNER	RG-214/U	LF01	N/A	Jan. 05, 2017	May 14, 2017	Jan. 04, 2018	Conduction (CO05-HY)
Test Software	N/A	EMC32	8.40.0	N/A	N/A	May 14, 2017	N/A	Conduction (CO05-HY)
Loop Antenna	Rohde & Schwarz	HFH2-Z2	100315	9 kHz~30 MHz	May 15, 2017	May 19, 2017~ May 31, 2017	May 14, 2019	Radiation (03CH13-HY)
Bilog Antenna	TESEQ	CBL 6111D&00800 N1D01N-06	40103&04	30MHz to 1GHz	Jan. 07, 2017	May 19, 2017~ May 31, 2017	Jan. 06, 2018	Radiation (03CH13-HY)
Horn Antenna	SCHWARZBE CK	BBHA 9120 D	9120D-152 2	1GHz ~ 18GHz	May 17, 2017	May 19, 2017~ May 31, 2017	May 16, 2018	Radiation (03CH13-HY)
SHF-EHF Horn Antenna	SCHWARZBE CK	BBHA 9170	BBHA9170 584	18GHz- 40GHz	Nov. 08, 2016	May 19, 2017~ May 31, 2017	Nov. 07, 2017	Radiation (03CH13-HY)
Spectrum Analyzer	Keysight	N9010A	MY553705 26	N/A	Mar. 15, 2017	May 19, 2017~ May 31, 2017	Mar. 14, 2018	Radiation (03CH13-HY)
Amplifier	Sonoma-Instru ment	310 N	187282	9KHz~1GHz	Dec. 21, 2016	May 19, 2017~ May 31, 2017	Dec. 20, 2017	Radiation (03CH13-HY)
Preamplifier	MITEQ	JS44-180040 00-33-8P	1840917	18GHz ~ 40GHz	Jun. 14, 2016	May 19, 2017~ May 31, 2017	Jun. 13, 2017	Radiation (03CH13-HY)
Preamplifier	MITEQ	AMF-7D-0010 1800-30-10P	1590074	1GHz~18GHz	Jun. 27, 2016	May 19, 2017~ May 31, 2017	Jun. 26, 2017	Radiation (03CH13-HY)
Preamplifier	Keysight	83017A	MY532701 47	1GHz~26.5GHz	Jan. 09, 2017	May 19, 2017~ May 31, 2017	Jan. 08, 2018	Radiation (03CH13-HY)



Instrument	Manufacturer	Model No.	Serial No.	Characteristics	Calibration Date	Test Date	Due Date	Remark
Hygrometer	TECPEL	DTM-303B	TP140349	N/A	Nov. 14, 2016	May 19, 2017~ May 31, 2017	Nov. 13, 2017	Radiation (03CH13-HY)
RF Cable	HUBER + SUHNER	SUCOFLEX 104	MY335041/ 4MY9840/4 MY9838/4	26G~40GHz	Mar. 27, 2017	May 19, 2017~ May 31, 2017	Mar. 26, 2018	Radiation (03CH13-HY)
RF Cable	HUBER + SUHNER	SUCOFLEX 104	MY335041/ 4MY9840/4 MY9838/4	1G~26GHz	Jan. 27, 2017	May 19, 2017~ May 31, 2017	Jan. 26, 2017	Radiation (03CH13-HY)
RF Cable	HUBER + SUHNER	SUCOFLEX 104	MY335041/ 4MY9840/4 MY9838/4	30M~1GHz	Jan. 27, 2017	May 19, 2017~ May 31, 2017	Jan. 26, 2018	Radiation (03CH13-HY)
RF Cable	HUBER + SUHNER	SUCOFLEX 104	MY24958/4 ,MY28653/ 4,MY9839/ 4PE	9K~30MHz	Jan. 10, 2017	May 19, 2017~ May 31, 2017	Jan. 09, 2018	Radiation (03CH13-HY)
Controller	EMEC	EM1000	N/A	Control Turn table & Ant Mast	N/A	May 19, 2017~ May 31, 2017	N/A	Radiation (03CH13-HY)
Antenna Mast	EMEC	AM-BS-4500- B	N/A	1m~4m	N/A	May 19, 2017~ May 31, 2017	N/A	Radiation (03CH13-HY)
Turn Table	EMEC	TT2000	N/A	0~360 Degree	N/A	May 19, 2017~ May 31, 2017	N/A	Radiation (03CH13-HY)
Test Software	Audix	E3	6.2009-8-2 4c	N/A	N/A	May 19, 2017~ May 31, 2017	N/A	Radiation (03CH13-HY)
Filter	Wainwright	WLKS1200-1 2SS	SN2	1.2G Low Pass	Sep. 19, 2016	May 19, 2017~ May 31, 2017	Sep. 18, 2017	Radiation (03CH13-HY)
Filter	Wainwright	WHKX12-270 0-3000-18000 -60SS	SN2	3G High Pass	Sep. 20, 2016	May 19, 2017~ May 31, 2017	Sep. 19, 2017	Radiation (03CH13-HY)



5 Uncertainty of Evaluation

Uncertainty of Conducted Emission Measurement (150 kHz ~ 30 MHz)

Measuring Uncertainty for a Level of Confidence of 95% ($U = 2Uc(y)$)	2.70
---	------

Uncertainty of Radiated Emission Measurement (30 MHz ~ 1000 MHz)

Measuring Uncertainty for a Level of Confidence of 95% ($U = 2Uc(y)$)	4.90
---	------

Uncertainty of Radiated Emission Measurement (1000 MHz ~ 18000 MHz)

Measuring Uncertainty for a Level of Confidence of 95% ($U = 2Uc(y)$)	5.40
---	------

Uncertainty of Radiated Emission Measurement (18000 MHz ~ 40000 MHz)

Measuring Uncertainty for a Level of Confidence of 95% ($U = 2Uc(y)$)	4.30
---	------

Appendix A. Conducted Test Results

Bluetooth Low Energy

Test Engineer:	Kai Liao Aking chang	Temperature:	21~25	°C
Test Date:	2017/05/16 ~ 2017/05/25	Relative Humidity:	51~54	%

TEST RESULTS DATA 6dB and 99% Occupied Bandwidth

Mod.	Data Rate	NTX	CH.	Freq. (MHz)	99% Occupied BW (MHz)	6dB BW (MHz)	6dB BW Limit (MHz)	Pass/Fail
BLE	1Mbps	1	0	2402	1.032	0.696	0.50	Pass
BLE	1Mbps	1	19	2440	1.032	0.696	0.50	Pass
BLE	1Mbps	1	39	2480	1.032	0.698	0.50	Pass

TEST RESULTS DATA Peak Power Table

Mod.	Data Rate	NTX	CH.	Freq. (MHz)	Peak Conducted Power (dBm)	Conducted Power Limit (dBm)	DG (dBi)	EIRP Power (dBm)	EIRP Power Limit (dBm)	Pass /Fail
BLE	1Mbps	1	0	2402	-0.75	30.00	-2.20	-2.95	36.00	Pass
BLE	1Mbps	1	19	2440	0.45	30.00	-2.20	-1.75	36.00	Pass
BLE	1Mbps	1	39	2480	-1.95	30.00	-2.20	-4.15	36.00	Pass

TEST RESULTS DATA Average Power Table (Reporting Only)

Mod.	Data Rate	NTX	CH.	Freq. (MHz)	Duty Factor (dB)	Average Conducted Power (dBm)
BLE	1Mbps	1	0	2402	2.19	-1.82
BLE	1Mbps	1	19	2440	2.19	-0.26
BLE	1Mbps	1	39	2480	2.19	-3.41

TEST RESULTS DATA Peak Power Density

Mod.	Data Rate	NTX	CH.	Freq. (MHz)	Peak PSD (dBm /100kHz)	Peak PSD (dBm /3kHz)	DG (dBi)	Peak PSD Limit (dBm /3kHz)	Pass/Fail
BLE	1Mbps	1	0	2402	-3.12	-17.91	-2.20	8.00	Pass
BLE	1Mbps	1	19	2440	-1.37	-16.05	-2.20	8.00	Pass
BLE	1Mbps	1	39	2480	-4.07	-18.67	-2.20	8.00	Pass

Note: PSD (dBm/ 100kHz) is a reference level used for Conducted Band Edges and Conducted Spurious Emission 20dBc limit.



Appendix B. Radiated Spurious Emission

Test Engineer :	Alex Jheng, Bill Chang, and Wilson Wu	Temperature :	24.5~24.6°C
		Relative Humidity :	55~57%

2.4GHz 2400~2483.5MHz

BLE (Band Edge @ 3m)

BLE	Note	Frequency (MHz)	Level (dBμV/m)	Over Limit (dB)	Limit Line (dBμV/m)	Read Level (dBμV)	Antenna Factor (dB/m)	Cable Loss (dB)	Preamp Factor (dB)	Ant Pos (cm)	Table Pos (deg)	Peak Avg. (P/A)	Pol. (H/V)	
BLE CH 00 2402MHz		2343.915	51.6	-22.4	74	40.69	27.2	4.78	31	368	77	P	H	
		2385.285	42.72	-11.28	54	31.64	27.31	4.83	30.99	368	77	A	H	
	*	2402	90.91	-	-	79.75	27.37	4.85	30.99	368	77	P	H	
	*	2402	90.5	-	-	79.34	27.37	4.85	30.99	368	77	A	H	
													H	
														H
			2351.37	51.6	-22.4	74	40.69	27.2	4.78	31	390	352	P	V
			2362.5	42.63	-11.37	54	31.64	27.26	4.8	31	390	352	A	V
	*		2402	87.58	-	-	76.42	27.37	4.85	30.99	390	352	P	V
	*		2402	87.06	-	-	75.9	27.37	4.85	30.99	390	352	A	V
														V
														V
BLE CH 19 2440MHz		2373.84	52.19	-21.81	74	41.14	27.31	4.8	30.99	400	81	P	H	
		2380.84	42.82	-11.18	54	31.74	27.31	4.83	30.99	400	81	A	H	
	*	2440	92.8	-	-	81.43	27.53	4.88	30.97	400	81	P	H	
	*	2440	92.3	-	-	80.93	27.53	4.88	30.97	400	81	A	H	
			2499.72	52.51	-21.49	74	40.91	27.7	4.93	30.96	400	81	P	H
			2490.83	43.21	-10.79	54	31.61	27.7	4.93	30.96	400	81	A	H
			2332.26	51.88	-22.12	74	41.05	27.15	4.76	31.01	400	252	P	V
			2388.68	42.71	-11.29	54	31.57	27.37	4.83	30.99	400	252	A	V
	*		2440	87.09	-	-	75.72	27.53	4.88	30.97	400	252	P	V
	*		2440	86.62	-	-	75.25	27.53	4.88	30.97	400	252	A	V
			2490.76	53.12	-20.88	74	41.52	27.7	4.93	30.96	400	252	P	V
			2496.08	43.16	-10.84	54	31.56	27.7	4.93	30.96	400	252	A	V



BLE CH 39 2480MHz	*	2480	90.22	-	-	78.7	27.64	4.92	30.97	393	76	P	H
	*	2480	89.78	-	-	78.26	27.64	4.92	30.97	393	76	A	H
		2488.04	52.11	-21.89	74	40.51	27.7	4.93	30.96	393	76	P	H
		2488.24	43.21	-10.79	54	31.61	27.7	4.93	30.96	393	76	A	H
													H
													H
	*	2480	85.77	-	-	74.25	27.64	4.92	30.97	400	349	P	V
	*	2480	84.54	-	-	73.02	27.64	4.92	30.97	400	349	A	V
		2489.48	52.29	-21.71	74	40.69	27.7	4.93	30.96	400	349	P	V
		2495.44	43.48	-10.52	54	31.88	27.7	4.93	30.96	400	349	A	V
													V
													V
Remark	1. No other spurious found. 2. All results are PASS against Peak and Average limit line.												



**2.4GHz 2400~2483.5MHz
BLE (Harmonic @ 3m)**

BLE	Note	Frequency (MHz)	Level (dBµV/m)	Over Limit (dB)	Limit Line (dBµV/m)	Read Level (dBµV)	Antenna Factor (dB/m)	Cable Loss (dB)	Preamp Factor (dB)	Ant Pos (cm)	Table Pos (deg)	Peak Avg. (P/A)	Pol. (H/V)	
BLE CH 00 2402MHz		4804	38.34	-35.66	74	63.16	31.76	7.65	64.75	100	0	P	H	
													H	
													H	
													H	
			4804	39.44	-34.56	74	64.26	31.76	7.65	64.75	100	0	P	V
														V
														V
BLE CH 19 2440MHz		4880	39.3	-34.7	74	63.8	31.88	7.82	64.7	100	0	P	H	
		7320	45.28	-28.72	74	62.75	37.22	9.68	64.83	100	0	P	H	
													H	
													H	
			4880	39.33	-34.67	74	63.83	31.88	7.82	64.7	100	0	P	V
			7320	44.81	-29.19	74	62.28	37.22	9.68	64.83	100	0	P	V
														V
BLE CH 39 2480MHz		4960	40.03	-33.97	74	64.15	32.04	7.98	64.63	100	0	P	H	
		7440	44.19	-29.81	74	61.28	37.56	9.77	64.88	100	0	P	H	
													H	
													H	
			4960	39.65	-34.35	74	63.77	32.04	7.98	64.63	100	0	P	V
			7440	44.44	-29.56	74	61.53	37.56	9.77	64.88	100	0	P	V
														V
Remark	1. No other spurious found.													
	2. All results are PASS against Peak and Average limit line.													



Emission below 1GHz

2.4GHz BLE (LF)

BLE	Note	Frequency	Level	Over	Limit	Read	Antenna	Cable	Preamp	Ant	Table	Peak	Pol.	
		(MHz)	(dBμV/m)	(dB)	(dBμV/m)	(dBμV)	(dB/m)	(dB)	(dB)	(cm)	(deg)	(P/A)	(H/V)	
2.4GHz BLE LF		37.02	21.09	-18.91	40	35.98	16.85	0.59	32.33			P	H	
		139.35	35.91	-7.59	43.5	52.4	14.56	1.19	32.28	100	0	P	H	
		221.97	35.64	-10.36	46	54.14	12.14	1.53	32.24			P	H	
		325.9	21.52	-24.48	46	35.47	16.36	1.76	32.14			P	H	
		829.2	29.91	-16.09	46	33.13	25.69	2.81	31.85			P	H	
		948.2	29.99	-16.01	46	30.03	27.83	3.06	31.07			P	H	
													H	
													H	
													H	
													H	
													H	
													H	
			37.02	29.97	-10.03	40	44.86	16.85	0.59	32.33	100	0	P	V
			128.82	23.83	-19.67	43.5	41.86	13.11	1.09	32.28			P	V
			217.92	23.39	-22.61	46	42.16	11.92	1.48	32.24			P	V
			409.2	19.92	-26.08	46	31.01	19	1.97	32.15			P	V
			640.2	25.71	-20.29	46	31.79	23.51	2.48	32.19			P	V
			829.2	31.95	-14.05	46	35.17	25.69	2.81	31.85			P	V
													V	
													V	
												V		
												V		
												V		
												V		
Remark	1. No other spurious found. 2. All results are PASS against limit line.													



Note symbol

*	Fundamental Frequency which can be ignored. However, the level of any unwanted emissions shall not exceed the level of the fundamental frequency.
!	Test result is over limit line.
P/A	Peak or Average
H/V	Horizontal or Vertical



A calculation example for radiated spurious emission is shown as below:

WIFI	Note	Frequency	Level	Over	Limit	Read	Antenna	Cable	Preamp	Ant	Table	Peak	Pol.
Ant.				Limit	Line	Level	Factor	Loss	Factor	Pos	Pos	Avg.	
1+2		(MHz)	(dBμV/m)	(dB)	(dBμV/m)	(dBμV)	(dB/m)	(dB)	(dB)	(cm)	(deg)	(P/A)	(H/V)
802.11b		2390	55.45	-18.55	74	54.51	32.22	4.58	35.86	103	308	P	H
CH 01													
2412MHz		2390	43.54	-10.46	54	42.6	32.22	4.58	35.86	103	308	A	H

- Level(dBμV/m) =
Antenna Factor(dB/m) + Cable Loss(dB) + Read Level(dBμV) - Preamp Factor(dB)
- Over Limit(dB) = Level(dBμV/m) – Limit Line(dBμV/m)

For Peak Limit @ 2390MHz:

- Level(dBμV/m)
= Antenna Factor(dB/m) + Cable Loss(dB) + Read Level(dBμV) - Preamp Factor(dB)
= 32.22(dB/m) + 4.58(dB) + 54.51(dBμV) – 35.86 (dB)
= 55.45 (dBμV/m)
- Over Limit(dB)
= Level(dBμV/m) – Limit Line(dBμV/m)
= 55.45(dBμV/m) – 74(dBμV/m)
= -18.55(dB)

For Average Limit @ 2390MHz:

- Level(dBμV/m)
= Antenna Factor(dB/m) + Cable Loss(dB) + Read Level(dBμV) - Preamp Factor(dB)
= 32.22(dB/m) + 4.58(dB) + 42.6(dBμV) – 35.86 (dB)
= 43.54 (dBμV/m)
- Over Limit(dB)
= Level(dBμV/m) – Limit Line(dBμV/m)
= 43.54(dBμV/m) – 54(dBμV/m)
= -10.46(dB)

Both peak and average measured complies with the limit line, so test result is “PASS”.



Appendix C. Radiated Spurious Emission

Test Engineer :	Alex Jheng, Bill Chang, and Wilson Wu	Temperature :	24.5~24.6°C
		Relative Humidity :	55~57%

Note symbol

-L	Low channel location
-R	High channel location



2.4GHz 2400~2483.5MHz

BLE (Band Edge @ 3m)

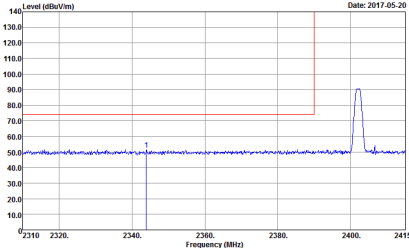
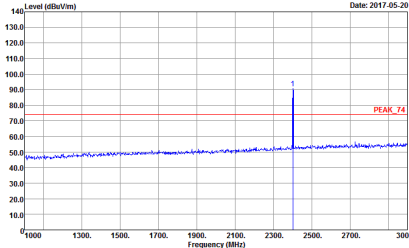
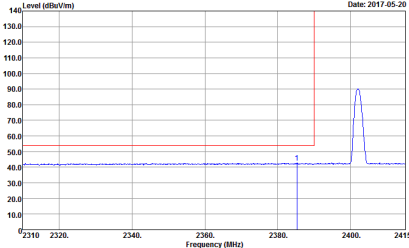
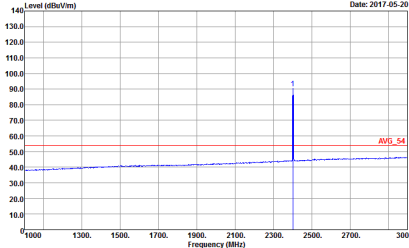
BLE	2.4GHz 2400~2483.5MHz Band Edge @ 3m	
ANT	BLE CH00 2402MHz	
1	Horizontal	Fundamental
Peak	 <p>Site : 03CH13-HY Condition : PEAK_BE_74 3m HORN_9120D_1522 HORIZONTAL</p>	 <p>Site : 03CH13-HY Condition : PEAK_74 3m HORN_9120D_1522 HORIZONTAL</p>
Avg.	 <p>Site : 03CH13-HY Condition : AVG_BE_54 3m HORN_9120D_1522 HORIZONTAL</p>	 <p>Site : 03CH13-HY Condition : AVG_54 3m HORN_9120D_1522 HORIZONTAL</p>



BLE	2.4GHz 2400~2483.5MHz Band Edge @ 3m	
ANT	BLE CH00 2402MHz	
1	Vertical	Fundamental
Peak	<p>Site : 03CH13-HY Condition : PEAK_BE_74 3m HORN_9120D_1522 VERTICAL</p>	<p>Site : 03CH13-HY Condition : PEAK_74 3m HORN_9120D_1522 VERTICAL</p>
Avg	<p>Site : 03CH13-HY Condition : AV6_BE_54 3m HORN_9120D_1522 VERTICAL</p>	<p>Site : 03CH13-HY Condition : AV6_54 3m HORN_9120D_1522 VERTICAL</p>



BLE	2.4GHz 2400~2483.5MHz Band Edge @ 3m	
ANT	BLE CH19 2440MHz - L	
1	Horizontal	Fundamental
Peak	<p>Level (dBuV/m) vs Frequency (MHz) plot for Horizontal orientation. The y-axis ranges from 10.0 to 140.0 dBuV/m, and the x-axis ranges from 2310 to 2450 MHz. A sharp peak is visible at approximately 2440 MHz. A red horizontal line is drawn at approximately 75 dBuV/m. A blue vertical line marks the peak at 2440 MHz. Date: 2017-05-20</p> <p>Site : 03CH13-HY Condition : PEAK_BE_74 3m HORN_9120D_1522 HORIZONTAL</p>	<p>Level (dBuV/m) vs Frequency (MHz) plot for Fundamental orientation. The y-axis ranges from 10.0 to 140.0 dBuV/m, and the x-axis ranges from 1000 to 3000 MHz. A sharp peak is visible at approximately 2440 MHz. A red horizontal line is drawn at approximately 75 dBuV/m, labeled 'PEAK_74'. A blue vertical line marks the peak at 2440 MHz. Date: 2017-05-20</p> <p>Site : 03CH13-HY Condition : PEAK_74 3m HORN_9120D_1522 HORIZONTAL</p>
Avg.	<p>Level (dBuV/m) vs Frequency (MHz) plot for Horizontal orientation. The y-axis ranges from 10.0 to 140.0 dBuV/m, and the x-axis ranges from 2310 to 2450 MHz. A sharp peak is visible at approximately 2440 MHz. A red horizontal line is drawn at approximately 55 dBuV/m. A blue vertical line marks the peak at 2440 MHz. Date: 2017-05-20</p> <p>Site : 03CH13-HY Condition : AV6_BE_54 3m HORN_9120D_1522 HORIZONTAL</p>	<p>Level (dBuV/m) vs Frequency (MHz) plot for Fundamental orientation. The y-axis ranges from 10.0 to 140.0 dBuV/m, and the x-axis ranges from 1000 to 3000 MHz. A sharp peak is visible at approximately 2440 MHz. A red horizontal line is drawn at approximately 55 dBuV/m, labeled 'AVG_54'. A blue vertical line marks the peak at 2440 MHz. Date: 2017-05-20</p> <p>Site : 03CH13-HY Condition : AV6_54 3m HORN_9120D_1522 HORIZONTAL</p>



BLE	2.4GHz 2400~2483.5MHz Band Edge @ 3m	
ANT	BLE CH19 2440MHz - R	
1	Horizontal	Fundamental
Peak	<p>Site : 03CH13-HY Condition : PEAK_BE_74 3m HORN_9120D_1522 HORIZONTAL</p>	Left blank
Avg.	<p>Site : 03CH13-HY Condition : AVG_BE_54 3m HORN_9120D_1522 HORIZONTAL</p>	Left blank



BLE	2.4GHz 2400~2483.5MHz Band Edge @ 3m	
ANT	BLE CH19 2440MHZ - L	
1	Vertical	Fundamental
Peak	<p>Site : 03CH13-HY Condition : PEAK_BE_74 3m HORN_9120D_1522 VERTICAL</p>	<p>Site : 03CH13-HY Condition : PEAK_74 3m HORN_9120D_1522 VERTICAL</p>
Avg.	<p>Site : 03CH13-HY Condition : AV6_BE_54 3m HORN_9120D_1522 VERTICAL</p>	<p>Site : 03CH13-HY Condition : AV6_54 3m HORN_9120D_1522 VERTICAL</p>



BLE	2.4GHz 2400~2483.5MHz Band Edge @ 3m	
ANT	BLE CH19 2440MHz - R	
1	Vertical	Fundamental
Peak	<p>Date: 2017-05-20</p> <p>Site : 03CH13-HY Condition : PEAK_BE_74 3m HORN_9120D_1522 VERTICAL</p>	Left blank
Avg.	<p>Date: 2017-05-20</p> <p>Site : 03CH13-HY Condition : AVG_BE_54 3m HORN_9120D_1522 VERTICAL</p>	Left blank

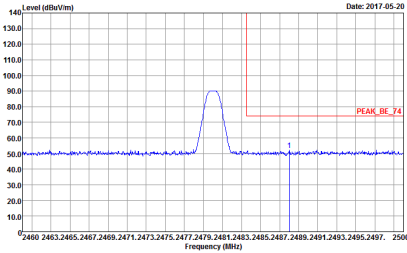
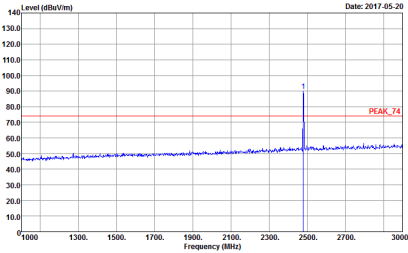
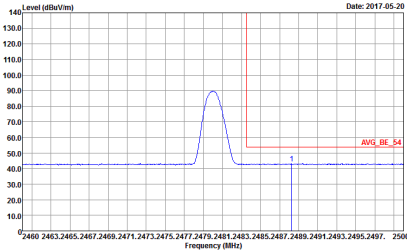
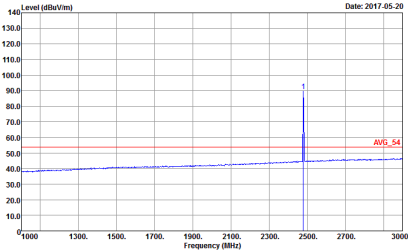

BLE	2.4GHz 2400~2483.5MHz Band Edge @ 3m	
ANT	BLE CH39 2480MHz	
1	Horizontal	Fundamental
Peak	 <p>Site : 03CH13-HY Condition : PEAK_BE_74 3m HORN_9120D_1522 HORIZONTAL</p>	 <p>Site : 03CH13-HY Condition : PEAK_74 3m HORN_9120D_1522 HORIZONTAL</p>
Avg.	 <p>Site : 03CH13-HY Condition : AV6_BE_54 3m HORN_9120D_1522 HORIZONTAL</p>	 <p>Site : 03CH13-HY Condition : AV6_54 3m HORN_9120D_1522 HORIZONTAL</p>

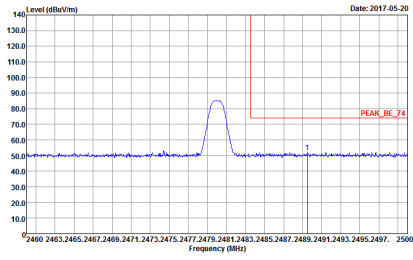
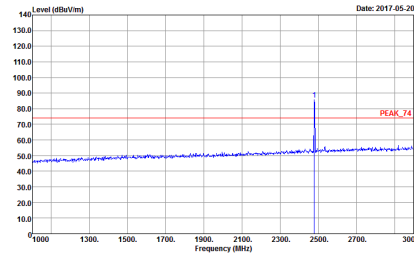
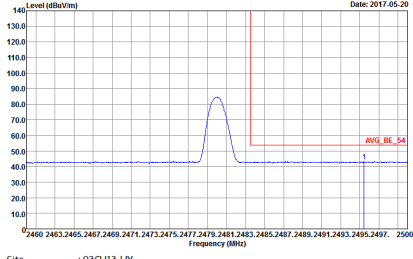
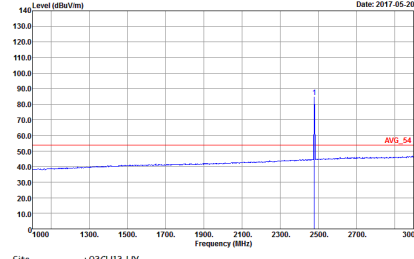

BLE	2.4GHz 2400~2483.5MHz Band Edge @ 3m	
ANT	BLE CH39 2480MHz	
1	Vertical	Fundamental
Peak	 <p>Site : 03CH13-HY Condition : PEAK_BE_74 3m HORN_9120D_1522 VERTICAL</p>	 <p>Site : 03CH13-HY Condition : PEAK_74 3m HORN_9120D_1522 VERTICAL</p>
Avg.	 <p>Site : 03CH13-HY Condition : AVG_BE_54 3m HORN_9120D_1522 VERTICAL</p>	 <p>Site : 03CH13-HY Condition : AVG_54 3m HORN_9120D_1522 VERTICAL</p>



2.4GHz 2400~2483.5MHz

BLE (Harmonic @ 3m)

BLE	2.4GHz 2400~2483.5MHz Harmonic @ 3m	
ANT	BLE CH00 2402MHz	
1	Horizontal	Vertical
Peak	<p>Site : 03CH13-1Y Condition : PEAK_74 3m SHF_HORN_584 HORIZONTAL</p>	<p>Site : 03CH13-1Y Condition : PEAK_74 3m SHF_HORN_584 VERTICAL</p>
Avg.		

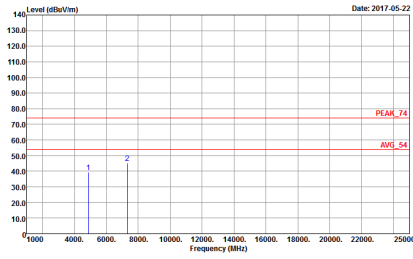
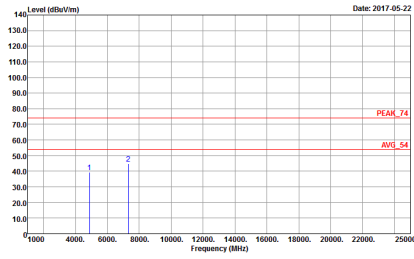

BLE	2.4GHz 2400~2483.5MHz Harmonic @ 3m	
ANT	BLE CH19 2440MHz	
1	Horizontal	Vertical
<p>Peak</p> <p>Avg.</p>	 <p>Date: 2017-05-22</p> <p>Site : 03CH13-HY Condition : PEAK_74 3m SHF_HORN_584 HORIZONTAL</p>	 <p>Date: 2017-05-22</p> <p>Site : 03CH13-HY Condition : PEAK_74 3m SHF_HORN_584 VERTICAL</p>

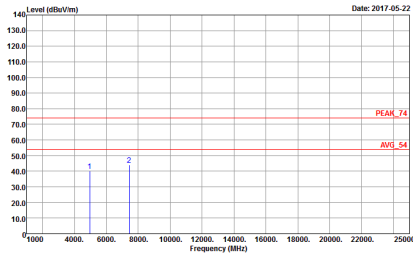
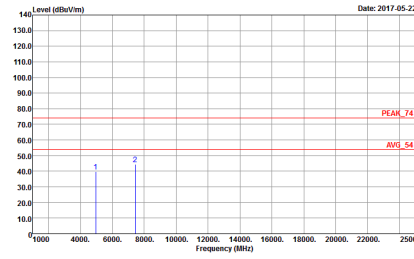

BLE	2.4GHz 2400~2483.5MHz Harmonic @ 3m	
ANT	BLE CH39 2480MHz	
1	Horizontal	Vertical
<p>Peak</p>	 <p>Date: 2017-05-22</p> <p>Site : 03CH13-HY Condition : PEAK_74 3m SHF_HORN_584 HORIZONTAL</p>	 <p>Date: 2017-05-22</p> <p>Site : 03CH13-HY Condition : PEAK_74 3m SHF_HORN_584 VERTICAL</p>



Emission below 1GHz

2.4GHz BLE (LF)

BLE	2.4GHz 2400~2483.5MHz	
ANT	BLE LF	
1	Horizontal	Vertical
QP / Peak	<p>Site : 03GH13-14Y Condition : QP 3m BILOG_40103 HORIZONTAL</p>	<p>Site : 03GH13-14Y Condition : QP 3m BILOG_40103 VERTICAL</p>



Appendix D. Duty Cycle Plots

Band	Duty Cycle(%)	T(us)	1/T(kHz)	VBW Setting
Bluetooth -LE	60.32	380	2.63	3kHz

Bluetooth - LE

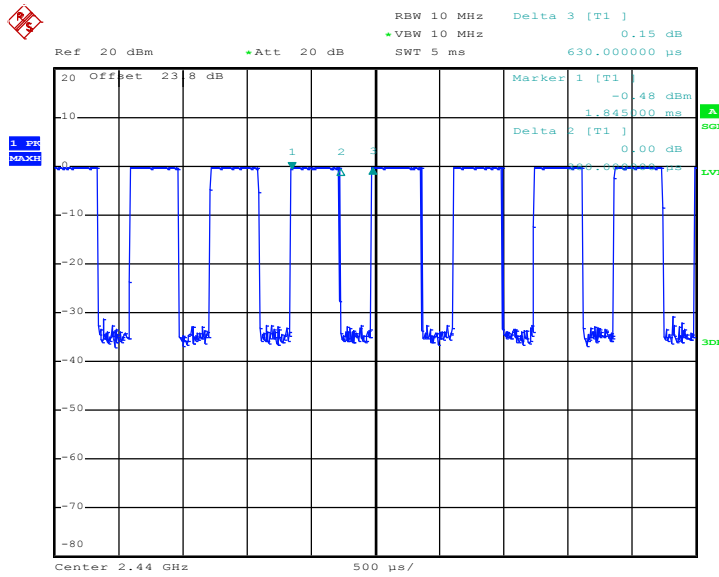

Date: 17.MAY.2017 01:43:31