



FCC RF Test Report

APPLICANT : Sony Mobile Communications Inc.
EQUIPMENT : GSM/WCDMA/LTE Phone+Bluetooth,
DTS/UNII a/b/g/n and NFC
BRAND NAME : Sony
FCC ID : PY7-44253G
STANDARD : 47 CFR Part 2, 22(H), 27
CLASSIFICATION : PCS Licensed Transmitter Held to Ear (PCE)

The product was received on May 01, 2017 and completely tested on Jun. 05, 2017. We, SPORTON INTERNATIONAL INC., would like to declare that the tested sample has been evaluated in accordance with the test procedures given in ANSI / TIA / EIA-603-D-2010 and the testing has shown the tested sample to be in compliance with the applicable technical standards.

The test results in this report apply exclusively to the tested model / sample. Without written approval of SPORTON INTERNATIONAL INC., the test report shall not be reproduced except in full.

Reviewed by: Joseph Lin / Supervisor

Approved by: Jones Tsai / Manager



SPORTON INTERNATIONAL INC.

No. 52, Hwa Ya 1st Rd., Hwa Ya Technology Park, Kwei-Shan District, Tao Yuan City, Taiwan, R.O.C.

SPORTON INTERNATIONAL INC.

TEL : 886-3-327-3456

FAX : 886-3-328-4978

FCC ID : PY7-44253G

Page Number : 1 of 24

Report Issued Date : Jul. 20, 2017

Report Version : Rev. 01

Report Template No.: BU5-FGLTE Version 1.6



TABLE OF CONTENTS

REVISION HISTORY.....3
SUMMARY OF TEST RESULT4
1 GENERAL DESCRIPTION5
1.1 Applicant.....5
1.2 Manufacturer.....5
1.3 Product Feature of Equipment Under Test.....5
1.4 Modification of EUT6
1.5 Maximum ERP/EIRP Power, Frequency Tolerance, and Emission Designator6
1.6 Testing Location7
1.7 Applicable Standards.....7
2 TEST CONFIGURATION OF EQUIPMENT UNDER TEST8
2.1 Test Mode.....8
2.2 Connection Diagram of Test System.....10
2.3 Support Unit used in test configuration and system10
2.4 Measurement Results Explanation Example.....10
2.5 Frequency List of Low/Middle/High Channels11
3 CONDUCTED TEST ITEMS13
3.1 Measuring Instruments13
3.2 Test Setup13
3.3 Test Result of Conducted Test13
3.4 Conducted Output Power and ERP/EIRP14
3.5 Peak-to-Average Ratio15
3.6 Occupied Bandwidth.....16
3.7 Conducted Band Edge17
3.8 Conducted Spurious Emission18
3.9 Frequency Stability19
4 RADIATED TEST ITEMS20
4.1 Measuring Instruments20
4.2 Test Setup20
4.3 Test Result of Radiated Test20
4.4 Radiated Spurious Emission21
5 LIST OF MEASURING EQUIPMENT22
6 UNCERTAINTY OF EVALUATION24
APPENDIX A. TEST RESULTS OF CONDUCTED TEST
APPENDIX B. TEST RESULTS OF ERP/EIRP AND RADIATED TEST



SUMMARY OF TEST RESULT

Report Section	FCC Rule	Description	Limit	Result	Remark
3.4	§2.1046	Conducted Output Power	Reporting Only	PASS	-
	§22.913(a)(2)	Effective Radiated Power (Band 5)	ERP < 7 Watt		
	§27.50(h)(2)	Equivalent Isotropic Radiated Power (Band 7) (Band 38) (Band 41)	EIRP < 2Watt		
3.5	N/A	Peak-to-Average Ratio	<13 dB	PASS	-
3.6	§2.1049	Occupied Bandwidth	Reporting Only	PASS	-
3.7	§2.1051 §22.917(a)	Conducted Band Edge Measurement (Band 5)	< 43+10log ₁₀ (P[Watts])	PASS	-
	§27.53(m)(4)	Conducted Band Edge Measurement (Band 7) (Band 38) (Band 41)	§27.53(m)(4)		
3.8	§2.1051 §22.917(a)	Conducted Spurious Emission (Band 5)	< 43+10log ₁₀ (P[Watts])	PASS	-
	§2.1051 §27.53(m)(4)	Conducted Spurious Emission (Band 7) (Band 38) (Band 41)	< 55+10log ₁₀ (P[Watts])		
3.9	§2.1055 §22.355	Frequency Stability Temperature & Voltage	< 2.5 ppm for Part 22	PASS	-
	§2.1055 §24.235 §27.54		Within Authorized Band		
4.4	§2.1053 §22.917(a)	Radiated Spurious Emission (Band 5)	< 43+10log ₁₀ (P[Watts])	PASS	Under limit 18.21 dB at 7806.000 MHz
	§2.1053 §27.53(m)(4)	Radiated Spurious Emission (Band 7) (Band 38) (Band 41)	< 55+10log ₁₀ (P[Watts])		



1 General Description

1.1 Applicant

Sony Mobile Communications Inc.

4-12-3 Higashi-Shinagawa, Shinagawa-ku, Tokyo, 140-0002, Japan

1.2 Manufacturer

Sony Mobile Communications Inc.

4-12-3 Higashi-Shinagawa, Shinagawa-ku, Tokyo, 140-0002, Japan

1.3 Product Feature of Equipment Under Test

GSM/WCDMA/LTE, Bluetooth, DTS/UNII, a/b/g/n, NFC and GPS

Product Specification subjective to this standard	
Antenna Type	C-feed Antenna

EUT Information List			
HW Version	SW Version	S/N	Performed Test Item
A	0.32	RQ3004URAR	Conducted Measurement Radiated Spurious Emission ERP/EIRP Test

Accessory List	
AC Adapter 1	Model No. : UCH20
	S/N : 1215W48600039
Earphone 1	Model No. : MH410c
	S/N : 1632A86900000FC
USB Cable	Model No. : UCB20
	S/N : 1625A91900007E2

Note:

1. Above EUT list and accessory list used are electrically identical per declared by manufacturer.
2. Above the accessories list are used to exercise the EUT during test.
3. For other wireless features of this EUT, test report will be issued separately.
4. For conducted test items except conducted output power is carrying out, FG742208-01B report reuses test data from the FG692209-01B report.
5. This device supports both LTE B41 and B38. Since the supported frequency span for LTE B38 falls completely within the supports frequency span for LTE B41, both LTE bands have the same target power, and both LTE bands share the same transmission path; therefore, this report was only assessed for LTE B41.



1.4 Modification of EUT

No modifications are made to the EUT during all test items.

1.5 Maximum ERP/EIRP Power, Frequency Tolerance, and Emission Designator

LTE Band 5		QPSK			16QAM		
BW (MHz)	Frequency Range (MHz)	Emission Designator (99%OBW)	Frequency Tolerance (ppm)	Maximum ERP(W)	Emission Designator (99%OBW)	Frequency Tolerance (ppm)	Maximum ERP(W)
1.4	824.7 ~ 848.3	1M09G7D	-	0.0538	1M09W7D	-	0.0423
3	825.5 ~ 847.5	2M79G7D	-	0.0536	2M74W7D	-	0.0438
5	826.5 ~ 846.5	4M51G7D	-	0.0532	4M50W7D	-	0.0442
10	829.0 ~ 844.0	9M07G7D	0.0128	0.0540	9M09W7D	-	0.0458
LTE Band 7		QPSK			16QAM		
BW (MHz)	Frequency Range (MHz)	Emission Designator (99%OBW)	Frequency Tolerance (ppm)	Maximum EIRP(W)	Emission Designator (99%OBW)	Frequency Tolerance (ppm)	Maximum EIRP(W)
5	2502.5 ~ 2567.5	4M55G7D	-	0.1422	4M50W7D	-	0.1211
10	2505.0 ~ 2565.0	9M13G7D	0.0072	0.1452	9M09W7D	-	0.1233
15	2507.5 ~ 2562.5	13M5G7D	-	0.1486	13M6W7D	-	0.1259
20	2510.0 ~ 2560.0	18M5G7D	-	0.1570	18M5W7D	-	0.1288
LTE Band 41		QPSK			16QAM		
BW (MHz)	Frequency Range (MHz)	Emission Designator (99%OBW)	Frequency Tolerance (ppm)	Maximum EIRP(W)	Emission Designator (99%OBW)	Frequency Tolerance (ppm)	Maximum EIRP(W)
5	2557.5 ~ 2652.5	4M50G7D	-	0.1567	4M50W7D	-	0.1230
10	2560.0 ~ 2650.0	9M01G7D	0.0097	0.1570	9M09W7D	-	0.1233
15	2562.5 ~ 2647.5	13M6G7D	-	0.1637	13M5W7D	-	0.1268
20	2565.0 ~ 2645.0	18M4G7D	-	0.1702	18M5W7D	-	0.1330



1.6 Testing Location

Sporton Lab is accredited to ISO 17025 by Taiwan Accreditation Foundation (TAF code : 1190) and the FCC designation No. TW1190 under the FCC 2.948(e) by Mutual Recognition Agreement (MRA) in FCC Test.

Test Site	SPORTON INTERNATIONAL INC.	
Test Site Location	No. 52, Hwa Ya 1 st Rd., Hwa Ya Technology Park, Kwei-Shan District, Tao Yuan City, Taiwan, R.O.C. TEL: +886-3-327-3456 FAX: +886-3-328-4978	
Test Site No.	Sporton Site No.	
	TH03-HY	03CH07-HY

1.7 Applicable Standards

According to the specifications of the manufacturer, the EUT must comply with the requirements of the following standards:

- ♦ 47 CFR Part 2, 22(H), 27
- ♦ ANSI / TIA / EIA-603-D-2010
- ♦ FCC KDB 971168 D01 Power Meas. License Digital Systems v02r02
- ♦ FCC KDB 412172 D01 Determining ERP and EIRP v01r01

Remark:

1. All test items were verified and recorded according to the standards and without any deviation during the test.
2. This EUT has also been tested and complied with the requirements of FCC Part 15, Subpart B, recorded in a separate test report.



2 Test Configuration of Equipment Under Test

2.1 Test Mode

Antenna port conducted and radiated test items listed below are performed according to KDB 971168 D01 Power Meas. License Digital Systems v02r02 with maximum output power.

Radiated measurements are performed by rotating the EUT in three different orthogonal test planes to find the maximum emission.

Test Items	Band	Bandwidth (MHz)						Modulation		RB #			Test Channel		
		1.4	3	5	10	15	20	QPSK	16QAM	1	Half	Full	L	M	H
Max. Output Power	5	Y	Y	Y	Y	-	-	Y	Y	Y	Y	Y	Y	Y	Y
	7	-	-	Y	Y	Y	Y	Y	Y	Y	Y	Y	Y	Y	Y
	41	-	-	Y	Y	Y	Y	Y	Y	Y	Y	Y	Y	Y	Y
Peak-to-Average Ratio	5				Y	-	-	Y	Y	Y		Y	Y	Y	Y
	7	-	-				Y	Y	Y	Y		Y	Y	Y	Y
	41	-	-				Y	Y	Y	Y		Y	Y	Y	Y
26dB and 99% Bandwidth	5	Y	Y	Y	Y	-	-	Y	Y			Y	Y	Y	Y
	7	-	-	Y	Y	Y	Y	Y	Y			Y	Y	Y	Y
	41	-	-	Y	Y	Y	Y	Y	Y			Y	Y	Y	Y
Conducted Band Edge	5	Y	Y	Y	Y	-	-	Y	Y	Y		Y	Y		Y
	7	-	-	Y	Y	Y	Y	Y	Y	Y		Y	Y		Y
	41	-	-	Y	Y	Y	Y	Y	Y	Y		Y	Y		Y
Conducted Spurious Emission	5	Y	Y	Y	Y	-	-	Y	Y	Y			Y	Y	Y
	7	-	-	Y	Y	Y	Y	Y	Y	Y			Y	Y	Y
	41	-	-	Y	Y	Y	Y	Y	Y	Y			Y	Y	Y
Frequency Stability	5				Y	-	-	Y				Y		Y	
	7	-	-		Y			Y				Y		Y	
	41	-	-		Y			Y				Y		Y	



Test Items	Band	Bandwidth (MHz)						Modulation		RB #			Test Channel		
		1.4	3	5	10	15	20	QPSK	16QAM	1	Half	Full	L	M	H
E.R.P/ E.I.R.P.	5	v	v	v	v	-	-	v	v	v			v	v	v
	7	-	-	v	v	v	v	v	v	v			v	v	v
	41	-	-	v	v	v	v	v	v	v			v	v	v
Radiated Spurious Emission	5	v	v	v	v	-	-	v		v				v	
	7	-	-	v	v	v	v	v		v				v	
	41	-	-	v	v	v	v	v		v				v	
Note	<ol style="list-style-type: none"> The mark "v" means that this configuration is chosen for testing The mark "-" means that this bandwidth is not supported. The device is investigated from 30MHz to 10 times of fundamental signal for radiated spurious emission test under different RB size/offset and modulations in exploratory test. Subsequently, only the worst case emissions are reported. 														

2.2 Connection Diagram of Test System

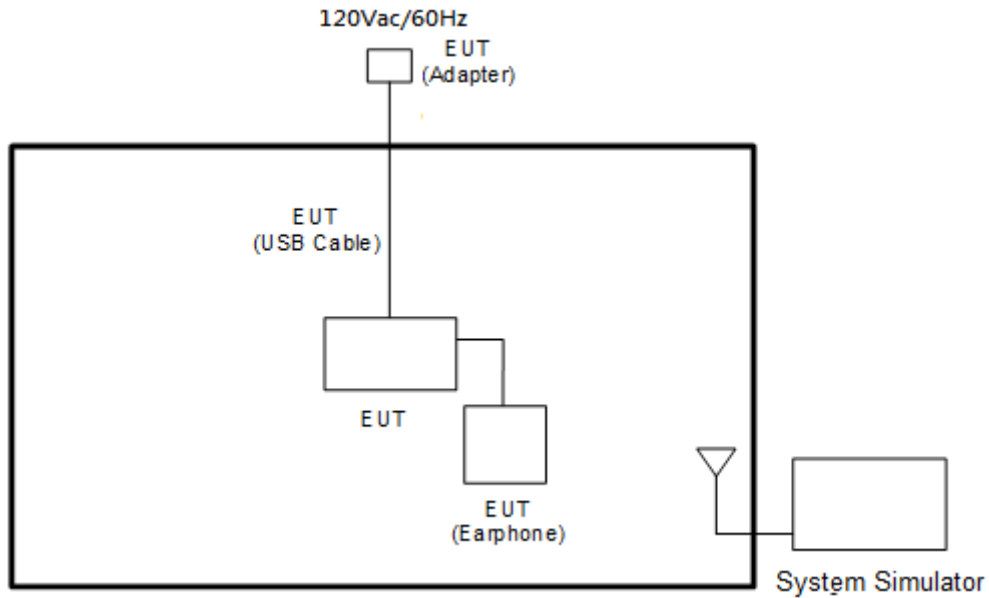

2.3 Support Unit used in test configuration and system

Item	Equipment	Trade Name	Model No.	FCC ID	Data Cable	Power Cord
1.	LTE Base Station	Anritsu	MT8820C	N/A	N/A	Unshielded, 1.8 m

2.4 Measurement Results Explanation Example

For all conducted test items:

The offset level is set in the spectrum analyzer to compensate the RF cable loss and attenuator factor between EUT conducted output port and spectrum analyzer. With the offset compensation, the spectrum analyzer reading level is exactly the EUT RF output level.

The spectrum analyzer offset is derived from RF cable loss and attenuator factor.

Offset = RF cable loss + attenuator factor.

Following shows an offset computation example with cable loss 4.2 dB and 10dB attenuator.

Example :

$$\begin{aligned} \text{Offset(dB)} &= \text{RF cable loss(dB)} + \text{attenuator factor(dB)} \\ &= 4.2 + 10 = 14.2 \text{ (dB)} \end{aligned}$$



2.5 Frequency List of Low/Middle/High Channels

LTE Band 5 Channel and Frequency List				
BW [MHz]	Channel/Frequency(MHz)	Lowest	Middle	Highest
10	Channel	20450	20525	20600
	Frequency	829	836.5	844
5	Channel	20425	20525	20625
	Frequency	826.5	836.5	846.5
3	Channel	20415	20525	20635
	Frequency	825.5	836.5	847.5
1.4	Channel	20407	20525	20643
	Frequency	824.7	836.5	848.3

LTE Band 7 Channel and Frequency List				
BW [MHz]	Channel/Frequency(MHz)	Lowest	Middle	Highest
20	Channel	20850	21100	21350
	Frequency	2510	2535	2560
15	Channel	20825	21100	21375
	Frequency	2507.5	2535	2562.5
10	Channel	20800	21100	21400
	Frequency	2505	2535	2565
5	Channel	20775	21100	21425
	Frequency	2502.5	2535	2567.5



LTE Band 38 Channel and Frequency List				
BW [MHz]	Channel/Frequency(MHz)	Lowest	Middle	Highest
20	Channel	37850	38000	38150
	Frequency	2580	2595	2610
15	Channel	37825	38000	38175
	Frequency	2577.5	2595	2612.5
10	Channel	37800	38000	38200
	Frequency	2575	2595	2615
5	Channel	37775	38000	38225
	Frequency	2572.5	2595	2617.5

LTE Band 41 Channel and Frequency List				
BW [MHz]	Channel/Frequency(MHz)	Lowest	Middle	Highest
20	Channel	40340	40740	41140
	Frequency	2565	2605	2645
15	Channel	40315	40740	41165
	Frequency	2562.5	2605	2647.5
10	Channel	40290	40740	41190
	Frequency	2560	2605	2650
5	Channel	40265	40740	41215
	Frequency	2557.5	2605	2652.5

3 Conducted Test Items

3.1 Measuring Instruments

See list of measuring instruments of this test report.

3.2 Test Setup

3.2.1 Conducted Output Power



3.2.2 Peak-to-Average Ratio, Occupied Bandwidth ,Conducted Band-Edge and Conducted Spurious Emission

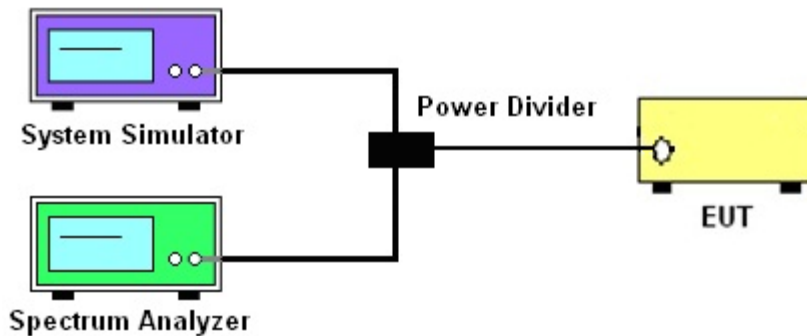

3.2.3 Frequency Stability

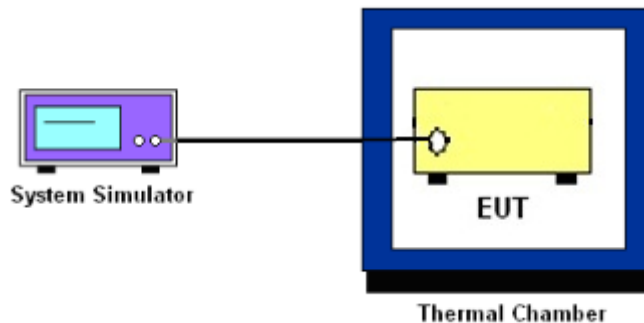

3.3 Test Result of Conducted Test

Please refer to Appendix A.



3.4 Conducted Output Power and ERP/EIRP

3.4.1 Description of the Conducted Output Power Measurement and ERP/EIRP Measurement

A system simulator was used to establish communication with the EUT. Its parameters were set to force the EUT transmitting at maximum output power. The measured power in the radio frequency on the transmitter output terminals shall be reported.

The ERP of mobile transmitters must not exceed 7 Watts for LTE Band 5.

The EIRP of mobile transmitters must not exceed 2 Watts for LTE Band 7 and Band 41

According to KDB 412172 D01 Power Approach,

$EIRP = P_T + G_T - L_C$, $ERP = EIRP - 2.15$, where

P_T = transmitter output power in dBm

G_T = gain of the transmitting antenna in dBi

L_C = signal attenuation in the connecting cable between the transmitter and antenna in dB

3.4.2 Test Procedures

1. The transmitter output port was connected to the system simulator.
2. Set EUT at maximum power through the system simulator.
3. Select lowest, middle, and highest channels for each band and different modulation.
4. Measure and record the power level from the system simulator.



3.5 Peak-to-Average Ratio

3.5.1 Description of the PAR Measurement

Power Complementary Cumulative Distribution Function (CCDF) curves provide a means for characterizing the power peaks of a digitally modulated signal on a statistical basis. A CCDF curve depicts the probability of the peak signal amplitude exceeding the average power level. Most contemporary measurement instrumentation include the capability to produce CCDF curves for an input signal provided that the instrument's resolution bandwidth can be set wide enough to accommodate the entire input signal bandwidth. In measuring transmissions in this band using an average power technique, the peak-to-average ratio (PAR) of the transmission may not exceed 13 dB.

3.5.2 Test Procedures

1. The testing follows FCC KDB 971168 v02r02 Section 5.7.1.
2. The EUT was connected to spectrum and system simulator via a power divider.
3. Set the CCDF (Complementary Cumulative Distribution Function) option in spectrum analyzer.
4. The highest RF powers were measured and recorded the maximum PAPR level associated with a probability of 0.1 %.
5. Record the deviation as Peak to Average Ratio.



3.6 Occupied Bandwidth

3.6.1 Description of Occupied Bandwidth Measurement

The occupied bandwidth is the width of a frequency band such that, below the lower and above the upper frequency limits, the mean powers emitted are each equal to a specified percentage 0.5% of the total mean transmitted power.

The 26 dB emission bandwidth is defined as the frequency range between two points, one above and one below the carrier frequency, at which the spectral density of the emission is attenuated 26 dB below the maximum in-band spectral density of the modulated signal. Spectral density (power per unit bandwidth) is to be measured with a detector of resolution bandwidth equal to approximately 1.0% of the emission bandwidth.

3.6.2 Test Procedures

1. The testing follows FCC KDB 971168 v02r02 Section 4.2.
2. The EUT was connected to spectrum analyzer and system simulator via a power divider.
3. The spectrum analyzer center frequency is set to the nominal EUT channel center frequency. The span range for the spectrum analyzer shall be between two and five times the anticipated OBW.
4. The nominal resolution bandwidth (RBW) shall be in the range of 1 to 5 % of the anticipated OBW, and the VBW shall be at least 3 times the RBW.
5. Set the detection mode to peak, and the trace mode to max hold.
6. Determine the reference value: Set the EUT to transmit a modulated signal. Allow the trace to stabilize. Set the spectrum analyzer marker to the highest level of the displayed trace.
(this is the reference value)
7. Determine the “-26 dB down amplitude” as equal to (Reference Value – X).
8. Place two markers, one at the lowest and the other at the highest frequency of the envelope of the spectral display such that each marker is at or slightly below the “-X dB down amplitude” determined in step 6. If a marker is below this “-X dB down amplitude” value it shall be placed as close as possible to this value. The OBW is the positive frequency difference between the two markers.
9. Use the 99 % power bandwidth function of the spectrum analyzer and report the measured bandwidth.



3.7 Conducted Band Edge

3.7.1 Description of Conducted Band Edge Measurement

22.917(a)

For operations in the 824 – 849 MHz band, the FCC limit is $43 + 10\log_{10}(P[\text{Watts}])$ dB below the transmitter power P(Watts) in a 100kHz bandwidth. However, in the 1MHz bands immediately outside and adjacent to the licensee's frequency block, a resolution bandwidth of at least one percent of the emission bandwidth of the fundamental emission of the transmitter may be employed.

27.53(m)(4)

For mobile digital stations, the attenuation factor shall be not less than $40 + 10 \log (P)$ dB on all frequencies between the channel edge and 5 megahertz from the channel edge, $43 + 10 \log (P)$ dB on all frequencies between 5 megahertz and X megahertz from the channel edge, and $55 + 10 \log (P)$ dB on all frequencies more than X megahertz from the channel edge, where X is the greater of 6 megahertz or the actual emission bandwidth as defined in paragraph (m)(6) of this section. In addition, the attenuation factor shall not be less that $43 + 10 \log (P)$ dB on all frequencies between 2490.5 MHz and 2496 MHz and $55 + 10 \log (P)$ dB at or below 2490.5 MHz. Mobile Satellite Service licensees operating on frequencies below 2495 MHz may also submit a documented interference complaint against BRS licensees operating on channel BRS Channel 1 on the same terms and conditions as adjacent channel BRS or EBS licensees.

3.7.2 Test Procedures

1. The testing follows FCC KDB 971168 v02r02 Section 6.0.
2. The EUT was connected to spectrum analyzer and system simulator via a power divider.
3. The band edges of low and high channels for the highest RF powers were measured.
4. Set RBW \geq 1% EBW in the 1MHz band immediately outside and adjacent to the band edge.
5. Beyond the 1 MHz band from the band edge, RBW=1MHz was used.
6. Set spectrum analyzer with RMS detector.
7. The RF fundamental frequency should be excluded against the limit line in the operating frequency band.
8. Checked that all the results comply with the emission limit line.

The limit line is derived from $43 + 10\log(P)$ dB below the transmitter power P(Watts)

For LTE Band 7,38,41, the other 40 dB, and 55 dB have additionally applied same calculation above.



3.8 Conducted Spurious Emission

3.8.1 Description of Conducted Spurious Emission Measurement

The power of any emission outside of the authorized operating frequency ranges must be lower than the transmitter power (P) by a factor of at least $43 + 10 \log (P)$ dB.

For Band 7,38,41:

The power of any emission outside of the authorized operating frequency ranges must be lower than the transmitter power (P) by a factor of at least $55 + 10 \log (P)$ dB.

It is measured by means of a calibrated spectrum analyzer and scanned from 30 MHz up to a frequency including its 10th harmonic.

3.8.2 Test Procedures

1. The testing follows FCC KDB 971168 v02r02 Section 6.0.
2. The EUT was connected to spectrum analyzer and system simulator via a power divider.
3. The RF output of EUT was connected to the spectrum analyzer by RF cable and attenuator. The path loss was compensated to the results for each measurement.
4. The middle channel for the highest RF power within the transmitting frequency was measured.
5. The conducted spurious emission for the whole frequency range was taken.
6. Make the measurement with the spectrum analyzer's RBW = 1MHz, VBW = 3MHz.
7. Set spectrum analyzer with RMS detector.
8. Taking the record of maximum spurious emission.
9. The RF fundamental frequency should be excluded against the limit line in the operating frequency band.
10. The limit line is derived from $43 + 10\log(P)$ dB below the transmitter power P(Watts)
11. For Band 7,38,41
The limit line is derived from $55 + 10\log(P)$ dB below the transmitter power P(Watts)



3.9 Frequency Stability

3.9.1 Description of Frequency Stability Measurement

The frequency stability shall be measured by variation of ambient temperature and variation of primary supply voltage to ensure that the fundamental emission stays within the authorized frequency block. The frequency stability of the transmitter shall be maintained within $\pm 0.00025\%$ ($\pm 2.5\text{ppm}$) of the center frequency.

3.9.2 Test Procedures for Temperature Variation

1. The testing follows FCC KDB 971168 v02r02 Section 9.0.
2. The EUT was set up in the thermal chamber and connected with the system simulator.
3. With power OFF, the temperature was decreased to -30°C and the EUT was stabilized before testing. Power was applied and the maximum change in frequency was recorded within one minute.
4. With power OFF, the temperature was raised in 10°C step up to 50°C . The EUT was stabilized at each step for at least half an hour. Power was applied and the maximum frequency change was recorded within one minute.

3.9.3 Test Procedures for Voltage Variation

1. The testing follows FCC KDB 971168 v02r02 Section 9.0.
2. The EUT was placed in a temperature chamber at $20\pm 5^{\circ}\text{C}$ and connected with the system simulator.
3. The power supply voltage to the EUT was varied from 85% to 115% of the nominal value measured at the input to the EUT.
4. The variation in frequency was measured for the worst case.

4 Radiated Test Items

4.1 Measuring Instruments

See list of measuring instruments of this test report.

4.2 Test Setup

4.2.1 For radiated test from 30MHz to 1GHz

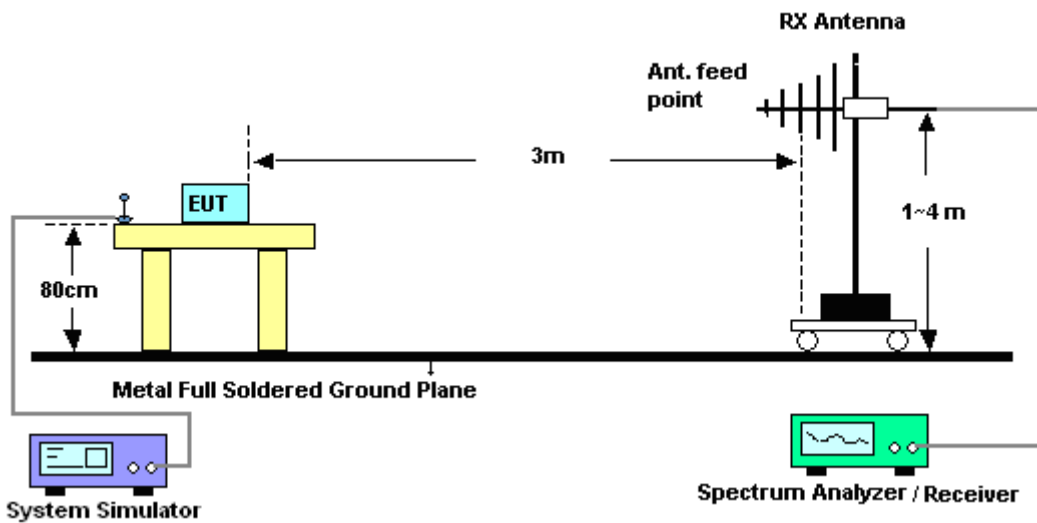

4.2.2 For radiated test above 1GHz

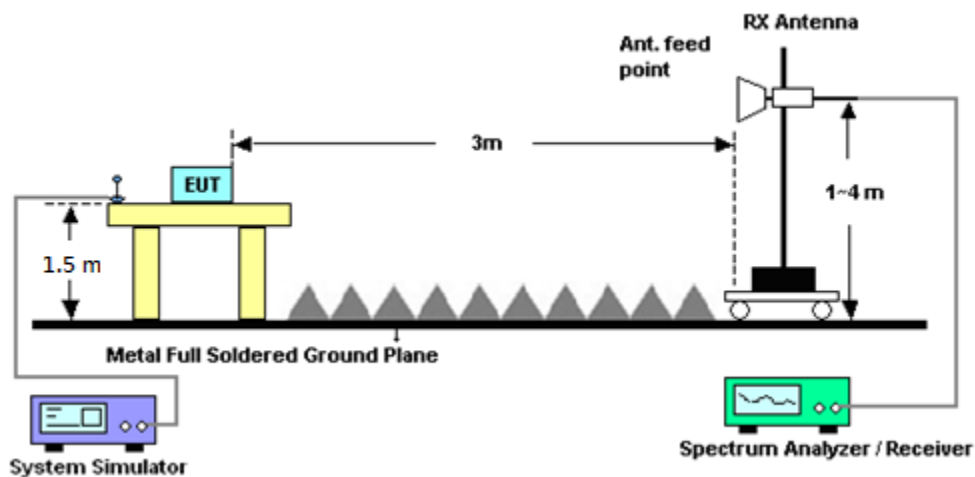

4.3 Test Result of Radiated Test

Please refer to Appendix B.



4.4 Radiated Spurious Emission

4.4.1 Description of Radiated Spurious Emission

The radiated spurious emission was measured by substitution method according to ANSI / TIA / EIA-603-D-2010. The power of any emission outside of the authorized operating frequency ranges must be attenuated below the transmitter power (P) by a factor of at least $43 + 10 \log (P)$ dB.

For Band 7,38,41

The power of any emission outside of the authorized operating frequency ranges must be attenuated below the transmitter power (P) by a factor of at least $55 + 10 \log (P)$ dB.

The spectrum is scanned from 30 MHz up to a frequency including its 10th harmonic.

4.4.2 Test Procedures

1. The testing follows FCC KDB 971168 v02r02 Section 5.8 and ANSI / TIA-603-D-2010 Section 2.2.12.
2. The EUT was placed on a turntable with 0.8 meter for frequency below 1GHz and 1.5 meter for frequency above 1GHz respectively above ground.
3. The EUT was set 3 meters from the receiving antenna, which was mounted on the antenna tower.
4. The table was rotated 360 degrees to determine the position of the highest spurious emission.
5. The height of the receiving antenna is varied between one meter and four meters to search the maximum spurious emission for both horizontal and vertical polarizations.
6. Make the measurement with the spectrum analyzer's RBW = 1MHz, VBW = 3MHz, taking the record of maximum spurious emission.
7. A horn antenna was substituted in place of the EUT and was driven by a signal generator.
8. Tune the output power of signal generator to the same emission level with EUT maximum spurious emission.
9. Taking the record of output power at antenna port.
10. Repeat step 7 to step 8 for another polarization.
11. The RF fundamental frequency should be excluded against the limit line in the operating frequency band.
The limit line is derived from $43 + 10\log(P)$ dB below the transmitter power P(Watts)
12. For Band 7,38,41:
The limit line is derived from $55 + 10\log(P)$ dB below the transmitter power P(Watts)
EIRP (dBm) = S.G. Power – Tx Cable Loss + Tx Antenna Gain
ERP (dBm) = EIRP - 2.15



5 List of Measuring Equipment

Instrument	Manufacturer	Model No.	Serial No.	Characteristics	Calibration Date	Test Date	Due Date	Remark
LTE Base Station	Anritsu	MT8820C	6201432821	GSM/GPRS /WCDMA/LTE	Oct. 11, 2016	May 11, 2017	Oct. 10, 2017	Conducted (TH05-HY)
Spectrum Analyzer	Rohde & Schwarz	FSV40	101397	10Hz~40GHz	Nov. 04, 2016	May 11, 2017	Nov. 03, 2017	Conducted (TH05-HY)
Temperature Chamber	ESPEC	SH-641	92013720	-30°C ~70°C	Sep. 01, 2016	May 11, 2017	Aug. 31, 2017	Conducted (TH05-HY)
Programmable Power Supply	GW Instek	PSS-2005	EL890089	1V~20V 0.5A~5A	Jan. 12, 2017	May 11, 2017	Jan. 11, 2018	Conducted (TH05-HY)
Hygrometer	Testo	608-H2	41410069	N/A	Aug. 28, 2016	May 11, 2017	Aug. 27, 2017	Conducted (TH05-HY)
RF Cable	HUBER + SUHNER	SUCOFLEX 104	MY84209521	1GHz~26GHz	Dec. 02, 2016	May 11, 2017	Dec. 01, 2017	Conducted (TH05-HY)
Bilog Antenna	TESEQ	CBL 6111D&008	35419&03	30MHz to 1GHz	Jan. 07, 2017	Jun. 03, 2017~ Jun. 05, 2017	Jan. 06, 2018	Radiation (03CH07-HY)
Double Ridge Horn Antenna	ESCO	3117	00075962	1GHz ~ 18GHz	Aug. 19, 2016	Jun. 03, 2017~ Jun. 05, 2017	Aug. 18, 2017	Radiation (03CH07-HY)
Horn Antenna	ESCO	3117	00066584	1GHz~18GHz	Sep. 02, 2016	Jun. 03, 2017~ Jun. 05, 2017	Sep. 01, 2017	Radiation (03CH07-HY)
SHF-EHF Horn Antenna	SCHWARZBECK	BBHA 9170	BBHA9170576	18GHz ~ 40GHz	Apr. 27, 2017	Jun. 03, 2017~ Jun. 05, 2017	Apr. 26, 2018	Radiation (03CH07-HY)
SHF-EHF Horn Antenna	SCHWARZBECK	BBHA 9170	BBHA9170584	18GHz- 40GHz	Nov. 08, 2016	Jun. 03, 2017~ Jun. 05, 2017	Nov. 07, 2017	Radiation (03CH07-HY)
Preamplifier	COM-POWER	PA-103A	161241	10MHz-1GHz	Mar. 14, 2017	Jun. 03, 2017~ Jun. 05, 2017	Mar. 13, 2018	Radiation (03CH07-HY)
Preamplifier	MITEQ	AMF-7D-00 101800-30-1	1590075	1GHz ~ 18GHz	Apr. 25, 2017	Jun. 03, 2017~ Jun. 05, 2017	Apr. 24, 2018	Radiation (03CH07-HY)
Preamplifier	MITEQ	JS44-18004 000-33-8P	1840917	18GHz ~ 40GHz	Jun. 14, 2016	Jun. 03, 2017~ Jun. 05, 2017	Jun. 13, 2017	Radiation (03CH07-HY)
Spectrum Analyzer	Agilent	N9010A	MY53470118	10Hz~44GHz	Apr. 17, 2017	Jun. 03, 2017~ Jun. 05, 2017	Apr. 16, 2018	Radiation (03CH07-HY)



Instrument	Manufacturer	Model No.	Serial No.	Characteristics	Calibration Date	Test Date	Due Date	Remark
Controller	ChainTek	Chaintek 3000	N/A	Control Turn table	N/A	Jun. 03, 2017~ Jun. 05, 2017	N/A	Radiation (03CH07-HY)
Controller	Max-Full	MF7802	MF780208368	Control Ant Mast	N/A	Jun. 03, 2017~ Jun. 05, 2017	N/A	Radiation (03CH07-HY)
Antenna Mast	Max-Full	MFA520BS	N/A	1m~4m	N/A	Jun. 03, 2017~ Jun. 05, 2017	N/A	Radiation (03CH07-HY)
Turn Table	ChainTek	Chaintek 3000	N/A	0~360 Degree	N/A	Jun. 03, 2017~ Jun. 05, 2017	N/A	Radiation (03CH07-HY)
Hygrometer	WISEWIND	410	BU5004	N/A	Mar. 20, 2017	Jun. 03, 2017~ Jun. 05, 2017	Mar. 19, 2018	Radiation (03CH07-HY)
Signal Generator	Rohde & Schwarz	SMF100A	101107	100kHz~40GHz	May 22, 2017	Jun. 03, 2017~ Jun. 05, 2017	May 21, 2018	Radiation (03CH07-HY)
RF Cable	HUBER + SUHNER	SUCOFLEX 104	Y84209521+M Y84209521	9KHz~30MHz	Jan. 03, 2017	Jun. 03, 2017~ Jun. 05, 2017	Jan. 02, 2018	Radiation (03CH07-HY)
RF Cable	HUBER + SUHNER	SUCOFLEX 104	MY84209521	30MHz~1GHz	Jan. 03, 2017	Jun. 03, 2017~ Jun. 05, 2017	Jan. 02, 2018	Radiation (03CH07-HY)
RF Cable	HUBER + SUHNER	SUCOFLEX 104	MY84209521+ MY84209521	1GHz~26GHz	Jan. 03, 2017	Jun. 03, 2017~ Jun. 05, 2017	Jan. 02, 2018	Radiation (03CH07-HY)
RF Cable	HUBER + SUHNER	SUCOFLEX 104	MY84209521+ MY84209521	26GHz~40GHz	Jan. 03, 2017	Jun. 03, 2017~ Jun. 05, 2017	Jan. 02, 2018	Radiation (03CH07-HY)
Filter	Microwave	H3G018G1	SN477220	3.0G High Pass	Nov. 22, 2016	Jun. 03, 2017~ Jun. 05, 2017	Nov. 21, 2017	Radiation (03CH07-HY)
Filter	Microwave	H1G013G1	SN477215	1.0G High Pass	Dec. 08, 2016	Jun. 03, 2017~ Jun. 05, 2017	Dec. 07, 2017	Radiation (03CH07-HY)
Filter	Wainwright	WLKS1200-12SS	SN2	1.2G Low Pass	Sep. 19, 2016	Jun. 03, 2017~ Jun. 05, 2017	Sep. 18, 2017	Radiation (03CH07-HY)
Notch Filter	Wainwright	WRCG824/849-40/8SS	SN35	CDMA 850	Nov. 22, 2016	Jun. 03, 2017~ Jun. 05, 2017	Nov. 21, 2017	Radiation (03CH07-HY)
Notch Filter	Wainwright	WRCT1850/1910-40/8S	SN21	1900	Nov. 22, 2016	Jun. 03, 2017~ Jun. 05, 2017	Nov. 21, 2017	Radiation (03CH07-HY)
Notch Filter	Wainwright	WRCT2500/2570-10/40-	SN1 R	LTE Band7	Aug. 25, 2016	Jun. 03, 2017~ Jun. 05, 2017	Aug. 24, 2017	Radiation (03CH07-HY)
Test Software	N/A	E3	6.2009-8-24 (sporton)	N/A	N/A	Jun. 03, 2017~ Jun. 05, 2017	N/A	Radiation (03CH07-HY)



6 Uncertainty of Evaluation

Uncertainty of Radiated Emission Measurement (30 MHz ~ 1000 MHz)

Measuring Uncertainty for a Level of Confidence of 95% ($U = 2Uc(y)$)	3.37
---	------

Uncertainty of Radiated Emission Measurement (1 GHz ~ 18 GHz)

Measuring Uncertainty for a Level of Confidence of 95% ($U = 2Uc(y)$)	3.67
---	------

Uncertainty of Radiated Emission Measurement (18 GHz ~ 40 GHz)

Measuring Uncertainty for a Level of Confidence of 95% ($U = 2Uc(y)$)	4.03
---	------



Appendix A. Test Results of Conducted Test

Conducted Output Power(Average power)

LTE Band 5 Maximum Average Power [dBm]						
BW [MHz]	RB Size	RB Offset	Mod	Lowest	Middle	Highest
10	1	0	QPSK	23.56	23.67	23.51
10	1	25		23.52	23.48	23.60
10	1	49		23.65	23.49	23.65
10	25	0		22.50	22.65	22.56
10	25	12		22.56	22.53	22.61
10	25	25		22.65	22.42	22.63
10	50	0		22.61	22.58	22.62
10	1	0	16-QAM	22.79	22.96	22.73
10	1	25		22.86	22.73	22.81
10	1	49		22.94	22.75	22.72
10	25	0		21.59	21.69	21.62
10	25	12		21.65	21.57	21.65
10	25	25		21.72	21.48	21.64
10	50	0		21.66	21.60	21.64
5	1	0	QPSK	23.45	23.53	23.56
5	1	12		23.50	23.47	23.60
5	1	24		23.48	23.39	23.61
5	12	0		22.44	22.52	22.54
5	12	7		22.52	22.48	22.59
5	12	13		22.54	22.41	22.57
5	25	0		22.50	22.47	22.58
5	1	0	16-QAM	22.68	22.77	22.79
5	1	12		22.79	22.71	22.75
5	1	24		22.80	22.64	22.62
5	12	0		21.53	21.57	21.59
5	12	7		21.61	21.55	21.61
5	12	13		21.64	21.47	21.55
5	25	0		21.57	21.51	21.57



LTE Band 5 Maximum Average Power [dBm]						
BW [MHz]	RB Size	RB Offset	Mod	Lowest	Middle	Highest
3	1	0	QPSK	23.48	23.52	23.62
3	1	8		23.42	23.41	23.58
3	1	14		23.48	23.44	23.64
3	8	0		22.49	22.52	22.63
3	8	4		22.50	22.48	22.64
3	8	7		22.50	22.46	22.63
3	15	0		22.56	22.55	22.69
3	1	0	16-QAM	22.67	22.76	22.76
3	1	8		22.70	22.67	22.66
3	1	14		22.76	22.69	22.68
3	8	0		21.60	21.61	21.66
3	8	4		21.62	21.57	21.64
3	8	7		21.62	21.54	21.60
3	15	0		21.63	21.59	21.67
1.4	1	0	QPSK	23.32	23.31	23.45
1.4	1	3		23.29	23.26	23.44
1.4	1	5		23.34	23.30	23.51
1.4	3	0		23.44	23.42	23.60
1.4	3	1		23.46	23.42	23.62
1.4	3	3		23.49	23.45	23.66
1.4	6	0		22.48	22.45	22.62
1.4	1	0	16-QAM	22.61	22.60	22.61
1.4	1	3		22.58	22.54	22.53
1.4	1	5		22.61	22.58	22.57
1.4	3	0		22.55	22.55	22.56
1.4	3	1		22.59	22.58	22.58
1.4	3	3		22.55	22.53	22.53
1.4	6	0		21.57	21.54	21.60



LTE Band 7 Maximum Average Power [dBm]						
BW [MHz]	RB Size	RB Offset	Mod	Lowest	Middle	Highest
20	1	0	QPSK	21.69	21.86	21.74
20	1	49		21.42	21.57	21.40
20	1	99		21.85	21.84	21.72
20	50	0		20.57	20.64	20.59
20	50	24		20.45	20.57	20.43
20	50	50		20.57	20.51	20.50
20	100	0		20.59	20.59	20.56
20	1	0	16-QAM	20.93	21.00	20.99
20	1	49		20.72	20.86	20.69
20	1	99		20.96	20.99	20.95
20	50	0		19.58	19.65	19.61
20	50	24		19.48	19.58	19.46
20	50	50		19.59	19.52	19.52
20	100	0		19.61	19.61	19.58
15	1	0	QPSK	21.44	21.59	21.39
15	1	37		21.29	21.44	21.28
15	1	74		21.51	21.62	21.45
15	36	0		20.34	20.46	20.31
15	36	20		20.28	20.42	20.29
15	36	39		20.34	20.41	20.32
15	75	0		20.33	20.42	20.30
15	1	0	16-QAM	20.70	20.88	20.67
15	1	37		20.60	20.72	20.57
15	1	74		20.78	20.90	20.72
15	36	0		19.37	19.48	19.35
15	36	20		19.32	19.44	19.33
15	36	39		19.37	19.43	19.35
15	75	0		19.36	19.45	19.33



LTE Band 7 Maximum Average Power [dBm]						
BW [MHz]	RB Size	RB Offset	Mod	Lowest	Middle	Highest
10	1	0	QPSK	21.29	21.45	21.27
10	1	25		21.27	21.41	21.27
10	1	49		21.36	21.52	21.36
10	25	0		20.25	20.40	20.22
10	25	12		20.24	20.38	20.24
10	25	25		20.22	20.33	20.22
10	50	0		20.25	20.38	20.24
10	1	0	16-QAM	20.59	20.75	20.54
10	1	25		20.58	20.69	20.55
10	1	49		20.67	20.81	20.63
10	25	0		19.31	19.44	19.28
10	25	12		19.31	19.43	19.30
10	25	25		19.28	19.39	19.28
10	50	0		19.28	19.41	19.27
5	1	0	QPSK	21.25	21.38	21.22
5	1	12		21.31	21.43	21.28
5	1	24		21.26	21.41	21.24
5	12	0		20.21	20.35	20.20
5	12	7		20.26	20.38	20.24
5	12	13		20.24	20.33	20.19
5	25	0		20.23	20.34	20.20
5	1	0	16-QAM	20.57	20.69	20.51
5	1	12		20.63	20.73	20.58
5	1	24		20.58	20.71	20.53
5	12	0		19.27	19.41	19.28
5	12	7		19.33	19.45	19.32
5	12	13		19.29	19.40	19.26
5	25	0		19.27	19.40	19.24



LTE Band 41 Maximum Average Power [dBm]						
BW [MHz]	RB Size	RB Offset	Mod	Lowest	Middle	Highest
20	1	0	QPSK	23.81	23.53	23.51
20	1	49		23.44	23.19	23.10
20	1	99		23.76	23.41	23.41
20	50	0		22.57	22.40	22.17
20	50	24		22.47	22.21	22.13
20	50	50		22.52	22.18	22.14
20	100	0		22.55	22.32	22.19
20	1	0	16-QAM	22.74	22.44	22.31
20	1	49		22.38	22.14	22.09
20	1	99		22.70	22.38	22.39
20	50	0		21.52	21.35	21.17
20	50	24		21.42	21.18	21.13
20	50	50		21.48	21.16	21.14
20	100	0		21.52	21.28	21.20
15	1	0	QPSK	23.64	23.31	23.16
15	1	37		23.44	23.14	23.06
15	1	74		23.57	23.26	23.22
15	36	0		22.43	22.17	22.03
15	36	20		22.35	22.09	22.02
15	36	39		22.38	22.08	22.04
15	75	0		22.38	22.11	22.03
15	1	0	16-QAM	22.53	22.21	22.10
15	1	37		22.33	22.03	21.98
15	1	74		22.45	22.16	22.15
15	36	0		21.39	21.14	21.04
15	36	20		21.33	21.06	21.02
15	36	39		21.35	21.05	21.03
15	75	0		21.37	21.09	21.04



LTE Band 41 Maximum Average Power [dBm]						
BW [MHz]	RB Size	RB Offset	Mod	Lowest	Middle	Highest
10	1	0	QPSK	23.46	23.13	23.02
10	1	25		23.37	23.07	23.00
10	1	49		23.41	23.13	23.09
10	25	0		22.38	22.11	22.02
10	25	12		22.35	22.07	22.02
10	25	25		22.34	22.03	22.00
10	50	0		22.35	22.06	22.01
10	1	0	16-QAM	22.41	22.08	22.00
10	1	25		22.32	22.03	21.98
10	1	49		22.36	22.10	22.07
10	25	0		21.38	21.13	21.08
10	25	12		21.37	21.09	21.06
10	25	25		21.36	21.04	21.03
10	50	0		21.32	21.03	21.00
5	1	0	QPSK	23.45	23.09	23.00
5	1	12		23.44	23.10	23.05
5	1	24		23.39	23.06	23.01
5	12	0		22.36	22.07	22.02
5	12	7		22.39	22.08	22.05
5	12	13		22.38	22.02	22.02
5	25	0		22.35	22.02	22.00
5	1	0	16-QAM	22.40	22.06	21.99
5	1	12		22.39	22.06	22.03
5	1	24		22.35	22.03	22.00
5	12	0		21.41	21.12	21.08
5	12	7		21.45	21.14	21.12
5	12	13		21.43	21.09	21.08
5	25	0		21.38	21.04	21.02



LTE Band 5

Peak-to-Average Ratio

Mode	LTE Band 5 / 10MHz				
Mod.	QPSK		16QAM		Limit: 13dB
RB Size	1RB	Full RB	1RB	Full RB	Result
Lowest CH	3.04	4.52	3.74	5.42	PASS
Middle CH	3.48	4.46	4.23	5.36	
Highest CH	3.16	4.43	4.23	5.36	



LTE Band 5 / 10MHz / QPSK

Lowest Channel / 1RB

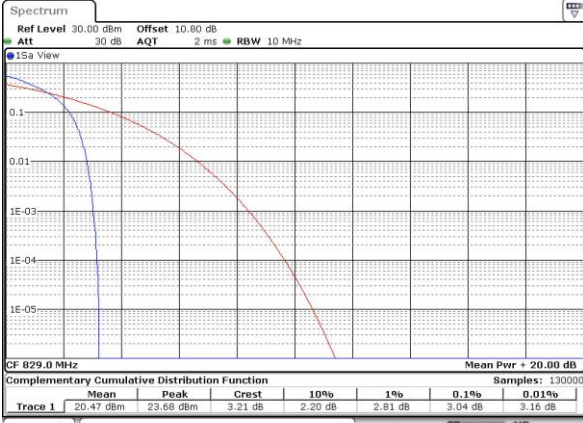

Date: 14.OCT.2016 16:28:47

Lowest Channel / Full RB

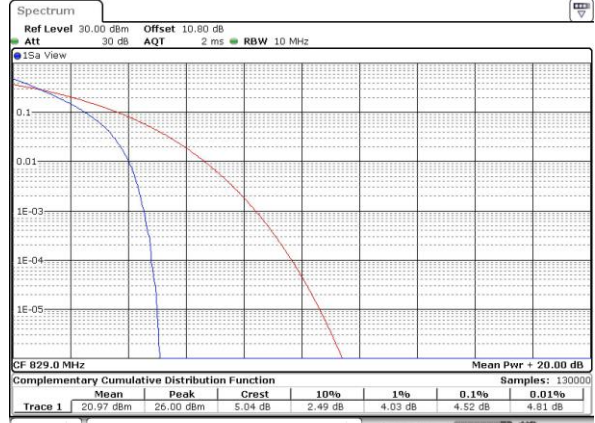

Date: 14.OCT.2016 16:27:00

Middle Channel / 1RB

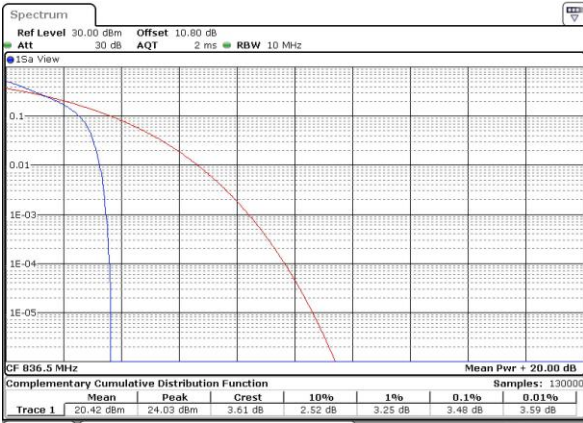

Date: 14.OCT.2016 16:27:17

Middle Channel / Full RB

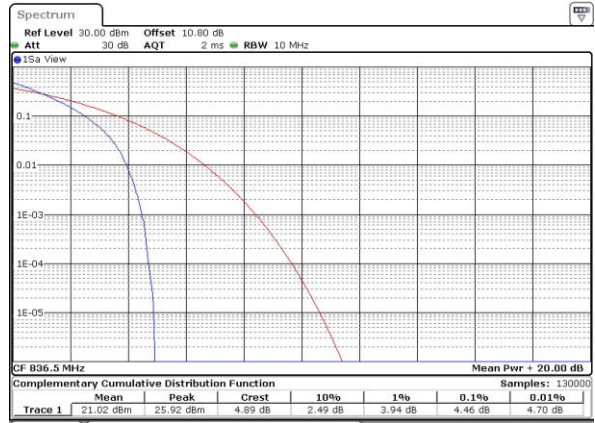

Date: 14.OCT.2016 16:27:27

Highest Channel / 1RB

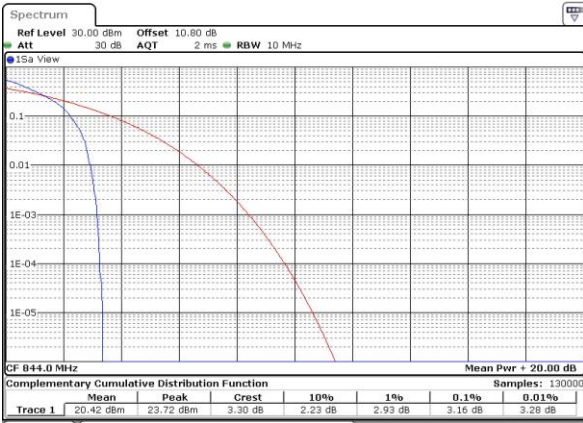

Date: 14.OCT.2016 16:27:57

Highest Channel / Full RB

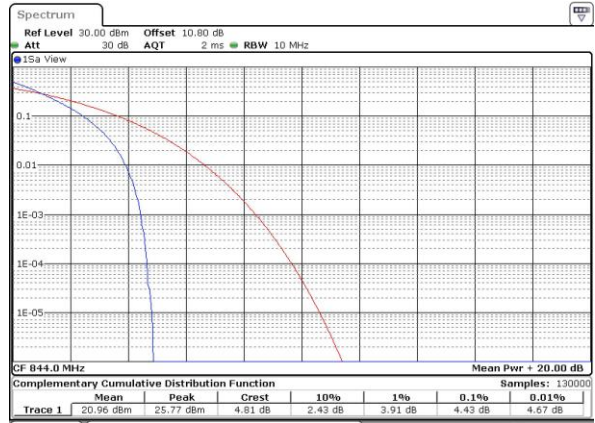

Date: 14.OCT.2016 16:28:12



LTE Band 5 / 10MHz / 16QAM

Lowest Channel / 1RB



Date: 14.OCT.2016 16:25:40

Lowest Channel / Full RB



Date: 14.OCT.2016 16:25:49

Middle Channel / 1RB



Date: 14.OCT.2016 16:25:59

Middle Channel / Full RB



Date: 14.OCT.2016 16:26:08

Highest Channel / 1RB



Date: 14.OCT.2016 16:26:18

Highest Channel / Full RB



Date: 14.OCT.2016 16:26:28



26dB Bandwidth

Mode	LTE Band 5 : 26dB BW(MHz)											
	1.4MHz		3MHz		5MHz		10MHz		15MHz		20MHz	
BW	QPSK	16QAM	QPSK	16QAM	QPSK	16QAM	QPSK	16QAM	QPSK	16QAM	QPSK	16QAM
Mod.	QPSK	16QAM	QPSK	16QAM	QPSK	16QAM	QPSK	16QAM	QPSK	16QAM	QPSK	16QAM
Lowest CH	1.25	1.27	2.98	3.01	4.97	5.04	9.79	9.81	-	-	-	-
Middle CH	1.24	1.24	3.00	3.00	4.97	4.92	10.03	9.93	-	-	-	-
Highest CH	1.25	1.28	2.95	2.99	5.06	4.93	9.99	9.83	-	-	-	-



LTE Band 5

Lowest Channel / 1.4MHz / QPSK

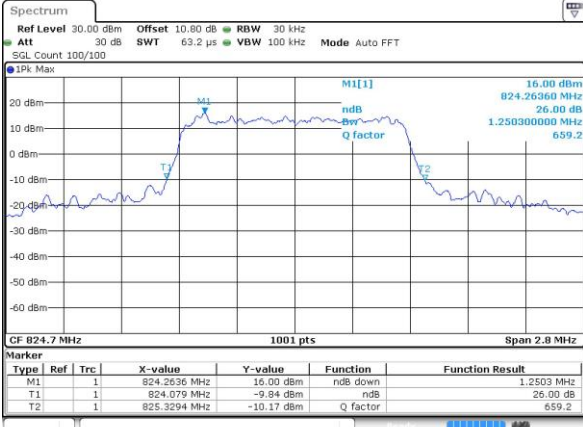

Date: 14.OCT.2016 15:34:22

Lowest Channel / 1.4MHz / 16QAM

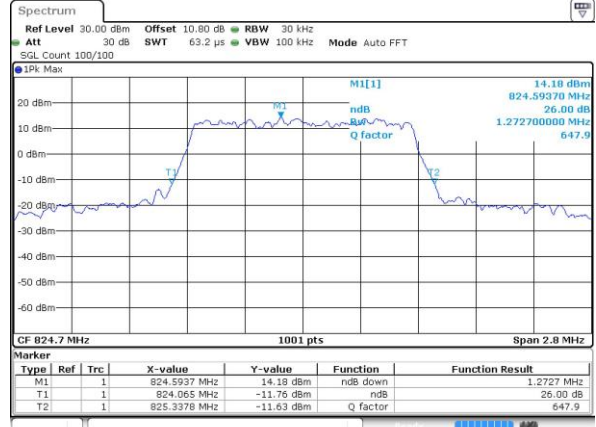

Date: 14.OCT.2016 15:34:12

Middle Channel / 1.4MHz / QPSK

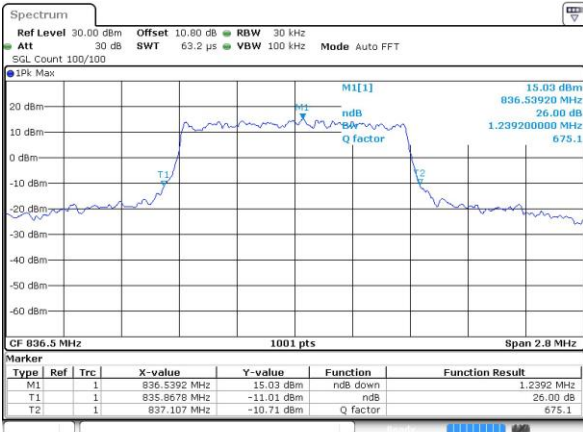

Date: 14.OCT.2016 15:43:18

Middle Channel / 1.4MHz / 16QAM

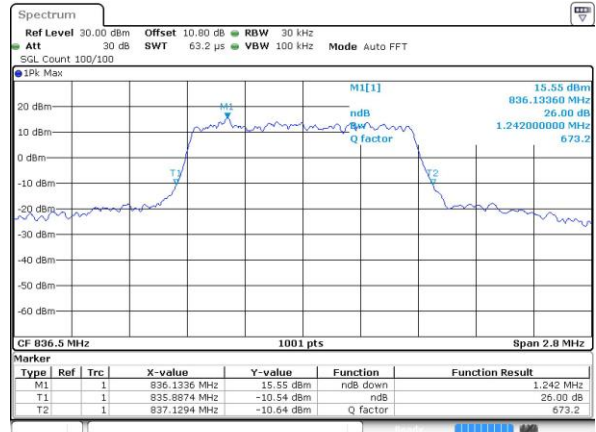

Date: 14.OCT.2016 15:43:29

Highest Channel / 1.4MHz / QPSK

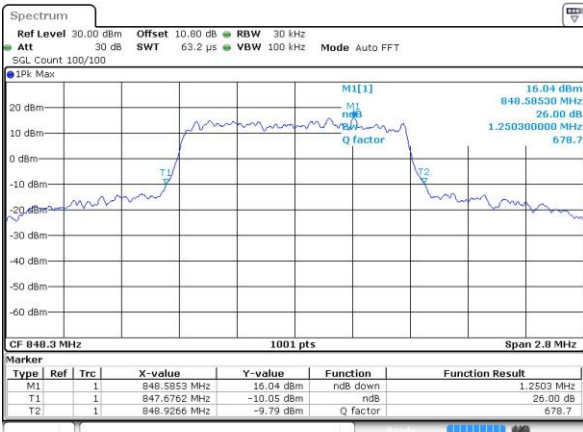

Date: 14.OCT.2016 15:45:48

Highest Channel / 1.4MHz / 16QAM

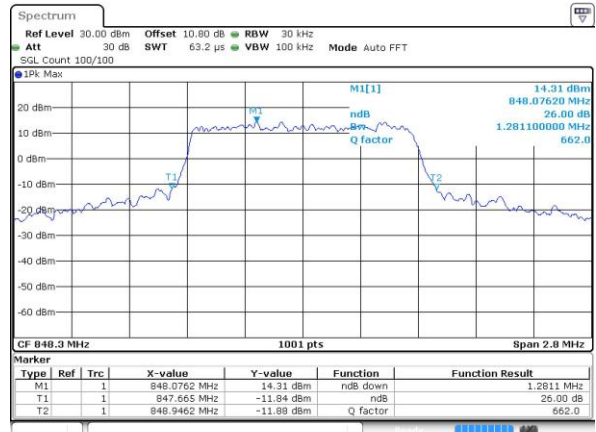

Date: 14.OCT.2016 15:45:58



LTE Band 5

Lowest Channel / 3MHz / QPSK

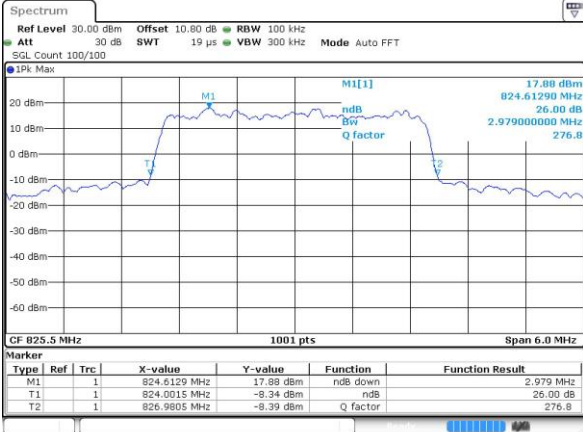

Date: 14.OCT.2016 14:32:05

Lowest Channel / 3MHz / 16QAM

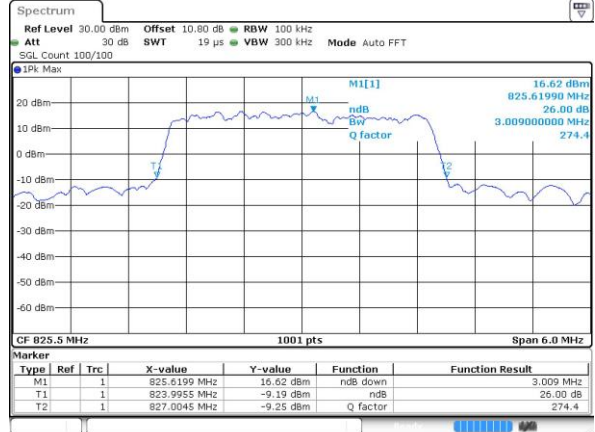

Date: 14.OCT.2016 14:32:15

Middle Channel / 3MHz / QPSK

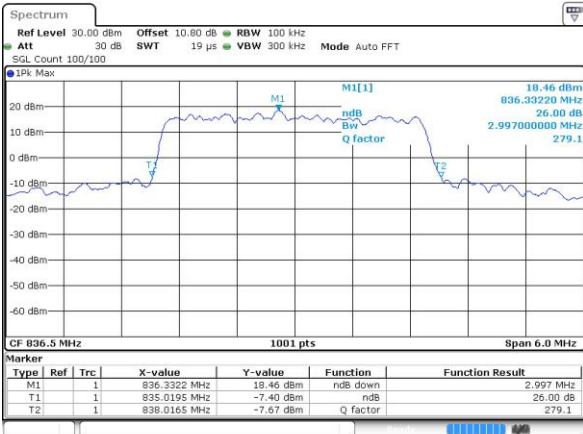

Date: 14.OCT.2016 14:41:12

Middle Channel / 3MHz / 16QAM

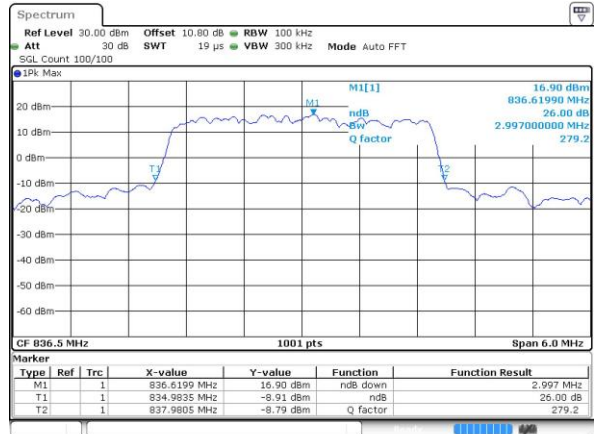

Date: 14.OCT.2016 14:41:23

Highest Channel / 3MHz / QPSK

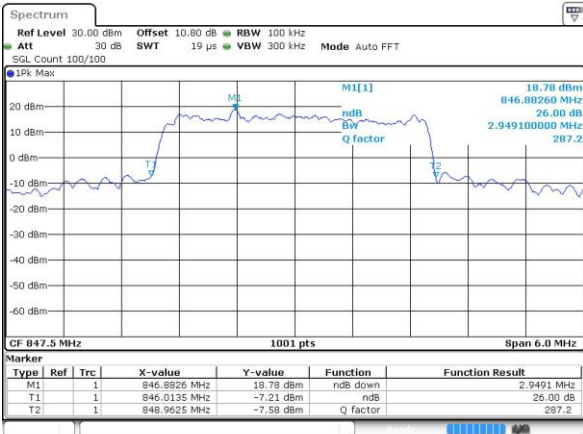

Date: 14.OCT.2016 14:43:42

Highest Channel / 3MHz / 16QAM

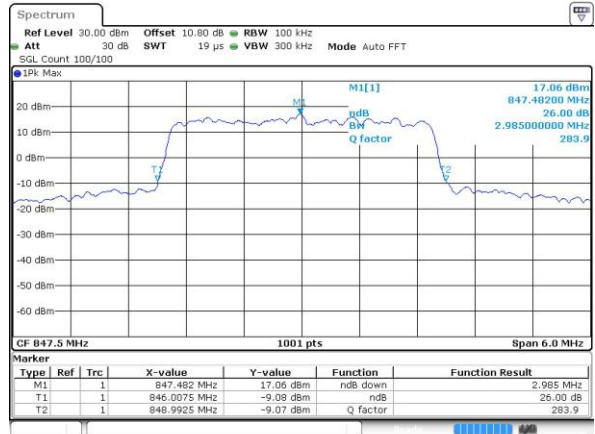

Date: 14.OCT.2016 14:43:53



LTE Band 5

Lowest Channel / 5MHz / QPSK

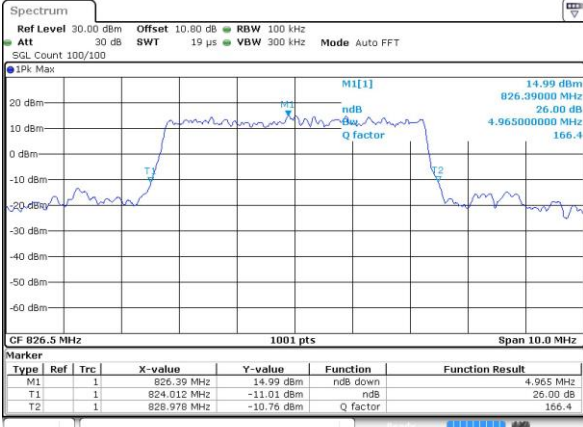

Date: 14.OCT.2016 14:52:48

Lowest Channel / 5MHz / 16QAM

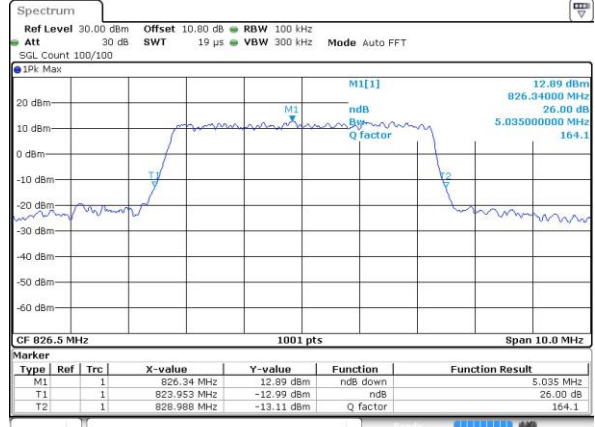

Date: 14.OCT.2016 14:52:59

Middle Channel / 5MHz / QPSK

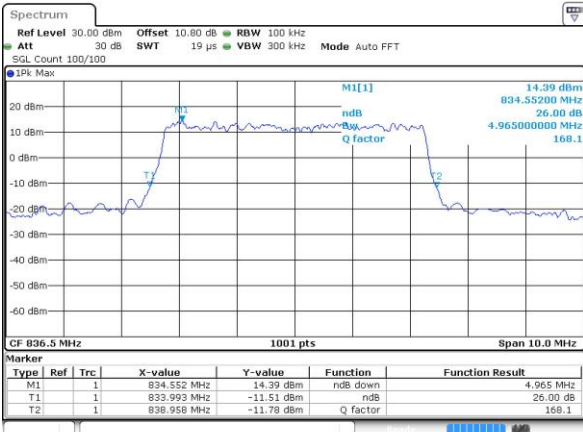

Date: 14.OCT.2016 15:01:54

Middle Channel / 5MHz / 16QAM

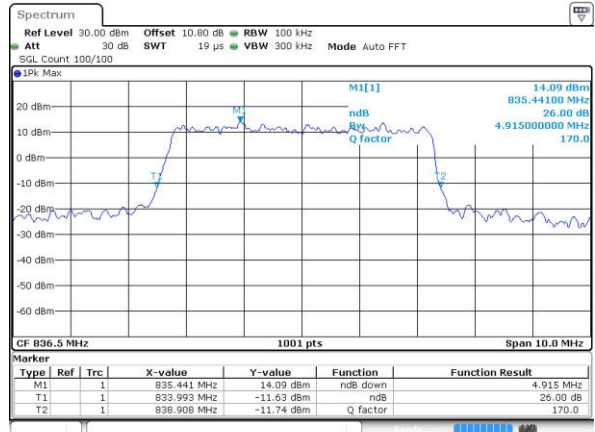

Date: 14.OCT.2016 15:02:05

Highest Channel / 5MHz / QPSK

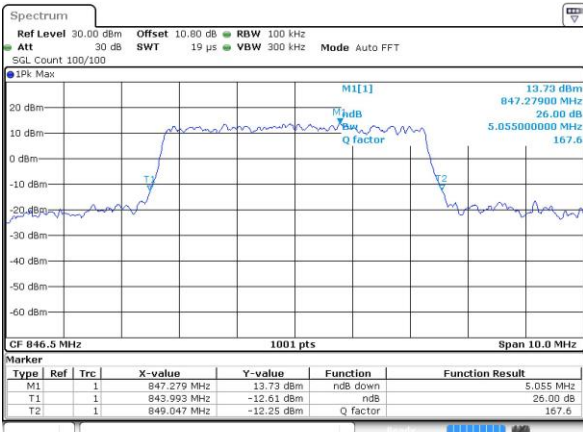

Date: 14.OCT.2016 15:04:24

Highest Channel / 5MHz / 16QAM

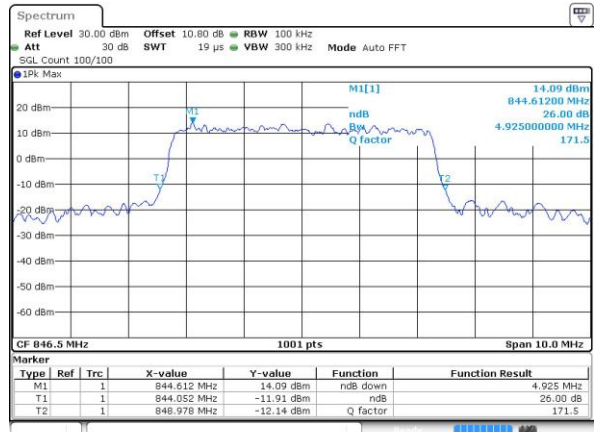

Date: 14.OCT.2016 15:04:34



LTE Band 5

Lowest Channel / 10MHz / QPSK

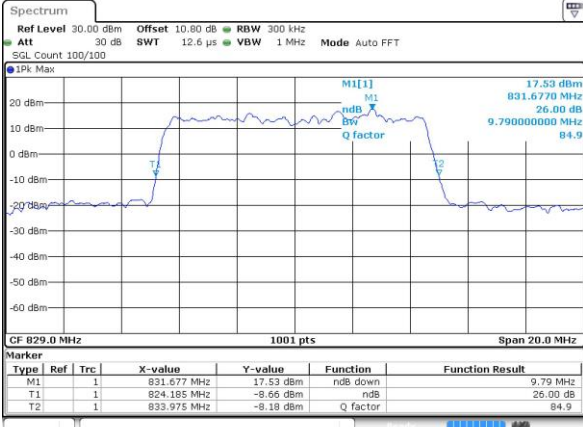

Date: 14.OCT.2016 15:13:30

Lowest Channel / 10MHz / 16QAM

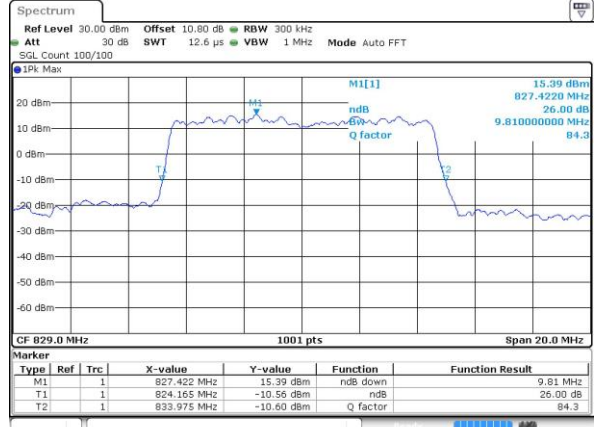

Date: 14.OCT.2016 15:13:40

Middle Channel / 10MHz / QPSK

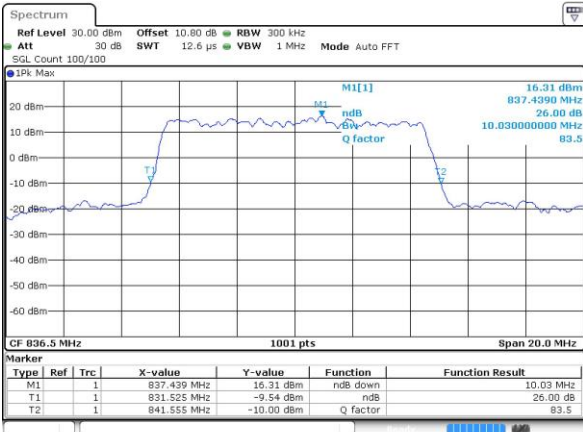

Date: 14.OCT.2016 15:22:38

Middle Channel / 10MHz / 16QAM

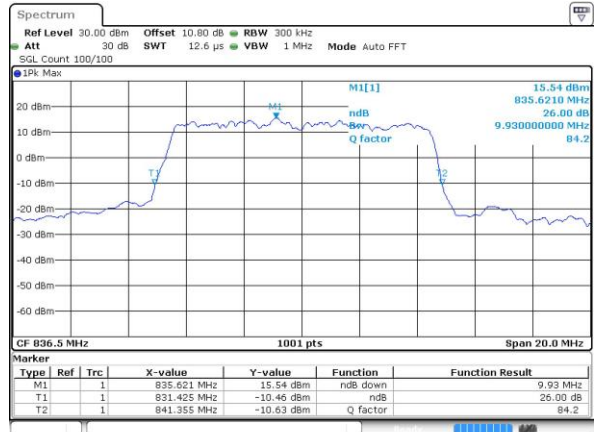

Date: 14.OCT.2016 15:22:46

Highest Channel / 10MHz / QPSK

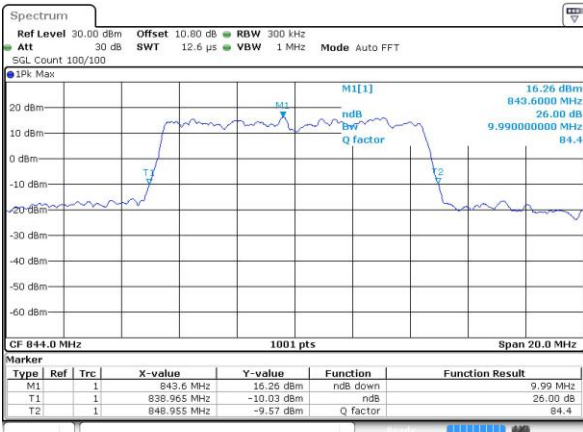

Date: 14.OCT.2016 15:25:05

Highest Channel / 10MHz / 16QAM

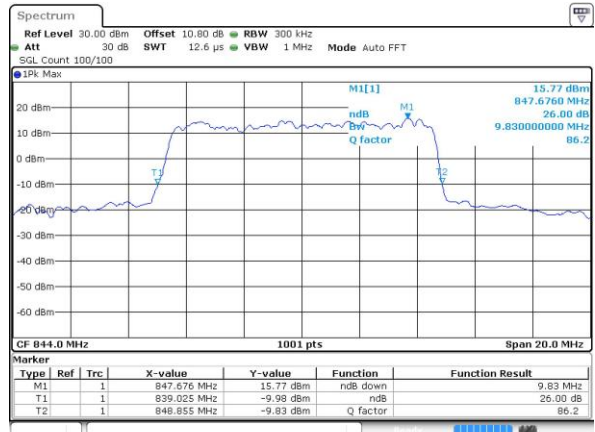

Date: 14.OCT.2016 15:25:16



Occupied Bandwidth

Mode	LTE Band 5 : 99%OBW(MHz)											
	1.4MHz		3MHz		5MHz		10MHz		15MHz		20MHz	
BW	QPSK	16QAM	QPSK	16QAM	QPSK	16QAM	QPSK	16QAM	QPSK	16QAM	QPSK	16QAM
Lowest CH	1.09	1.09	2.73	2.72	4.5	4.5	9.05	9.05	-	-	-	-
Middle CH	1.09	1.09	2.79	2.74	4.51	4.48	9.07	9.09	-	-	-	-
Highest CH	1.09	1.09	2.76	2.72	4.51	4.5	9.03	9.09	-	-	-	-



LTE Band 5

Lowest Channel / 1.4MHz / QPSK

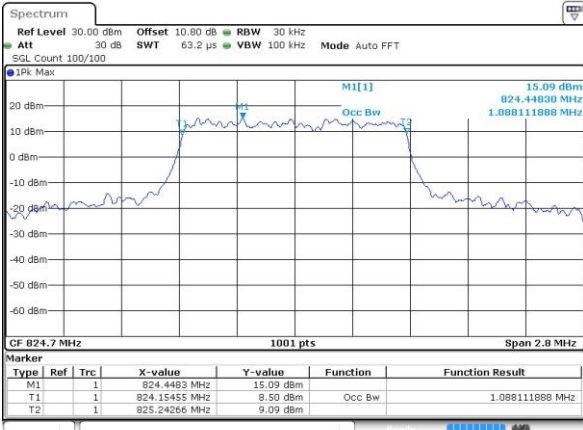

Date: 14.OCT.2016 15:33:51

Lowest Channel / 1.4MHz / 16QAM

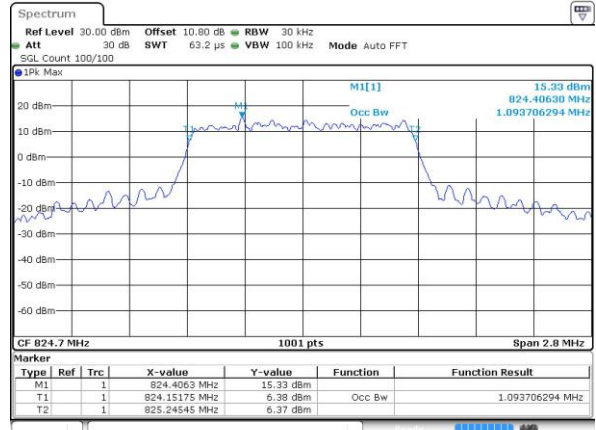

Date: 14.OCT.2016 15:34:02

Middle Channel / 1.4MHz / QPSK

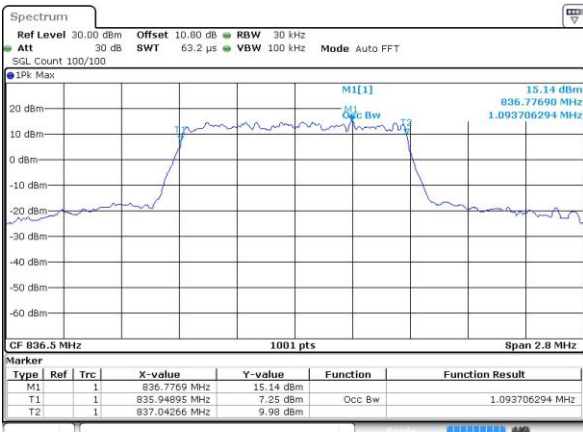

Date: 14.OCT.2016 15:42:58

Middle Channel / 1.4MHz / 16QAM

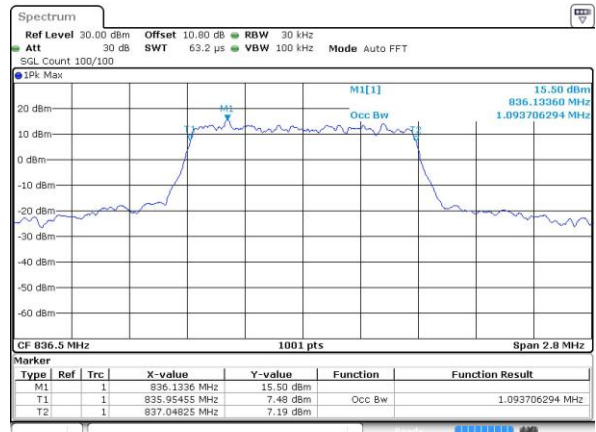

Date: 14.OCT.2016 15:43:08

Highest Channel / 1.4MHz / QPSK

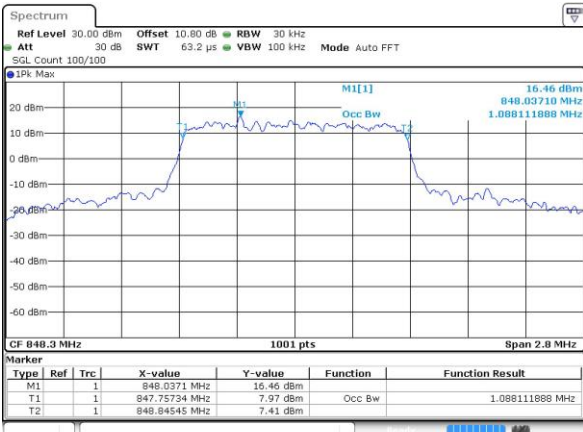

Date: 14.OCT.2016 15:45:27

Highest Channel / 1.4MHz / 16QAM

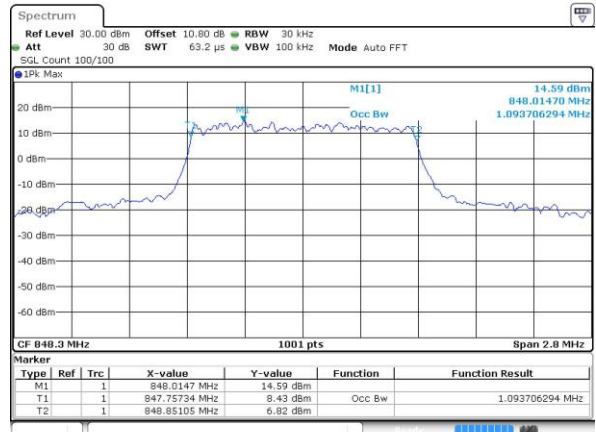

Date: 14.OCT.2016 15:45:38



LTE Band 5

Lowest Channel / 3MHz / QPSK

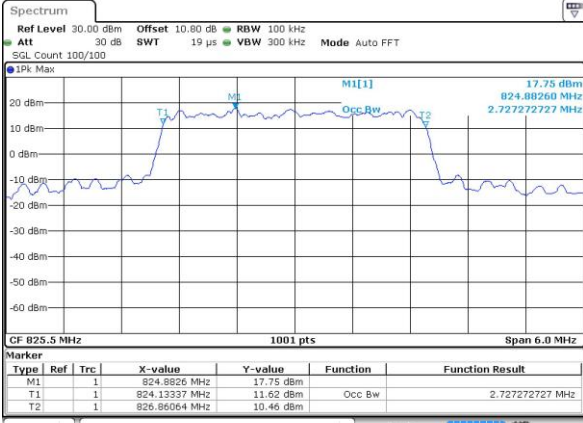

Date: 14.OCT.2016 14:31:44

Lowest Channel / 3MHz / 16QAM

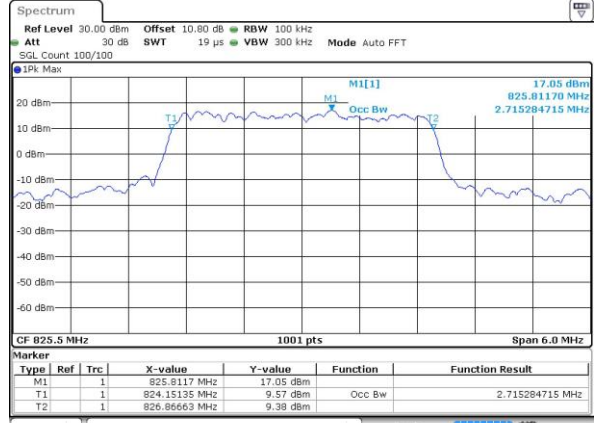

Date: 14.OCT.2016 14:31:55

Middle Channel / 3MHz / QPSK

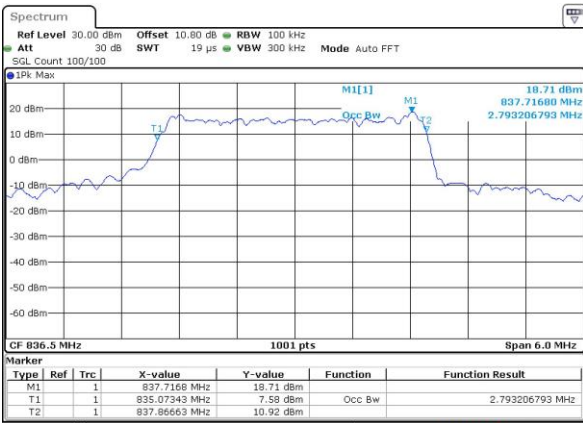

Date: 14.OCT.2016 14:40:52

Middle Channel / 3MHz / 16QAM

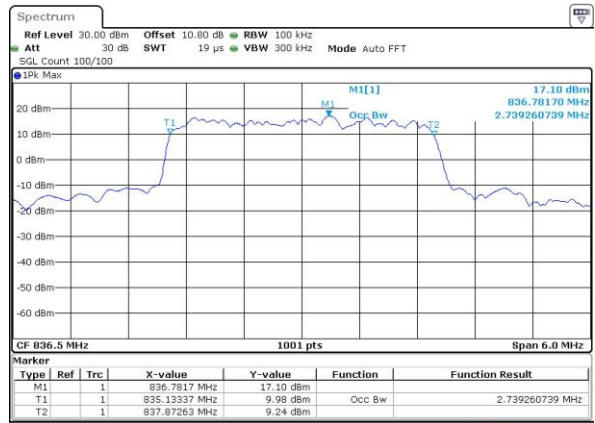

Date: 14.OCT.2016 14:41:02

Highest Channel / 3MHz / QPSK

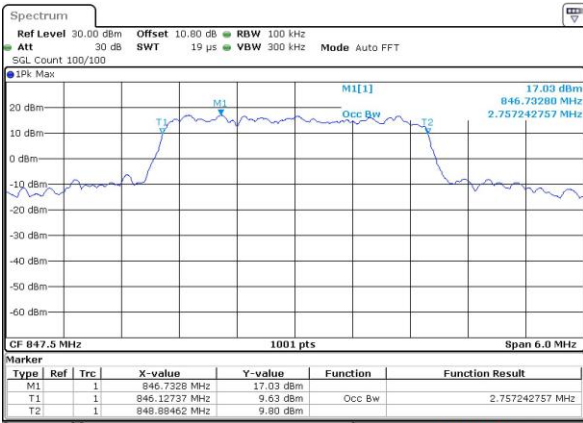

Date: 14.OCT.2016 14:43:22

Highest Channel / 3MHz / 16QAM

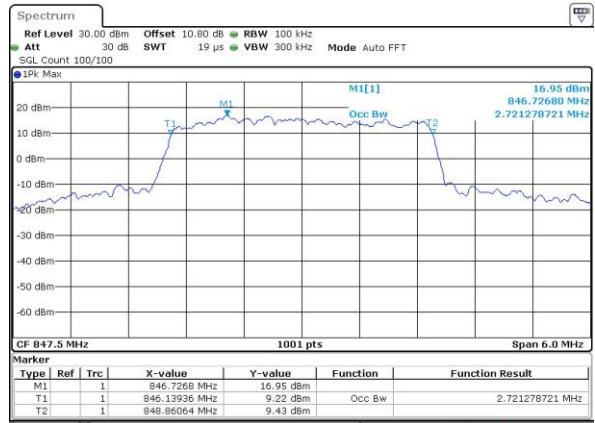

Date: 14.OCT.2016 14:43:32



LTE Band 5

Lowest Channel / 5MHz / QPSK

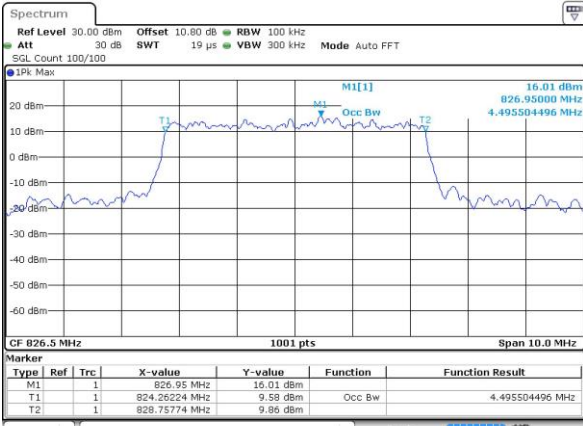

Date: 14.OCT.2016 14:52:28

Lowest Channel / 5MHz / 16QAM

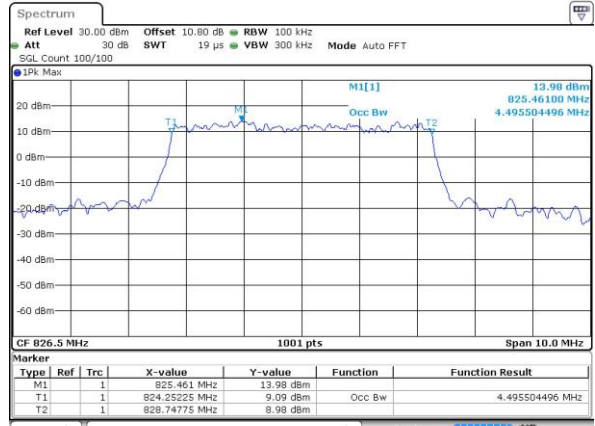

Date: 14.OCT.2016 14:52:38

Middle Channel / 5MHz / QPSK

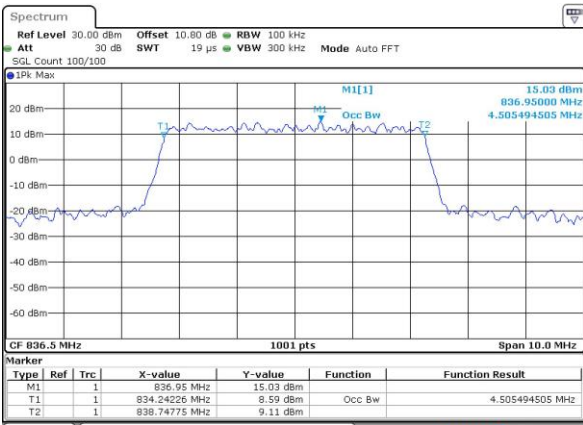

Date: 14.OCT.2016 15:01:34

Middle Channel / 5MHz / 16QAM

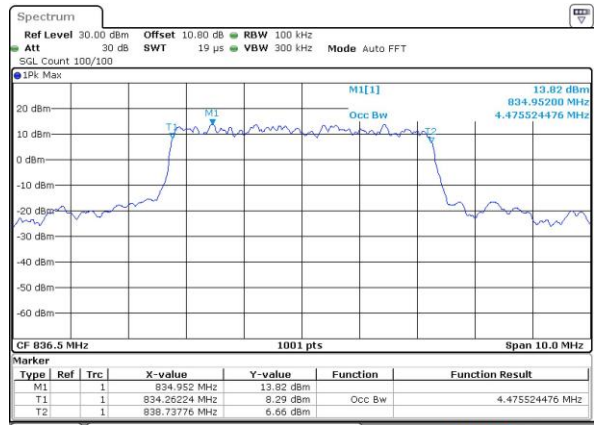

Date: 14.OCT.2016 15:01:44

Highest Channel / 5MHz / QPSK

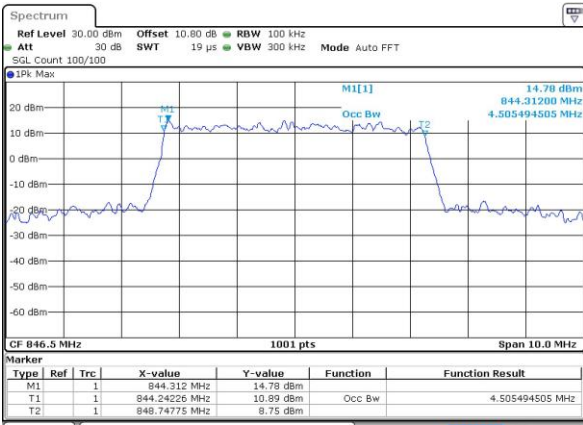

Date: 14.OCT.2016 15:04:03

Highest Channel / 5MHz / 16QAM

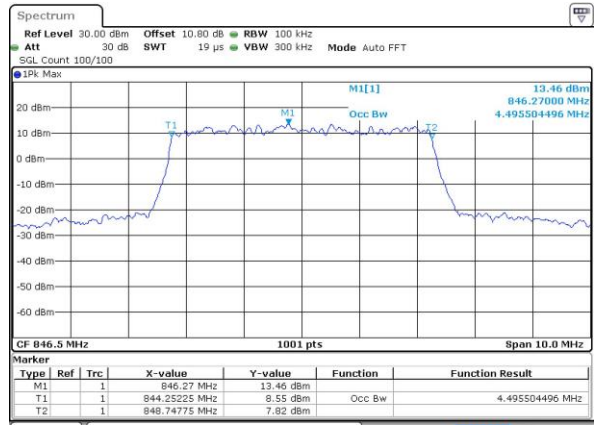

Date: 14.OCT.2016 15:04:13



LTE Band 5

Lowest Channel / 10MHz / QPSK

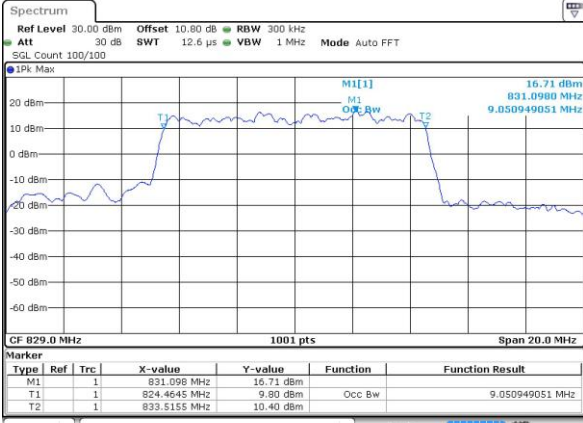

Date: 14.OCT.2016 15:13:09

Lowest Channel / 10MHz / 16QAM

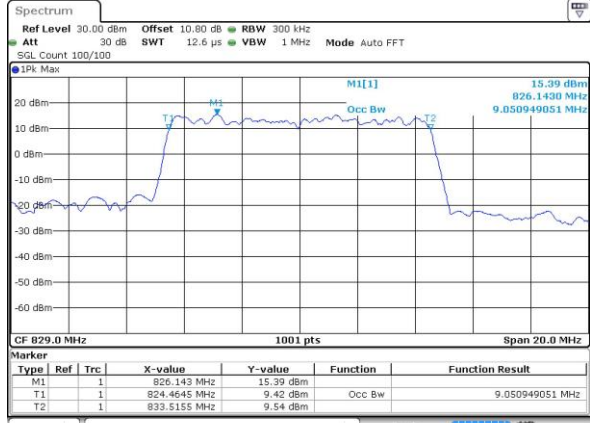

Date: 14.OCT.2016 15:13:19

Middle Channel / 10MHz / QPSK

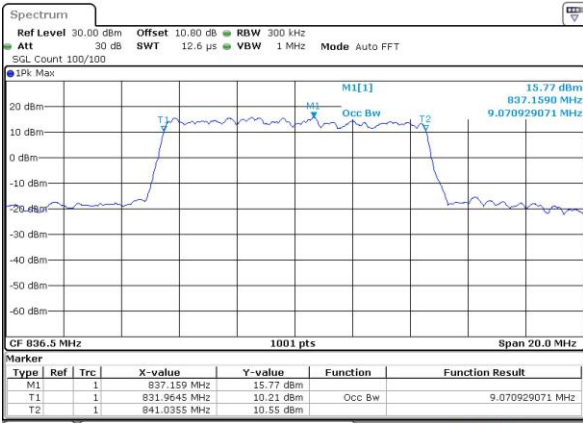

Date: 14.OCT.2016 15:22:15

Middle Channel / 10MHz / 16QAM

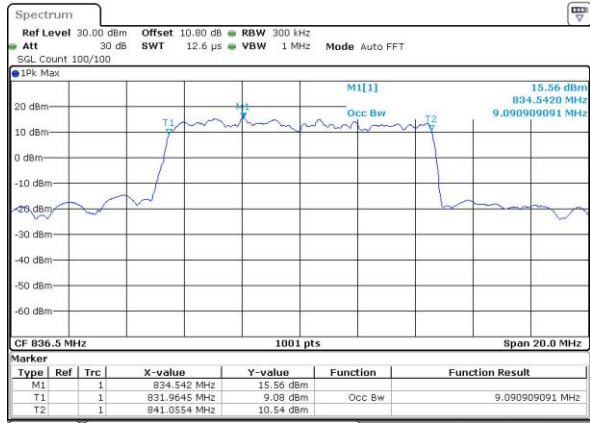

Date: 14.OCT.2016 15:22:25

Highest Channel / 10MHz / QPSK

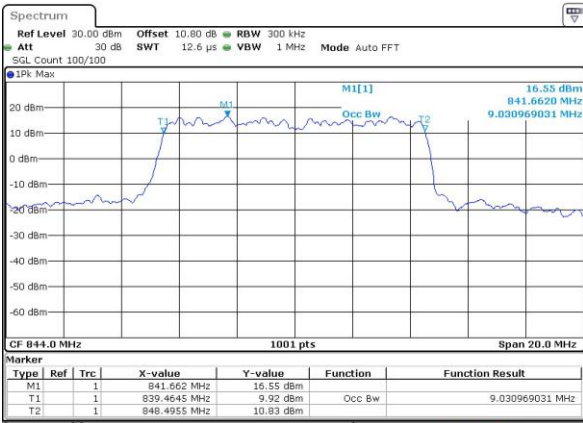

Date: 14.OCT.2016 15:24:45

Highest Channel / 10MHz / 16QAM

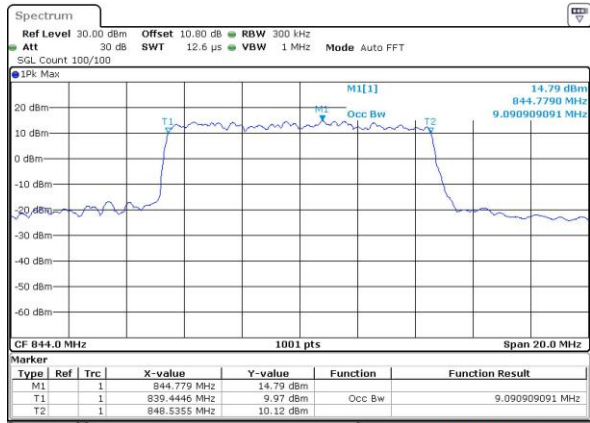

Date: 14.OCT.2016 15:24:55



Conducted Band Edge

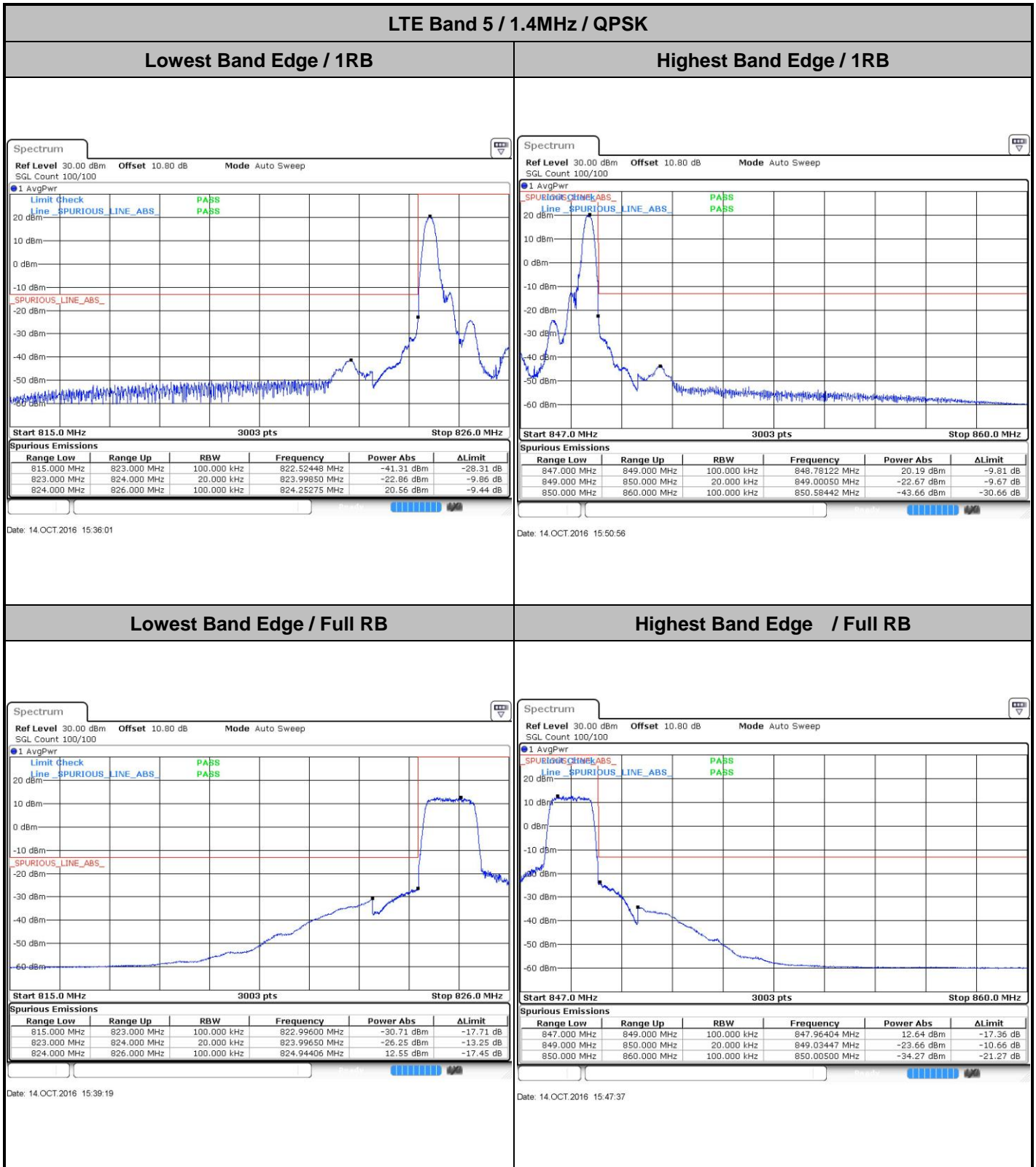



LTE Band 5 / 1.4MHz / 16QAM

Lowest Band Edge / 1 RB

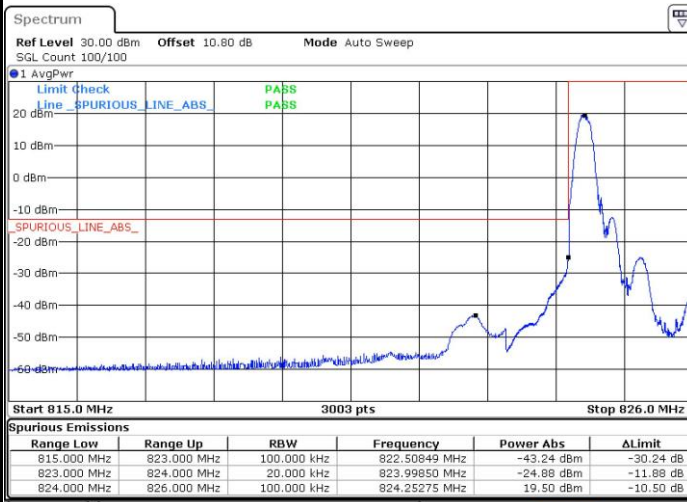

Date: 14.OCT.2016 15:37:40

Highest Band Edge / 1 RB

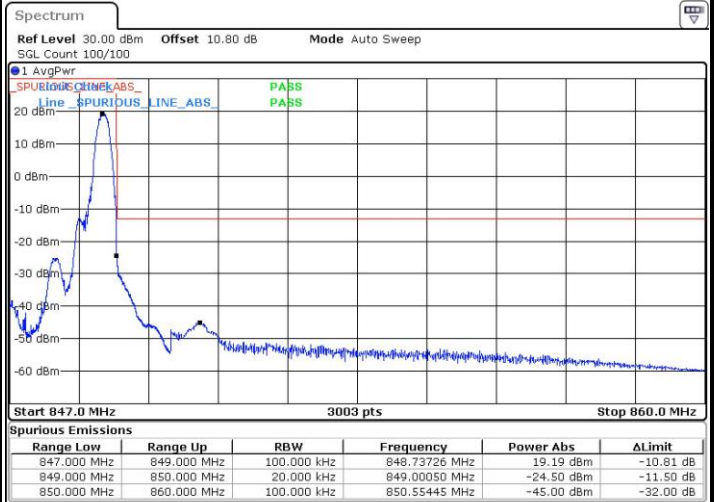

Date: 14.OCT.2016 15:52:35

Lowest Band Edge / Full RB

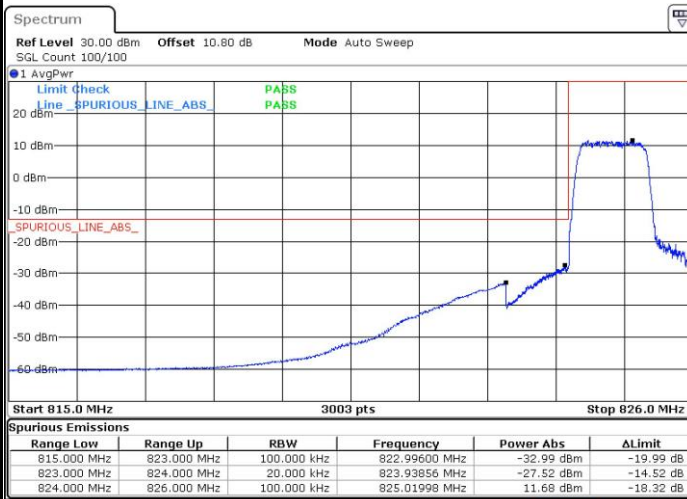

Date: 14.OCT.2016 15:40:58

Highest Band Edge / Full RB



Date: 14.OCT.2016 15:49:16



LTE Band 5 / 3MHz / QPSK

Lowest Band Edge / 1RB

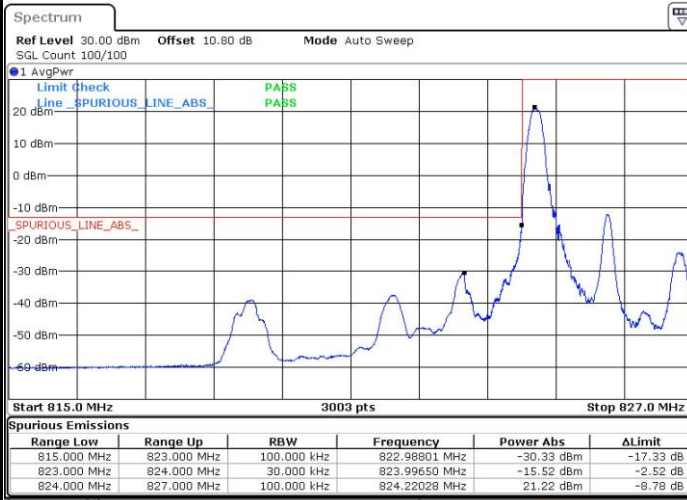

Date: 14.OCT.2016 14:33:54

Highest Band Edge / 1 RB



Date: 14.OCT.2016 14:45:31

Lowest Band Edge / Full RB

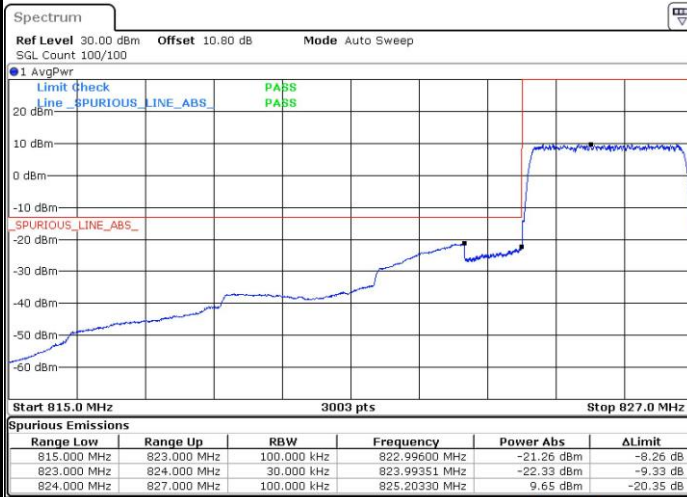

Date: 14.OCT.2016 14:37:13

Highest Band Edge / Full RB



Date: 14.OCT.2016 14:48:50



LTE Band 5 / 3MHz / 16QAM

Lowest Band Edge / 1 RB

Highest Band Edge / 1 RB

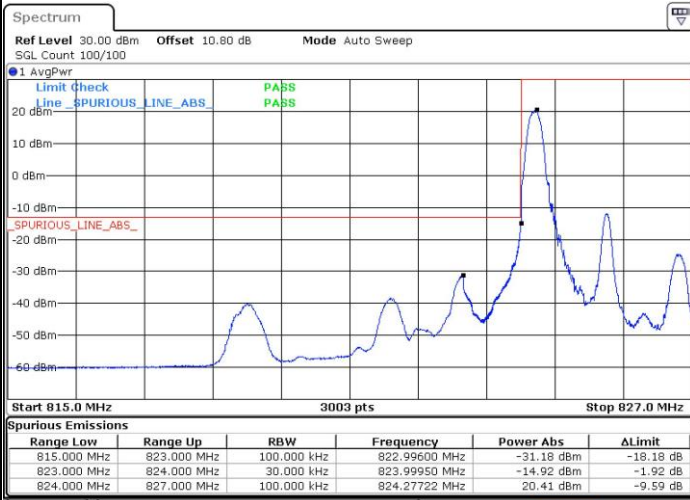

Date: 14.OCT.2016 14:35:34

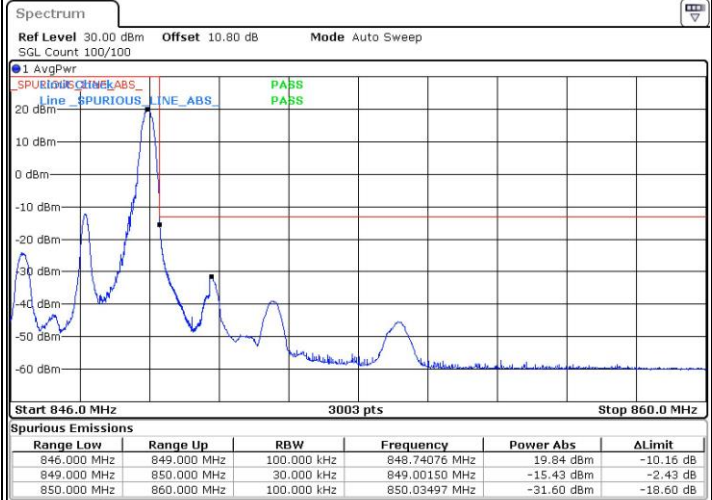

Date: 14.OCT.2016 14:47:11

Lowest Band Edge / Full RB

Highest Band Edge / Full RB

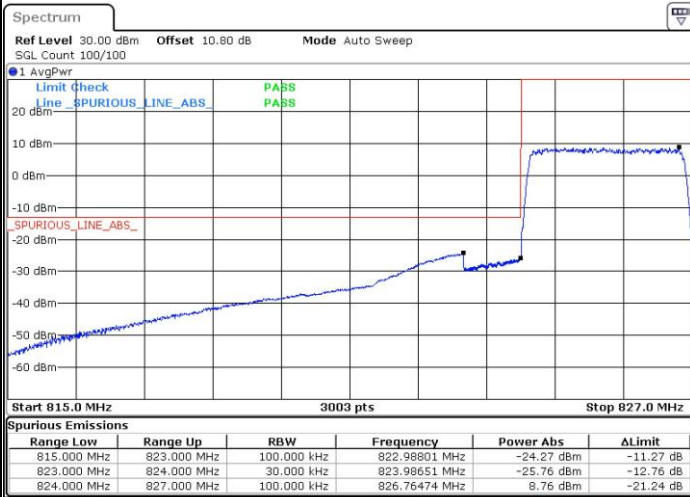

Date: 14.OCT.2016 14:38:52



Date: 14.OCT.2016 14:50:29