



# **CERTIFICATION TEST REPORT**

**Report Number. :** 12132730-E1V2

**Applicant :** SONY MOBILE COMMUNICATIONS, INC.  
4-12-3 HIGASHI-SHINAGAWA,  
SHINAGAWA -KU, TOKYO, 140-0002, JAPAN

**FCC ID :** PY7- 43153F

**EUT Description :** GSM/WCDMA/LTE PHONE WITH BT, DTS/UNII A/B/G/N/AC & NFC

**Test Standard(s) :** FCC CFR47 PART 22H, 24E, and 27F/H/L/M

**Date Of Issue:**  
MARCH 26, 2018

**Prepared by:**  
UL Verification Services Inc.  
47173 Benicia Street  
Fremont, CA 94538, U.S.A.  
TEL: (510) 771-1000  
FAX: (510) 661-0888



---

Revision History

<u>Rev.</u>	<u>Issue Date</u>	<u>Revisions</u>	<u>Revised By</u>
V1	3/23/2018	Initial Review	--
V2	3/26/2018	Updated Section 5.2, 7, 7.3, 7.4, 7.6, 7.7 and 8.4.7	Kiya Kedida

## TABLE OF CONTENTS

<b>1. ATTESTATION OF TEST RESULTS</b> .....	<b>6</b>
<b>2. TEST METHODOLOGY</b> .....	<b>7</b>
<b>3. FACILITIES AND ACCREDITATION</b> .....	<b>7</b>
<b>4. CALIBRATION AND UNCERTAINTY</b> .....	<b>7</b>
4.1. MEASURING INSTRUMENT CALIBRATION.....	7
4.2. SAMPLE CALCULATION.....	7
4.3. MEASUREMENT UNCERTAINTY.....	8
<b>5. EQUIPMENT UNDER TEST</b> .....	<b>9</b>
5.1. DESCRIPTION OF EUT.....	9
5.2. MAXIMUM OUTPUT POWER (one antenna).....	9
5.3. MAXIMUM ANTENNA GAIN.....	14
5.4. WORST-CASE CONFIGURATION AND MODE.....	15
5.6. DESCRIPTION OF TEST SETUP.....	16
<b>6. TEST AND MEASUREMENT EQUIPMENT</b> .....	<b>18</b>
<b>7. RF OUTPUT POWER VERIFICATION</b> .....	<b>19</b>
7.1. GSM.....	20
7.1.1. GSM GSM850.....	21
7.1.2. GSM 1900MHz.....	21
7.2. WCDMA.....	22
7.2.1. WCDMA BAND5.....	25
7.2.2. WCDMA BAND2.....	26
7.2.3. WCDMA BAND4.....	27
7.3. LTE Band 4.....	28
7.4. LTE Band 5.....	31
7.5. LTE Band 7.....	33
7.6. LTE Band 13.....	35
7.7. LTE 17.....	36
7.8. LTE 41.....	37
<b>8. CONDUCTED TEST RESULTS</b> .....	<b>39</b>
8.1. OCCUPIED BANDWIDTH.....	39
8.1.1. GSM.....	43

---

8.1.2.	WCDMA .....	44
8.1.3.	LTE BAND 4.....	45
8.1.4.	LTE BAND 5.....	47
8.1.5.	LTE BAND 7.....	49
8.1.6.	LTE BAND 13.....	51
8.1.7.	LTE BAND 17.....	52
8.1.8.	LTE BAND 41.....	53
8.2.	BAND EDGE AND EMISSION MASK .....	55
8.2.1.	GSM 850MHz.....	57
8.2.2.	GSM 1900MHz.....	58
8.2.1.	WCDMA BAND 5 .....	59
8.2.2.	WCDMA BAND 2 .....	60
8.2.3.	WCDMA BAND 4 .....	61
8.2.4.	LTE BAND 4 BANDEDGE.....	62
8.2.5.	LTE BAND 5 BANDEDGE.....	74
8.2.6.	LTE BAND 7 ADJACENT CHANNEL POWER.....	82
8.2.7.	LTE BAND 13 BANDEDGE.....	90
8.2.8.	LTE BAND 17 BANDEDGE.....	94
8.2.9.	LTE BAND 41 ADJACENT CHANNEL POWER.....	98
8.3.	OUT OF BAND EMISSIONS .....	106
8.3.1.	GSM GSM850.....	107
8.3.2.	GSM GSM1900.....	109
8.3.3.	WCDMA BAND5 .....	111
8.3.4.	WCDMA BAND2 .....	113
8.3.5.	WCDMA BAND4 .....	115
8.3.6.	LTE BAND 4.....	117
8.3.7.	LTE BAND 5.....	123
8.3.8.	LTE BAND 7.....	127
8.3.9.	LTE BAND 13.....	131
8.3.10.	LTE BAND 17 .....	133
8.3.11.	LTE BAND 41 .....	135
8.4.	FREQUENCY STABILITY .....	139
8.4.1.	GSM 1900.....	141
8.4.2.	LTE BAND 4.....	141
8.4.3.	LTE BAND 5.....	142

---

8.4.4.	LTE BAND 7.....	142
8.4.5.	LTE BAND 13.....	143
8.4.6.	LTE BAND 17.....	143
8.4.7.	LTE BAND 41.....	144
8.5.	PEAK TO AVERAGE RATIO.....	145
8.5.1.	GSM.....	146
8.5.2.	WCDMA.....	147
8.5.3.	LTE BAND 4.....	148
8.5.4.	LTE BAND 5.....	150
8.5.5.	LTE BAND 7.....	152
8.5.6.	LTE BAND 13.....	154
8.5.7.	LTE BAND 17.....	155
8.5.8.	LTE BAND 41.....	156
<b>9.</b>	<b>RADIATED TEST RESULTS .....</b>	<b>158</b>
9.1.	FIELD STRENGTH OF SPURIOUS RADIATION.....	158
9.1.3.	LTE BAND 4.....	161
9.1.4.	LTE BAND 5.....	163
9.1.5.	LTE BAND 7.....	165
9.1.6.	LTE BAND 13.....	167
9.1.7.	LTE BAND 17.....	168
9.1.8.	LTE BAND 41.....	169
<b>10.</b>	<b>SETUP PHOTOS.....</b>	<b>171</b>

# 1. ATTESTATION OF TEST RESULTS

Applicant Name and Address	SONY MOBILE COMMUNICATIONS, INC. 4-12-3 HIGASHI-SHINAGAWA, SHINAGAWA -KU, TOKYO, 140-0002, JAPAN
FCC ID	PY7- 43153F
EUT Description	GSM/WCDMA/LTE PHONE WITH BT, DTS/UNII A/B/G/N/AC & NFC
Serial Number	BH90002HBN, BH9000EZBN, BH9000BRBN, BH9000JHBN
Date Tested	FEBRUARY 23, 2018 to MARCH 07, 2018
Applicable Standards	FCC CFR47 PART 22H, 24E, and 27F/H/L/M
Test Results	Complies

UL Verification Services Inc. tested the above equipment in accordance with the requirements set forth in the above standards. All indications of Pass/Fail in this report are opinions expressed by UL Verification Services Inc. based on interpretations and/or observations of test results. Measurement Uncertainties were not taken into account and are published for informational purposes only. The test results show that the equipment tested is capable of demonstrating compliance with the requirements as documented in this report.

**Note:** The results documented in this report apply only to the tested sample, under the conditions and modes of operation as described herein. This document may not be altered or revised in any way unless done so by UL Verification Services Inc. and all revisions are duly noted in the revisions section. Any alteration of this document not carried out by UL Verification Services Inc. will constitute fraud and shall nullify the document. This report must not be used by the client to claim product certification, approval, or endorsement by NVLAP, NIST, any agency of the Federal Government, or any agency of any government (NIST Handbook 150, Annex A). This report is written to support regulatory compliance of the applicable standards stated above.

Approved & Released For  
UL Verification Services Inc. By:



Dan Corona  
Operations Leader  
UL Verification Services Inc.

Reviewed By:



Kiya Kedida  
Project Engineer  
UL Verification Services Inc.

## 2. TEST METHODOLOGY

The tests documented in this report were performed in accordance with ANSI C63.26:2015, TIA-603-E, FCC CFR 47 Part 2, Part 22, Part 24, Part 27, FCC KDB 971168 D01 v03.

## 3. FACILITIES AND ACCREDITATION

The test sites and measurement facilities used to collect data are located at 47173 and 47266 Benicia Street, Fremont, California, USA. Line conducted emissions are measured only at the 47173 address. The following table identifies which facilities were utilized for radiated emission measurements documented in this report. Specific facilities are also identified in the test results sections.

47173 Benicia Street		47266 Benicia Street	
<input checked="" type="checkbox"/>	Chamber A (ISED:2324B-1)	<input type="checkbox"/>	Chamber D (ISED:22541-1)
<input checked="" type="checkbox"/>	Chamber B (ISED:2324B-2)	<input type="checkbox"/>	Chamber E (ISED:22541-2)
<input type="checkbox"/>	Chamber C (ISED:2324B-3)	<input type="checkbox"/>	Chamber F (ISED:22541-3)
		<input type="checkbox"/>	Chamber G (ISED:22541-4)
		<input type="checkbox"/>	Chamber H (ISED:22541-5)

UL Verification Services Inc. is accredited by NVLAP, Laboratory Code 200065-0. The full scope of accreditation can be viewed at <http://ts.nist.gov/standards/scopes/2000650.htm>.

## 4. CALIBRATION AND UNCERTAINTY

### 4.1. MEASURING INSTRUMENT CALIBRATION

The measuring equipment utilized to perform the tests documented in this report has been calibrated in accordance with the manufacturer's recommendations, and is traceable to recognized national standards.

### 4.2. SAMPLE CALCULATION

Where relevant, the following sample calculation is provided:

$$\text{Field Strength (dBuV/m)} = \text{Measured Voltage (dBuV)} + \text{Antenna Factor (dB/m)} + \text{Cable Loss (dB)} - \text{Preamp Gain (dB)}$$

$$36.5 \text{ dBuV} + 18.7 \text{ dB/m} + 0.6 \text{ dB} - 26.9 \text{ dB} = 28.9 \text{ dBuV/m}$$

### 4.3. MEASUREMENT UNCERTAINTY

Where relevant, the following measurement uncertainty levels have been estimated for tests performed on the apparatus:

PARAMETER	UNCERTAINTY
Worst Case Conducted Disturbance, 9KHz to 0.15 MHz	3.84 dB
Worst Case Conducted Disturbance, 0.15 to 30 MHz	3.65 dB
Worst Case Radiated Disturbance, 9KHz to 30 MHz	3.15 dB
Worst Case Radiated Disturbance, 30 to 1000 MHz	5.36 dB
Worst Case Radiated Disturbance, 1000 to 18000 MHz	4.32 dB
Worst Case Radiated Disturbance, 18000 to 26000 MHz	4.45 dB
Worst Case Radiated Disturbance, 26000 to 40000 MHz	5.24 dB

Uncertainty figures are valid to a confidence level of 95%.



---

## 5. EQUIPMENT UNDER TEST

### 5.1. DESCRIPTION OF EUT

The EUT is a GSM/WCDMA/LTE Phone with BT, DTS/UNII a/b/g/n/ac & NFC.

### 5.2. MAXIMUM OUTPUT POWER (one antenna)

#### ERP/EIRP LIMIT

FCC: §2.1046, §22.913, §24.232, §27.50

#### EIRP/ERP TEST PROCEDURE

ANSI C63.26:2015/ TIA-603-E Clause 2.2.17

KDB 971168 Section 5.6

$$\text{ERP/EIRP} = \text{PMeas} + \text{GT} - \text{LC}$$

Where: ERP/EIRP = effective or equivalent radiated power, respectively (expressed in the same units as PMeas, typically dBW or dBm);

PMeas = measured transmitter output power or PSD, in dBm or dBW;

GT = gain of the transmitting antenna, in dBd (ERP) or dBi (EIRP);

LC = signal attenuation in the connecting cable between the transmitter and antenna, in dB.

For devices utilizing multiple antennas, KDB 662911 provides guidance for determining the effective array transmit antenna gain term to be used in the above equation.

The transmitter has a maximum average conducted and ERP / EIRP output powers as follows:

**GSM MODES**

**Part 22 850MHz**

Frequency range (MHz)	Modulation	Conducted (Average) (dBm)	Antenna Gain (dBi)	ERP		Limit (dBm)	Margin (dB)
				dBm	mW		
824- 849	GPRS	33.00	-6.50	24.35	272.3	38.5	-14.1
	EGPRS	27.00	-6.50	18.35	68.4	38.5	-20.1

**Part 24 1900MHz**

Frequency range (MHz)	Modulation	Conducted (Average) (dBm)	Antenna Gain (dBi)	EIRP		Limit (dBm)	Margin (dB)
				dBm	mW		
1850-1910	GPRS	28.40	-6.20	22.20	166.0	33.0	-10.8
	EGPRS	25.90	-6.20	19.70	93.3	33.0	-13.3

**WCDMA MODE**

**Part 22 Band 5**

Frequency range (MHz)	Modulation	Conducted (Average) (dBm)	Antenna Gain (dBi)	ERP		Limit (dBm)	Margin (dB)
				dBm	mW		
824- 849	REL 99	24.50	-6.50	15.85	38.5	38.5	-22.6
	HSDPA	23.50	-6.50	14.85	30.5	38.5	-23.6

**Part 24 Band 2**

Frequency range (MHz)	Modulation	Conducted (Average) (dBm)	Antenna Gain (dBi)	EIRP		Limit (dBm)	Margin (dB)
				dBm	mW		
1850-1910	REL 99	22.30	-6.20	16.10	40.7	33.0	-16.9
	HSDPA	21.30	-6.20	15.10	32.4	33.0	-17.9

**Part 27 Band 4**

Frequency range (MHz)	Modulation	Conducted (Average) (dBm)	Antenna Gain (dBi)	EIRP		Limit (dBm)	Margin (dB)
				dBm	mW		
1710-1755	REL 99	22.20	-6.90	15.30	33.9	30.0	-14.7
	HSDPA	21.30	-6.90	14.40	27.5	30.0	-15.6

**LTE BAND 4**

Part 27						
EIRP Limit (dBm)		30.00				
Antenna Gain (dBi)		-6.90				
Bandwidth (MHz)	Frequency Range (MHz)	Modulation	Conducted Average (dBm)	EIRP Average		Margin (dB)
				dBm	mW	
1.4	1710-1755	QPSK	22.6	15.7	37.2	-14.3
		16QAM	22.3	15.4	34.7	-14.6
		64QAM	22.6	15.7	37.2	-14.3
3.0		QPSK	22.8	<b>15.9</b>	<b>38.9</b>	-14.1
		16QAM	22.4	15.5	35.5	-14.5
		64QAM	22.6	15.7	37.2	-14.3
5.0		QPSK	22.8	<b>15.9</b>	<b>38.9</b>	-14.1
		16QAM	22.6	15.7	37.2	-14.3
		64QAM	22.4	15.5	35.5	-14.5
10.0		QPSK	22.8	<b>15.9</b>	<b>38.9</b>	-14.1
		16QAM	22.5	15.6	36.3	-14.4
		64QAM	22.4	15.5	35.5	-14.5
15.0	QPSK	22.8	<b>15.9</b>	<b>38.9</b>	-14.1	
	16QAM	22.6	15.7	37.2	-14.3	
	64QAM	22.8	<b>15.9</b>	<b>38.9</b>	-14.1	
20.0	QPSK	22.8	<b>15.9</b>	<b>38.9</b>	-14.1	
	16QAM	22.9	<b>16.0</b>	<b>39.8</b>	-14.0	
	64QAM	22.7	15.8	38.0	-14.2	

**LTE BAND 5**

Part 22						
ERP Limit (dBm)		38.45				
Antenna Gain (dBi)		-6.50				
Bandwidth (MHz)	Frequency Range (MHz)	Modulation	Conducted Average (dBm)	ERP Average		Margin (dB)
				dBm	mW	
1.4	824-849	QPSK	24.8	16.15	41.2	-22.3
		16QAM	24.0	15.35	34.3	-23.1
		64QAM	22.5	13.85	24.3	-24.6
3.0		QPSK	24.9	<b>16.25</b>	<b>42.2</b>	-22.2
		16QAM	24.0	15.35	34.3	-23.1
		64QAM	22.6	<b>13.95</b>	<b>24.8</b>	-24.5
5.0		QPSK	24.9	<b>16.25</b>	<b>42.2</b>	-22.2
		16QAM	24.0	15.35	34.3	-23.1
		64QAM	22.6	<b>13.95</b>	<b>24.8</b>	-24.5
10.0		QPSK	24.7	16.05	40.3	-22.4
		16QAM	24.1	<b>15.45</b>	<b>35.1</b>	-23.0
		64QAM	22.6	<b>13.95</b>	<b>24.8</b>	-24.5

**LTE BAND 7**

Part 27						
EIRP Limit (dBm)		33.00				
Antenna Gain (dBi)		-7.00				
Bandwidth (MHz)	Frequency Range (MHz)	Modulation	Conducted Average (dBm)	EIRP Average		Margin (dB)
				dBm	mW	
5.0	2500-2570	QPSK	22.7	15.7	37.2	-17.3
		16QAM	22.7	15.7	37.2	-17.3
		64QAM	22.5	15.5	35.5	-17.5
10.0		QPSK	22.7	15.7	37.2	-17.3
		16QAM	22.6	15.6	36.3	-17.4
		64QAM	22.5	15.5	35.5	-17.5
15.0		QPSK	22.8	15.8	38.0	-17.2
		16QAM	22.7	15.7	37.2	-17.3
		64QAM	22.7	15.7	37.2	-17.3
20.0	QPSK	22.8	15.8	38.0	-17.2	
	16QAM	22.7	15.7	37.2	-17.3	
	64QAM	22.7	15.7	37.2	-17.3	

**LTE BAND 13**

Part 27						
ERP Limit (dBm)		34.77				
Antenna Gain (dBi)		-7.00				
Bandwidth (MHz)	Frequency Range (MHz)	Modulation	Conducted Average (dBm)	ERP Average		Margin (dB)
				dBm	mW	
5.0	777-787	QPSK	24.9	15.75	37.6	-19.0
		16QAM	23.8	14.65	29.2	-20.1
		64QAM	22.7	13.55	22.6	-21.2
10.0		QPSK	24.9	15.75	37.6	-19.0
		16QAM	24.0	14.85	30.5	-19.9
		64QAM	22.3	13.15	20.7	-21.6

**LTE BAND 17**

Part 27						
ERP Limit (dBm)		34.77				
Antenna Gain (dBi)		-7.00				
Bandwidth (MHz)	Frequency Range (MHz)	Modulation	Conducted Average (dBm)	ERP Average		Margin (dB)
				dBm	mW	
5.0	704-716	QPSK	24.7	15.55	35.9	-19.2
		16QAM	24.0	14.85	30.5	-19.9
		64QAM	22.4	13.25	21.1	-21.5
10.0		QPSK	24.6	15.45	35.1	-19.3
		16QAM	24.0	14.85	30.5	-19.9
		64QAM	22.4	13.25	21.1	-21.5

**LTE BAND 41**

Part 27						
EIRP Limit (dBm)		33.00				
Antenna Gain (dBi)		-6.90				
Bandwidth (MHz)	Frequency Range (MHz)	Modulation	Conducted Average (dBm)	EIRP Average		Margin (dB)
				dBm	mW	
5.0	2496-2690	QPSK	22.7	15.8	38.0	-17.2
		16QAM	22.6	15.7	37.2	-17.3
		64QAM	22.5	15.6	36.3	-17.4
10.0		QPSK	22.6	15.7	37.2	-17.3
		16QAM	22.2	15.3	33.9	-17.7
		64QAM	22.1	15.2	33.1	-17.8
15.0		QPSK	22.7	15.8	38.0	-17.2
		16QAM	22.5	15.6	36.3	-17.4
		64QAM	22.4	15.5	35.5	-17.5
20.0		QPSK	22.8	<b>15.9</b>	<b>38.9</b>	-17.1
		16QAM	22.7	<b>15.8</b>	<b>38.0</b>	-17.2
		64QAM	22.6	<b>15.7</b>	<b>37.2</b>	-17.3

### 5.3. MAXIMUM ANTENNA GAIN

Please see table below:

LTE Bands	Antenna Gain (dBi)
GSM850, 824-849MHz	-6.5
GSM1900, 1850-1910MHz	-6.2
WCDMA Band 2, 1850-1910 MHz	-6.2
WCDMA Band 4, 1710-1755 MHz	-6.9
WCDMA Band 5, 824-849 MHz	-6.5
LTE BAND 4, 1710 - 1755 MHz	-6.9
LTE BAND 5, 824 - 849 MHz	-6.5
LTE BAND 7, 2500 - 2570 MHz	-7.0
LTE BAND 13, 777 - 787 MHz	-7.0
LTE BAND 17, 704 - 716 MHz	-7.0
LTE BAND 41, 2496 - 2690 MHz	-6.9

---

## 5.4. WORST-CASE CONFIGURATION AND MODE

The EUT supports LTE Bands of:  
Band 4, Band 5, Band 7, Band 13, Band 17, and Band 41.

The worst-case scenario for all measurements is based on the average conducted output power measurement investigation results. Output power measurements were measured on QPSK, 16QAM, and 64QAM modulations. It was found that QPSK, and 16QAM results were worst case. All testing was performed using QPSK, and 16QAM modulations to represent the worst case.

The fundamental of the EUT was investigated in three orthogonal orientations X, Y, & Z, and it was determined that X-Axis with AC/DC Adapter and headset was worst-case orientation; therefore, all final radiated testing was performed with the EUT in X-Axis with AC/DC Adapter and headset orientation.

## 5.6. DESCRIPTION OF TEST SETUP

### SUPPORT EQUIPMENT

Support Equipment List			
Description	Manufacturer	Model	Serial Number
AC adapter	SONY	UCH12	VB17W46601037
Audio & Charging Cable	SONY	1312-8675.1B	YYWWSSPCXXXXXC
DC Power Supply	Ametek	XT 15-4	T463
Earphone	SONY	MH410c	N/A

### I/O CABLES (RF Conducted Test)

I/O Cable List						
Cable No	Port	# of identical ports	Connector Type	Cable Type	Cable Length (m)	Remarks
1	RF Out	1	Spectrum Analyzer	Shielded	None	NA
2	Antenna Port	1	EUT	Shielded	0.1m	NA
3	RF In/Out	1	Communication Test Set	Shielded	1m	NA

### I/O CABLES (RF Radiated Test)

I/O Cable List						
Cable No	Port	# of identi	Connector Type	Cable Type	Cable Length	Remarks
1	USB	1	AC Adapter	Un-shielded	1.2m	No
2	Jack	1	Headset	Shielded	1m	No
3	USB/Headphone Jack	1	USB Type-C/Audio	Un-shielded	.2m	Audio & Charging Cable
4	RF In/out	1	Communication Test Set	Un-shielded	2m	No



**CONDUCTED SETUP**

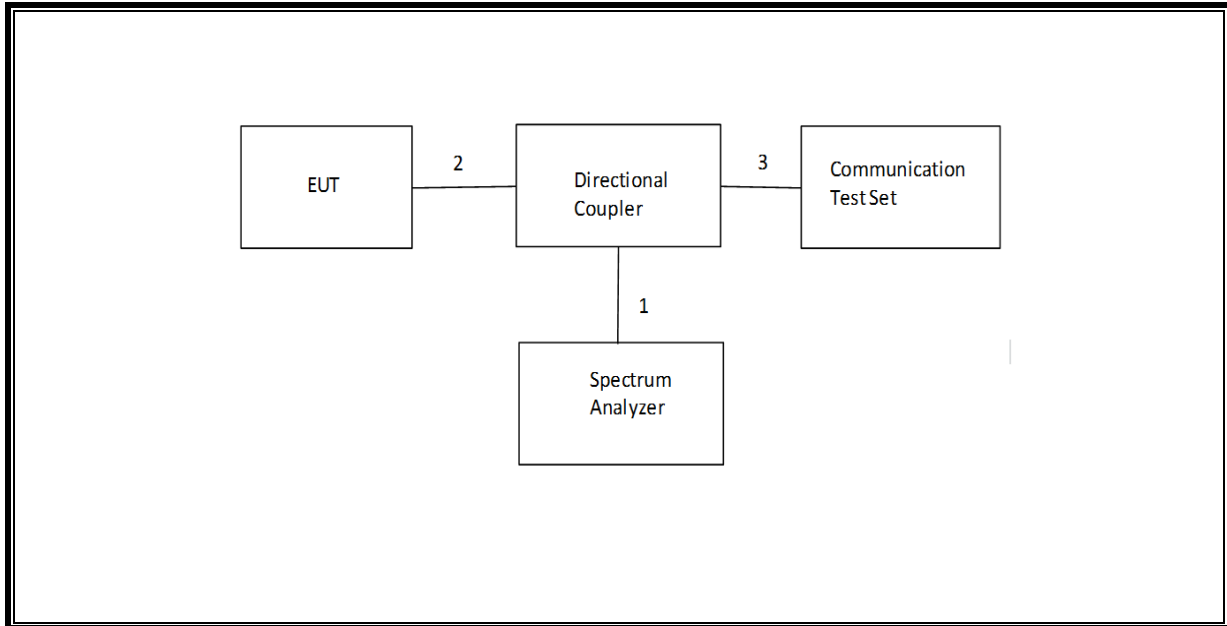

**RADIATED SETUP**

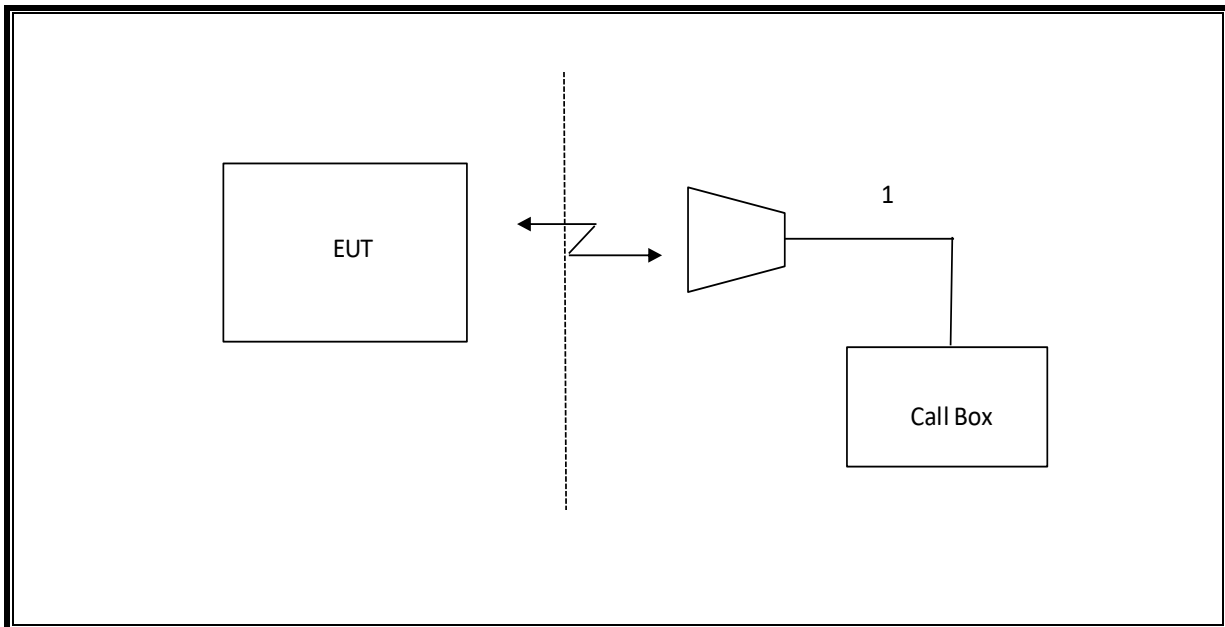

## 6. TEST AND MEASUREMENT EQUIPMENT

The following test and measurement equipment was utilized for the tests documented in this report:

TEST EQUIPMENT LIST					
Description	Manufacturer	Model	ID Num	Cal Due	Last Cal
Highpass Filter, 2.7 GHz	Micro-Circuits	H2G518G6	T772	07/05/18	07/05/17
Highpass Filter, 1 GHz	Micro-Tronics	HPM18129	T889	02/21/19	02/21/18
Highpass Filter, 4GHz	Micro-Tronics	HPM13351	T1241	07/19/18	07/19/17
Antenna, Horn 1-18GHz	ETS-Lindgren	3117	T346	03/28/2018	03/28/2017
Antenna, Horn 1-18GHz	ETS-Lindgren	3117	T862	06/09/2018	06/09/2017
RF Amplifier	MITEQ	AFS42-00101800-25-S-42	T493	12/16/2018	12/16/2017
RF Amplifier	MITEQ	AFS42-00101800-25-S-42	T1165	11/25/2018	11/25/2017
Directional Coupler	Mini-Circuits	ZUDC10-183+	T1136	06/18/18	06/18/17
Wideband Communication Test Set, Call Box	R&S	CMW500	T954	02/21/19	02/21/18
Chamber, Environmental	Thermotron	SE-600-10-10	T80	02/22/19	02/22/18
Spectrum Analyzer	Agilent (Keysight) Technologies	E4446A	T146	07/18/2018	07/18/2017
Spectrum Analyzer, PXA, 3Hz to 44GHz	Agilent (Keysight) Technologies	N9030A	T1466	04/11/2018	04/11/2017
Spectrum Analyzer, PXA, 3Hz to 44GHz	Agilent (Keysight) Technologies	N9030A	T907	01/23/2019	01/23/2018
DC power supply, 8 V @ 3 A or 15 V @ 2 A	Agilent / HP	E3610A	None	CNR	CNR

UL AUTOMATION SOFTWARE			
CLT Software	UL	UL RF	Ver 7.6, November 11, 2017
Power Measurement Software	UL	UL RF	Ver 2.2, June 2017

**NOTES:**

1. Equipment listed above that calibrated during the testing period was set for test after the calibration.
2. Equipment listed above that has a calibration due date during the testing period, the testing is completed before equipment expiration date.

---

## 7. RF OUTPUT POWER VERIFICATION

The below tables contain the highest of all configurations average conducted output powers as follows

## 7.1. GSM

### Using CMW500 Communication Test Set

Function: Menu select > GSM Mobile Station > GSM 850/900/1800/1900

Press **Connection control** to choose the different menus

Press **RESET** > choose all to reset all settings

Connection	Press <b>Signal Off</b> to turn off the signal and change settings Network Support > GSM+GPRS or GSM+EGPRS Main Service > Packet Data Service selection > Test Mode A – Auto Slot Config. off
MS Signal	Press Slot Config bottom on the right twice to select and change the number of time slots and power setting > Slot configuration > Uplink/Gamma > 33 dBm for GPRS 850/900 > 27 dBm for EGPRS 850/900 > 30 dBm for GPRS1800/1900 > 26 dBm for EGPRS1800/1900
BS Signal	Enter the same channel number for TCH channel (test channel) and BCCH channel  Frequency Offset > + 0 Hz Mode > BCCH and TCH BCCH Level > -85 dBm (May need to adjust if link is not stable) BCCH Channel > choose desire test channel [Enter the same channel number for TCH channel (test channel) and BCCH channel]  Channel Type > Off P0> 4 dB Slot Config > Unchanged (if already set under MS Signal) TCH > choose desired test channel Hopping > Off Main Timeslot > 3 (Default)
Network	Coding Scheme > CS 4 (GPRS) and MCS5 (EGPRS) Bit Stream > 2E9-1PSR Bit Pattern
AF/RF	Enter appropriate offsets for Ext. Att. Output and Ext. Att. Input
Connection	Press <b>Signal On</b> to turn on the signal and change settings

### RESULT

**7.1.1. GSM GSM850**

<b>ID:</b>	40814	<b>Date:</b>	2/23/18
------------	-------	--------------	---------

**GPRS (GMSK) - Coding Scheme: CS1**

Band	Ch No.	Freq. (MHz)	Average (dBm)	
			1 slot	2 slots
850.0	128	824.2	32.8	30.7
	190	836.6	32.8	30.9
	251	848.8	<b>33.0</b>	30.9

**EGPRS (8PSK) - Coding Scheme: MCS5**

Band	Ch No.	Freq. (MHz)	Average (dBm)	
			1 slot	2 slots
850.0	128	824.2	26.8	25.4
	190	836.6	26.9	25.4
	251	848.8	<b>27.0</b>	25.5

**7.1.2. GSM 1900MHz**

<b>ID:</b>	40814	<b>Date:</b>	2/23/18
------------	-------	--------------	---------

**GPRS (GMSK) - Coding Scheme: CS1**

Band	Ch No.	Freq. (MHz)	Average (dBm)	
			1 slot	2 slots
1900.0	512	1850.2	28.2	26.1
	661	1880.0	<b>28.4</b>	26.2
	810	1909.8	28.3	26.3

**EGPRS (8PSK) - Coding Scheme: MCS5**

Band	Ch No.	Freq. (MHz)	Average (dBm)	
			1 slot	2 slots
1900.0	512	1850.2	25.7	24.3
	661	1880.0	<b>25.9</b>	24.4
	810	1909.8	25.8	24.3

## 7.2. WCDMA

### TEST PROCEDURE

The transmitter output was connected to the input terminal of Directional Coupler via calibrated coaxial cable. The output coupling terminal of the Directional Coupler was directly connected to a spectrum analyzer while the output through terminal connected to the communication test set via calibrated coaxial cable.

The output power was measured with the spectrum analyzer at the low, middle and high channel in each band.

- Set the spectrum analyzer span wide enough or greater than the modulated signal BW.
- Set a spectrum analyzer at peak detection mode with VBW  $\geq$  RBW  $\geq$  26dB BW, typically 5MHz.
- Set a marker to point the corresponding peak value.

### REL 99

The following tests were completed according to the test requirements outlined in section 5.2 of the 3GPP TS34.121-1 specification. The DUT supports power Class 3, which has a nominal maximum output power of 24 dBm (+1.7/-3.7).

Mode	Subtest	Rel99
WCDMA General Settings	Loopback Mode	Test Mode 2
	Rel99 RMC	12.2kbps RMC
	Power Control Algorithm	Algorithm2
	$\beta_c/\beta_d$	8/15

### HSDPA REL 5

The following 4 Sub-tests were completed according to Release 5 procedures in section 5.2 of 3GPP TS34.121. A summary of these settings are illustrated below:

Mode	HSDPA	HSDPA	HSDPA	HSDPA	
Subtest	1	2	3	4	
W-CDMA General Settings	Loopback Mode	Test Mode 1			
	Rel99 RMC	12.2kbps RMC			
	HSDPA FRC	H-Set 1			
	Power Control Algorithm	Algorithm 2			
	$\beta_c$	2/15	11/15	15/15	15/15
	$\beta_d$	15/15	15/15	8/15	4/15
	Bd (SF)	64			
	$\beta_c/\beta_d$	2/15	11/15	15/8	15/4
	$\beta_{hs}$	4/15	24/15	30/15	30/15
MPR (dB)	0	0	0.5	0.5	
HSDPA Specific Settings	$D_{ACK}$	8			
	$D_{NAK}$	8			
	DCQI	8			
	Ack-Nack repetition factor	3			
	CQI Feedback (Table 5.2B.4)	4ms			
	CQI Repetition Factor (Table 5.2B.4)	2			
Ahs= $\beta_{hs}/\beta_c$	30/15				

**HSPA (HSDPA & HSUPA) Setup Procedures used to establish the test signals**

The following 5 Sub-tests were completed according to Release 6 procedures in table C, 11.1.3 of 3GPP TS34.121-1v13. A summary of these settings are illustrated below:

	Mode	HSPA				
	Subtest	1	2	3	4	5
WCDMA General Settings	Loopback Mode	Test Mode 1				
	Rel99 RMC	12.2 kbps RMC				
	HSDPA FRC	H-Set 1				
	HSUPA Test	HSPA				
	Power Control Algorithm	Algorithm 2				Algorithm 1
	$\beta_c$	11/15	6/15	15/15	2/15	15/15
	$\beta_d$	15/15	15/15	9/15	15/15	0
	$\beta_{ec}$	209/225	12/15	30/15	2/15	5/15
	$\beta_c/\beta_d$	11/15	6/15	15/9	2/15	-
	$\beta_{hs}$	22/15	12/15	30/15	4/15	5/15
	$\beta_{ed}$	1309/225	94/75	47/15	56/75	47/15
CM (dB)	1	3	2	3	1	
MPR (dB)	0	2	1	2	0	
HSDPA Specific Settings	DACK	8				0
	DNAK	8				0
	DCQI	8				0
	Ack-Nack repetition factor	3				
	CQI Feedback (Table 5.2B.4)	4ms				
	CQI Repetition Factor (Table 5.2B.4)	2				
	$A_{hs} = \beta_{hs}/\beta_c$	30/15				
HSUPA Specific Settings	E-DPDCCH	6	8	8	5	7
	DHARQ	0	0	0	0	0
	AG Index	20	12	15	17	21
	ETFCI (from 34.121 Table C.11.1.3)	75	67	92	71	81
	Associated Max UL Data Rate kbps	242.1	174.9	482.8	205.8	308.9
	Reference E-TFCIs	5	5	2	5	1
	Reference E-TFCI	11	11	11	11	67
	Reference E-TFCI PO	4	4	4	4	18
	Reference E-TFCI	67	67	92	67	67
	Reference E-TFCI PO	18	18	18	18	18
	Reference E-TFCI	71	71	71	71	71
	Reference E-TFCI PO	23	23	23	23	23
	Reference E-TFCI	75	75	75	75	75
	Reference E-TFCI PO	26	26	26	26	26
	Reference E-TFCI	81	81	81	81	81
Reference E-TFCI PO	27	27	27	27	27	
Maximum Channelization Codes	2xSF2				SF4	

**HSPA+ REL 7**

The following 1 Sub-test was completed according to Release 7 procedures in section 5.2 of 3GPP TS34.121. A summary of these settings are illustrated below:

**Table C.11.1.4:  $\beta$  values for transmitter characteristics tests with HS-DPCCH and E-DCH with 16QAM**

Sub-test	$\beta_c$ (Note3)	$\beta_d$	$\beta_{HS}$ (Note1)	$\beta_{ec}$	$\beta_{ed}$ (2xSF2) (Note 4)	$\beta_{ed}$ (2xSF4) (Note 4)	CM (dB) (Note 2)	MPR (dB) (Note 2)	AG Index (Note 4)	E-TFCI (Note 5)	E-TFCI (boost)
1	1	0	30/15	30/15	$\beta_{ed1}$ : 30/15 $\beta_{ed2}$ : 30/15	$\beta_{ed3}$ : 24/15 $\beta_{ed4}$ : 24/15	3.5	2.5	14	105	105

Note 1:  $\Delta_{ACK}$ ,  $\Delta_{NACK}$  and  $\Delta_{CQI} = 30/15$  with  $\beta_{hs} = 30/15 * \beta_c$ .

Note 2: CM = 3.5 and the MPR is based on the relative CM difference, MPR = MAX(CM-1,0).

Note 3: DPDCH is not configured, therefore the  $\beta_c$  is set to 1 and  $\beta_d = 0$  by default.

Note 4:  $\beta_{ed}$  can not be set directly; it is set by Absolute Grant Value.

Note 5: All the sub-tests require the UE to transmit 2SF2+2SF4 16QAM EDCH and they apply for UE using E-DPDCH category 7. E-DCH TTI is set to 2ms TTI and E-DCH table index = 2. To support these E-DCH configurations DPDCH is not allocated. The UE is signalled to use the extrapolation algorithm.

**RESULT**



7.2.1. WCDMA BAND5

<b>ID:</b>	40814	<b>Date:</b>	2/23/18
------------	-------	--------------	---------

Band	Mode		UL Ch No.	Freq. (MHz)	MPR (dB)	Average Power				
						(dBm)				
W-CDMA Band 5 (850MHz)	Rel 99	RMC, 12.2 kbps	4132	826.4	N/A	24.4				
			4183	836.6	N/A	24.5				
			4233	846.6	N/A	24.4				
	HSDPA	Subtest 1		4132	826.4	0	23.4			
				4183	836.6	0	23.5			
				4233	846.6	0	23.4			
		Subtest 2			4132	826.4	0	23.4		
					4183	836.6	0	23.5		
					4233	846.6	0	23.4		
		Subtest 3			4132	826.4	0.5	22.9		
					4183	836.6	0.5	23.0		
					4233	846.6	0.5	22.9		
		Subtest 4			4132	826.4	0.5	22.9		
					4183	836.6	0.5	23.0		
					4233	846.6	0.5	22.9		
		HSPA (HSDPA & HSUPA)	Subtest 1			4132	826.4	0	23.4	
						4183	836.6	0	23.5	
						4233	846.6	0	23.5	
			Subtest 2				4132	826.4	2	21.4
							4183	836.6	2	21.5
							4233	846.6	2	21.5
	Subtest 3					4132	826.4	1	22.4	
						4183	836.6	1	22.5	
						4233	846.6	1	22.4	
	Subtest 4					4132	826.4	2	21.4	
						4183	836.6	2	21.5	
						4233	846.6	2	21.5	
	Subtest 5					4132	826.4	0	23.4	
						4183	836.6	0	23.5	
						4233	846.6	0	23.5	

7.2.2. WCDMA BAND2

<b>ID:</b>	40814	<b>Date:</b>	2/23/18
------------	-------	--------------	---------

Band	Mode		UL Ch No.	Freq. (MHz)	MPR (dB)	Average	
						(dBm)	
W-CDMA Band 2 (1900MHz)	Rel 99	RMC, 12.2 kbps	9262	1852.4	N/A	22.0	
			9400	1880.0	N/A	<b>22.3</b>	
			9538	1907.6	N/A	22.2	
	HSDPA	Subtest 1	9262	1852.4	0	21.0	
			9400	1880.0	0	21.2	
			9538	1907.6	0	21.2	
		Subtest 2	9262	1852.4	0	21.0	
			9400	1880.0	0	21.2	
			9538	1907.6	0	21.2	
		Subtest 3	9262	1852.4	0.5	20.5	
			9400	1880.0	0.5	20.8	
			9538	1907.6	0.5	20.7	
			9262	1852.4	0.5	20.5	
			9400	1880.0	0.5	20.8	
			9538	1907.6	0.5	20.7	
		HSPA (HSDPA & HSUPA)	Subtest 1	9262	1852.4	0	21.0
				9400	1880.0	0	<b>21.3</b>
				9538	1907.6	0	21.1
	Subtest 2		9262	1852.4	2	19.0	
			9400	1880.0	2	19.3	
			9538	1907.6	2	19.2	
	Subtest 3		9262	1852.4	1	20.0	
			9400	1880.0	1	20.2	
			9538	1907.6	1	20.1	
	Subtest 4		9262	1852.4	2	19.0	
			9400	1880.0	2	19.3	
			9538	1907.6	2	19.2	
	Subtest 5		9262	1852.4	0	21.0	
			9400	1880.0	0	<b>21.3</b>	
			9538	1907.6	0	21.1	

7.2.3. WCDMA BAND4

<b>ID:</b>	40814	<b>Date:</b>	2/23/18
------------	-------	--------------	---------

Band	Mode		UL Ch No.	Freq. (MHz)	MPR (dB)	Average	
						(dBm)	
W-CDMA Band 4 (1700MHz)	Rel 99	RMC, 12.2 kbps	1312	1712.4	N/A	22.2	
			1413	1732.6	N/A	22.2	
			1513	1752.6	N/A	22.1	
	HSDPA	Subtest 1	1312	1712.4	0	21.3	
			1413	1732.6	0	21.3	
			1513	1752.6	0	21.1	
		Subtest 2	1312	1712.4	0	21.3	
			1413	1732.6	0	21.3	
			1513	1752.6	0	21.1	
		Subtest 3	1312	1712.4	0.5	20.8	
			1413	1732.6	0.5	20.8	
			1513	1752.6	0.5	20.7	
			1312	1712.4	0.5	20.8	
			1413	1732.6	0.5	20.8	
			1513	1752.6	0.5	20.7	
		HSPA (HSDPA & HSUPA)	Subtest 1	1312	1712.4	0	21.3
				1413	1732.6	0	21.3
				1513	1752.6	0	21.2
	Subtest 2		1312	1712.4	2	19.3	
			1413	1732.6	2	19.3	
			1513	1752.6	2	19.2	
	Subtest 3		1312	1712.4	1	20.3	
			1413	1732.6	1	20.3	
			1513	1752.6	1	20.2	
	Subtest 4		1312	1712.4	2	19.3	
			1413	1732.6	2	19.3	
			1513	1752.6	2	19.2	
	Subtest 5		1312	1712.4	0	21.3	
			1413	1732.6	0	21.3	
			1513	1752.6	0	21.2	

### 7.3. LTE Band 4

<b>ID:</b>	40814	<b>Date:</b>	2/23/18
------------	-------	--------------	---------

#### OUTPUT POWER FOR LTE BAND 4 (1.4 MHz)

Bandwidth (MHz)	Modulation	RB Allocation	RB Offset	Conducted Average (dBm)		
				19957	20175	20393
				1710.7 MHz	1732.5 MHz	1754.3 MHz
1.4	QPSK	1	0	22.3	22.6	22.3
		1	2	22.4	<b>22.6</b>	22.3
		1	5	22.3	22.6	22.3
		3	0	22.4	22.5	22.3
		3	1	22.4	22.6	22.4
		3	2	22.4	22.6	22.4
	16QAM	6	0	22.3	22.5	22.3
		1	0	22.2	22.2	21.9
		1	2	<b>22.3</b>	22.2	22.0
		1	5	22.2	22.2	22.0
		3	0	22.1	22.2	22.1
		3	1	22.2	22.2	22.2
	64QAM	3	2	22.2	22.2	22.2
		6	0	21.8	22.2	22.1
		1	0	22.0	22.5	22.0
		1	2	22.1	<b>22.6</b>	22.1
		1	5	22.0	22.5	22.1
		3	0	22.1	22.5	21.8
		3	1	22.2	22.5	21.9
		3	2	22.2	22.5	21.9
		6	0	21.7	21.6	21.5

#### OUTPUT POWER FOR LTE BAND 4 (3.0 MHz)

Bandwidth (MHz)	Modulation	RB Allocation	RB Offset	Conducted Average (dBm)		
				19965	20175	20385
				1711.5 MHz	1732.5 MHz	1753.5 MHz
3.0	QPSK	1	0	22.4	22.6	22.4
		1	7	22.5	22.7	22.4
		1	14	22.4	22.7	22.3
		8	0	22.4	22.6	22.4
		8	4	22.5	22.7	22.4
		8	7	22.5	<b>22.8</b>	22.4
	16QAM	15	0	22.4	22.7	22.4
		1	0	22.4	22.1	22.0
		1	7	<b>22.4</b>	22.2	22.1
		1	14	22.4	22.1	22.0
		8	0	22.1	22.3	22.0
		8	4	22.1	22.3	22.1
	64QAM	8	7	22.1	22.4	22.1
		15	0	22.0	22.3	22.0
		1	0	22.1	22.5	22.2
		1	7	22.2	<b>22.6</b>	22.3
		1	14	22.1	22.5	22.2
		8	0	21.5	21.8	21.5
		8	4	21.6	21.8	21.5
		8	7	21.6	21.9	21.5
		15	0	21.6	21.8	21.5

**OUTPUT POWER FOR LTE BAND 4 (5.0 MHz)**

Bandwidth (MHz)	Modulation	RB Allocation	RB Offset	Conducted Average (dBm)		
				19975	20175	20375
				1712.5 MHz	1732.5 MHz	1752.5 MHz
5.0	QPSK	1	0	22.5	22.8	22.5
		1	12	22.4	22.7	22.5
		1	24	22.5	<b>22.8</b>	22.5
		12	0	22.5	22.7	22.5
		12	6	22.5	22.7	22.5
		12	11	22.5	22.7	22.4
		25	0	22.6	22.8	22.4
	16QAM	1	0	22.6	22.4	22.2
		1	12	22.5	22.3	22.1
		1	24	<b>22.6</b>	22.4	22.1
		12	0	22.2	22.3	22.1
		12	6	22.2	22.4	22.1
		12	11	22.2	22.4	22.1
		25	0	22.2	22.3	22.0
	64QAM	1	0	22.3	22.2	22.3
		1	12	22.3	22.1	22.3
		1	24	<b>22.4</b>	22.2	22.3
		12	0	21.5	21.8	21.6
		12	6	21.5	21.9	21.6
		12	11	21.5	21.9	21.6
		25	0	21.6	21.8	21.6

**OUTPUT POWER FOR LTE BAND 4 (10.0 MHz)**

Bandwidth (MHz)	Modulation	RB Allocation	RB Offset	Conducted Average (dBm)		
				20000	20175	20350
				1715.0 MHz	1732.5 MHz	1750.0 MHz
10.0	QPSK	1	0	22.5	22.5	22.4
		1	24	22.5	22.6	22.4
		1	49	22.4	22.6	22.4
		25	0	22.6	22.7	22.5
		25	12	22.6	<b>22.8</b>	22.5
		25	24	22.5	22.7	22.5
		50	0	22.6	22.8	22.5
	16QAM	1	0	<b>22.4</b>	22.1	22.1
		1	24	22.4	22.1	22.0
		1	49	22.4	22.1	22.0
		25	0	22.2	22.3	22.2
		25	12	22.2	22.4	22.2
		25	24	22.1	22.3	22.1
		50	0	22.1	22.3	22.1
	64QAM	1	0	22.2	22.5	22.3
		1	24	22.2	22.5	22.2
		1	49	22.1	<b>22.5</b>	22.2
		25	0	21.4	21.4	21.3
		25	12	21.3	21.5	21.3
		25	24	21.3	21.5	21.2
		50	0	21.3	21.5	21.2

**OUTPUT POWER FOR LTE BAND 4 (15.0 MHz)**

Bandwidth (MHz)	Modulation	RB Allocation	RB Offset	Conducted Average (dBm)		
				20025	20175	20325
				1717.5 MHz	1732.5 MHz	1747.5 MHz
15.0	QPSK	1	0	22.6	22.7	22.7
		1	37	22.4	22.6	22.5
		1	74	22.6	22.6	22.5
		36	0	22.6	22.7	22.6
		36	16	22.5	<b>22.8</b>	22.5
		36	35	22.5	22.7	22.5
	16QAM	75	0	22.5	22.7	22.6
		1	0	22.5	22.2	<b>22.6</b>
		1	37	22.3	22.1	22.4
		1	74	22.5	22.1	22.4
		36	0	22.2	22.3	22.2
		36	16	22.2	22.3	22.0
	64QAM	36	35	22.2	22.3	22.0
		75	0	22.2	22.3	22.2
		1	0	22.3	22.7	<b>22.8</b>
		1	37	22.1	22.5	22.6
		1	74	22.3	22.5	22.6
		36	0	21.8	21.9	21.8
		36	16	21.7	21.9	21.6
		36	35	21.7	21.9	21.5
		75	0	21.7	21.8	21.8

**OUTPUT POWER FOR LTE BAND 4 (20.0 MHz)**

Bandwidth (MHz)	Modulation	RB Allocation	RB Offset	Conducted Average (dBm)		
				20050	20175	20300
				1720.0 MHz	1732.5 MHz	1745.0 MHz
20.0	QPSK	1	0	22.6	22.8	22.6
		1	49	22.5	22.6	22.5
		1	99	22.6	22.6	22.4
		50	0	22.7	22.8	22.7
		50	24	22.7	<b>22.8</b>	22.7
		50	49	22.7	22.7	22.5
	16QAM	100	0	22.6	22.7	22.7
		1	0	22.7	<b>22.9</b>	22.6
		1	49	22.5	22.7	22.4
		1	99	22.6	22.7	22.4
		50	0	22.3	22.4	22.3
		50	24	22.3	22.4	22.2
	64QAM	50	49	22.3	22.4	22.1
		100	0	22.3	22.3	22.2
		1	0	<b>22.7</b>	22.7	22.5
		1	49	<b>22.7</b>	22.5	22.3
		1	99	<b>22.7</b>	22.5	22.2
		50	0	21.4	21.5	21.5
		50	24	21.4	21.6	21.4
		50	49	21.5	21.5	21.2
		100	0	21.3	21.4	21.4

**7.4. LTE Band 5**

<b>ID:</b>	38515	<b>Date:</b>	2/22/18
------------	-------	--------------	---------

**OUTPUT POWER FOR LTE BAND 5 (1.4 MHz)**

Bandwidth (MHz)	Modulation	RB Allocation	RB Offset	Conducted Average (dBm)		
				20407	20525	20643
				824.7 MHz	836.5 MHz	848.3 MHz
1.4	QPSK	1	0	24.7	24.6	24.5
		1	2	24.8	24.7	24.5
		1	5	24.7	24.7	24.4
		3	0	24.7	24.7	24.4
		3	1	24.8	24.7	24.5
		3	2	24.8	24.7	24.5
	16QAM	6	0	23.7	23.6	23.5
		1	0	23.8	24.0	23.6
		1	2	23.9	24.0	23.6
		1	5	23.9	24.0	23.5
		3	0	24.0	23.9	23.5
		3	1	24.0	24.0	23.6
	64QAM	3	2	24.0	24.0	23.6
		6	0	23.0	22.7	22.7
		1	0	22.5	22.3	22.4
		1	2	22.5	22.4	22.5
		1	5	22.5	22.2	22.3
		3	0	22.3	22.3	22.3
		3	1	22.4	22.4	22.4
		3	2	22.4	22.4	22.4
		6	0	21.9	22.0	21.6

**OUTPUT POWER FOR LTE BAND 5 (3.0 MHz)**

Bandwidth (MHz)	Modulation	RB Allocation	RB Offset	Conducted Average (dBm)		
				20415	20525	20635
				825.5 MHz	836.5 MHz	847.5 MHz
3.0	QPSK	1	0	24.8	24.7	24.5
		1	7	24.9	24.8	24.6
		1	14	24.8	24.7	24.3
		8	0	23.8	23.7	23.4
		8	4	23.8	23.7	23.6
		8	7	23.8	23.7	23.6
	16QAM	15	0	23.8	23.7	23.4
		1	0	24.0	23.7	23.6
		1	7	24.0	23.8	23.7
		1	14	24.0	23.6	23.4
		8	0	23.0	22.9	22.6
		8	4	23.0	22.9	22.7
	64QAM	8	7	23.0	22.9	22.7
		15	0	23.0	22.8	22.5
		1	0	22.6	22.4	22.3
		1	7	22.6	22.5	22.4
		1	14	22.5	22.4	22.3
		8	0	21.8	21.8	21.6
		8	4	21.9	21.9	21.7
		8	7	21.9	21.9	21.7
		15	0	21.9	21.9	21.5

**OUTPUT POWER FOR LTE BAND 5 (5.0 MHz)**

Bandwidth (MHz)	Modulation	RB Allocation	RB Offset	Conducted Average (dBm)		
				20425	20525	20625
				826.5 MHz	836.5 MHz	846.5 MHz
5.0	QPSK	1	0	24.7	24.9	24.6
		1	12	24.6	24.8	24.6
		1	24	24.6	<b>24.9</b>	24.4
		12	0	23.7	23.7	23.5
		12	6	23.7	23.8	23.5
		12	11	23.7	23.8	23.5
	16QAM	25	0	23.7	23.8	23.5
		1	0	<b>24.0</b>	<b>24.0</b>	23.7
		1	12	<b>24.0</b>	23.9	23.7
		1	24	<b>24.0</b>	24.0	23.6
		12	0	22.9	22.9	22.6
		12	6	23.0	22.9	22.6
	64QAM	12	11	22.9	22.9	22.6
		25	0	22.9	22.8	22.5
		1	0	<b>22.6</b>	22.3	22.3
		1	12	22.6	22.2	22.3
		1	24	22.6	22.3	22.3
		12	0	21.8	21.9	21.7
		12	6	21.8	21.9	21.6
		12	11	21.8	21.9	21.6
		25	0	21.8	21.8	21.6

**OUTPUT POWER FOR LTE BAND 5 (10.0 MHz)**

Bandwidth (MHz)	Modulation	RB Allocation	RB Offset	Conducted Average (dBm)		
				20450	20525	20600
				829.0 MHz	836.5 MHz	844.0 MHz
10.0	QPSK	1	0	24.6	24.7	24.6
		1	24	24.5	24.7	24.6
		1	49	24.5	<b>24.7</b>	24.6
		25	0	23.6	23.8	23.7
		25	12	23.5	23.8	23.7
		25	24	23.4	23.7	23.7
	16QAM	50	0	23.5	23.8	23.7
		1	0	23.7	23.7	24.0
		1	24	23.6	23.7	<b>24.1</b>
		1	49	23.5	23.7	24.0
		25	0	22.7	22.9	22.8
		25	12	22.7	22.9	22.8
	64QAM	25	24	22.6	22.8	22.8
		50	0	22.6	22.8	22.8
		1	0	22.3	22.6	22.3
		1	24	22.3	22.5	22.2
		1	49	22.3	<b>22.6</b>	22.2
		25	0	21.9	21.9	21.7
		25	12	21.9	21.9	21.7
		25	24	21.8	21.9	21.6
		50	0	21.9	21.8	21.6



**7.5. LTE Band 7**

<b>ID:</b>	40814	<b>Date:</b>	2/23/18
------------	-------	--------------	---------

**OUTPUT POWER FOR LTE BAND 7 (5.0 MHz)**

Bandwidth (MHz)	Modulation	RB Allocation	RB Offset	Conducted Average (dBm)		
				20775	21100	21425
				2502.5 MHz	2535.0 MHz	2567.5 MHz
5.0	QPSK	1	0	22.7	22.6	<b>22.7</b>
		1	12	22.6	22.6	22.7
		1	24	22.6	22.5	22.7
		12	0	22.6	22.6	22.6
		12	6	22.7	22.6	22.6
		12	11	22.6	22.6	22.6
		25	0	22.6	22.6	22.6
	16QAM	1	0	22.3	22.6	22.3
		1	12	22.3	<b>22.7</b>	22.4
		1	24	22.3	22.6	22.3
		12	0	22.3	22.3	22.3
		12	6	22.3	22.3	22.3
		12	11	22.3	22.3	22.3
		25	0	22.2	22.2	22.2
	64QAM	1	0	<b>22.5</b>	22.1	22.5
		1	12	22.5	22.1	22.5
		1	24	22.5	22.1	22.4
		12	0	21.7	21.7	21.8
		12	6	21.7	21.7	21.8
		12	11	21.7	21.7	21.8
		25	0	21.7	21.7	21.8

**OUTPUT POWER FOR LTE BAND 7 (10.0 MHz)**

Bandwidth (MHz)	Modulation	RB Allocation	RB Offset	Conducted Average (dBm)		
				20800	21100	21400
				2505.0 MHz	2535.0 MHz	2565.0 MHz
10.0	QPSK	1	0	22.6	22.6	22.6
		1	24	22.5	22.6	22.6
		1	49	22.6	22.6	22.6
		25	0	22.6	22.6	22.6
		25	12	<b>22.7</b>	22.6	22.6
		25	24	22.7	22.6	22.6
		50	0	22.7	22.6	22.6
	16QAM	1	0	22.2	<b>22.6</b>	22.1
		1	24	22.2	22.5	22.1
		1	49	22.2	22.5	22.1
		25	0	22.3	22.2	22.2
		25	12	22.4	22.2	22.2
		25	24	22.4	22.2	22.3
		50	0	22.3	22.2	22.2
	64QAM	1	0	22.4	<b>22.5</b>	22.4
		1	24	22.3	22.4	22.4
		1	49	22.4	22.4	22.3
		25	0	21.8	21.7	21.8
		25	12	21.9	21.7	21.8
		25	24	21.9	21.7	21.8
		50	0	21.8	21.7	21.7

**OUTPUT POWER FOR LTE BAND 7 (15.0 MHz)**

Bandwidth (MHz)	Modulation	RB Allocation	RB Offset	Conducted Average (dBm)		
				20825	21100	21375
				2507.5 MHz	2535.0 MHz	2562.5 MHz
15.0	QPSK	1	0	<b>22.8</b>	22.6	22.7
		1	37	22.7	22.5	22.6
		1	74	22.6	22.4	22.6
		36	0	22.7	22.6	22.6
		36	16	22.7	22.6	22.6
		36	35	22.7	22.6	22.5
		75	0	22.6	22.6	22.6
	16QAM	1	0	22.6	22.1	<b>22.7</b>
		1	37	22.6	22.0	22.5
		1	74	22.5	22.0	22.6
		36	0	22.4	22.2	22.2
		36	16	22.4	22.2	22.2
		36	35	22.3	22.2	22.1
		75	0	22.3	22.2	22.2
	64QAM	1	0	22.4	22.5	22.7
		1	37	22.4	22.5	<b>22.7</b>
		1	74	22.3	22.4	22.7
		36	0	21.9	21.8	21.7
		36	16	21.9	21.8	21.7
		36	35	21.8	21.7	21.7
		75	0	21.8	21.7	21.7

**OUTPUT POWER FOR LTE BAND 7 (20.0 MHz)**

Bandwidth (MHz)	Modulation	RB Allocation	RB Offset	Conducted Average (dBm)		
				20850	21100	21350
				2510.0 MHz	2535.0 MHz	2560.0 MHz
20.0	QPSK	1	0	<b>22.8</b>	22.5	22.7
		1	49	22.6	22.5	22.5
		1	99	22.6	22.6	22.6
		50	0	22.7	22.6	22.6
		50	24	22.7	22.7	22.7
		50	49	22.7	22.6	22.6
		100	0	22.7	22.6	22.6
	16QAM	1	0	22.7	22.7	22.7
		1	49	22.7	22.7	22.5
		1	99	22.7	<b>22.7</b>	22.6
		50	0	22.4	22.3	22.2
		50	24	22.4	22.3	22.2
		50	49	22.3	22.2	22.1
		100	0	22.3	22.3	22.2
	64QAM	1	0	<b>22.7</b>	22.5	22.5
		1	49	<b>22.7</b>	22.4	22.4
		1	99	<b>22.7</b>	22.5	22.4
		50	0	21.9	21.8	21.8
		50	24	21.9	21.8	21.8
		50	49	21.8	21.7	21.7
		100	0	21.8	21.8	21.8

**7.6. LTE Band 13**

<b>ID:</b>	40814	<b>Date:</b>	2/23/18
------------	-------	--------------	---------

**OUTPUT POWER FOR LTE BAND 13 (5.0 MHz)**

Bandwidth (MHz)	Modulation	RB Allocation	RB Offset	Conducted Average (dBm)		
				23207	23230	23255
				779.5 MHz	782.0 MHz	784.5 MHz
5.0	QPSK	1	0	24.5	24.5	24.5
		1	12	24.7	24.7	24.7
		1	24	<b>24.9</b>	<b>24.9</b>	24.8
		12	0	23.7	23.7	23.7
		12	6	23.8	23.8	23.7
		12	11	23.8	23.8	23.8
		25	0	23.8	23.8	23.7
	16QAM	1	0	23.4	23.4	23.4
		1	12	23.7	23.7	23.7
		1	24	<b>23.8</b>	<b>23.8</b>	23.8
		12	0	22.8	22.8	22.8
		12	6	22.9	22.9	22.9
		12	11	22.9	22.9	22.9
		25	0	22.8	22.8	22.8
	64QAM	1	0	22.3	22.3	22.3
		1	12	22.6	22.6	22.6
		1	24	<b>22.7</b>	<b>22.7</b>	22.7
		12	0	21.8	21.8	21.8
		12	6	21.9	21.9	21.9
		12	11	21.9	21.9	22.0
		25	0	21.9	21.9	21.8

**OUTPUT POWER FOR LTE BAND 13 (10.0 MHz)**

Bandwidth (MHz)	Modulation	RB Allocation	RB Offset	Conducted Average (dBm)		
				N/A	23230	N/A
				N/A	782.0 MHz	N/A
10.0	QPSK	1	0		24.7	
		1	24		24.8	
		1	49		<b>24.9</b>	
		25	0		23.8	
		25	12		23.8	
		25	24		23.8	
		50	0		23.8	
	16QAM	1	0		23.8	
		1	24		24.0	
		1	49		<b>24.0</b>	
		25	0		22.9	
		25	12		23.0	
		25	24		23.0	
		50	0		22.9	
	64QAM	1	0		22.1	
		1	24		22.2	
		1	49		<b>22.3</b>	
		25	0		21.9	
		25	12		21.9	
		25	24		22.0	
		50	0		21.8	

**7.7. LTE 17**

<b>ID:</b>	40814	<b>Date:</b>	2/23/18
------------	-------	--------------	---------

**OUTPUT POWER FOR LTE BAND 17 (5.0 MHz)**

Bandwidth (MHz)	Modulation	RB Allocation	RB Offset	Conducted Average (dBm)		
				23755	23790	23825
				706.5 MHz	710.0 MHz	713.5 MHz
5.0	QPSK	1	0	24.6	<b>24.7</b>	24.4
		1	12	24.5	24.6	24.5
		1	24	24.6	24.6	24.6
		12	0	23.5	23.6	23.5
		12	6	23.6	23.6	23.6
		12	11	23.5	23.5	23.6
		25	0	23.5	23.5	23.6
	16QAM	1	0	<b>24.0</b>	23.7	23.5
		1	12	23.9	23.7	23.5
		1	24	23.9	23.7	23.5
		12	0	22.7	22.6	22.7
		12	6	22.7	22.7	22.7
		12	11	22.6	22.7	22.6
		25	0	22.6	22.6	22.6
	64QAM	1	0	<b>22.4</b>	22.3	22.4
		1	12	22.2	22.2	22.3
		1	24	22.1	22.2	22.4
		12	0	21.7	21.6	21.7
		12	6	21.7	21.7	21.7
		12	11	21.7	21.7	21.6
		25	0	21.6	21.6	21.7

**OUTPUT POWER FOR LTE BAND 17 (10.0 MHz)**

Bandwidth (MHz)	Modulation	RB Allocation	RB Offset	Conducted Average (dBm)		
				23780	23790	23800
				709.0 MHz	710.0 MHz	711.0 MHz
10.0	QPSK	1	0	24.5	24.5	24.4
		1	24	24.5	24.5	24.5
		1	49	24.6	24.5	<b>24.6</b>
		25	0	23.6	23.6	23.6
		25	12	23.6	23.6	23.6
		25	24	23.5	23.5	23.5
		50	0	23.5	23.5	23.6
	16QAM	1	0	<b>24.0</b>	23.6	23.4
		1	24	23.9	23.6	23.5
		1	49	23.9	23.6	23.5
		25	0	22.7	22.7	22.7
		25	12	22.7	22.7	22.7
		25	24	22.6	22.7	22.6
		50	0	22.6	22.7	22.6
	64QAM	1	0	22.3	22.3	22.4
		1	24	22.2	22.2	22.4
		1	49	22.2	22.2	<b>22.4</b>
		25	0	21.7	21.7	21.7
		25	12	21.7	21.7	21.7
		25	24	21.7	21.7	21.7
		50	0	21.6	21.6	21.7

**7.8. LTE 41**

<b>ID:</b>	38515	<b>Date:</b>	2/23/18
------------	-------	--------------	---------

**OUTPUT POWER FOR LTE BAND 41 (FCC) (5.0 MHz)**

Bandwidth (MHz)	Modulation	RB Allocation	RB Offset	Conducted Average (dBm)		
				39675	40620	41565
				2498.5 MHz	2593.0 MHz	2687.5 MHz
5.0	QPSK	1	0	22.4	<b>22.7</b>	22.5
		1	12	22.3	22.5	22.5
		1	24	22.4	22.5	22.5
		12	0	22.5	22.6	22.5
		12	6	22.6	22.6	22.6
		12	11	22.6	22.5	22.5
		25	0	22.6	22.6	22.5
	16QAM	1	0	21.9	<b>22.6</b>	22.2
		1	12	21.9	22.1	22.2
		1	24	22.0	22.0	22.1
		12	0	22.1	22.1	22.2
		12	6	22.2	22.1	22.2
		12	11	22.2	22.1	22.2
		25	0	22.2	22.1	22.1
	64QAM	1	0	22.2	<b>22.5</b>	21.9
		1	12	22.2	22.5	21.8
		1	24	22.3	22.5	21.8
		12	0	21.5	21.8	21.7
		12	6	21.6	21.8	21.7
		12	11	21.6	21.7	21.6
		25	0	21.6	21.6	21.7

**OUTPUT POWER FOR LTE BAND 41 (FCC) (10.0 MHz)**

Bandwidth (MHz)	Modulation	RB Allocation	RB Offset	Conducted Average (dBm)		
				39700	40620	41540
				2501.0 MHz	2593.0 MHz	2685.0 MHz
10.0	QPSK	1	0	22.5	22.5	<b>22.6</b>
		1	24	22.4	22.5	22.5
		1	49	22.5	22.5	22.5
		25	0	22.5	22.6	22.6
		25	12	22.6	22.6	22.6
		25	24	22.6	22.6	22.6
		50	0	22.6	22.6	22.6
	16QAM	1	0	22.2	22.1	22.2
		1	24	22.1	22.1	22.1
		1	49	<b>22.2</b>	22.1	22.1
		25	0	22.1	22.2	22.2
		25	12	22.2	22.2	22.2
		25	24	22.2	22.1	22.1
		50	0	22.2	22.1	22.2
	64QAM	1	0	<b>22.1</b>	21.8	22.1
		1	24	22.1	21.7	22.1
		1	49	22.1	21.7	22.1
		25	0	21.6	21.7	21.6
		25	12	21.7	21.7	21.6
		25	24	21.6	21.7	21.6
		50	0	21.7	21.6	21.7

**OUTPUT POWER FOR LTE BAND 41 (FCC) (15.0 MHz)**

Bandwidth (MHz)	Modulation	RB Allocation	RB Offset	Conducted Average (dBm)		
				39725	40620	41515
				2503.5 MHz	2593.0 MHz	2682.5 MHz
15.0	QPSK	1	0	22.4	22.6	<b>22.7</b>
		1	37	22.4	22.5	22.5
		1	74	22.5	22.5	22.4
		36	0	22.5	22.6	22.6
		36	16	22.5	22.6	22.6
		36	35	22.5	22.5	22.5
	75	0	22.5	22.5	22.6	
	16QAM	1	0	22.1	22.2	<b>22.5</b>
		1	37	22.0	22.1	22.1
		1	74	22.2	22.1	22.0
		36	0	22.1	22.2	22.2
		36	16	22.2	22.1	22.2
		36	35	22.1	22.1	22.1
	75	0	22.2	22.1	22.2	
	64QAM	1	0	22.3	21.8	22.1
		1	37	22.3	21.7	22.0
		1	74	<b>22.4</b>	21.8	21.9
		36	0	21.7	21.8	21.7
36		16	21.8	21.7	21.7	
36		35	21.7	21.7	21.6	
75	0	21.7	21.7	21.7		

**OUTPUT POWER FOR LTE BAND 41 (FCC) (20.0 MHz)**

Bandwidth (MHz)	Modulation	RB Allocation	RB Offset	Conducted Average (dBm)		
				39750	40620	41490
				2506.0 MHz	2593.0 MHz	2680.0 MHz
20.0	QPSK	1	0	22.5	22.7	<b>22.8</b>
		1	49	22.4	22.5	22.6
		1	99	22.5	22.5	22.5
		50	0	22.6	22.6	22.7
		50	24	22.6	22.6	22.6
		50	49	22.5	22.5	22.5
	100	0	22.6	22.6	22.6	
	16QAM	1	0	<b>22.7</b>	22.2	22.2
		1	49	22.1	22.1	22.0
		1	99	22.2	22.1	21.9
		50	0	22.2	22.2	22.3
		50	24	22.3	22.2	22.2
		50	49	22.2	22.1	22.1
	100	0	22.2	22.2	22.2	
	64QAM	1	0	22.0	<b>22.6</b>	22.3
		1	49	22.0	22.5	22.2
		1	99	22.1	22.6	22.0
		50	0	21.7	21.8	21.8
50		24	21.8	21.7	21.7	
50		49	21.7	21.6	21.6	
100	0	21.7	21.7	21.7		

---

## 8. CONDUCTED TEST RESULTS

### 8.1. OCCUPIED BANDWIDTH

#### RULE PART(S)

FCC: §2.1049

#### LIMITS

For reporting purposes only

#### TEST PROCEDURE

The transmitter output was connected to a calibrated coaxial cable and coupler, the other end of which was connected to a spectrum analyzer. The occupied bandwidth was measured with the spectrum analyzer at the middle channel in each band. The 99% and -26dB bandwidths was also measured and recorded.

#### MODES TESTED

- GSM
- WCDMA
- LTE Band 4
- LTE Band 5
- LTE Band 7
- LTE Band 13
- LTE Band 17
- LTE Band 41

#### RESULTS

There is no limit required and power is the same for low, middle and high channel; therefore, only middle channel was tested.

**GSM**

Band	Modulation	Channel	f(MHz)	99% BW (KHz)	-26dB BW (KHz)
850MHz	GPRS	190	836.6	244.95	274.08
	EGPRS			247.71	283.27
1900MHz	GPRS	661	1880.0	249.72	275.98
	EGPRS			250.25	286.31

**WCDMA**

Band	Modulation	Channel	f(MHz)	99% BW (MHz)	-26dB BW (MHz)
BAND 5	REL 99	4408	836.6	4.12	4.53
	HSDPA			4.11	4.52
BAND 2	REL 99	9800	1880.0	4.13	4.56
	HSDPA			4.12	4.57
BAND 4	REL 99	1638	1732.6	4.15	4.53
	HSDPA			4.11	4.54



**LTE BAND 4**

Band	Mode	RB Allocation/RB Offset	f(MHz)	99% BW (MHz)	-26dB BW (MHz)
LTE BAND 4	1.4 MHz, QPSK	6/0	1732.5	1.09	1.19
	1.4 MHz, 16QAM			1.09	1.19
	3 MHz, QPSK	15/0		2.69	2.87
	3 MHz, 16QAM			2.70	2.89
	5 MHz, QPSK	25/0		4.51	4.76
	5 MHz, 16QAM			4.49	4.81
	10 MHz, QPSK	50/0		8.95	9.51
	10 MHz, 16QAM			8.95	9.45
	15 MHz, QPSK	75/0		13.42	14.16
	15 MHz, 16QAM			13.41	14.08
20 MHz, QPSK	100/0	17.86	18.82		
20 MHz, 16QAM		17.84	18.79		

**LTE BAND 5**

Band	Mode	RB Allocation/RB Offset	f(MHz)	99% BW (MHz)	-26dB BW (MHz)
LTE BAND 5	1.4 MHz, QPSK	6/0	836.5	1.09	1.16
	1.4 MHz, 16QAM			1.09	1.19
	3 MHz, QPSK	15/0		2.67	2.86
	3 MHz, 16QAM			2.68	2.88
	5 MHz, QPSK	25/0		4.48	4.78
	5 MHz, 16QAM			4.49	4.79
	10 MHz, QPSK	50/0		8.94	9.44
	10 MHz, 16QAM			8.94	9.39

**LTE BAND 7**

Band	Mode	RB Allocation/RB Offset	f(MHz)	99% BW (MHz)	-26dB BW (MHz)
LTE BAND 7	5 MHz, QPSK	25/0	2535.0	4.53	4.78
	5 MHz, 16QAM			4.50	4.77
	10 MHz, QPSK	50/0		8.97	9.54
	10 MHz, 16QAM			8.96	9.51
	15 MHz, QPSK	75/0		13.41	14.14
	15 MHz, 16QAM			13.44	14.04
	20 MHz, QPSK	100/0		17.90	18.92
	20 MHz, 16QAM			17.85	18.76

**LTE BAND 13**

Band	Mode	RB Allocation/RB Offset	f(MHz)	99% BW (MHz)	-26dB BW (MHz)
LTE BAND 13	5 MHz, QPSK	25/0	782.0	4.50	4.81
	5 MHz, 16QAM			4.49	4.76
	10 MHz, QPSK	50/0		8.94	9.46
	10 MHz, 16QAM			8.95	9.41

**LTE BAND 17**

Band	Mode	RB Allocation/RB Offset	f(MHz)	99% BW (MHz)	-26dB BW (MHz)
LTE BAND 17	5 MHz, QPSK	25/0	710.0	4.49	4.85
	5 MHz, 16QAM			4.49	4.78
	10 MHz, QPSK	50/0		8.95	9.48
	10 MHz, 16QAM			8.96	9.42

**LTE BAND 41**

Band	Mode	RB Allocation/RB Offset	f(MHz)	99% BW (MHz)	-26dB BW (MHz)
LTE BAND 41	5 MHz, QPSK	25/0	2593.0	4.50	4.78
	5 MHz, 16QAM			4.50	4.76
	10 MHz, QPSK	50/0		8.96	9.44
	10 MHz, 16QAM			8.97	9.45
	15 MHz, QPSK	75/0		13.41	14.12
	15 MHz, 16QAM			13.39	14.07
	20 MHz, QPSK	100/0		17.79	18.67
	20 MHz, 16QAM			17.89	18.73

8.1.1. GSM

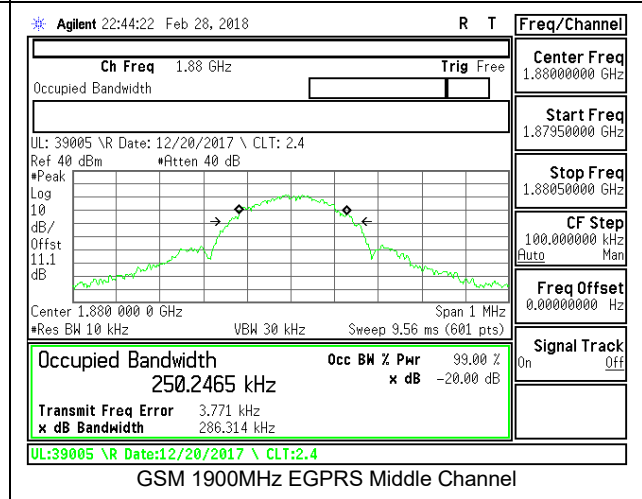
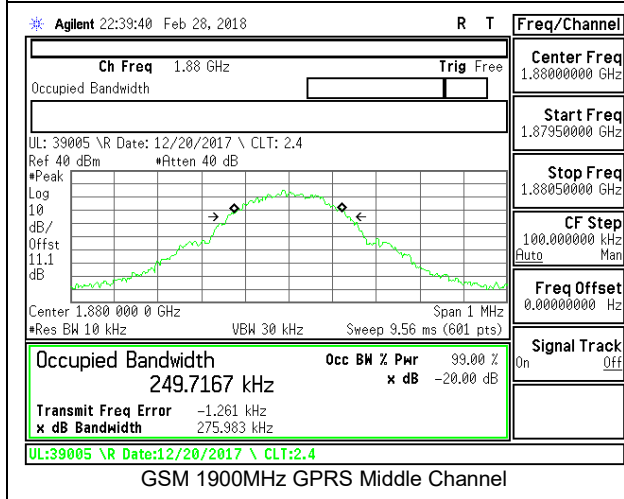
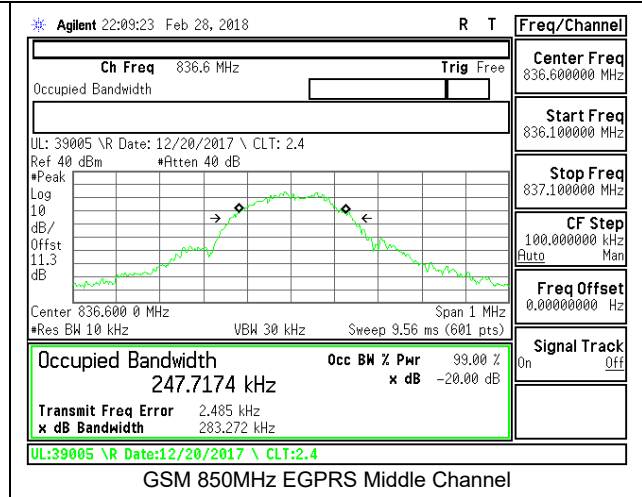
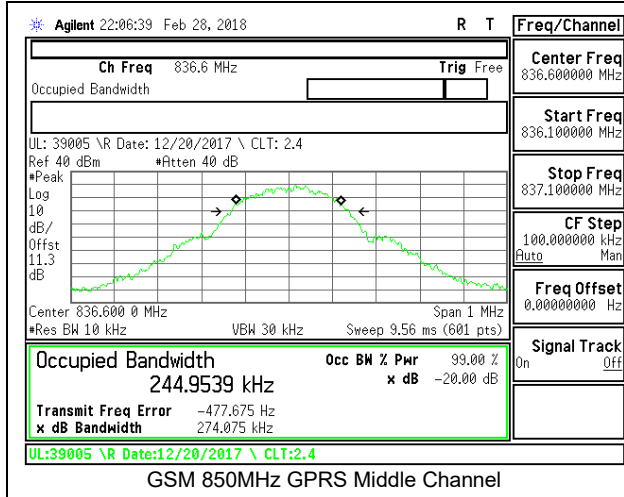

8.1.2. WCDMA

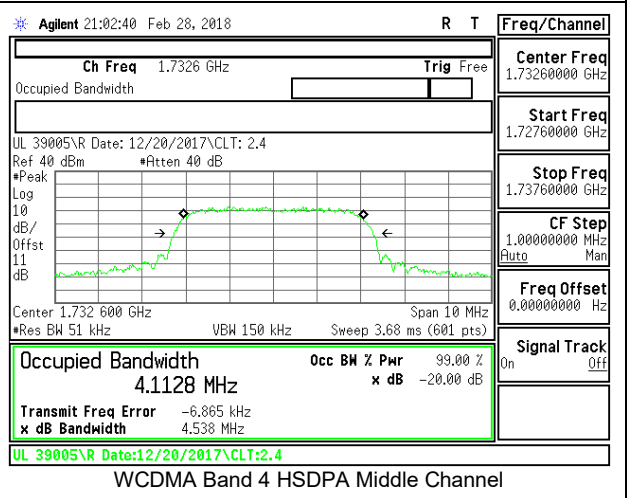
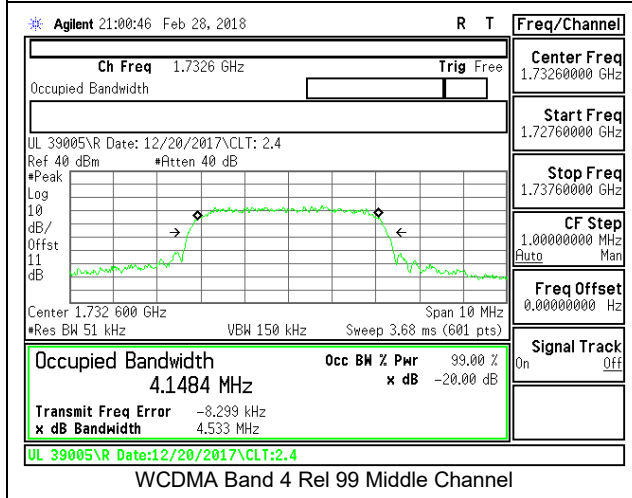
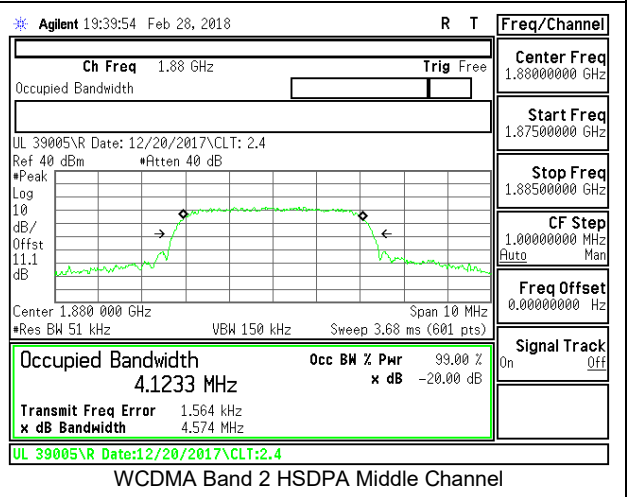
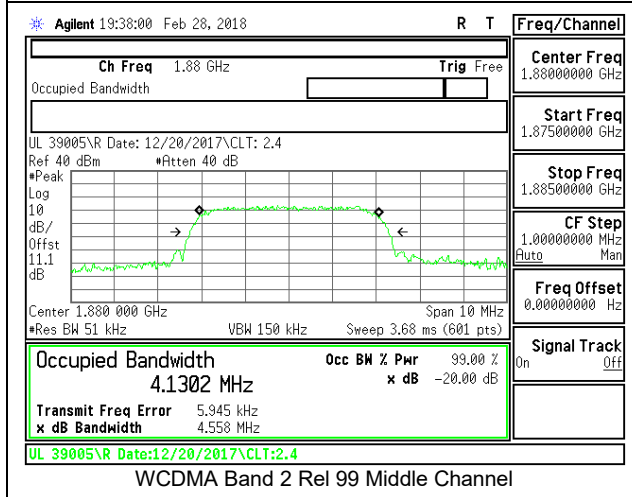
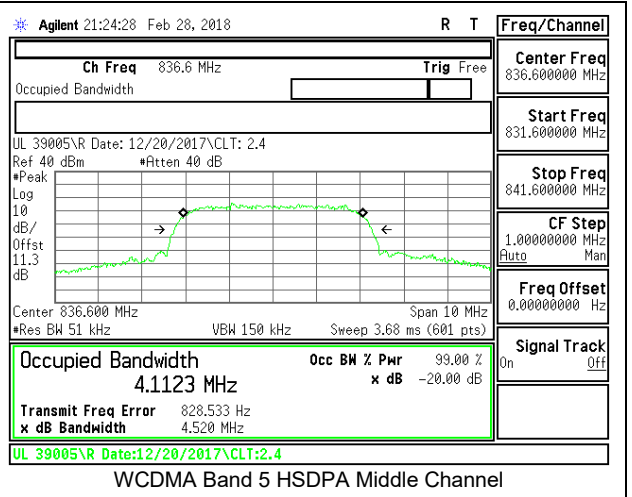
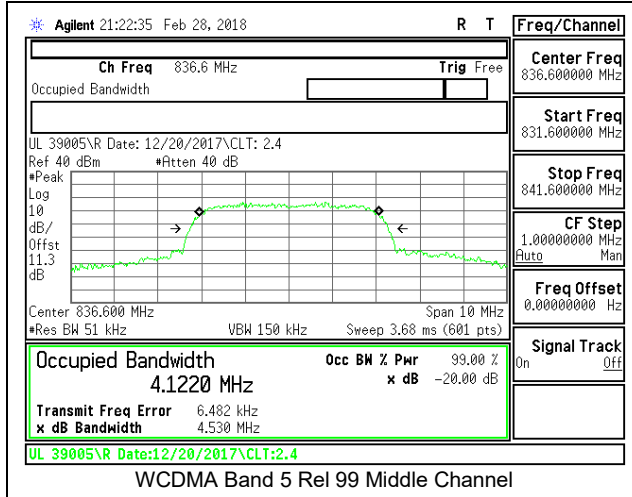

8.1.3. LTE BAND 4

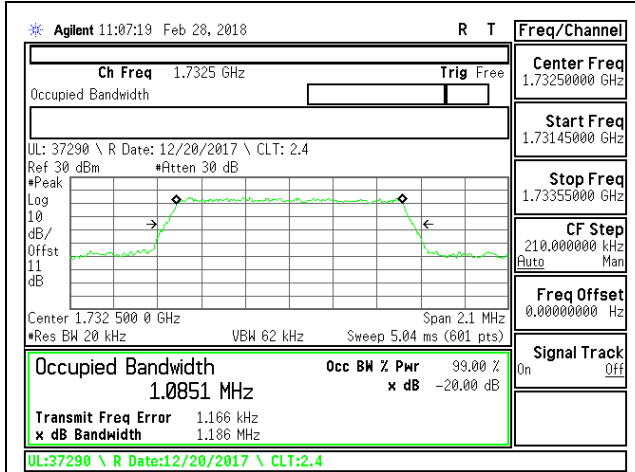

LTE B4 1.4MHz QPSK Mid Channel RB6-0

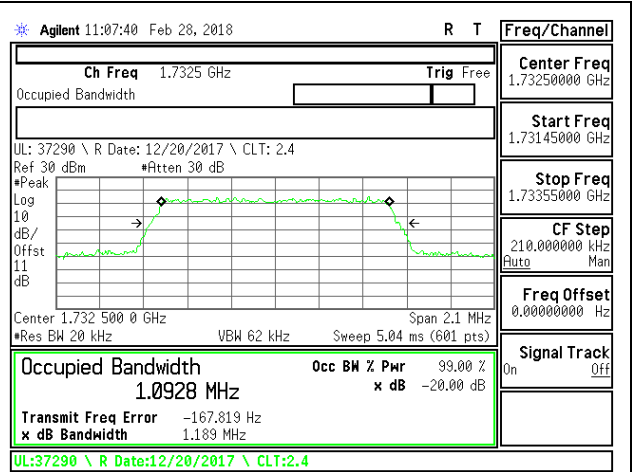

LTE B4 1.4MHz 16QAM Mid Channel RB6-0

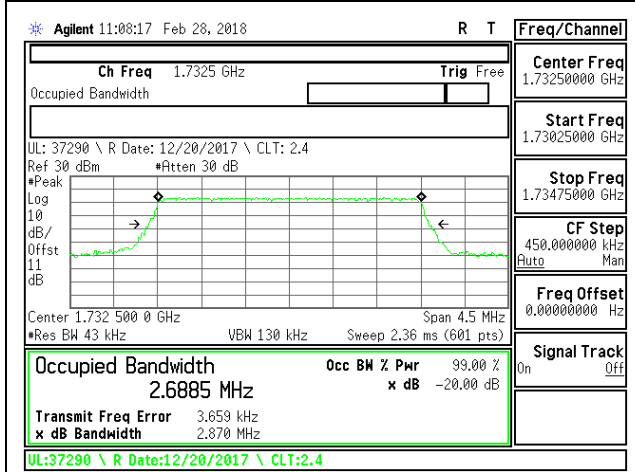

LTE B4 3MHz QPSK Mid Channel RB15-0

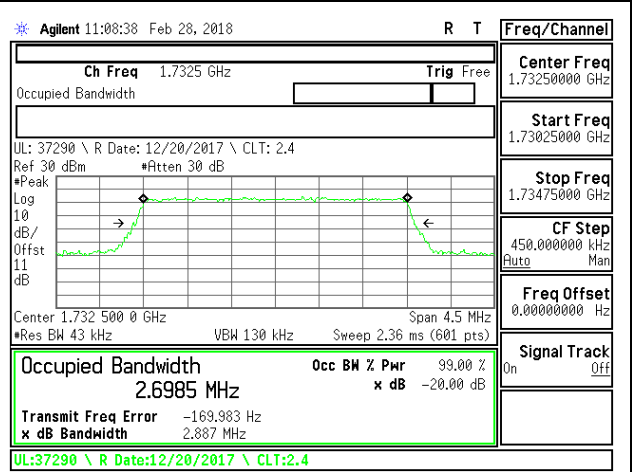

LTE B4 3MHz 16QAM Mid Channel RB15-0

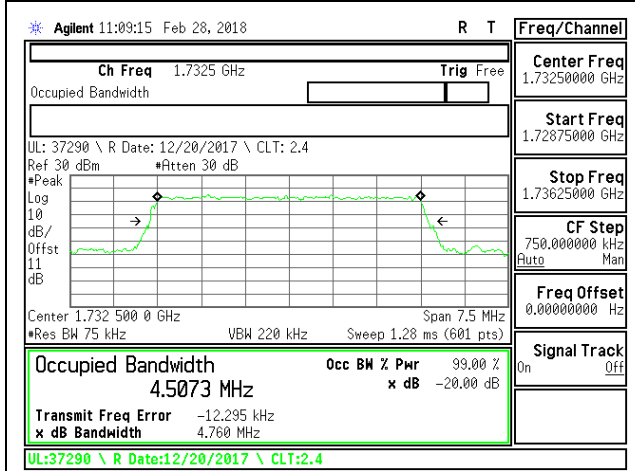

LTE B4 5MHz QPSK Mid Channel RB25-0

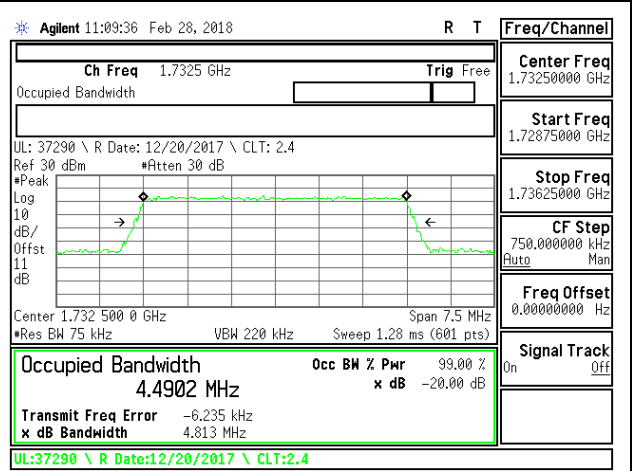

LTE B4 5MHz 16QAM Mid Channel RB25-0

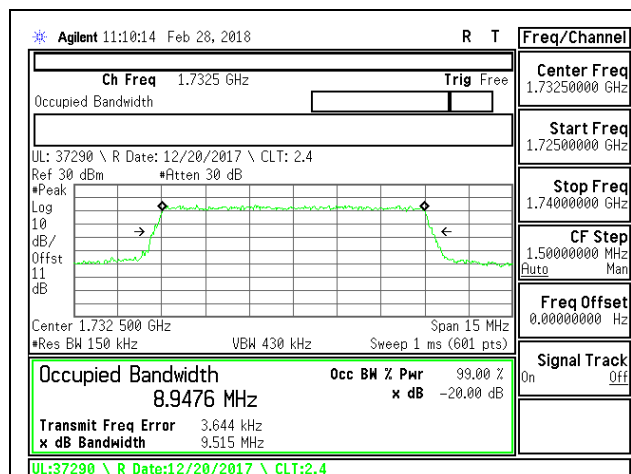

LTE B4 10MHz QPSK Mid Channel RB50-0

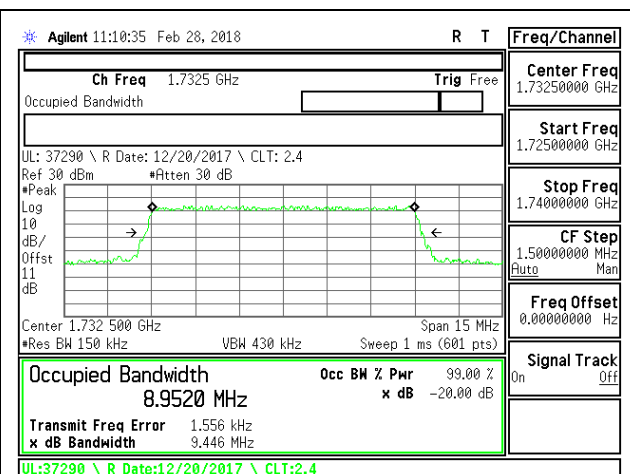

LTE B4 10MHz 16QAM Mid Channel RB50-0

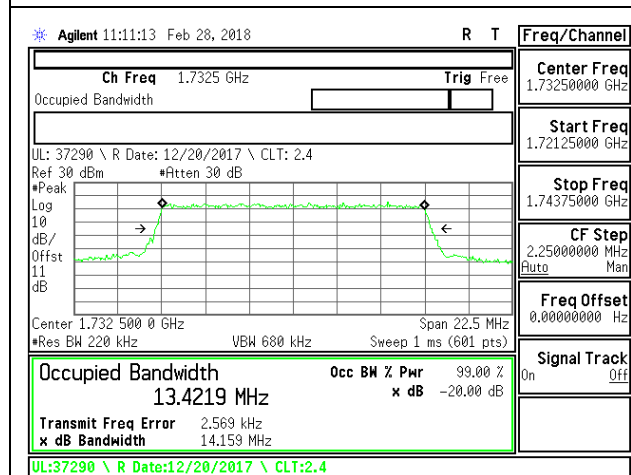

LTE B4 15MHz QPSK Mid Channel RB75-0

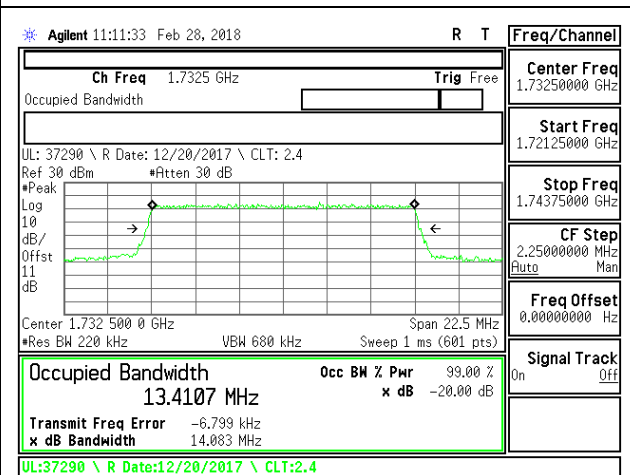

LTE B4 15MHz 16QAM Mid Channel RB75-0

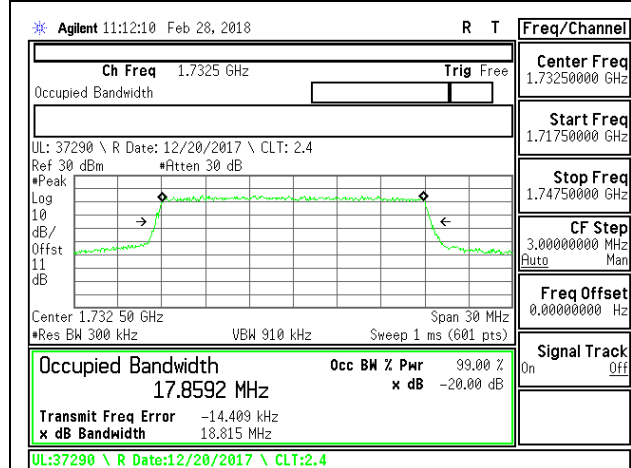

LTE B4 20MHz QPSK Mid Channel RB100-0

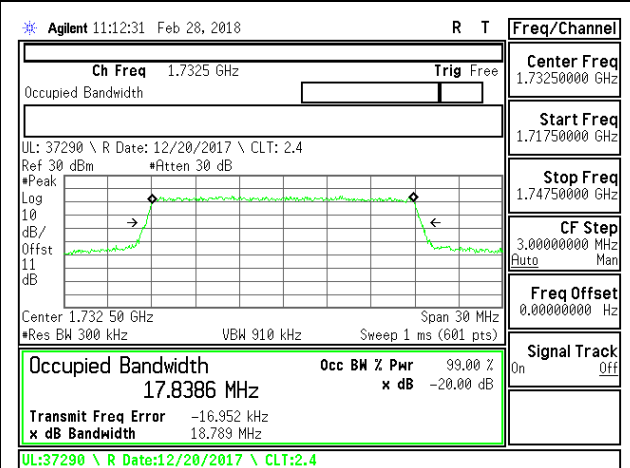

LTE B4 20MHz 16QAM Mid Channel RB100-0

8.1.4. LTE BAND 5

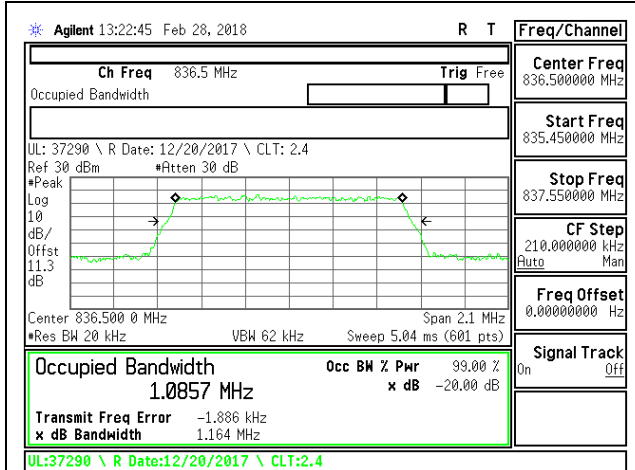

LTE B5 1.4MHz QPSK Mid Channel RB6-0

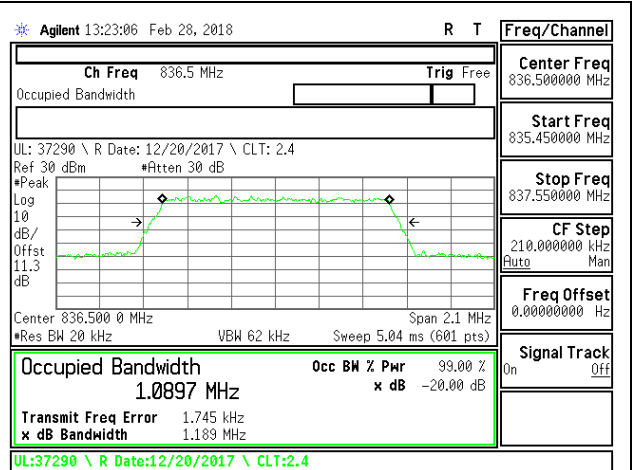

LTE B5 1.4MHz 16QAM Mid Channel RB6-0

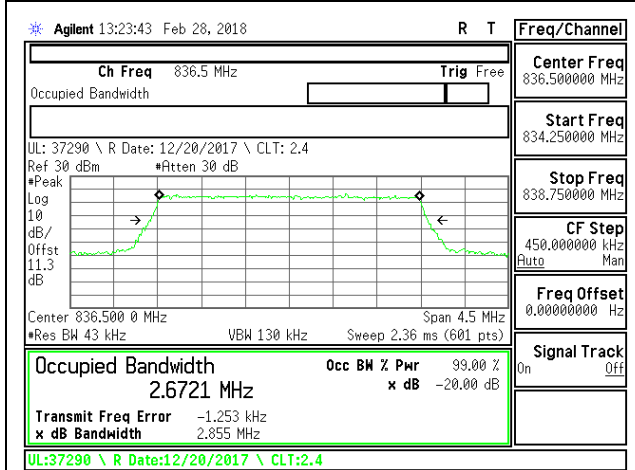

LTE B5 3MHz QPSK Mid Channel RB15-0

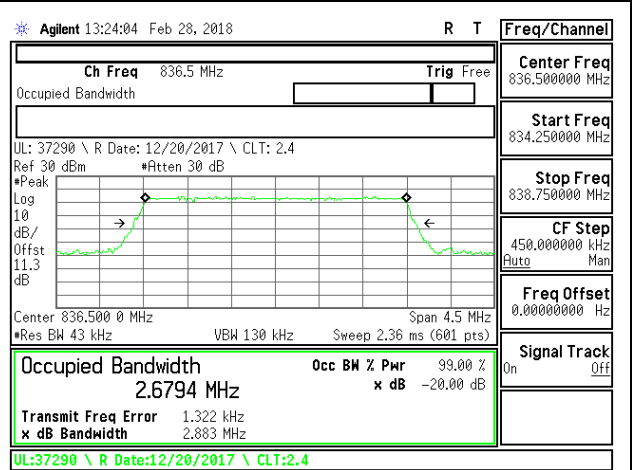

LTE B5 3MHz 16QAM Mid Channel RB15-0

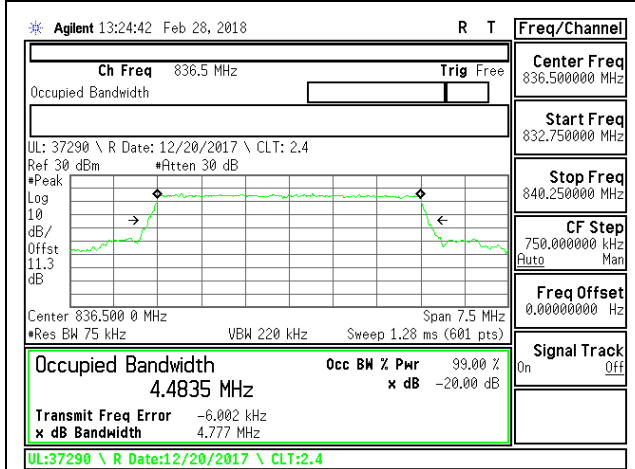

LTE B5 5MHz QPSK Mid Channel RB25-0

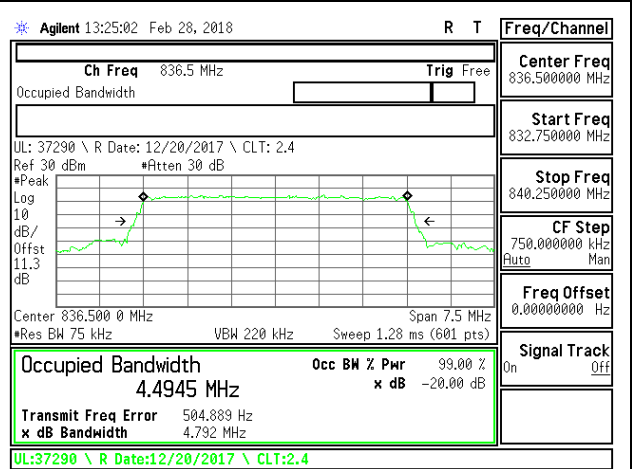

LTE B5 5MHz 16QAM Mid Channel RB25-0

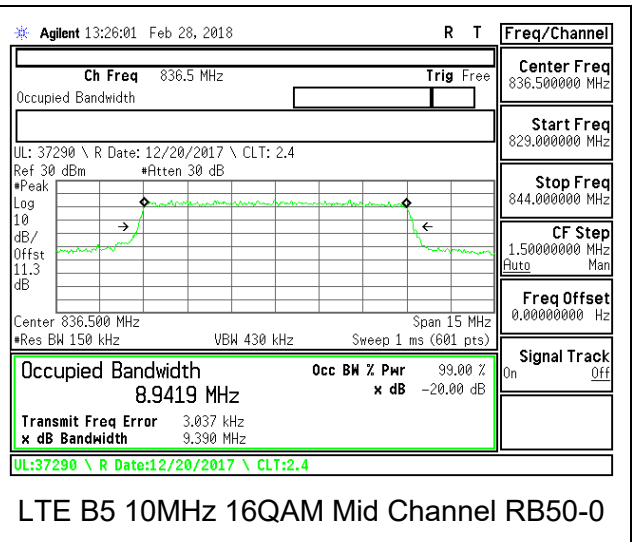
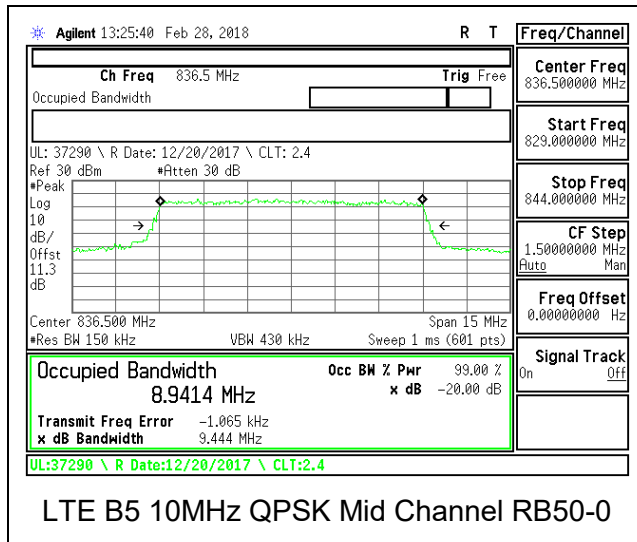



8.1.5. LTE BAND 7

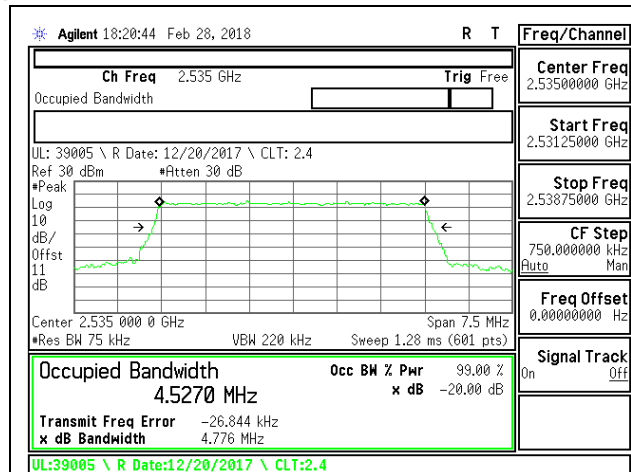

LTE B7 5MHz QPSK Mid Channel RB25-0

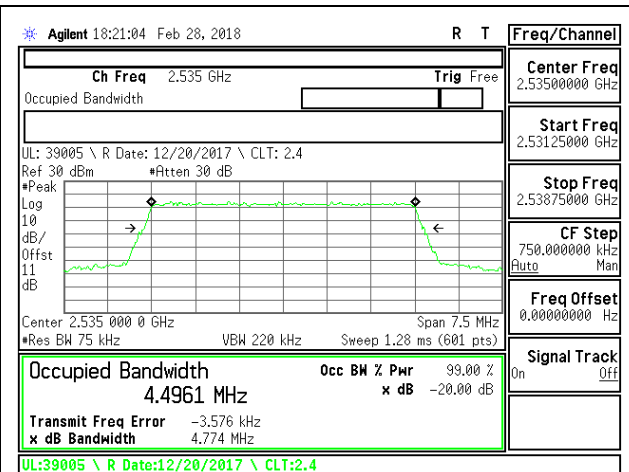

LTE B7 5MHz 16QAM Mid Channel RB25-0

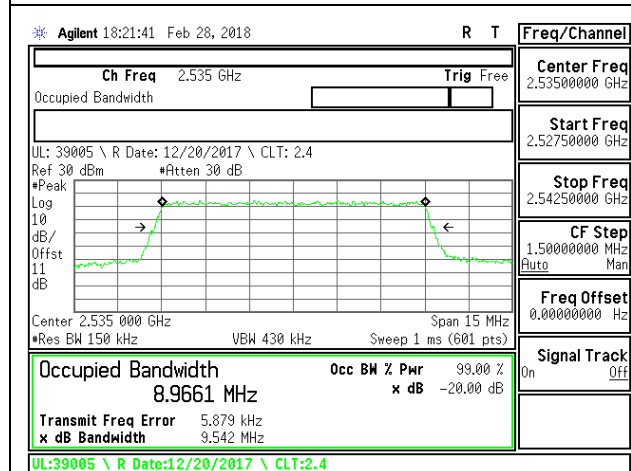

LTE B7 10MHz QPSK Mid Channel RB50-0

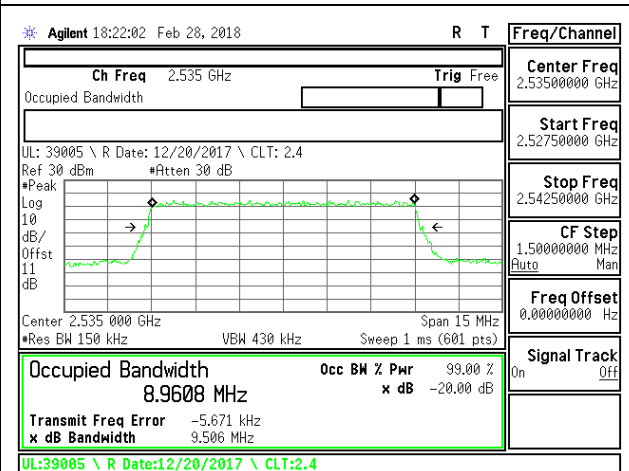

LTE B7 10MHz 16QAM Mid Channel RB50-0

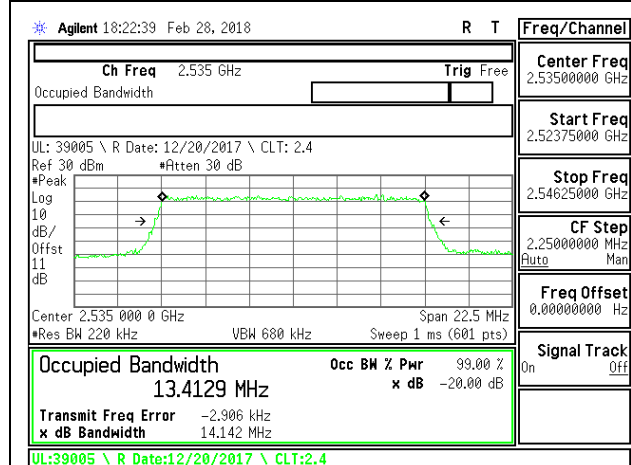

LTE B7 15MHz QPSK Mid Channel RB75-0

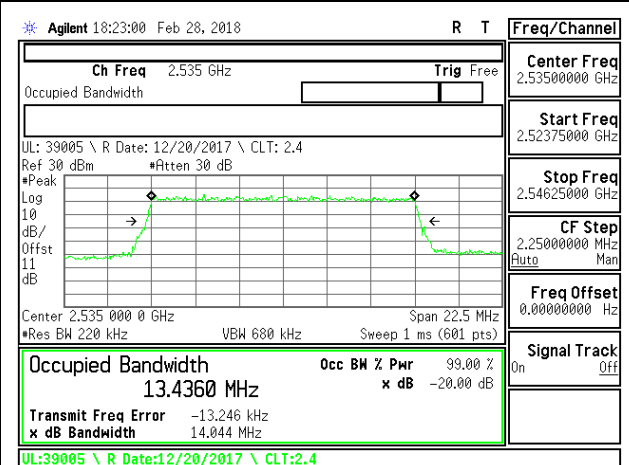

LTE B7 15MHz 16QAM Mid Channel RB75-0

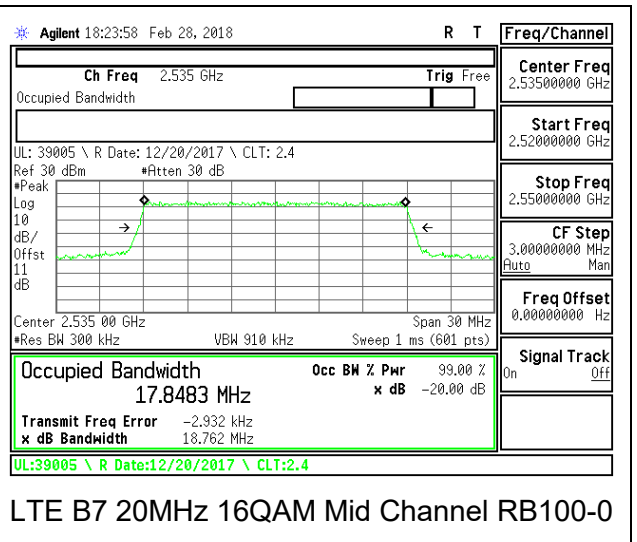
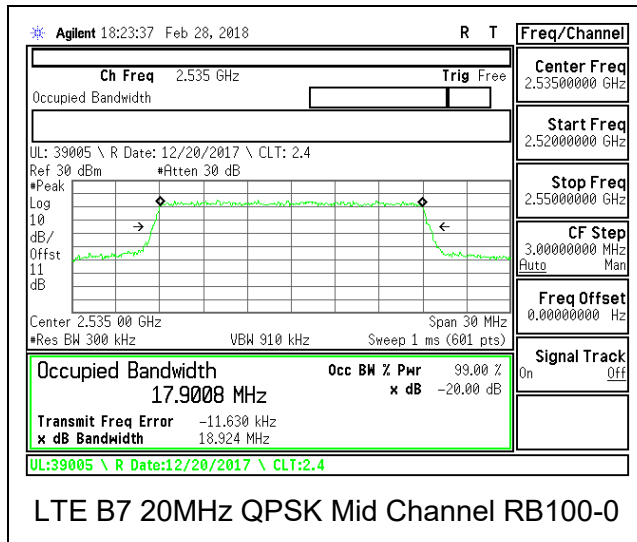

8.1.6. LTE BAND 13

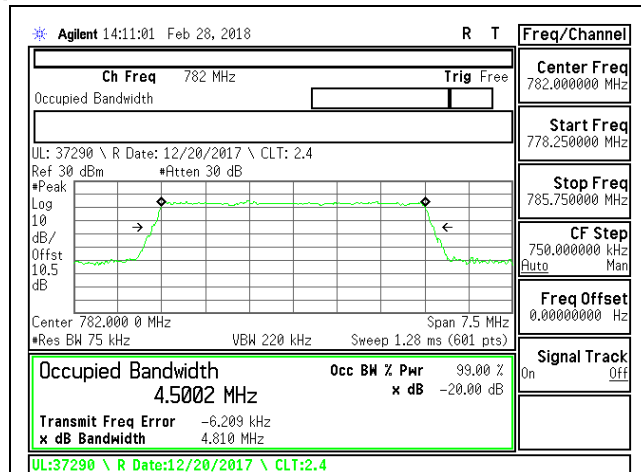

LTE B13 5MHz QPSK Mid Channel RB25-0

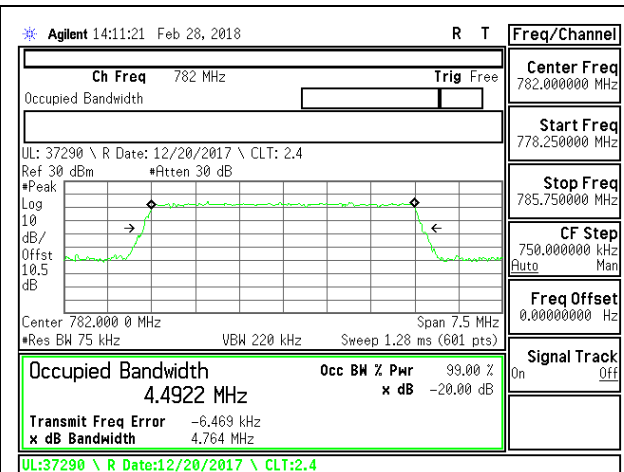

LTE B13 5MHz 16QAM Mid Channel RB25-0

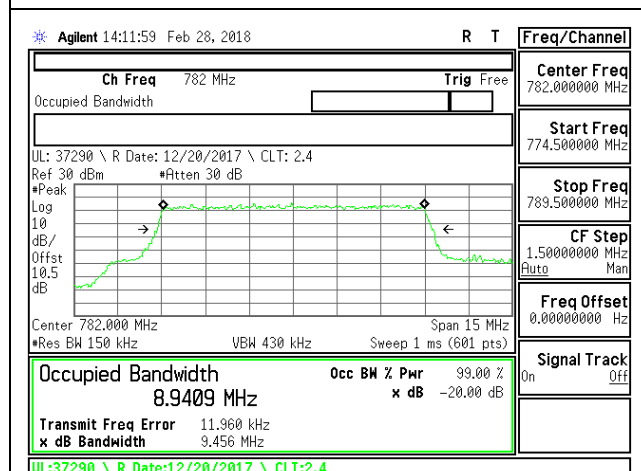

LTE B13 10MHz QPSK Mid Channel RB50-0

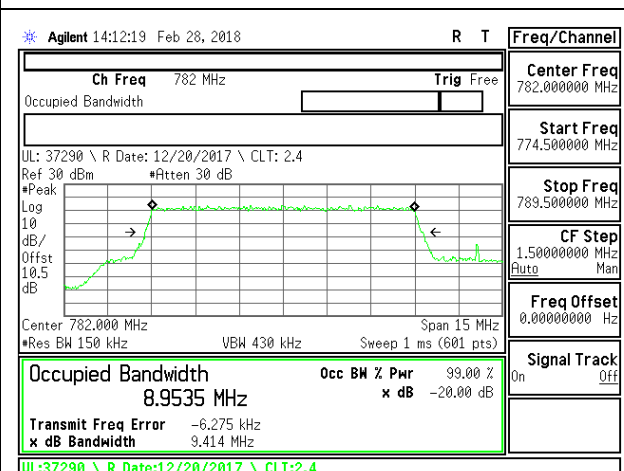

LTE B13 10MHz 16QAM Mid Channel RB50-0

8.1.7. LTE BAND 17

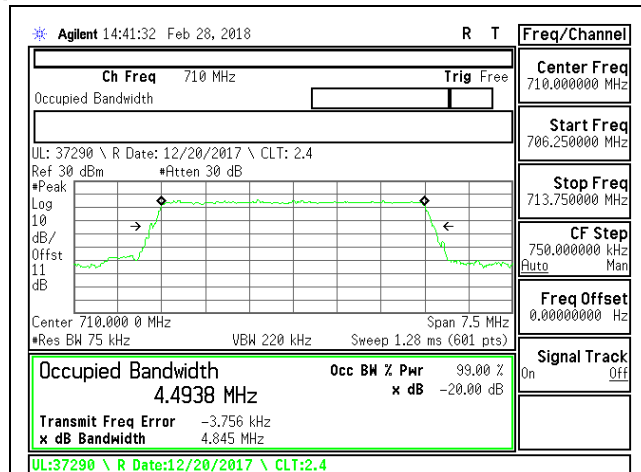

LTE B17 5MHz QPSK Mid Channel RB25-0

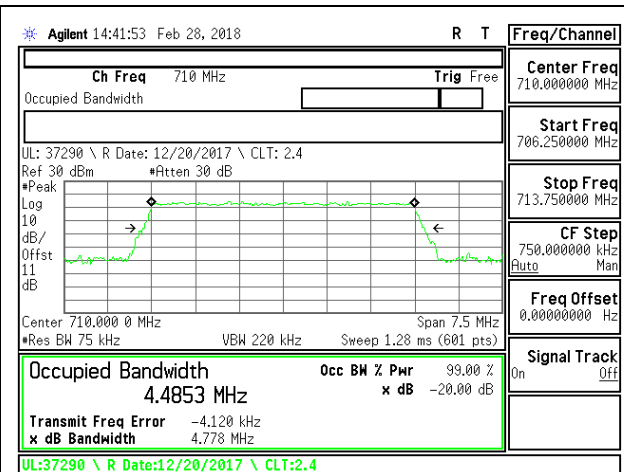

LTE B17 5MHz 16QAM Mid Channel RB25-0

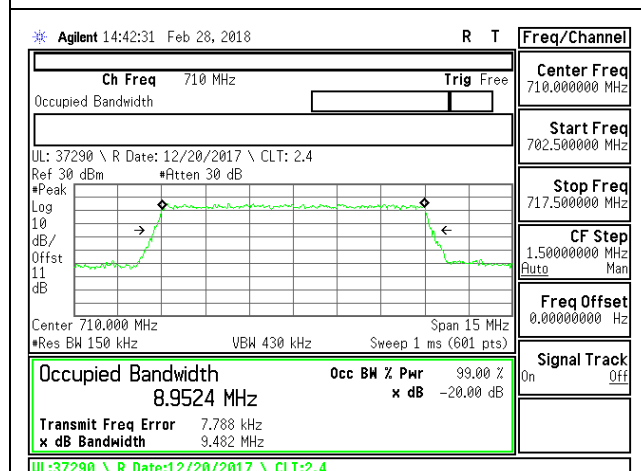

LTE B17 10MHz QPSK Mid Channel RB50-0

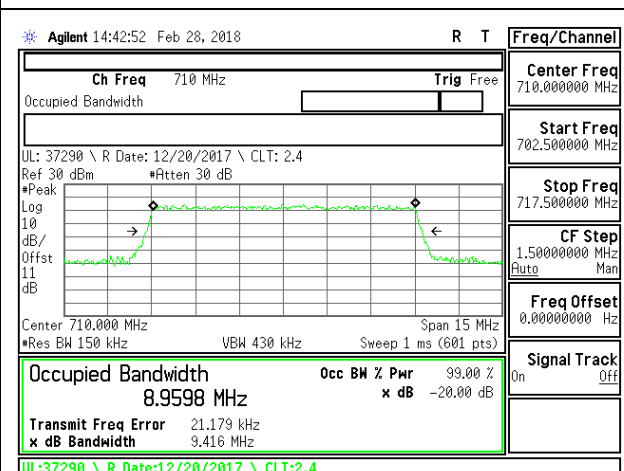

LTE B17 10MHz 16QAM Mid Channel RB50-0

8.1.8. LTE BAND 41

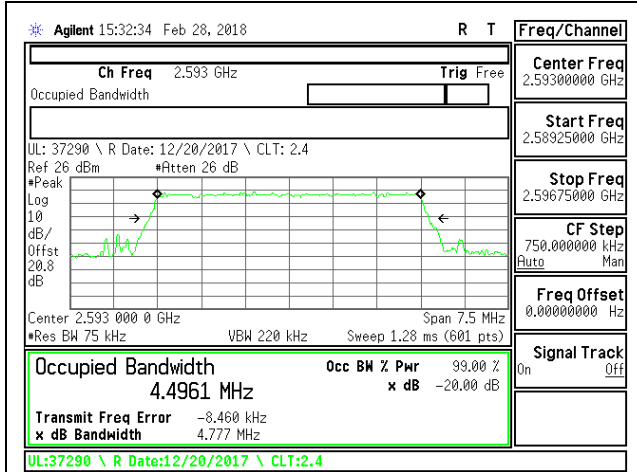

LTE B41 5MHz QPSK Mid Channel RB25-0

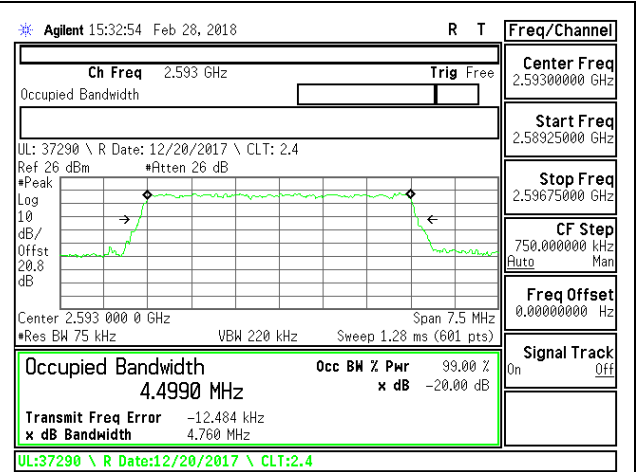

LTE B41 5MHz 16QAM Mid Channel RB25-0

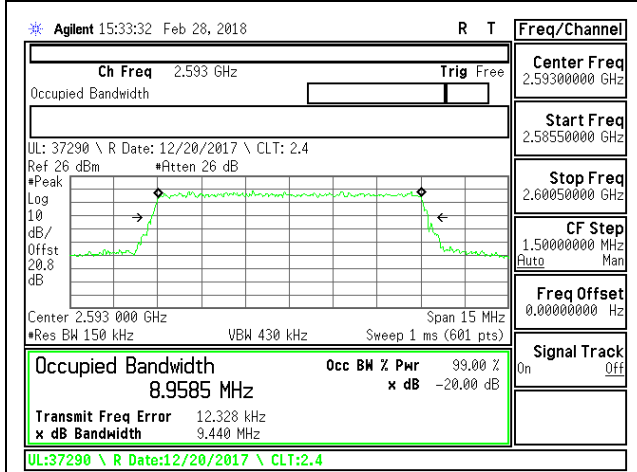

LTE B41 10MHz QPSK Mid Channel RB50-0

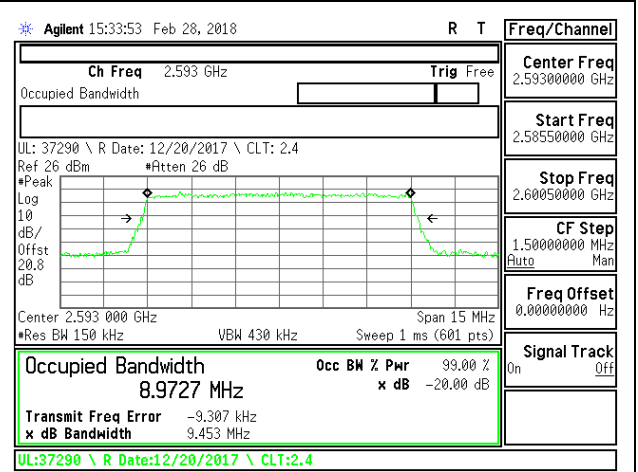

LTE B41 10MHz 16QAM Mid Channel RB50-0

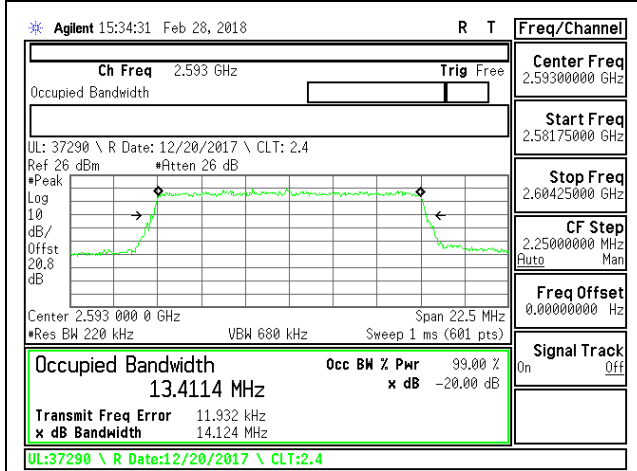

LTE B41 15MHz QPSK Mid Channel RB75-0

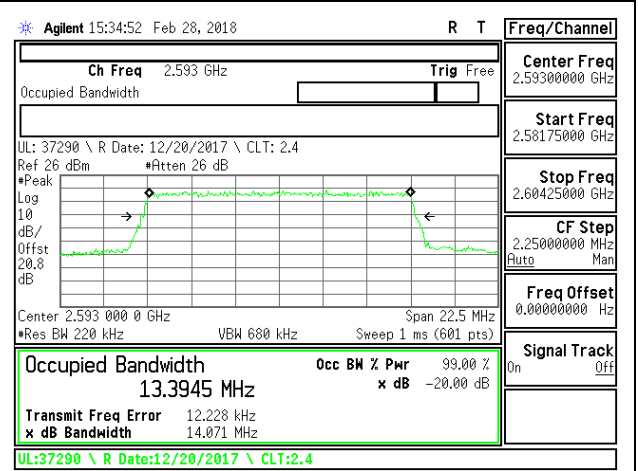

LTE B41 15MHz 16QAM Mid Channel RB75-0

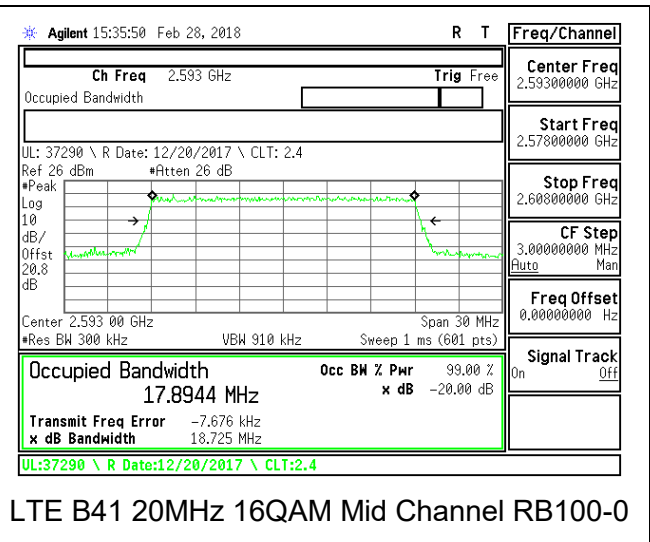
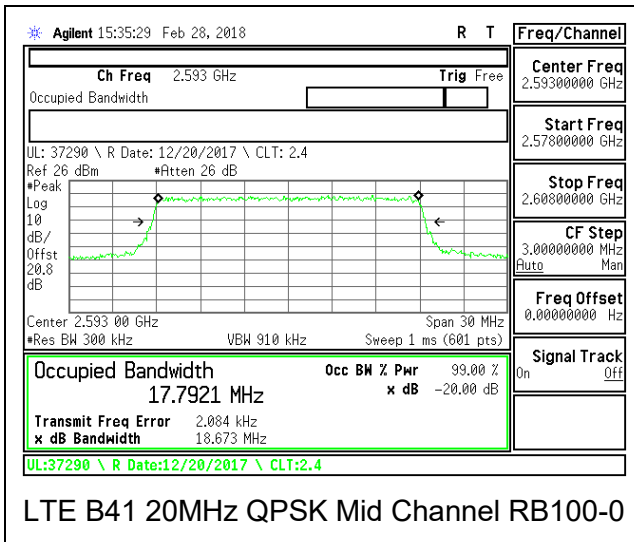

## 8.2. BAND EDGE AND EMISSION MASK

### RULE PART(S)

FCC: §2.1051, §22.917, §24.238, §27.53

### LIMITS

FCC: §22.917, §24.238, §27.53(h)

The power of any emission outside of the authorized operating frequency ranges must be attenuated below the transmitting power (P) by a factor of at least  $43 + 10 \log (P)$  dB.

FCC: §27.53 (Band 13)

(c) For operations in the 746-758 MHz band and the 776-788 MHz band, the power of any emission outside the licensee's frequency band(s) of operation shall be attenuated below the transmitter power (P) within the licensed band(s) of operation, measured in watts, in accordance with the following:

(2) On any frequency outside the 776-788 MHz band, the power of any emission shall be attenuated outside the band below the transmitter power (P) by at least  $43 + 10 \log (P)$  dB;

(4) On all frequencies between 763-775 MHz and 793-805 MHz, by a factor not less than  $65 + 10 \log (P)$  dB in a 6.25 kHz band segment, for mobile and portable stations;

(5) Compliance with the provisions of paragraphs (c)(2) of this section is based on the use of measurement instrumentation employing a resolution bandwidth of 100 kHz or greater. However, in the 100 kHz bands immediately outside and adjacent to the frequency block, a resolution bandwidth of at least 30 kHz may be employed;

(6) Compliance with the provisions of paragraphs (c)(4) of this section is based on the use of measurement instrumentation such that the reading taken with any resolution bandwidth setting should be adjusted to indicate spectral energy in a 6.25 kHz segment.

(f) Emissions in the band 1559-1610 MHz shall be limited to  $-70$  dBW/MHz equivalent isotropically radiated power (EIRP) for wideband signals. ( $-70$  dBW/MHz =  $-40$  dBm/MHz).

FCC: §27.53 (Band 12, 17)

(g) For operations in the 600 MHz band and the 698-746 MHz band, the power of any emission outside a licensee's frequency band(s) of operation shall be attenuated below the transmitter power (P) within the licensed band(s) of operation, measured in watts, by at least  $43 + 10 \log (P)$  dB. Compliance with this provision is based on the use of measurement instrumentation employing a resolution bandwidth of 100 kilohertz or greater. However, in the 100 kilohertz bands immediately outside and adjacent to a licensee's frequency block, a resolution bandwidth of at least 30 kHz may be employed.

FCC: §27.53 (Band 7, 41)

(m)(4) For mobile digital stations, the attenuation factor shall be not less than  $40 + 10 \log (P)$  dB on all frequencies between the channel edge and 5 megahertz from the channel edge,  $43 + 10 \log (P)$  dB on all frequencies between 5 megahertz and X megahertz from the channel edge, and  $55 + 10 \log (P)$  dB on all frequencies more than X megahertz from the channel edge, where X is the greater of 6 megahertz or the actual emission bandwidth as defined in paragraph (m)(6) of this section. In addition, the attenuation factor shall not be less than  $43 + 10 \log (P)$  dB on all frequencies between 2490.5 MHz and 2496 MHz and  $55 + 10 \log (P)$  dB at or below 2490.5 MHz. Mobile Satellite Service licensees operating on frequencies below 2495 MHz may also submit a documented interference complaint against BRS licensees operating on channel BRS Channel 1 on the same terms and conditions as adjacent channel BRS or EBS licensees.

### TEST PROCEDURE

---

The transmitter output was connected to a CMW500Test Set and configured to operate at maximum power. The band edge emissions were measured at the required operating frequencies in each band on the Spectrum Analyzer.

For each band edge measurement:

- Set the spectrum analyzer span to include the block edge frequency.
- Set a marker to point the corresponding band edge frequency in each test case.
- Set display line at -13 dBm
- Set resolution bandwidth to at least 1% of emission bandwidth.

#### **MODES TESTED**

- GSM
- WCDMA
- LTE Band 4
- LTE Band 5
- LTE Band 7
- LTE Band 13
- LTE Band 17
- LTE Band 41

#### **RESULTS**



8.2.1. GSM 850MHz

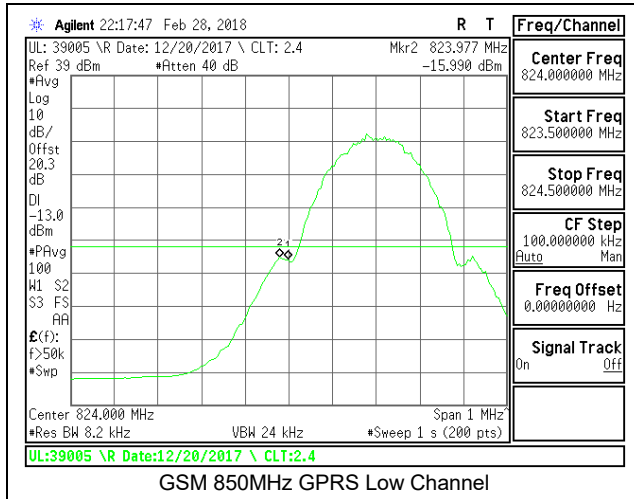

GSM 850MHz GPRS Low Channel

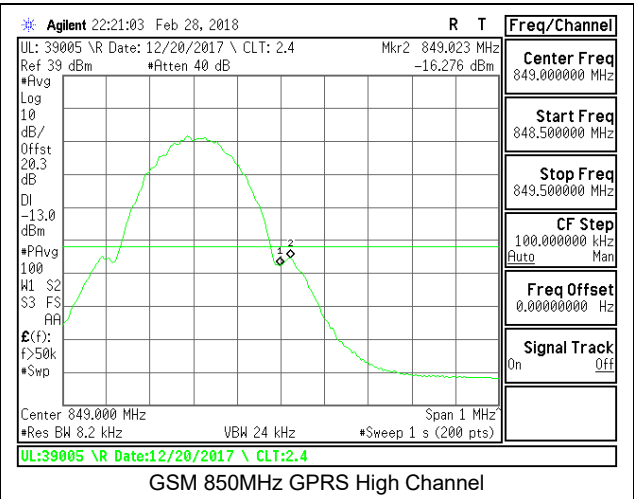

GSM 850MHz GPRS High Channel

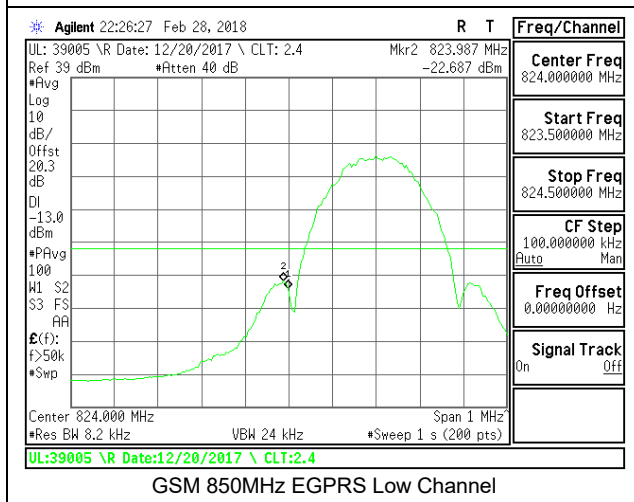

GSM 850MHz EGPRS Low Channel

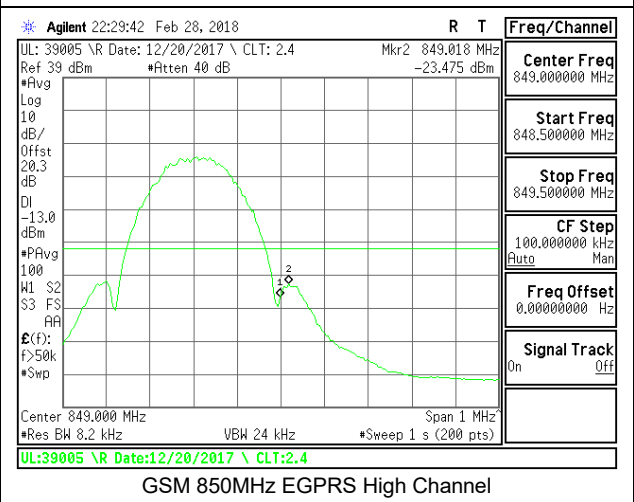

GSM 850MHz EGPRS High Channel

8.2.2. GSM 1900MHz

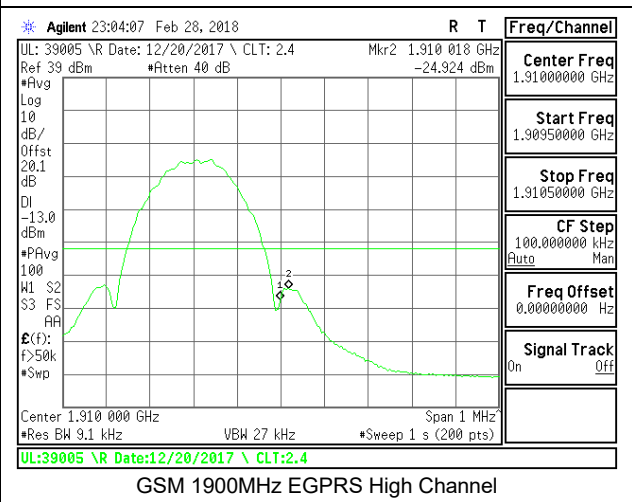
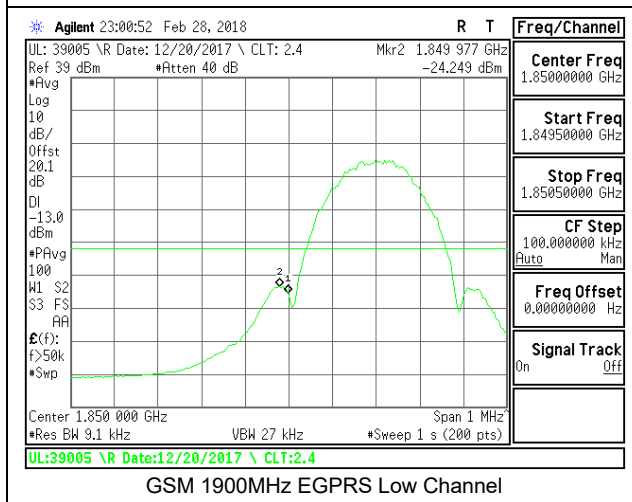
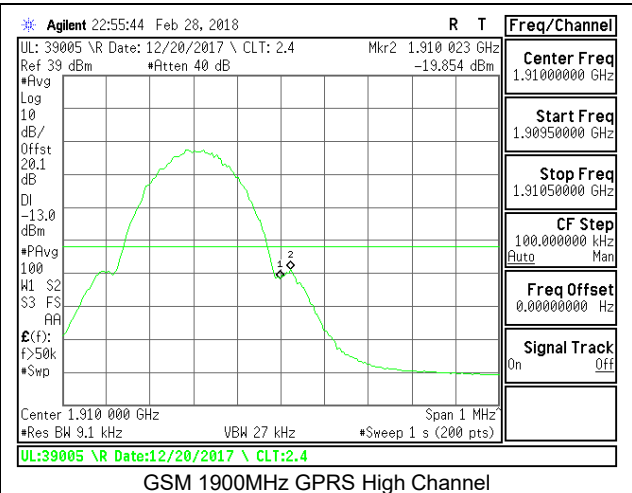
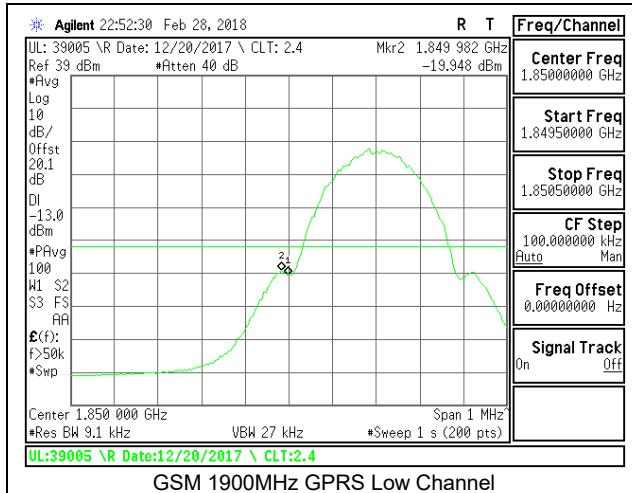

8.2.1. WCDMA BAND 5

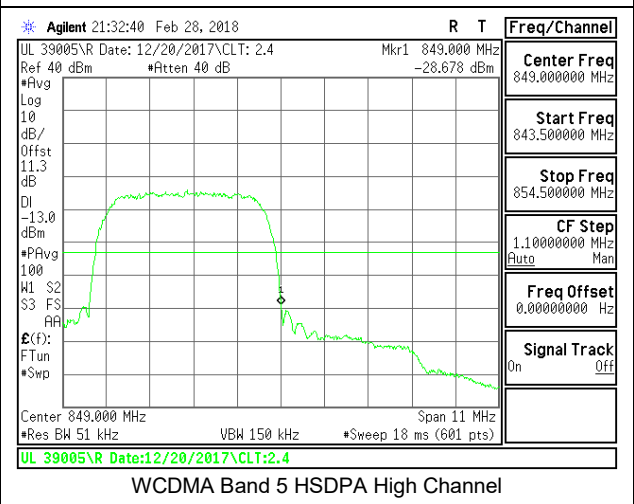
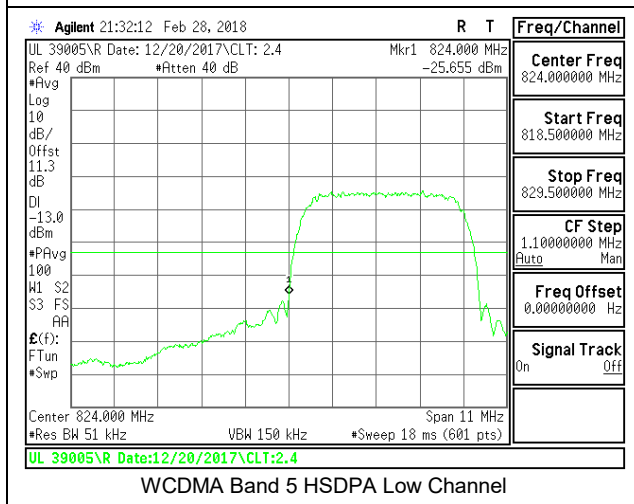
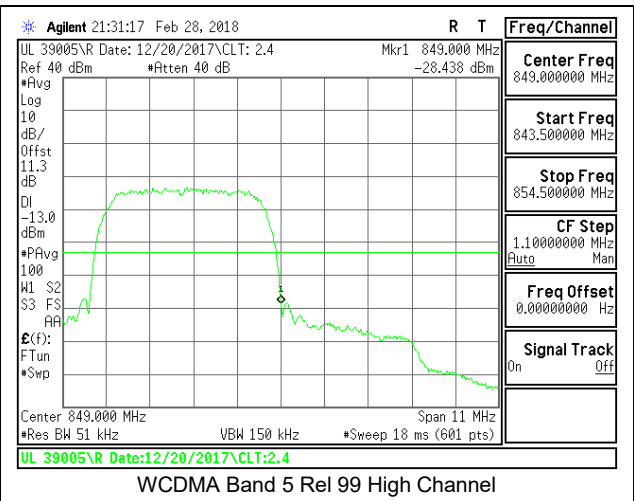
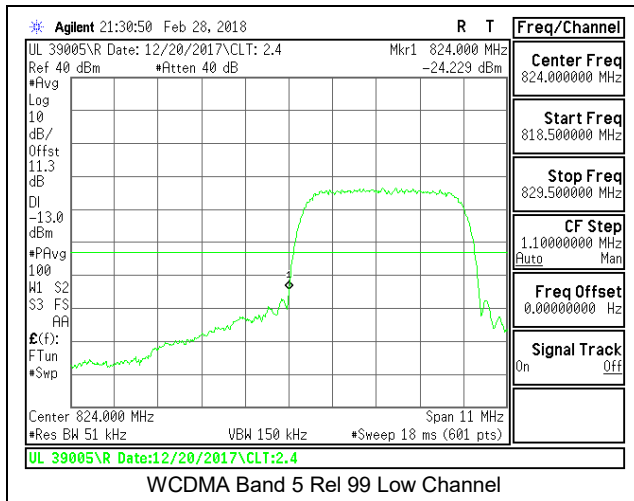

8.2.2. WCDMA BAND 2

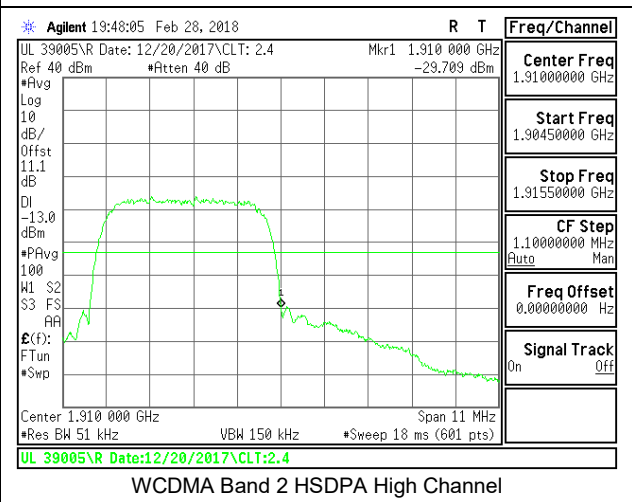
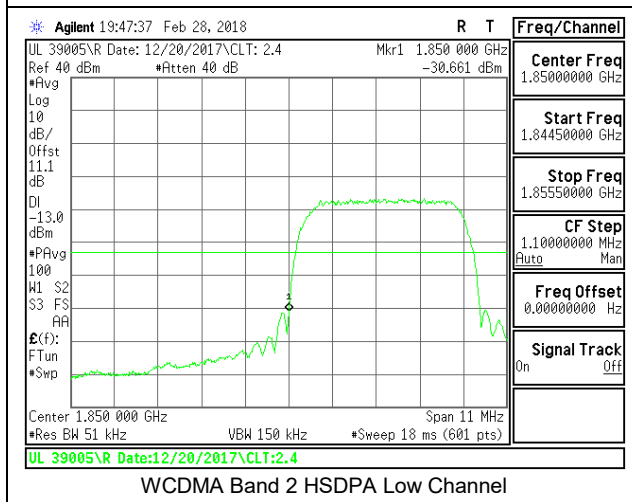
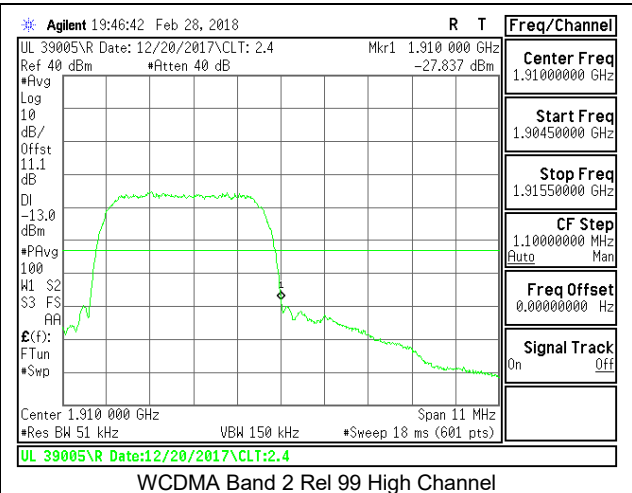
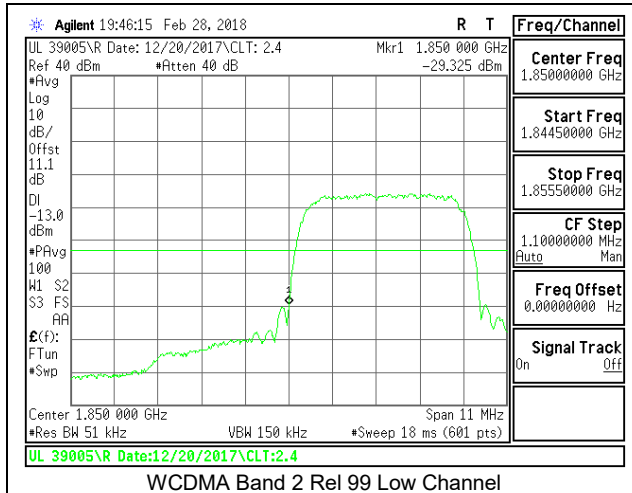

8.2.3. WCDMA BAND 4

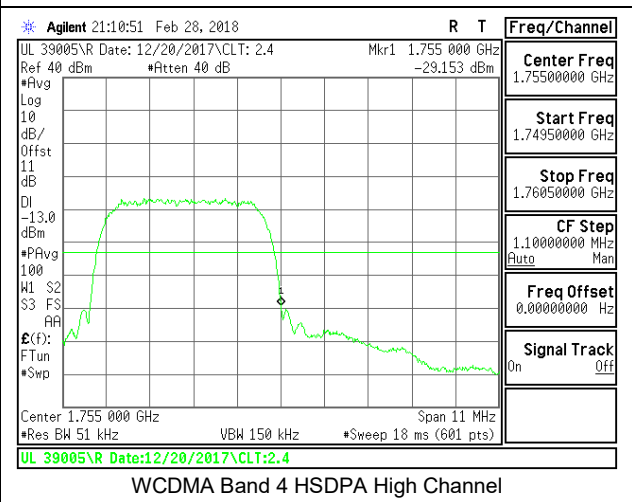
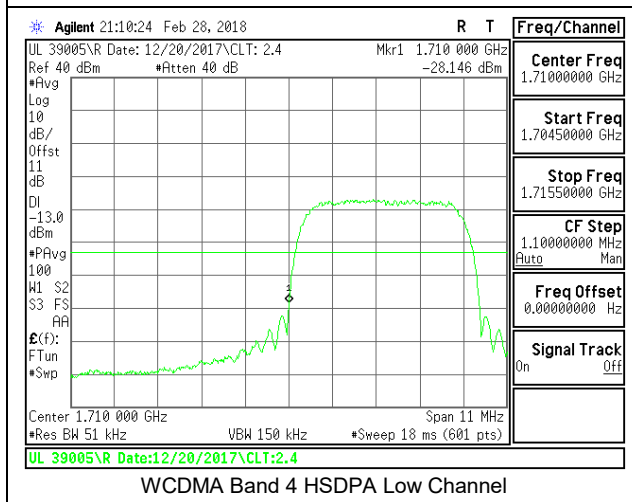
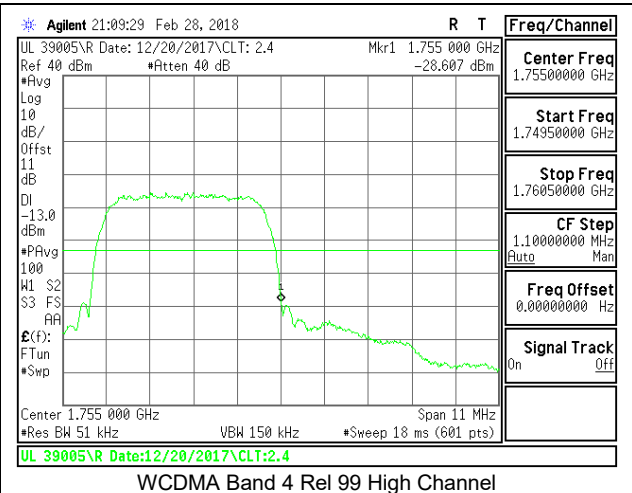
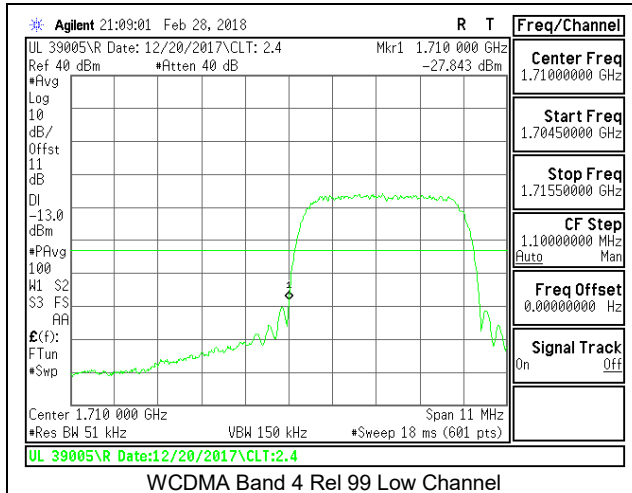

8.2.4. LTE BAND 4 BANDEDGE

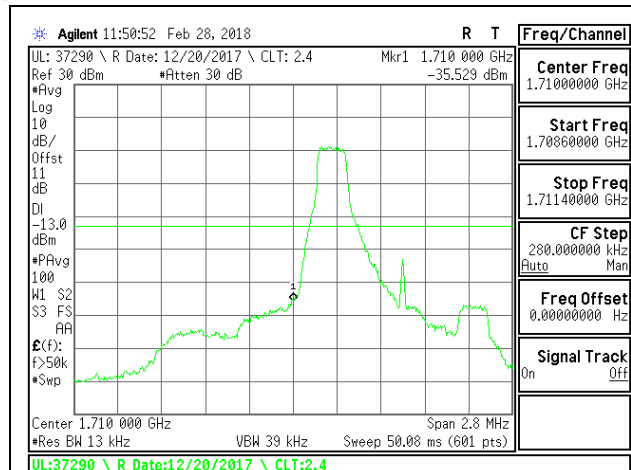

LTE B4 1.4MHz QPSK Low Channel RB1-0

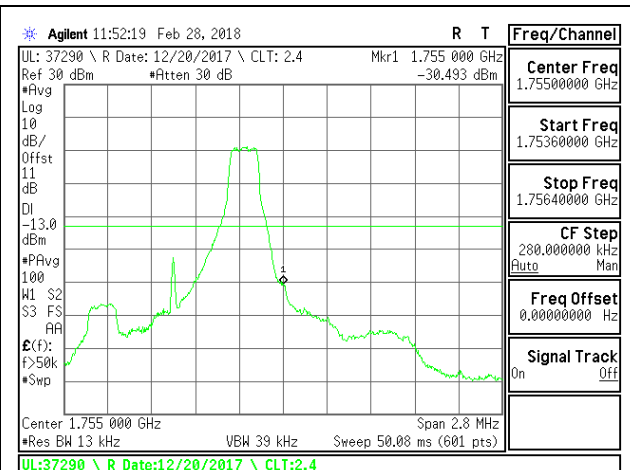

LTE B4 1.4MHz QPSK High Channel RB1-0

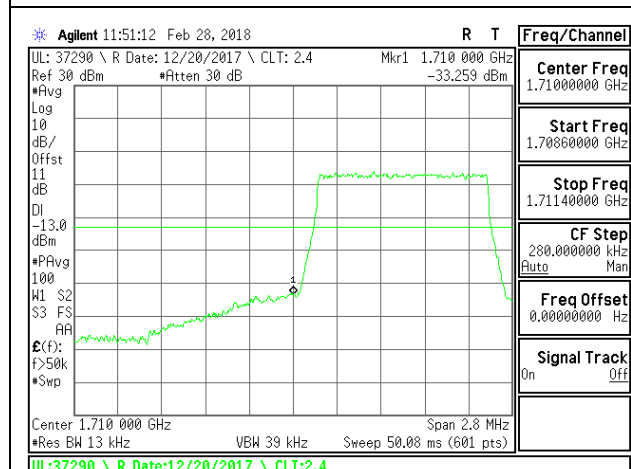

LTE B4 1.4MHz QPSK Low Channel RB6-0

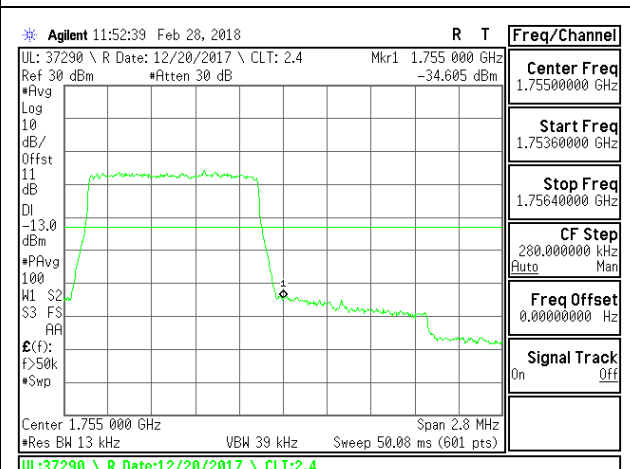

LTE B4 1.4MHz QPSK High Channel RB6-0

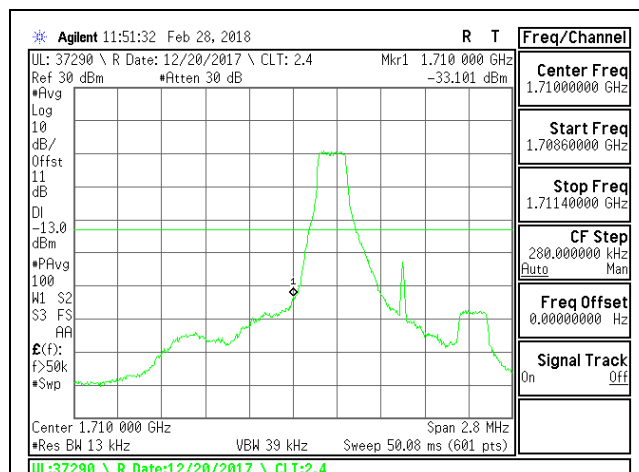

LTE B4 1.4MHz 16QAM Low Channel RB1-0

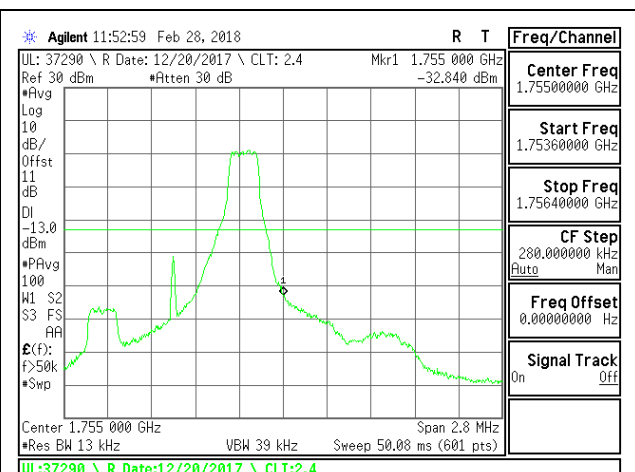

LTE B4 1.4MHz 16QAM High Channel RB1-0

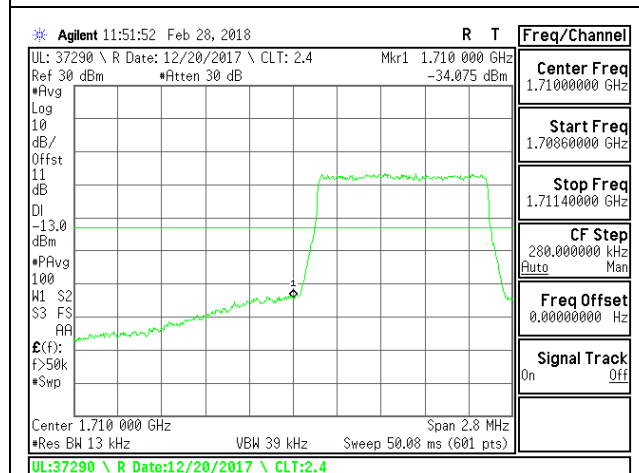

LTE B4 1.4MHz 16QAM Low Channel RB6-0

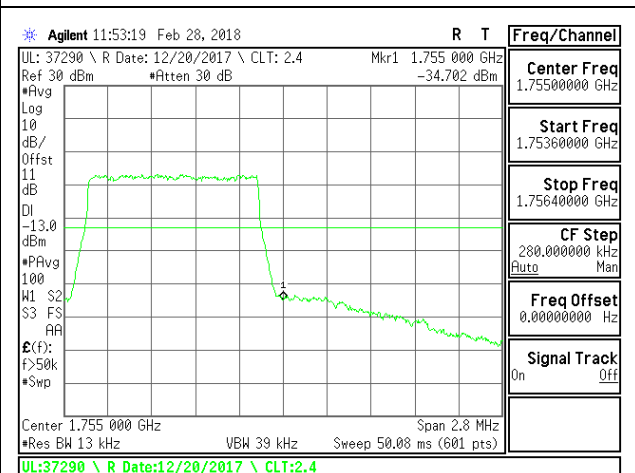

LTE B4 1.4MHz 16QAM High Channel RB6-0

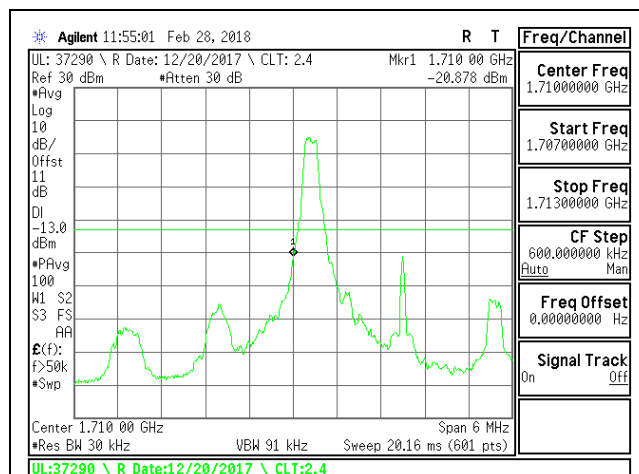

LTE B4 3MHz QPSK Low Channel RB1-0

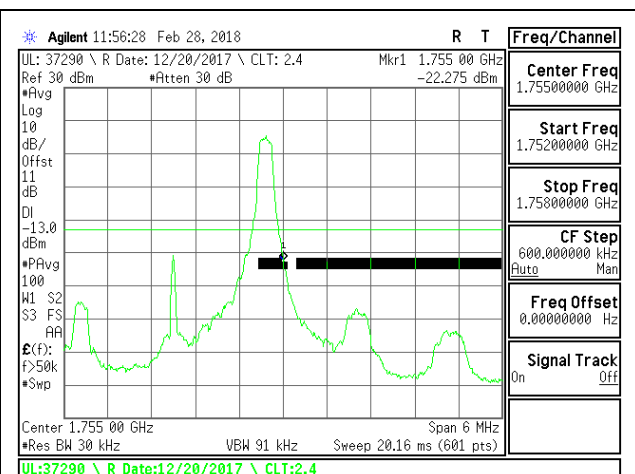

LTE B4 3MHz QPSK High Channel RB1-0

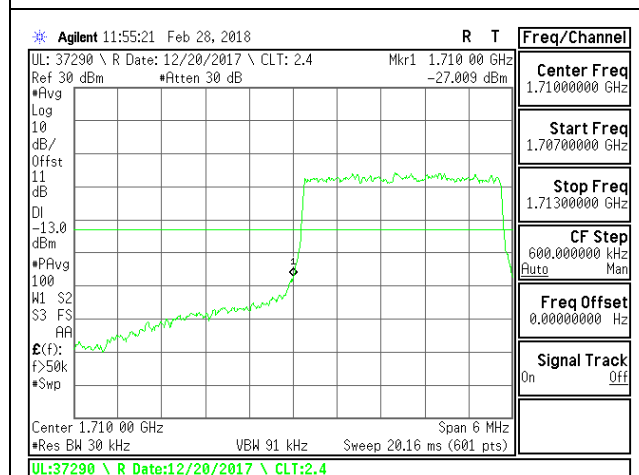

LTE B4 3MHz QPSK Low Channel RB15-0

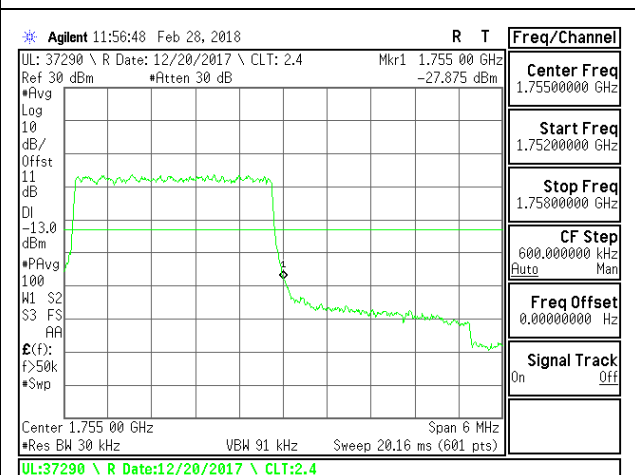

LTE B4 3MHz QPSK High Channel RB15-0



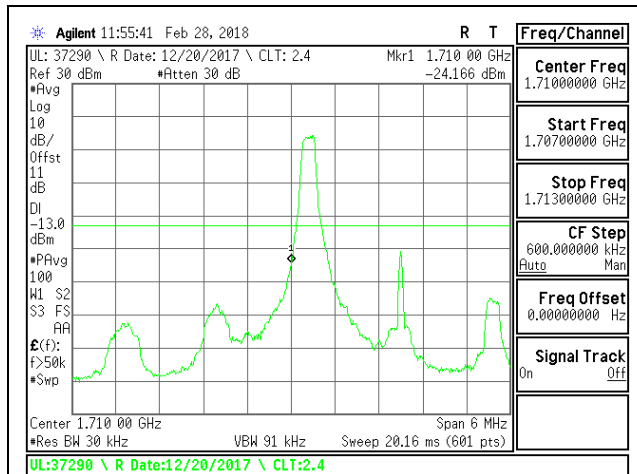

LTE B4 3MHz 16QAM Low Channel RB1-0

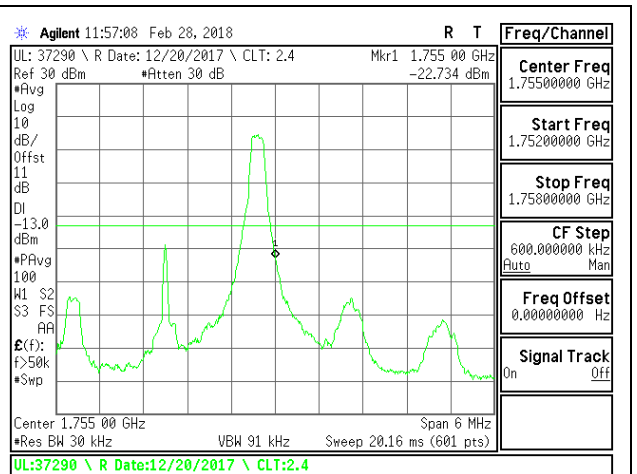

LTE B4 3MHz 16QAM High Channel RB1-0

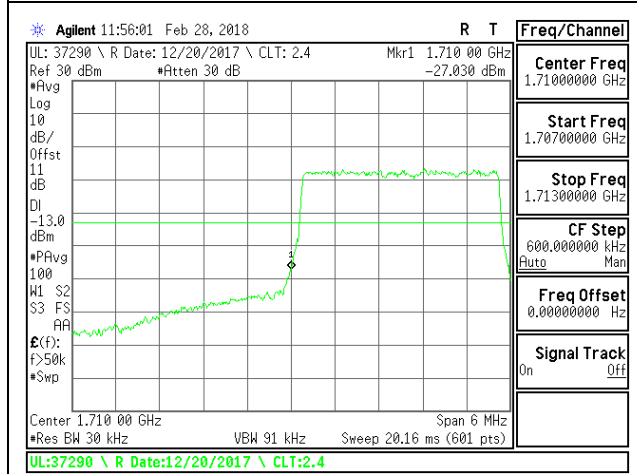

LTE B4 3MHz 16QAM Low Channel RB15-0

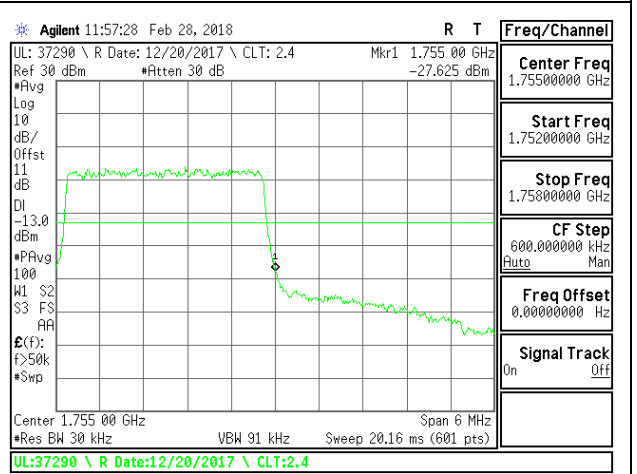

LTE B4 3MHz 16QAM High Channel RB15-0

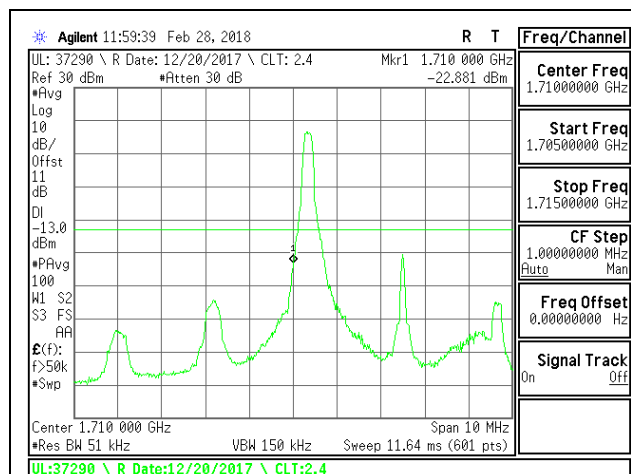

LTE B4 5MHz QPSK Low Channel RB1-0

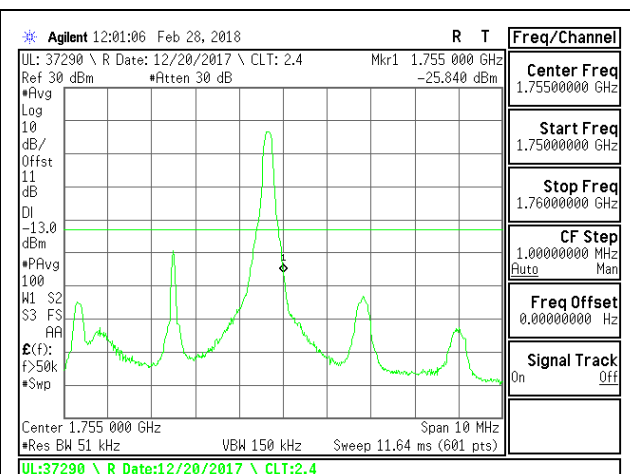

LTE B4 5MHz QPSK High Channel RB1-0

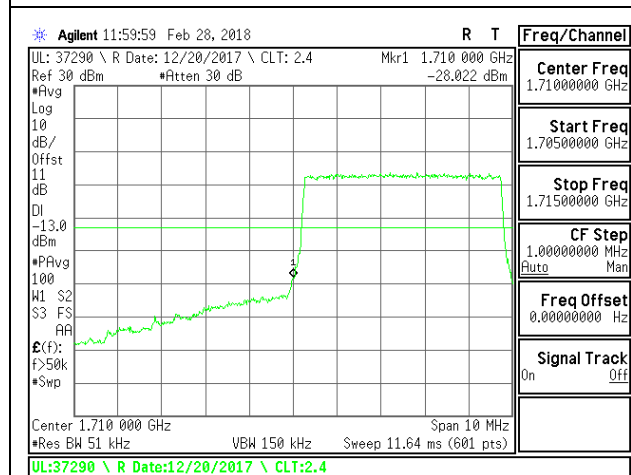

LTE B4 5MHz QPSK Low Channel RB25-0

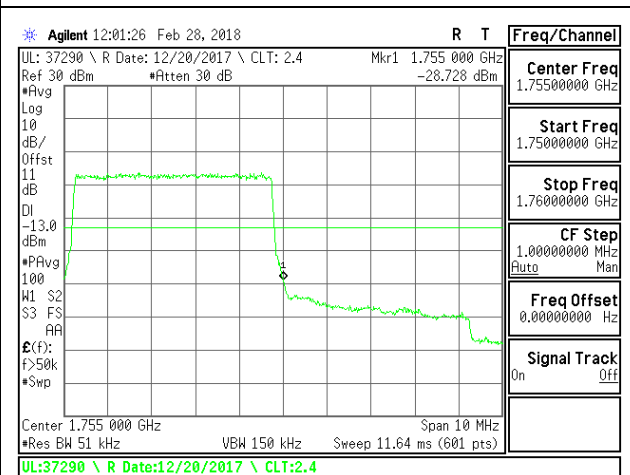

LTE B4 5MHz QPSK High Channel RB25-0

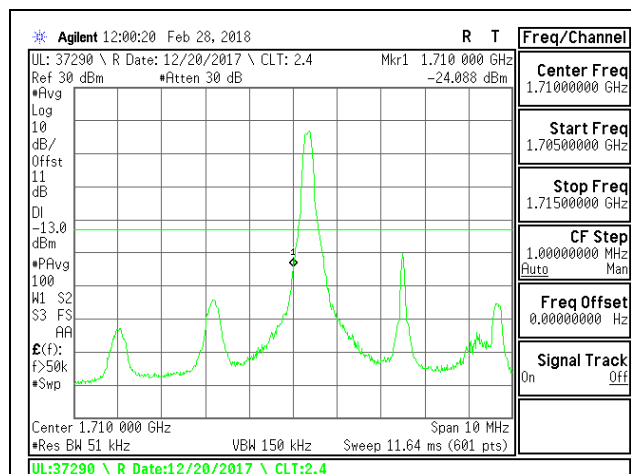

LTE B4 5MHz 16QAM Low Channel RB1-0

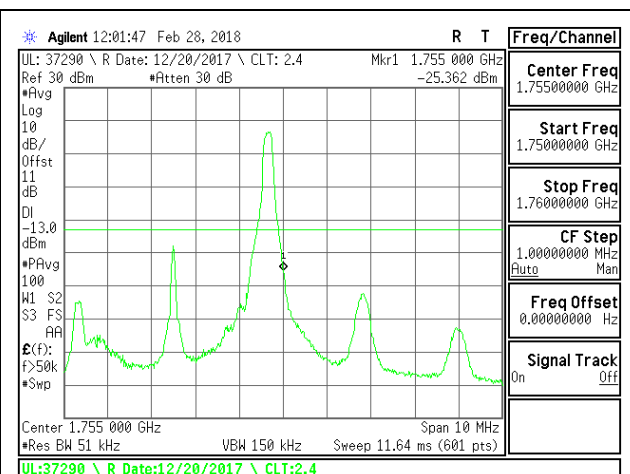

LTE B4 5MHz 16QAM High Channel RB1-0

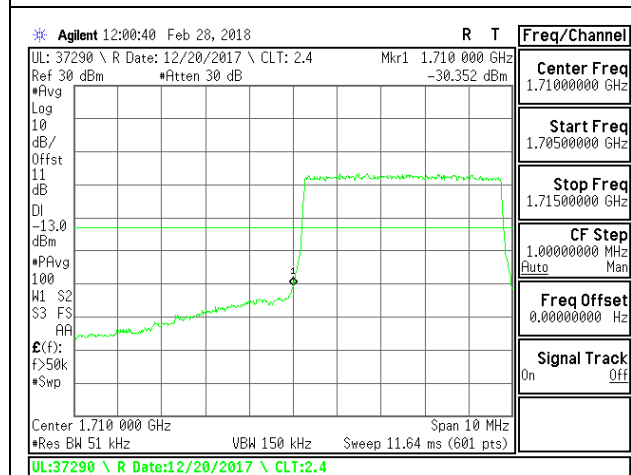

LTE B4 5MHz 16QAM Low Channel RB25-0

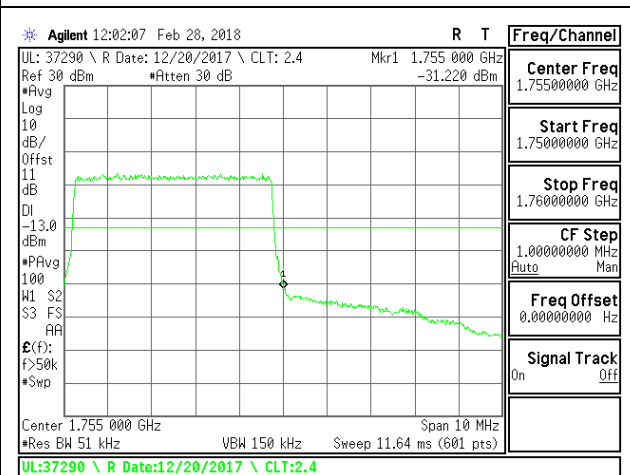

LTE B4 5MHz 16QAM High Channel RB25-0

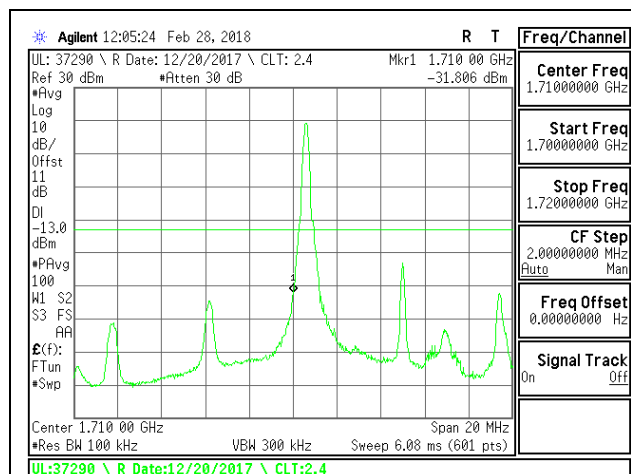

LTE B4 10MHz QPSK Low Channel RB1-0

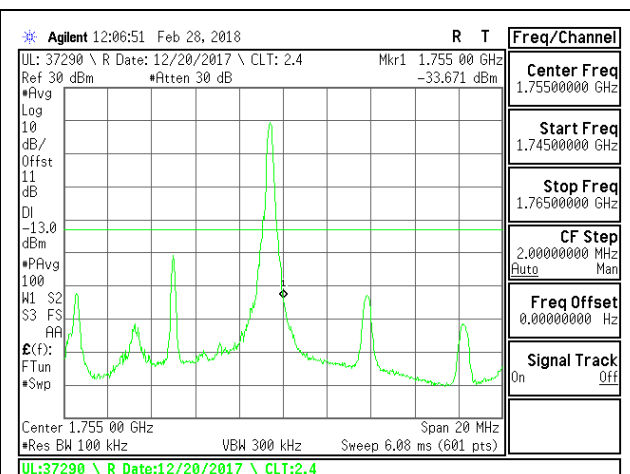

LTE B4 10MHz QPSK High Channel RB1-0

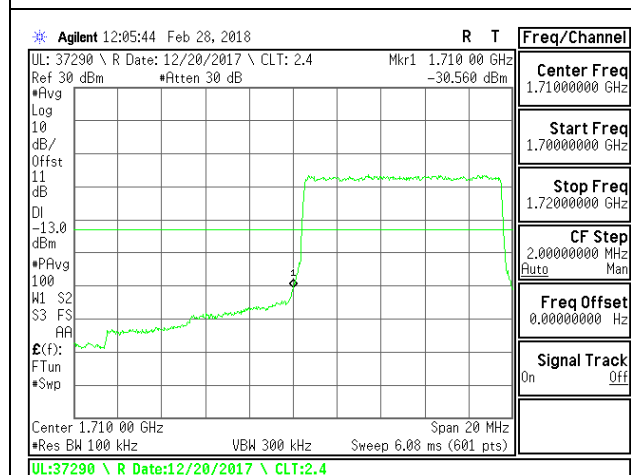

LTE B4 10MHz QPSK Low Channel RB50-0

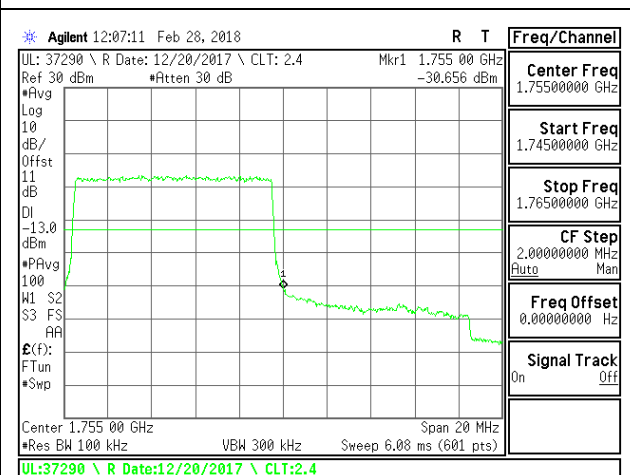

LTE B4 10MHz QPSK High Channel RB50-0

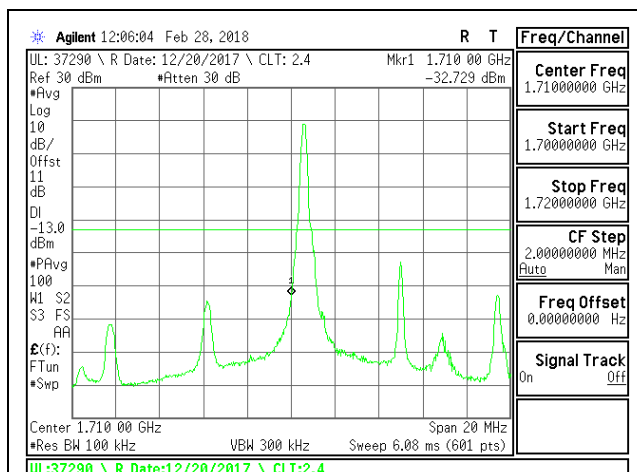

LTE B4 10MHz 16QAM Low Channel RB1-0

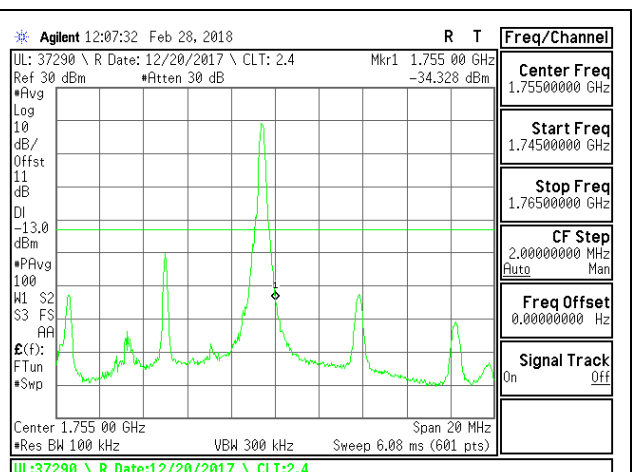

LTE B4 10MHz 16QAM High Channel RB1-0

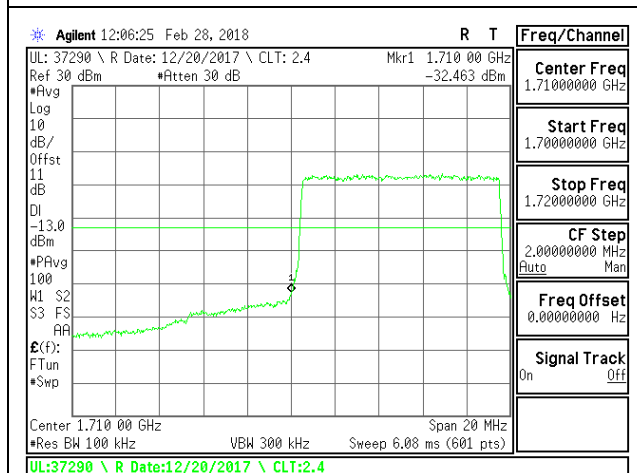

LTE B4 10MHz 16QAM Low Channel RB50-0

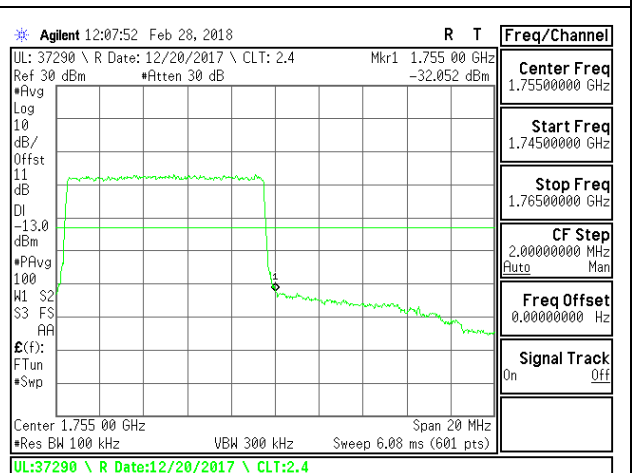

LTE B4 10MHz 16QAM High Channel RB50-0

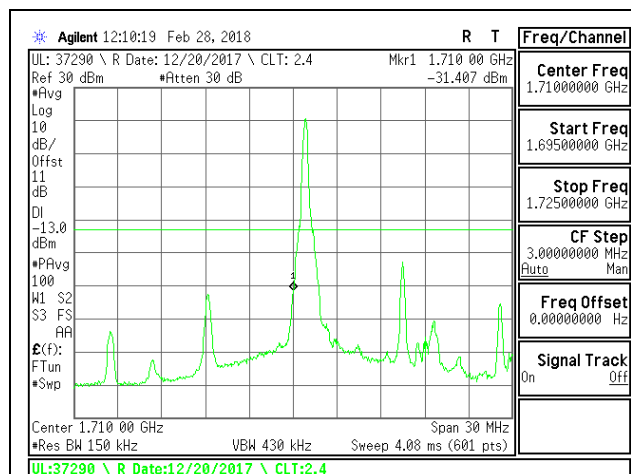

LTE B4 15MHz QPSK Low Channel RB1-0

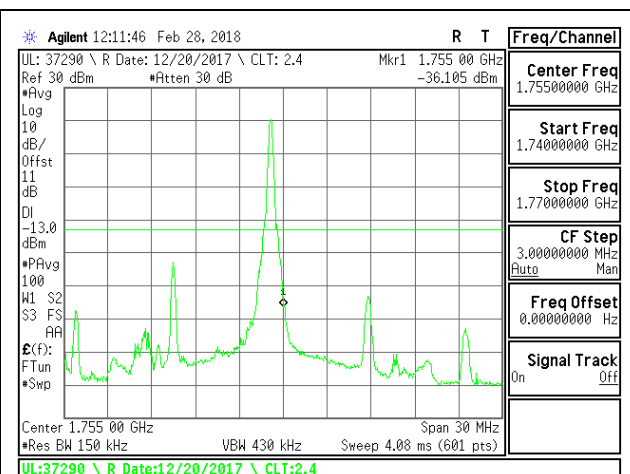

LTE B4 15MHz QPSK High Channel RB1-0

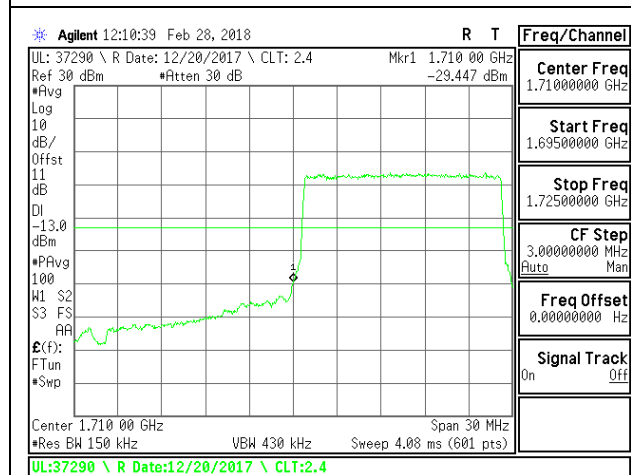

LTE B4 15MHz QPSK Low Channel RB75-0

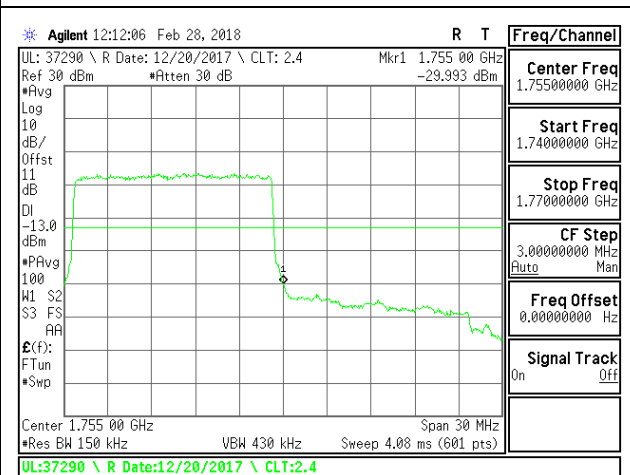

LTE B4 15MHz QPSK High Channel RB75-0

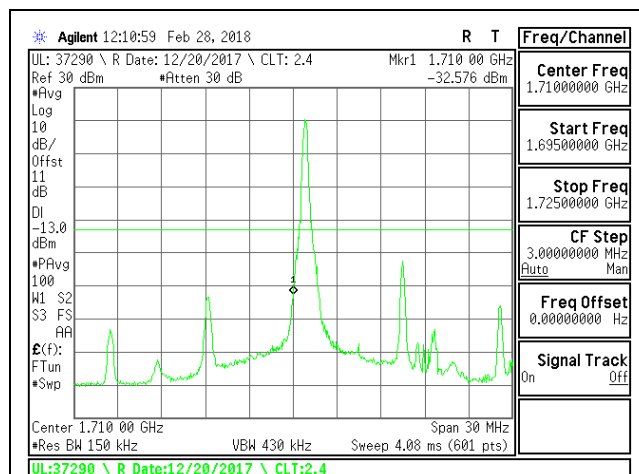

LTE B4 15MHz 16QAM Low Channel RB1-0

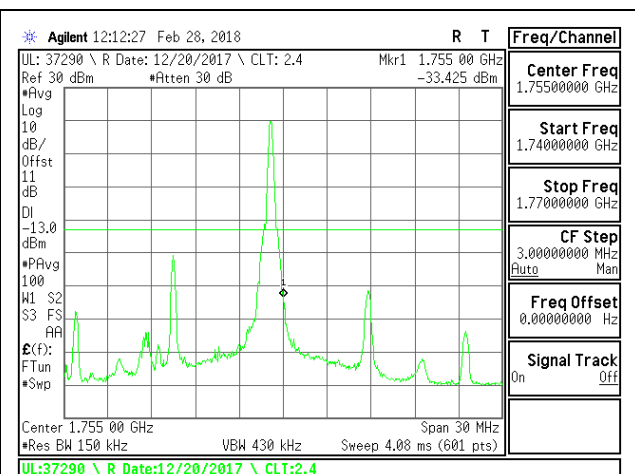

LTE B4 15MHz 16QAM High Channel RB1-0

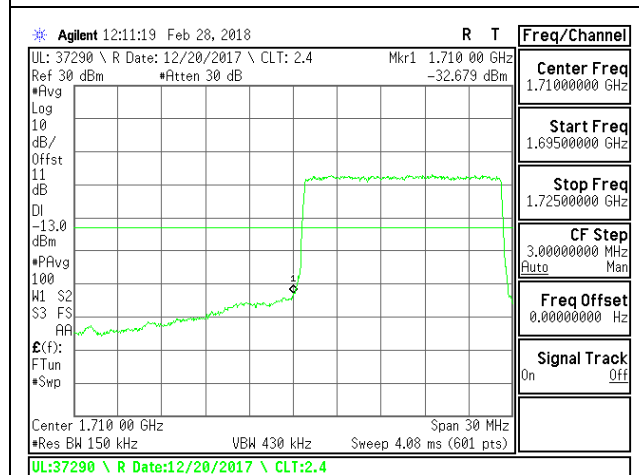

LTE B4 15MHz 16QAM Low Channel RB75-0

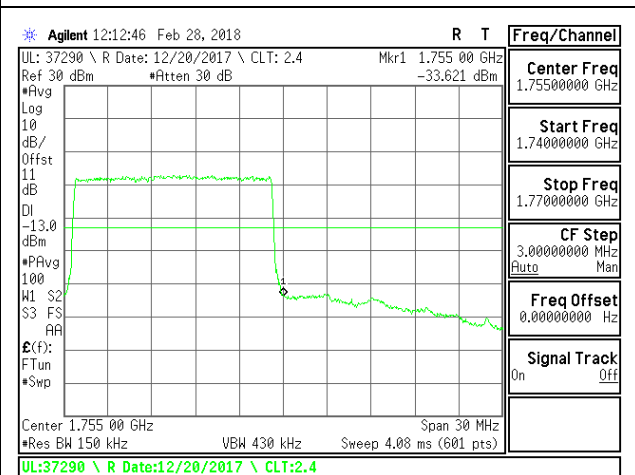

LTE B4 15MHz 16QAM High Channel RB75-0

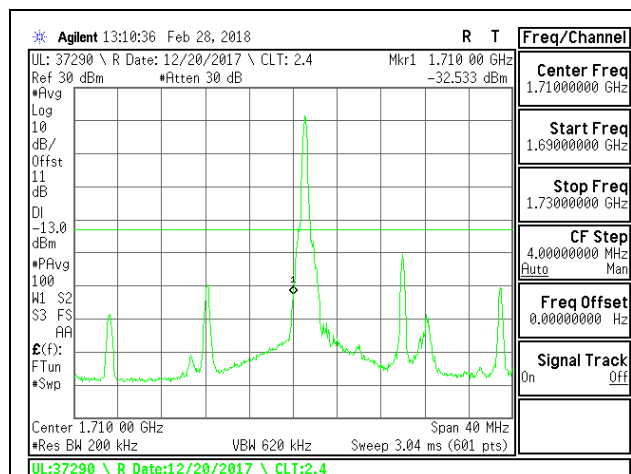

LTE B4 20MHz QPSK Low Channel RB1-0

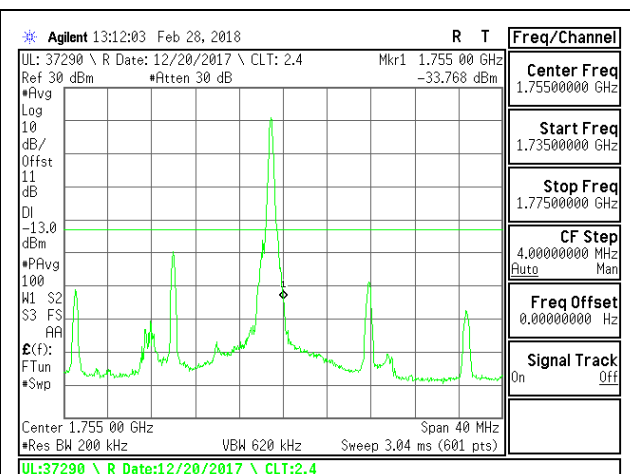

LTE B4 20MHz QPSK High Channel RB1-0

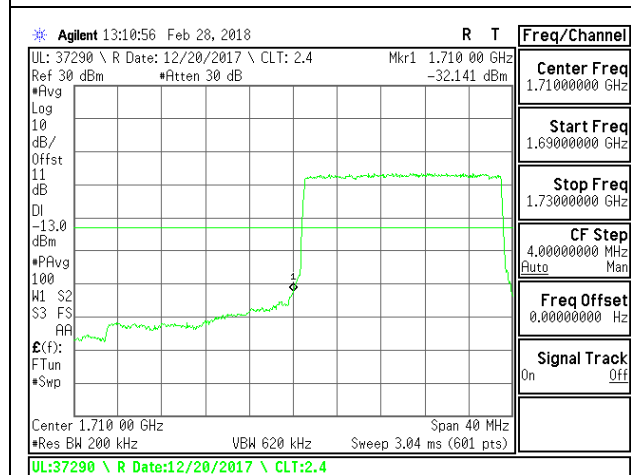

LTE B4 20MHz QPSK Low Channel RB100-0

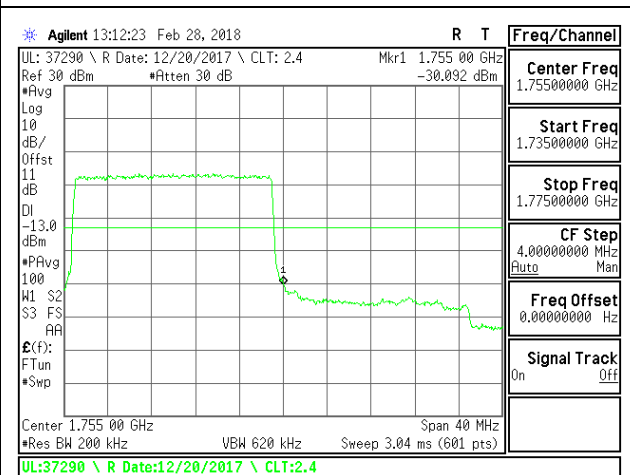

LTE B4 20MHz QPSK High Channel RB100-0



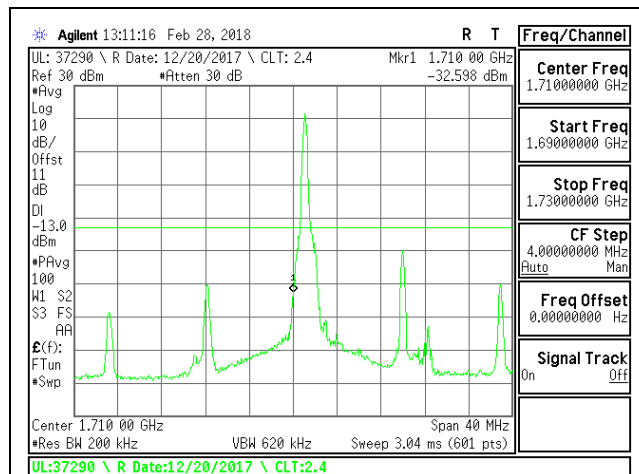

LTE B4 20MHz 16QAM Low Channel RB1-0

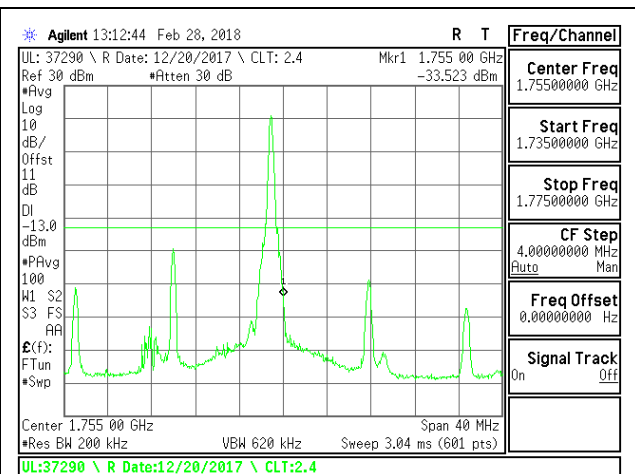

LTE B4 20MHz 16QAM High Channel RB1-0

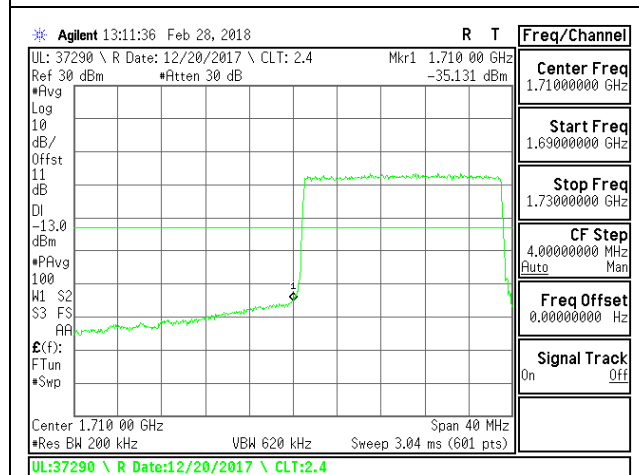

LTE B4 20MHz 16QAM Low Channel RB100-0

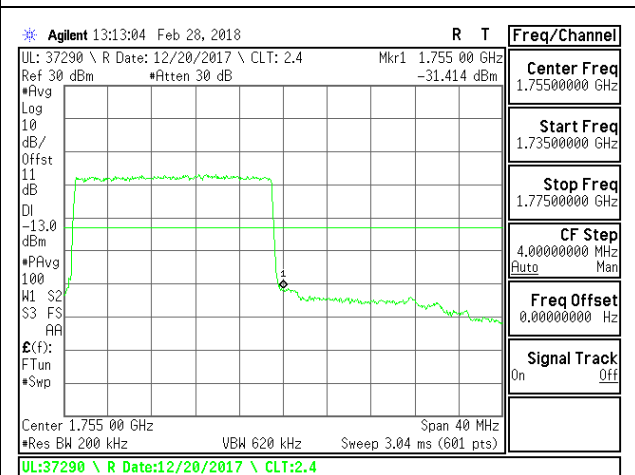

LTE B4 20MHz 16QAM High Channel RB100-0

8.2.5. LTE BAND 5 BANDEDGE

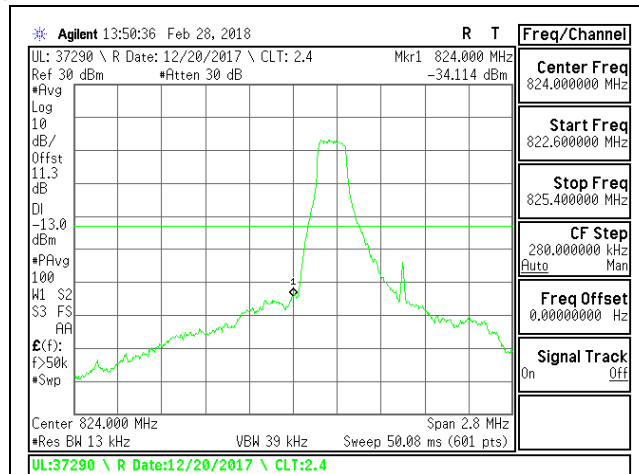

LTE B5 1.4MHz QPSK Low Channel RB1-0

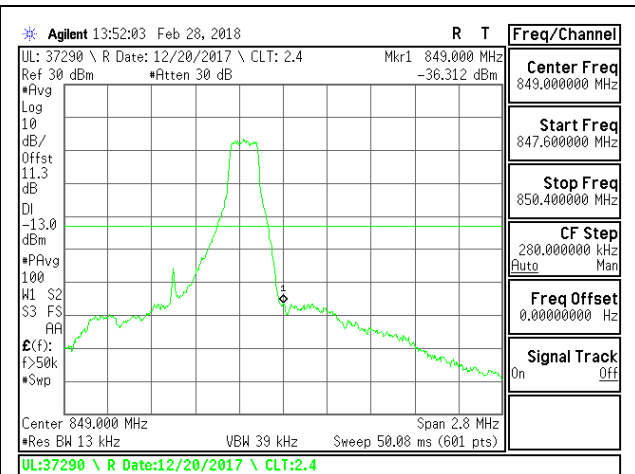

LTE B5 1.4MHz QPSK High Channel RB1-0

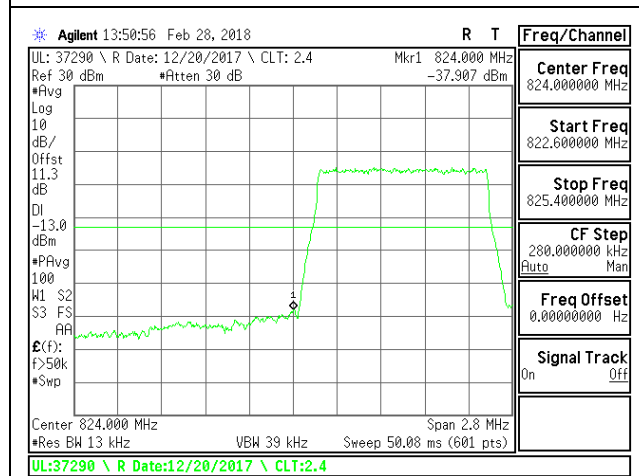

LTE B5 1.4MHz QPSK Low Channel RB6-0

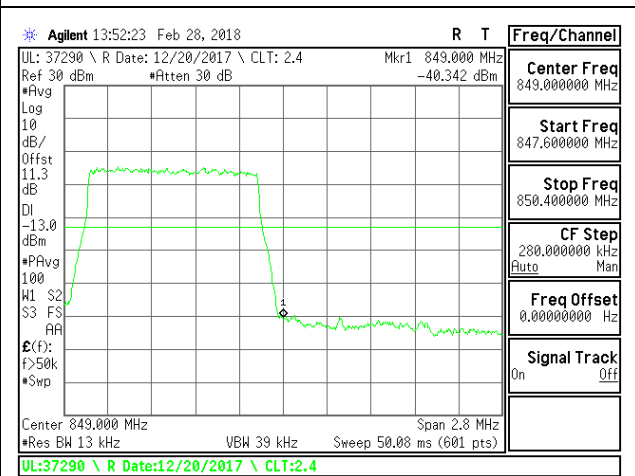

LTE B5 1.4MHz QPSK High Channel RB6-0

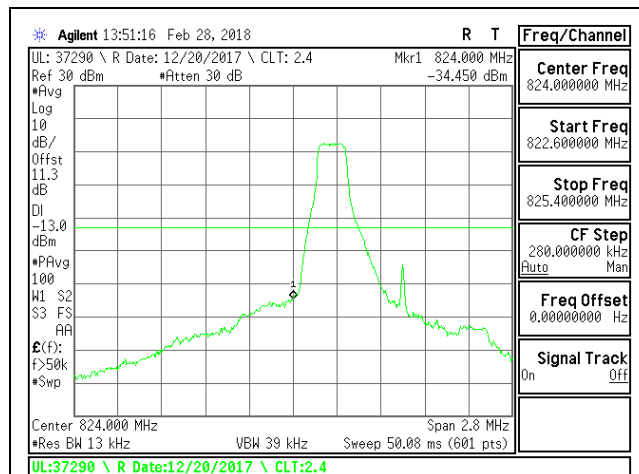

LTE B5 1.4MHz 16QAM Low Channel RB1-0

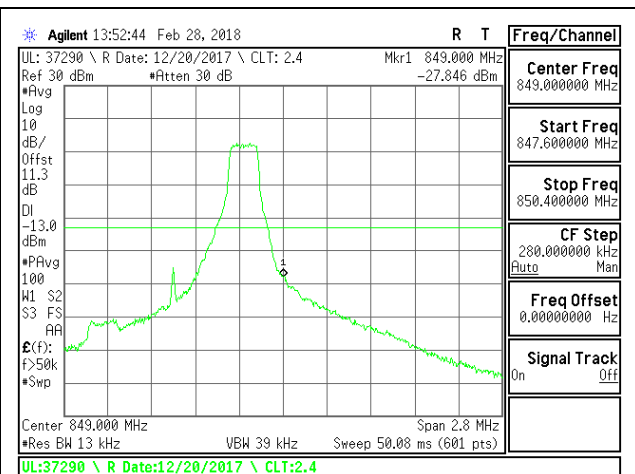

LTE B5 1.4MHz 16QAM High Channel RB1-0

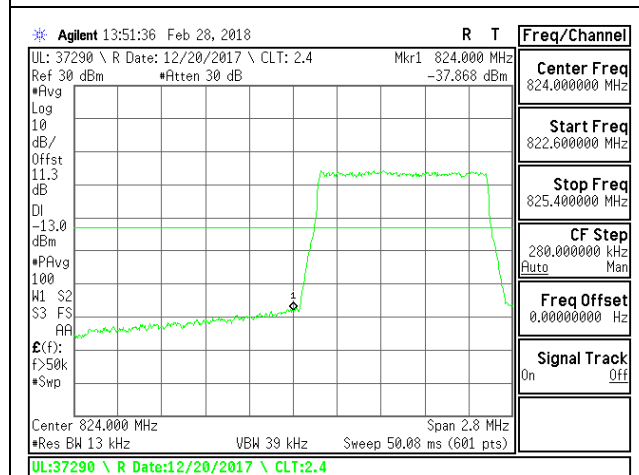

LTE B5 1.4MHz 16QAM Low Channel RB6-0

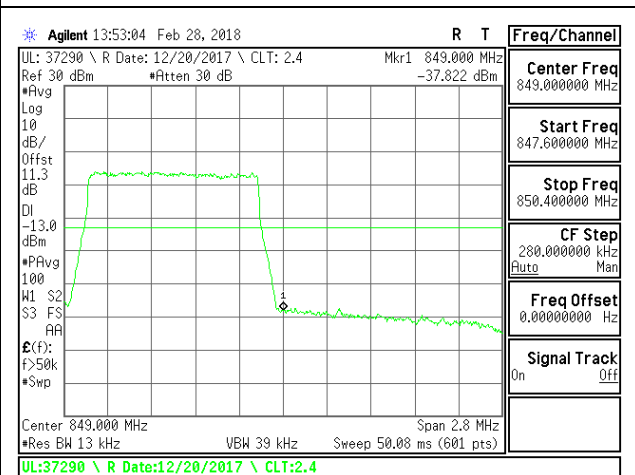

LTE B5 1.4MHz 16QAM High Channel RB6-0

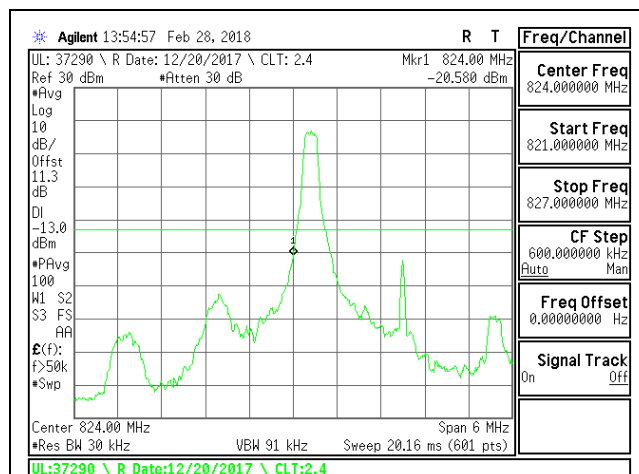

LTE B5 3MHz QPSK Low Channel RB1-0

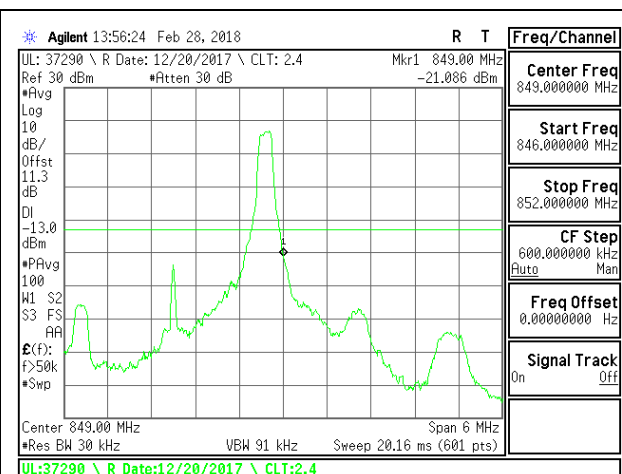

LTE B5 3MHz QPSK High Channel RB1-0

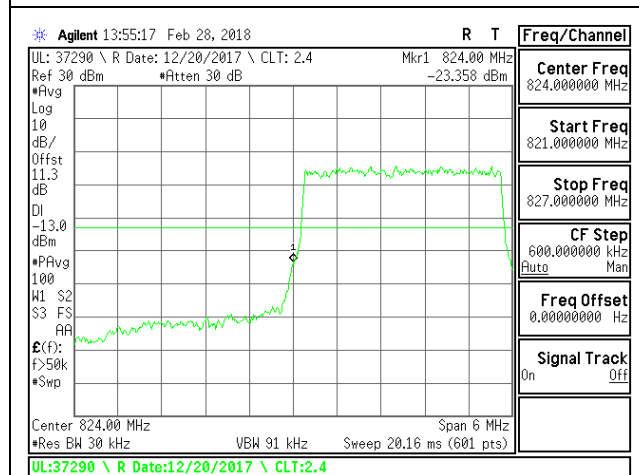

LTE B5 3MHz QPSK Low Channel RB15-0

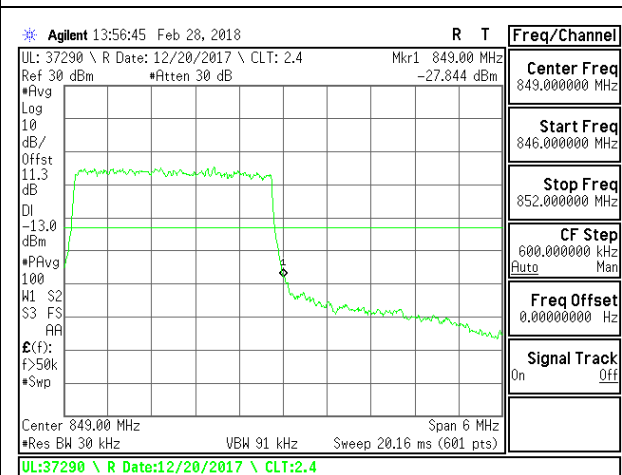

LTE B5 3MHz QPSK High Channel RB15-0

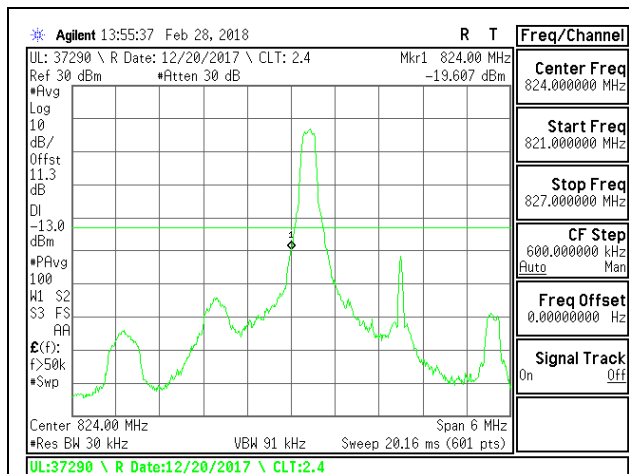

LTE B5 3MHz 16QAM Low Channel RB1-0

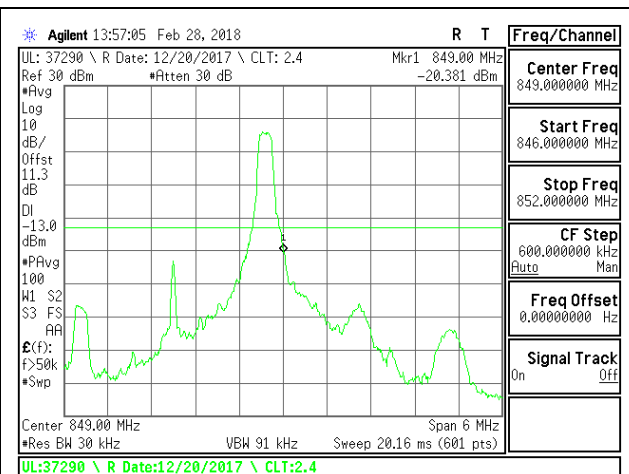

LTE B5 3MHz 16QAM High Channel RB1-0

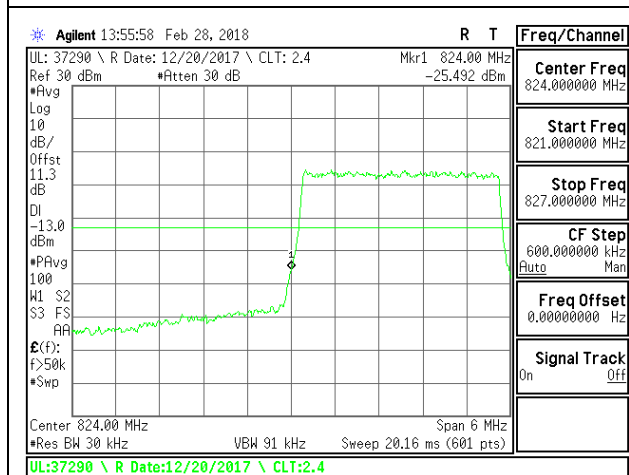

LTE B5 3MHz 16QAM Low Channel RB15-0

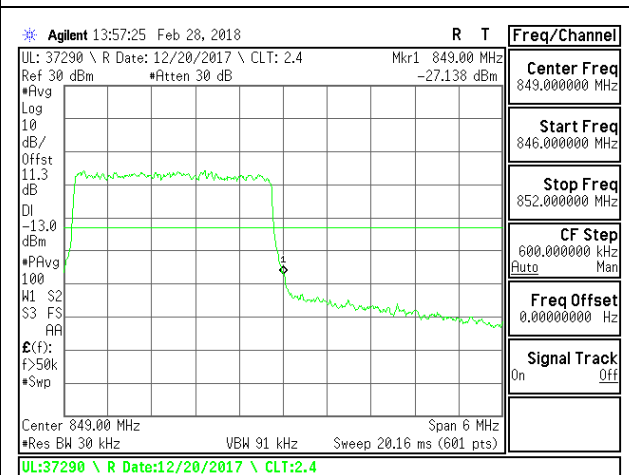

LTE B5 3MHz 16QAM High Channel RB15-0

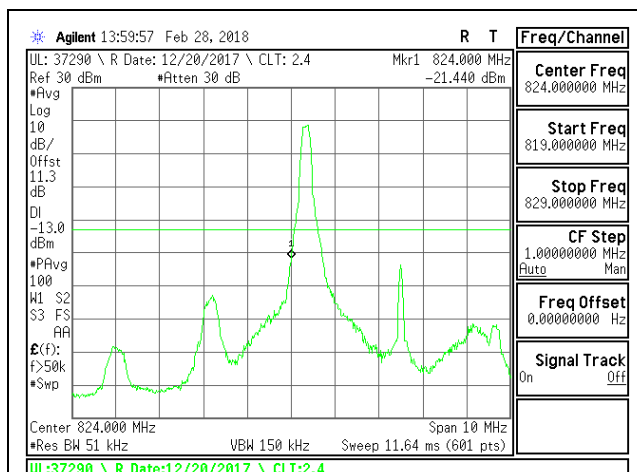

LTE B5 5MHz QPSK Low Channel RB1-0

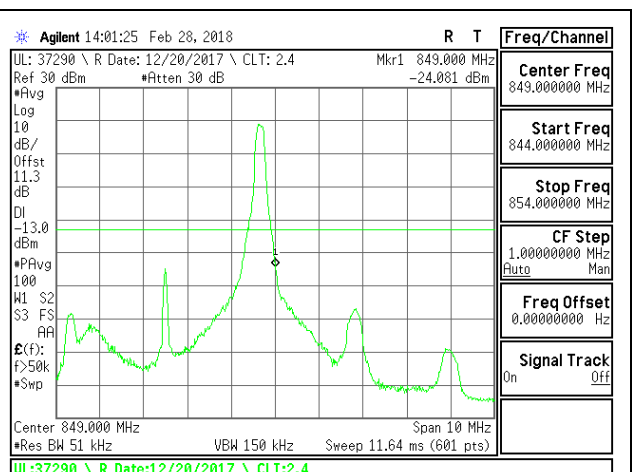

LTE B5 5MHz QPSK High Channel RB1-0

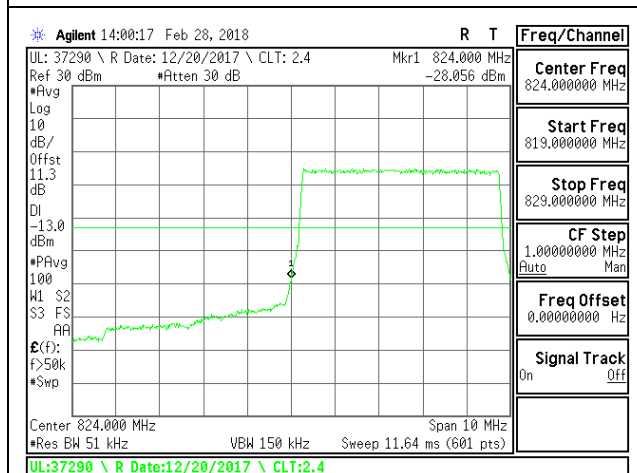

LTE B5 5MHz QPSK Low Channel RB25-0

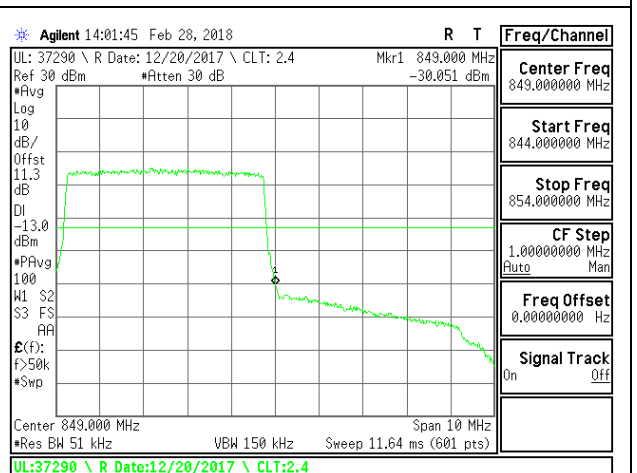

LTE B5 5MHz QPSK High Channel RB25-0

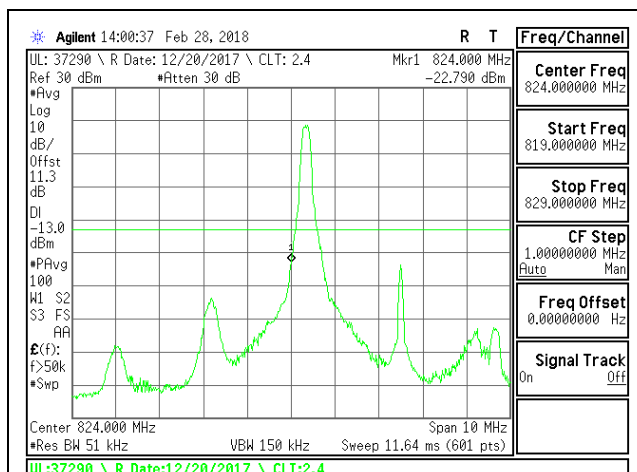

LTE B5 5MHz 16QAM Low Channel RB1-0

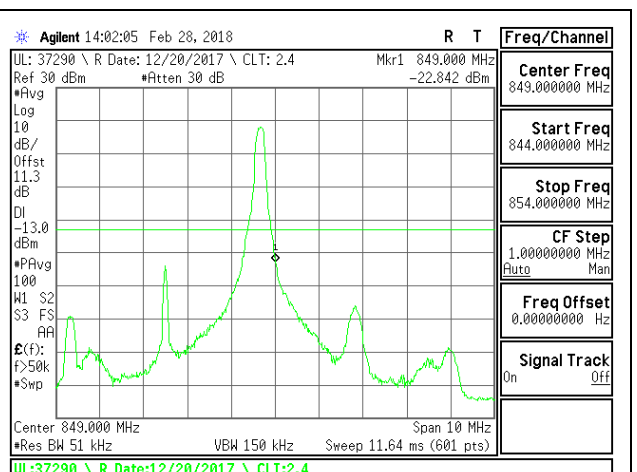

LTE B5 5MHz 16QAM High Channel RB1-0

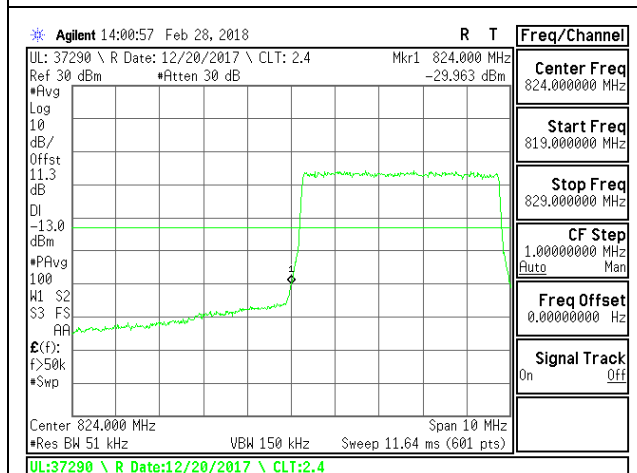

LTE B5 5MHz 16QAM Low Channel RB25-0

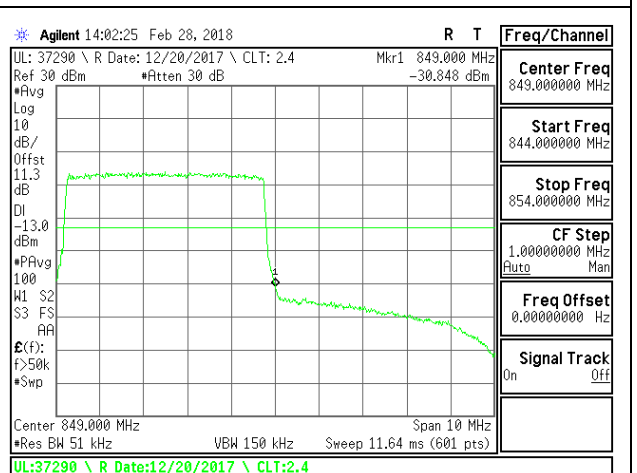

LTE B5 5MHz 16QAM High Channel RB25-0

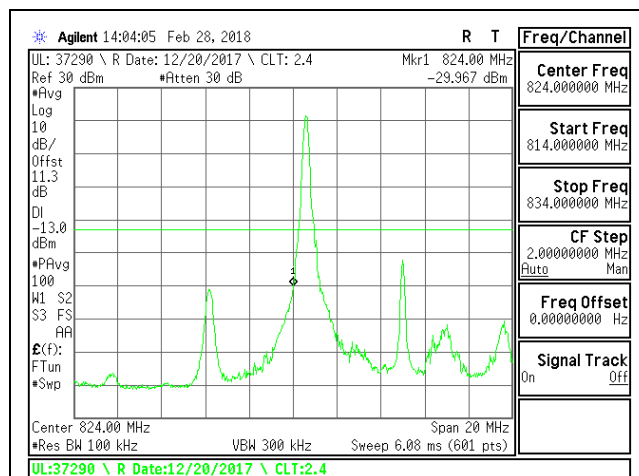

LTE B5 10MHz QPSK Low Channel RB1-0

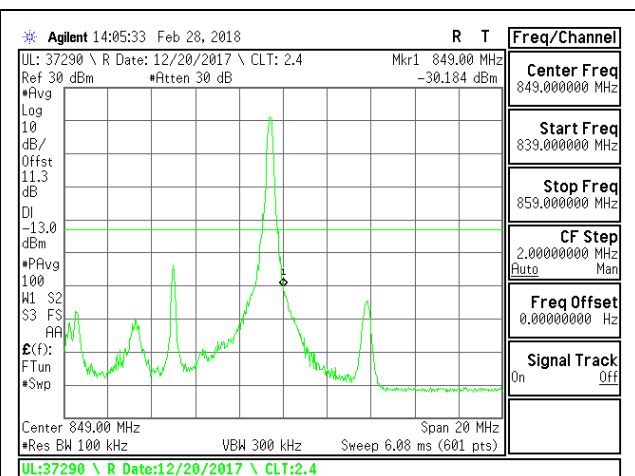

LTE B5 10MHz QPSK High Channel RB1-0

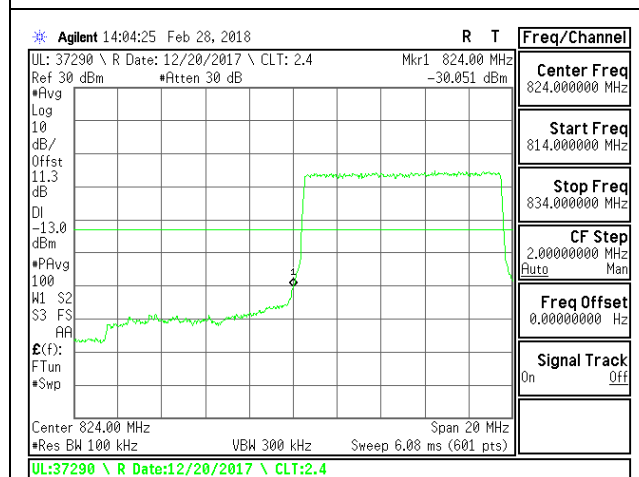

LTE B5 10MHz QPSK Low Channel RB50-0

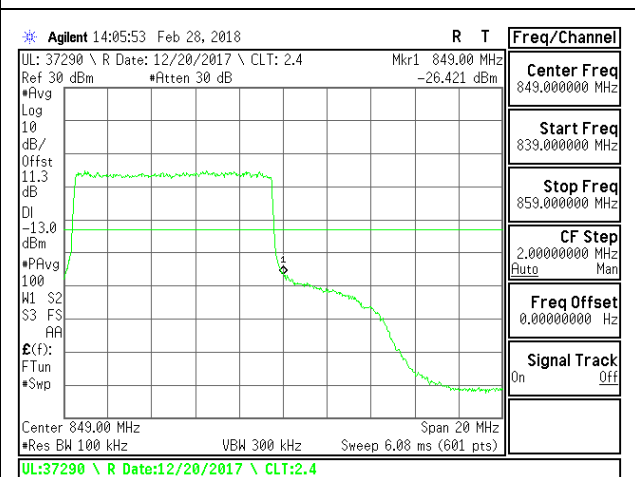

LTE B5 10MHz QPSK High Channel RB50-0



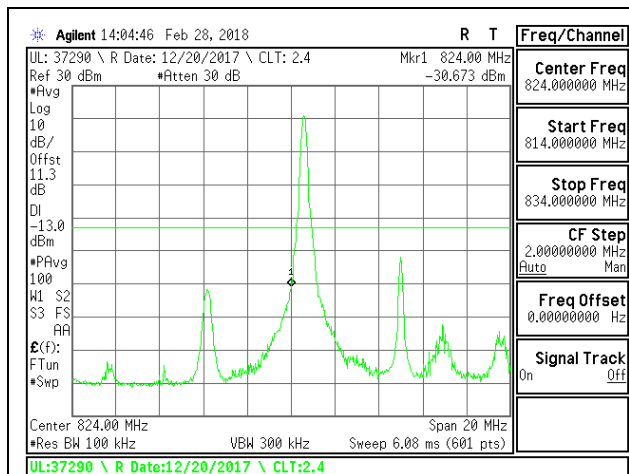

LTE B5 10MHz 16QAM Low Channel RB1-0

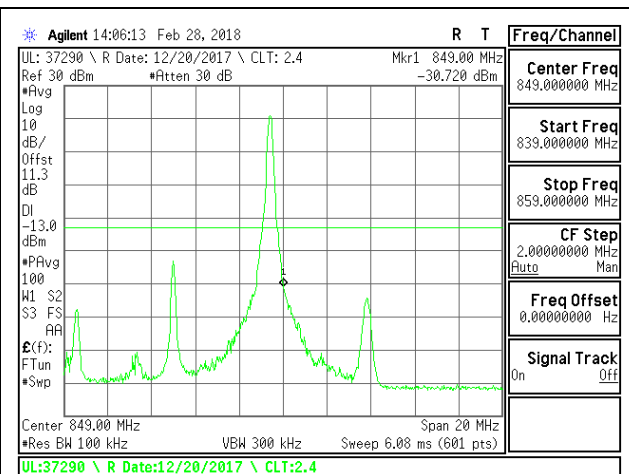

LTE B5 10MHz 16QAM High Channel RB1-0

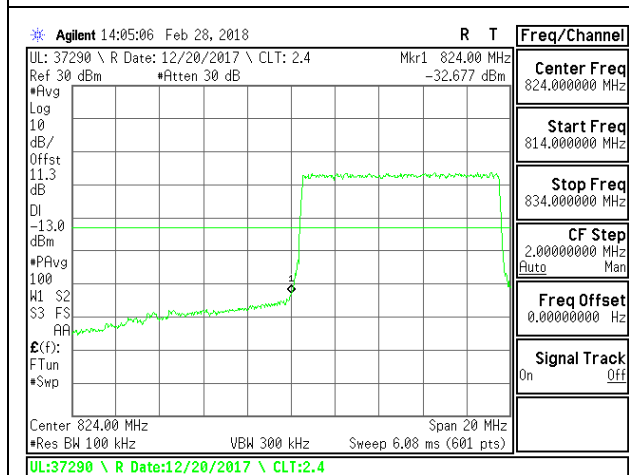

LTE B5 10MHz 16QAM Low Channel RB50-0

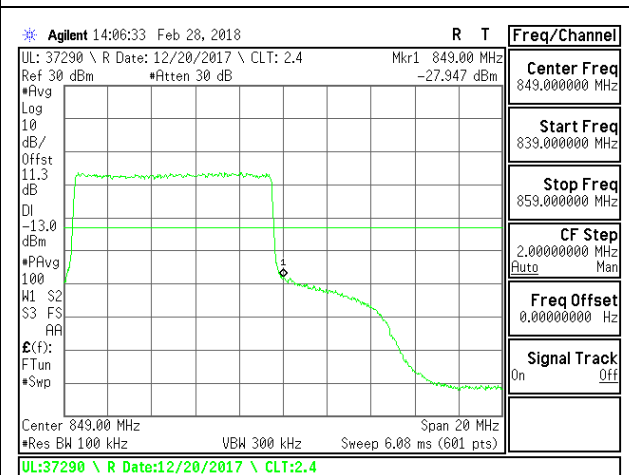

LTE B5 10MHz 16QAM High Channel RB50-0

8.2.6. LTE BAND 7 ADJACENT CHANNEL POWER

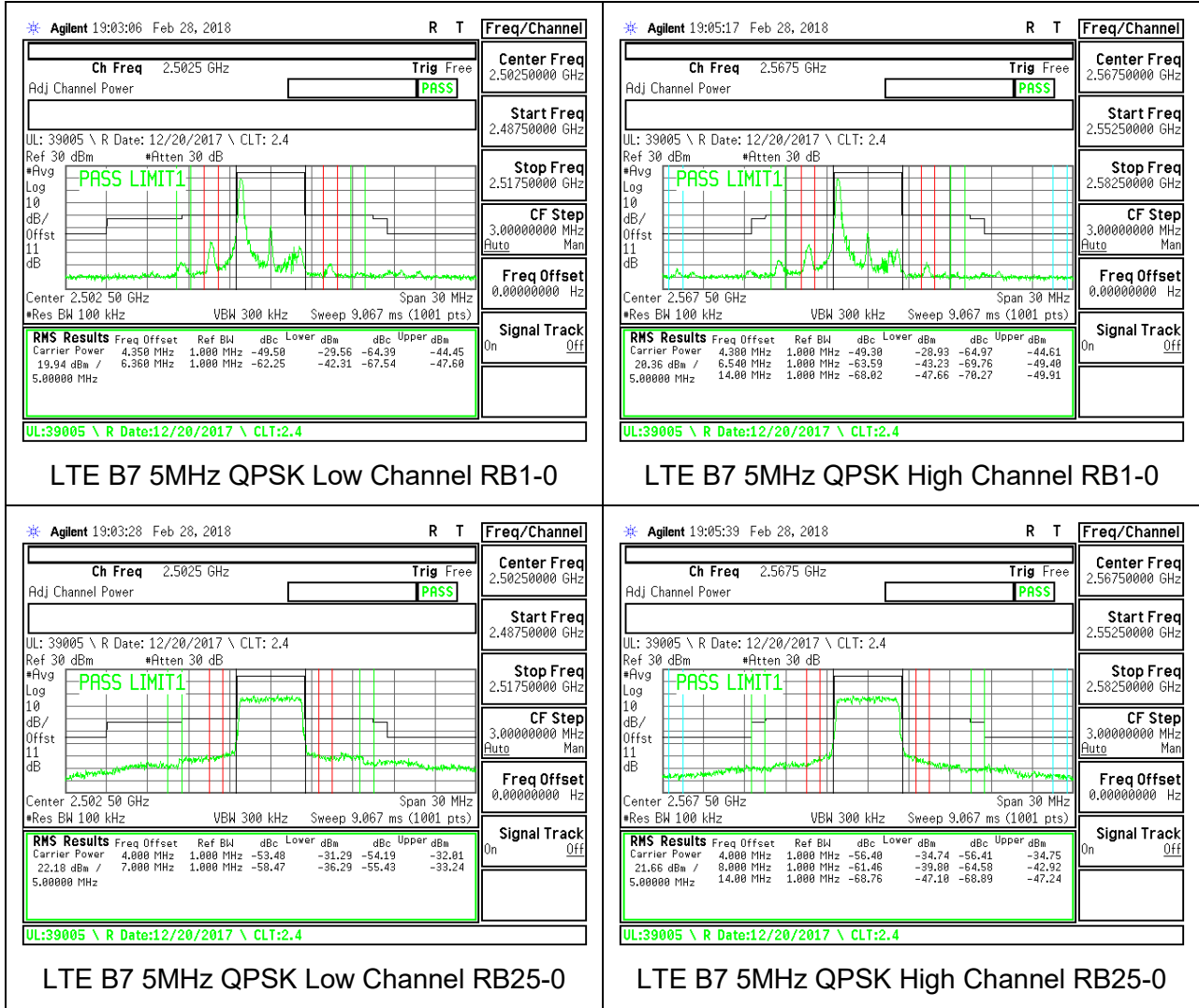

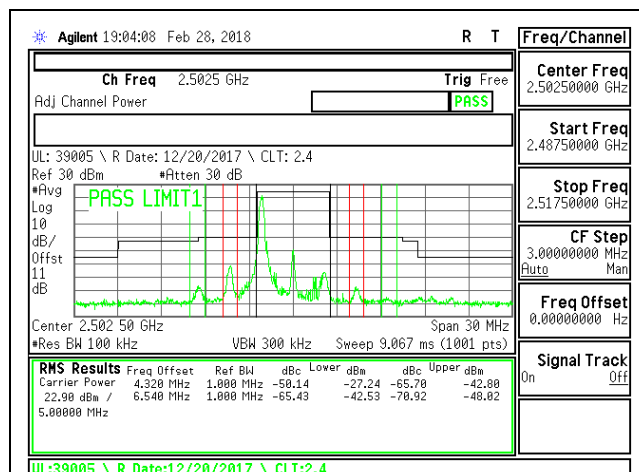

LTE B7 5MHz 16QAM Low Channel RB1-0

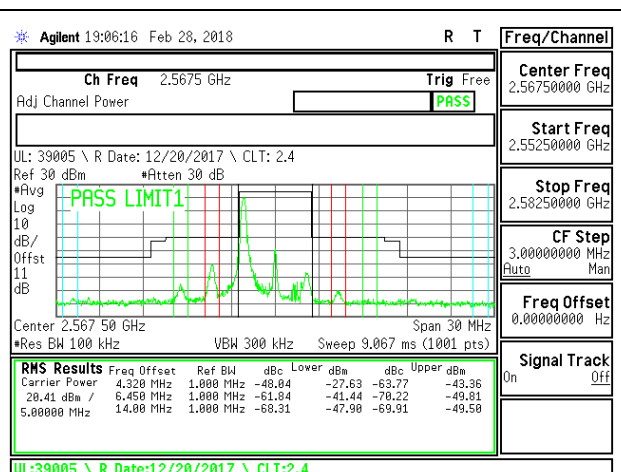

LTE B7 5MHz 16QAM High Channel RB1-0

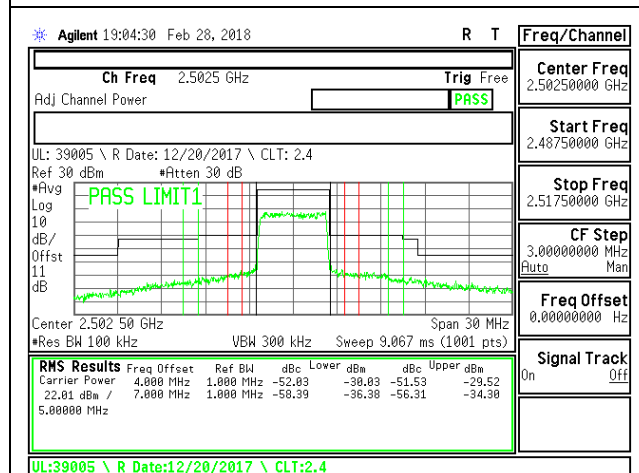

LTE B7 5MHz 16QAM Low Channel RB25-0

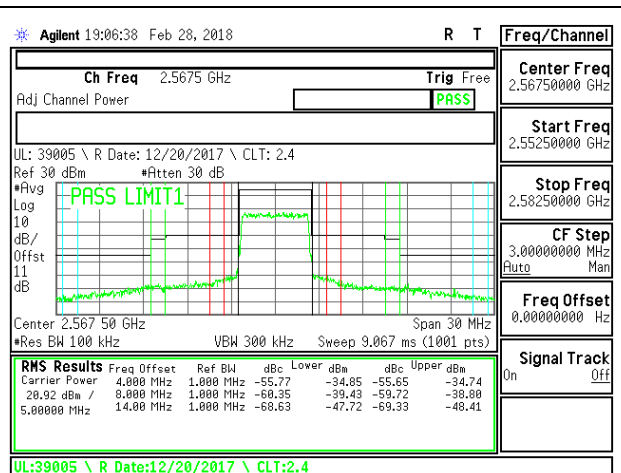

LTE B7 5MHz 16QAM High Channel RB25-0

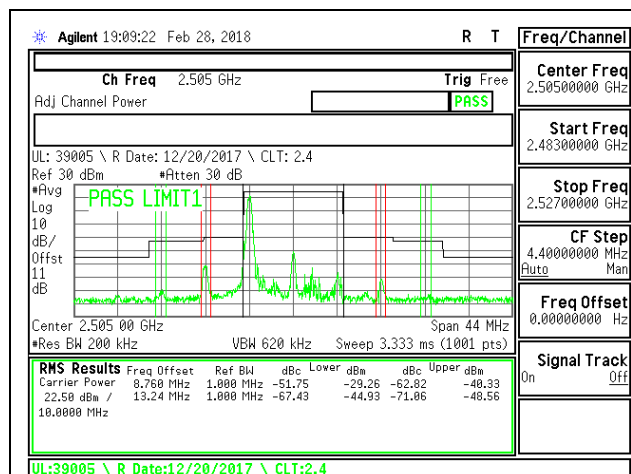

LTE B7 10MHz QPSK Low Channel RB1-0

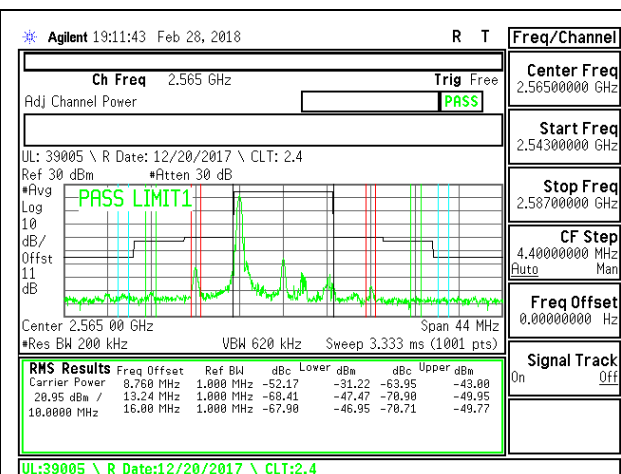

LTE B7 10MHz QPSK High Channel RB1-0

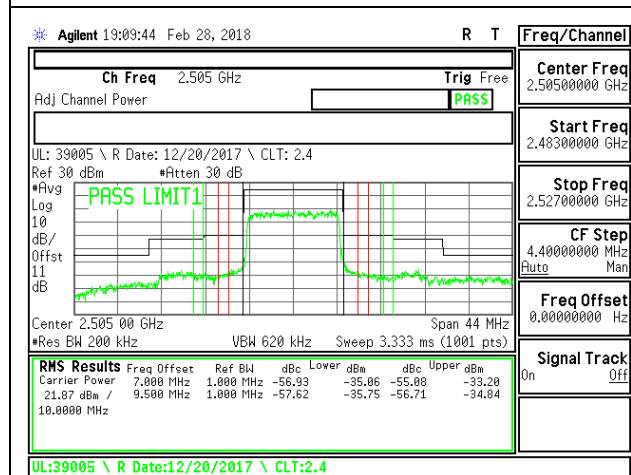

LTE B7 10MHz QPSK Low Channel RB50-0

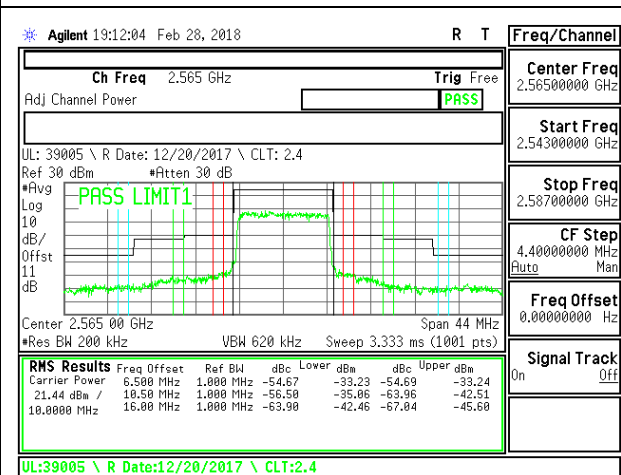

LTE B7 10MHz QPSK High Channel RB50-0

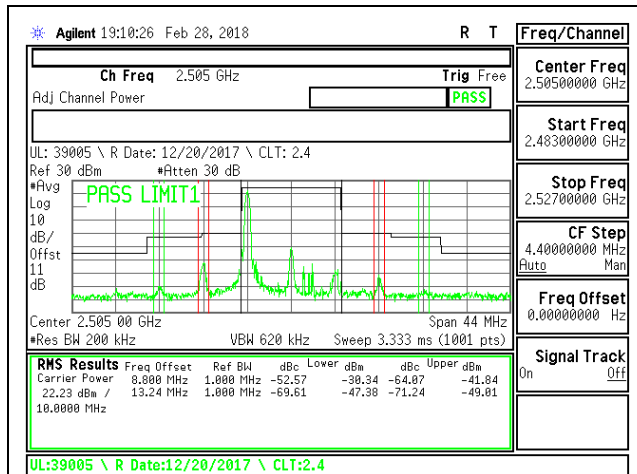

LTE B7 10MHz 16QAM Low Channel RB1-0

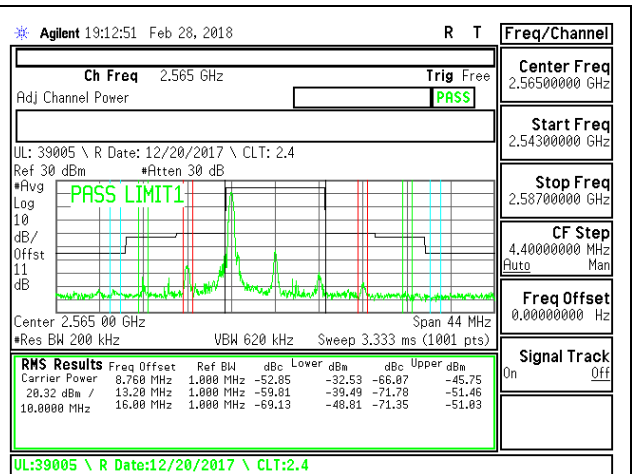

LTE B7 10MHz 16QAM High Channel RB1-0

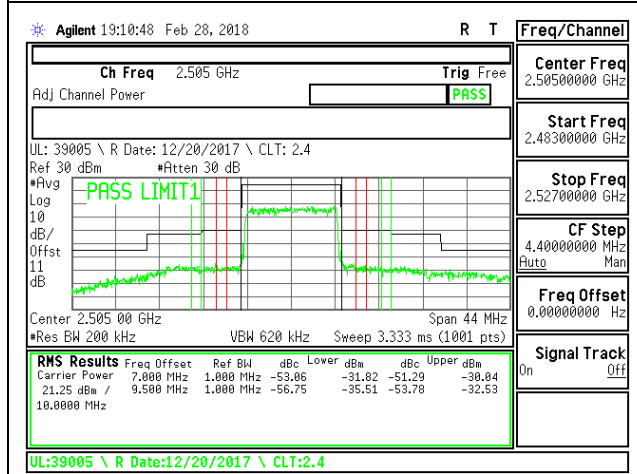

LTE B7 10MHz 16QAM Low Channel RB50-0

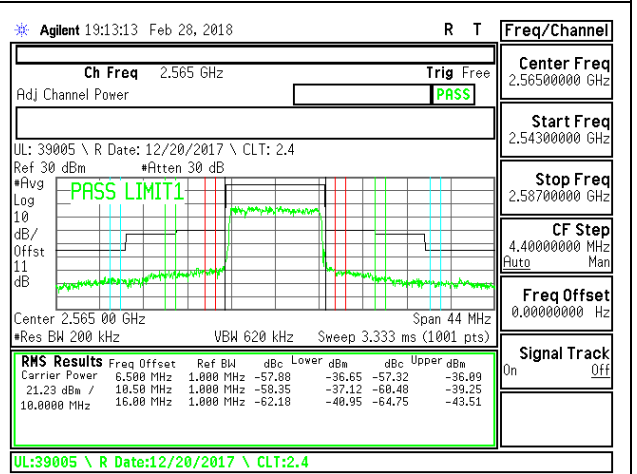

LTE B7 10MHz 16QAM High Channel RB50-0

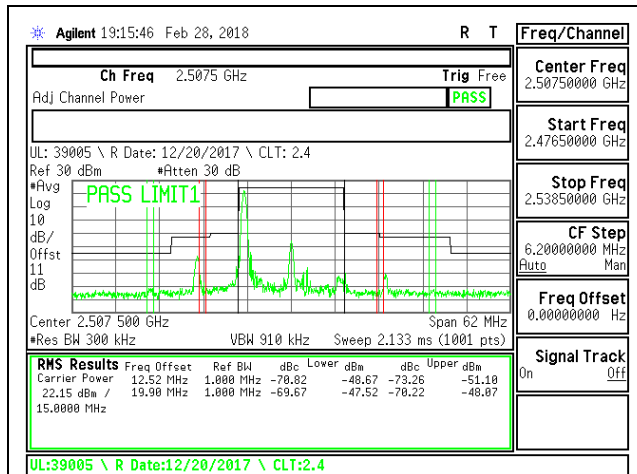

LTE B7 15MHz QPSK Low Channel RB1-0

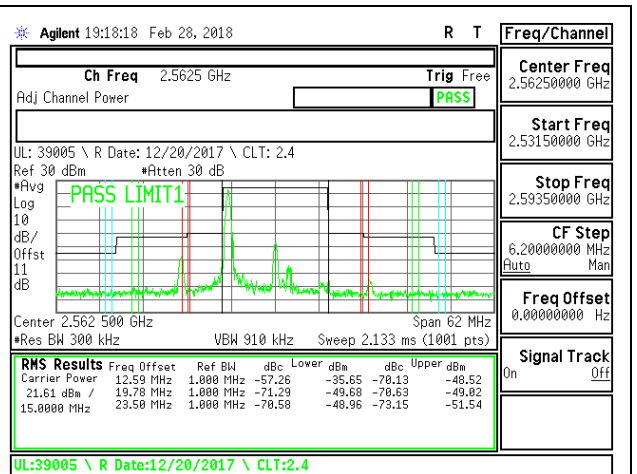

LTE B7 15MHz QPSK High Channel RB1-0

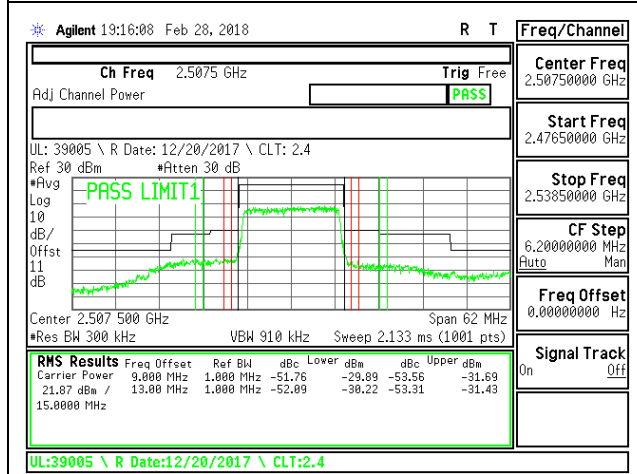

LTE B7 15MHz QPSK Low Channel RB75-0

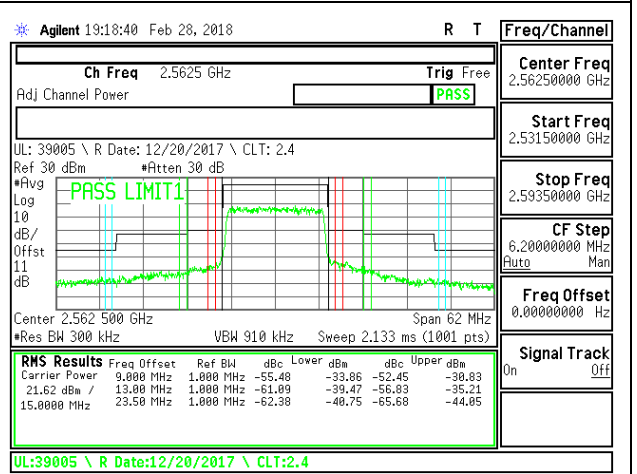

LTE B7 15MHz QPSK High Channel RB75-0

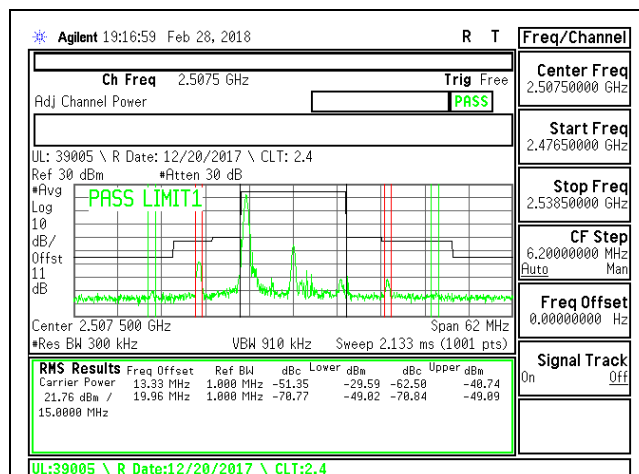

LTE B7 15MHz 16QAM Low Channel RB1-0

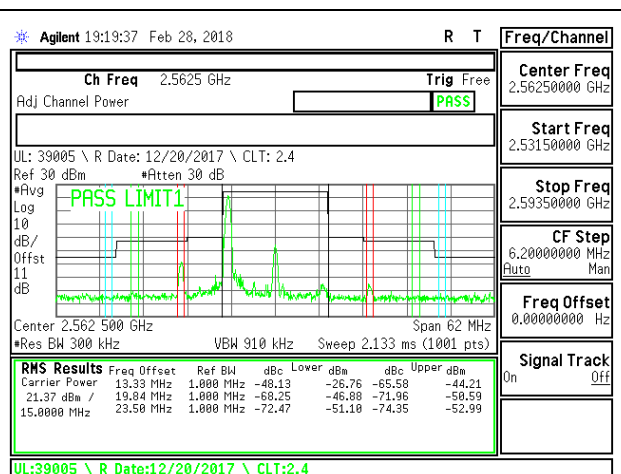

LTE B7 15MHz 16QAM High Channel RB1-0

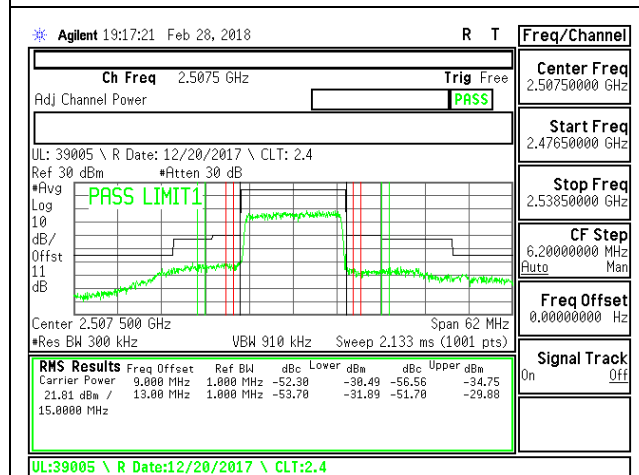

LTE B7 15MHz 16QAM Low Channel RB75-0

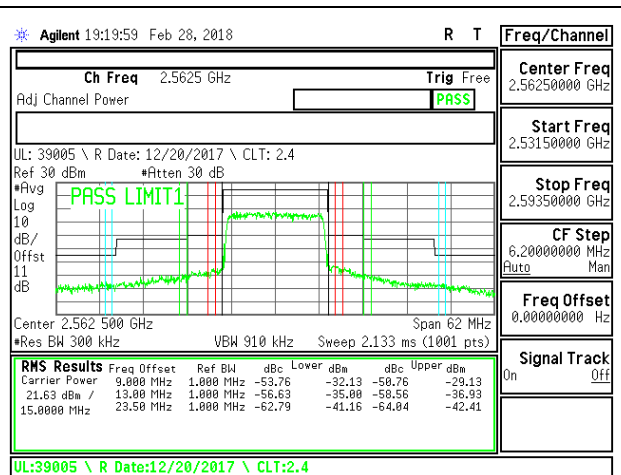

LTE B7 15MHz 16QAM High Channel RB75-0

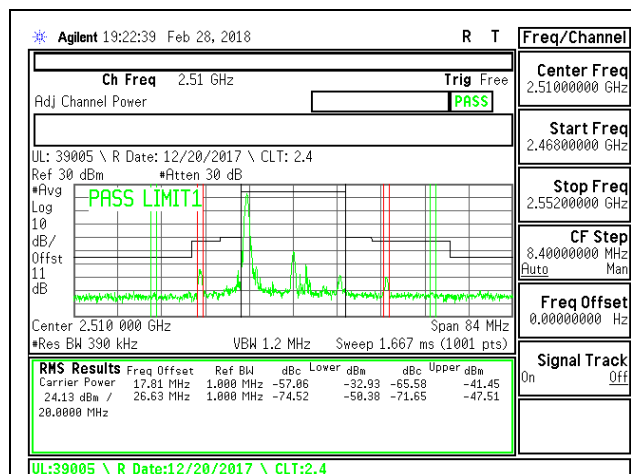

LTE B7 20MHz QPSK Low Channel RB1-0

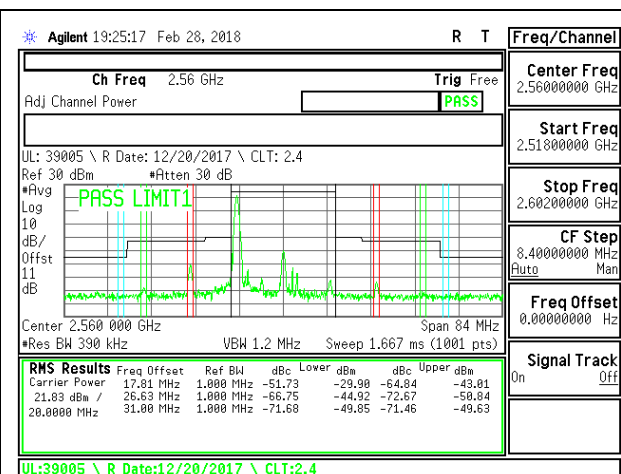

LTE B7 20MHz QPSK High Channel RB1-0

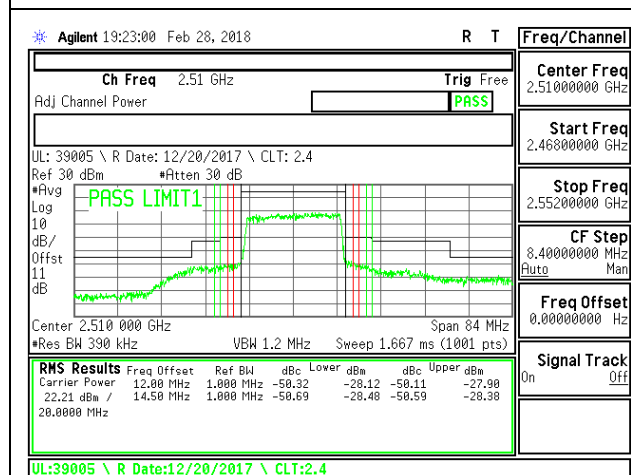

LTE B7 20MHz QPSK Low Channel RB100-0

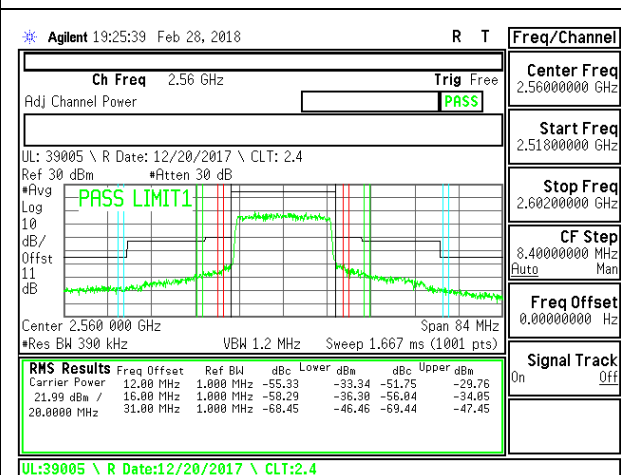

LTE B7 20MHz QPSK High Channel RB100-0



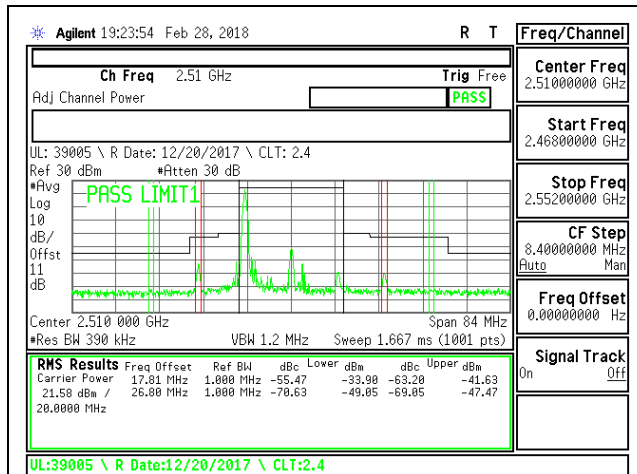

LTE B7 20MHz 16QAM Low Channel RB1-0

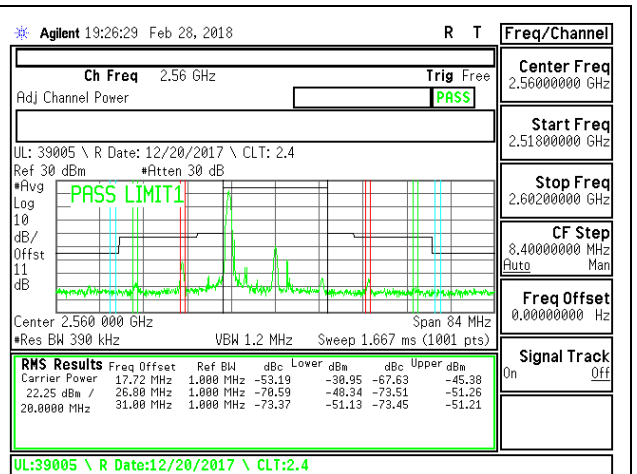

LTE B7 20MHz 16QAM High Channel RB1-0

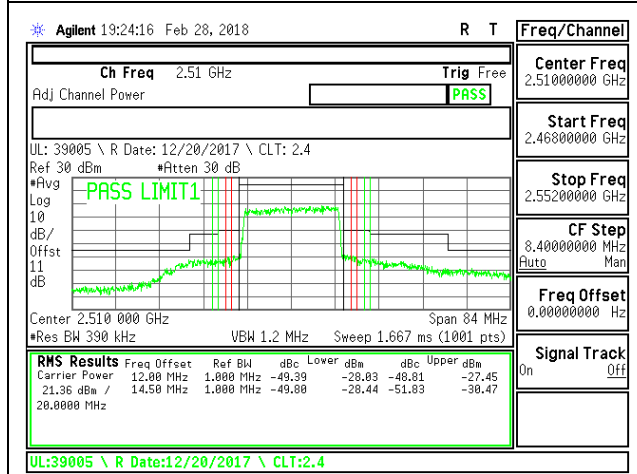

LTE B7 20MHz 16QAM Low Channel RB100-0

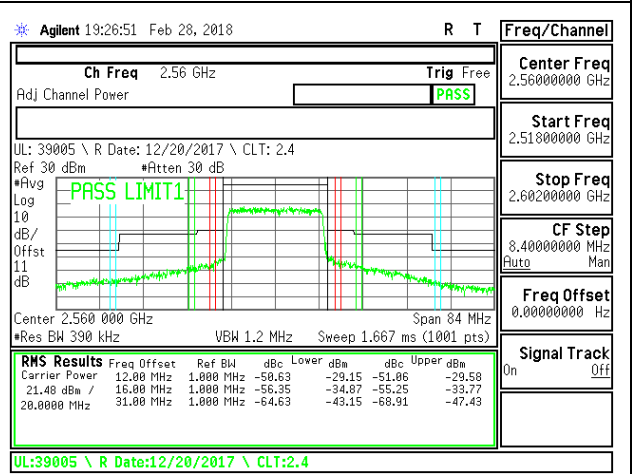

LTE B7 20MHz 16QAM High Channel RB100-0

8.2.7. LTE BAND 13 BANDEDGE

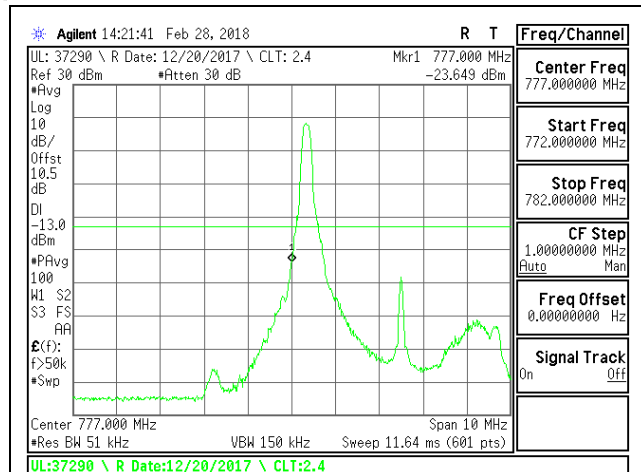

LTE B13 5MHz QPSK Low Channel RB1-0

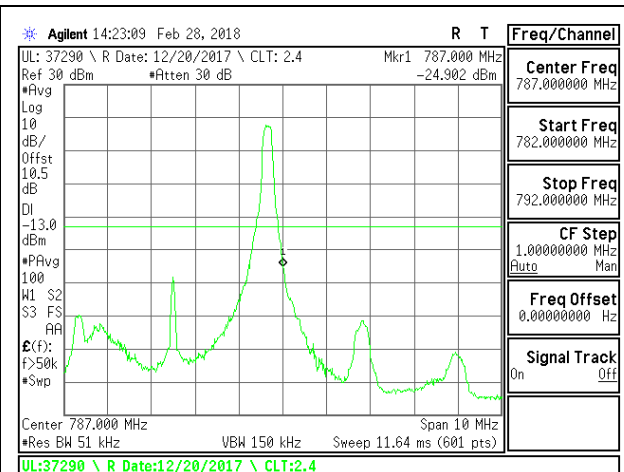

LTE B13 5MHz QPSK High Channel RB1-0

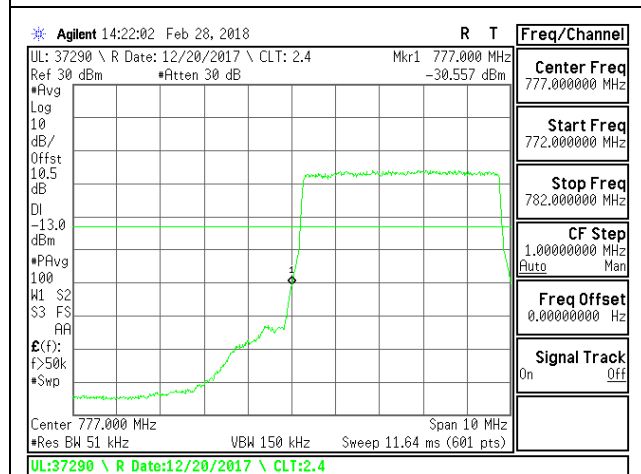

LTE B13 5MHz QPSK Low Channel RB25-0

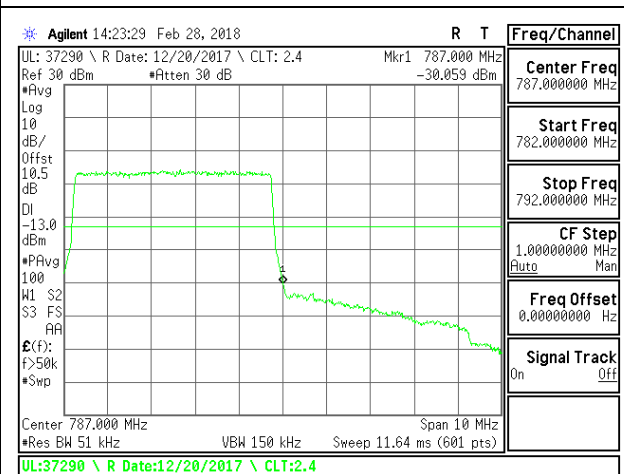

LTE B13 5MHz QPSK High Channel RB25-0

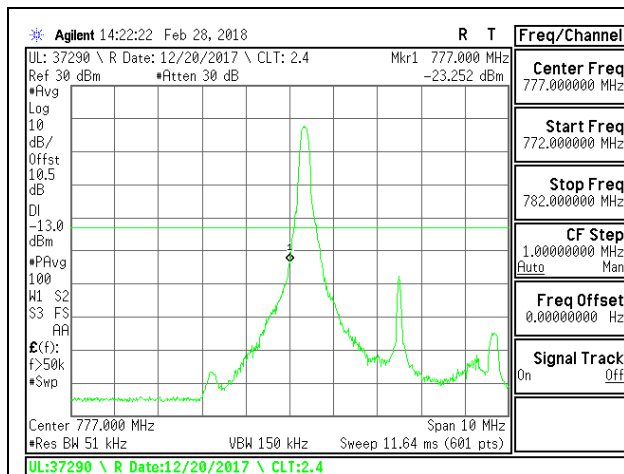

LTE B13 5MHz 16QAM Low Channel RB1-0

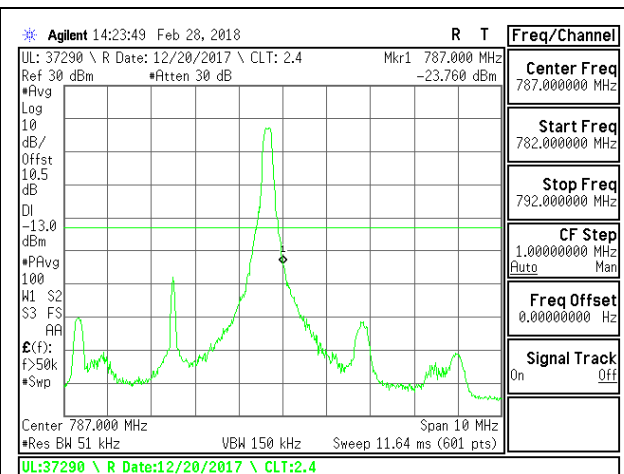

LTE B13 5MHz 16QAM High Channel RB1-0

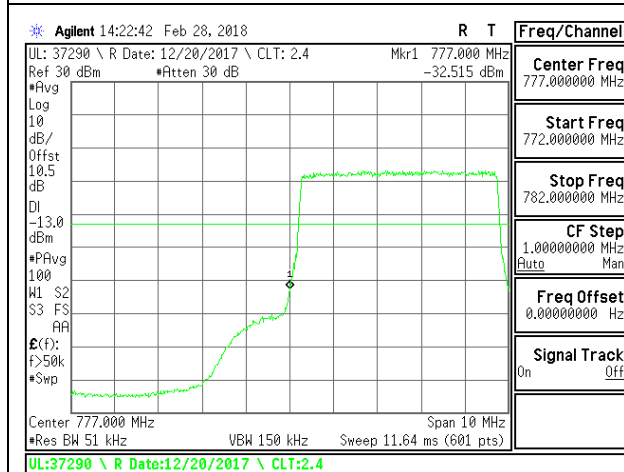

LTE B13 5MHz 16QAM Low Channel RB25-0

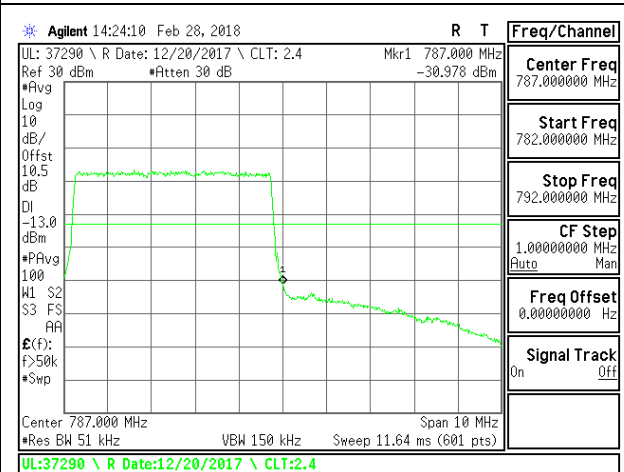

LTE B13 5MHz 16QAM High Channel RB25-0

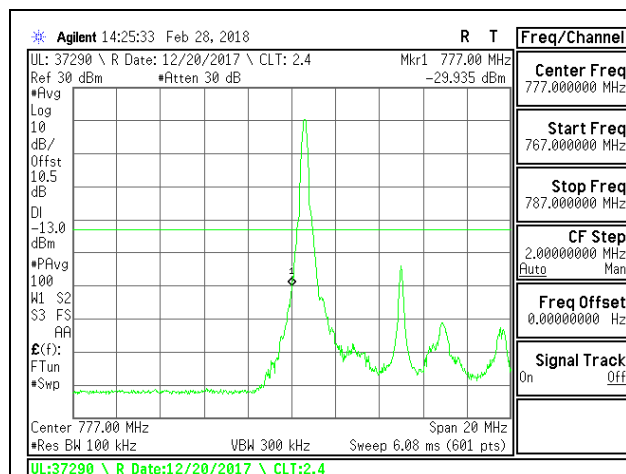

LTE B13 10MHz QPSK Low Channel RB1-0

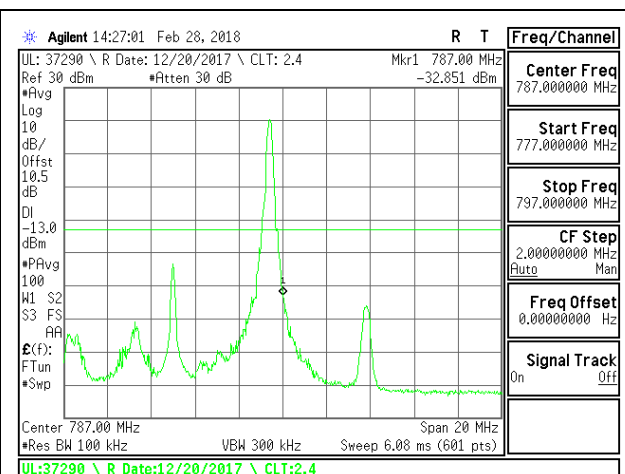

LTE B13 10MHz QPSK Mid Channel RB1-0

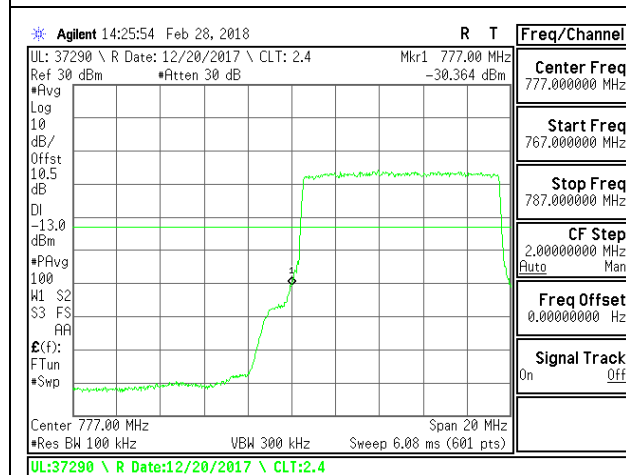

LTE B13 10MHz QPSK Mid Channel RB50-0

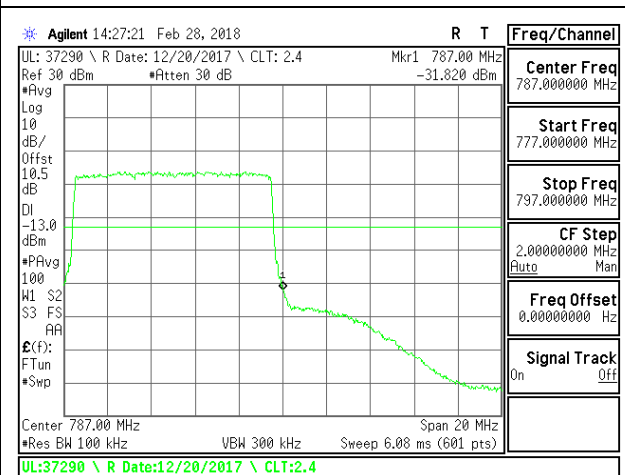

LTE B13 10MHz QPSK High Channel RB50-0

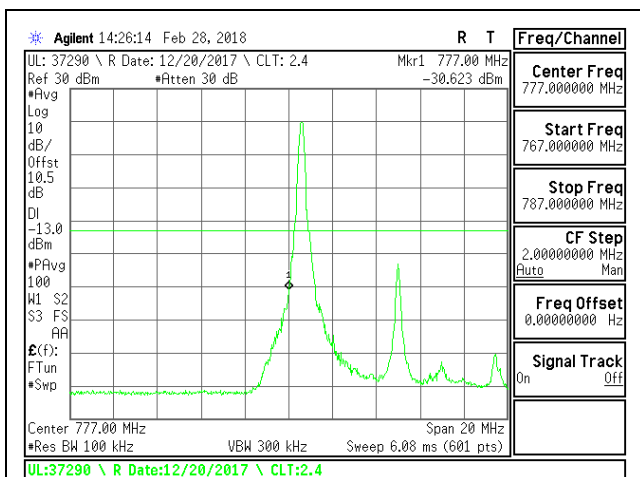

LTE B13 10MHz 16QAM Low Channel RB1-0

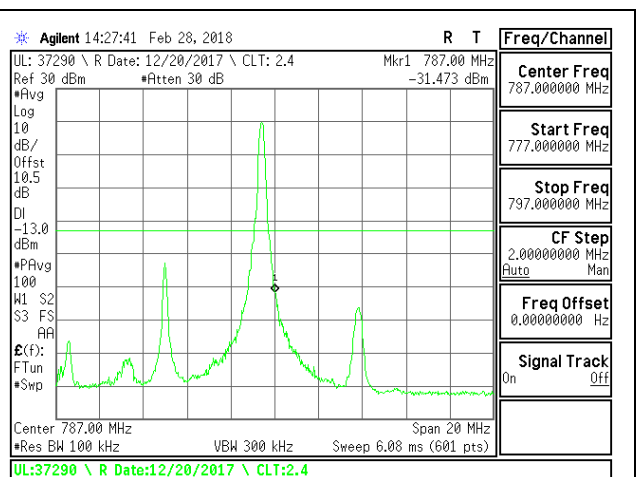

LTE B13 10MHz 16QAM Mid Channel RB1-0

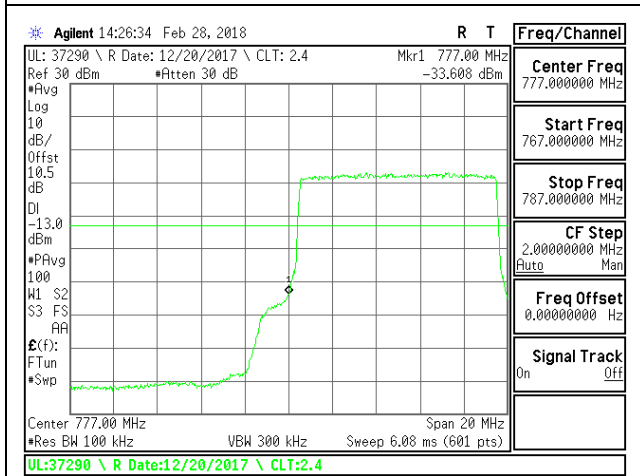

LTE B13 10MHz 16QAM Mid Channel RB50-0

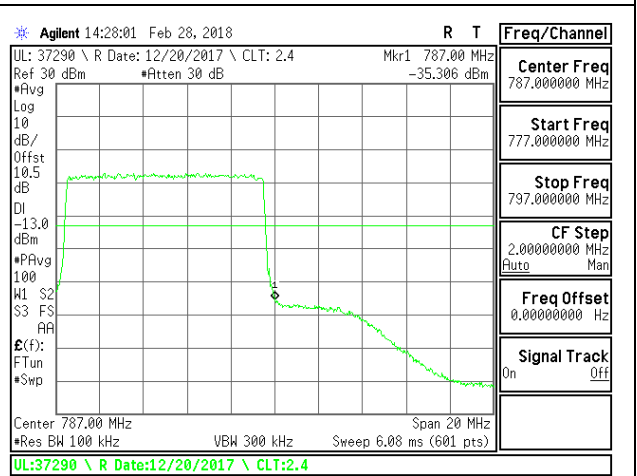

LTE B13 10MHz 16QAM High Channel RB50-0

8.2.8. LTE BAND 17 BANDEDGE

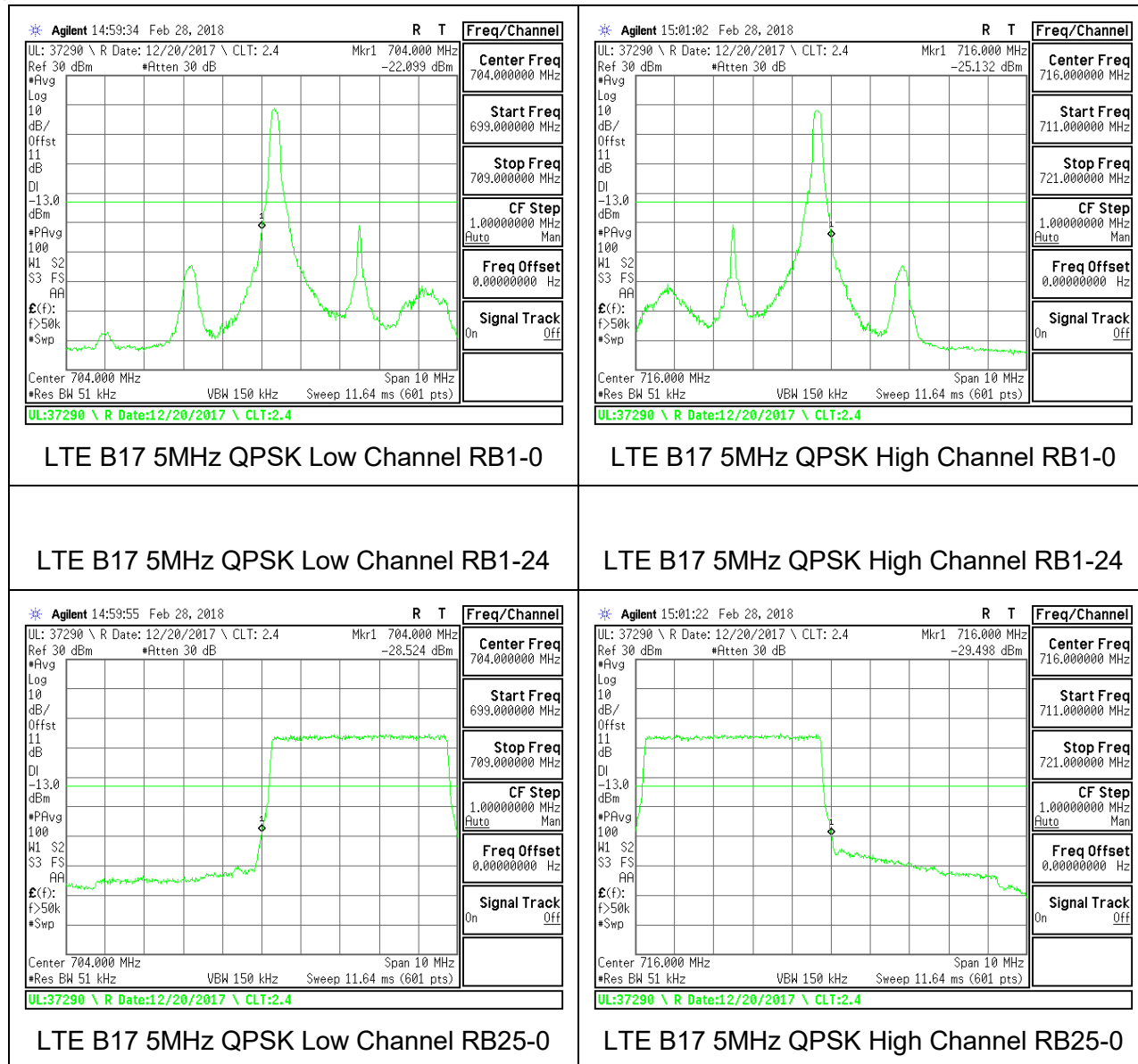

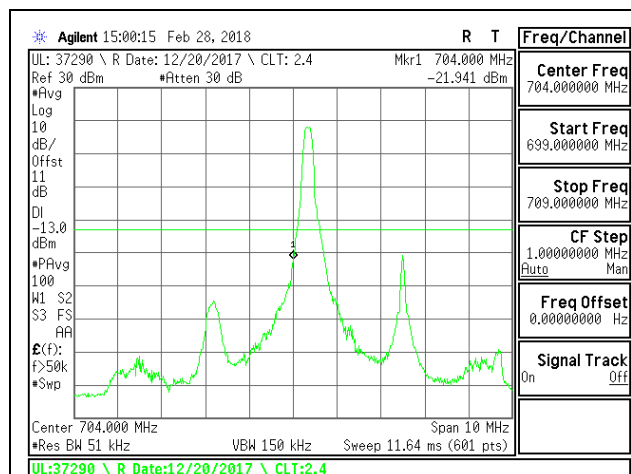

LTE B17 5MHz 16QAM Low Channel RB1-0

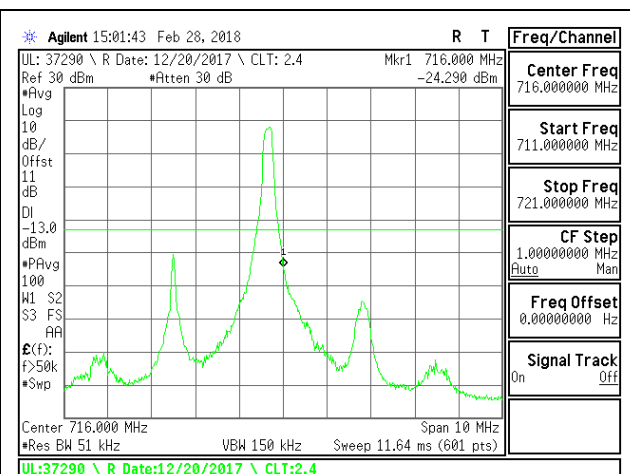

LTE B17 5MHz 16QAM High Channel RB1-0

LTE B17 5MHz 16QAM Low Channel RB1-24

LTE B17 5MHz 16QAM High Channel RB1-24

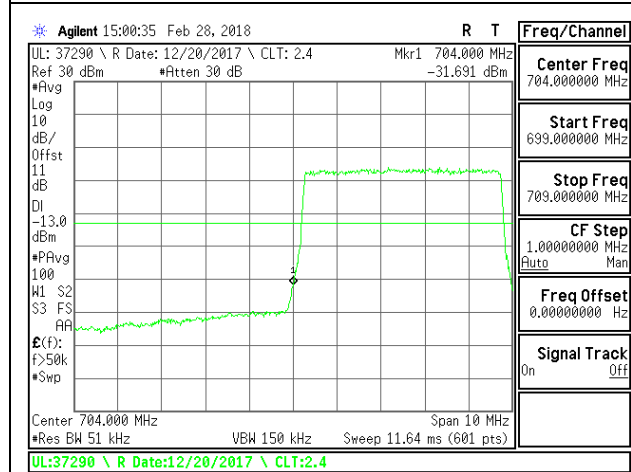

LTE B17 5MHz 16QAM Low Channel RB25-0

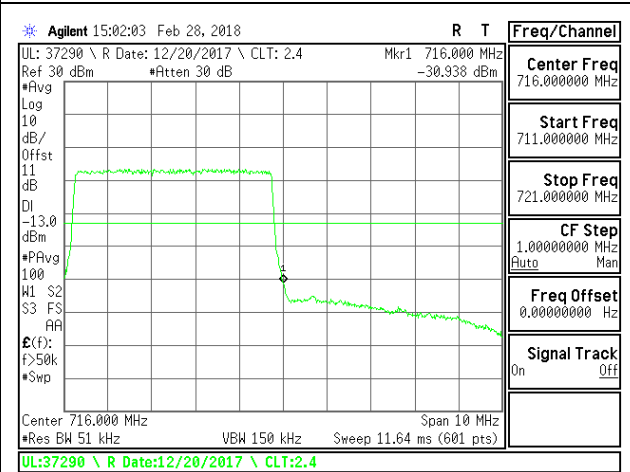

LTE B17 5MHz 16QAM High Channel RB25-0

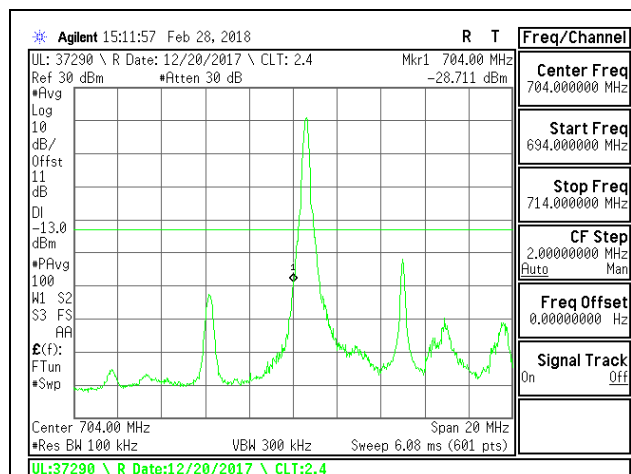

LTE B17 10MHz QPSK Low Channel RB1-0

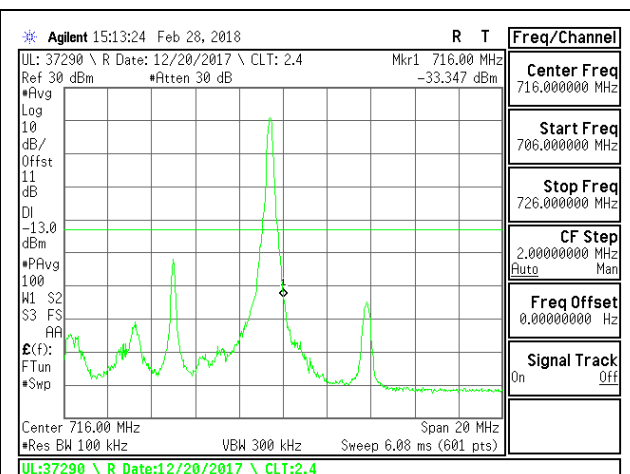

LTE B17 10MHz QPSK High Channel RB1-0

LTE B17 10MHz QPSK Low Channel RB1-49

LTE B17 10MHz QPSK High Channel RB1-49

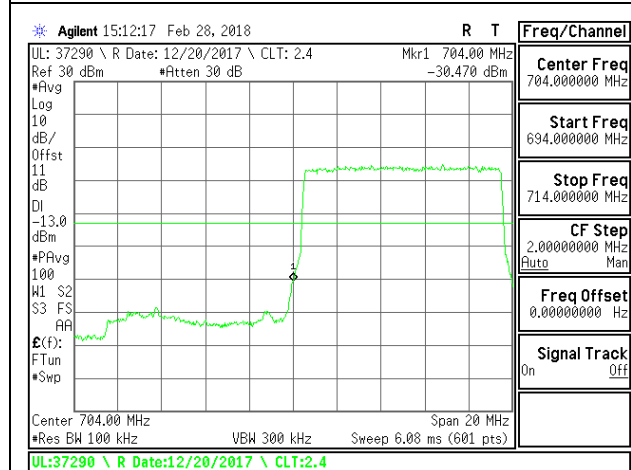

LTE B17 10MHz QPSK Low Channel RB50-0

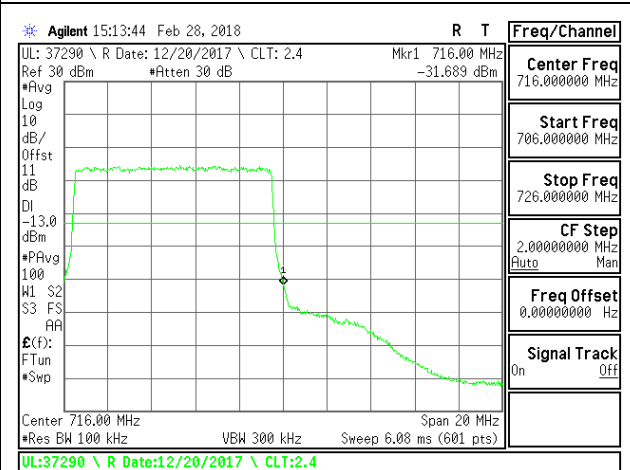

LTE B17 10MHz QPSK High Channel RB50-0



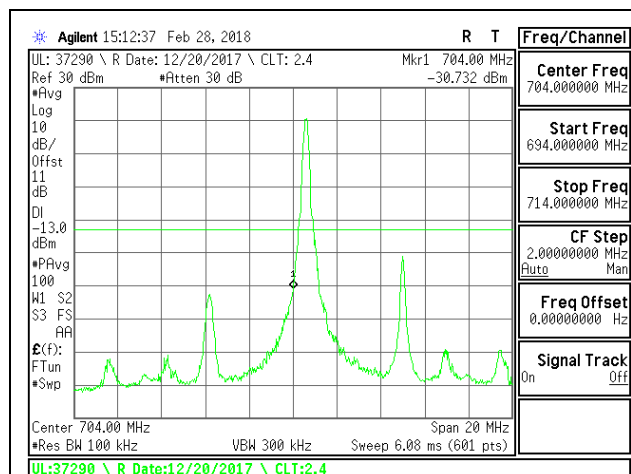

LTE B17 10MHz 16QAM Low Channel RB1-0

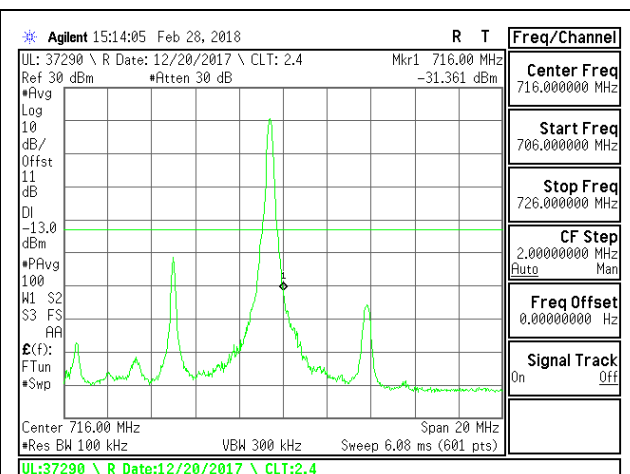

LTE B17 10MHz 16QAM High Channel RB1-0

LTE B17 10MHz 16QAM Low Channel RB1-49

LTE B17 10MHz 16QAM High Channel RB1-49

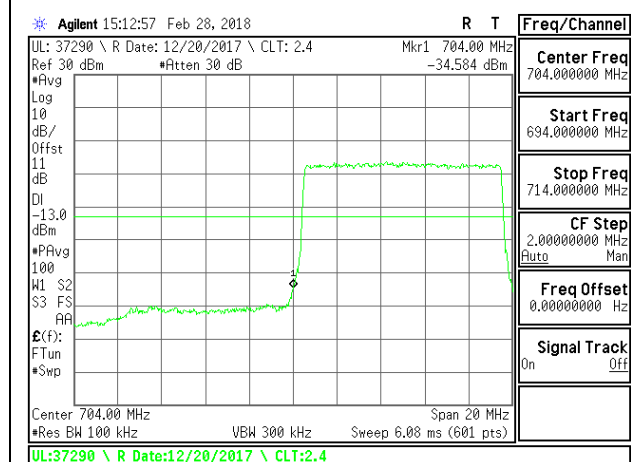

LTE B17 10MHz 16QAM Low Channel RB50-0

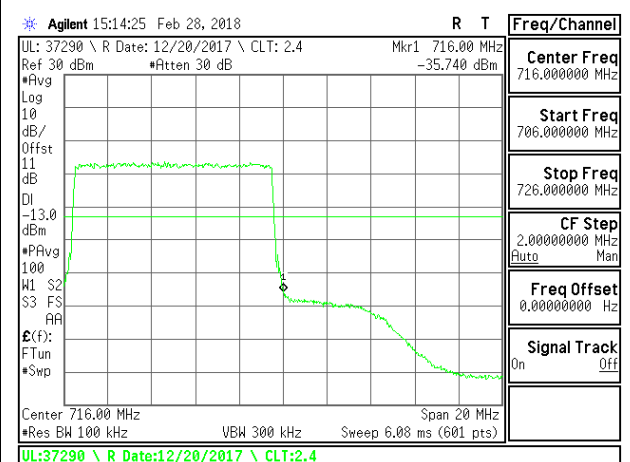

LTE B17 10MHz 16QAM High Channel RB50-0

8.2.9. LTE BAND 41 ADJACENT CHANNEL POWER

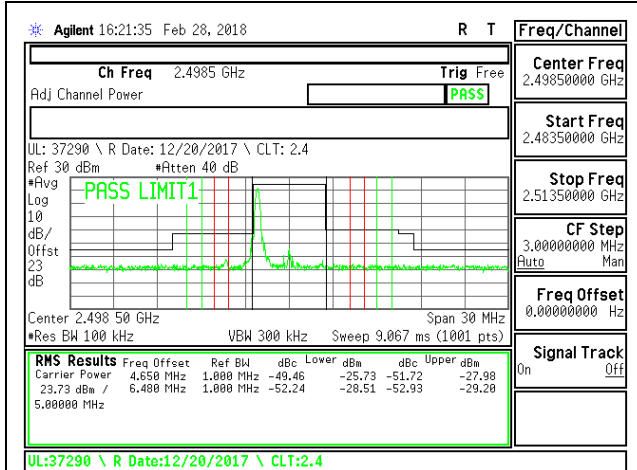

LTE B41 5MHz QPSK Low Channel RB1-0

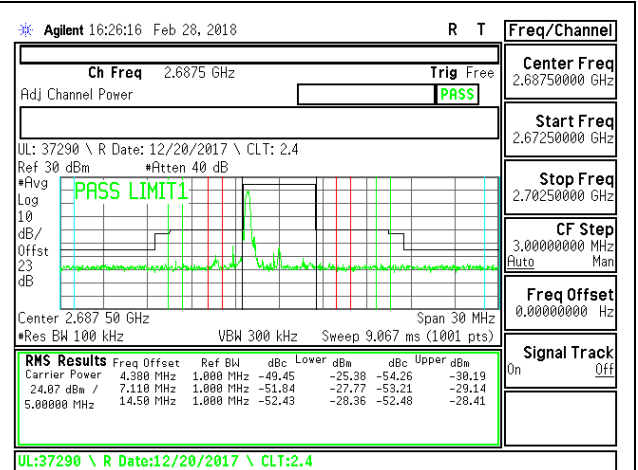

LTE B41 5MHz QPSK High Channel RB1-0

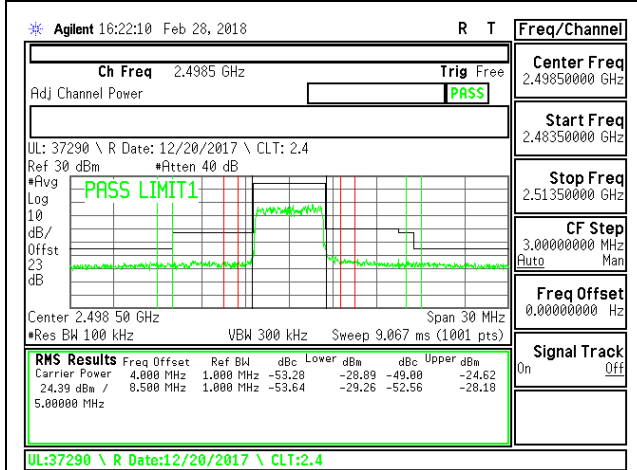

LTE B41 5MHz QPSK Low Channel RB25-0

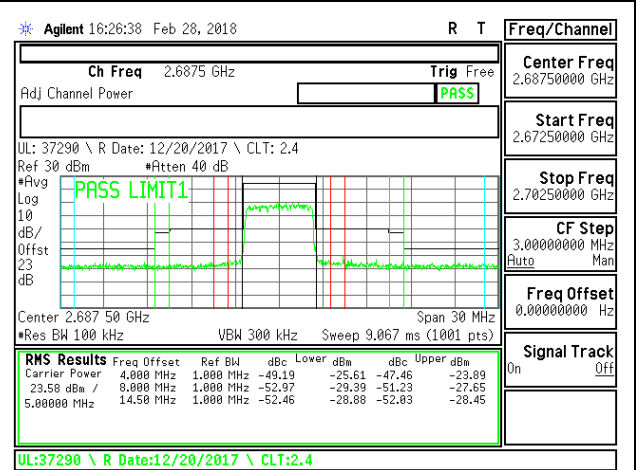

LTE B41 5MHz QPSK High Channel RB25-0

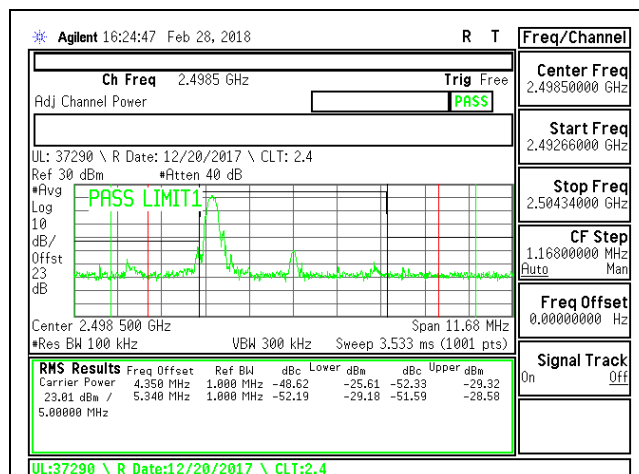

LTE B41 5MHz 16QAM Low Channel RB1-0

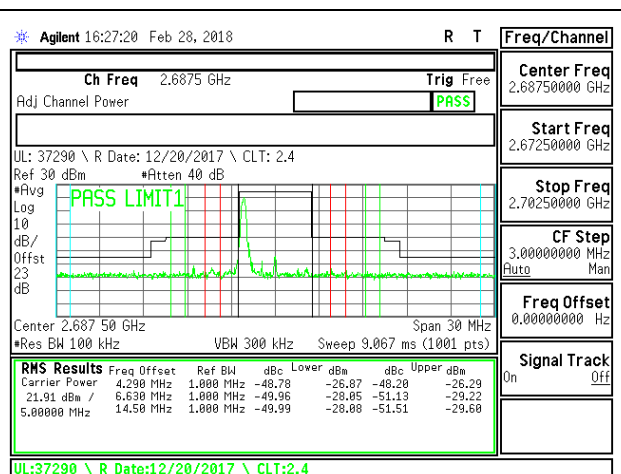

LTE B41 5MHz 16QAM High Channel RB1-0

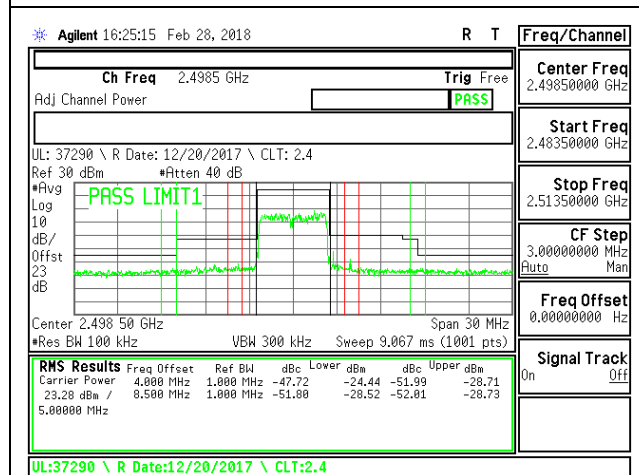

LTE B41 5MHz 16QAM Low Channel RB25-0

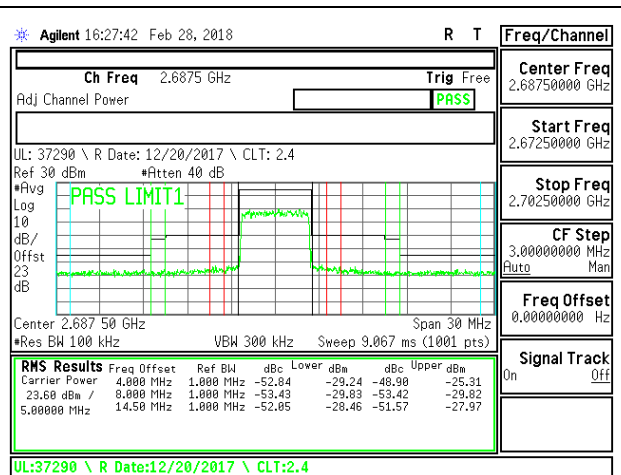

LTE B41 5MHz 16QAM High Channel RB25-0

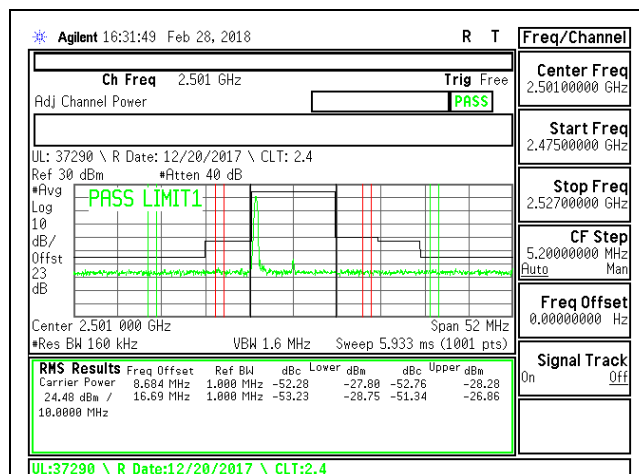

LTE B41 10MHz QPSK Low Channel RB1-0

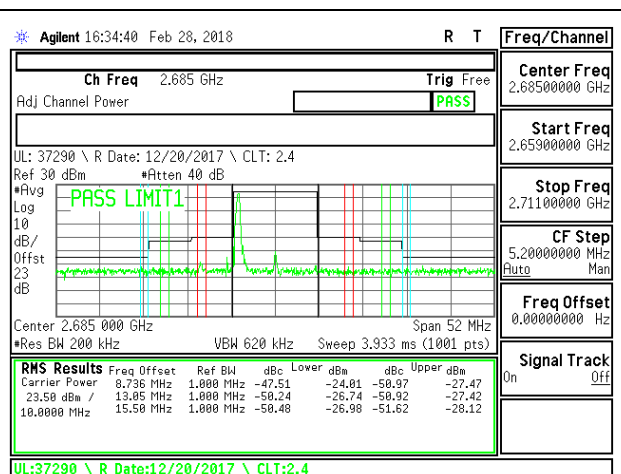

LTE B41 10MHz QPSK High Channel RB1-0

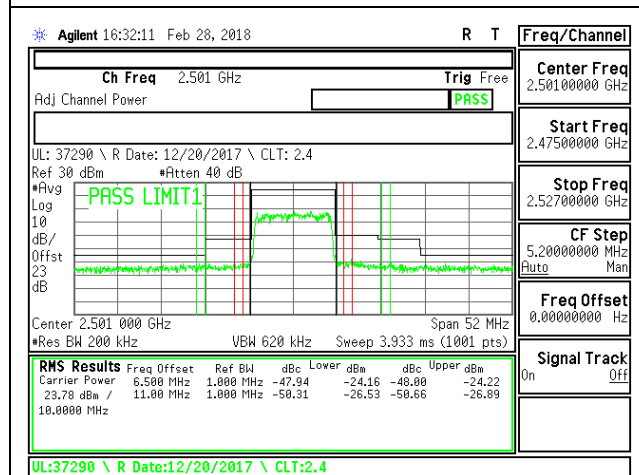

LTE B41 10MHz QPSK Low Channel RB50-0

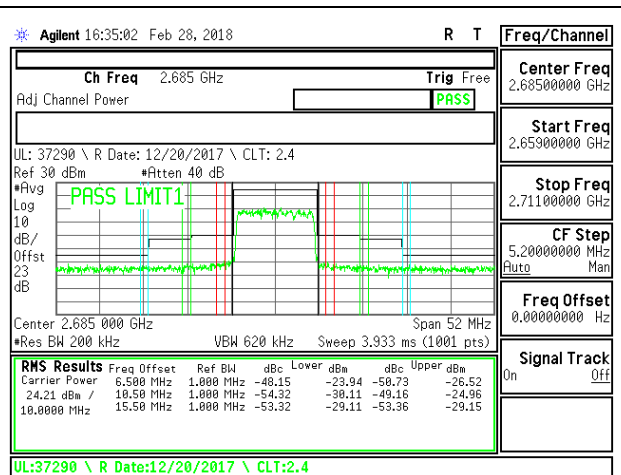

LTE B41 10MHz QPSK High Channel RB50-0

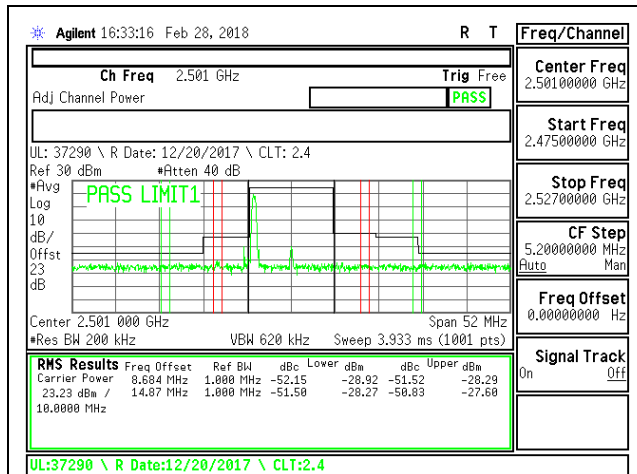

LTE B41 10MHz 16QAM Low Channel RB1-0

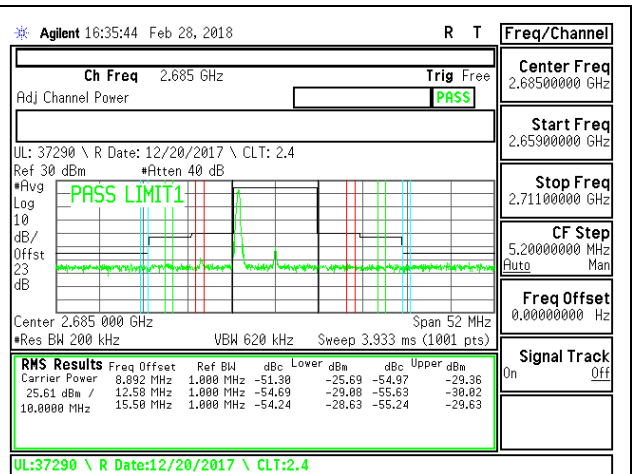

LTE B41 10MHz 16QAM High Channel RB1-0

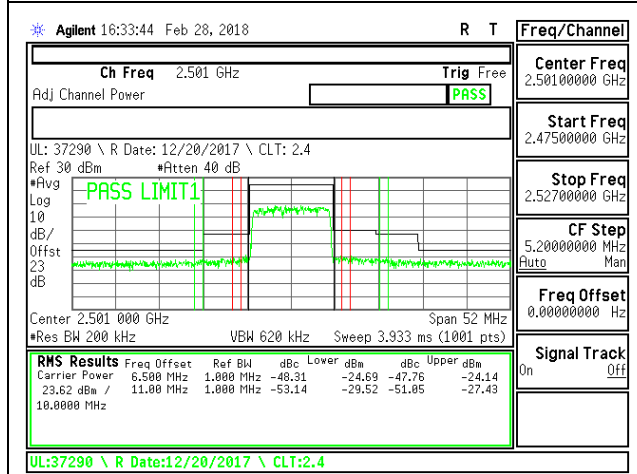

LTE B41 10MHz 16QAM Low Channel RB50-0

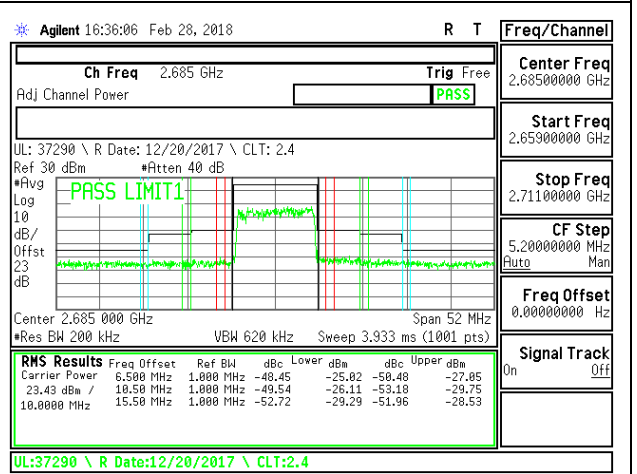

LTE B41 10MHz 16QAM High Channel RB50-0

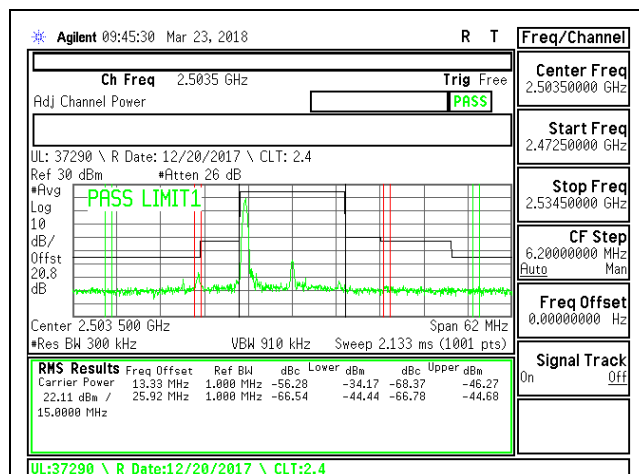

LTE B41 15MHz QPSK Low Channel RB1-0

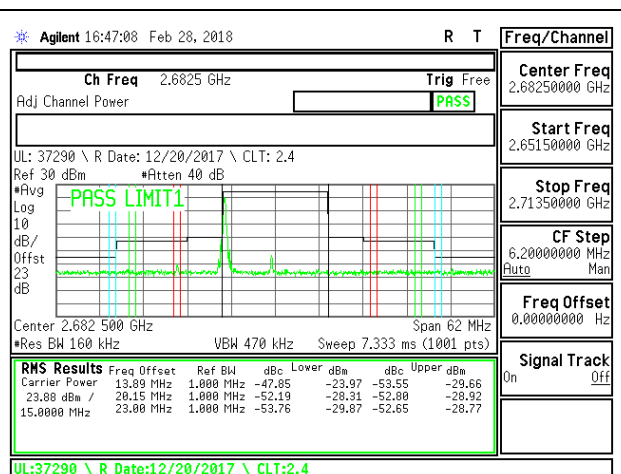

LTE B41 15MHz QPSK High Channel RB1-0

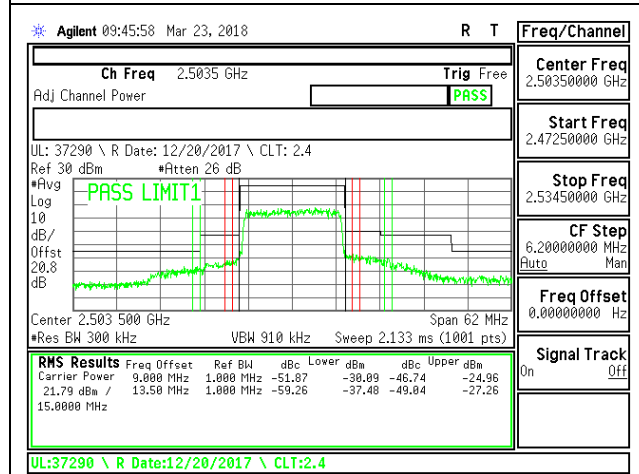

LTE B41 15MHz QPSK Low Channel RB75-0

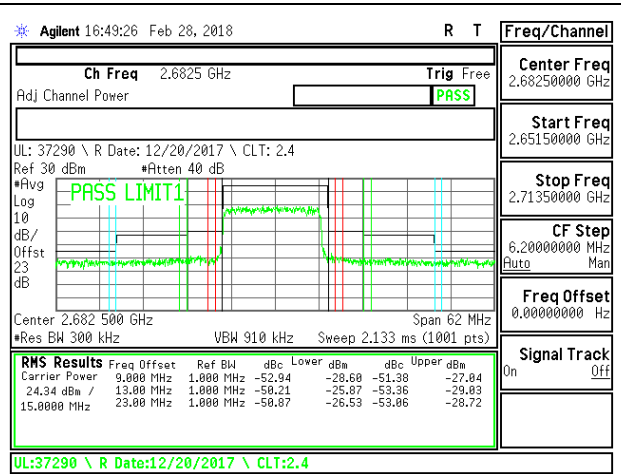

LTE B41 15MHz QPSK High Channel RB75-0

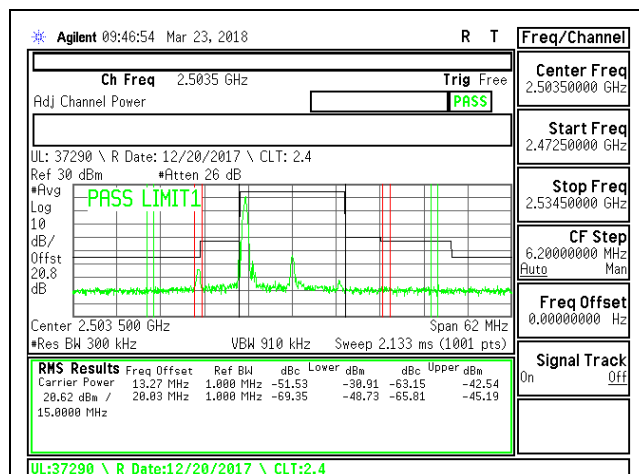

LTE B41 15MHz 16QAM Low Channel RB1-0

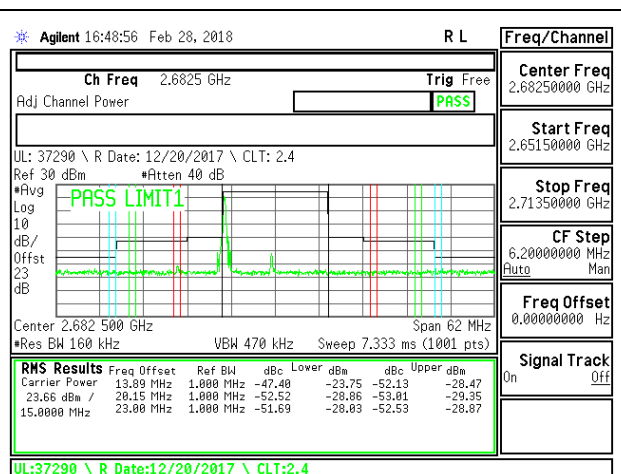

LTE B41 15MHz 16QAM High Channel RB1-0

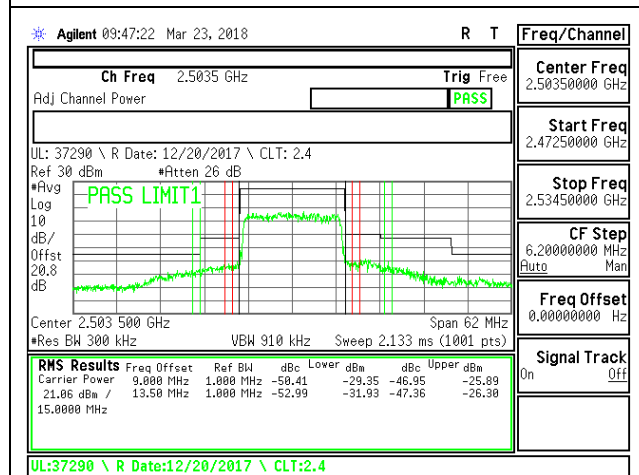

LTE B41 15MHz 16QAM Low Channel RB75-0

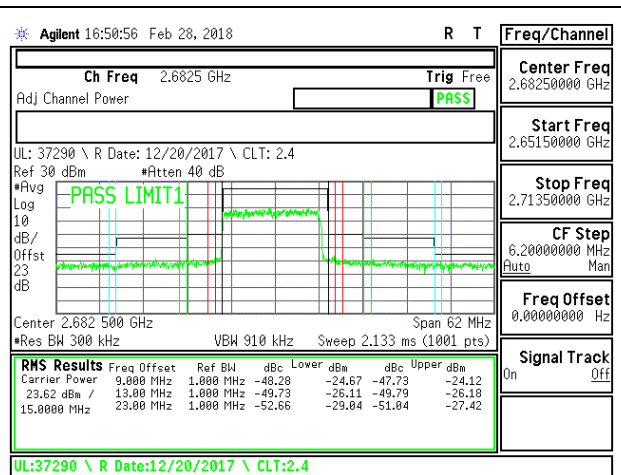

LTE B41 15MHz 16QAM High Channel RB75-0

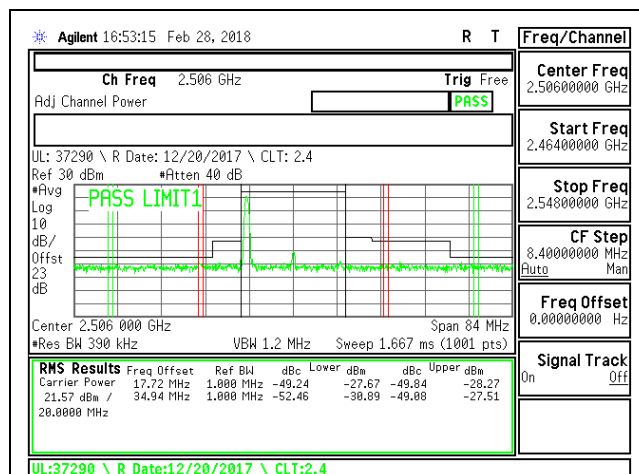

LTE B41 20MHz QPSK Low Channel RB1-0

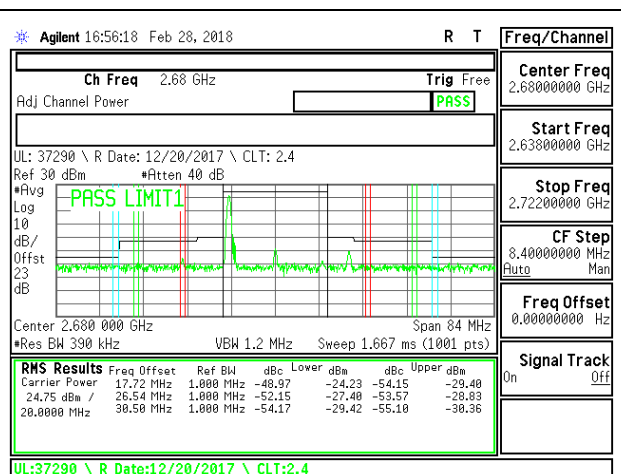

LTE B41 20MHz QPSK High Channel RB1-0

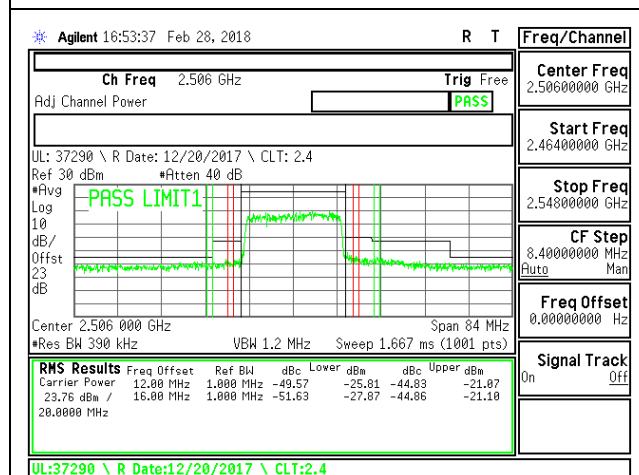

LTE B41 20MHz QPSK Low Channel RB100-0

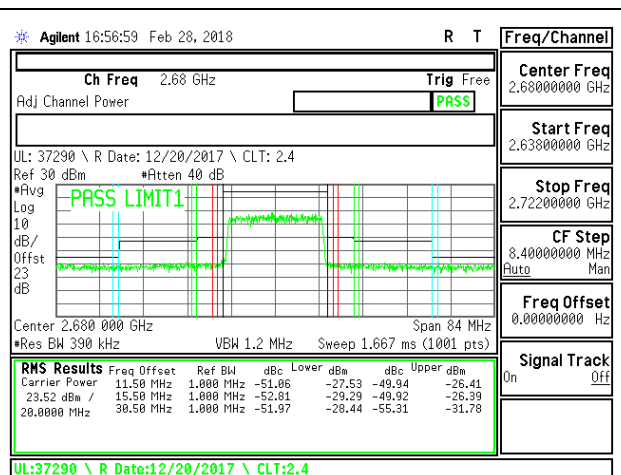

LTE B41 20MHz QPSK High Channel RB100-0



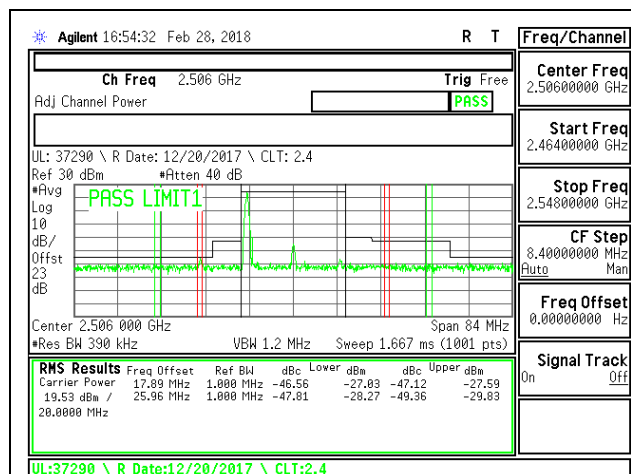

LTE B41 20MHz 16QAM Low Channel RB1-0

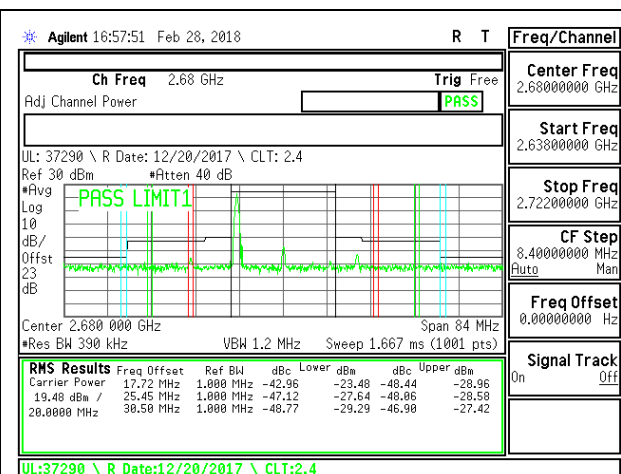

LTE B41 20MHz 16QAM High Channel RB1-0

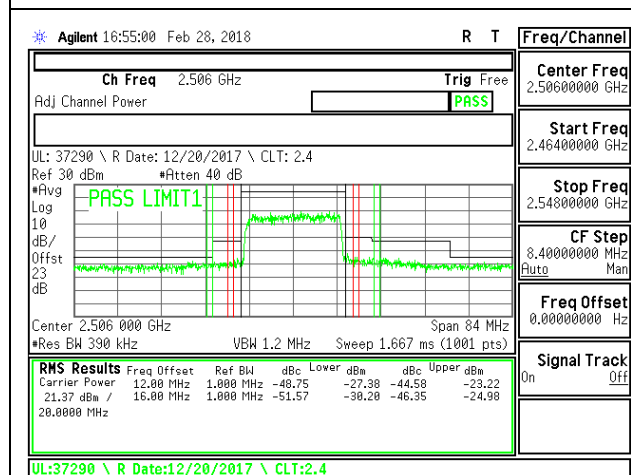

LTE B41 20MHz 16QAM Low Channel RB100-0

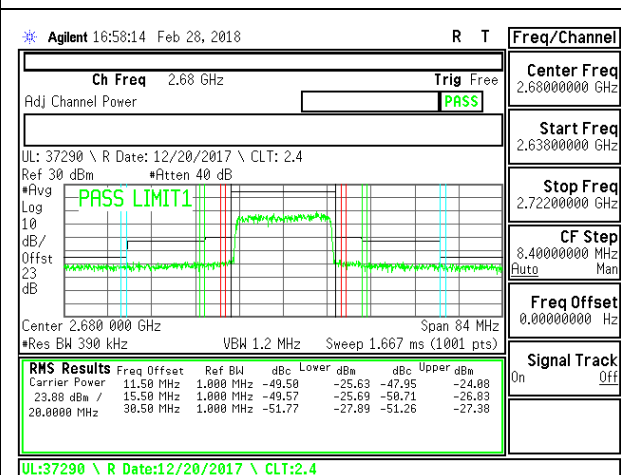

LTE B41 20MHz 16QAM High Channel RB100-0

### **8.3. OUT OF BAND EMISSIONS**

#### **RULE PART(S)**

FCC: §2.1051, §22.901, §22.917, §24.238, §27.53

#### **LIMITS**

FCC: §22.917, §24.238, §27.53 (c), (g), (h),

The minimum permissible attenuation level of any spurious emissions is  $43 + 10 \log (P)$  dB where transmitting power (P) in Watts.

FCC: §27.53 (m) (Band 7, 41)

The minimum permissible attenuation level of any spurious emissions is  $55 + 10 \log (P)$  dB where transmitting power (P) in Watts.

#### **TEST PROCEDURE**

The RF output of the transmitter was connected to a spectrum analyzer through a calibrated coaxial cable. Sufficient scans were taken to show the out-of-band Emissions, if any, up to 10th harmonic. Multiple sweeps were recorded in maximum hold mode using a peak detector to ensure that the worst-case emissions were caught.

For each out of band emissions measurement:

- Set display line at -13 dBm
- Set RBW & VBW to 100 kHz for the measurement below 1 GHz, and 1 MHz for the measurement above 1 GHz. (NOTE: Worst case set RBW/VBW to 1MHz/3MHz)

#### **MODES TESTED**

- GSM
- WCDMA
- LTE Band 4
- LTE Band 5
- LTE Band 7
- LTE Band 13
- LTE Band 17
- LTE Band 41

#### **RESULTS**

8.3.1. GSM GSM850

GPRS

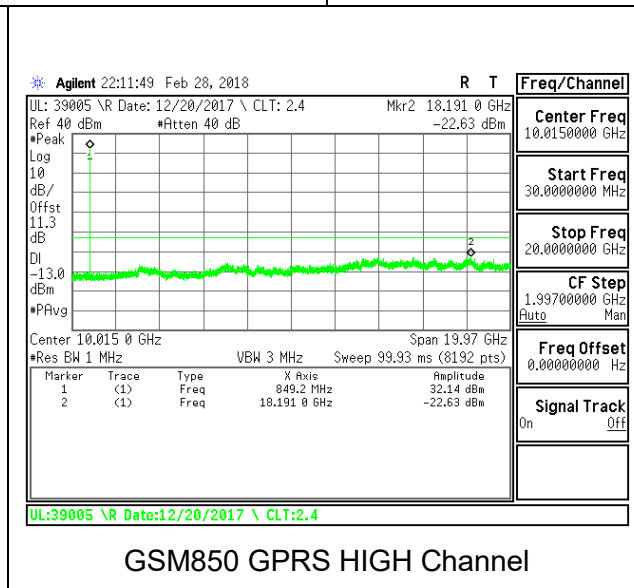
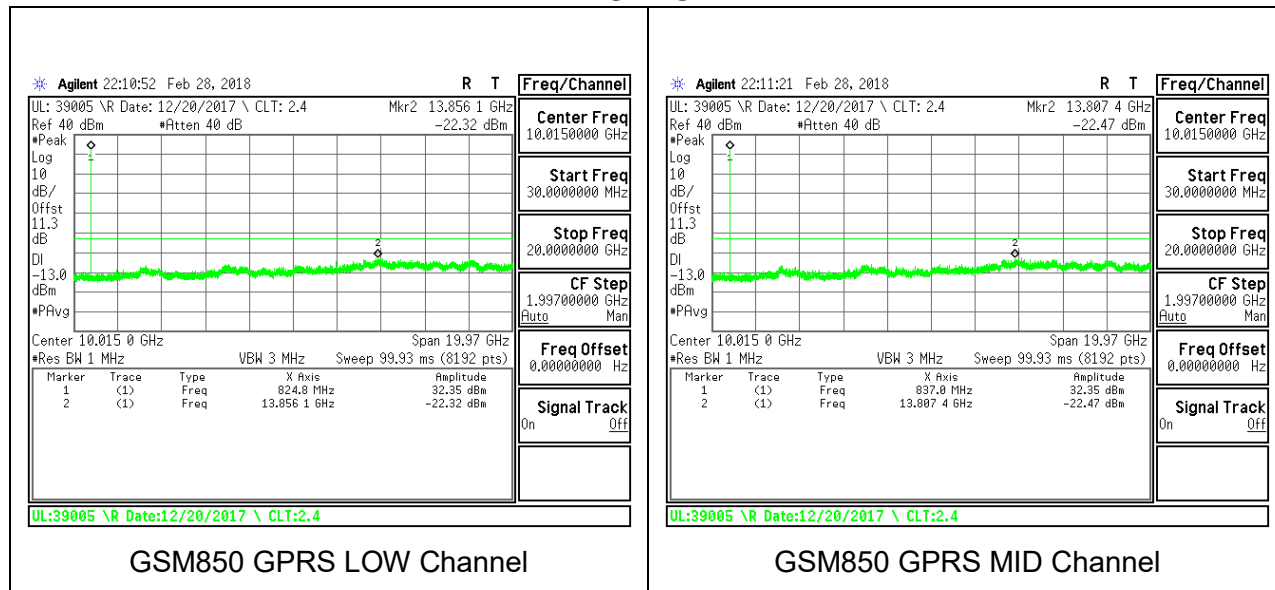

### EGPRS

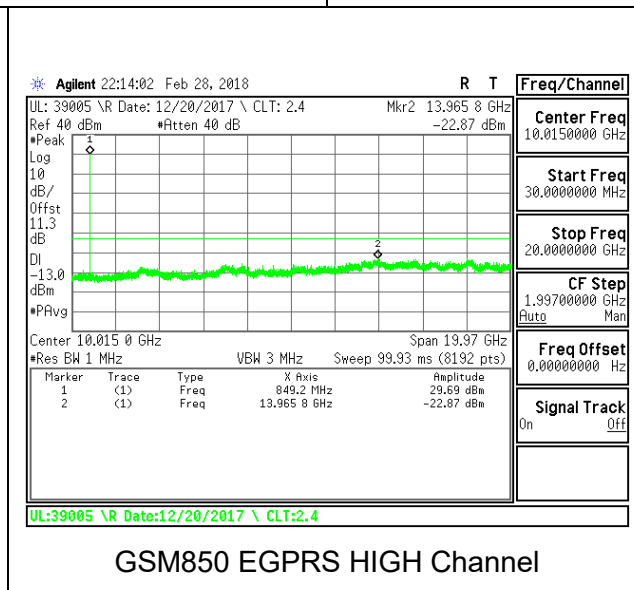
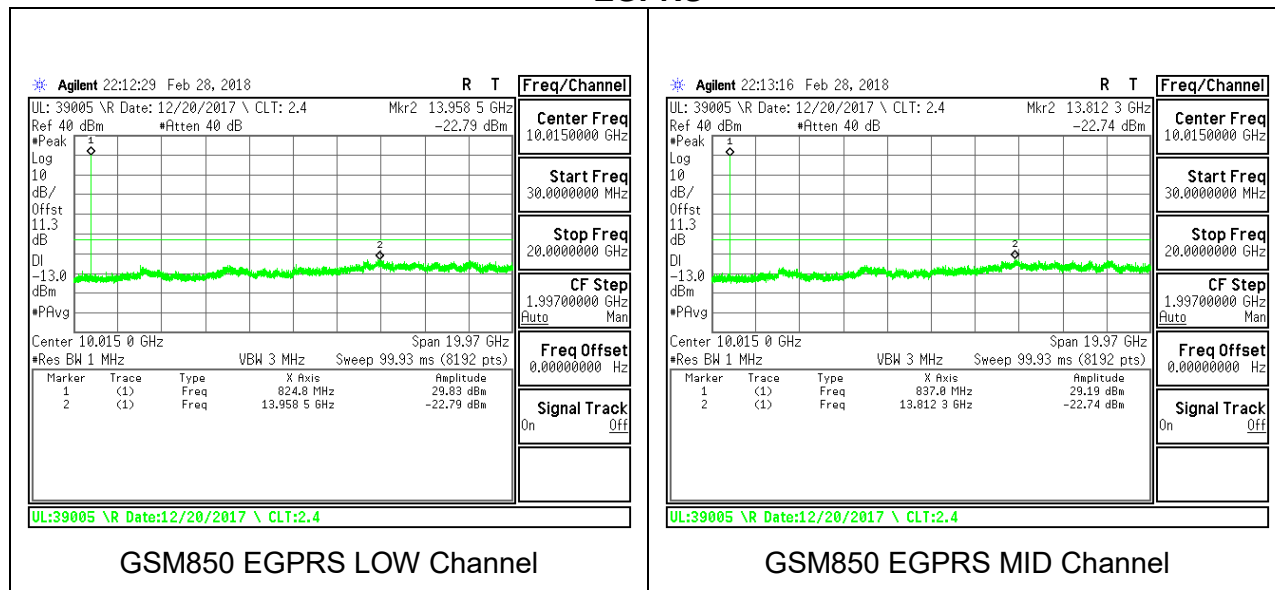

8.3.2. GSM GSM1900

GPRS

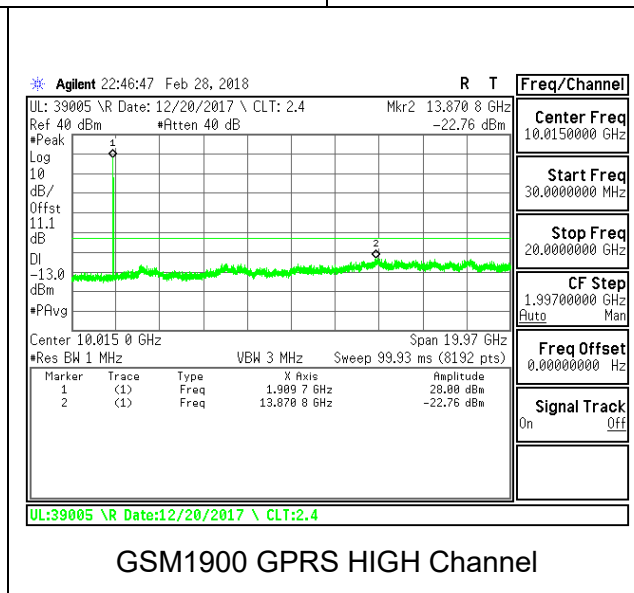
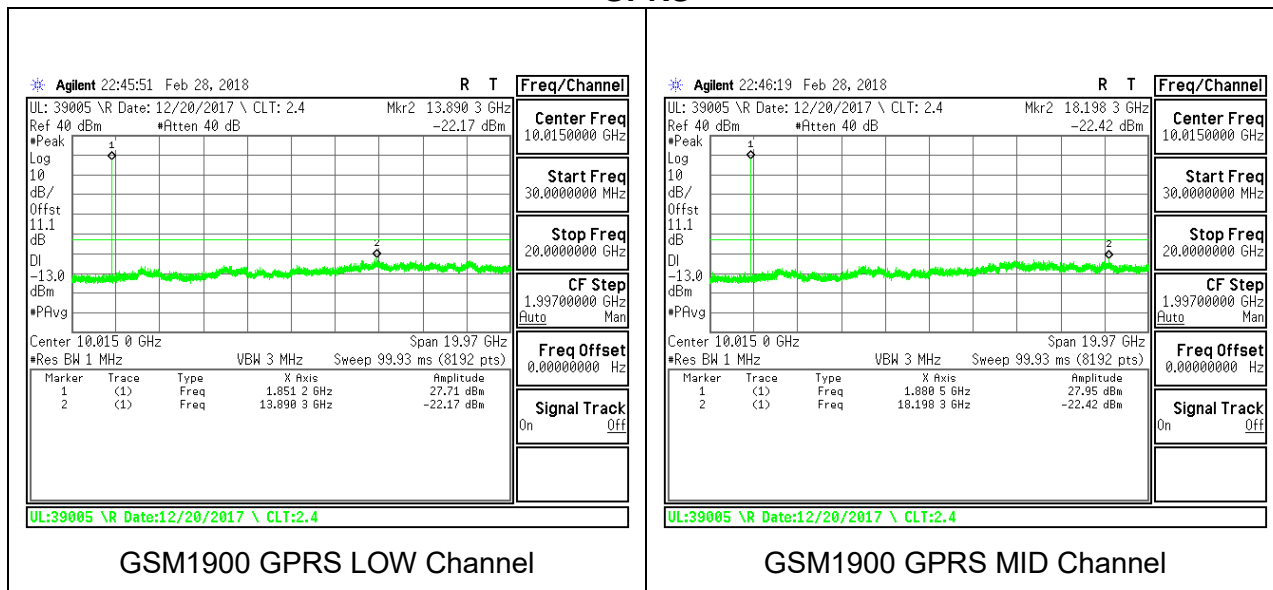

**EGPRS**

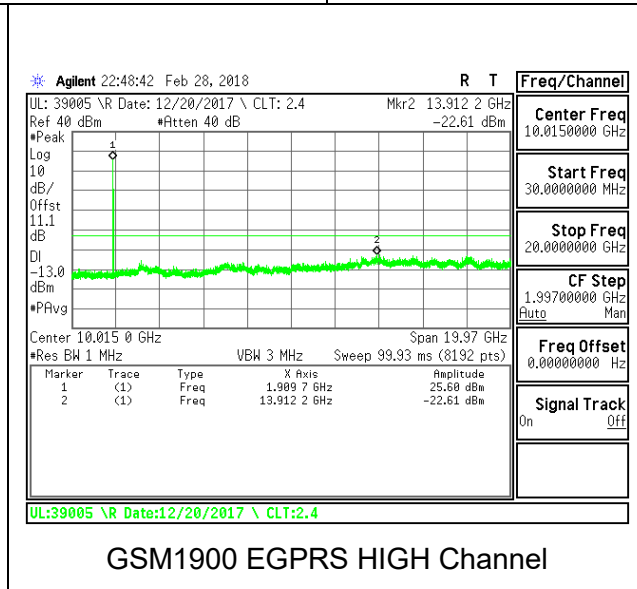
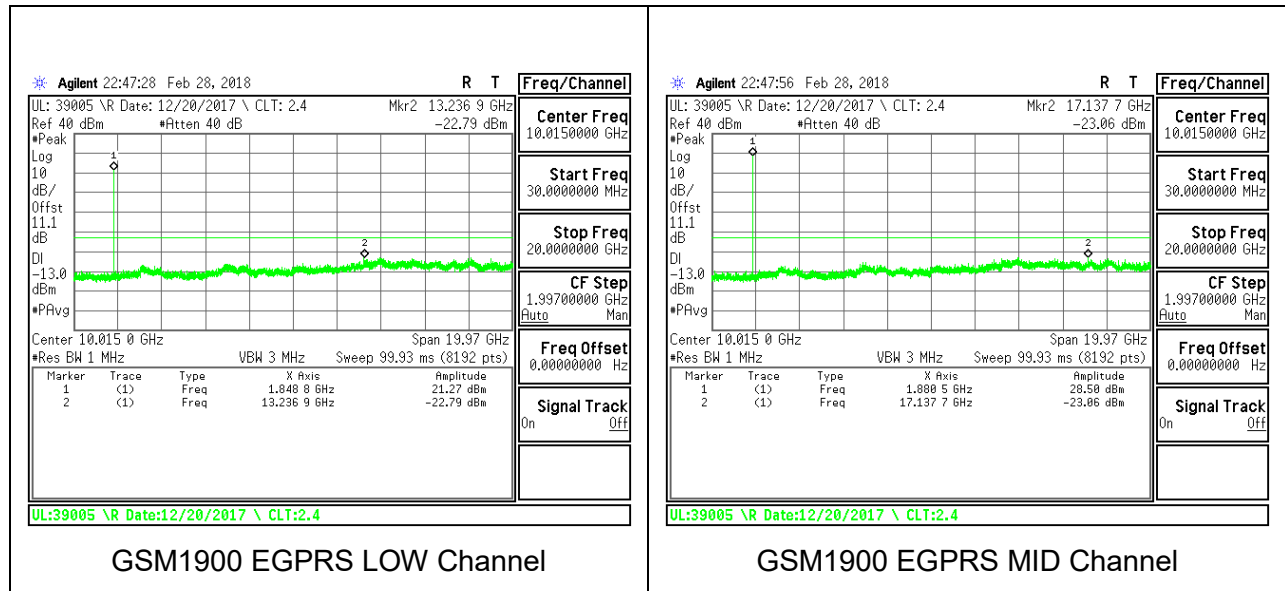

8.3.3. WCDMA BAND5

Rel99

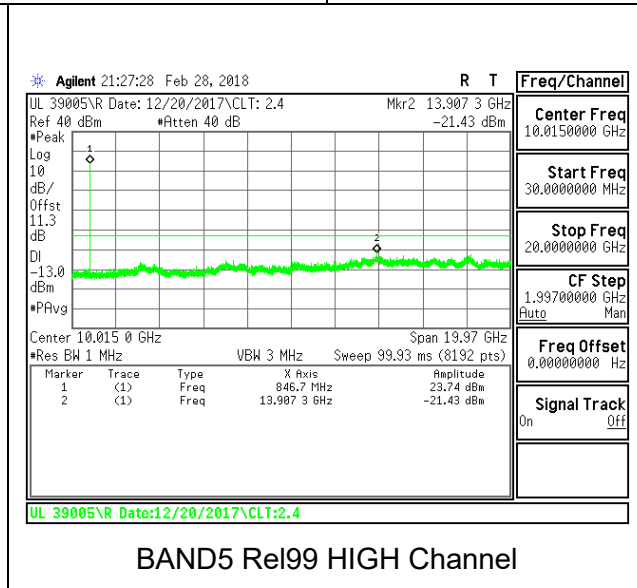
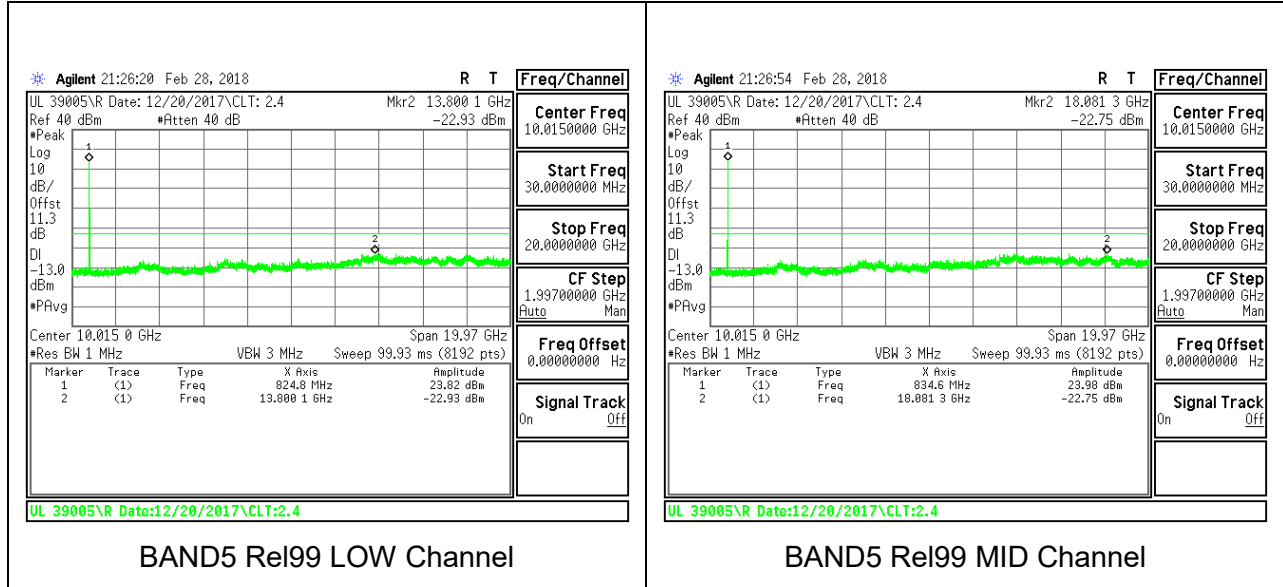

### HSDPA

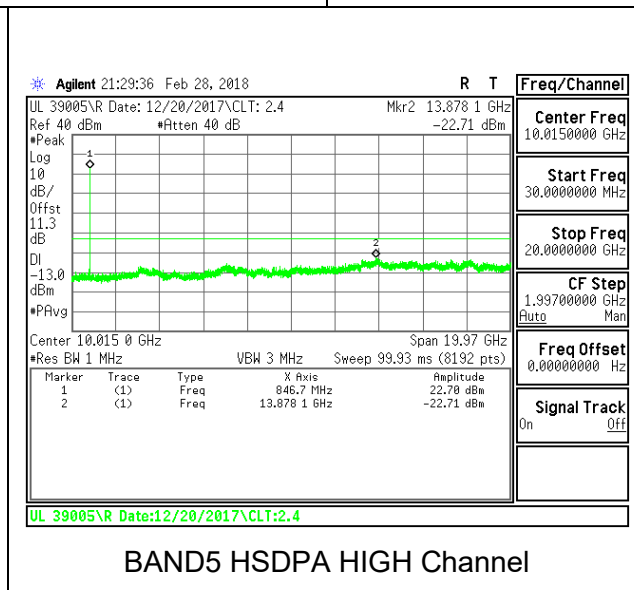
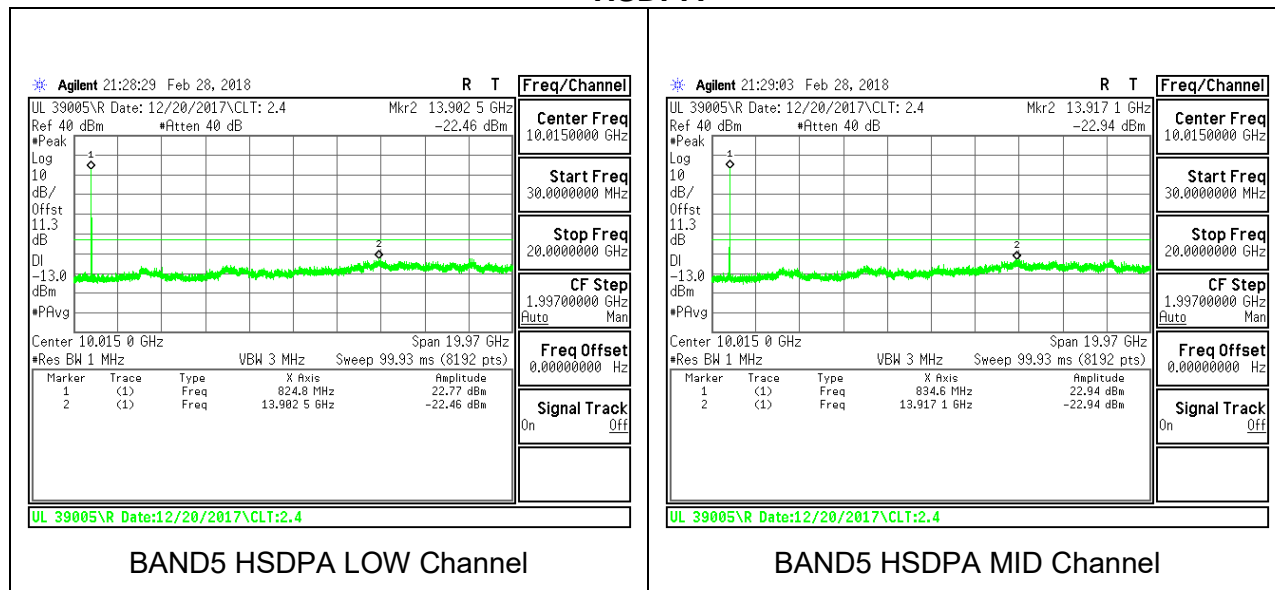



8.3.4. WCDMA BAND2

Rel99

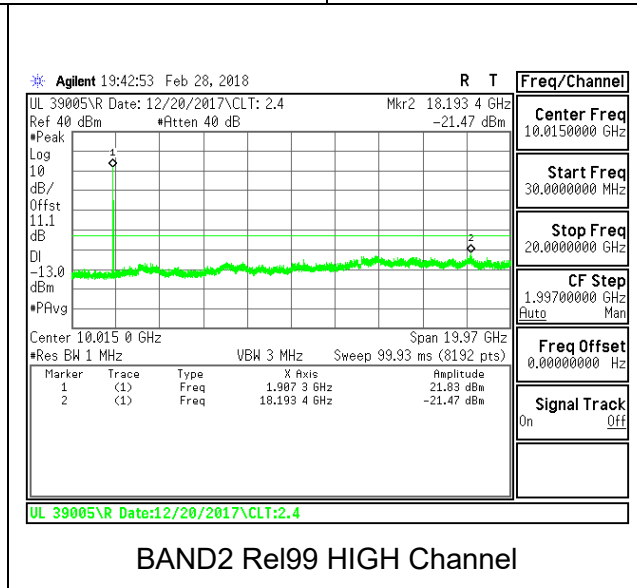
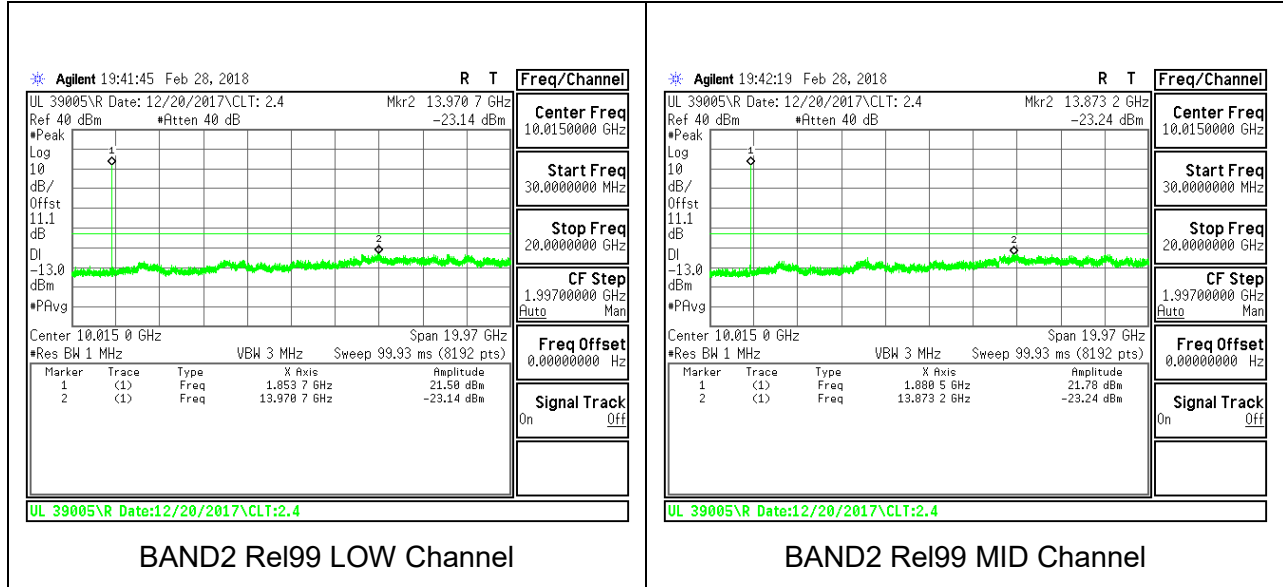

**HSDPA**

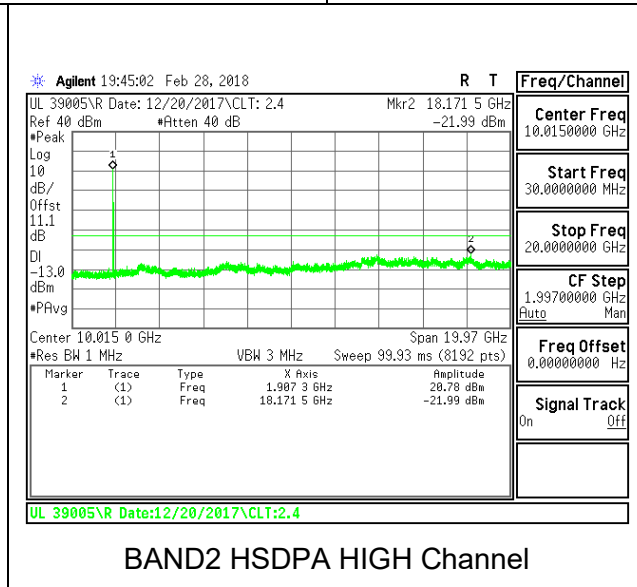
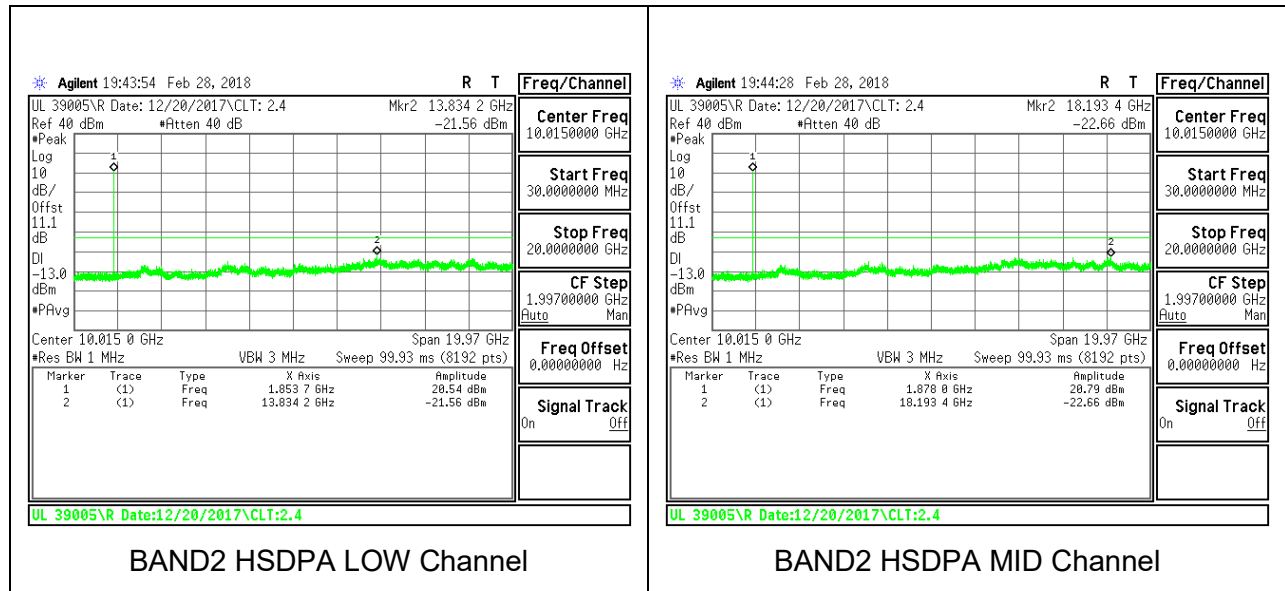

8.3.5. WCDMA BAND4

Rel99

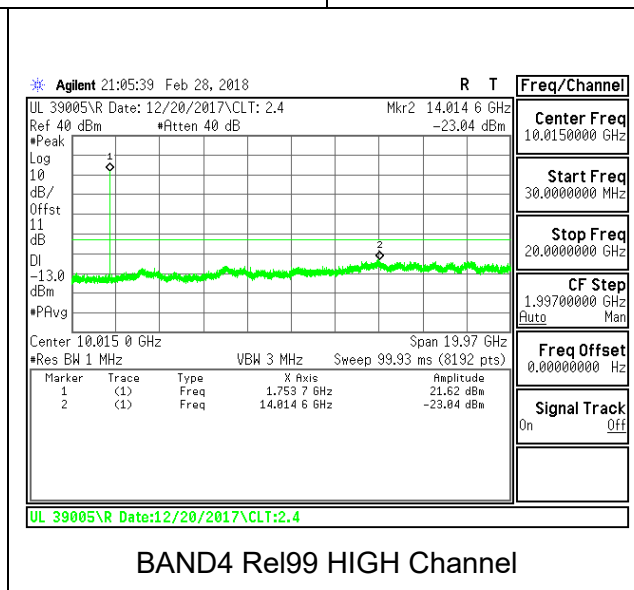
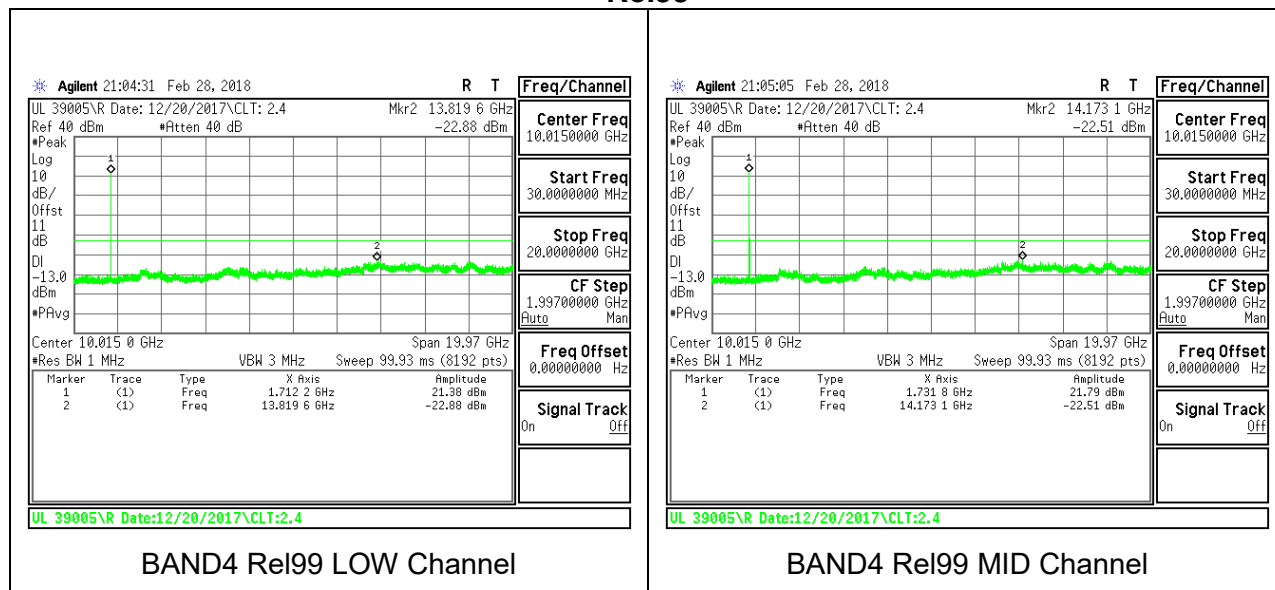

### HSDPA

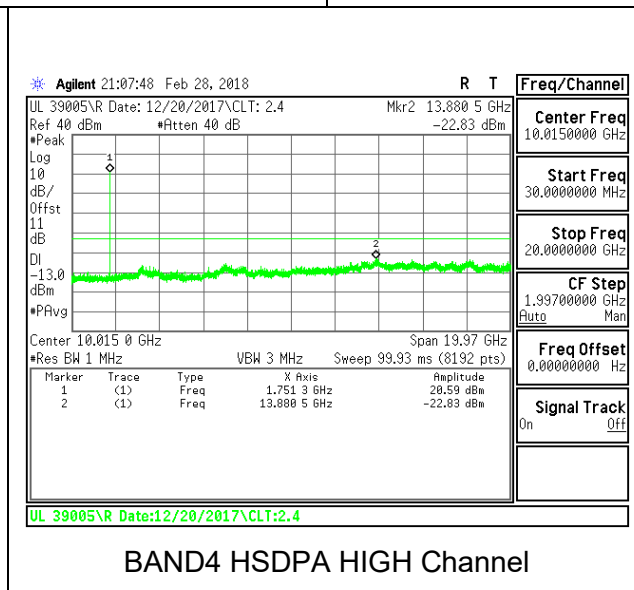
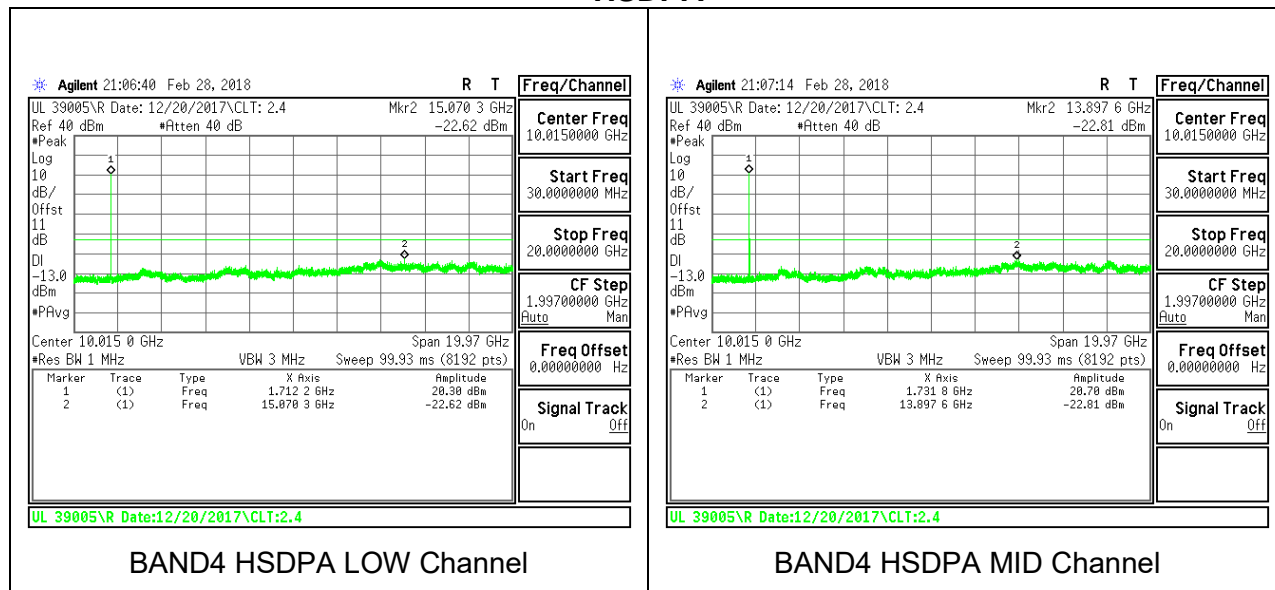

### 8.3.6. LTE BAND 4

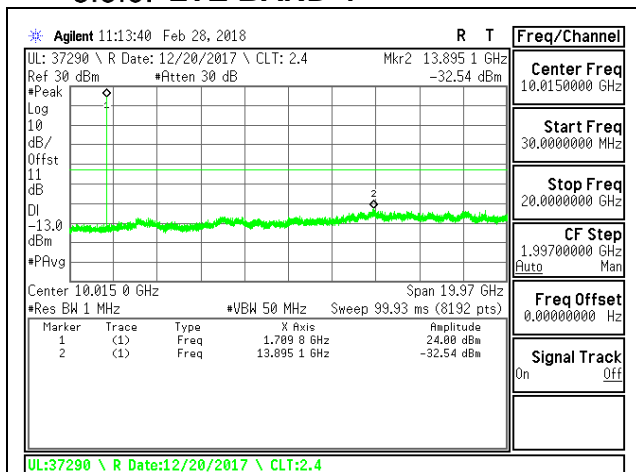

LTE B4 1.4MHz QPSK Low Channel RB1-0

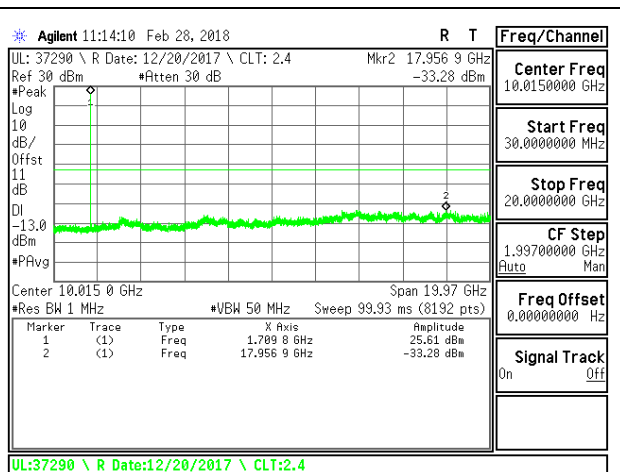

LTE B4 1.4MHz 16QAM Low Channel RB1-0

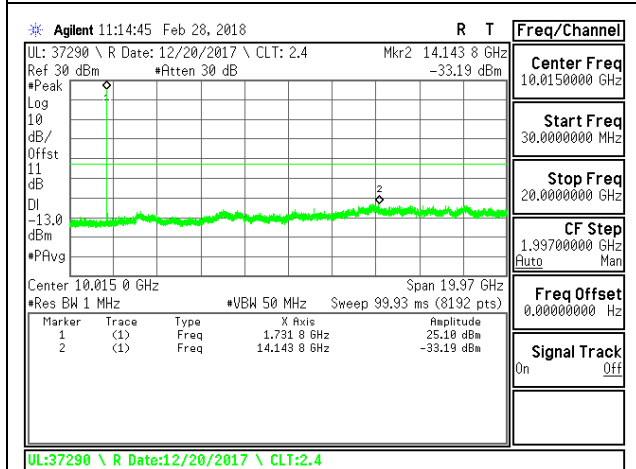

LTE B4 1.4MHz QPSK Middle Channel RB1-0

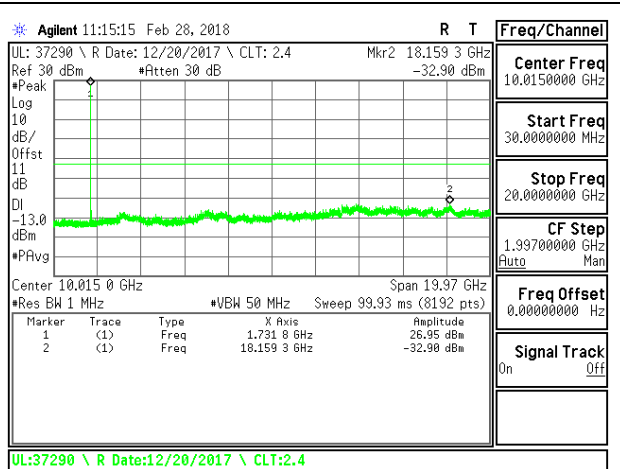

LTE B4 1.4MHz 16QAM Middle Channel RB1-0

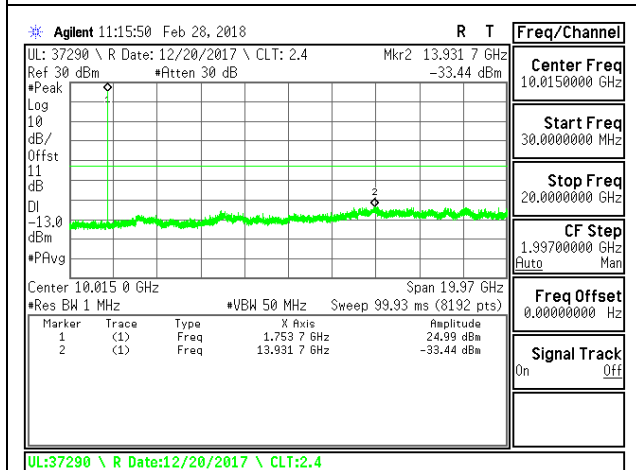

LTE B4 1.4MHz QPSK High Channel RB1-0

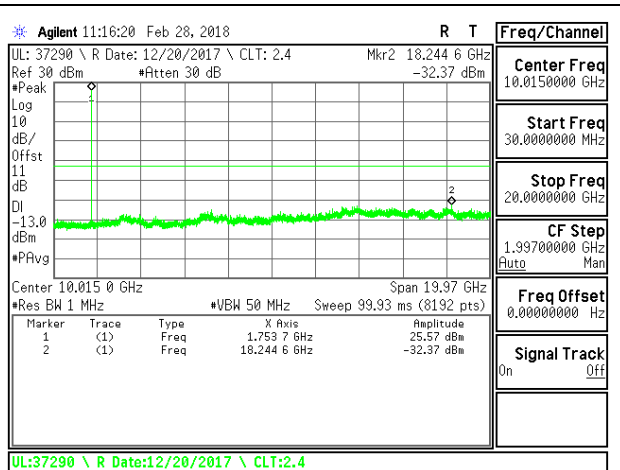

LTE B4 1.4MHz 16QAM High Channel RB1-0

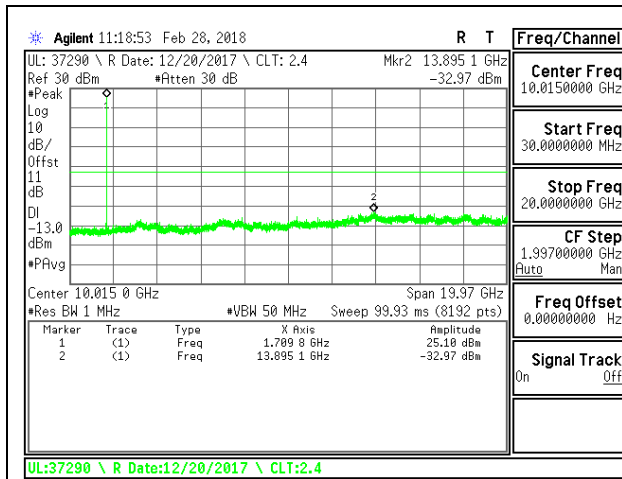

LTE B4 3MHz QPSK Low Channel RB1-0

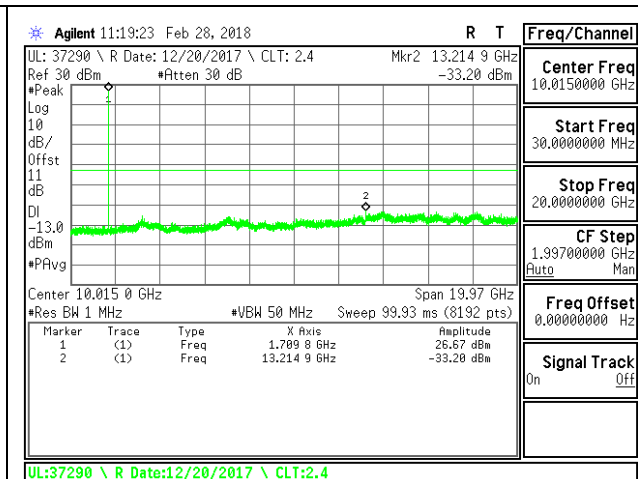

LTE B4 3MHz 16QAM Low Channel RB1-0

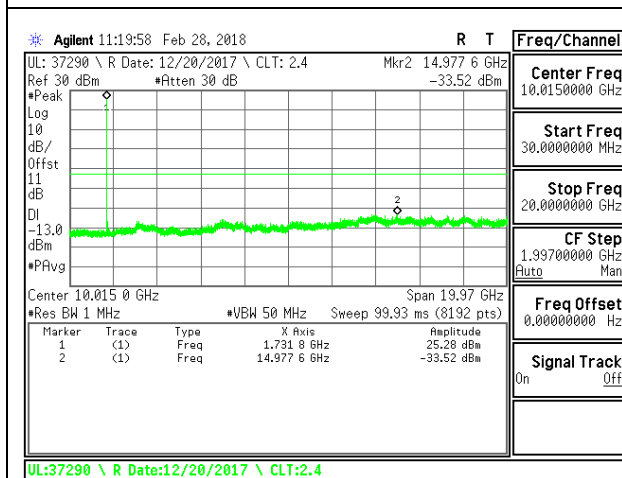

LTE B4 3MHz QPSK Middle Channel RB1-0

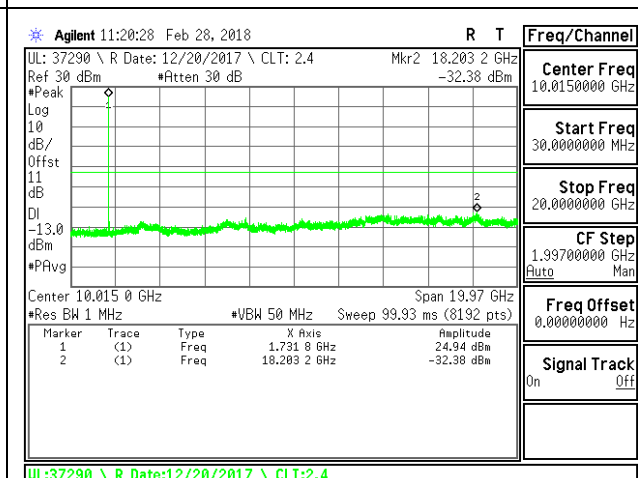

LTE B4 3MHz 16QAM Middle Channel RB1-0

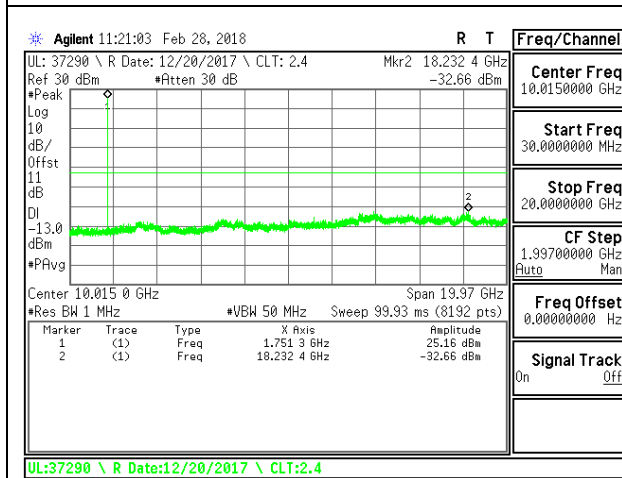

LTE B4 3MHz QPSK High Channel RB1-0

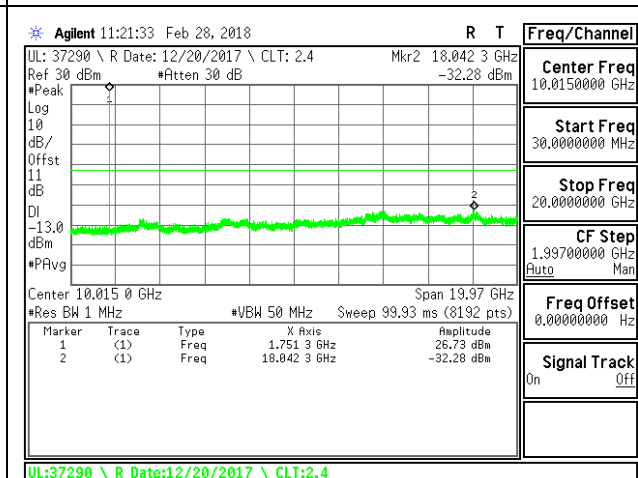

LTE B4 3MHz 16QAM High Channel RB1-0

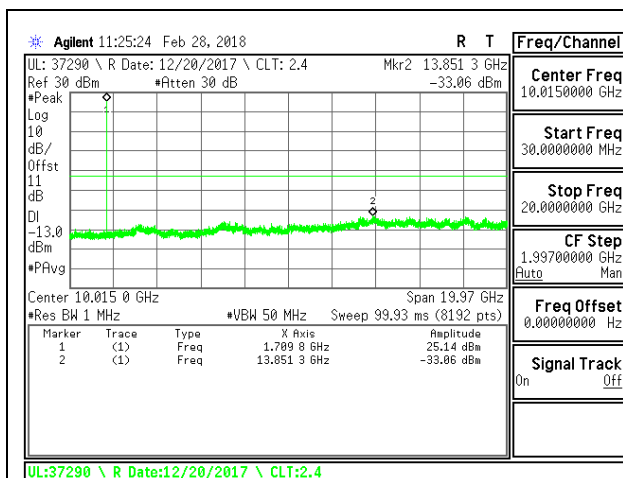

LTE B4 5MHz QPSK Low Channel RB1-0

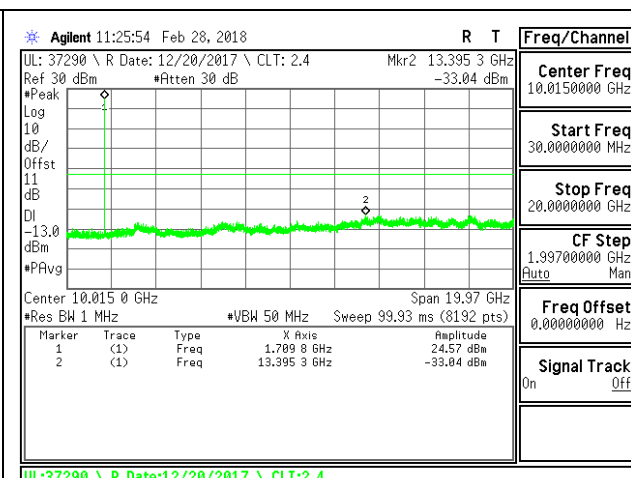

LTE B4 5MHz 16QAM Low Channel RB1-0

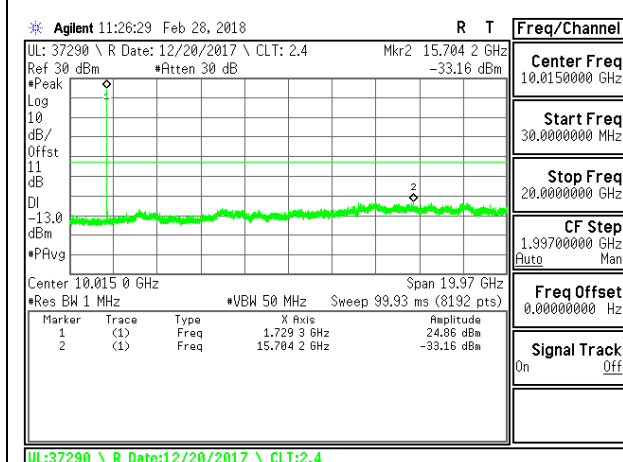

LTE B4 5MHz QPSK Middle Channel RB1-0

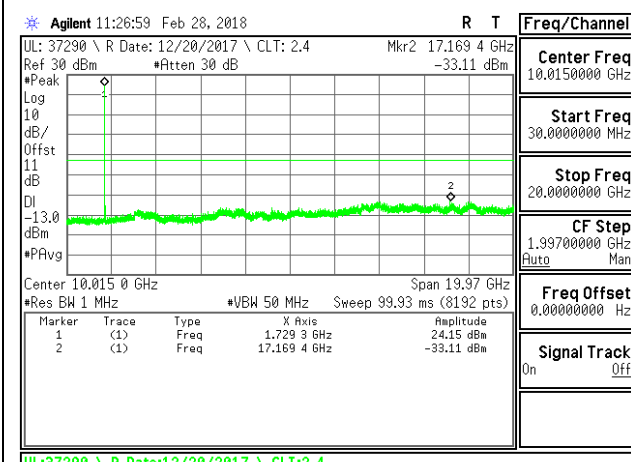

LTE B4 5MHz 16QAM Middle Channel RB1-0

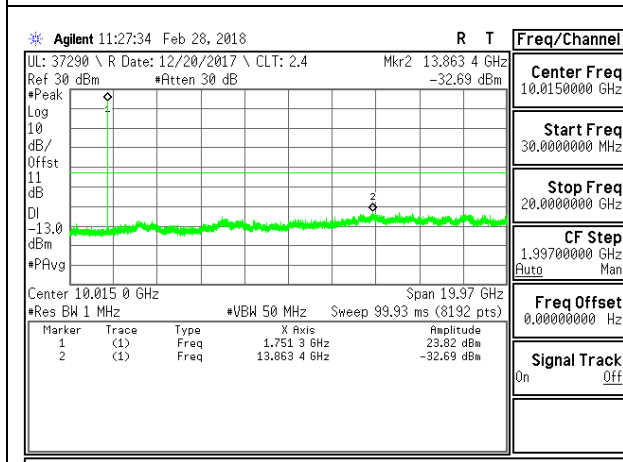

LTE B4 5MHz QPSK High Channel RB1-0

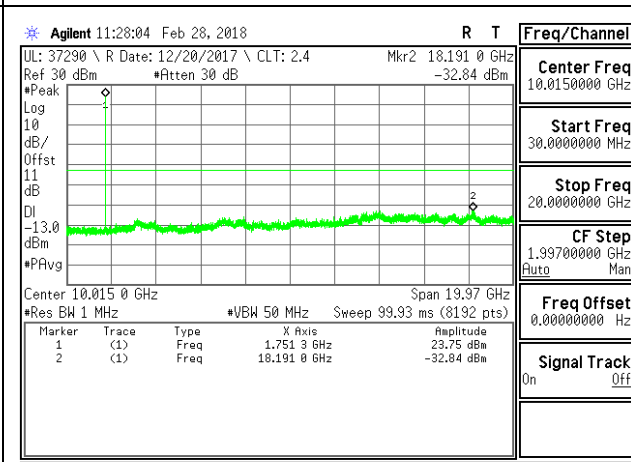

LTE B4 5MHz 16QAM High Channel RB1-0

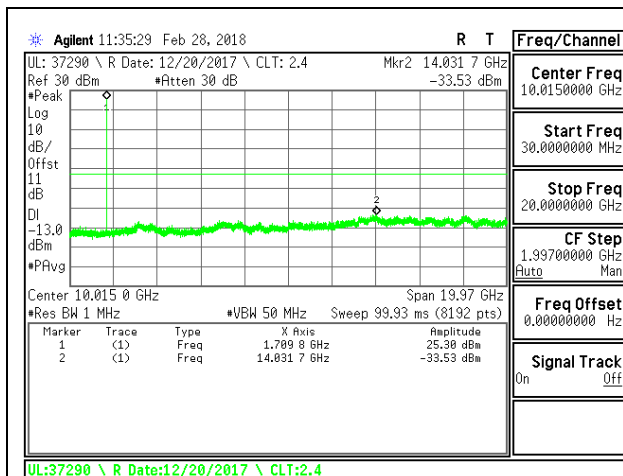

LTE B4 10MHz QPSK Low Channel RB1-0

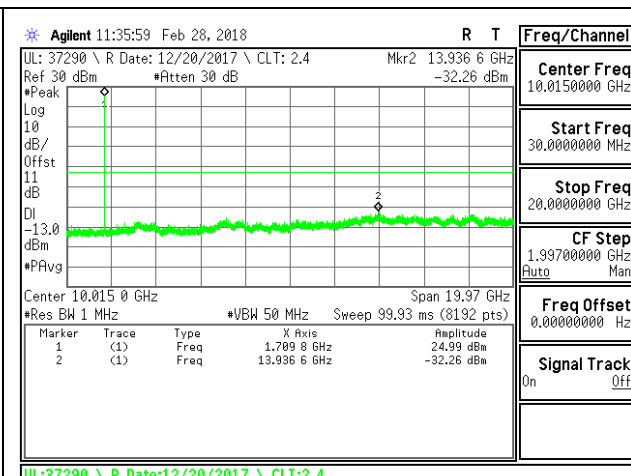

LTE B4 10MHz 16QAM Low Channel RB1-0

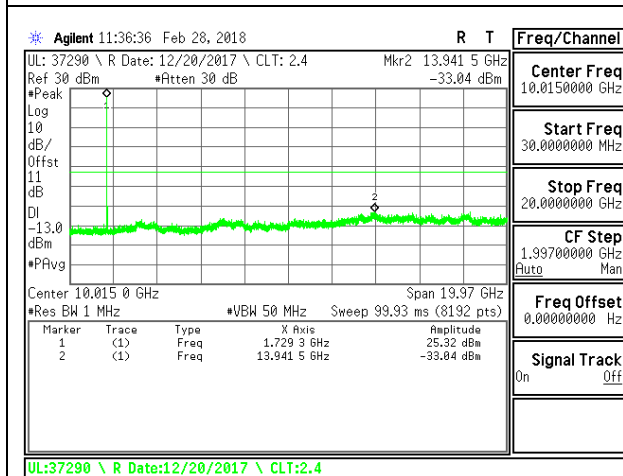

LTE B4 10MHz QPSK Middle Channel RB1-0

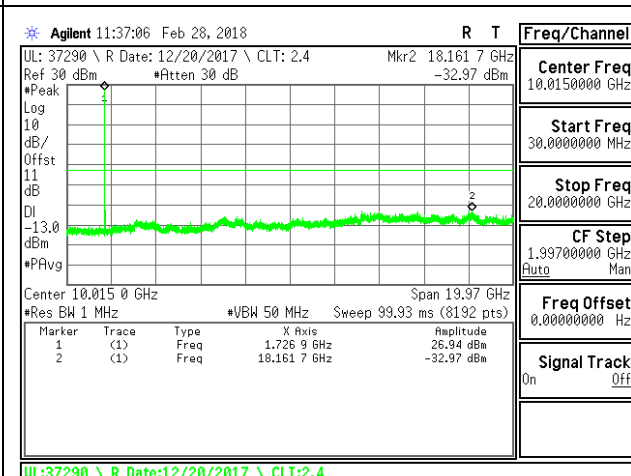

LTE B4 10MHz 16QAM Middle Channel RB1-0

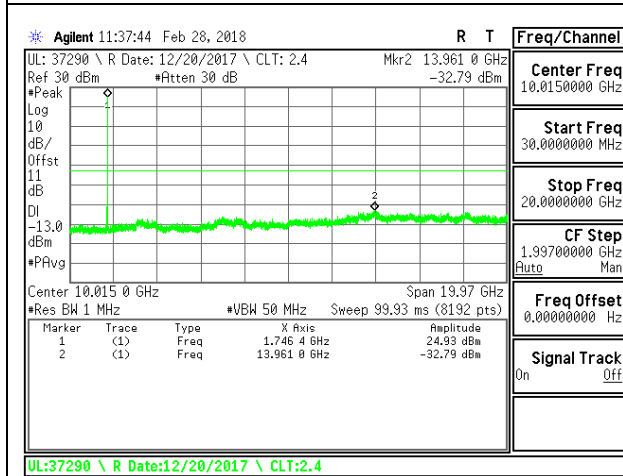

LTE B4 10MHz QPSK High Channel RB1-0

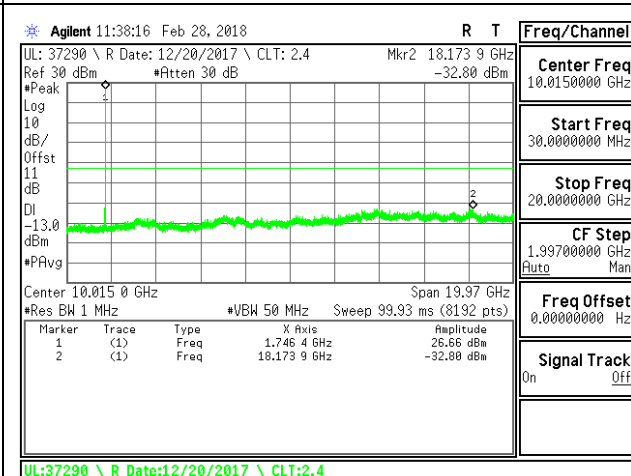

LTE B4 10MHz 16QAM High Channel RB1-0