



# FCC RF Test Report

**APPLICANT** : Sony Mobile Communications Inc.  
**EQUIPMENT** : GSM/WCDMA/LTE Phone+Bluetooth, DTS/UNII  
a/b/g/n and NFC  
**BRAND NAME** : Sony  
**FCC ID** : PY7-84773W  
**STANDARD** : FCC Part 15 Subpart E §15.407  
**CLASSIFICATION** : (NII) Unlicensed National Information Infrastructure

The product was received on Sep. 22, 2016 and testing was completed on Oct. 17, 2016. We, SPORTON INTERNATIONAL INC., would like to declare that the tested sample has been evaluated in accordance with the test procedures and has been in compliance with the applicable technical standards.

The test results in this report apply exclusively to the tested model / sample. Without written approval of SPORTON INTERNATIONAL INC., the test report shall not be reproduced except in full.

Reviewed by: Joseph Lin / Supervisor

Approved by: Jones Tsai / Manager



## SPORTON INTERNATIONAL INC.

No. 52, Hwa Ya 1<sup>st</sup> Rd., Hwa Ya Technology Park, Kwei-Shan District, Tao Yuan City, Taiwan, R.O.C.

SPORTON INTERNATIONAL INC.

TEL : 886-3-327-3456

FAX : 886-3-328-4978

FCC ID : PY7-84773W

Page Number : 1 of 34

Report Issued Date : Feb. 06, 2017

Report Version : Rev. 01

Report Template No.: BU5-FR15EWLB4 AC MA Version 1.4



# TABLE OF CONTENTS

**REVISION HISTORY ..... 3**

**SUMMARY OF TEST RESULT ..... 4**

**1 GENERAL DESCRIPTION ..... 5**

    1.1 Applicant ..... 5

    1.2 Manufacturer ..... 5

    1.3 Product Feature of Equipment Under Test ..... 5

    1.4 Modification of EUT ..... 6

    1.5 Testing Location ..... 7

    1.6 Applicable Standards ..... 8

**2 TEST CONFIGURATION OF EQUIPMENT UNDER TEST ..... 9**

    2.1 Carrier Frequency and Channel ..... 9

    2.2 Test Mode ..... 10

    2.3 Connection Diagram of Test System ..... 11

    2.4 Support Unit used in test configuration and system ..... 12

    2.5 EUT Operation Test Setup ..... 12

    2.6 Measurement Results Explanation Example ..... 12

**3 TEST RESULT ..... 13**

    3.1 6dB and 26dB and 99% Occupied Bandwidth Measurement ..... 13

    3.2 Maximum Conducted Output Power Measurement ..... 16

    3.3 Power Spectral Density Measurement ..... 17

    3.4 Unwanted Emissions Measurement ..... 20

    3.5 AC Conducted Emission Measurement ..... 25

    3.6 Frequency Stability Measurement ..... 29

    3.7 Automatically Discontinue Transmission ..... 30

    3.8 Antenna Requirements ..... 31

**4 LIST OF MEASURING EQUIPMENT ..... 32**

**5 UNCERTAINTY OF EVALUATION ..... 34**

**APPENDIX A. CONDUCTED TEST RESULTS**

**APPENDIX B. RADIATED SPURIOUS EMISSION**

**APPENDIX C. RADIATED SPURIOUS EMISSION PLOTS**

**APPENDIX D. DUTY CYCLE PLOTS**





### SUMMARY OF TEST RESULT

Report Section	FCC Rule	Description	Limit	Result	Remark
3.1	15.403(i)	6dB, 26dB and 99% Occupied Bandwidth	> 500kHz	Pass	-
3.2	15.407(a)	Maximum Conducted Output Power	≤ 30 dBm	Pass	-
3.3	15.407(a)	Power Spectral Density	≤ 30 dBm/500kHz	Pass	-
3.4	15.407(b)	Unwanted Emissions	15.407(b)(4)(i) & 15.209(a)	Pass	Under limit 6.73 dB at 5939.800 MHz
3.5	15.207	AC Conducted Emission	15.207(a)	Pass	Under limit 14.10 dB at 0.462 MHz
3.6	15.407(g)	Frequency Stability	Within Operation Band	Pass	-
3.7	15.407(c)	Automatically Discontinue Transmission	Discontinue Transmission	Pass	-
3.8	15.203 & 15.407(a)	Antenna Requirement	N/A	Pass	-



# 1 General Description

## 1.1 Applicant

Sony Mobile Communications Inc.  
4-12-3 Higashi-Shinagawa, Shinagawa-ku, Tokyo, 140-0002, Japan

## 1.2 Manufacturer

Sony Mobile Communications Inc.  
4-12-3 Higashi-Shinagawa, Shinagawa-ku, Tokyo, 140-0002, Japan

## 1.3 Product Feature of Equipment Under Test

GSM/WCDMA/LTE, Bluetooth, DTS/UNII, a/b/g/n, GPS, and NFC

Standards-related Product Specification	
Antenna Type / Gain	PIFA Antenna with gain -1.10 dBi

EUT Information List			
HW Version	SW Version	S/N	Performed Test Item
A	0.85	RQ3002HXPA	RF conducted measurement
		RQ3002HWLU	Radiated Spurious Emission
		RQ3002HWM1	Conducted Emission



Accessory List	
<b>AC Adapter 1</b>	Model No. : UCH20
	S/N :
	1215W48600011 (for radiated spurious emission) 1215W48600039 (for conducted emission)
<b>Earphone 1</b>	Model No. : MH410c
	S/N:
	1632A86300007A6 (for radiated spurious emission) 1632A8640000088 (for conducted emission)
<b>USB Cable</b>	Model No. : UCB20
	S/N :
	1625A912000332E (for radiated spurious emission) 1625A91900007E2 (for conducted emission)

**Note:**

1. Above EUT list and accessory list used are electrically identical per declared by manufacturer.
2. Above the accessories list are used to exercise the EUT during test.
3. For other wireless features of this EUT, test report will be issued separately.

### 1.4 Modification of EUT

No modifications are made to the EUT during all test items.



### 1.5 Testing Location

Sporton Lab is accredited to ISO 17025 by Taiwan Accreditation Foundation (TAF code : 1190) and the FCC designation No. TW1022 under the FCC 2.948(e) by Mutual Recognition Agreement (MRA) in FCC Test.

<b>Test Site</b>	SPORTON INTERNATIONAL INC.	
<b>Test Site Location</b>	No. 52, Hwa Ya 1 <sup>st</sup> Rd., Hwa Ya Technology Park, Kwei-Shan District, Tao Yuan City, Taiwan, R.O.C. TEL: +886-3-327-3456 FAX: +886-3-328-4978	
<b>Test Site No.</b>	<b>Sporton Site No.</b>	
	TH05-HY	CO05-HY

**Note:** The test site complies with ANSI C63.4 2014 requirement.

<b>Test Site</b>	SPORTON INTERNATIONAL INC.	
<b>Test Site Location</b>	No.58, Aly. 75, Ln. 564, Wenhua 3rd Rd. Guishan Dist, Taoyuan City, Taiwan (R.O.C.) TEL: +886-3-327-0868 FAX: +886-3-327-0855	
<b>Test Site No.</b>	<b>Sporton Site No.</b>	
	03CH12-HY	

**Note:** The test site complies with ANSI C63.4 2014 requirement.



## 1.6 Applicable Standards

According to the specifications of the manufacturer, the EUT must comply with the requirements of the following standards:

- ♦ FCC Part 15 Subpart E
- ♦ FCC KDB 789033 D02 General UNII Test Procedures New Rules v01r03
- ♦ ANSI C63.10-2013

### **Remark:**

1. All test items were verified and recorded according to the standards and without any deviation during the test.
2. This EUT has also been tested and complied with the requirements of FCC Part 15, Subpart B, recorded in a separate test report.





## 2 Test Configuration of Equipment Under Test

The EUT has been associated with peripherals and configuration operated in a manner tended to maximize its emission characteristics in a typical application. Frequency range investigated: conducted emission (150 kHz to 30 MHz) and radiated emission (9 kHz to the 10th harmonic of the highest fundamental frequency or to 40 GHz, whichever is lower). For radiated measurement, pre-scanned in three orthogonal panels, X, Y, Z. The worst cases (Y plane) were recorded in this report.

### 2.1 Carrier Frequency and Channel

Frequency Band	Channel	Freq. (MHz)	Channel	Freq. (MHz)
5725-5850 MHz Band 4 (U-NII-3)	149	5745	157	5785
	151*	5755	159*	5795
	153	5765	161	5805
	-	-	165	5825

**Note:** The above Frequency and Channel in "\*" were 802.11n HT40.



## 2.2 Test Mode

Final test mode of conducted test items and radiated spurious emissions are considering the modulation and worse data rates as below table.

Modulation	Data Rate
802.11a	6 Mbps
802.11n HT20	MCS0
802.11n HT40	MCS0

<b>AC Conducted Emission</b>	Mode 1 : GSM1900 Idle + Bluetooth Link + WLAN (5GHz) Link + MP3 + Earphone 1 + Battery + USB Cable (Charging from Adapter 1)
------------------------------	--

Ch. #		Band IV : 5725-5850 MHz		
		802.11a	802.11n HT20	802.11n HT40
L	Low	149	149	151
M	Middle	157	157	-
H	High	165	165	159

Ch. #		Band IV : 5725-5850 MHz		
		802.11ac VHT20	802.11ac VHT40	802.11ac VHT80
L	Low	149	151	-
M	Middle	157	-	155
H	High	165	159	-

## 2.3 Connection Diagram of Test System

<WLAN Tx Mode>

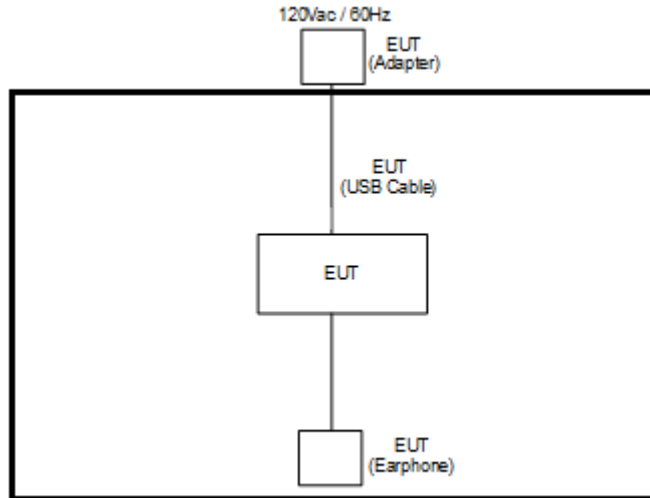

<AC Conducted Emission Mode>

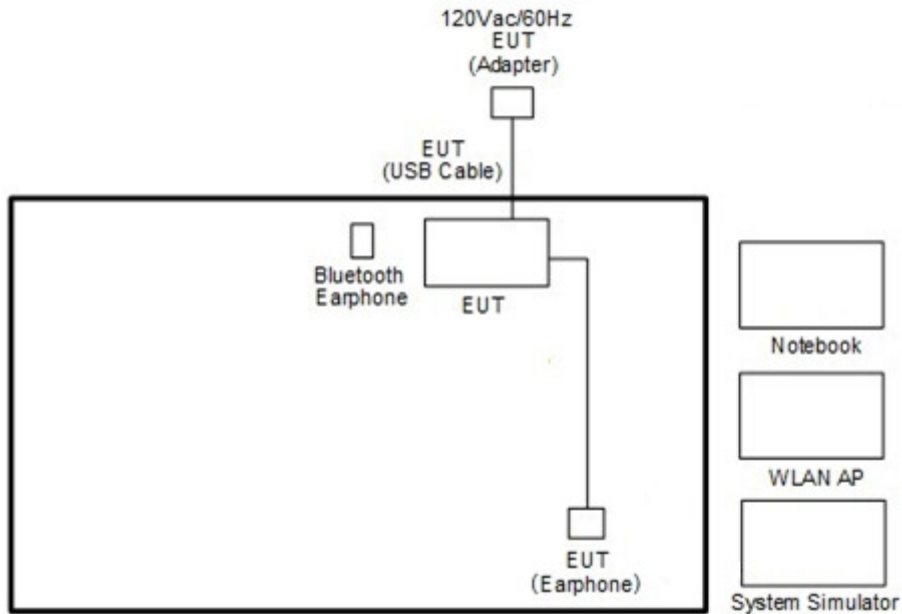



## 2.4 Support Unit used in test configuration and system

Item	Equipment	Trade Name	Model Name	FCC ID	Data Cable	Power Cord
1.	System Simulator	Anritsu	MT8820C	N/A	N/A	Unshielded, 1.8 m
2.	WLAN AP	ASUS	RT-AC66U	MSQ-RTAC66U	N/A	Unshielded, 1.8m
3.	Notebook	DELL	Latitude E6320	FCC DoC/ Contains FCC ID: QDS-BRCM1054	N/A	AC I/P: Unshielded, 1.2 m DC O/P: Shielded, 1.8 m
4.	Bluetooth Earphone	Sony	SBH20	PY7-RD0010	N/A	N/A
5.	SD Card	SanDisk	MicroSD HC	FCC DoC	N/A	N/A

## 2.5 EUT Operation Test Setup

For RF test items, an engineering test program was provided and enabled to make EUT transmitting signals.

## 2.6 Measurement Results Explanation Example

**For all conducted test items:**

The offset level is set in the spectrum analyzer to compensate the RF cable loss and attenuator factor between EUT conducted output port and spectrum analyzer. With the offset compensation, the spectrum analyzer reading level is exactly the EUT RF output level.

Example :

The spectrum analyzer offset is derived from RF cable loss and attenuator factor.

*Offset = RF cable loss + attenuator factor.*

Following shows an offset computation example with cable loss 4.2 dB and 10dB attenuator.

$$\begin{aligned} \text{Offset(dB)} &= \text{RF cable loss(dB)} + \text{attenuator factor(dB)}. \\ &= 4.2 + 10 = 14.2 \text{ (dB)} \end{aligned}$$

### 3 Test Result

#### 3.1 6dB and 26dB and 99% Occupied Bandwidth Measurement

##### 3.1.1 Description of 6dB and 26dB and 99% Occupied Bandwidth

The minimum 6 dB bandwidth shall be at least 500 kHz.

26dB and 99% Occupied bandwidth are reporting only.

##### 3.1.2 Measuring Instruments

The measuring equipment is listed in the section 4 of this test report.

##### 3.1.3 Test Procedures

1. The testing follows FCC KDB 789033 D02 General UNII Test Procedures New Rules v01r03.  
Section C) Emission bandwidth for the band 5.725-5.85GHz
2. Set RBW = 100kHz.
3. Set the VBW  $\geq 3 \times$  RBW.
4. Detector = Peak.
5. Trace mode = max hold
6. Measure the maximum width of the emission that is 6 dB down from the peak of the emission.
7. Measure and record the results in the test report.

##### 3.1.4 Test Setup

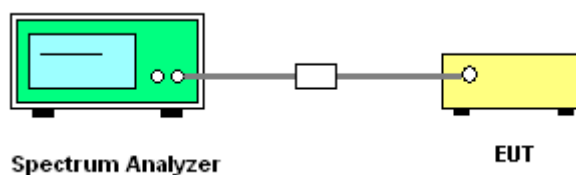



### 3.1.5 Test Result of 6dB Bandwidth

Please refer to Appendix A.

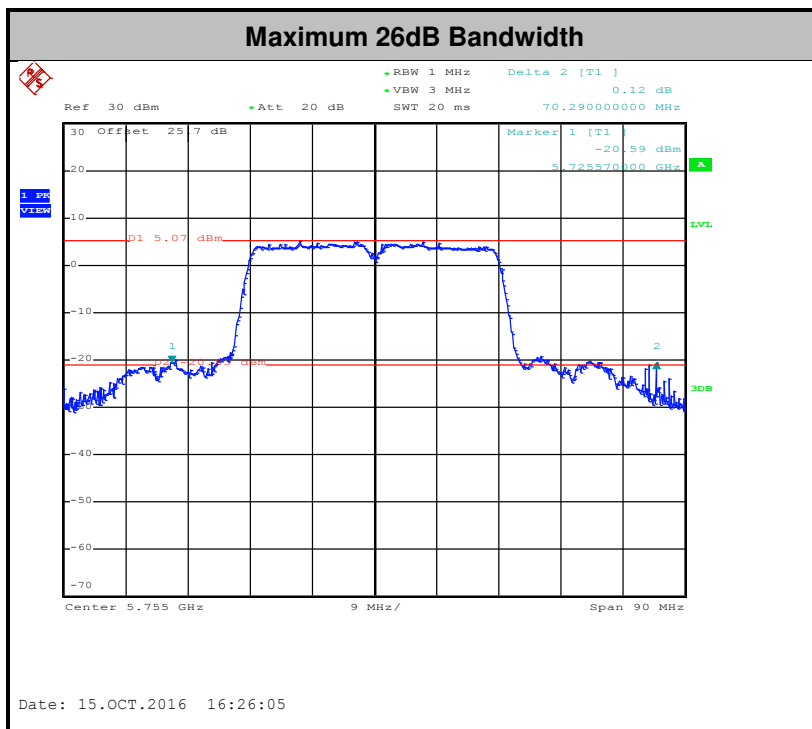
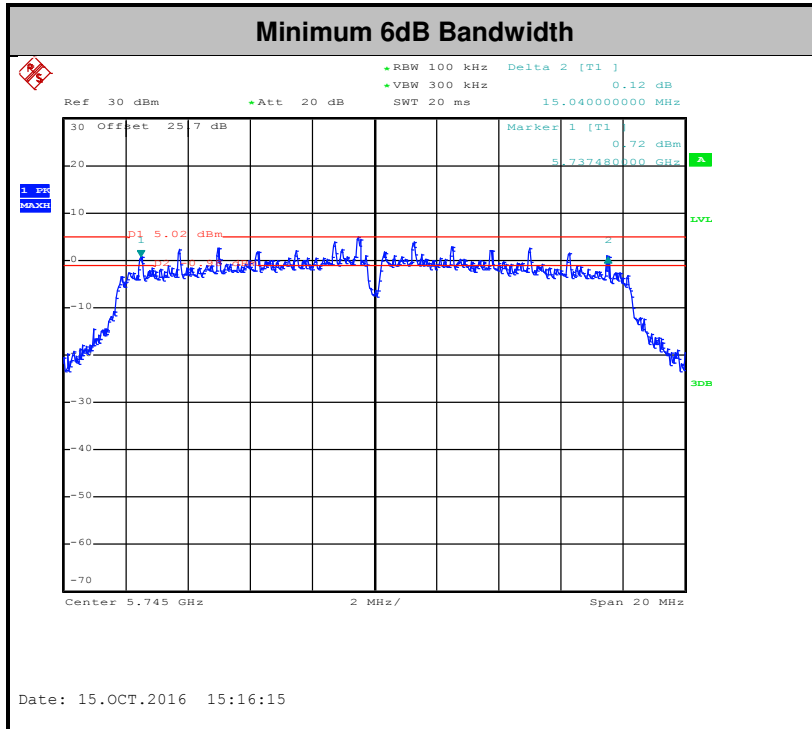

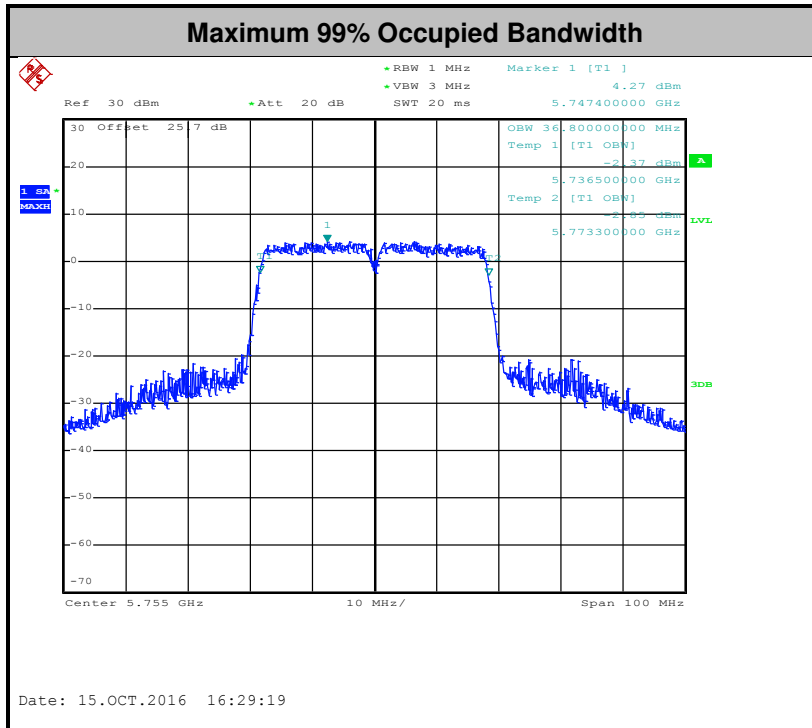

**Note:** The occupied channel bandwidth is maintained within the band of operation for all of the modulations.

## 3.2 Maximum Conducted Output Power Measurement

### 3.2.1 Limit of Maximum Conducted Output Power

For the band 5.725–5.85 GHz, the maximum conducted output power over the frequency band of operation shall not exceed 1 W.

If transmitting antennas of directional gain greater than 6 dBi are used, the peak output power shall be reduced by the amount in dB that the directional gain of the antenna exceeds 6 dBi.

### 3.2.2 Measuring Instruments

The measuring equipment is listed in the section 4 of this test report.

### 3.2.3 Test Procedures

The testing follows Method PM of FCC KDB 789033 D02 General UNII Test Procedures New Rules v01r03.

Method PM (Measurement using an RF average power meter):

1. Measurement is performed using a wideband RF power meter.
2. The EUT is configured to transmit continuously with a consistent duty cycle at its maximum power control level.
3. Measure the average power of the transmitter, and the average power is corrected with duty factor,  $10 \log(1/x)$ , where  $x$  is the duty cycle.

### 3.2.4 Test Setup

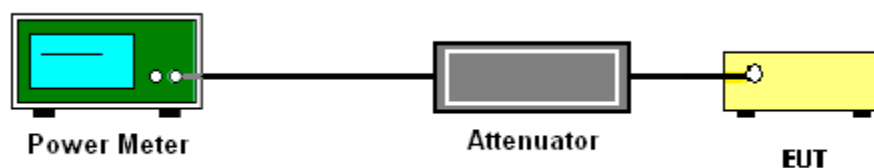

### 3.2.5 Test Result of Maximum Conducted Output Power

Please refer to Appendix A.





### 3.3 Power Spectral Density Measurement

#### 3.3.1 Limit of Power Spectral Density

For the band 5.725–5.85 GHz, the maximum power spectral density shall not exceed 30 dBm in any 500-kHz band.

If transmitting antennas of directional gain greater than 6 dBi are used, the peak output power shall be reduced by the amount in dB that the directional gain of the antenna exceeds 6 dBi.

#### 3.3.2 Measuring Instruments

The measuring equipment is listed in the section 4 of this test report.

#### 3.3.3 Test Procedures

The testing follows FCC KDB 789033 D02 General UNII Test Procedures New Rules v01r03. Section F) Maximum power spectral density.

##### # Method SA-2 #

(trace averaging across on and off times of the EUT transmissions, followed by duty cycle correction).

1. The testing follows Method SA-2 of FCC KDB 789033 D02 General UNII Test Procedures New Rules v01r02.
  - Measure the duty cycle.
  - Set span to encompass the entire emission bandwidth (EBW) of the signal.
  - Set RBW = 300 kHz.
  - Set VBW  $\geq$  1 MHz.
  - Number of points in sweep  $\geq$  2 Span / RBW.
  - Sweep time = auto.
  - Detector = RMS
  - Trace average at least 100 traces in power averaging mode.
  - Add  $10 \log(500\text{kHz}/\text{RBW})$  to the test result.
  - Add  $10 \log(1/x)$ , where x is the duty cycle, to the measured power in order to compute the average power during the actual transmission times. For example, add  $10 \log(1/0.25) = 6$  dB if the duty cycle is 25 percent.

2. The RF output of EUT was connected to the spectrum analyzer by a low loss cable.
3. Each plot has already offset with cable loss, and attenuator loss. Measure the PPSD and record it.
4. For MIMO mode, calculation method follows FCC KDB 662911 D01 Multiple Transmitter Output v02r01.

Method (c): Measure and add  $10 \log(N_{\text{ANT}})$  dB.

With this technique, spectrum measurements are performed at each output of the device, but rather than summing the spectra or the spectral peaks across the outputs, the quantity  $10 \log(N_{\text{ANT}})$  dB is added to each spectrum value before comparing to the emission limit. The addition of  $10 \log(N_{\text{ANT}})$  dB serves to apportion the emission limit among the  $N_{\text{ANT}}$  outputs so that each output is permitted to contribute no more than  $1/N_{\text{ANT}}^{\text{th}}$  of the PSD limit.

### 3.3.4 Test Setup

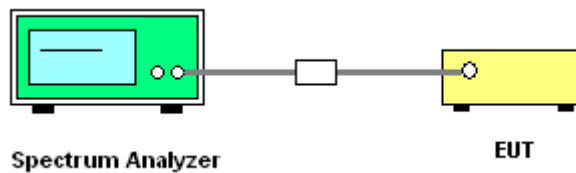



### 3.3.5 Test Result of Power Spectral Density

Please refer to Appendix A.

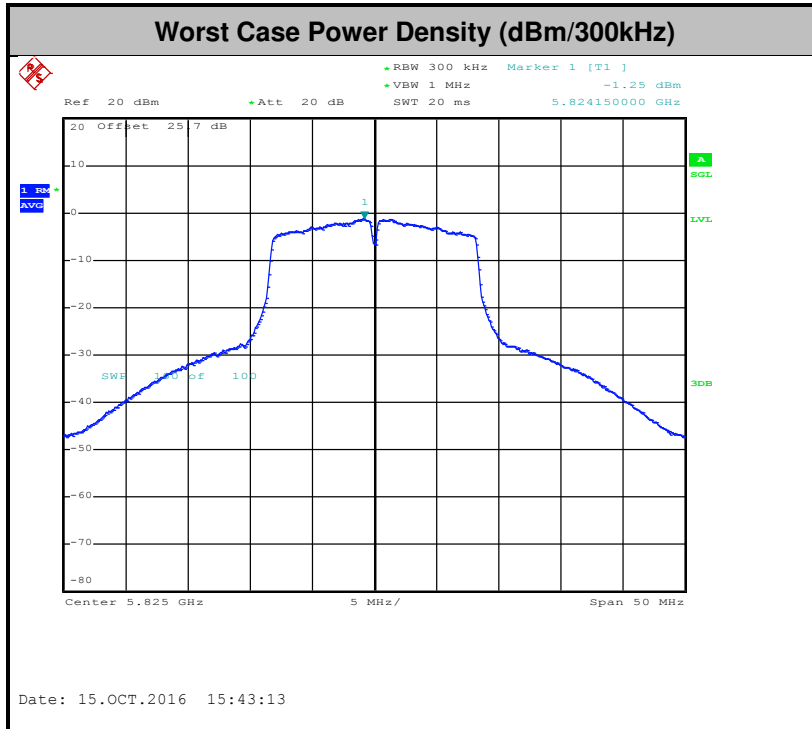



### 3.4 Unwanted Emissions Measurement

This section as specified in FCC Part 15.407(b) is to measure unwanted emissions through radiated measurement for band edge spurious emissions and out of band emissions measurement. The unwanted emissions shall comply with 15.407(b)(1) to (6), and restricted bands per FCC Part15.205.

#### 3.4.1 Limit of Unwanted Emissions

(1) For transmitters operating in the 5.725-5.85 GHz band:

15.407(b)(4)(i) All emissions shall be limited to a level of -27 dBm/MHz at 75 MHz or more above or below the band edge increasing linearly to 10 dBm/MHz at 25 MHz above or below the band edge, and from 25 MHz above or below the band edge increasing linearly to a level of 15.6 dBm/MHz at 5 MHz above or below the band edge, and from 5 MHz above or below the band edge increasing linearly to a level of 27 dBm/MHz at the band edge.

(2) Unwanted spurious emissions fallen in restricted bands per FCC Part15.205 shall comply with the general field strength limits set forth in § 15.209 as below table,

Frequency (MHz)	Field Strength (microvolts/meter)	Measurement Distance (meters)
0.009 – 0.490	2400/F(kHz)	300
0.490 – 1.705	24000/F(kHz)	30
1.705 – 30.0	30	30
30 – 88	100	3
88 – 216	150	3
216 - 960	200	3
Above 960	500	3

**Note:** The following formula is used to convert the EIRP to field strength.

$$E = \frac{1000000\sqrt{30P}}{3} \mu\text{V/m, where P is the eirp (Watts)}$$



EIRP (dBm)	Field Strength at 3m (dBµV/m)
-17	78.3
- 27	68.3

(3) KDB 789033 D02 General UNII Test Procedures New Rules v01r03 G)2)c) As specified in 15.407(b), emissions above 1000 MHz that are outside of the restricted bands are subject to a peak emission limit of -27 dBm/MHz (or -17 dBm/MHz as specified in 15.407(b)(4)). However, an out-of-band emission that complies with both the average and peak limits of 15.209 is not required to satisfy the -27 dBm/MHz or -17 dBm/MHz peak emission limit.

### 3.4.2 Measuring Instruments

The measuring equipment is listed in the section 4 of this test report.

### 3.4.3 Test Procedures

1. The testing follows FCC KDB 789033 D02 General UNII Test Procedures New Rules v01r03. Section G) Unwanted emissions measurement.

(1) Procedure for Unwanted Emissions Measurements Below 1000MHz

- RBW = 120 kHz
- VBW = 300 kHz
- Detector = Peak
- Trace mode = max hold

(2) Procedure for Peak Unwanted Emissions Measurements Above 1000 MHz

- RBW = 1 MHz
- VBW ≥ 3 MHz
- Detector = Peak
- Sweep time = auto
- Trace mode = max hold

(3) Procedures for Average Unwanted Emissions Measurements Above 1000MHz

- RBW = 1 MHz
- VBW = 10 Hz, when duty cycle is no less than 98 percent.
- VBW ≥ 1/T, when duty cycle is less than 98 percent where T is the minimum transmission duration over which the transmitter is on and is transmitting at its maximum power control level for the tested mode of operation.

2. The EUT was placed on a turntable with 0.8 meter for frequency below 1GHz and 1.5 meter for frequency above 1GHz respectively above ground.
3. The EUT was set 3 meters from the interference receiving antenna which was mounted on the top of a variable height antenna tower.
4. The antenna is a broadband antenna and its height is adjusted between one meter and four meters above ground to find the maximum value of the field strength for both horizontal polarization and vertical polarization of the antenna.
5. For each suspected emission, the EUT was arranged to its worst case and then adjust the antenna tower (from 1 m to 4 m) and turntable (from 0 degree to 360 degrees) to find the maximum reading.
6. For testing below 1GHz, if the emission level of the EUT in peak mode was 3 dB lower than the limit specified, then peak values of EUT will be reported, otherwise, the emissions will be repeated one by one using the CISPR quasi-peak method and reported.
7. For testing above 1GHz, the emission level of the EUT in peak mode was 20dB lower than average limit (that means the emission level in average mode also complies with the limit in average mode), then peak values of EUT will be reported, otherwise, the emissions will be measured in average mode again and reported.

### 3.4.4 Test Setup

For radiated emissions below 30MHz

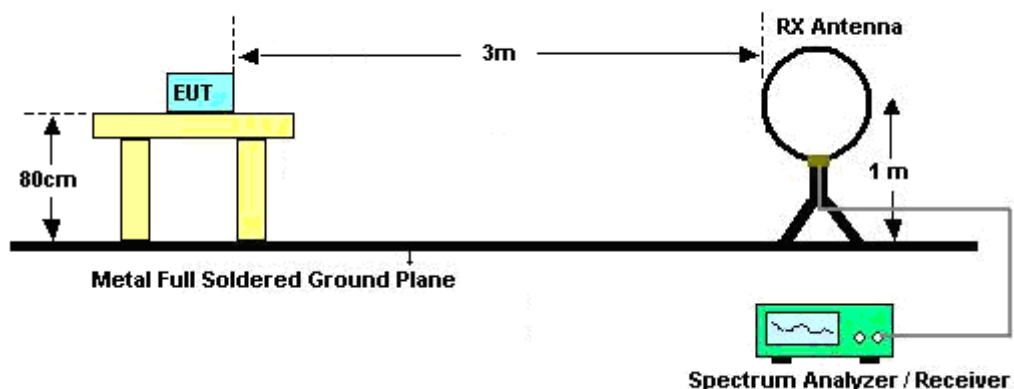

For radiated emissions from 30MHz to 1GHz

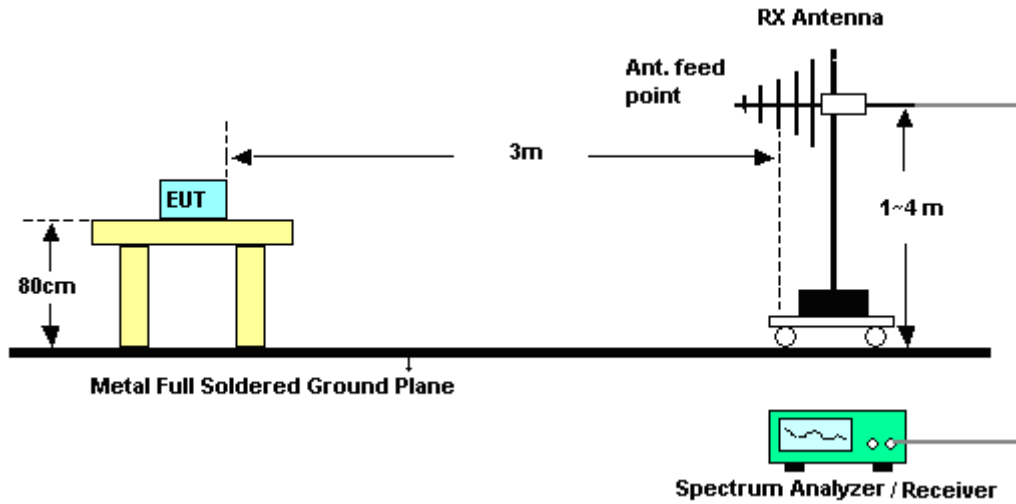

For radiated emissions above 1GHz

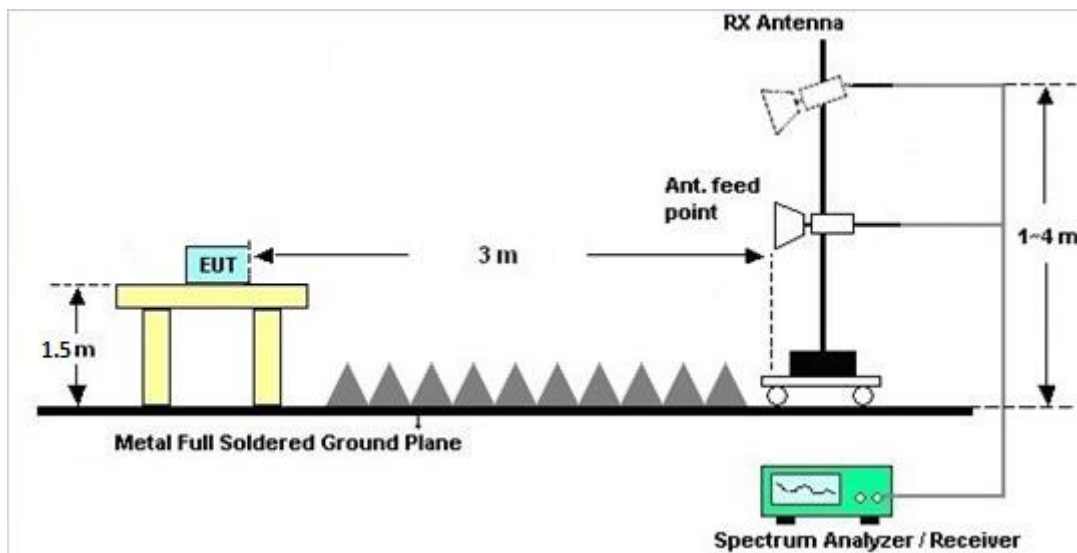



### **3.4.5 Test Results of Radiated Spurious Emissions (9 kHz ~ 30 MHz)**

The low frequency, which started from 9 kHz to 30MHz, was pre-scanned and the result which was 20dB lower than the limit line per 15.31(o) was not reported.

### **3.4.6 Test Result of Radiated Spurious at Band Edges**

Please refer to Appendix B and C.

### **3.4.7 Duty Cycle**

Please refer to Appendix D.

### **3.4.8 Test Result of Radiated Spurious Emissions (30MHz ~ 10th Harmonic)**

Please refer to Appendix B and C.





### 3.5 AC Conducted Emission Measurement

#### 3.5.1 Limit of AC Conducted Emission

For equipment that is designed to be connected to the public utility (AC) power line, the radio frequency voltage that is conducted back onto the AC power line on any frequency or frequencies within the band 150 kHz to 30 MHz shall not exceed the limits in the following table.

Frequency of emission (MHz)	Conducted limit (dB $\mu$ V)	
	Quasi-peak	Average
0.15-0.5	66 to 56*	56 to 46*
0.5-5	56	46
5-30	60	50

\*Decreases with the logarithm of the frequency.

#### 3.5.2 Measuring Instruments

The measuring equipment is listed in the section 4 of this test report.

#### 3.5.3 Test Procedures

1. The EUT was placed 0.4 meter from the conducting wall of the shielding room was kept at least 80 centimeters from any other grounded conducting surface.
2. Connect EUT to the power mains through a line impedance stabilization network (LISN).
3. All the support units are connecting to the other LISN.
4. The LISN provides 50 ohm coupling impedance for the measuring instrument.
5. The FCC states that a 50 ohm, 50 microhenry LISN should be used.
6. Both sides of AC line were checked for maximum conducted interference.
7. The frequency range from 150 kHz to 30 MHz was searched.
8. Set the test-receiver system to Peak Detect Function and specified bandwidth with Maximum Hold Mode.

### 3.5.4 Test Setup

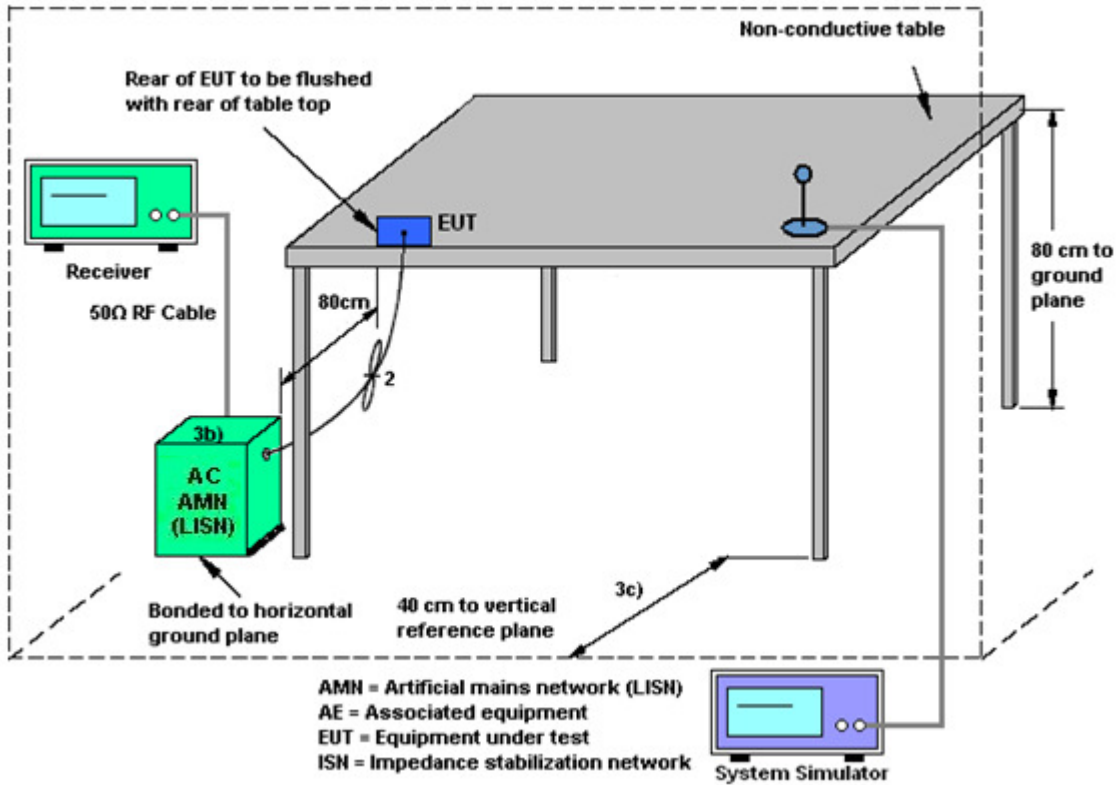



3.5.5 Test Result of AC Conducted Emission

Test Mode :	Mode 1	Temperature :	21~23°C
Test Engineer :	Arthur Hsieh	Relative Humidity :	51~53%
Test Voltage :	120Vac / 60Hz	Phase :	Line
Function Type :	GSM1900 Idle + Bluetooth Link + WLAN (5GHz) Link + MP3 + Earphone 1 + Battery + USB Cable (Charging from Adapter 1)		

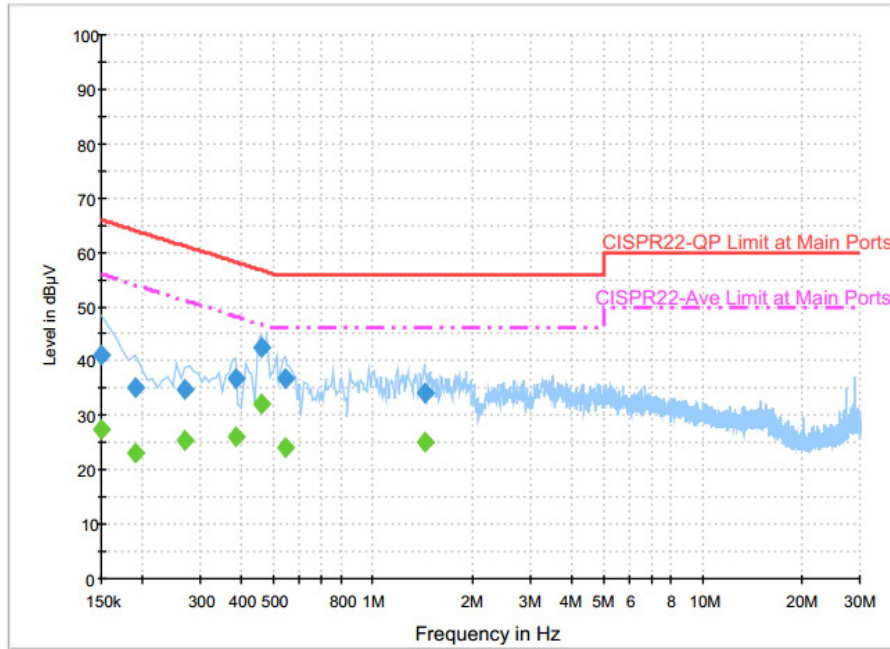

Final Result : QuasiPeak

Frequency (MHz)	QuasiPeak (dBµV)	Filter	Line	Corr. (dB)	Margin (dB)	Limit (dBµV)
0.150000	41.3	Off	L1	19.6	24.7	66.0
0.190000	35.1	Off	L1	19.6	28.9	64.0
0.270000	34.9	Off	L1	19.6	26.2	61.1
0.382000	36.7	Off	L1	19.6	21.5	58.2
0.462000	42.6	Off	L1	19.6	14.1	56.7
0.542000	36.7	Off	L1	19.6	19.3	56.0
1.438000	34.3	Off	L1	19.7	21.7	56.0

Final Result : Average

Frequency (MHz)	Average (dBµV)	Filter	Line	Corr. (dB)	Margin (dB)	Limit (dBµV)
0.150000	27.5	Off	L1	19.6	28.5	56.0
0.190000	23.2	Off	L1	19.6	30.8	54.0
0.270000	25.5	Off	L1	19.6	25.6	51.1
0.382000	26.2	Off	L1	19.6	22.0	48.2
0.462000	32.1	Off	L1	19.6	14.6	46.7
0.542000	24.2	Off	L1	19.6	21.8	46.0
1.438000	25.2	Off	L1	19.7	20.8	46.0



Test Mode :	Mode 1	Temperature :	21~23°C
Test Engineer :	Arthur Hsieh	Relative Humidity :	51~53%
Test Voltage :	120Vac / 60Hz	Phase :	Neutral
Function Type :	GSM1900 Idle + Bluetooth Link + WLAN (5GHz) Link + MP3 + Earphone 1 + Battery + USB Cable (Charging from Adapter 1)		

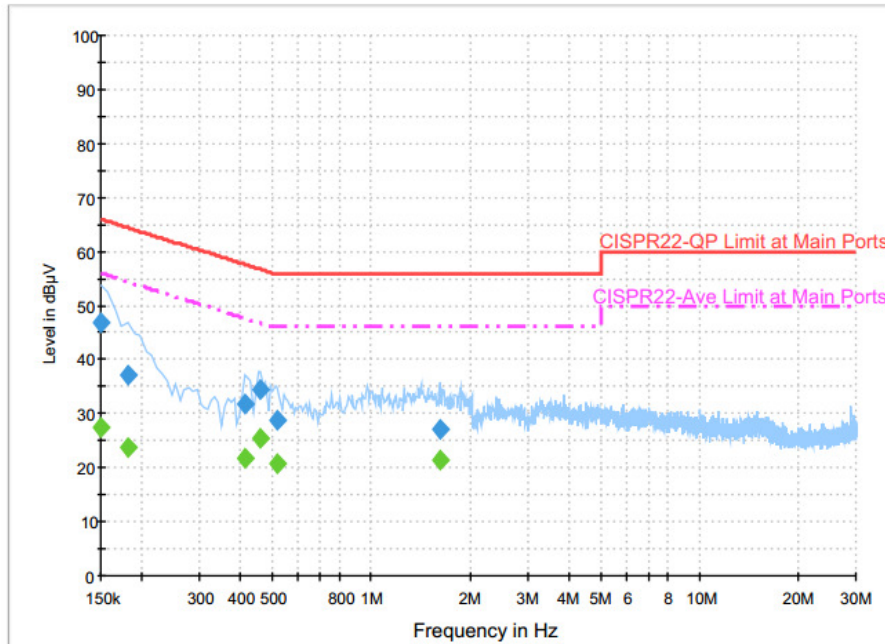

**Final Result : QuasiPeak**

Frequency (MHz)	QuasiPeak (dBµV)	Filter	Line	Corr. (dB)	Margin (dB)	Limit (dBµV)
0.150000	46.7	Off	N	19.6	19.3	66.0
0.182000	37.1	Off	N	19.6	27.3	64.4
0.414000	31.8	Off	N	19.6	25.8	57.6
0.462000	34.4	Off	N	19.6	22.3	56.7
0.518000	28.7	Off	N	19.6	27.3	56.0
1.622000	27.2	Off	N	19.7	28.8	56.0

**Final Result : Average**

Frequency (MHz)	Average (dBµV)	Filter	Line	Corr. (dB)	Margin (dB)	Limit (dBµV)
0.150000	27.6	Off	N	19.6	28.4	56.0
0.182000	23.6	Off	N	19.6	30.8	54.4
0.414000	21.9	Off	N	19.6	25.7	47.6
0.462000	25.5	Off	N	19.6	21.2	46.7
0.518000	20.6	Off	N	19.6	25.4	46.0
1.622000	21.3	Off	N	19.7	24.7	46.0

## 3.6 Frequency Stability Measurement

### 3.6.1 Limit of Frequency Stability

Manufacturers of U-NII devices are responsible for ensuring frequency stability such that an emission is maintained within the band of operation under all conditions of normal operation as specified in the user's manual.

### 3.6.2 Measuring Instruments

The measuring equipment is listed in the section 4 of this test report.

### 3.6.3 Test Procedures

1. To ensure emission at the band edge is maintained within the authorized band, those values shall be measured by radiation emissions at upper and lower frequency points, and finally compensated by frequency deviation as procedures below.
2. The EUT was operated at the maximum output power, and connected to the spectrum analyzer, which is set to maximum hold function and peak detector. The peak value of the power envelope was measured and noted. The upper and lower frequency points were respectively measured relatively 10dB lower than the measured peak value.
3. The frequency deviation was calculated by adding the upper frequency point and the lower frequency point divided by two. Those detailed values of frequency deviation are provided in table below.

### 3.6.4 Test Setup

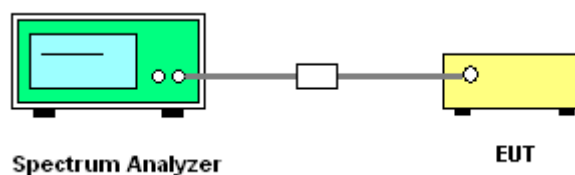

### 3.6.5 Test Result of Frequency Stability

Please refer to Appendix A.



## **3.7 Automatically Discontinue Transmission**

### **3.7.1 Limit of Automatically Discontinue Transmission**

The device shall automatically discontinue transmission in case of either absence of information to transmit or operational failure. These provisions are not intended to preclude the transmission of control or signaling information or the use of repetitive codes used by certain digital technologies to complete frame or burst intervals. Applicants shall include in their application for equipment authorization to describe how this requirement is met.

### **3.7.2 Measuring Instruments**

The measuring equipment is listed in the section 4 of this test report.

### **3.7.3 Test Result of Automatically Discontinue Transmission**

While the EUT is not transmitting any information, the EUT can automatically discontinue transmission and become standby mode for power saving. The EUT can detect the controlling signal of ACK message transmitting from remote device and verify whether it shall resend or discontinue transmission.



## **3.8 Antenna Requirements**

### **3.8.1 Standard Applicable**

According to FCC 47 CFR Section 15.407(a)(1)(2) ,if transmitting antenna directional gain is greater than 6 dBi, both the peak transmit power and the peak power spectral density shall be reduced by the amount in dB that the directional gain of the antenna exceeds 6 dBi.

### **3.8.2 Antenna Anti-Replacement Construction**

An embedded-in antenna design is used.

### **3.8.3 Antenna Gain**

The antenna gain is less than 6 dBi. Therefore, it is not necessary to reduce maximum peak output power limit.



## 4 List of Measuring Equipment

Instrument	Manufacturer	Model No.	Serial No.	Characteristics	Calibration Date	Test Date	Due Date	Remark
Spectrum Analyzer	Rohde & Schwarz	FSP40	100057	9kHz-40GHz	Nov. 23, 2015	Oct. 06, 2016 ~ Oct. 17, 2016	Nov. 22, 2016	Conducted (TH05-HY)
Power Meter	Anritsu	ML2495A	1240001	300MHz~40GHz	Sep. 07, 2016	Oct. 06, 2016 ~ Oct. 17, 2016	Sep. 06, 2017	Conducted (TH05-HY)
Power Sensor	Anritsu	MA2411B	1207349	300MHz~40GHz	Sep. 07, 2016	Oct. 06, 2016 ~ Oct. 17, 2016	Sep. 06, 2017	Conducted (TH05-HY)
Hygrometer	Testo	608-H2	41410069	N/A	Aug. 28, 2016	Oct. 06, 2016 ~ Oct. 17, 2016	Aug. 27, 2017	Conducted (TH05-HY)
RF Cable	HUBER + SUHNER	SUCOFLEX 104	MY84209521	1GHz~26GHz	Dec. 03, 2015	Oct. 06, 2016 ~ Oct. 17, 2016	Dec. 02, 2016	Conducted (TH05-HY)
Temperature Chamber	ESPEC	SH-641	92013720	-40°C ~90°C	Sep. 01, 2016	Oct. 06, 2016 ~ Oct. 17, 2016	Aug. 31, 2017	Conducted (TH05-HY)
AC Power Source	ChainTek	APC-1000W	N/A	N/A	N/A	Oct. 11, 2016	N/A	Conduction (CO05-HY)
EMI Test Receiver	Rohde & Schwarz	ESCI 7	100724	9kHz~7GHz	Aug. 30, 2016	Oct. 11, 2016	Aug. 29, 2017	Conduction (CO05-HY)
Hygrometer	Testo	608-H1	34913912	N/A	Apr. 19, 2016	Oct. 11, 2016	Apr. 18, 2017	Conduction (CO05-HY)
LISN	Rohde & Schwarz	ENV216	100080	9kHz~30MHz	Dec. 02, 2015	Oct. 11, 2016	Dec. 01, 2016	Conduction (CO05-HY)
LF Cable	HUBER + SUHNER	RG-214/U	LF01	N/A	Jan. 06, 2016	Oct. 11, 2016	Jan. 05, 2017	Conduction (CO05-HY)
Test Software	N/A	EMC32	8.40.0	N/A	N/A	Oct. 11, 2016	N/A	Conduction (CO05-HY)
Loop Antenna	Rohde & Schwarz	HFH2-Z2	100315	9 kHz~30 MHz	Sep. 02, 2015	Oct. 06, 2016 ~ Oct. 13, 2016	Sep. 01, 2017	Radiation (03CH12-HY)
Amplifier	SONOMA	310N	187312	9kHz~1GHz	Nov. 20, 2015	Oct. 06, 2016 ~ Oct. 13, 2016	Nov. 19, 2016	Radiation (03CH12-HY)
Bilog Antenna	TESEQ	CBL 6111D&N-6-06	35414&AT-N 0602	30MHz~1GHz	Nov. 17, 2015	Oct. 06, 2016 ~ Oct. 13, 2016	Nov. 16, 2016	Radiation (03CH12-HY)
Horn Antenna	SCHWARZBECK	BBHA 9120D	9120D-1328	1GHz ~ 18GHz	Nov. 02, 2015	Oct. 06, 2016 ~ Oct. 13, 2016	Nov. 01, 2016	Radiation (03CH12-HY)
SHF-EHF Horn Antenna	SCHWARZBECK	BBHA 9170	BBHA9170584	18GHz- 40GHz	Nov. 02, 2015	Oct. 06, 2016 ~ Oct. 13, 2016	Nov. 01, 2016	Radiation (03CH12-HY)
EMI Test Receiver	Rohde & Schwarz	ESU26	100390	20Hz~26.5GHz	Dec. 21, 2015	Oct. 06, 2016 ~ Oct. 13, 2016	Dec. 20, 2016	Radiation (03CH12-HY)
Spectrum Analyzer	Agilent	N9030A	MY52350276	3Hz~44GHz	Mar. 21, 2016	Oct. 06, 2016 ~ Oct. 13, 2016	Mar. 20, 2017	Radiation (03CH12-HY)
Preamplifier	MITEQ	TTA0204	1872107	2GHz~40GHz	Feb. 15, 2016	Oct. 06, 2016 ~ Oct. 13, 2016	Feb. 14, 2017	Radiation (03CH12-HY)
Preamplifier	MITEQ	AMF-7D-0010 1800-30-10P	1815698	1GHz~18GHz	Dec. 14, 2015	Oct. 06, 2016 ~ Oct. 13, 2016	Dec. 13, 2016	Radiation (03CH12-HY)
Preamplifier	Keysight	83017A	MY53270148	1GHz~26.5GHz	Jan. 30, 2016	Oct. 06, 2016 ~ Oct. 13, 2016	Jan. 29, 2017	Radiation (03CH12-HY)





Instrument	Manufacturer	Model No.	Serial No.	Characteristics	Calibration Date	Test Date	Due Date	Remark
Hygrometer	TECPEL	DTM-303B	TP140349	N/A	Nov. 17, 2015	Oct. 06, 2016 ~ Oct. 13, 2016	Nov. 16, 2016	Radiation (03CH12-HY)
RF Cable	HUBER + SUHNER	SUCOFLEX 104	MY24958/4, MY28653/4, MY9839/4PE	26GHz~40GHz	Jan. 12, 2016	Oct. 06, 2016 ~ Oct. 13, 2016	Jan. 11, 2017	Radiation (03CH12-HY)
RF Cable	HUBER + SUHNER	SUCOFLEX 104	MY24958/4, MY28653/4, MY9839/4PE	1GHz~26GHz	Jan. 12, 2016	Oct. 06, 2016 ~ Oct. 13, 2016	Jan. 11, 2017	Radiation (03CH12-HY)
RF Cable	HUBER + SUHNER	SUCOFLEX 104	MY24958/4, MY28653/4, MY9839/4PE	30MHz~1GHz	Jan. 12, 2016	Oct. 06, 2016 ~ Oct. 13, 2016	Jan. 11, 2017	Radiation (03CH12-HY)
RF Cable	HUBER + SUHNER	SUCOFLEX 104	MY24958/4, MY28653/4, MY9839/4PE	9K~30MHz	Jan. 12, 2016	Oct. 06, 2016 ~ Oct. 13, 2016	Jan. 11, 2017	Radiation (03CH12-HY)
Controller	EMEC	EM1000	N/A	Control Turn table & Ant Mast	N/A	Oct. 06, 2016 ~ Oct. 13, 2016	N/A	Radiation (03CH12-HY)
Antenna Mast	EMEC	AM-BS-4500-B	N/A	1m~4m	N/A	Oct. 06, 2016 ~ Oct. 13, 2016	N/A	Radiation (03CH12-HY)
Turn Table	EMEC	TT2000	N/A	0~360 Degree	N/A	Oct. 06, 2016 ~ Oct. 13, 2016	N/A	Radiation (03CH12-HY)
Test Software	Audix	E3	6.2009-8-24	N/A	N/A	Oct. 06, 2016 ~ Oct. 13, 2016	N/A	Radiation (03CH12-HY)
Filter	Wainwright	WLKS4500-8S S	SN19	4.5G Low Pass	Sep. 19, 2016	Oct. 06, 2016 ~ Oct. 13, 2016	Sep. 18, 2017	Radiation (03CH12-HY)
Filter	Wainwright	WHKX8-5872. 5-6750-18000- 40ST	SN3	6.75 GHz Highpass	Sep. 19, 2016	Oct. 06, 2016 ~ Oct. 13, 2016	Sep. 18, 2017	Radiation (03CH12-HY)



## 5 Uncertainty of Evaluation

### Uncertainty of Conducted Emission Measurement (150kHz ~ 30MHz)

Measuring Uncertainty for a Level of Confidence of 95% ( $U = 2Uc(y)$ )	2.70
---	------

### Uncertainty of Radiated Emission Measurement (30 MHz ~ 1000 MHz)

Measuring Uncertainty for a Level of Confidence of 95% ( $U = 2Uc(y)$ )	5.10
---	------

### Uncertainty of Radiated Emission Measurement (1000 MHz ~ 18000 MHz)

Measuring Uncertainty for a Level of Confidence of 95% ( $U = 2Uc(y)$ )	5.20
---	------

### Uncertainty of Radiated Emission Measurement (18000 MHz ~ 40000 MHz)

Measuring Uncertainty for a Level of Confidence of 95% ( $U = 2Uc(y)$ )	4.70
---	------



## Appendix A. Conducted Test Results

Test Engineer:	Luffy Lin / Tommy Lee	Temperature:	21~25	°C
Test Date:	2016/10/06 ~ 2016/10/17	Relative Humidity:	51~54	%

**TEST RESULTS DATA**  
**6dB and 26dB EBW and 99% OBW**

Band IV									
Mod.	Data Rate	NTX	CH.	Freq. (MHz)	99% Bandwidth (MHz)	26 dB Bandwidth (MHz)	6 dB Bandwidth (MHz)	6dB Bandwidth min. Limit (MHz)	Pass/Fail
11a	6M bps	1	149	5745	17.95	31.5	15.04	0.5	Pass
11a	6Mbps	1	157	5785	17.55	31.5	15.52	0.5	Pass
11a	6Mbps	1	165	5825	17.65	37.7	15.12	0.5	Pass
HT20	MCS 0	1	149	5745	18.85	36.8	15.12	0.5	Pass
HT20	MCS 0	1	157	5785	18.35	34.4	15.08	0.5	Pass
HT20	MCS 0	1	165	5825	18.5	35.6	15.08	0.5	Pass
HT40	MCS 0	1	151	5755	36.8	70.29	36	0.5	Pass
HT40	MCS 0	1	159	5795	36.6	62.28	36	0.5	Pass

**TEST RESULTS DATA**  
**Average Power Table**

Band IV										
Mod.	Data Rate	NTX	CH.	Freq. (MHz)	Duty Factor (dB)	Average Conducted Power (dBm)	FCC Conducted Power Limit (dBm)	DG (dBi)		Pass/Fail
11a	6M bps	1	149	5745	0.15	14.98	30.00	-1.10		Pass
11a	6Mbps	1	157	5785	0.15	14.91	30.00	-1.10		Pass
11a	6Mbps	1	165	5825	0.15	14.90	30.00	-1.10		Pass
HT20	MCS 0	1	149	5745	0.15	14.82	30.00	-1.10		Pass
HT20	MCS 0	1	157	5785	0.15	14.80	30.00	-1.10		Pass
HT20	MCS 0	1	165	5825	0.15	14.37	30.00	-1.10		Pass
HT40	MCS 0	1	151	5755	0.26	11.44	30.00	-1.10		Pass
HT40	MCS 0	1	159	5795	0.26	11.41	30.00	-1.10		Pass

**TEST RESULTS DATA**  
**Power Spectral Density**

Band IV										
Mod.	Data Rate	NTX	CH.	Freq. (MHz)	Duty Factor (dB)	10log (500kHz /RBW) Factor (dB)	Average Power Density (dBm/500kHz)	Average PSD Limit (dBm/500kHz)	DG (dBi)	Pass/Fail
11a	6M bps	1	149	5745	0.15	2.22	0.67	30.00	-1.10	Pass
11a	6Mbps	1	157	5785	0.15	2.22	0.25	30.00	-1.10	Pass
11a	6Mbps	1	165	5825	0.15	2.22	1.12	30.00	-1.10	Pass
HT20	MCS 0	1	149	5745	0.15	2.22	0.91	30.00	-1.10	Pass
HT20	MCS 0	1	157	5785	0.15	2.22	0.22	30.00	-1.10	Pass
HT20	MCS 0	1	165	5825	0.15	2.22	0.29	30.00	-1.10	Pass
HT40	MCS 0	1	151	5755	0.26	2.22	-6.54	30.00	-1.10	Pass
HT40	MCS 0	1	159	5795	0.26	2.22	-7.14	30.00	-1.10	Pass

**TEST RESULTS DATA**  
**Frequency Stability**

Band IV										
Mod.	Data Rate	NTX	CH.	Freq. (MHz)	Center Frequency (MHz)	Frequency Deviation (MHz)	Frequency Stability (ppm)	Temperature (°C)	Voltage (V)	Note
11a	6M bps	1	149	5745	5745.000	0.000	0.00	50	3.8	
11a	6M bps	1	149	5745	5745.000	0.000	0.00	-30	3.8	
11a	6M bps	1	149	5745	5745.000	0.000	0.00	20	4.35	
11a	6M bps	1	149	5745	5745.000	0.000	0.00	20	3.4	
11a	6M bps	1	149	5745	5745.050	0.050	8.70	20	3.8	





## Appendix B. Radiated Spurious Emission

Test Engineer :	Peter Chiu, Karl Hou, Nick Yu, and Citta Ke	Temperature :	21~23°C
		Relative Humidity :	54~58%

Band 4 - 5725~5850MHz

WIFI 802.11a (Band Edge @ 3m)

WIFI Ant. 1	Note	Frequency ( MHz )	Level ( dBμV/m )	Over Limit ( dB )	Limit Line ( dBμV/m )	Read Level ( dBμV )	Antenna Factor ( dB/m )	Cable Loss ( dB )	Preamp Factor ( dB )	Ant Pos ( cm )	Table Pos ( deg )	Peak Avg. ( P/A )	Pol. ( H/V )	
802.11a CH 149 5745MHz		5635	59.55	-8.65	68.2	46.57	32.19	11.79	31	177	331	P	H	
		5694.2	60.56	-40.36	100.92	47.48	32.27	11.82	31.01	177	331	P	H	
		5713.4	60.55	-48.4	108.95	47.44	32.29	11.84	31.02	177	331	P	H	
		5723.8	68.19	-51.27	119.46	55.06	32.31	11.84	31.02	177	331	P	H	
	*	5745	108.08	-	-	94.16	33.09	11.86	31.03	177	331	P	H	
	*	5745	97.2	-	-	83.28	33.09	11.86	31.03	177	331	A	H	
														H
														H
			5624.6	59.31	-8.89	68.2	46.34	32.17	11.79	30.99	108	13	P	V
			5672	60.12	-24.4	84.52	47.07	32.24	11.82	31.01	108	13	P	V
			5710.2	60.34	-47.72	108.06	47.23	32.29	11.84	31.02	108	13	P	V
			5723.2	65.88	-52.22	118.1	52.75	32.31	11.84	31.02	108	13	P	V
	*		5745	102.91	-	-	88.99	33.09	11.86	31.03	108	13	P	V
	*		5745	91.95	-	-	78.03	33.09	11.86	31.03	108	13	A	V
														V
														V



WIFI Ant. 1	Note	Frequency ( MHz )	Level ( dBμV/m )	Over Limit ( dB )	Limit Line ( dBμV/m )	Read Level ( dBμV )	Antenna Factor ( dB/m )	Cable Loss ( dB )	Preamp Factor ( dB )	Ant Pos ( cm )	Table Pos ( deg )	Peak Avg. (P/A)	Pol. (H/V)
		5630.4	59.9	-8.3	68.2	46.94	32.17	11.79	31	169	324	P	H
		5685.4	59.53	-34.9	94.43	46.45	32.27	11.82	31.01	169	324	P	H
		5713.2	60.15	-48.75	108.9	47.04	32.29	11.84	31.02	169	324	P	H
		5722.2	58.93	-56.89	115.82	45.8	32.31	11.84	31.02	169	324	P	H
	*	5785	106.59	-	-	92.56	33.2	11.88	31.05	169	324	P	H
	*	5785	95.74	-	-	81.71	33.2	11.88	31.05	169	324	A	H
		5854.6	58.92	-52.79	111.71	45.44	32.51	12.03	31.06	169	324	P	H
		5863.8	60.09	-48.24	108.33	46.48	32.51	12.17	31.07	169	324	P	H
		5918.4	60.48	-12.59	73.07	46.68	32.58	12.31	31.09	169	324	P	H
		5935	60.84	-7.36	68.2	47.02	32.6	12.31	31.09	169	324	P	H
													H
													H
802.11a													
CH 157													
5785MHz		5626.8	59.61	-8.59	68.2	46.64	32.17	11.79	30.99	100	16	P	V
		5660	59.87	-15.76	75.63	46.87	32.22	11.79	31.01	100	16	P	V
		5704	58.96	-47.36	106.32	45.84	32.29	11.84	31.01	100	16	P	V
		5721	60.67	-52.41	113.08	47.54	32.31	11.84	31.02	100	16	P	V
	*	5785	102.36	-	-	88.33	33.2	11.88	31.05	100	16	P	V
	*	5785	91.38	-	-	78.16	32.39	11.88	31.05	100	16	A	V
		5852.4	59.54	-57.19	116.73	46.09	32.48	12.03	31.06	100	16	P	V
		5868.4	60.29	-46.76	107.05	46.68	32.51	12.17	31.07	100	16	P	V
		5907.6	60.55	-20.49	81.04	46.74	32.58	12.31	31.08	100	16	P	V
		5946.6	61.36	-6.84	68.2	47.37	32.63	12.45	31.09	100	16	P	V
													V
													V



WiFi Ant. 1	Note	Frequency ( MHz )	Level ( dBμV/m )	Over Limit ( dB )	Limit Line ( dBμV/m )	Read Level ( dBμV )	Antenna Factor ( dB/m )	Cable Loss ( dB )	Preamp Factor ( dB )	Ant Pos ( cm )	Table Pos ( deg )	Peak Avg. ( P/A )	Pol. ( H/V )	
802.11a CH 165 5825MHz	*	5825	107.09	-	-	92.8	33.31	12.03	31.05	100	328	P	H	
	*	5825	96.32	-	-	82.03	33.31	12.03	31.05	100	328	A	H	
		5851	64.14	-55.78	119.92	50.69	32.48	12.03	31.06	100	328	P	H	
		5859.4	59.76	-49.81	109.57	46.29	32.51	12.03	31.07	100	328	P	H	
		5886.4	60.41	-36.33	96.74	46.79	32.53	12.17	31.08	100	328	P	H	
		5927.4	60.65	-7.55	68.2	46.83	32.6	12.31	31.09	100	328	P	H	
														H
														H
	*	5825	103.57	-	-	89.28	33.31	12.03	31.05	109	13	P	V	
	*	5825	92.81	-	-	78.52	33.31	12.03	31.05	109	13	A	V	
		5853	61.36	-54	115.36	47.91	32.48	12.03	31.06	109	13	P	V	
		5859.4	60.28	-49.29	109.57	46.81	32.51	12.03	31.07	109	13	P	V	
		5887.2	60.57	-35.57	96.14	46.95	32.53	12.17	31.08	109	13	P	V	
		5944.6	59.92	-8.28	68.2	45.93	32.63	12.45	31.09	109	13	P	V	
														V
														V
														V
<b>Remark</b>	1. No other spurious found. 2. All results are PASS against Peak and Average limit line.													



Band 4 5725~5850MHz

WIFI 802.11a (Harmonic @ 3m)

WIFI Ant. 1	Note	Frequency ( MHz )	Level ( dBμV/m )	Over Limit ( dB )	Limit Line ( dBμV/m )	Read Level ( dBμV )	Antenna Factor ( dB/m )	Cable Loss ( dB )	Preamp Factor ( dB )	Ant Pos ( cm )	Table Pos ( deg )	Peak Avg. ( P/A )	Pol. ( H/V )
802.11a CH 149 5745MHz		11490	46.53	-27.47	74	45.8	40.11	18.4	57.78	100	0	P	H
		17235	52.26	-15.94	68.2	44.61	41.65	23.14	57.14	100	0	P	H
													H
													H
		11490	46.34	-27.66	74	45.61	40.11	18.4	57.78	100	0	P	V
		17235	49.48	-18.72	68.2	41.83	41.65	23.14	57.14	100	0	P	V
													V
													V
802.11a CH 157 5785MHz		11570	47.12	-26.88	74	46.48	39.95	18.49	57.8	100	0	P	H
		17355	53.55	-14.65	68.2	45.84	42.02	23.25	57.56	100	0	P	H
													H
													H
		11570	47.55	-26.45	74	46.91	39.95	18.49	57.8	100	0	P	V
		17355	48.69	-19.51	68.2	40.98	42.02	23.25	57.56	100	0	P	V
													V
													V
802.11a CH 165 5825MHz		11650	48.97	-25.03	74	48.39	39.8	18.58	57.8	100	0	P	H
		17475	54.35	-13.85	68.2	46.58	42.39	23.36	57.98	100	0	P	H
													H
													H
		11650	46.8	-27.2	74	46.22	39.8	18.58	57.8	100	0	P	V
		17475	48.26	-19.94	68.2	40.49	42.39	23.36	57.98	100	0	P	V
													V
													V
Remark	1. No other spurious found. 2. All results are PASS against Peak and Average limit line.												



Band 4 5725~5850MHz

WIFI 802.11n HT20 (Band Edge @ 3m)

WIFI Ant. 1	Note	Frequency ( MHz )	Level ( dBμV/m )	Over Limit ( dB )	Limit Line ( dBμV/m )	Read Level ( dBμV )	Antenna Factor ( dB/m )	Cable Loss ( dB )	Preamp Factor ( dB )	Ant Pos ( cm )	Table Pos ( deg )	Peak Avg. ( P/A )	Pol. ( H/V )	
802.11n HT20 CH 149 5745MHz		5646	59.43	-8.77	68.2	46.45	32.19	11.79	31	121	322	P	H	
		5695.2	60.12	-41.54	101.66	47.04	32.27	11.82	31.01	121	322	P	H	
		5719.4	64.71	-45.92	110.63	51.58	32.31	11.84	31.02	121	322	P	H	
		5724.6	67.56	-53.73	121.29	54.43	32.31	11.84	31.02	121	322	P	H	
	*	5745	107.21	-	-	93.29	33.09	11.86	31.03	121	322	P	H	
	*	5745	96.09	-	-	82.17	33.09	11.86	31.03	121	322	A	H	
														H
														H
			5627.8	59.61	-8.59	68.2	46.64	32.17	11.79	30.99	100	14	P	V
			5680	59.66	-30.78	90.44	46.61	32.24	11.82	31.01	100	14	P	V
			5718.6	61.01	-49.4	110.41	47.88	32.31	11.84	31.02	100	14	P	V
			5725	66.24	-55.96	122.2	53.11	32.31	11.84	31.02	100	14	P	V
	*		5745	102.57	-	-	88.65	33.09	11.86	31.03	100	14	P	V
	*		5745	91.3	-	-	77.38	33.09	11.86	31.03	100	14	A	V
														V
													V	



WIFI Ant. 1	Note	Frequency ( MHz )	Level ( dBμV/m )	Over Limit ( dB )	Limit Line ( dBμV/m )	Read Level ( dBμV )	Antenna Factor ( dB/m )	Cable Loss ( dB )	Preamp Factor ( dB )	Ant Pos ( cm )	Table Pos ( deg )	Peak Avg. (P/A)	Pol. (H/V)
		5614.6	59.5	-8.7	68.2	46.58	32.14	11.77	30.99	171	313	P	H
		5695	60.18	-41.33	101.51	47.1	32.27	11.82	31.01	171	313	P	H
		5705.4	59.73	-46.98	106.71	46.62	32.29	11.84	31.02	171	313	P	H
		5720.6	58.9	-53.27	112.17	45.77	32.31	11.84	31.02	171	313	P	H
	*	5785	106.46	-	-	92.43	33.2	11.88	31.05	171	313	P	H
	*	5785	95.39	-	-	81.36	33.2	11.88	31.05	171	313	A	H
		5852.8	60.16	-55.66	115.82	46.71	32.48	12.03	31.06	171	313	P	H
		5863.4	60.06	-48.39	108.45	46.45	32.51	12.17	31.07	171	313	P	H
		5908	60.55	-20.19	80.74	46.74	32.58	12.31	31.08	171	313	P	H
		5933.8	60.58	-7.62	68.2	46.76	32.6	12.31	31.09	171	313	P	H
													H
													H
802.11n													
HT20													
CH 157		5618	59.85	-8.35	68.2	46.9	32.17	11.77	30.99	111	15	P	V
5785MHz		5667.8	60.07	-21.34	81.41	47.02	32.24	11.82	31.01	111	15	P	V
		5709	59.43	-48.29	107.72	46.32	32.29	11.84	31.02	111	15	P	V
		5721	59.31	-53.77	113.08	46.18	32.31	11.84	31.02	111	15	P	V
	*	5785	101.4	-	-	87.37	33.2	11.88	31.05	111	15	P	V
	*	5785	90.61	-	-	77.39	32.39	11.88	31.05	111	15	A	V
		5854.2	60.37	-52.25	112.62	46.89	32.51	12.03	31.06	111	15	P	V
		5861	59.71	-49.41	109.12	46.1	32.51	12.17	31.07	111	15	P	V
		5919	60.61	-12.01	72.62	46.81	32.58	12.31	31.09	111	15	P	V
		5942.2	60.53	-7.67	68.2	46.54	32.63	12.45	31.09	111	15	P	V
													V
													V



WIFI Ant. 1	Note	Frequency ( MHz )	Level ( dBμV/m )	Over Limit ( dB )	Limit Line ( dBμV/m )	Read Level ( dBμV )	Antenna Factor ( dB/m )	Cable Loss ( dB )	Preamp Factor ( dB )	Ant Pos ( cm )	Table Pos ( deg )	Peak Avg. ( P/A )	Pol. ( H/V )	
802.11n HT20 CH 165 5825MHz	*	5825	105.89	-	-	91.6	33.31	12.03	31.05	157	319	P	H	
	*	5825	94.74	-	-	80.45	33.31	12.03	31.05	157	319	A	H	
		5850.2	65.86	-55.88	121.74	52.41	32.48	12.03	31.06	157	319	P	H	
		5856.8	61.03	-49.27	110.3	47.55	32.51	12.03	31.06	157	319	P	H	
		5879	60.31	-41.92	102.23	46.68	32.53	12.17	31.07	157	319	P	H	
		5941.4	59.79	-8.41	68.2	45.8	32.63	12.45	31.09	157	319	P	H	
														H
														H
	*	5825	102.52	-	-	88.23	33.31	12.03	31.05	110	15	P	V	
	*	5825	91.48	-	-	77.19	33.31	12.03	31.05	110	15	A	V	
		5850.8	61.48	-58.9	120.38	48.03	32.48	12.03	31.06	110	15	P	V	
		5872.2	60.28	-45.7	105.98	46.65	32.53	12.17	31.07	110	15	P	V	
		5879.2	60.72	-41.36	102.08	47.09	32.53	12.17	31.07	110	15	P	V	
		5950	60.14	-8.06	68.2	46.15	32.63	12.45	31.09	110	15	P	V	
														V
														V
<b>Remark</b>	1. No other spurious found. 2. All results are PASS against Peak and Average limit line.													



Band 4 5725~5850MHz

WIFI 802.11n HT20 (Harmonic @ 3m)

WIFI Ant. 1	Note	Frequency ( MHz )	Level ( dBμV/m )	Over Limit ( dB )	Limit Line ( dBμV/m )	Read Level ( dBμV )	Antenna Factor ( dB/m )	Cable Loss ( dB )	Preamp Factor ( dB )	Ant Pos ( cm )	Table Pos ( deg )	Peak Avg. ( P/A )	Pol. ( H/V )
802.11n HT20 CH 149 5745MHz		11490	46.48	-27.52	74	45.75	40.11	18.4	57.78	100	0	P	H
		17235	50.62	-17.58	68.2	42.97	41.65	23.14	57.14	100	0	P	H
													H
													H
		11490	47.38	-26.62	74	46.65	40.11	18.4	57.78	100	0	P	V
		17235	49.05	-19.15	68.2	41.4	41.65	23.14	57.14	100	0	P	V
													V
802.11n HT20 CH 157 5785MHz		11570	47.43	-26.57	74	46.79	39.95	18.49	57.8	100	0	P	H
		17355	52.33	-15.87	68.2	44.62	42.02	23.25	57.56	100	0	P	H
													H
													H
		11570	47.92	-26.08	74	47.28	39.95	18.49	57.8	100	0	P	V
		17355	49.35	-18.85	68.2	41.64	42.02	23.25	57.56	100	0	P	V
													V
802.11n HT20 CH 165 5825MHz		11650	47.49	-26.51	74	46.91	39.8	18.58	57.8	100	0	P	H
		17475	50.97	-17.23	68.2	43.2	42.39	23.36	57.98	100	0	P	H
													H
													H
		11650	46.56	-27.44	74	45.98	39.8	18.58	57.8	100	0	P	V
		17475	46.99	-21.21	68.2	39.22	42.39	23.36	57.98	100	0	P	V
													V
Remark	1. No other spurious found.												
	2. All results are PASS against Peak and Average limit line.												





Band 4 5725~5850MHz

WIFI 802.11n HT40 (Band Edge @ 3m)

WIFI Ant. 1	Note	Frequency ( MHz )	Level ( dBμV/m )	Over Limit ( dB )	Limit Line ( dBμV/m )	Read Level ( dBμV )	Antenna Factor ( dB/m )	Cable Loss ( dB )	Preamp Factor ( dB )	Ant Pos ( cm )	Table Pos ( deg )	Peak Avg. ( P/A )	Pol. ( H/V )
		5619.4	60.36	-7.84	68.2	46.85	32.73	11.77	30.99	143	315	P	H
		5678.2	60.4	-28.71	89.11	46.69	32.9	11.82	31.01	143	315	P	H
		5719.2	69.85	-40.73	110.58	56.02	33.01	11.84	31.02	143	315	P	H
		5723	70.2	-47.44	117.64	56.36	33.02	11.84	31.02	143	315	P	H
	*	5755	101.19	-	-	87.25	33.11	11.86	31.03	143	315	P	H
	*	5755	89.86	-	-	75.92	33.11	11.86	31.03	143	315	A	H
		5852.6	59.67	-56.6	116.27	45.31	33.39	12.03	31.06	143	315	P	H
		5873	60.86	-44.9	105.76	46.32	33.44	12.17	31.07	143	315	P	H
		5889.4	61.81	-32.7	94.51	47.23	33.49	12.17	31.08	143	315	P	H
		5925.4	61.16	-7.04	68.2	46.35	33.59	12.31	31.09	143	315	P	H
													H
													H
802.11n HT40 CH 151 5755MHz		5611.2	60.76	-7.44	68.2	47.84	32.14	11.77	30.99	100	14	P	V
		5674.2	60.81	-25.34	86.15	47.76	32.24	11.82	31.01	100	14	P	V
		5719.8	65.17	-45.57	110.74	52.04	32.31	11.84	31.02	100	14	P	V
		5720.6	65.83	-46.34	112.17	52.7	32.31	11.84	31.02	100	14	P	V
	*	5755	96.11	-	-	82.17	33.11	11.86	31.03	100	14	P	V
	*	5755	84.74	-	-	71.55	32.36	11.86	31.03	100	14	A	V
		5850	60.39	-61.81	122.2	46.94	32.48	12.03	31.06	100	14	P	V
		5866.2	60.44	-47.22	107.66	46.83	32.51	12.17	31.07	100	14	P	V
		5901.6	61.14	-24.34	85.48	47.35	32.56	12.31	31.08	100	14	P	V
		5948.8	61.11	-7.09	68.2	47.12	32.63	12.45	31.09	100	14	P	V
													V
													V



WIFI Ant. 1	Note	Frequency ( MHz )	Level ( dBμV/m )	Over Limit ( dB )	Limit Line ( dBμV/m )	Read Level ( dBμV )	Antenna Factor ( dB/m )	Cable Loss ( dB )	Preamp Factor ( dB )	Ant Pos ( cm )	Table Pos ( deg )	Peak Avg. ( P/A )	Pol. ( H/V )
		5606	61.35	-6.85	68.2	47.87	32.7	11.77	30.99	169	326	P	H
		5689.6	60.78	-36.75	97.53	47.04	32.93	11.82	31.01	169	326	P	H
		5716	59.85	-49.83	109.68	46.03	33	11.84	31.02	169	326	P	H
		5720.4	60.21	-51.5	111.71	46.37	33.02	11.84	31.02	169	326	P	H
	*	5795	99.62	-	-	85.56	33.23	11.88	31.05	169	326	P	H
	*	5795	88.79	-	-	74.73	33.23	11.88	31.05	169	326	A	H
		5851.4	62.32	-56.69	119.01	47.97	33.38	12.03	31.06	169	326	P	H
		5856.8	61.2	-49.1	110.3	46.83	33.4	12.03	31.06	169	326	P	H
		5911.6	61.08	-17.01	78.09	46.31	33.55	12.31	31.09	169	326	P	H
		5939.8	61.47	-6.73	68.2	46.62	33.63	12.31	31.09	169	326	P	H
802.11n													H
HT40													H
CH 159		5626	59.7	-8.5	68.2	46.73	32.17	11.79	30.99	100	14	P	V
5795MHz		5674.8	59.97	-26.62	86.59	46.92	32.24	11.82	31.01	100	14	P	V
		5708	59.4	-48.04	107.44	46.29	32.29	11.84	31.02	100	14	P	V
		5721.6	58.95	-55.5	114.45	45.82	32.31	11.84	31.02	100	14	P	V
	*	5795	95.64	-	-	81.58	33.23	11.88	31.05	100	14	P	V
	*	5795	84.65	-	-	70.59	33.23	11.88	31.05	100	14	A	V
		5852.4	59.71	-57.02	116.73	46.26	32.48	12.03	31.06	100	14	P	V
		5869.4	60.21	-46.56	106.77	46.6	32.51	12.17	31.07	100	14	P	V
		5902.4	60.29	-24.6	84.89	46.5	32.56	12.31	31.08	100	14	P	V
		5928.2	60.01	-8.19	68.2	46.19	32.6	12.31	31.09	100	14	P	V
													V
													V
Remark	1. No other spurious found. 2. All results are PASS against Peak and Average limit line.												



Band 4 5725~5850MHz

WIFI 802.11n HT40 (Harmonic @ 3m)

WIFI Ant. 1	Note	Frequency ( MHz )	Level ( dBμV/m )	Over Limit ( dB )	Limit Line ( dBμV/m )	Read Level ( dBμV )	Antenna Factor ( dB/m )	Cable Loss ( dB )	Preamp Factor ( dB )	Ant Pos ( cm )	Table Pos ( deg )	Peak Avg. ( P/A )	Pol. ( H/V )
802.11n HT40 CH 151 5755MHz		11510	45.94	-28.06	74	45.19	40.1	18.45	57.8	100	0	P	H
		17265	49.22	-18.98	68.2	41.56	41.75	23.17	57.26	100	0	P	H
													H
													H
		11510	46.63	-27.37	74	45.88	40.1	18.45	57.8	100	0	P	V
		17265	49.74	-18.46	68.2	42.08	41.75	23.17	57.26	100	0	P	V
													V
													V
802.11n HT40 CH 159 5795MHz		11590	47.07	-26.93	74	46.42	39.91	18.54	57.8	100	0	P	H
		17385	48.47	-19.73	68.2	40.73	42.13	23.29	57.68	100	0	P	H
													H
													H
		11590	47.29	-26.71	74	46.64	39.91	18.54	57.8	100	0	P	V
		17385	48.91	-19.29	68.2	41.17	42.13	23.29	57.68	100	0	P	V
													V
													V
Remark	1. No other spurious found. 2. All results are PASS against Peak and Average limit line.												





Emission below 1GHz

5GHz WIFI 802.11n HT20 (LF @ 3m)

WIFI	Note	Frequency	Level	Over	Limit	Read	Antenna	Cable	Preamp	Ant	Table	Peak	Pol.	
Ant.				Limit	Line	Level	Factor	Loss	Factor	Pos	Pos	Avg.		
1		( MHz )	( dBμV/m )	( dB )	( dBμV/m )	( dBμV )	( dB/m )	( dB )	( dB )	( cm )	( deg )	( P/A )	( H/V )	
5GHz 802.11n HT20 LF		68.88	24.1	-15.9	40	43.14	12.35	1.06	32.45			P	H	
		140.16	28.26	-15.24	43.5	41.08	17.85	1.75	32.42			P	H	
		158.79	26.87	-16.63	43.5	40.59	16.95	1.75	32.42			P	H	
		806.1	29.42	-16.58	46	29.07	28.37	4.14	32.16			P	H	
		878.9	30.58	-15.42	46	28.76	29.07	4.45	31.7			P	H	
		957.3	32.02	-13.98	46	27.76	30.58	4.75	31.07	100	0	P	H	
													H	
													H	
													H	
													H	
													H	
													H	
			36.21	29.77	-10.23	40	38.91	22.54	0.78	32.46	100	0	P	V
			68.88	27.98	-12.02	40	47.02	12.35	1.06	32.45			P	V
			105.6	30.42	-13.08	43.5	44.66	16.76	1.43	32.43			P	V
			746.6	28.92	-17.08	46	29.62	27.64	3.97	32.31			P	V
			860	30.12	-15.88	46	28.7	28.96	4.28	31.82			P	V
			944	31.96	-14.04	46	27.95	30.44	4.75	31.18			P	V
													V	
													V	
													V	
													V	
													V	
													V	
Remark	1. No other spurious found. 2. All results are PASS against limit line.													



Emission below 1GHz

5GHz WIFI 802.11n HT40 (LF @ 3m)

WIFI	Note	Frequency	Level	Over	Limit	Read	Antenna	Cable	Preamp	Ant	Table	Peak	Pol.	
Ant.				Limit	Line	Level	Factor	Loss	Factor	Pos	Pos	Avg.		
1		( MHz )	( dBμV/m )	( dB )	( dBμV/m )	( dBμV )	( dB/m )	( dB )	( dB )	( cm )	( deg )	(P/A)	(H/V)	
5GHz 802.11n HT40 LF		40.53	26.38	-13.62	40	38.32	19.74	0.78	32.46	100	0	P	H	
		138.81	26.72	-16.78	43.5	39.8	17.91	1.43	32.42			P	H	
		159.33	26.88	-16.62	43.5	40.6	16.95	1.75	32.42			P	H	
		617.1	26.82	-19.18	46	29.85	25.87	3.5	32.4			P	H	
		893.6	31.1	-14.9	46	29.1	29.16	4.45	31.61			P	H	
		992.3	31.9	-22.1	54	28.22	30.52	3.92	30.76			P	H	
														H
														H
														H
														H
														H
														H
														H
														H
														H
			30.27	30.18	-9.82	40	36.16	25.7	0.78	32.46	100	0	P	V
			37.02	29.36	-10.64	40	39.06	21.98	0.78	32.46			P	V
			159.33	24.51	-18.99	43.5	38.23	16.95	1.75	32.42			P	V
			747.3	30.93	-15.07	46	31.63	27.64	3.97	32.31			P	V
			960.8	31.77	-22.23	54	27.47	30.58	4.75	31.03			P	V
		984.6	31.75	-22.25	54	28.12	30.53	3.92	30.82			P	V	
													V	
													V	
													V	
													V	
													V	
													V	
<b>Remark</b>	1. No other spurious found. 2. All results are PASS against limit line.													



**Note symbol**

*	<b>Fundamental Frequency</b> which can be ignored. However, the level of any unwanted emissions shall not exceed the level of the fundamental frequency.
!	Test result is <b>over limit</b> line.
P/A	<b>Peak</b> or <b>Average</b>
H/V	<b>Horizontal</b> or <b>Vertical</b>



A calculation example for radiated spurious emission is shown as below:

WIFI	Note	Frequency	Level	Over	Limit	Read	Antenna	Cable	Preamp	Ant	Table	Peak	Pol.
Ant.				Limit	Line	Level	Factor	Loss	Factor	Pos	Pos	Avg.	
1		( MHz )	( dBμV/m )	( dB )	( dBμV/m )	( dBμV )	( dB/m )	( dB )	( dB )	( cm )	( deg )	( P/A )	( H/V )
802.11b		2390	55.45	-18.55	74	54.51	32.22	4.58	35.86	103	308	P	H
CH 01													
2412MHz		2390	43.54	-10.46	54	42.6	32.22	4.58	35.86	103	308	A	H

- Level(dBμV/m) =  
Antenna Factor(dB/m) + Cable Loss(dB) + Read Level(dBμV) - Preamp Factor(dB)
- Over Limit(dB) = Level(dBμV/m) – Limit Line(dBμV/m)

**For Peak Limit @ 2390MHz:**

- Level(dBμV/m)  
= Antenna Factor(dB/m) + Cable Loss(dB) + Read Level(dBμV) - Preamp Factor(dB)  
= 32.22(dB/m) + 4.58(dB) + 54.51(dBμV) – 35.86 (dB)  
= 55.45 (dBμV/m)
- Over Limit(dB)  
= Level(dBμV/m) – Limit Line(dBμV/m)  
= 55.45(dBμV/m) – 74(dBμV/m)  
= -18.55(dB)

**For Average Limit @ 2390MHz:**

- Level(dBμV/m)  
= Antenna Factor(dB/m) + Cable Loss(dB) + Read Level(dBμV) - Preamp Factor(dB)  
= 32.22(dB/m) + 4.58(dB) + 42.6(dBμV) – 35.86 (dB)  
= 43.54 (dBμV/m)
- Over Limit(dB)  
= Level(dBμV/m) – Limit Line(dBμV/m)  
= 43.54(dBμV/m) – 54(dBμV/m)  
= -10.46(dB)

**Both peak and average measured complies with the limit line, so test result is “PASS”.**





## Appendix C. Radiated Spurious Emission Plots

Test Engineer :	Peter Chiu, Karl Hou, Nick Yu, and Citta Ke	Temperature :	21~23°C
		Relative Humidity :	54~58%

**Band 4 - 5725~5850MHz**  
**WIFI 802.11a (Band Edge @ 3m)**

WIFI	Band 4 5725~5850MHz Band Edge @ 3m	
ANT	802.11a CH149 5745MHz	
1	Horizontal	Fundamental
Peak		



WIFI	Band 4 5725~5850MHz Band Edge @ 3m	
ANT	802.11a CH149 5745MHz	
1	Vertical	Fundamental
Peak	<p>Site Condition : 03CH12-HY : PEAK_BE(B4)_16-24 3m HORN_9120D_1328 VERTICAL</p>	<p>Site Condition : 03CH12-HY : PEAK(UNIT) 3m HORN_9120D_1328 VERTICAL</p>



WIFI	Band 4 5725~5850MHz Band Edge @ 3m	
ANT	802.11a CH157 5785MHz	
1	Horizontal	Fundamental
Peak	<p>Site Condition : 03CH12-HY : PEAK_BE(B4)_16-24 3m HORN_9120D_1328 HORIZONTAL</p>	<p>Site Condition : 03CH12-HY : PEAK(UNI) 3m HORN_9120D_1328 HORIZONTAL</p>
Peak	<p>Site Condition : 03CH12-HY : PEAK_BE(B4)_16-24 3m HORN_9120D_1328 HORIZONTAL</p>	Left blank



WIFI	Band 4 5725~5850MHz Band Edge @ 3m	
ANT	802.11a CH157 5785MHz	
1	Vertical	Fundamental
Peak		
Peak		Left blank



WIFI	Band 4 5725~5850MHz Band Edge @ 3m	
ANT	802.11a CH165 5825MHz	
1	Horizontal	Fundamental
Peak	<p>Date: 2016-10-08 PEAK_BE(B4)_16-24 Site Condition : 03CH12-HY : PEAK_BE(B4)_16-24 3m HORN_9120D_1328 HORIZONTAL</p>	<p>Date: 2016-10-08 PEAK(UNIT) Site Condition : 03CH12-HY : PEAK(UNIT) 3m HORN_9120D_1328 HORIZONTAL</p>



WIFI	Band 4 5725~5850MHz Band Edge @ 3m	
ANT	802.11a CH165 5825MHz	
1	Vertical	Fundamental
Peak	<p>Site Condition : 03CH12-HY : PEAK_BE(B4)_16-24 3m HORN_9120D_1328 VERTICAL</p>	<p>Site Condition : 03CH12-HY : PEAK(UNI) 3m HORN_9120D_1328 VERTICAL</p>



Band 4 5725~5850MHz
WIFI 802.11n HT20 (Band Edge @ 3m)

Table with 2 columns: Horizontal, Fundamental. Row 1: Peak. Includes two spectral plots showing Level (dBuV/m) vs Frequency (MHz) with various annotations and site conditions.



WIFI	Band 4 5725~5850MHz Band Edge @ 3m	
ANT	802.11n HT20 CH149 5745MHz	
1	Vertical	Fundamental
Peak	<p>Site Condition : 03CH12-HY : PEAK_BE(B4)_16-24 3m HORN_9120D_1328 VERTICAL</p>	<p>Site Condition : 03CH12-HY : PEAK(UNIT) 3m HORN_9120D_1328 VERTICAL</p>





WIFI	Band 4 5725~5850MHz Band Edge @ 3m	
ANT	802.11n HT20 CH157 5785MHz	
1	Horizontal	Fundamental
Peak	<p>Site Condition : 03CH12-HY : PEAK_BE(B4)_16-24 3m HORN_9120D_1328 HORIZONTAL</p>	<p>Site Condition : 03CH12-HY : PEAK(UNIT) 3m HORN_9120D_1328 HORIZONTAL</p>
Peak	<p>Site Condition : 03CH12-HY : PEAK_BE(B4)_16-24 3m HORN_9120D_1328 HORIZONTAL</p>	Left blank



WIFI	Band 4 5725~5850MHz Band Edge @ 3m	
ANT	802.11n HT20 CH157 5785MHz	
1	Vertical	Fundamental
Peak		
Peak		Left blank



WIFI	Band 4 5725~5850MHz Band Edge @ 3m	
ANT	802.11n HT20 CH165 5825MHz	
1	Horizontal	Fundamental
Peak	<p>Horizontal spectrum plot showing Level (dBuV/m) vs Frequency (MHz) from 5750 to 5950. A peak is visible around 5825 MHz. A red line indicates a limit. Date: 2016-10-08. Site Condition: 03CH12-HY, PEAK_BE(B4)_16-24 3m HORN_9120D_1328 HORIZONTAL.</p>	<p>Fundamental spectrum plot showing Level (dBuV/m) vs Frequency (MHz) from 1000 to 7000. A sharp peak is visible at 5825 MHz. A red line indicates a limit. Date: 2016-10-08. Site Condition: 03CH12-HY, PEAK(UNIT) 3m HORN_9120D_1328 HORIZONTAL.</p>



WIFI	Band 4 5725~5850MHz Band Edge @ 3m	
ANT	802.11n HT20 CH165 5825MHz	
1	Vertical	Fundamental
Peak	<p>Vertical spectrum plot showing Level (dBuV/m) vs Frequency (MHz) from 5750 to 5950. A peak is visible at 5825 MHz. A red line indicates a limit. Text: PEAK_BE(B4)_16-24. Site Condition: : 03CH12-HY : PEAK_BE(B4)_16-24 3m HORN_9120D_1328 VERTICAL.</p>	<p>Fundamental spectrum plot showing Level (dBuV/m) vs Frequency (MHz) from 1000 to 7000. A sharp peak is visible at 5825 MHz. A red line indicates a limit. Text: PEAK(UNIT). Site Condition: : 03CH12-HY : PEAK(UNIT) 3m HORN_9120D_1328 VERTICAL.</p>



Band 4 5725~5850MHz
WIFI 802.11n HT40 (Band Edge @ 3m)

Table with 2 columns: WIFI, ANT and 2 rows: Peak, Peak. The table contains spectral analysis plots for 'Horizontal' and 'Fundamental' signals, and a 'Left blank' plot. Each plot shows Level (dBuV/m) vs Frequency (MHz) with various markers and site information.

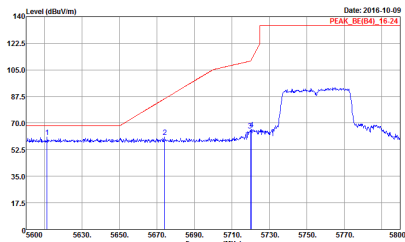
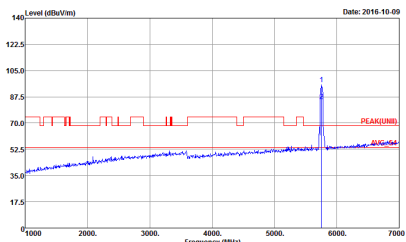
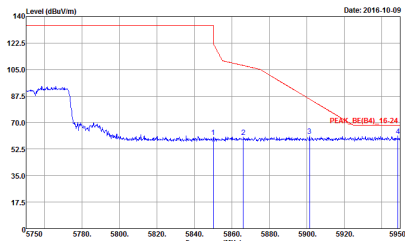

WIFI	Band 4 5725~5850MHz Band Edge @ 3m	
ANT	802.11n HT40 CH151 5755MHz	
1	Vertical	Fundamental
Peak	 <p>Date: 2016-10-09 PEAK_BE(B4)_16-24</p> <p>Site Condition : 03CH12-HY : PEAK_BE(B4)_16-24 3m HORN_9120D_1328 VERTICAL</p>	 <p>Date: 2016-10-09 PEAK(U)N1</p> <p>Site Condition : 03CH12-HY : PEAK(U)N1 3m HORN_9120D_1328 VERTICAL</p>
Peak	 <p>Date: 2016-10-09 PEAK_BE(B4)_16-24</p> <p>Site Condition : 03CH12-HY : PEAK_BE(B4)_16-24 3m HORN_9120D_1328 VERTICAL</p>	Left blank



WIFI	Band 4 5725~5850MHz Band Edge @ 3m	
ANT	802.11n HT40 CH159 5795MHz	
1	Horizontal	Fundamental
Peak	<p>Site Condition : 03CH12-HY : PEAK_BE(B4)_16-24 3m HORN_9120D_1328 HORIZONTAL</p>	<p>Site Condition : 03CH12-HY : PEAK(UMI) 3m HORN_9120D_1328 HORIZONTAL</p>
Peak	<p>Site Condition : 03CH12-HY : PEAK_BE(B4)_16-24 3m HORN_9120D_1328 HORIZONTAL</p>	Left blank



WIFI	Band 4 5725~5850MHz Band Edge @ 3m	
ANT	802.11n HT40 CH159 5795MHz	
1	Vertical	Fundamental
Peak	<p>Site Condition : 03CH12-HY : PEAK_BE(B4)_16-24 3m HORN_9120D_1328 VERTICAL</p>	<p>Site Condition : 03CH12-HY : PEAK(U)M1 3m HORN_9120D_1328 VERTICAL</p>
Peak	<p>Site Condition : 03CH12-HY : PEAK_BE(B4)_16-24 3m HORN_9120D_1328 VERTICAL</p>	Left blank





Band 4 5725~5850MHz

Band 4 - 5725~5850MHz

WIFI 802.11a (Harmonic @ 3m)

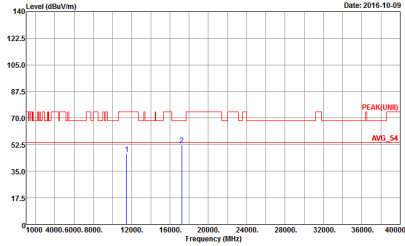
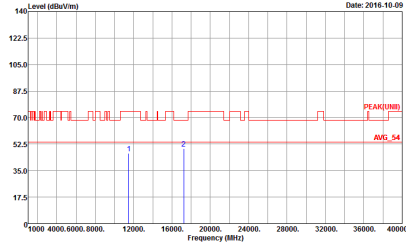
WIFI	Band 4 5725~5850MHz Harmonic @ 3m	
ANT	802.11a CH149 5745MHz	
1	Horizontal	Vertical
<p><b>Peak</b></p> <p><b>Avg.</b></p>	 <p>Site Condition : 03CH12-HY : PEAK(UNIT) 3m HORN_9120D_1328 HORIZONTAL</p>	 <p>Site Condition : 03CH12-HY : PEAK(UNIT) 3m HORN_9120D_1328 VERTICAL</p>

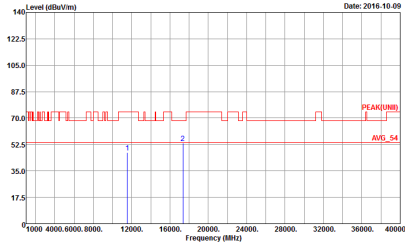
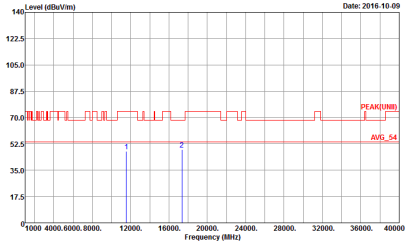

WIFI	Band 4 5725~5850MHz Harmonic @ 3m	
ANT	802.11a CH157 5785MHz	
1	Horizontal	Vertical
<p>Peak</p> <p>Avg.</p>	 <p>Site Condition : 03CH12-HY : PEAK(UNI) 3m HORN_9120D_1328 HORIZONTAL</p>	 <p>Site Condition : 03CH12-HY : PEAK(UNI) 3m HORN_9120D_1328 VERTICAL</p>

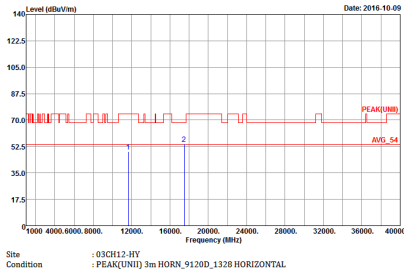
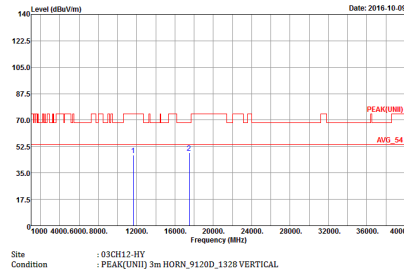

WIFI	Band 4 5725~5850MHz Harmonic @ 3m	
ANT	802.11a CH165 5825MHz	
1	Horizontal	Vertical
Peak Avg.	 <p>Site Condition : 03CH12-HY : PEAK(UNIT) 3m HORN_9120D_1328 HORIZONTAL</p>	 <p>Site Condition : 03CH12-HY : PEAK(UNIT) 3m HORN_9120D_1328 VERTICAL</p>



Band 4 5725~5850MHz
WIFI 802.11n HT20 (Harmonic @ 3m)

Table with 3 columns: WIFI, ANT, and measurement results for Horizontal and Vertical orientations. Includes sub-headers for Peak and Avg. and contains two frequency spectrum graphs.



WIFI	Band 4 5725~5850MHz Harmonic @ 3m	
ANT	802.11n HT20 CH157 5785MHz	
1	Horizontal	Vertical
Peak Avg.	<p>Horizontal spectrum plot showing Level (dBuV/m) vs Frequency (MHz). The plot displays a series of peaks across the frequency range from 1000 to 40000 MHz. A prominent peak is observed at 5785 MHz, marked with a red vertical line and labeled 'PEAK[UNII]'. The average level is indicated as 'AVG_54'. The site condition is noted as ': 03CH12-HY : PEAK[UNII] 3m HORN_9120D_1328 HORIZONTAL'.</p>	<p>Vertical spectrum plot showing Level (dBuV/m) vs Frequency (MHz). The plot displays a series of peaks across the frequency range from 1000 to 40000 MHz. A prominent peak is observed at 5785 MHz, marked with a red vertical line and labeled 'PEAK[UNII]'. The average level is indicated as 'AVG_54'. The site condition is noted as ': 03CH12-HY : PEAK[UNII] 3m HORN_9120D_1328 VERTICAL'.</p>



WIFI	Band 4 5725~5850MHz Harmonic @ 3m	
ANT	802.11n HT20 CH165 5825MHz	
1	Horizontal	Vertical
Peak Avg.	<p>Horizontal spectrum plot showing Level (dBuV/m) vs Frequency (MHz). The plot displays a series of peaks across the frequency range from 1000 to 40000 MHz. A prominent peak is observed at 5825 MHz, marked with a blue vertical line and labeled '1'. The average level is indicated by a red horizontal line at approximately 54 dBuV/m, labeled 'AVG_54'. The date of the test is 2016-10-09.</p> <p>Site Condition : 03CH12-HY : PEAK(UNIT) 3m HORN_9120D_1328 HORIZONTAL</p>	<p>Vertical spectrum plot showing Level (dBuV/m) vs Frequency (MHz). The plot displays a series of peaks across the frequency range from 1000 to 40000 MHz. A prominent peak is observed at 5825 MHz, marked with a blue vertical line and labeled '2'. The average level is indicated by a red horizontal line at approximately 54 dBuV/m, labeled 'AVG_54'. The date of the test is 2016-10-09.</p> <p>Site Condition : 03CH12-HY : PEAK(UNIT) 3m HORN_9120D_1328 VERTICAL</p>



**Band 4 5725~5850MHz  
WIFI 802.11n HT40 (Harmonic @ 3m)**

WIFI	Band 4 5725~5850MHz Harmonic @ 3m	
ANT	802.11n HT40 CH151 5755MHz	
1	Horizontal	Vertical
<p><b>Peak</b></p> <p><b>Avg.</b></p>	<p>Site : 03CH12-HY Condition : PEAK(UNIT) 3m HORN_9120D_1328 HORIZONTAL</p>	<p>Site : 03CH12-HY Condition : PEAK(UNIT) 3m HORN_9120D_1328 VERTICAL</p>



WIFI	Band 4 5725~5850MHz Harmonic @ 3m	
ANT	802.11n HT40 CH159 5795MHz	
1	Horizontal	Vertical
Peak Avg.	<p>Horizontal spectrum plot showing Level (dBuV/m) vs Frequency (MHz). The plot displays a series of peaks between 5725 MHz and 5850 MHz. A prominent peak is labeled at 5795 MHz. The average level is indicated as AVG_54. The site condition is noted as 03CH12-HY, PEAK(UNIT) 3m HORN_9120D_1328 HORIZONTAL.</p>	<p>Vertical spectrum plot showing Level (dBuV/m) vs Frequency (MHz). The plot displays a series of peaks between 5725 MHz and 5850 MHz. A prominent peak is labeled at 5795 MHz. The average level is indicated as AVG_54. The site condition is noted as 03CH12-HY, PEAK(UNIT) 3m HORN_9120D_1328 VERTICAL.</p>





Band 4 5725~5850MHz

Emission below 1GHz

5GHz WIFI 802.11a (LF)

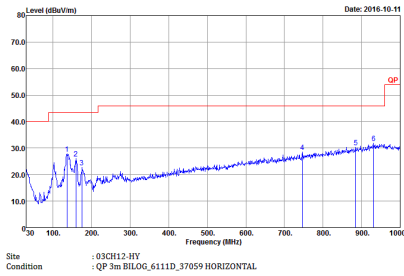
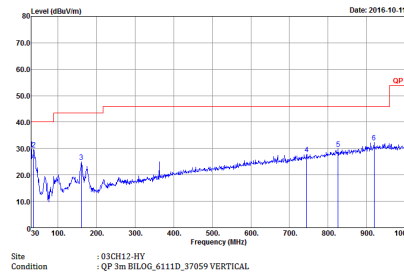
WIFI	5GHz 5725~5850MHz	
ANT	802.11a LF	
1	Horizontal	Vertical
QP / Peak	 <p>Horizontal plot showing Level (dBuV/m) vs Frequency (MHz). The plot displays a blue signal line with several peaks and a red step function. The x-axis ranges from 50 to 1000 MHz, and the y-axis ranges from 10.0 to 80.0 dBuV/m. The date is 2016-10-11. Site Condition: : 03CH12-HY : QP 3m BILOG_6111D_37059 HORIZONTAL.</p>	 <p>Vertical plot showing Level (dBuV/m) vs Frequency (MHz). The plot displays a blue signal line with several peaks and a red step function. The x-axis ranges from 50 to 1000 MHz, and the y-axis ranges from 10.0 to 80.0 dBuV/m. The date is 2016-10-11. Site Condition: : 03CH12-HY : QP 3m BILOG_6111D_37059 VERTICAL.</p>



Emission below 1GHz  
5GHz WIFI 802.11n HT20 (LF)

WIFI	5GHz 5725~5850MHz	
ANT	802.11n HT20 LF	
1	Horizontal	Vertical
QP / Peak	<p>Horizontal plot showing Level (dBuV/m) vs Frequency (MHz) from 50 to 1000 MHz. A red line indicates the QP level, and a blue line shows the spectrum with peaks marked 1-6. Date: 2016-10-11. Site Condition: 03CH12-HY, QP 3m BILOG_6111D_37059 HORIZONTAL.</p>	<p>Vertical plot showing Level (dBuV/m) vs Frequency (MHz) from 50 to 1000 MHz. A red line indicates the QP level, and a blue line shows the spectrum with peaks marked 1-6. Date: 2016-10-11. Site Condition: 03CH12-HY, QP 3m BILOG_6111D_37059 VERTICAL.</p>



Emission below 1GHz  
5GHz WIFI 802.11n HT40 (LF)

WIFI	5GHz 5725~5850MHz	
ANT	802.11n HT40 LF	
1	Horizontal	Vertical
QP / Peak	<p>Horizontal plot showing Level (dBuV/m) vs Frequency (MHz). The plot includes a red line for the QP level and a blue line for the spectrum. Peaks are labeled 1 through 5. Site Condition: 03CH12-HY, QP 3m BILOG_6111D_37059 HORIZONTAL.</p>	<p>Vertical plot showing Level (dBuV/m) vs Frequency (MHz). The plot includes a red line for the QP level and a blue line for the spectrum. Peaks are labeled 1 through 5. Site Condition: 03CH12-HY, QP 3m BILOG_6111D_37059 VERTICAL.</p>



## Appendix D Duty Cycle Plots

Band	Duty Cycle(%)	T(us)	1/T(kHz)	VBW Setting
802.11a	96.53	1390	0.72	1kHz
5GHz 802.11n HT20	96.65	1300	0.77	1kHz
5GHz 802.11n HT40	94.2	650	1.54	3kHz

### 802.11a

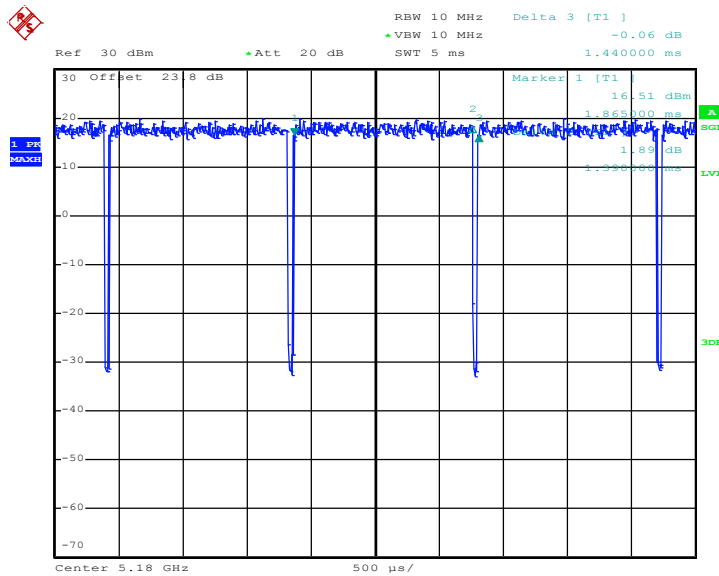

Date: 6.OCT.2016 10:29:57



5GHz 802.11n HT20

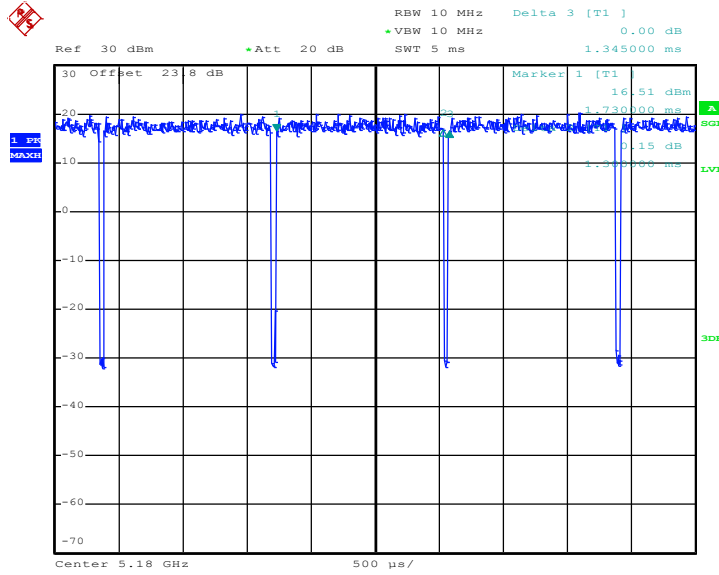

Date: 6.OCT.2016 10:41:44

5GHz 802.11n HT40

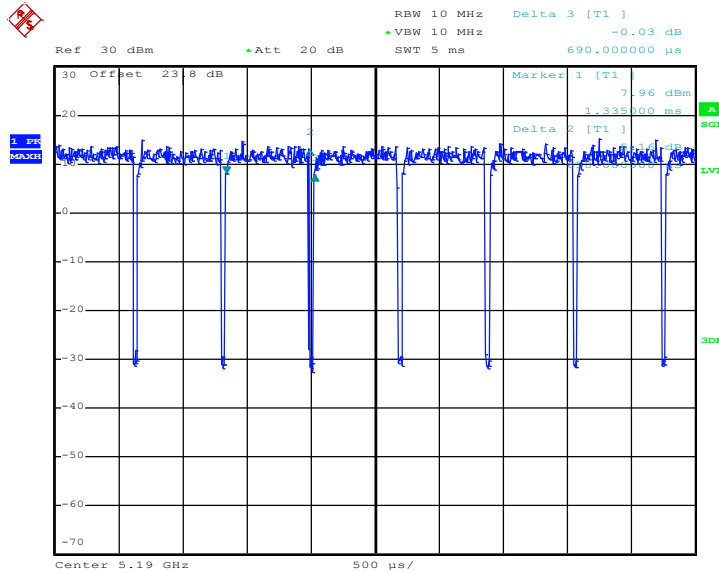

Date: 6.OCT.2016 10:43:58