



# FCC RADIO TEST REPORT

FCC ID : PY7-38061M  
Equipment : GSM/WCDMA/LTE/5G Phone with BT, DTS/UNII  
a/b/g/n/ac/ax, GPS and NFC  
Brand Name : Sony  
Applicant : Sony Corporation  
1-7-1 Konan Minato-ku Tokyo, 108-0075 Japan  
Manufacturer : Sony Corporation  
1-7-1 Konan Minato-ku Tokyo, 108-0075 Japan  
Standard : FCC Part 15 Subpart E §15.407

The product was received on Apr. 21, 2021 and testing was started from May 03, 2021 and completed on May 14, 2021. We, Sporton International Inc. EMC & Wireless Communications Laboratory, would like to declare that the tested sample has been evaluated in accordance with the test procedures and has been in compliance with the applicable technical standards.

The test results in this spot check data report apply exclusively to the tested model / sample. Without written approval of Sporton International Inc. EMC & Wireless Communications Laboratory, the test report shall not be reproduced except in full.

*Louis Wu*

Approved by: Louis Wu

**Sporton International Inc. EMC & Wireless Communications Laboratory**

No. 52, Huaya 1st Rd., Guishan Dist., Taoyuan City 333, Taiwan (R.O.C.)



## Table of Contents

History of this test report.....	3
Summary of Test Result.....	4
<b>1 General Description .....</b>	<b>5</b>
1.1 Product Feature of Equipment Under Test.....	5
1.2 Modification of EUT .....	5
1.3 Testing Location .....	6
1.4 Applicable Standards.....	6
<b>2 Test Configuration of Equipment Under Test .....</b>	<b>7</b>
2.1 Carrier Frequency and Channel .....	7
2.2 Test Mode.....	7
2.3 Connection Diagram of Test System.....	8
2.4 EUT Operation Test Setup .....	8
<b>3 Test Result .....</b>	<b>9</b>
3.1 Maximum Conducted Output Power Measurement .....	9
3.2 Unwanted Emissions Measurement.....	10
3.3 Antenna Requirements.....	15
<b>4 List of Measuring Equipment.....</b>	<b>16</b>
<b>5 Uncertainty of Evaluation .....</b>	<b>17</b>
<b>Appendix A. Conducted Test Results</b>	
<b>Appendix B. Radiated Spurious Emission</b>	
<b>Appendix C. Radiated Spurious Emission Plots</b>	
<b>Appendix D. Duty Cycle Plots</b>	



### History of this test report

Report No.	Version	Description	Issued Date
FR133140F	01	Initial issue of report	May 24, 2021



## Summary of Test Result

Report Clause	Ref Std. Clause	Test Items	Result (PASS/FAIL)	Remark
-	15.403(i)	6dB & 26dB Bandwidth	-	See Note
-	2.1049	99% Occupied Bandwidth	-	See Note
3.1	15.407(a)	Maximum Conducted Output Power	Pass	-
-	15.407(a)	Power Spectral Density	-	See Note
3.2	15.407(b)	Unwanted Emissions	Pass	Under limit 6.06 dB at 54.250 MHz
-	15.207	AC Conducted Emission	-	See Note
-	15.407(c)	Automatically Discontinue Transmission	-	See Note
3.3	15.203 15.407(a)	Antenna Requirement	Pass	-

**Note:** The RF circuit, output power level and antenna performance is the same in WLAN function across all two FCC ID PY7-38061M and PY7-45256F, since the change, only verify RF output power and radiated spurious emission test data the worst mode was reported in this report.

**Declaration of Conformity:**

The test results with all measurement uncertainty excluded are presented in accordance with the regulation limits or requirements declared by manufacturers.

**Comments and Explanations:**

The declared of product specification for EUT presented in the report are provided by the manufacturer, and the manufacturer takes all the responsibilities for the accuracy of product specification.

**Reviewed by: Keven Cheng**

**Report Producer: Amy Chen**



# 1 General Description

## 1.1 Product Feature of Equipment Under Test

GSM/WCDMA/LTE, Bluetooth, DTS/UNII a/b/g/n/ac/ax, NFC, FM Receiver and GNSS.

Product Specification subjective to this standard	
Antenna Type	<Chain 0>: Loop Antenna with gain -1.9 dBi <Chain 1>: Loop Antenna with gain -6.3 dBi

**Remark:** The above EUT's information was declared by manufacturer. Please refer to Comments and Explanations in report summary.

EUT Information List			
HW Version	SW Version	S/N	Performed Test Item
A	0.325	QV7200607L	RF conducted measurement
		QV72006H7L	Radiated Spurious Emission

Accessory List	
AC Adapter	Model Name : XQZ-UC1
	S/N : 0020W51300095
Earphone	Model Name : STH40D
	S/N : N/A
USB Cable	Model Name : XQZ-UB1
	S/N : N/A

**Note:**

1. Above EUT list used are electrically identical per declared by manufacturer.
2. Above the accessories list are used to exercise the EUT during test, and the serial number of each type of accessories is listed in each section of this report. .
3. For other wireless features of this EUT, test report will be issued separately.

## 1.2 Modification of EUT

No modifications are made to the EUT during all test items.



### 1.3 Testing Location

<b>Test Site</b>	Sporton International Inc. EMC & Wireless Communications Laboratory
<b>Test Site Location</b>	No.52, Huaya 1st Rd., Guishan Dist., Taoyuan City 333, Taiwan (R.O.C.) TEL: +886-3-327-3456 FAX: +886-3-328-4978
<b>Test Site No.</b>	<b>Sporton Site No.</b> TH02-HY
<b>Test Site</b>	Sporton International Inc. Wensan Laboratory
<b>Test Site Location</b>	No.58, Aly. 75, Ln. 564, Wenhua 3rd, Rd., Guishan Dist., Taoyuan City 333010, Taiwan (R.O.C.) TEL: +886-3-327-0868 FAX: +886-3-327-0855
<b>Test Site No.</b>	<b>Sporton Site No.</b> 03CH11-HY (TAF Code: 3786)
<b>Remark</b>	The Radiated Spurious Emission test item subcontracted to Sporton International Inc. Wensan Laboratory

**Note:** The test site complies with ANSI C63.4 2014 requirement.

FCC designation No.: TW1190 and TW3786

### 1.4 Applicable Standards

According to the specifications of the manufacturer, the EUT must comply with the requirements of the following standards:

- ♦ FCC Part 15 Subpart E
- ♦ FCC KDB 789033 D02 General UNII Test Procedures New Rules v02r01.
- ♦ FCC KDB 414788 D01 Radiated Test Site v01r01.
- ♦ FCC KDB 662911 D01 Multiple Transmitter Output v02r01.
- ♦ ANSI C63.10-2013

**Remark:**

1. All test items were verified and recorded according to the standards and without any deviation during the test.
2. The TAF code is not including all the FCC KDB listed without accreditation.
3. This EUT has also been tested and complied with the requirements of FCC Part 15, Subpart B, recorded in a separate test report.



## 2 Test Configuration of Equipment Under Test

- a. The EUT has been associated with peripherals and configuration operated in a manner tended to maximize its emission characteristics in a typical application. Frequency range investigated: radiation emission (9 kHz to the 10th harmonic of the highest fundamental frequency or to 40 GHz, whichever is lower). For radiated measurement, pre-scanned in three orthogonal panels, X, Y, Z. The worst cases (Z plane) were recorded in this report.

### 2.1 Carrier Frequency and Channel

Frequency Band	Channel	Freq. (MHz)	Channel	Freq. (MHz)
5725-5850 MHz Band 4 (U-NII-3)	149	5745	157	5785
	151*	5755	159*	5795
	153	5765	161	5805
	155 <sup>#</sup>	5775	165	5825

**Note:**

1. The above Frequency and Channel in "\*" were 802.11n HT40 and 802.11ac VHT40 and 802.11ax HE40.
2. The above Frequency and Channel in "<sup>#</sup>" were 802.11ac VHT80 and 802.11ax HE80.

### 2.2 Test Mode

Final test modes are considering the modulation and worse data rates as below table.

Modulation	Data Rate
802.11a	6 Mbps
802.11n HT20	MCS0
802.11n HT40	MCS0
802.11ac VHT20	MCS0
802.11ac VHT40	MCS0
802.11ac VHT80	MCS0
802.11ax HE20	MCS0
802.11ax HE40	MCS0
802.11ax HE80	MCS0

Ch. #		Band IV : 5725-5850 MHz	
		802.11ax HE20	802.11ax HE80
L	Low	-	-
M	Middle	-	155
H	High	165	-

**Remark:** For radiation spurious emission, the final modulation and the worst data rate was reference the original report worse case.

## 2.3 Connection Diagram of Test System

<WLAN Tx Mode >

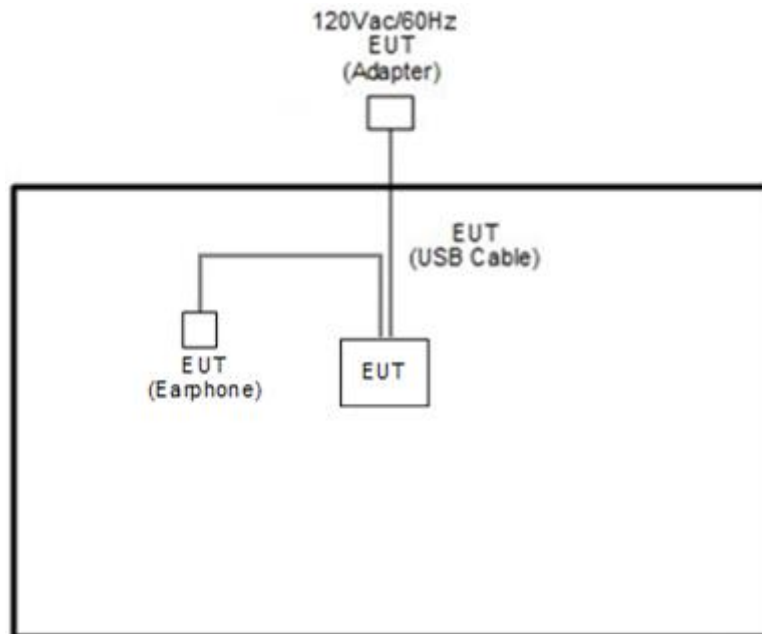

## 2.4 EUT Operation Test Setup

The RF test items, utility “FTMC\_bridge\_v0.39” was installed in Notebook which was programmed in order to make the EUT get into the engineering modes to provide channel selection, power level, data rate and the application type and for continuous transmitting signals.



### 3 Test Result

#### 3.1 Maximum Conducted Output Power Measurement

##### 3.1.1 Limit of Maximum Conducted Output Power

For the band 5.725–5.85 GHz, the maximum conducted output power over the frequency band of operation shall not exceed 1 W.

If transmitting antennas of directional gain greater than 6 dBi are used, the peak output power shall be reduced by the amount in dB that the directional gain of the antenna exceeds 6 dBi.

##### 3.1.2 Measuring Instruments

See list of measuring equipment of this test report.

##### 3.1.3 Test Procedures

The testing follows Method PM-G of FCC KDB 789033 D02 General UNII Test Procedures New Rules v02r01.

Method PM-G (Measurement using a gated RF average power meter):

1. Measurement is performed using a wideband RF power meter.
2. The EUT is configured to transmit at its maximum power control level.
3. Measure the average power of the transmitter.
4. Since the measurement is made only during the ON time of the transmitter, no duty cycle correction factor is required.

##### 3.1.4 Test Setup

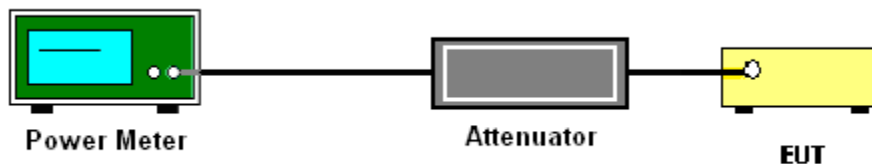

##### 3.1.5 Test Result of Maximum Conducted Output Power

Please refer to Appendix A.



### 3.2 Unwanted Emissions Measurement

This section is to measure unwanted emissions through radiated measurement for band edge spurious emissions and out of band emissions measurement.

#### 3.2.1 Limit of Unwanted Emissions

(1) For transmitters operating in the 5.725-5.85 GHz band:

15.407(b)(4)(i) All emissions shall be limited to a level of -27 dBm/MHz at 75 MHz or more above or below the band edge increasing linearly to 10 dBm/MHz at 25 MHz above or below the band edge, and from 25 MHz above or below the band edge increasing linearly to a level of 15.6 dBm/MHz at 5 MHz above or below the band edge, and from 5 MHz above or below the band edge increasing linearly to a level of 27 dBm/MHz at the band edge.

(2) Unwanted spurious emissions fallen in restricted bands shall comply with the general field strength limits as below table,

Frequency (MHz)	Field Strength (microvolts/meter)	Measurement Distance (meters)
0.009 – 0.490	2400/F(kHz)	300
0.490 – 1.705	24000/F(kHz)	30
1.705 – 30.0	30	30
30 – 88	100	3
88 – 216	150	3
216 - 960	200	3
Above 960	500	3

**Note:** The following formula is used to convert the EIRP to field strength.

$$E = \frac{1000000\sqrt{30P}}{3} \mu\text{V/m, where P is the eirp (Watts)}$$

EIRP (dBm)	Field Strength at 3m (dBμV/m)
- 27	68.3

(3) KDB789033 D02 v02r01 G)2)c)

(i) Sections 15.407(b)(1-3) specifies the unwanted emissions limit for the U-NII-1 and U-NII-2 bands. As specified, emissions above 1000 MHz that are outside of the restricted bands are subject to a peak emission limit of -27 dBm/MHz.

(ii) Section 15.407(b)(4) specifies the unwanted emissions limit for the U-NII-3 band. A band emissions mask is specified in Section 15.407(b)(4)(i). The emission limits are based on the use of a peak detector.



### 3.2.2 Measuring Instruments

See list of measuring equipment of this test report.

### 3.2.3 Test Procedures

1. The testing follows FCC KDB 789033 D02 General UNII Test Procedures New Rules v02r01. Section G) Unwanted emissions measurement.
  - (1) Procedure for Unwanted Emissions Measurements Below 1000 MHz
    - RBW = 120 kHz
    - VBW = 300 kHz
    - Detector = Peak
    - Trace mode = max hold
  - (2) Procedure for Peak Unwanted Emissions Measurements Above 1000 MHz
    - RBW = 1 MHz
    - VBW  $\geq$  3 MHz
    - Detector = Peak
    - Sweep time = auto
    - Trace mode = max hold
  - (3) Procedures for Average Unwanted Emissions Measurements Above 1000 MHz
    - RBW = 1 MHz
    - VBW = 10 Hz, when duty cycle is no less than 98 percent.
    - VBW  $\geq$  1/T, when duty cycle is less than 98 percent where T is the minimum transmission duration over which the transmitter is on and is transmitting at its maximum power control level for the tested mode of operation.
2. The EUT was placed on a turntable with 0.8 meter for frequency below 1 GHz and 1.5 meter for frequency above 1 GHz respectively above ground.
3. The EUT was set 3 meters from the interference receiving antenna which was mounted on the top of a variable height antenna tower.
4. The antenna is a broadband antenna and its height is adjusted between one meter and four meters above ground to find the maximum value of the field strength for both horizontal polarization and vertical polarization of the antenna.
5. For each suspected emission, the EUT was arranged to its worst case and then adjust the antenna tower (from 1 m to 4 m) and turntable (from 0 degree to 360 degrees) to find the maximum reading.
6. For testing below 1 GHz, if the emission level of the EUT in peak mode was 3 dB lower than the limit specified, then peak values of EUT will be reported, otherwise, the emissions will be repeated one by one using the CISPR quasi-peak method and reported.

7. For testing above 1 GHz, the emission level of the EUT in peak mode was 20 dB lower than average limit (that means the emission level in average mode also complies with the limit in average mode), then peak values of EUT will be reported, otherwise, the emissions will be measured in average mode again and reported.

### 3.2.4 Test Setup

For radiated emissions below 30MHz

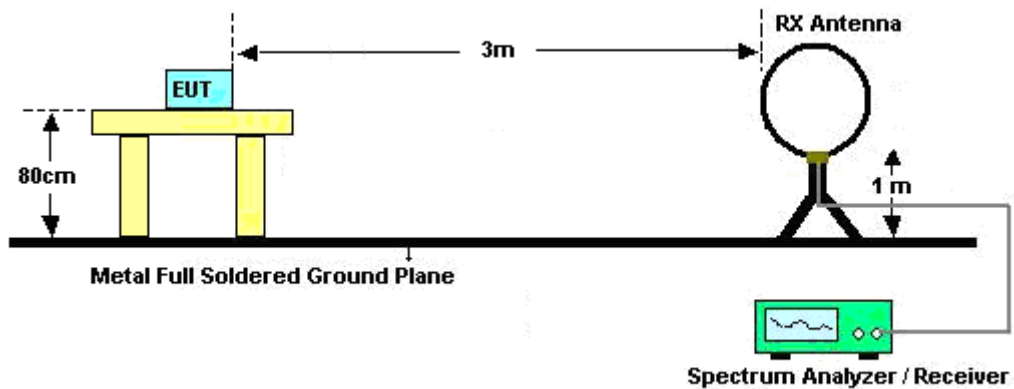

For radiated emissions from 30MHz to 1GHz

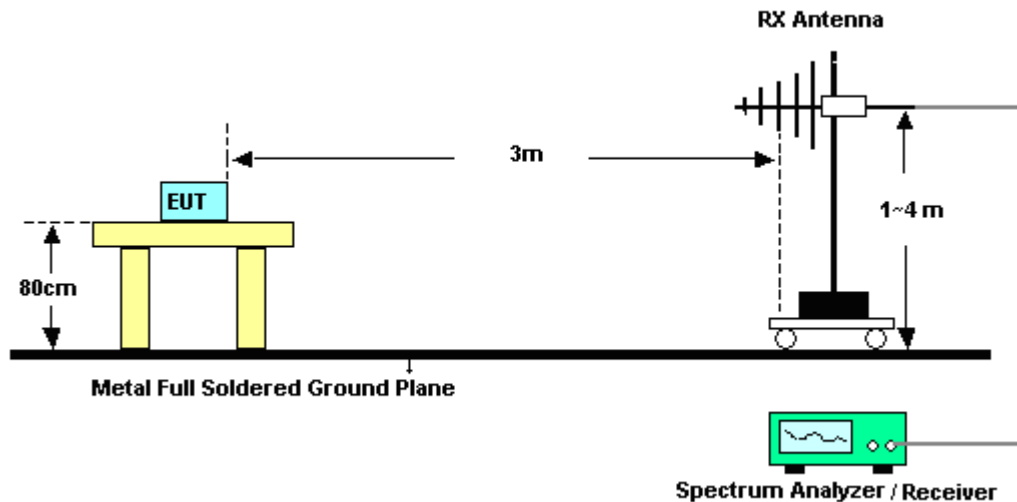

For radiated test from 1GHz to 18GHz

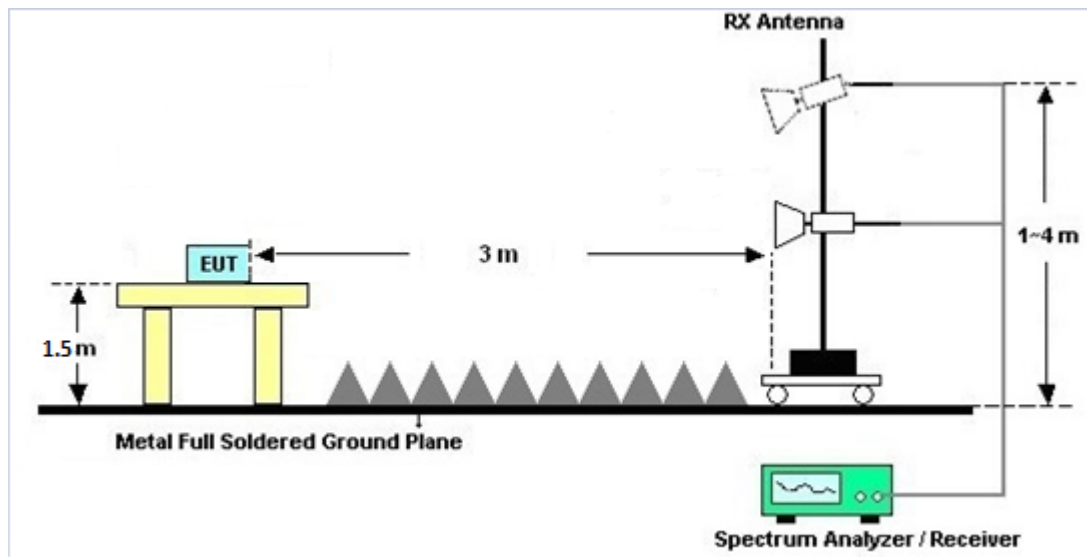

For radiated test above 18GHz

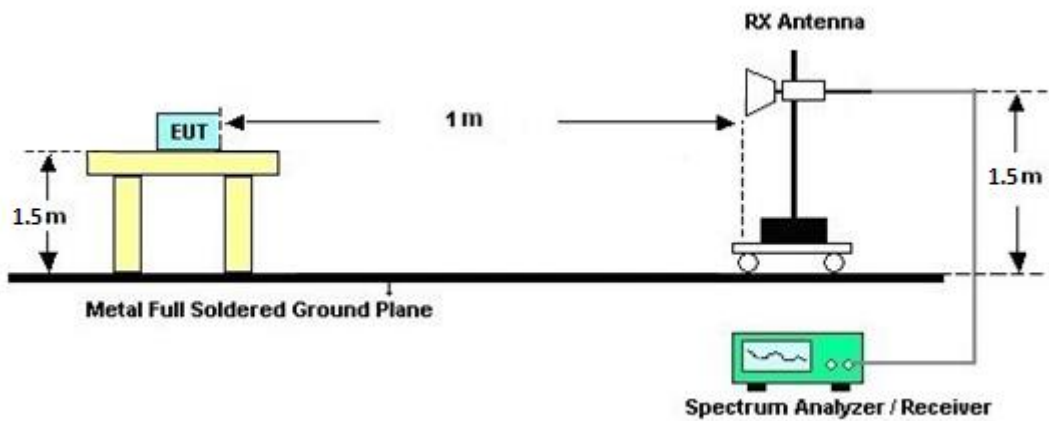



### **3.2.5 Test Results of Radiated Emissions (9 kHz ~ 30 MHz)**

The low frequency, which started from 9 kHz to 30MHz, was pre-scanned and the result which was 20dB lower than the limit line was not reported.

There is a comparison data of both open-field test site and alternative test site - semi-Anechoic chamber according to 414788 D01 Radiated Test Site v01r01, and the result came out very similar.

### **3.2.6 Test Result of Radiated Band Edges**

Please refer to Appendix B and C.

### **3.2.7 Duty Cycle**

Please refer to Appendix D.

### **3.2.8 Test Result of Unwanted Radiated Emission (30MHz ~ 10th Harmonic)**

Please refer to Appendix B and C.



### **3.3 Antenna Requirements**

#### **3.3.1 Standard Applicable**

If transmitting antenna directional gain is greater than 6 dBi, both the peak transmit power and the peak power spectral density shall be reduced by the amount in dB that the directional gain of the antenna exceeds 6 dBi.

#### **3.3.2 Antenna Anti-Replacement Construction**

An embedded-in antenna design is used.

#### **3.3.3 Antenna Gain**

The antenna peak gain of EUT is less than 6 dBi. Therefore, it is not necessary to reduce maximum peak output power limit.



## 4 List of Measuring Equipment

Instrument	Brand Name	Model No.	Serial No.	Characteristics	Calibration Date	Test Date	Due Date	Remark
Hygrometer	Testo	608-H1	34893241	N/A	Mar. 03, 2021	May 03, 2021~ May 05, 2021	Mar. 02, 2022	Conducted (TH02-HY)
Power Sensor	DARE	RPR3006W	16I00054SN O10	10MHz~6GHz	Dec. 16, 2020	May 03, 2021~ May 05, 2021	Dec. 15, 2021	Conducted (TH02-HY)
Signal Analyzer	Rohde & Schwarz	FSV40	101566	10Hz ~ 40GHz	Jul. 22, 2020	May 03, 2021~ May 05, 2021	Jul. 21, 2021	Conducted (TH02-HY)
Switch Box & RF Cable	EM Electronics	EMSW18SE	SW200302	N/A	Mar. 17, 2021	May 03, 2021~ May 05, 2021	Mar. 16, 2022	Conducted (TH02-HY)
Loop Antenna	Rohde & Schwarz	HFH2-Z2	100315	9 kHz~30 MHz	Jan. 04, 2021	May 14, 2021	Jan. 03, 2022	Radiation (03CH11-HY)
Amplifier	SONOMA	310N	187312	9kHz~1GHz	Dec. 02, 2020	May 14, 2021	Dec. 01, 2021	Radiation (03CH11-HY)
Bilog Antenna	TESEQ	CBL 6111D & N-6-06	35414 & AT-N0602	30MHz~1GHz	Oct. 11, 2020	May 14, 2021	Oct. 10, 2021	Radiation (03CH11-HY)
Horn Antenna	SCHWARZBE CK	BBHA 9120 D	9120D-1326	1GHz~18GHz	Nov. 03, 2020	May 14, 2021	Nov. 02, 2021	Radiation (03CH11-HY)
Hygrometer	TECPEL	DTN-303B	TP140325	N/A	Nov. 18, 2020	May 14, 2021	Nov. 17, 2021	Radiation (03CH11-HY)
Preamplifier	Keysight	83017A	MY53270080	1GHz~26.5GHz	Nov. 12, 2020	May 14, 2021	Nov. 11, 2021	Radiation (03CH11-HY)
Spectrum Analyzer	Keysight	N9010A	MY54200486	10Hz~44GHz	Oct. 23, 2020	May 14, 2021	Oct. 22, 2021	Radiation (03CH11-HY)
Filter	Wainwright	WHKX8-5872. 5-6750-18000- 40SS	SN3	6.75GHz High Pass Filter	Sep. 15, 2020	May 14, 2021	Sep. 14, 2021	Radiation (03CH11-HY)
Filter	Wainwright	WLK4-1000-15 30-8000-40SS	SN11	1.53GHz Low Pass Filter	Sep. 14, 2020	May 14, 2021	Sep. 13, 2021	Radiation (03CH11-HY)
RF Cable	HUBER + SUHNER	SUCOFLEX 104	MY9837/4PE	9kHz~30MHz	Mar. 11, 2021	May 14, 2021	Mar. 10, 2022	Radiation (03CH11-HY)
RF Cable	HUBER + SUHNER	SUCOFLEX 102	MY2859/2	30MHz~40GHz	Mar. 11, 2021	May 14, 2021	Mar. 10, 2022	Radiation (03CH11-HY)
RF Cable	HUBER + SUHNER	SUCOFLEX 104	MY9837/4PE	30MHz~18GHz	Mar. 11, 2021	May 14, 2021	Mar. 10, 2022	Radiation (03CH11-HY)
RF Cable	HUBER + SUHNER	SUCOFLEX 102	MY4274/2	30MHz~40GHz	Mar. 11, 2021	May 14, 2021	Mar. 10, 2022	Radiation (03CH11-HY)
RF Cable	HUBER + SUHNER	SUCOFLEX 104	MY11681/4P E	30MHz~18GHz	Mar. 11, 2021	May 14, 2021	Mar. 10, 2022	Radiation (03CH11-HY)
Controller	EMEC	EM 1000	N/A	Control Turn table & Ant Mast	N/A	May 14, 2021	N/A	Radiation (03CH11-HY)
Antenna Mast	EMEC	AM-BS-4500-B	N/A	1~4m	N/A	May 14, 2021	N/A	Radiation (03CH11-HY)
Turn Table	EMEC	TT 2000	N/A	0~360 Degree	N/A	May 14, 2021	N/A	Radiation (03CH11-HY)
SHF-EHF Horn Antenna	SCHWARZBE CK	BBHA9170	00994	18GHz-40GHz	N/A	May 14, 2021	N/A	Radiation (03CH11-HY)
Preamplifier	EMEC	EM18G40G	060801	18GHz~40GHz	N/A	May 14, 2021	N/A	Radiation (03CH11-HY)
Preamplifier	EMEC	EM1G18G	060812	1GHz~18GHz	N/A	May 14, 2021	N/A	Radiation (03CH11-HY)





## 5 Uncertainty of Evaluation

### Uncertainty of Radiated Emission Measurement (30 MHz ~ 1000 MHz)

Measuring Uncertainty for a Level of Confidence of 95% ( $U = 2Uc(y)$ )	4.4
---	-----

### Uncertainty of Radiated Emission Measurement (1000 MHz ~ 18000 MHz)

Measuring Uncertainty for a Level of Confidence of 95% ( $U = 2Uc(y)$ )	5.2
---	-----

### Uncertainty of Radiated Emission Measurement (18000 MHz ~ 40000 MHz)

Measuring Uncertainty for a Level of Confidence of 95% ( $U = 2Uc(y)$ )	5.1
---	-----

**Appendix A. Test Result of Conducted Test Items**

Test Engineer:	Eason Huang	Temperature:	21~25	°C
Test Date:	2021/05/03~2021/05/05	Relative Humidity:	51~54	%

**TEST RESULTS DATA**  
**Average Power Table**

Band IV MIMO												
Mod.	Data Rate	NTX	CH.	Freq. (MHz)	Average Conducted Power (dBm)			FCC Conducted Power Limit (dBm)		DG (dBi)		Pass/Fail
					Chain 0	Chain 1	SUM	Chain 0	Chain 1	Chain 0	Chain 1	
11a	6Mbps	2	149	5745	10.40	10.30	13.36	30.00	30.00	-1.90	-1.90	Pass
11a	6Mbps	2	157	5785	10.40	10.30	13.36	30.00	30.00	-1.90	-1.90	Pass
11a	6Mbps	2	165	5825	10.40	10.40	13.41	30.00	30.00	-1.90	-1.90	Pass
HT20	MCS0	2	149	5745	10.30	10.20	13.26	30.00	30.00	-1.90	-1.90	Pass
HT20	MCS0	2	157	5785	10.30	10.30	13.31	30.00	30.00	-1.90	-1.90	Pass
HT20	MCS0	2	165	5825	10.30	10.30	13.31	30.00	30.00	-1.90	-1.90	Pass
HT40	MCS0	2	151	5755	10.30	10.20	13.26	30.00	30.00	-1.90	-1.90	Pass
HT40	MCS0	2	159	5795	10.20	10.20	13.21	30.00	30.00	-1.90	-1.90	Pass
VHT20	MCS0	2	149	5745	10.30	10.20	13.26	30.00	30.00	-1.90	-1.90	Pass
VHT20	MCS0	2	157	5785	10.30	10.30	13.31	30.00	30.00	-1.90	-1.90	Pass
VHT20	MCS0	2	165	5825	10.30	10.30	13.31	30.00	30.00	-1.90	-1.90	Pass
VHT40	MCS0	2	151	5755	10.30	10.20	13.26	30.00	30.00	-1.90	-1.90	Pass
VHT40	MCS0	2	159	5795	10.20	10.20	13.21	30.00	30.00	-1.90	-1.90	Pass
VHT80	MCS0	2	155	5775	10.30	10.30	13.31	30.00	30.00	-1.90	-1.90	Pass

**TEST RESULTS DATA**  
**Average Power Table**

Band IV MIMO													
Mod.	Data Rate	NTX	CH.	Freq. (MHz)	RU Config	Average Conducted Power (dBm)			FCC Conducted Power Limit (dBm)		DG (dBi)		Pass/Fail
						Chain 0	Chain 1	SUM	Chain 0	Chain 1	Chain 0	Chain 1	
HE20	MCS0	2	149	5745	Full	10.40	10.30	13.36	30.00		-1.90	Pass	
HE20	MCS0	2	149	5745	26/0	8.90	8.90	11.91	30.00		-1.90	Pass	
HE20	MCS0	2	149	5745	52/37	10.30	10.40	13.36	30.00		-1.90	Pass	
HE20	MCS0	2	149	5745	106/53	10.30	10.40	13.36	30.00		-1.90	Pass	
HE20	MCS0	2	157	5785	Full	10.40	10.40	13.41	30.00		-1.90	Pass	
HE20	MCS0	2	165	5825	Full	10.40	10.40	13.41	30.00		-1.90	Pass	
HE20	MCS0	2	165	5825	26/8	8.90	8.80	11.86	30.00		-1.90	Pass	
HE20	MCS0	2	165	5825	52/40	10.40	10.30	13.36	30.00		-1.90	Pass	
HE20	MCS0	2	165	5825	106/54	10.40	10.40	13.41	30.00		-1.90	Pass	
HE40	MCS0	2	151	5755	Full	10.40	10.30	13.36	30.00		-1.90	Pass	
HE40	MCS0	2	151	5755	242/61	10.40	10.40	13.41	30.00		-1.90	Pass	
HE40	MCS0	2	159	5795	Full	10.30	10.30	13.31	30.00		-1.90	Pass	
HE40	MCS0	2	159	5795	242/62	10.40	10.40	13.41	30.00		-1.90	Pass	
HE80	MCS0	2	155	5775	Full	10.40	10.40	13.41	30.00		-1.90	Pass	
HE80	MCS0	2	155	5775	484/65	10.30	10.30	13.31	30.00		-1.90	Pass	
HE80	MCS0	2	155	5775	484/66	10.30	10.40	13.36	30.00		-1.90	Pass	



### Appendix B. Radiated Spurious Emission

Test Engineer :	Bill Cheng, Fu Chen, Troye Hsieh, and Harvey Guo	Temperature :	22.8~25.7°C
		Relative Humidity :	57.6~63.6%

#### Band 4 5725~5850MHz

#### WIFI 802.11ax HE20\_Full (Harmonic @ 3m)

WIFI Chain 0+1	Note	Frequency ( MHz )	Level ( dBμV/m )	Over Limit ( dB )	Limit Line ( dBμV/m )	Read Level ( dBμV )	Antenna Factor ( dB/m )	Path Loss ( dB )	Preamp Factor ( dB )	Ant Pos ( cm )	Table Pos ( deg )	Peak Avg. ( P/A )	Pol. ( H/V )
802.11ax HE20 Full CH 165 5825MHz		11650	48.07	-25.93	74	57.14	39.25	17.9	66.22	100	0	P	H
		17475	53.26	-14.94	68.2	54.8	41.38	22.98	65.9	100	0	P	H
		17945	56.58	-17.42	74	52.02	46.3	23.44	65.18	100	0	P	H
		17945	46.98	-7.02	54	42.42	46.3	23.44	65.18	100	0	A	H
		11650	45.67	-28.33	74	54.74	39.25	17.9	66.22	100	0	P	V
		17475	50.69	-17.51	68.2	52.23	41.38	22.98	65.9	100	0	P	V
		17945	56.49	-17.51	74	51.93	46.3	23.44	65.18	100	0	P	V
		17945	47.02	-6.98	54	42.46	46.3	23.44	65.18	100	0	A	V
Remark	1. No other spurious found. 2. All results are PASS against Peak and Average limit line.												



**Band 4 5725~5850MHz**  
**WIFI 802.11ax HE80\_Full (Band Edge @ 3m)**

WIFI Chain 0+1	Note	Frequency ( MHz )	Level ( dBμV/m )	Over Limit ( dB )	Limit Line ( dBμV/m )	Read Level ( dBμV )	Antenna Factor ( dB/m )	Path Loss ( dB )	Preamp Factor ( dB )	Ant Pos ( cm )	Table Pos ( deg )	Peak Avg. ( P/A )	Pol. ( H/V )
		5650	53.14	-15.06	68.2	43.55	31.8	10.74	32.95	100	117	P	H
		5699.5	71.03	-33.8	104.83	61.38	31.8	10.79	32.94	100	117	P	H
		5719	76.38	-34.14	110.52	66.62	31.88	10.82	32.94	100	117	P	H
		5723	77.07	-40.57	117.64	67.3	31.89	10.82	32.94	100	117	P	H
	*	5775	101.7	-	-	91.7	32.05	10.88	32.93	100	117	P	H
	*	5775	92.53	-	-	82.53	32.05	10.88	32.93	100	117	A	H
		5851.5	74.36	-44.42	118.78	64.02	32.3	10.96	32.92	100	117	P	H
		5855.25	73.18	-37.55	110.73	62.83	32.31	10.96	32.92	100	117	P	H
		5876	64.61	-39.85	104.46	54.19	32.35	10.98	32.91	100	117	P	H
		5943.75	54.38	-13.82	68.2	43.84	32.4	11.04	32.9	100	117	P	H
<b>802.11ax</b>													H
<b>HE80 Full</b>													H
<b>CH 155</b>		5646.75	53.19	-15.01	68.2	43.62	31.79	10.73	32.95	400	0	P	V
<b>5775MHz</b>		5700	73.74	-31.46	105.2	64.08	31.8	10.8	32.94	400	0	P	V
		5716.75	77.18	-32.71	109.89	67.44	31.87	10.81	32.94	400	0	P	V
		5721.25	76.44	-37.21	113.65	66.67	31.89	10.82	32.94	400	0	P	V
	*	5775	101.68	-	-	91.68	32.05	10.88	32.93	400	0	P	V
	*	5775	91.78	-	-	81.78	32.05	10.88	32.93	400	0	A	V
		5851.5	74.61	-44.17	118.78	64.27	32.3	10.96	32.92	400	0	P	V
		5862	72.56	-36.28	108.84	62.18	32.32	10.97	32.91	400	0	P	V
		5875.75	65	-39.64	104.64	54.58	32.35	10.98	32.91	400	0	P	V
		5931.75	55.03	-13.17	68.2	44.5	32.4	11.03	32.9	400	0	P	V
													V
													V
<b>Remark</b>	1. No other spurious found. 2. All results are PASS against Peak and Average limit line.												



**Emission above 18GHz  
WIFI 802.11ax HE20 Full (SHF @ 3m)**

WIFI Chain 0+1	Note	Frequency ( MHz )	Level ( dBμV/m )	Over Limit ( dB )	Limit Line ( dBμV/m )	Read Level (dBμV)	Antenna Factor ( dB/m )	Path Loss ( dB )	Preamp Factor ( dB )	Ant Pos ( cm )	Table Pos ( deg )	Peak Avg. (P/A)	Pol. (H/V)
802.11ax HE20 Full SHF		37294	45.1	-23.1	68.2	60.66	43.25	-1.09	57.72	100	0	P	H
													H
													H
													H
													H
													H
													H
													H
													H
													H
													H
													H
													H
													H
													H
			35886	45.02	-23.18	68.2	61.35	43.54	-1.17	58.7	100	0	P
													V
													V
													V
													V
													V
													V
													V
													V
													V
													V
<b>Remark</b>	1. No other spurious found. 2. All results are PASS against limit line.												



Emission below 1GHz  
WIFI 802.11ax HE20 Full (LF @ 3m)

WIFI Chain 0+1	Note	Frequency ( MHz )	Level ( dBµV/m )	Over Limit ( dB )	Limit Line ( dBµV/m )	Read Level (dBµV)	Antenna Factor ( dB/m )	Path Loss ( dB )	Preamp Factor ( dB )	Ant Pos ( cm )	Table Pos ( deg )	Peak Avg. (P/A)	Pol. (H/V)
		43.58	21.58	-18.42	40	35.77	17.3	1.03	32.52	-	-	P	H
		100.81	25.77	-17.73	43.5	40.77	15.96	1.54	32.5	-	-	P	H
		161.92	25.6	-17.9	43.5	39.91	16.24	1.97	32.52	-	-	P	H
		837.04	29.58	-16.42	46	27.97	28.71	4.35	31.45	-	-	P	H
		875.84	30.35	-15.65	46	27.95	29.21	4.49	31.3	-	-	P	H
		953.44	31.4	-14.6	46	26.7	30.84	4.71	30.85	100	0	P	H
													H
													H
													H
													H
													H
													H
802.11ax													H
HE20 Full													H
LF		46.49	33.45	-6.55	40	49.18	15.73	1.07	32.53	-	-	P	V
		54.25	33.94	-6.06	40	52.99	12.35	1.15	32.55	100	0	P	V
		67.83	26.66	-13.34	40	45.88	12.04	1.27	32.53	-	-	P	V
		842.86	29.7	-16.3	46	27.82	28.94	4.37	31.43	-	-	P	V
		856.44	30.89	-15.11	46	28.6	29.25	4.41	31.37	-	-	P	V
		951.5	31.83	-14.17	46	27.25	30.75	4.7	30.87	-	-	P	V
													V
													V
													V
													V
													V
													V
													V
													V
													V
Remark	1. No other spurious found. 2. All results are PASS against limit line.												





**Note symbol**

*	<b>Fundamental Frequency</b> which can be ignored. However, the level of any unwanted emissions shall not exceed the level of the fundamental frequency.
!	Test result is <b>over limit</b> line.
P/A	<b>Peak</b> or <b>Average</b>
H/V	<b>Horizontal</b> or <b>Vertical</b>



A calculation example for radiated spurious emission is shown as below:

WIFI	Note	Frequency	Level	Over	Limit	Read	Antenna	Path	Preamp	Ant	Table	Peak	Pol.
Chain				Limit	Line	Level	Factor	Loss	Factor	Pos	Pos	Avg.	
0+1		( MHz )	( dBμV/m )	( dB )	( dBμV/m )	( dBμV )	( dB/m )	( dB )	( dB )	( cm )	( deg )	( P/A )	( H/V )
802.11b		2390	55.45	-18.55	74	54.51	32.22	4.58	35.86	103	308	P	H
CH 01													
2412MHz		2390	43.54	-10.46	54	42.6	32.22	4.58	35.86	103	308	A	H

1. Path Loss(dB) = Cable loss(dB) + Filter loss(dB) + Attenuator loss(dB)
2. Level(dBμV/m) = Antenna Factor(dB/m) + Path Loss(dB) + Read Level(dBμV) - Preamp Factor(dB)
3. Over Limit(dB) = Level(dBμV/m) – Limit Line(dBμV/m)

**For Peak Limit @ 2390MHz:**

1. Level(dBμV/m)  
= Antenna Factor(dB/m) + Path Loss(dB) + Read Level(dBμV) - Preamp Factor(dB)  
= 32.22(dB/m) + 4.58(dB) + 54.51(dBμV) – 35.86 (dB)  
= 55.45 (dBμV/m)
2. Over Limit(dB)  
= Level(dBμV/m) – Limit Line(dBμV/m)  
= 55.45(dBμV/m) – 74(dBμV/m)  
= -18.55(dB)

**For Average Limit @ 2390MHz:**

1. Level(dBμV/m)  
= Antenna Factor(dB/m) + Path Loss(dB) + Read Level(dBμV) - Preamp Factor(dB)  
= 32.22(dB/m) + 4.58(dB) + 42.6(dBμV) – 35.86 (dB)  
= 43.54 (dBμV/m)
2. Over Limit(dB) = Level(dBμV/m) – Limit Line(dBμV/m)  
= 43.54(dBμV/m) – 54(dBμV/m)  
= -10.46(dB)

**Both peak and average measured complies with the limit line, so test result is “PASS”.**



## Appendix C. Radiated Spurious Emission Plots

Test Engineer :	Bill Cheng, Fu Chen, Troye Hsieh, and Harvey Guo	Temperature :	22.8~25.7°C
		Relative Humidity :	57.6~63.6%

### Note symbol

-L	Low channel location
-R	High channel location



**Band 4 5725~5850MHz**  
**WIFI 802.11ax HE80 Full (Band Edge @ 3m)**

WIFI	Band 4 5725~5850MHz Band Edge @ 3m	
Chain	802.11ax HE80 Full CH155 5775MHz	
0+1	Horizontal	Fundamental
Peak	<p>Site : 03CH11-HY            Condition : PEAK_BE(B4)_16-24 3m HORN 91200-HF_1326 HORIZONTAL            : RBW:1000.000kHz VBW:3000.000kHz SWT:Auto</p>	<p>Site : 03CH11-HY            Condition : PEAK(U8) 3m HORN 91200-HF_1326 HORIZONTAL            : RBW:1000.000kHz VBW:3000.000kHz SWT:Auto</p>
Peak	<p>Site : 03CH11-HY            Condition : PEAK_BE(B4)_16-24 3m HORN 91200-HF_1326 HORIZONTAL            : RBW:1000.000kHz VBW:3000.000kHz SWT:Auto</p>	Left blank



WIFI	Band 4 5725~5850MHz Band Edge @ 3m	
Chain	802.11ax HE80 Full CH155 5775MHz	
0+1	Vertical	Fundamental
Peak	<p>Site : 03CHI1-HY Condition : PEAK_BE(B4)_16-24 3m HORN 9120D-HF_1326 VERTICAL : RBW:1000.000KHz VBW:3000.000KHz SWT:Auto</p>	<p>Site : 03CHI1-HY Condition : PEAK(FUNB) 3m HORN 9120D-HF_1326 VERTICAL : RBW:1000.000KHz VBW:3000.000KHz SWT:Auto</p>
Peak	<p>Site : 03CHI1-HY Condition : PEAK_BE(B4)_16-24 3m HORN 9120D-HF_1326 VERTICAL : RBW:1000.000KHz VBW:3000.000KHz SWT:Auto</p>	Left blank



**Band 4 - 5725~5850MHz**  
**WIFI 802.11ax HE20 Full (Harmonic @ 3m)**

<b>WIFI</b>	<b>Band 4 5725~5850MHz Harmonic @ 3m</b>	
<b>Chain</b>	<b>802.11ax HE20 Full CH165 5825MHz</b>	
<b>0+1</b>	<b>Horizontal</b>	<b>Vertical</b>
<b>Peak</b> <b>Avg.</b>	<p>Site : 03CHI1-HY          Condition : PEAK(UNII) 3m HORN 9120D-HF_1326 HORIZONTAL</p>	<p>Site : 03CHI1-HY          Condition : PEAK(UNII) 3m HORN 9120D-HF_1326 VERTICAL</p>



Emission above 18GHz  
5GHz WIFI 802.11ax HE20 Full (SHF)

WIFI	5GHz WIFI	
Chain	802.11ax HE20 Full SHF	
0+1	Horizontal	Vertical
QP / Peak	<p>Site : 03CHI1-HY Condition : PEAK(UNII)_1M 1m SHF ANT_9170_00994 HORIZONTAL</p>	<p>Site : 03CHI1-HY Condition : PEAK(UNII)_1M 1m SHF ANT_9170_00994 VERTICAL</p>



Emission below 1GHz  
5GHz WIFI 802.11ax HE20 Full (LF)

WIFI	5GHz WIFI	
Chain	802.11ax HE20 Full LF	
0+1	Horizontal	Vertical
QP / Peak	<p>Site : 03CHI1-HY Condition : QP 3m BE-LOG 6111D-LF_ETC HORIZONTAL</p>	<p>Site : 03CHI1-HY Condition : QP 3m BE-LOG 6111D-LF_ETC VERTICAL</p>





## Appendix D. Duty Cycle Plots

Chain	Band	Duty Cycle(%)	T(us)	1/T(kHz)	VBW Setting	Duty Factor(dB)
0+1	5GHz 802.11ax HE20 Full RU	99.73	-	-	10Hz	0.01
0+1	5GHz 802.11ax HE80 Full RU	99.45	-	-	10Hz	0.02

### MIMO <Chain 0+1>

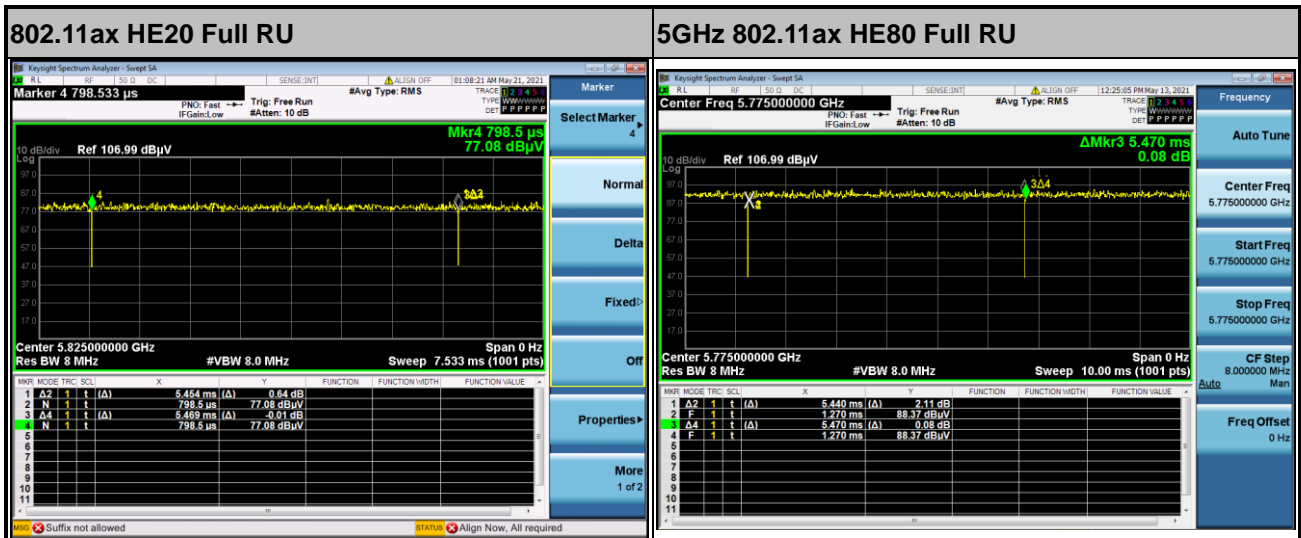

—THE END—