

**SONY**

# **Antenna Specification**

**PY7-37016L**

**Sony Corporation**

**1-7-1 Konan Minato-ku Tokyo, 108-0075**

**Signature:** *Syulli Li*

---

**< Syulli Li >**

**Date: 01.29.2024**

**Contents**

1	Introduction .....	3
2	Measurement Environment .....	3
2.1	Test Site.....	3
2.2	Test Equipment List .....	3
3	Applied Standards.....	3
4	Test Condition.....	3
4.1	Test Method (Test Procedure) .....	3
4.2	Measurement System .....	4
4.3	Test setup photo .....	4
5	Test Method (Test Procedure) .....	4
6	Test Results.....	6
6.1	Gain and Efficiency .....	6
6.2	Radiation Pattern (2D or 3D).....	7

## 1 Introduction

This document describe how to measure the antenna performance of this device and the characteristics of the antenna i.e. antenna gain, antenna efficiency and radiation pattern. The Antenna Type is PIFA antenna.

## 2 Measurement Environment

### 2.1 Test Site

Zhejiang Haitong communication electronic Limited by Share Ltd Shanghai branch

ADD: Ground floor, C5 building, Kangqiao business oasis, No.2555 Xiu Pu Road, Pudong New Area, Shanghai.

### 2.2 Test Equipment List

Type of Equipment	Manufacturer	Model Number	S/N	Calibration	
				Last Cal.	Due Date
Network Analyzer	KEYSIGHT	E5071C	MY42302296	2023.06	Network Analyzer
Satimo Horn antenna	Satimo	SH-400		NA	Satimo Horn antenna
Controller unit	Satimo	Controller unit SG24	MODU-022-A0031	NA	Controller unit

## 3 Applied Standards

Identity	Document Title
ANSI/IEEE Std 149-2008	IEEE Standard Test Procedures for Antennas

## 4 Test Condition

Temperature	MIN=19°C MAX=25°C
Relative humidity	MIN=40% MAX=72%
Shield effect	0.4-6GHz >100dB
Ground resistance	<0.5Ω

### 4.1 Test Method (Test Procedure)

Satimo SG24 :

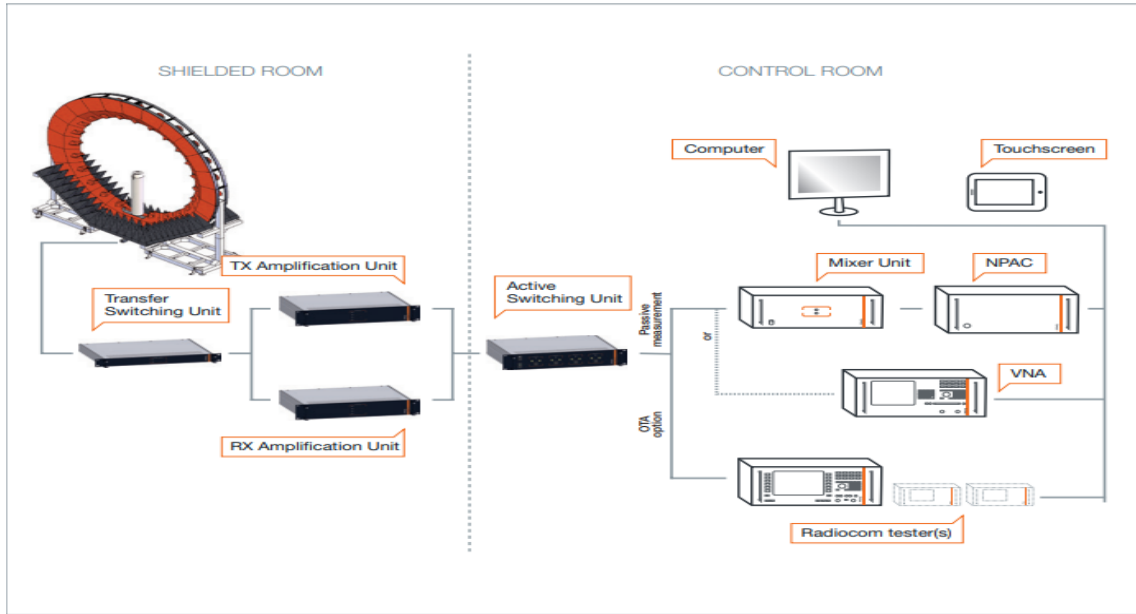

GTS2800:

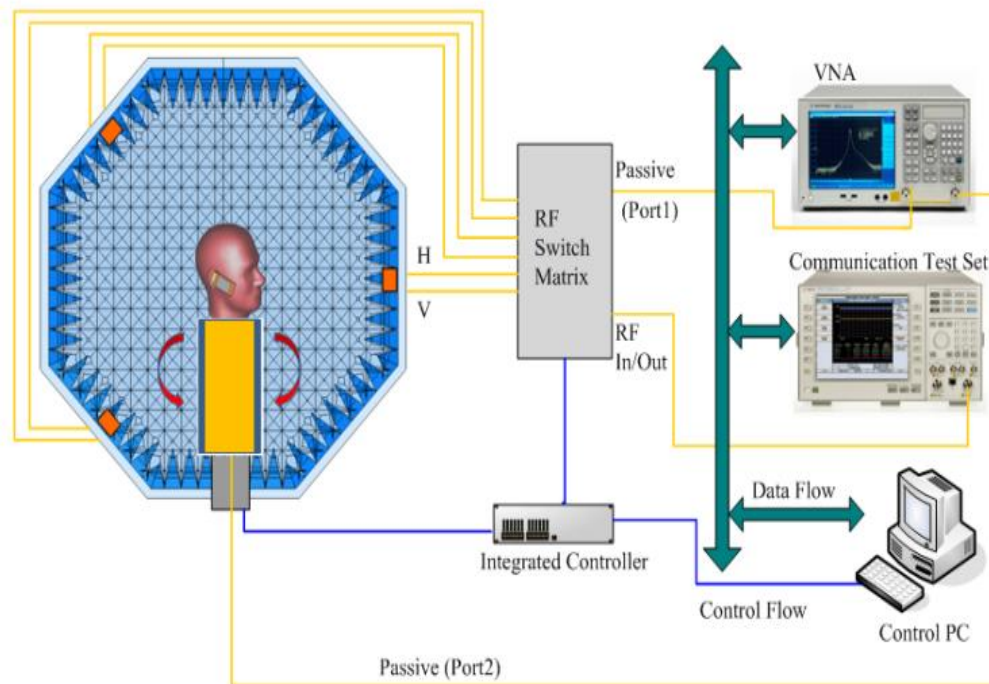

4.2 Measurement System

Satimo SG24:

4.3 Test setup photo

Please refer to "FCC\_Antenna\_Gain\_for\_WLAN\_and\_Bluetooth\_setup\_photo"

5 Test Method (Test Procedure)

SG24:

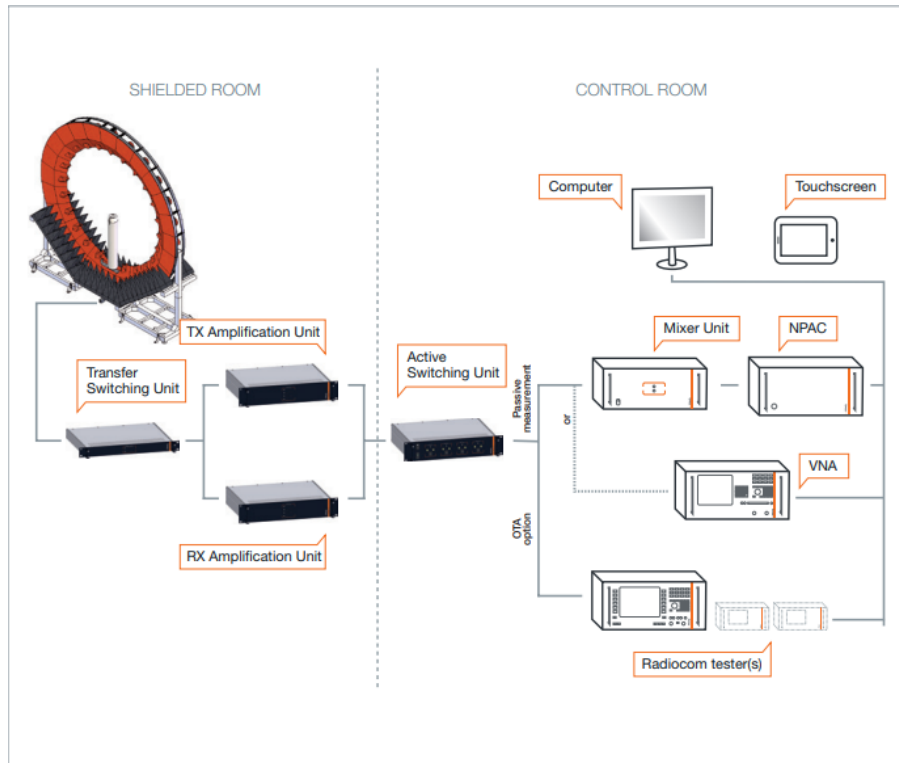

GTS2800:

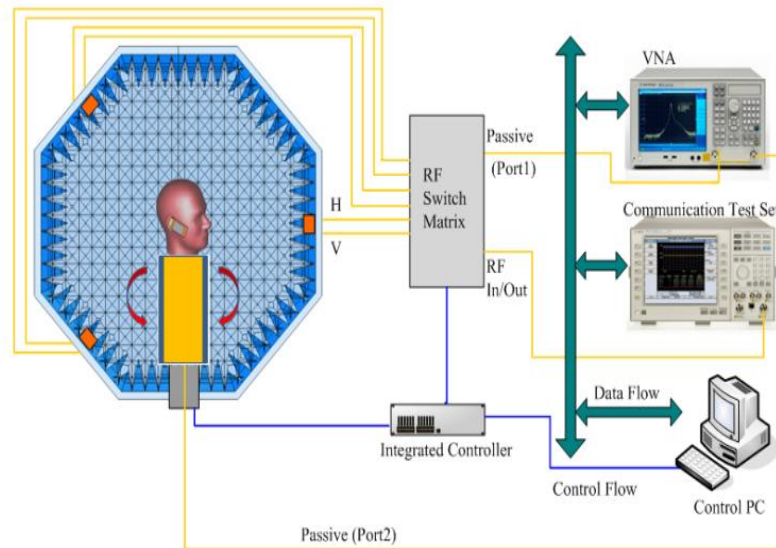

## 6 Test Results

### 6.1 Gain and Efficiency

#### (1) Chain 0 Antenna (ANT6)

Frequency [MHz]	Peak Gain [dBi]	Efficiency [%]
2400	-2.9	22%
2410	-3.0	22%
2420	-2.9	22%
2430	-2.9	22%
2440	-2.8	22%
2450	-2.8	21%
2460	-2.9	21%
2470	-2.8	21%
2480	-2.8	21%
2490	-2.9	20%
2500	-2.8	20%
5150	-2.9	24%
5200	-3.1	24%
5250	-3.0	24%
5300	-2.7	25%
5350	-2.3	25%
5400	-2.4	27%
5450	-2.3	26%
5500	-2.1	25%
5550	-2.0	25%
5600	-1.6	25%
5650	-1.6	24%
5700	-1.7	23%
5750	-1.8	23%
5800	-2.0	22%
5850	-1.6	21%

#### (2) Chain 1 Antenna (ANT7)

Frequency [MHz]	Peak Gain [dBi]	Efficiency [%]
2400	-2.9	18%
2410	-2.5	18%
2420	-2.4	19%
2430	-2.3	19%
2440	-2.1	19%
2450	-1.9	19%
2460	-2.2	19%
2470	-2.3	19%
2480	-2.0	19%
2490	-1.9	19%
2500	-1.9	20%
5150	-1.5	24%
5200	-1.8	23%

5250	-1.7	23%
5300	-1.6	25%
5350	-1.6	23%
5400	-1.8	25%
5450	-1.8	23%
5500	-2.0	21%
5550	-1.8	22%
5600	-2.0	22%
5650	-2.8	19%
5700	-3.9	17%
5750	-3.8	20%
5800	-4.2	17%
5850	-4.5	17%

## 6.2 Radiation Pattern (2D or 3D)

### 6.2.1 Pattern Plots

#### 6.2.1.1 Return Loss

##### (1) Chain 0 Antenna (ANT6)

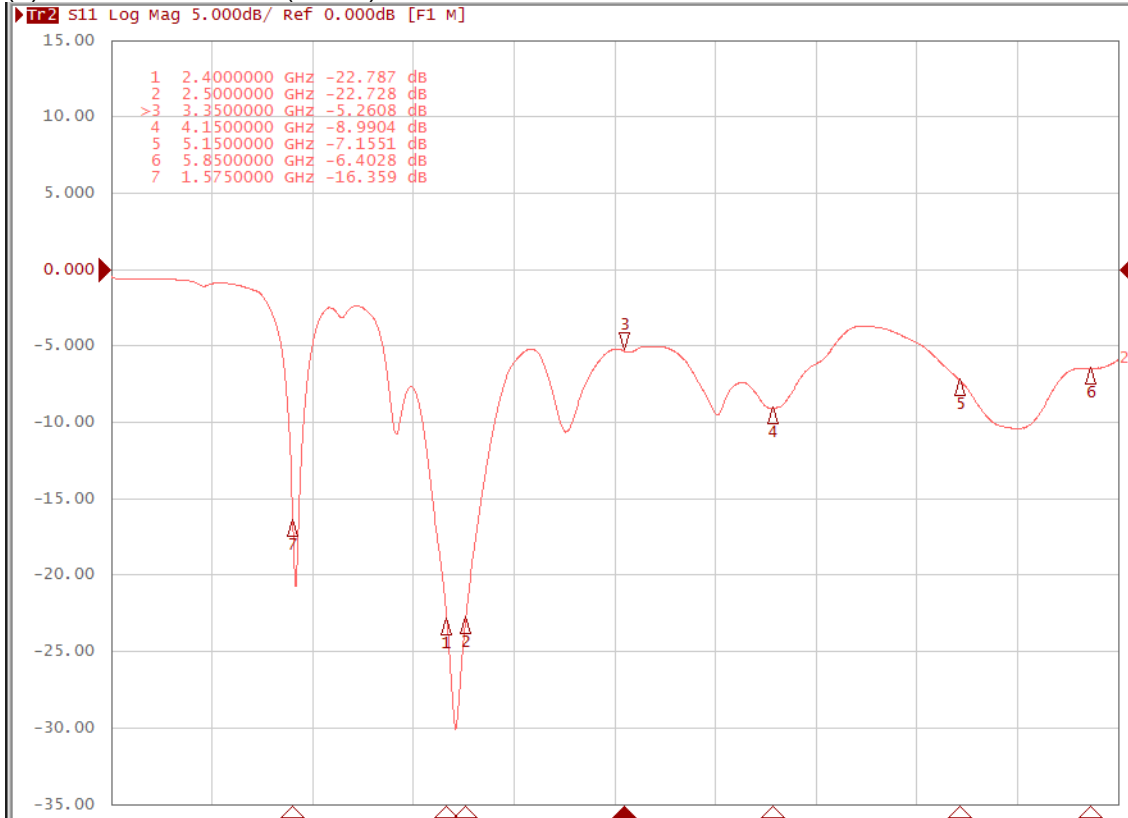

(2) Chain 1 Antenna (ANT7)

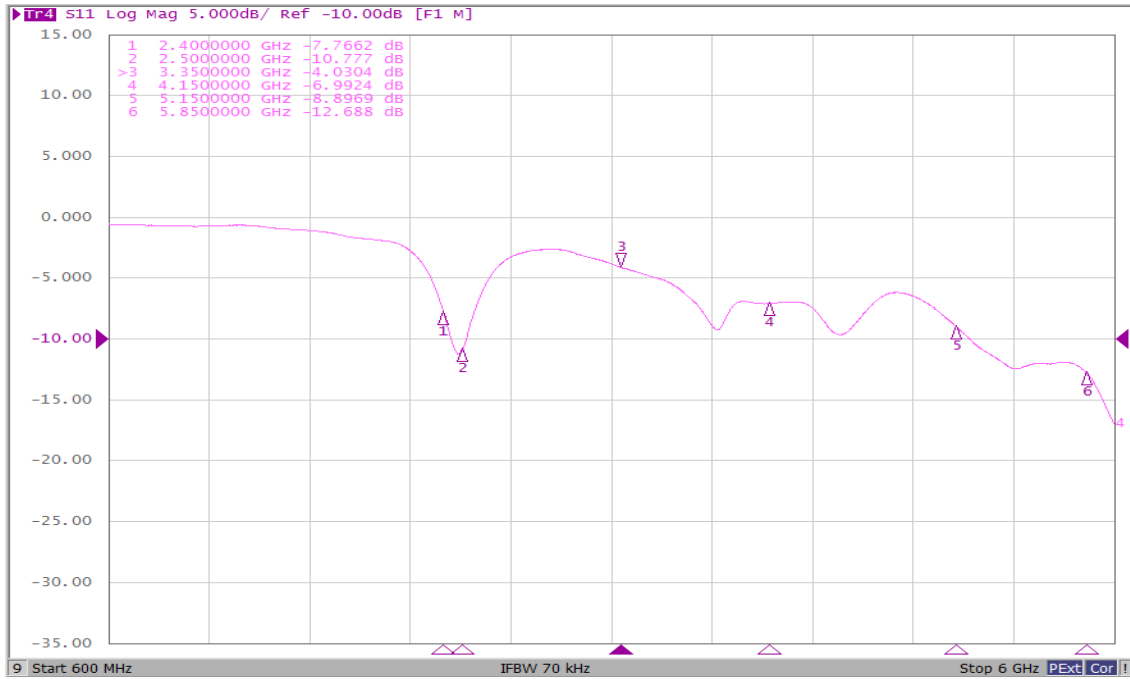

6.2.1.2 VSWR

(1) Chain 0 Antenna (ANT6)

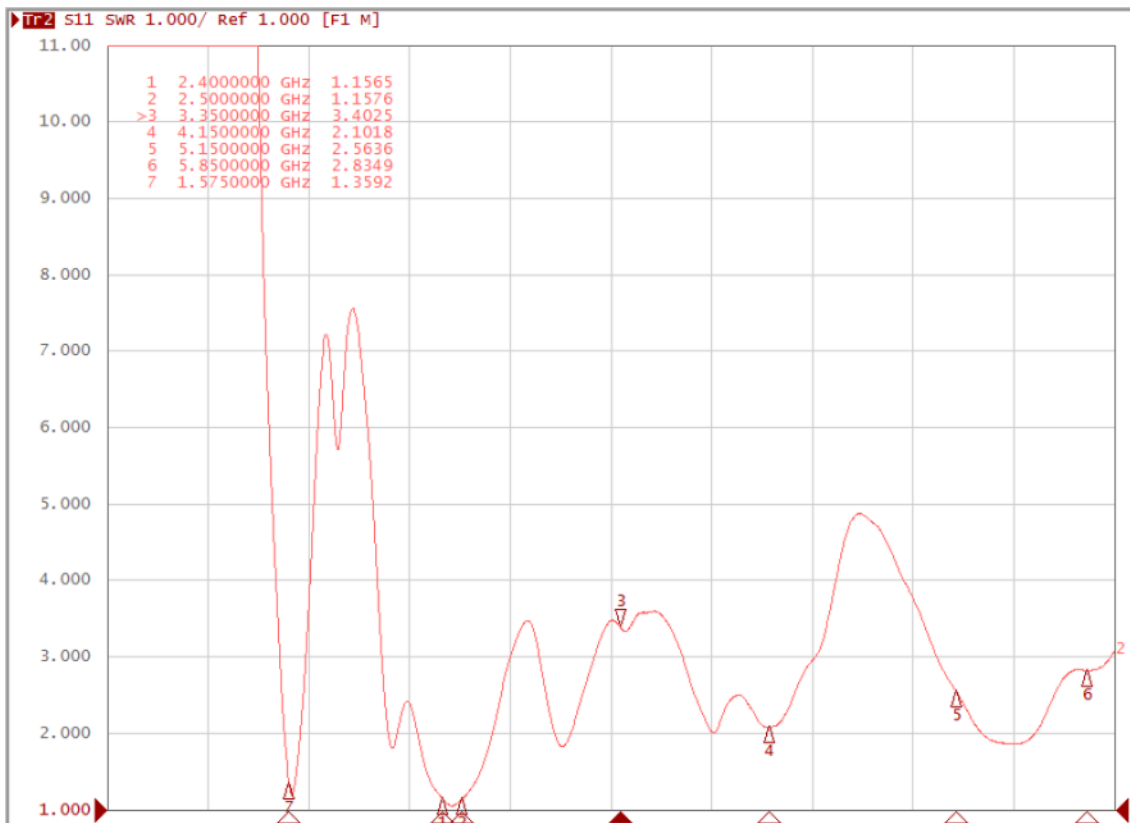



(2) Chain 1 Antenna (ANT7)



6.2.1.3 Smith

(1) Chain 0 Antenna (ANT6)

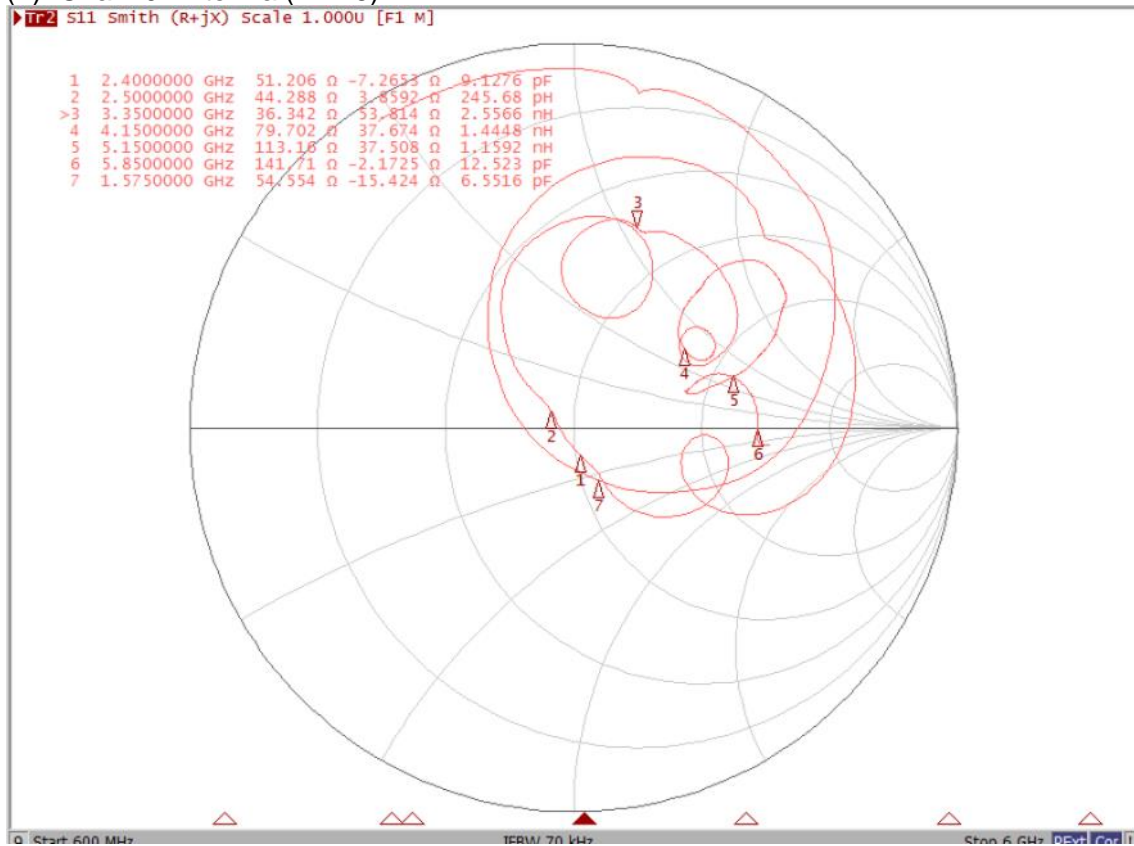

(2) Chain 1 Antenna (ANT7)

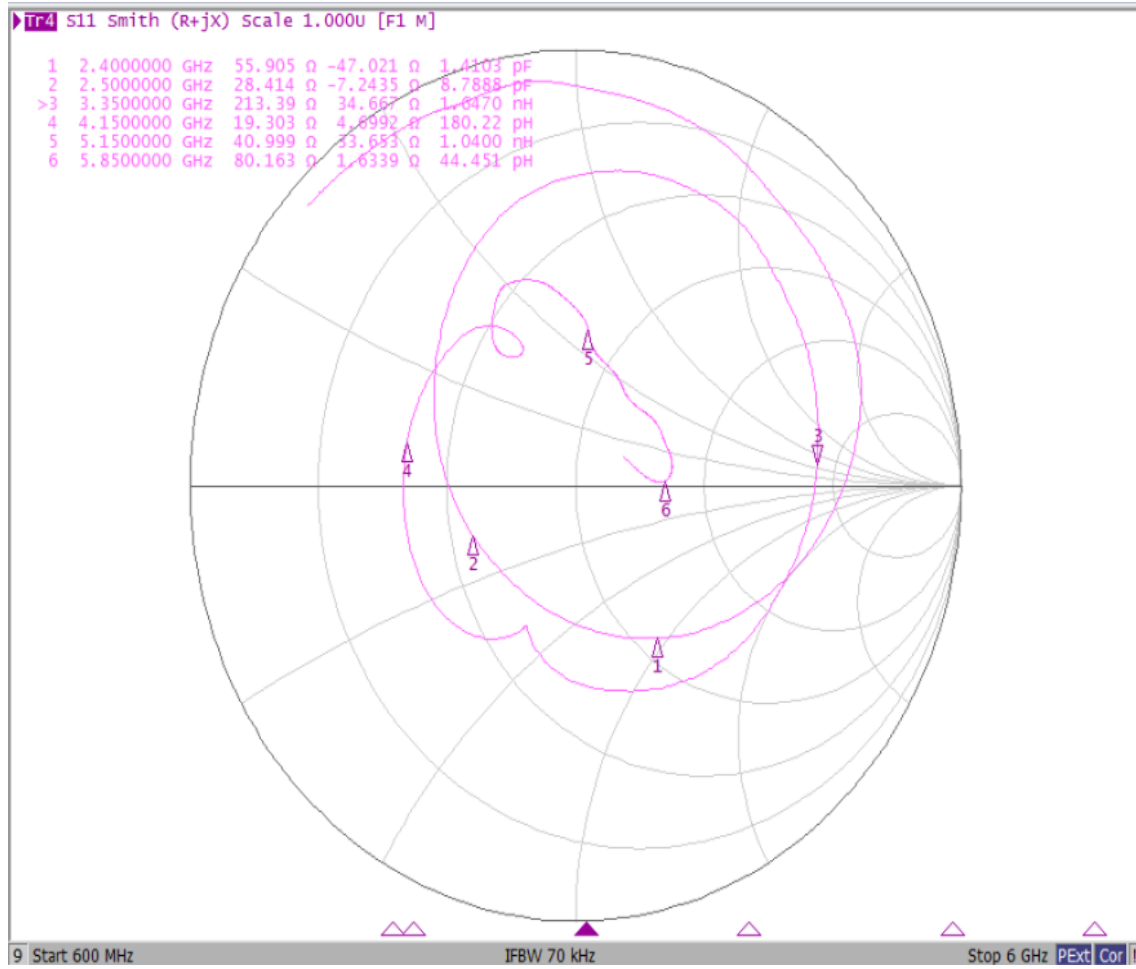

### 6.2.2 Antenna Pattern (2D or 3D)

#### 6.2.2.1 Antenna Pattern(2D)

##### (1) Chain 0 Antenna (ANT6)

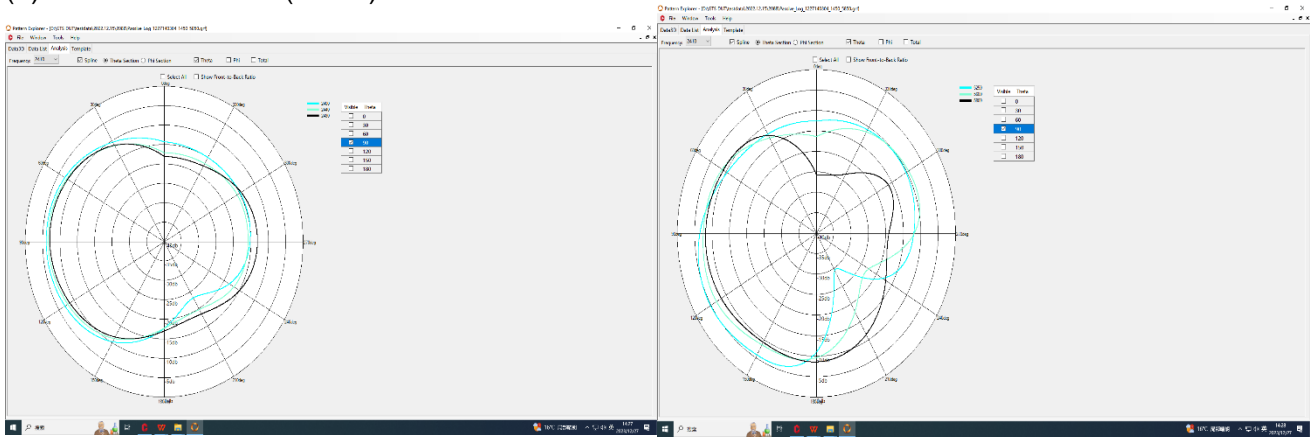

##### (2) Chain 1 Antenna (ANT7)

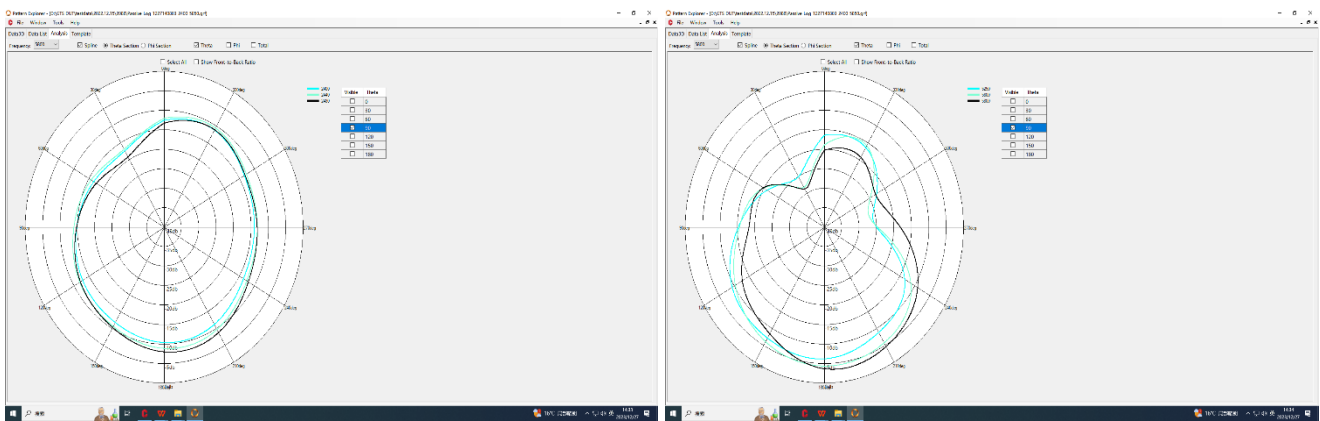

#### 6.2.2.2 Antenna Pattern(3D)

##### (1) Chain 0 Antenna (ANT6)

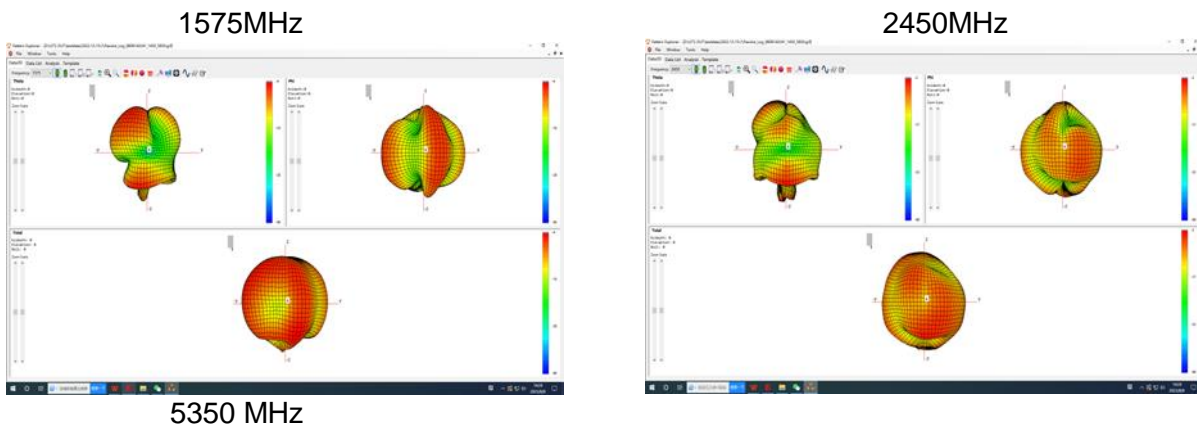

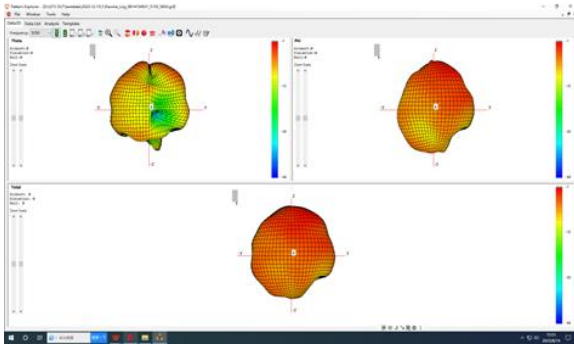

(2) Chain 1 Antenna (ANT7)

2450MHz

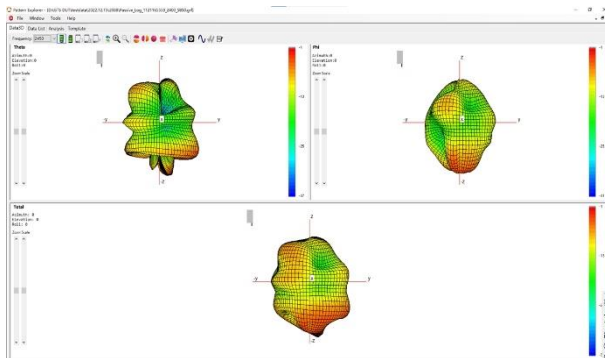

5350MHz

