



FCC RADIO TEST REPORT

FCC ID : PY7-35228T
Equipment : GSM/WCDMA/LTE Phone+Bluetooth,
DTS/UNII a/b/g/n/ac and NFC
Brand Name : Sony
Applicant : Sony Mobile Communications Inc.
4-12-3 Higashi-Shinagawa, Shinagawa-ku,
Tokyo, 140-0002, Japan
Manufacturer : Sony Mobile Communications Inc.
4-12-3 Higashi-Shinagawa, Shinagawa-ku,
Tokyo, 140-0002, Japan
Standard : 47 CFR Part 2, 22(H), 24(E), 27(L)

The product was received on Aug. 31, 2018 and testing was started from Oct. 01, 2018 and completed on Nov. 18, 2018. We, SPORTON INTERNATIONAL INC., would like to declare that the tested sample has been evaluated in accordance with the test procedures given in ANSI / TIA-603-E and has been in compliance with the applicable technical standards.

The report must not be used by the client to claim product certification, approval, or endorsement by TAF or any agency of government.

The test results in this report apply exclusively to the tested model / sample. Without written approval of SPORTON INTERNATIONAL INC. EMC & Wireless Communications Laboratory, the test report shall not be reproduced except in full.

Approved by: Jones Tsai

SPORTON INTERNATIONAL INC. EMC & Wireless Communications Laboratory

No. 52, Huaya 1st Rd., Guishan Dist., Taoyuan City, Taiwan (R.O.C.)



Table of Contents

History of this test report.....	3
Summary of Test Result.....	4
1 General Description	5
1.1 Product Feature of Equipment Under Test	5
1.2 Modification of EUT	5
1.3 Maximum ERP/EIRP Power, Frequency Tolerance, and Emission Designator	6
1.4 Testing Location	6
1.5 Applicable Standards.....	7
2 Test Configuration of Equipment Under Test.....	8
2.1 Test Mode	8
2.2 Connection Diagram of Test System	9
2.3 Support Unit used in test configuration	10
2.4 Measurement Results Explanation Example	10
2.5 Frequency List of Low/Middle/High Channels.....	11
3 Conducted Test Result	12
3.1 Measuring Instruments	12
3.2 Conducted Output Power and ERP/EIRP.....	13
3.3 Peak-to-Average Ratio	14
3.4 99% Occupied Bandwidth and 26dB Bandwidth Measurement.....	15
3.5 Conducted Band Edge	16
3.6 Conducted Spurious Emission.....	17
3.7 Frequency Stability.....	18
4 Radiated Test Items	19
4.1 Measuring Instruments	19
4.2 Test Setup	19
4.3 Test Result of Radiated Test.....	19
4.4 Field Strength of Spurious Radiation Measurement	20
5 List of Measuring Equipment	21
6 Uncertainty of Evaluation	23
Appendix A. Test Results of Conducted Test	
Appendix B. Test Results of ERP/EIRP and Radiated Test	



History of this test report

Report No.	Version	Description	Issued Date
FG882923-01A	01	Initial issue of report	Dec. 10, 2018
FG882923-01A	02	Revising test data.	Dec. 21, 2018



Summary of Test Result

Report Clause	Ref Std. Clause	Test Items	Result (PASS/FAIL)	Remark
3.2	§2.1046	Conducted Output Power	Pass	-
	§22.913 (a)(2)	Effective Radiated Power		
	§24.232 (c)	Equivalent Isotropic Radiated Power		
	§27.50 (d)(4)	Equivalent Isotropic Radiated Power		
3.3	§24.232 (d)	Peak-to-Average Ratio	Pass	-
3.4	§2.1049 §22.917 (b) §24.238 (b) §27.53 (g)	Occupied Bandwidth	Pass	-
3.5	§2.1051 §22.917 (a) §24.238 (a) §27.53 (g)	Band Edge Measurement	Pass	-
3.6	§2.1051 §22.917 (a) §24.238 (a) §27.53 (g)	Conducted Emission	Pass	-
3.7	§2.1055 §22.355	Frequency Stability Temperature & Voltage	Pass	-
	§2.1055 §24.235 §27.54			-
4.44	§2.1053 §22.917 (a) §24.238 (a) §27.53 (h)	Field Strength of Spurious Radiation	Pass	Under limit 26.71 dB at 5550.000 MHz

Reviewed by: Wii Chang

Report Producer: Natasha Hsieh



1 General Description

1.1 Product Feature of Equipment Under Test

GSM/WCDMA/LTE, Bluetooth, DTS/UNII a/b/g/n/ac, FM Receiver, NFC, and GNSS.

Product Specification subjective to this standard	
Antenna Type	Loop Antenna

EUT Information List			
HW Version	SW Version	S/N	Performed Test Item
A	1.129	CQ300166PR	Conducted Measurement
		CQ3001BTG5	Radiated Spurious Emission ERP/EIRP Test

Accessory List	
AC Adapter	Model Name: UCH32
	S/N: 6218W30200038
Earphone	Model Name: MH410c
	S/N: N/A
USB Cable	Model Name: UCB24
	S/N: N/A

Note:

1. Above EUT list used are electrically identical per declared by manufacturer.
2. Above the accessories list are used to exercise the EUT during test, and the serial number of each type of accessories is listed in each section of this report. .
3. For other wireless features of this EUT, test report will be issued separately.

1.2 Modification of EUT

No modifications are made to the EUT during all test items.



1.3 Maximum ERP/EIRP Power, Frequency Tolerance, and Emission Designator

FCC Rule	Frequency Range (MHz)	System	Type of Modulation	Maximum ERP/EIRP (W)	Frequency Tolerance (ppm)	Emission Designator
Part 22	824.2 ~848.8	GSM850 GPRS class 8	GMSK	0.5000	0.0634 ppm	245KGXW
Part 22	824.2 ~848.8	GSM850 EDGE class 8	8PSK	0.1227	0.0072 ppm	248KG7W
Part 22	826.4 ~846.6	WCDMA Band V RMC 12.2Kbps	BPSK	0.0716	0.0239 ppm	4M20F9W
Part 24	1850.2 ~1909.8	GSM1900 GSM	GMSK	0.5929	0.0394 ppm	247KGXW
Part 24	1850.2 ~1909.8	GSM1900 EDGE class 10	8PSK	0.2460	0.0335 ppm	249KG7W
Part 24	1852.4 ~ 1907.6	WCDMA Band II RMC 12.2Kbps	BPSK	0.1746	0.0043 ppm	4M16F9W
Part 27	1712.4 ~ 1752.6	WCDMA Band IV RMC 12.2Kbps	BPSK	0.2018	0.0369 ppm	4M18F9W

1.4 Testing Location

Sporton Lab is accredited to ISO 17025 by Taiwan Accreditation Foundation (TAF code : 1190) and the FCC designation No. TW1190 and TW0007 under the FCC 2.948(e) by Mutual Recognition Agreement (MRA) in FCC Test.

Test Site	SPORTON INTERNATIONAL INC.
Test Site Location	No.52, Huaya 1st Rd., Guishan Dist., Taoyuan City, Taiwan (R.O.C.) TEL: +886-3-327-3456 FAX: +886-3-328-4978
Test Site No.	Sporton Site No. TH03-HY

Note: The test site complies with ANSI C63.4 2014 requirement.

Test Site	SPORTON INTERNATIONAL INC.
Test Site Location	No.58, Aly. 75, Ln. 564, Wenhua 3rd, Rd., Guishan Dist., Taoyuan City, Taiwan (R.O.C.) TEL: +886-3-327-0868 FAX: +886-3-327-0855
Test Site No.	Sporton Site No. 03CH11-HY

Note: The test site complies with ANSI C63.4 2014 requirement.



1.5 Applicable Standards

According to the specifications of the manufacturer, the EUT must comply with the requirements of the following standards:

- ♦ ANSI C63.26-2015
- ♦ ANSI / TIA-603-E
- ♦ 47 CFR Part 2, 22(H), 24(E), 27(L)
- ♦ FCC KDB 971168 D01 Power Meas. License Digital Systems v03r01
- ♦ FCC KDB 412172 D01 Determining ERP and EIRP v01r01

Remark:

1. All test items were verified and recorded according to the standards and without any deviation during the test.
2. This EUT has also been tested and complied with the requirements of FCC Part 15, Subpart B, recorded in a separate test report.



2 Test Configuration of Equipment Under Test

2.1 Test Mode

Antenna port conducted and radiated test items were performed according to KDB 971168 D01 Power Meas. License Digital Systems v03r01 with maximum output power.

For radiated measurement, pre-scanned in three orthogonal panels, X, Y, Z. The worst cases (Y plane for AWS Band, and Z plane for Cellular Band and PCS Band) were recorded in this report.

Radiated emissions were investigated as following frequency range:

1. 30 MHz to 9000 MHz for GSM850 and WCDMA Band V.
2. 30 MHz to 18000 MHz for WCDMA Band IV.
3. 30 MHz to 19100 MHz for GSM1900 and WCDMA Band II.

All modes and data rates and positions were investigated.

Test modes are chosen to be reported as the worst case configuration below:

Test Modes		
Band	Radiated TCs	Conducted TCs
GSM 850	<ul style="list-style-type: none">■ GPRS Class 8 Link■ EDGE Class 8 Link	<ul style="list-style-type: none">■ GPRS Class 8 Link■ EDGE Class 8 Link
GSM 1900	<ul style="list-style-type: none">■ GSM Link■ EDGE Class 10 Link	<ul style="list-style-type: none">■ GSM Link■ EDGE Class 10 Link
WCDMA Band V	<ul style="list-style-type: none">■ RMC 12.2Kbps Link	<ul style="list-style-type: none">■ RMC 12.2Kbps Link
WCDMA Band II	<ul style="list-style-type: none">■ RMC 12.2Kbps Link	<ul style="list-style-type: none">■ RMC 12.2Kbps Link
WCDMA Band IV	<ul style="list-style-type: none">■ RMC 12.2Kbps Link	<ul style="list-style-type: none">■ RMC 12.2Kbps Link

2.2 Connection Diagram of Test System

<EUT without Accessory>

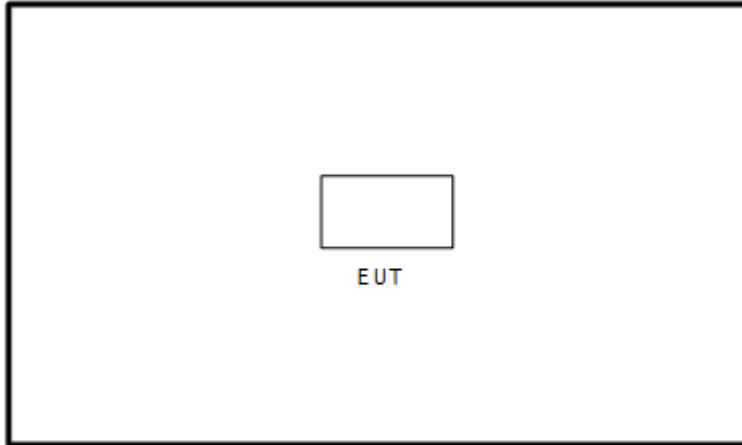

<EUT with Accessory>

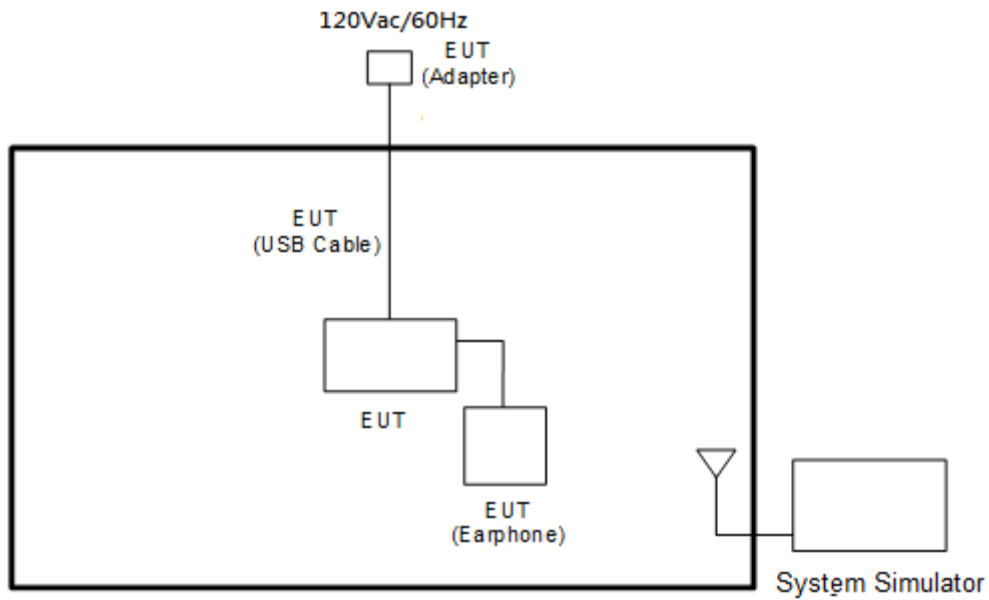



2.3 Support Unit used in test configuration

Item	Equipment	Trade Name	Model No.	FCC ID	Data Cable	Power Cord
1.	System Simulator	R&S	CMU 200	N/A	N/A	Unshielded, 1.8 m

2.4 Measurement Results Explanation Example

For all conducted test items:

The offset level is set in the spectrum analyzer to compensate the RF cable loss and attenuator factor between RF conducted output port and spectrum analyzer. With the offset compensation, the spectrum analyzer reading level will be exactly the RF output level.

The spectrum analyzer offset is derived from RF cable loss and attenuator factor.

$$\text{Offset} = \text{RF cable loss} + \text{attenuator factor}.$$

The following shows an offset computation example with RF cable loss 4.2 dB and a 10dB attenuator.

Example:

$$\begin{aligned} \text{Offset(dB)} &= \text{RF cable loss(dB)} + \text{attenuator factor(dB)}. \\ &= 4.2 + 10 = 14.2 \text{ (dB)} \end{aligned}$$



2.5 Frequency List of Low/Middle/High Channels

Frequency List				
Band	Channel/Frequency(MHz)	Lowest	Middle	Highest
GSM850	Channel	128	189	251
	Frequency	824.2	836.4	848.8
WCDMA Band V	Channel	4132	4182	4233
	Frequency	826.4	836.4	846.6
GSM1900	Channel	512	661	810
	Frequency	1850.2	1880.0	1909.8
WCDMA Band II	Channel	9262	9400	9538
	Frequency	1852.4	1880.0	1907.6
WCDMA Band IV	Channel	1312	1413	1513
	Frequency	1712.4	1732.6	1752.6

3 Conducted Test Result

3.1 Measuring Instruments

See list of measuring instruments of this test report.

3.1.1 Test Setup

3.1.2 Conducted Output Power



3.1.3 Peak-to-Average Ratio, Occupied Bandwidth, Conducted Band-Edge and Conducted Spurious Emission

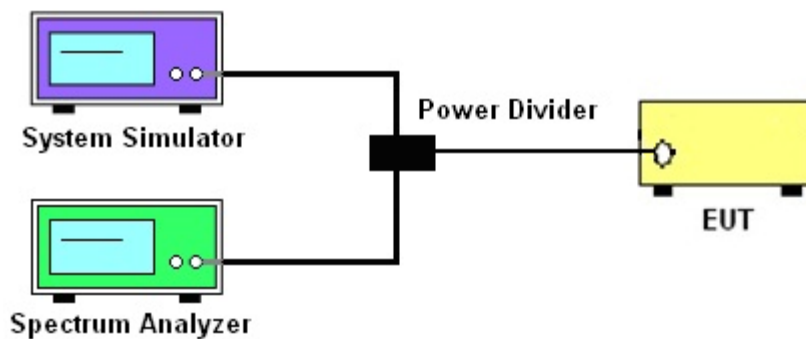

3.1.4 Frequency Stability

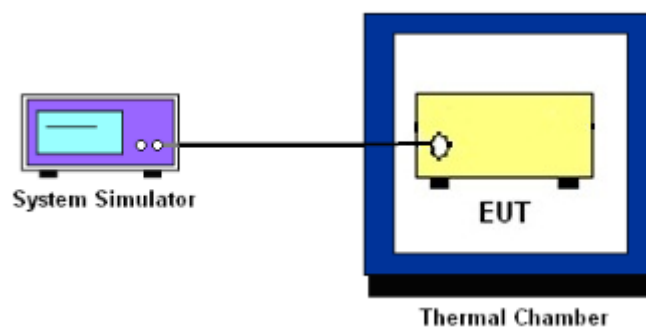

3.1.5 Test Result of Conducted Test

Please refer to Appendix A.



3.2 Conducted Output Power and ERP/EIRP

3.2.1 Description of the Conducted Output Power and ERP/EIRP

A system simulator was used to establish communication with the EUT. Its parameters were set to enforce EUT transmitting at the maximum power. The measured power in the radio frequency on the transmitter output terminals shall be reported.

The ERP of mobile transmitters must not exceed 7 Watts for GSM850 and WCDMA Band V.

The EIRP of mobile transmitters must not exceed 2 Watts for GSM1900 and WCDMA Band II.

The EIRP of mobile transmitters must not exceed 1 Watts for WCDMA Band IV.

According to KDB 412172 D01 Power Approach,

$EIRP = P_T + G_T - L_C$, $ERP = EIRP - 2.15$, where

P_T = transmitter output power in dBm

G_T = gain of the transmitting antenna in dBi

L_C = signal attenuation in the connecting cable between the transmitter and antenna in dB

3.2.2 Test Procedures

1. The transmitter output port was connected to the system simulator.
2. Set EUT at maximum power through system simulator.
3. Select lowest, middle, and highest channels for each band and different modulation.
4. Measure the maximum burst average power for GSM and maximum average power for other modulation signal.



3.3 Peak-to-Average Ratio

3.3.1 Description of the PAR Measurement

The peak-to-average ratio (PAR) of the transmission may not exceed 13 dB.

3.3.2 Test Procedures

The testing follows FCC KDB 971168 D01 v03r01 Section 5.7.1

1. The EUT was connected to spectrum analyzer and system simulator via a power divider.
2. Set EUT to transmit at maximum output power.
3. When the duty cycle is less than 98%, then signal gating will be implemented on the spectrum analyzer by triggering from the system simulator.
4. Set the CCDF (Complementary Cumulative Distribution Function) option of the spectrum analyzer.
5. Record the maximum PAPR level associated with a probability of 0.1%.



3.4 99% Occupied Bandwidth and 26dB Bandwidth Measurement

3.4.1 Description of 99% Occupied Bandwidth and 26dB Bandwidth Measurement

The occupied bandwidth is the width of a frequency band such that, below the lower and above the upper frequency limits, the mean powers emitted are each equal to a specified percentage 0.5% of the total mean transmitted power.

The 26 dB emission bandwidth is defined as the frequency range between two points, one above and one below the carrier frequency, at which the spectral density of the emission is attenuated 26 dB below the maximum in-band spectral density of the modulated signal. Spectral density (power per unit bandwidth) is to be measured with a detector of resolution bandwidth equal to approximately 1.0% of the emission bandwidth.

3.4.2 Test Procedures

The testing follows FCC KDB 971168 D01 v03r01 Section 4.2

1. The EUT was connected to spectrum analyzer and system simulator via a power divider.
2. The spectrum analyzer center frequency is set to the nominal EUT channel center frequency. The span range for the spectrum analyzer shall be between two and five times the anticipated OBW.
3. The nominal resolution bandwidth (RBW) shall be in the range of 1 to 5 % of the anticipated OBW, and the VBW shall be at least 3 times the RBW.
4. Set the detection mode to peak, and the trace mode to max hold.
5. Determine the reference value: Set the EUT to transmit a modulated signal. Allow the trace to stabilize. Set the spectrum analyzer marker to the highest level of the displayed trace.
(this is the reference value)
6. Determine the “-26 dB down amplitude” as equal to (Reference Value – X).
7. Place two markers, one at the lowest and the other at the highest frequency of the envelope of the spectral display such that each marker is at or slightly below the “-X dB down amplitude” determined in step 6. If a marker is below this “-X dB down amplitude” value it shall be placed as close as possible to this value. The OBW is the positive frequency difference between the two markers.
8. Use the 99 % power bandwidth function of the spectrum analyzer and report the measured bandwidth.



3.5 Conducted Band Edge

3.5.1 Description of Conducted Band Edge Measurement

The power of any emission outside of the authorized operating frequency ranges must be lower than the transmitter power (P) by a factor of at least $43 + 10 \log (P)$ dB.

3.5.2 Test Procedures

The testing follows FCC KDB 971168 D01 v03r01 Section 6.0.

1. The EUT was connected to the spectrum analyzer and system simulator via a power divider.
2. The RF output of EUT was connected to the spectrum analyzer by an RF cable and attenuator. The path loss was compensated to the results for each measurement.
3. The band edges of low and high channels for the highest RF powers were measured.
4. The RF fundamental frequency should be excluded against the limit line in the operating frequency band.
5. The limit line is derived from $43 + 10\log(P)$ dB below the transmitter power P(Watts)



3.6 Conducted Spurious Emission

3.6.1 Description of Conducted Spurious Emission Measurement

The power of any emission outside of the authorized operating frequency ranges must be lower than the transmitter power (P) by a factor of at least $43 + 10 \log (P)$ dB.

It is measured by means of a calibrated spectrum analyzer and scanned from 30 MHz up to a frequency including its 10th harmonic.

3.6.2 Test Procedures

The testing follows FCC KDB 971168 D01 v03r01 Section 6.0.

1. The EUT was connected to the spectrum analyzer and system simulator via a power divider.
2. The RF output of EUT was connected to the spectrum analyzer by an RF cable and attenuator.
The path loss was compensated to the results for each measurement.
3. The middle channel for the highest RF power within the transmitting frequency was measured.
4. The conducted spurious emission for the whole frequency range was taken.
5. The RF fundamental frequency should be excluded against the limit line in the operating frequency band.
6. The limit line is derived from $43 + 10\log(P)$ dB below the transmitter power P(Watts)



3.7 Frequency Stability

3.7.1 Description of Frequency Stability Measurement

22.355

The frequency stability shall be measured by variation of ambient temperature and variation of primary supply voltage to ensure that the fundamental emission stays within the authorized frequency block. The frequency stability of the transmitter shall be maintained within $\pm 0.00025\%$ ($\pm 2.5\text{ppm}$) of the center frequency.

24.235 & 27.54

The frequency stability shall be sufficient to ensure that the fundamental emission stays within the authorized frequency block.

3.7.2 Test Procedures for Temperature Variation

The testing follows FCC KDB 971168 D01 v03r01 Section 9.0.

1. The EUT was set up in the thermal chamber and connected with the system simulator.
2. With power OFF, the temperature was decreased to -30°C and the EUT was stabilized before testing. Power was applied and the maximum change in frequency was recorded within one minute.
3. With power OFF, the temperature was raised in 10°C steps up to 50°C . The EUT was stabilized at each step for at least half an hour. Power was applied and the maximum frequency change was recorded within one minute.

3.7.3 Test Procedures for Voltage Variation

The testing follows FCC KDB 971168 D01 v03r01 Section 9.0.

1. The EUT was placed in a temperature chamber at $20\pm 5^{\circ}\text{C}$ and connected with the system simulator.
2. The power supply voltage to the EUT was varied from 85% to 115% of the nominal value measured at the input to the EUT.
3. The variation in frequency was measured for the worst case.

4 Radiated Test Items

4.1 Measuring Instruments

See list of measuring instruments of this test report.

4.2 Test Setup

For radiated test from 30MHz to 1GHz

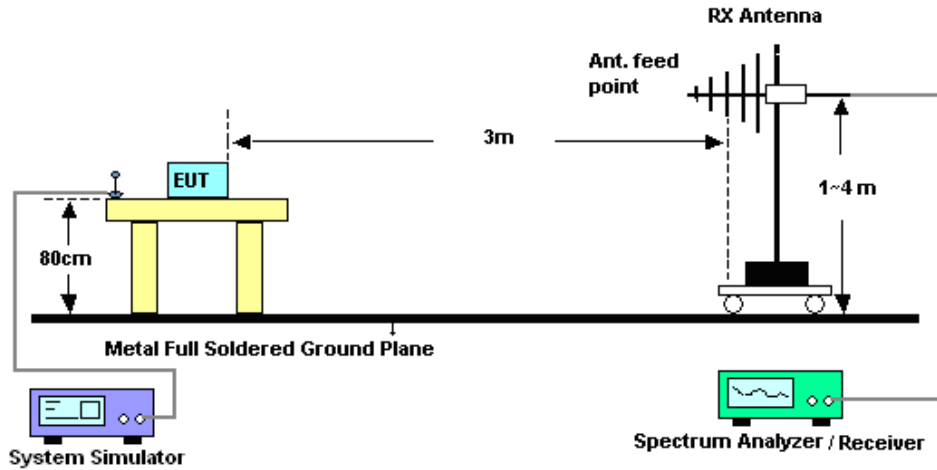

For radiated test above 1GHz

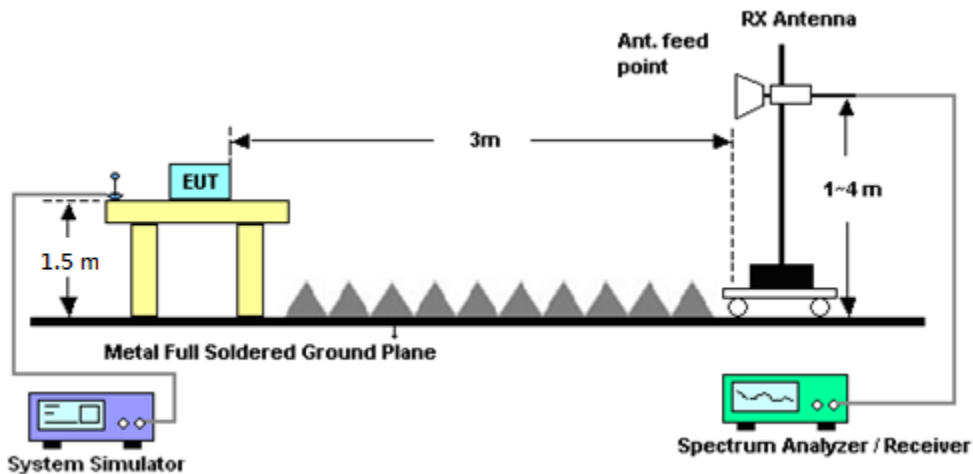

4.3 Test Result of Radiated Test

Please refer to Appendix B.



4.4 Field Strength of Spurious Radiation Measurement

4.4.1 Description of Field Strength of Spurious Radiated Measurement

The power of any emission outside of the authorized operating frequency ranges must be attenuated below the transmitter power (P) by a factor of at least $43 + 10 \log (P)$ dB. The spectrum is scanned from 30 MHz up to a frequency including its 10th harmonic.

4.4.2 Test Procedures

The testing follows FCC KDB 971168 D01 v03r01 Section 5.8 and ANSI / TIA-603-E Section 2.2.12.

1. The EUT was placed on a rotatable wooden table 0.8 meters for frequency below 1GHz and 1.5 meter for frequency above 1GHz above the ground.
2. The EUT was set 3 meters from the receiving antenna, which was mounted on the antenna tower.
3. The table was rotated 360 degrees to determine the position of the highest spurious emission.
4. The height of the receiving antenna is varied between one meter and four meters to search for the maximum spurious emission for both horizontal and vertical polarizations.
5. Make the measurement with the spectrum analyzer's RBW = 1MHz, VBW = 3MHz, taking record of maximum spurious emission.
6. A horn antenna was substituted in place of the EUT and was driven by a signal generator.
7. Tune the output power of signal generator to the same emission level with EUT maximum spurious emission.
8. Taking the record of output power at antenna port.
9. Repeat step 7 to step 8 for another polarization.
10. $EIRP (dBm) = S.G. Power - Tx Cable Loss + Tx Antenna Gain$
11. $ERP (dBm) = EIRP - 2.15$
12. The RF fundamental frequency should be excluded against the limit line in the operating frequency band.
13. The limit line is derived from $43 + 10\log(P)$ dB below the transmitter power P(Watts)



5 List of Measuring Equipment

Instrument	Manufacturer	Model No.	Serial No.	Characteristics	Calibration Date	Test Date	Due Date	Remark
Base Station (Measure)	Rohde & Schwarz	CMU200	117995	GSM / GPRS / WCDMA / CDMA	Aug. 15, 2018	Oct. 01, 2018~ Oct. 11, 2018	Aug. 14, 2019	Conducted (TH03-HY)
Spectrum Analyzer	Rohde & Schwarz	FSP30	101329	9kHz~30GHz	Jun. 25, 2018	Oct. 01, 2018~ Oct. 11, 2018	Jun. 24, 2019	Conducted (TH03-HY)
Temperature Chamber	ESPEC	SU-641	92013721	-30°C ~70°C	Dec. 06, 2017	Oct. 01, 2018~ Oct. 11, 2018	Dec. 05, 2019	Conducted (TH03-HY)
Programmable Power Supply	GW Instek	PSS-2005	EL883644	Voltage:0~20V;Current:0~5A	Dec. 06, 2017	Oct. 01, 2018~ Oct. 11, 2018	Dec. 05, 2019	Conducted (TH03-HY)
Hygrometer	Testo	608-H1	34893241	N/A	Mar. 06, 2018	Oct. 01, 2018~ Oct. 11, 2018	Mar. 05, 2019	Conducted (TH03-HY)
Loop Antenna	Rohde & Schwarz	HFH2-Z2	100488	9 kHz~30 MHz	Nov. 23, 2017	Oct. 15, 2018~ Nov. 18, 2018	Nov. 22, 2019	Radiation (03CH11-HY)
Bilog Antenna	TESEQ	CBL 6111D &N-6-06	35414&AT-N0602	30MHz~1GHz	Oct. 13, 2018	Oct. 15, 2018~ Nov. 18, 2018	Oct. 12, 2019	Radiation (03CH11-HY)
Horn Antenna	ESCO	3117	00066584	1GHz~18GHz	Sep. 17, 2018	Oct. 15, 2018~ Oct. 31, 2018	Sep. 16, 2019	Radiation (03CH11-HY)
Horn Antenna	SCHWARZBECK	BBHA 9120 D	BBHA 9120 D 1212	1GHz ~ 18GHz	May 10, 2018	Nov. 18, 2018	May 09, 2019	Radiation (03CH11-HY)
SHF-EHF Horn Antenna	SCHWARZBECK	BBHA 9170	BBHA9170584	18GHz- 40GHz	Nov. 27, 2017	Oct. 15, 2018~ Nov. 18, 2018	Nov. 26, 2018	Radiation (03CH11-HY)
SHF-EHF Horn Antenna	SCHWARZBECK	BBHA 9170	BBHA9170576	18GHz ~ 40GHz	May 08, 2018	Oct. 15, 2018~ Nov. 18, 2018	May 07, 2019	Radiation (03CH11-HY)
Preamplifier	Keysight	83017A	MY53270080	1GHz~26.5GHz	Nov. 10, 2016	Oct. 15, 2018~ Oct. 31, 2018	Nov. 09, 2018	Radiation (03CH11-HY)
Preamplifier	Keysight	83017A	MY53270080	1GHz~26.5GHz	Nov. 14, 2018	Nov. 18, 2018	Nov. 13, 2020	Radiation (03CH11-HY)
Amplifier	MITEQ	TTA1840-35-HG	1871923	18GHz~40GHz, VSWR : 2.5:1 max	Jul. 16, 2018	Oct. 15, 2018~ Nov. 18, 2018	Jul. 15, 2019	Radiation (03CH11-HY)
Spectrum Analyzer	Keysight	N9010A	MY55370526	10Hz ~ 44GHz	Mar. 15, 2018	Oct. 15, 2018~ Nov. 18, 2018	Mar. 14, 2019	Radiation (03CH11-HY)
Amplifier	SONOMA	310N	187312	9kHz~1GHz	Jan. 16, 2018	Oct. 15, 2018~ Nov. 18, 2018	Jan. 15, 2019	Radiation (03CH11-HY)



Instrument	Manufacturer	Model No.	Serial No.	Characteristics	Calibration Date	Test Date	Due Date	Remark
Hygrometer	Testo	DTM-303A	TP157075	N/A	Mar. 06, 2018	Oct. 15, 2018~ Nov. 18, 2018	Mar. 05, 2019	Radiation (03CH11-HY)
Notch Filter	Wainwright	WRCT2300/ 2500-20/40- 10SSK	SN1	2300/2500	Aug. 23, 2018	Oct. 15, 2018~ Nov. 18, 2018	Aug. 22, 2019	Radiation (03CH11-HY)
Notch Filter	Wainwright	WRCD1800/ 2000-20/40- 10SSK	SN1	LTE Band 25	Aug. 23, 2018	Oct. 15, 2018~ Nov. 18, 2018	Aug. 22, 2019	Radiation (03CH11-HY)
Notch Filter	Wainwright	WTRCT5-82 4-849-20-70- 60SSK	SN1	824-849	Mar. 22, 2018	Oct. 15, 2018~ Nov. 18, 2018	Mar. 21, 2019	Radiation (03CH11-HY)
Notch Filter	Wainwright	WRCT10-19 20-1980-20- 40-40SSK	SN1	1920-1980	May 22, 2018	Oct. 15, 2018~ Nov. 18, 2018	May 21, 2019	Radiation (03CH11-HY)
Notch Filter	Wainwright	WTRCD10-1 710-1785-20 -40-40SSK	SN1	1710-1785	May 22, 2018	Oct. 15, 2018~ Nov. 18, 2018	May 21, 2019	Radiation (03CH11-HY)
Filter	Wainwright	WHKX12-10 80-1200-150 0-60SS	SN2	1.2G High Pass	Sep. 16, 2018	Oct. 15, 2018~ Nov. 18, 2018	Sep. 17, 2019	Radiation (03CH11-HY)
Filter	Wainwright	WHKX12-27 00-3000-180 00-60SS	SN3	2.7G High Pass	Sep. 16, 2018	Oct. 15, 2018~ Nov. 18, 2018	Sep. 17, 2019	Radiation (03CH11-HY)
RF Cable	HUBER + SUHNER	SUCOFLEX 104	MY9837/4P E	9kHz-30MHz	Mar. 14, 2018	Oct. 15, 2018~ Nov. 18, 2018	Mar. 13, 2019	Radiation (03CH11-HY)
RF Cable	HUBER + SUHNER	SUCOFLEX 102	MY2859/2	30MHz-40GHz	Mar. 14, 2018	Oct. 15, 2018~ Nov. 18, 2018	Mar. 13, 2019	Radiation (03CH11-HY)
RF Cable	HUBER + SUHNER	SUCOFLEX 104	MY9837/4P E	30M-18G	Mar. 14, 2018	Oct. 15, 2018~ Nov. 18, 2018	Mar. 13, 2019	Radiation (03CH11-HY)
Controller	EMEC	EM 1000	N/A	Control Turn table & Ant Mast	N/A	Oct. 15, 2018~ Nov. 18, 2018	N/A	Radiation (03CH11-HY)
Antenna Mast	EMEC	AM-BS-4500 -B	N/A	1~4m	N/A	Oct. 15, 2018~ Nov. 18, 2018	N/A	Radiation (03CH11-HY)
Turn Table	EMEC	TT 2000	N/A	0~360 Degree	N/A	Oct. 15, 2018~ Nov. 18, 2018	N/A	Radiation (03CH11-HY)
Signal Generator	Rohde & Schwarz	SMF100A	101107	100kHz~40GHz	May 22, 2018	Oct. 15, 2018~ Nov. 18, 2018	May 21, 2019	Radiation (03CH11-HY)
Software	Audix	E3 6.2009-8-24	RK-001042	N/A	N/A	Oct. 15, 2018~ Nov. 18, 2018	N/A	Radiation (03CH11-HY)



6 Uncertainty of Evaluation

Uncertainty of Radiated Emission Measurement (30 MHz ~ 1000 MHz)

Measuring Uncertainty for a Level of Confidence of 95% ($U = 2Uc(y)$)	5.20
---	------

Uncertainty of Radiated Emission Measurement (1 GHz ~ 18 GHz)

Measuring Uncertainty for a Level of Confidence of 95% ($U = 2Uc(y)$)	5.50
---	------

Uncertainty of Radiated Emission Measurement (18 GHz ~ 40 GHz)

Measuring Uncertainty for a Level of Confidence of 95% ($U = 2Uc(y)$)	5.20
---	------



Appendix A. Test Results of Conducted Test

Conducted Output Power(Average power)

Conducted Power (*Unit: dBm)						
Band	GSM850			GSM1900		
Channel	128	189	251	512	661	810
Frequency	824.2	836.4	848.8	1850.2	1880	1909.8
GSM	32.75	32.91	32.97	29.69	29.62	29.78
GPRS class 8	32.96	32.93	32.99	29.51	29.64	29.63
GPRS class 10	30.69	30.82	30.58	27.04	27.11	27.08
GPRS class 11	28.37	28.47	28.34	25.72	25.36	25.86
GPRS class 12	27.47	27.42	27.44	24.87	24.85	24.94
EGPRS class 8	26.86	26.89	26.72	25.83	25.93	25.73
EGPRS class 10	26.69	26.67	26.58	25.67	25.81	25.96
EGPRS class 11	26.14	26.16	26.32	25.49	25.49	25.50
EGPRS class 12	25.88	26.04	26.08	24.53	24.99	24.90

Conducted Power (*Unit: dBm)						
Band	WCDMA Band V			WCDMA Band II		
Channel	4132	4182	4233	9262	9400	9538
Frequency	826.4	836.4	846.6	1852.4	1880	1907.6
RMC 12.2K	24.55	24.42	24.51	24.43	24.37	24.47
HSDPA Subtest-1	23.54	23.46	23.52	23.57	23.54	23.49
HSDPA Subtest-2	23.59	23.41	23.50	23.58	23.57	23.51
HSDPA Subtest-3	23.07	23.00	23.06	23.11	23.07	23.04
HSDPA Subtest-4	23.07	23.00	23.08	23.11	23.06	23.03
HSUPA Subtest-1	23.47	23.31	23.38	23.50	23.48	23.40
HSUPA Subtest-2	21.45	21.35	21.37	21.48	21.50	21.48
HSUPA Subtest-3	22.47	22.35	22.35	22.46	22.40	22.40
HSUPA Subtest-4	21.43	21.27	21.40	21.48	21.43	21.39
HSUPA Subtest-5	23.45	23.35	23.35	23.45	23.40	23.45

Conducted Power (*Unit: dBm)			
Band	WCDMA Band IV		
Channel	1312	1413	1513
Frequency	1712.4	1732.6	1752.6
RMC 12.2K	24.36	24.43	24.36
HSDPA Subtest-1	23.40	23.47	23.34
HSDPA Subtest-2	23.41	23.47	23.33
HSDPA Subtest-3	22.92	22.95	22.89
HSDPA Subtest-4	22.91	22.93	22.90
HSUPA Subtest-1	22.45	22.43	22.43
HSUPA Subtest-2	20.50	20.43	20.42
HSUPA Subtest-3	21.45	21.41	21.41
HSUPA Subtest-4	20.46	20.41	20.40
HSUPA Subtest-5	22.45	22.50	22.48



A2. GSM

Peak-to-Average Ratio

Mode	GSM850		Limit: 13dB
Mod.	GPRS class 8	EDGE class 8	Result
Lowest CH	0.40	3.24	PASS
Middle CH	0.36	3.28	
Highest CH	0.36	3.56	

Mode	GSM1900		Limit: 13dB
Mod.	GSM	EDGE class 10	Result
Lowest CH	0.28	3.24	PASS
Middle CH	0.32	3.20	
Highest CH	0.32	3.32	

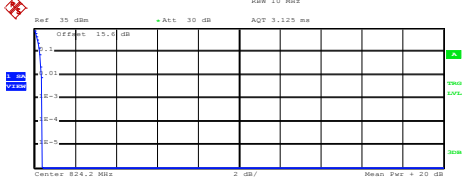
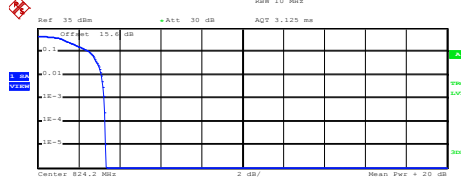
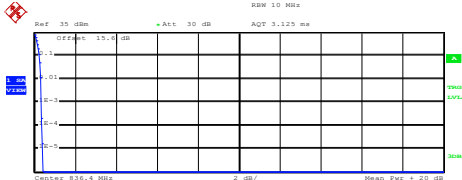
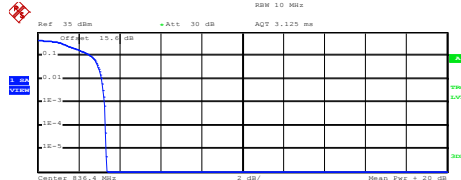
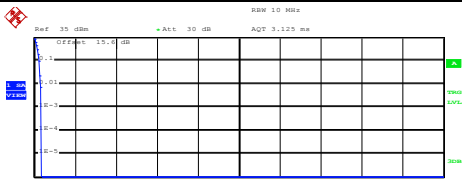
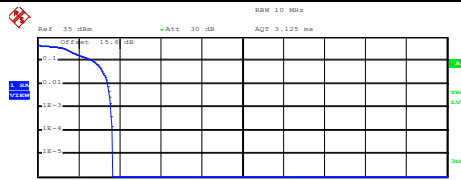

GSM850 (GPRS class 8)	GSM850 (EDGE class 8)																
<p style="text-align: center;">Lowest Channel</p>  <p>Complementary Cumulative Distribution Function (100000 samples) Trace 1 Mean 33.11 dBm Peak 33.49 dBm Crest 0.38 dB</p> <table border="1"> <tr><td>10 %</td><td>0.28 dB</td></tr> <tr><td>1 %</td><td>0.36 dB</td></tr> <tr><td>.1 %</td><td>0.40 dB</td></tr> <tr><td>.01 %</td><td>0.40 dB</td></tr> </table> <p>Date: 1.OCT.2018 17:35:54</p>	10 %	0.28 dB	1 %	0.36 dB	.1 %	0.40 dB	.01 %	0.40 dB	<p style="text-align: center;">Lowest Channel</p>  <p>Complementary Cumulative Distribution Function (100000 samples) Trace 1 Mean 27.53 dBm Peak 30.88 dBm Crest 3.35 dB</p> <table border="1"> <tr><td>10 %</td><td>2.52 dB</td></tr> <tr><td>1 %</td><td>3.12 dB</td></tr> <tr><td>.1 %</td><td>3.24 dB</td></tr> <tr><td>.01 %</td><td>3.32 dB</td></tr> </table> <p>Date: 1.OCT.2018 16:20:48</p>	10 %	2.52 dB	1 %	3.12 dB	.1 %	3.24 dB	.01 %	3.32 dB
10 %	0.28 dB																
1 %	0.36 dB																
.1 %	0.40 dB																
.01 %	0.40 dB																
10 %	2.52 dB																
1 %	3.12 dB																
.1 %	3.24 dB																
.01 %	3.32 dB																
<p style="text-align: center;">Middle Channel</p>  <p>Complementary Cumulative Distribution Function (100000 samples) Trace 1 Mean 33.16 dBm Peak 33.56 dBm Crest 0.40 dB</p> <table border="1"> <tr><td>10 %</td><td>0.24 dB</td></tr> <tr><td>1 %</td><td>0.32 dB</td></tr> <tr><td>.1 %</td><td>0.36 dB</td></tr> <tr><td>.01 %</td><td>0.40 dB</td></tr> </table> <p>Date: 1.OCT.2018 17:36:10</p>	10 %	0.24 dB	1 %	0.32 dB	.1 %	0.36 dB	.01 %	0.40 dB	<p style="text-align: center;">Middle Channel</p>  <p>Complementary Cumulative Distribution Function (100000 samples) Trace 1 Mean 27.49 dBm Peak 30.88 dBm Crest 3.39 dB</p> <table border="1"> <tr><td>10 %</td><td>2.60 dB</td></tr> <tr><td>1 %</td><td>3.12 dB</td></tr> <tr><td>.1 %</td><td>3.28 dB</td></tr> <tr><td>.01 %</td><td>3.32 dB</td></tr> </table> <p>Date: 1.OCT.2018 16:21:00</p>	10 %	2.60 dB	1 %	3.12 dB	.1 %	3.28 dB	.01 %	3.32 dB
10 %	0.24 dB																
1 %	0.32 dB																
.1 %	0.36 dB																
.01 %	0.40 dB																
10 %	2.60 dB																
1 %	3.12 dB																
.1 %	3.28 dB																
.01 %	3.32 dB																
<p style="text-align: center;">Highest Channel</p>  <p>Complementary Cumulative Distribution Function (100000 samples) Trace 1 Mean 33.28 dBm Peak 33.63 dBm Crest 0.36 dB</p> <table border="1"> <tr><td>10 %</td><td>0.24 dB</td></tr> <tr><td>1 %</td><td>0.32 dB</td></tr> <tr><td>.1 %</td><td>0.36 dB</td></tr> <tr><td>.01 %</td><td>0.36 dB</td></tr> </table> <p>Date: 1.OCT.2018 17:36:22</p>	10 %	0.24 dB	1 %	0.32 dB	.1 %	0.36 dB	.01 %	0.36 dB	<p style="text-align: center;">Highest Channel</p>  <p>Complementary Cumulative Distribution Function (100000 samples) Trace 1 Mean 27.15 dBm Peak 30.81 dBm Crest 3.66 dB</p> <table border="1"> <tr><td>10 %</td><td>2.68 dB</td></tr> <tr><td>1 %</td><td>3.40 dB</td></tr> <tr><td>.1 %</td><td>3.56 dB</td></tr> <tr><td>.01 %</td><td>3.64 dB</td></tr> </table> <p>Date: 1.OCT.2018 16:21:12</p>	10 %	2.68 dB	1 %	3.40 dB	.1 %	3.56 dB	.01 %	3.64 dB
10 %	0.24 dB																
1 %	0.32 dB																
.1 %	0.36 dB																
.01 %	0.36 dB																
10 %	2.68 dB																
1 %	3.40 dB																
.1 %	3.56 dB																
.01 %	3.64 dB																

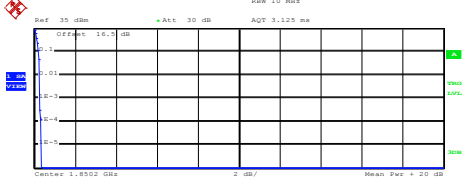
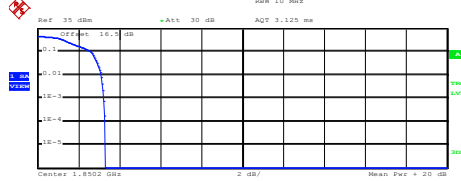
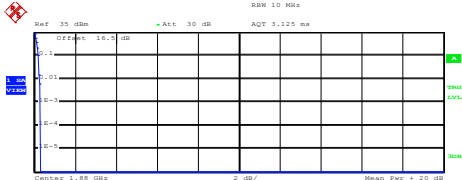
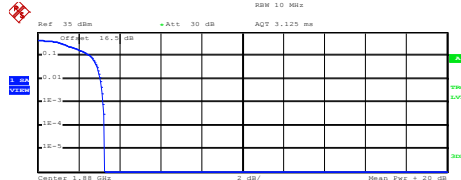
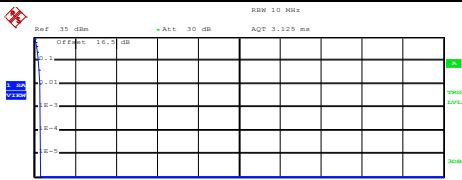
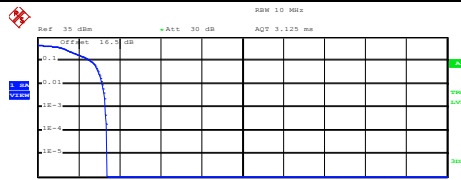

GSM1900 (GSM)	GSM1900 (EDGE class 10)																
<p align="center">Lowest Channel</p>  <p>Ref: 35 dBm RBW: 10 MHz AQT: 3.125 ms Att: 30 dB</p> <p>Center: 1.8502 GHz 2 dB/</p> <p>Complementary Cumulative Distribution Function (100000 samples) Trace 1 Mean: 30.75 dBm Peak: 31.09 dBm Crest: 0.35 dB</p> <table border="1"> <tr><td>10 %</td><td>0.20 dB</td></tr> <tr><td>1 %</td><td>0.28 dB</td></tr> <tr><td>.1 %</td><td>0.28 dB</td></tr> <tr><td>.01 %</td><td>0.32 dB</td></tr> </table> <p>Date: 1.OCT.2018 17:26:39</p>	10 %	0.20 dB	1 %	0.28 dB	.1 %	0.28 dB	.01 %	0.32 dB	<p align="center">Lowest Channel</p>  <p>Ref: 35 dBm RBW: 10 MHz AQT: 3.125 ms Att: 30 dB</p> <p>Center: 1.8502 GHz 2 dB/</p> <p>Complementary Cumulative Distribution Function (100000 samples) Trace 1 Mean: 25.41 dBm Peak: 28.69 dBm Crest: 3.29 dB</p> <table border="1"> <tr><td>10 %</td><td>2.60 dB</td></tr> <tr><td>1 %</td><td>3.12 dB</td></tr> <tr><td>.1 %</td><td>3.24 dB</td></tr> <tr><td>.01 %</td><td>3.28 dB</td></tr> </table> <p>Date: 1.OCT.2018 17:08:39</p>	10 %	2.60 dB	1 %	3.12 dB	.1 %	3.24 dB	.01 %	3.28 dB
10 %	0.20 dB																
1 %	0.28 dB																
.1 %	0.28 dB																
.01 %	0.32 dB																
10 %	2.60 dB																
1 %	3.12 dB																
.1 %	3.24 dB																
.01 %	3.28 dB																
<p align="center">Middle Channel</p>  <p>Ref: 35 dBm RBW: 10 MHz AQT: 3.125 ms Att: 30 dB</p> <p>Center: 1.85 GHz 2 dB/</p> <p>Complementary Cumulative Distribution Function (100000 samples) Trace 1 Mean: 30.86 dBm Peak: 31.16 dBm Crest: 0.31 dB</p> <table border="1"> <tr><td>10 %</td><td>0.20 dB</td></tr> <tr><td>1 %</td><td>0.28 dB</td></tr> <tr><td>.1 %</td><td>0.32 dB</td></tr> <tr><td>.01 %</td><td>0.32 dB</td></tr> </table> <p>Date: 1.OCT.2018 17:26:56</p>	10 %	0.20 dB	1 %	0.28 dB	.1 %	0.32 dB	.01 %	0.32 dB	<p align="center">Middle Channel</p>  <p>Ref: 35 dBm RBW: 10 MHz AQT: 3.125 ms Att: 30 dB</p> <p>Center: 1.85 GHz 2 dB/</p> <p>Complementary Cumulative Distribution Function (100000 samples) Trace 1 Mean: 25.56 dBm Peak: 28.83 dBm Crest: 3.27 dB</p> <table border="1"> <tr><td>10 %</td><td>2.56 dB</td></tr> <tr><td>1 %</td><td>3.08 dB</td></tr> <tr><td>.1 %</td><td>3.20 dB</td></tr> <tr><td>.01 %</td><td>3.28 dB</td></tr> </table> <p>Date: 1.OCT.2018 17:08:52</p>	10 %	2.56 dB	1 %	3.08 dB	.1 %	3.20 dB	.01 %	3.28 dB
10 %	0.20 dB																
1 %	0.28 dB																
.1 %	0.32 dB																
.01 %	0.32 dB																
10 %	2.56 dB																
1 %	3.08 dB																
.1 %	3.20 dB																
.01 %	3.28 dB																
<p align="center">Highest Channel</p>  <p>Ref: 35 dBm RBW: 10 MHz AQT: 3.125 ms Att: 30 dB</p> <p>Center: 1.9098 GHz 2 dB/</p> <p>Complementary Cumulative Distribution Function (100000 samples) Trace 1 Mean: 30.66 dBm Peak: 30.95 dBm Crest: 0.29 dB</p> <table border="1"> <tr><td>10 %</td><td>0.20 dB</td></tr> <tr><td>1 %</td><td>0.28 dB</td></tr> <tr><td>.1 %</td><td>0.32 dB</td></tr> <tr><td>.01 %</td><td>0.32 dB</td></tr> </table> <p>Date: 1.OCT.2018 17:27:11</p>	10 %	0.20 dB	1 %	0.28 dB	.1 %	0.32 dB	.01 %	0.32 dB	<p align="center">Highest Channel</p>  <p>Ref: 35 dBm RBW: 10 MHz AQT: 3.125 ms Att: 30 dB</p> <p>Center: 1.9098 GHz 2 dB/</p> <p>Complementary Cumulative Distribution Function (100000 samples) Trace 1 Mean: 25.31 dBm Peak: 28.69 dBm Crest: 3.38 dB</p> <table border="1"> <tr><td>10 %</td><td>2.60 dB</td></tr> <tr><td>1 %</td><td>3.16 dB</td></tr> <tr><td>.1 %</td><td>3.32 dB</td></tr> <tr><td>.01 %</td><td>3.40 dB</td></tr> </table> <p>Date: 1.OCT.2018 17:09:04</p>	10 %	2.60 dB	1 %	3.16 dB	.1 %	3.32 dB	.01 %	3.40 dB
10 %	0.20 dB																
1 %	0.28 dB																
.1 %	0.32 dB																
.01 %	0.32 dB																
10 %	2.60 dB																
1 %	3.16 dB																
.1 %	3.32 dB																
.01 %	3.40 dB																



26dB Bandwidth

Mode	GSM850 : 26dB BW(MHz)	
Mod.	GPRS class 8	EDGE class 8
Lowest CH	0.315	0.299
Middle CH	0.315	0.299
Highest CH	0.303	0.295

Mode	GSM1900 : 26dB BW(MHz)	
Mod.	GSM	EDGE class 10
Lowest CH	0.310	0.298
Middle CH	0.312	0.302
Highest CH	0.317	0.307

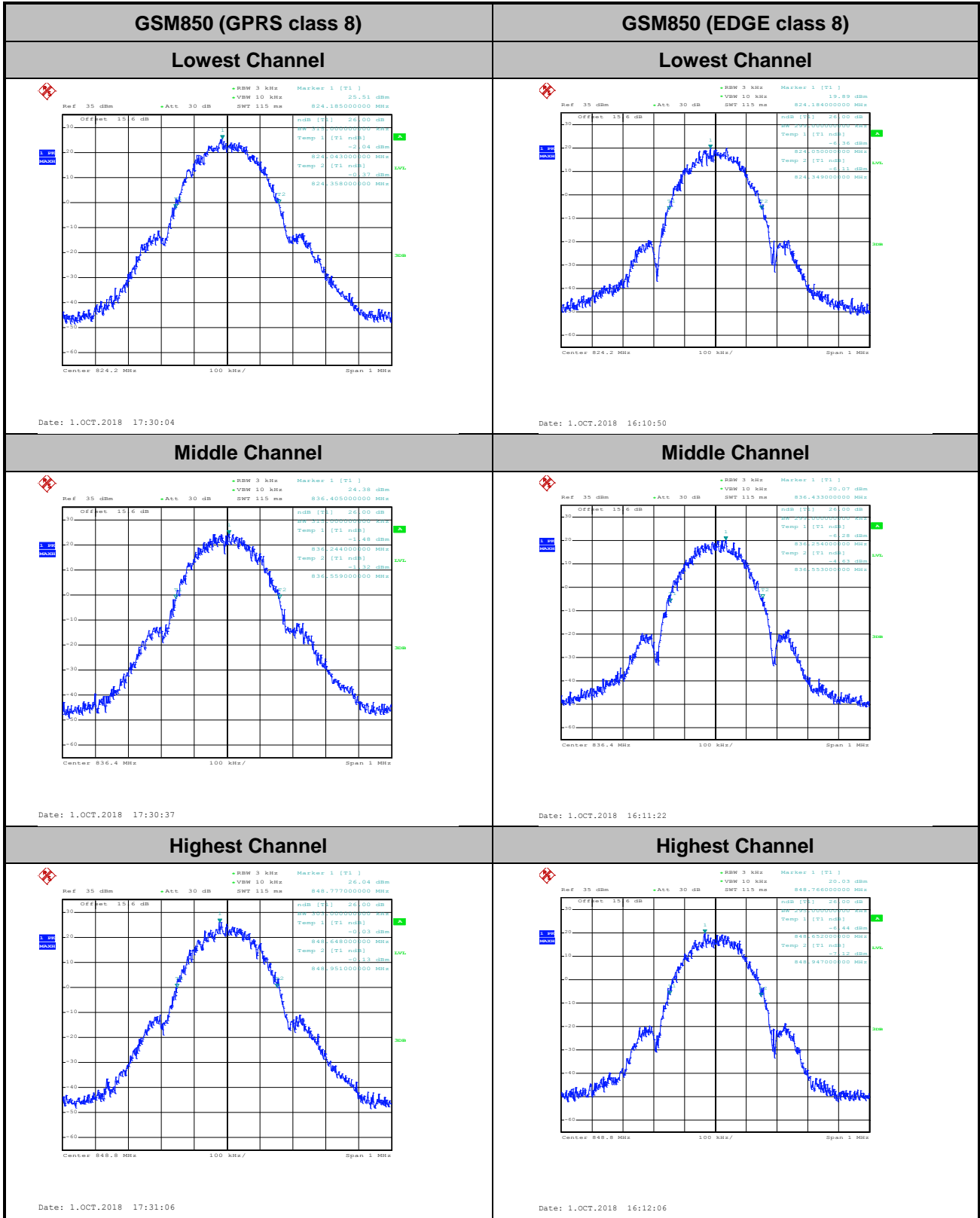

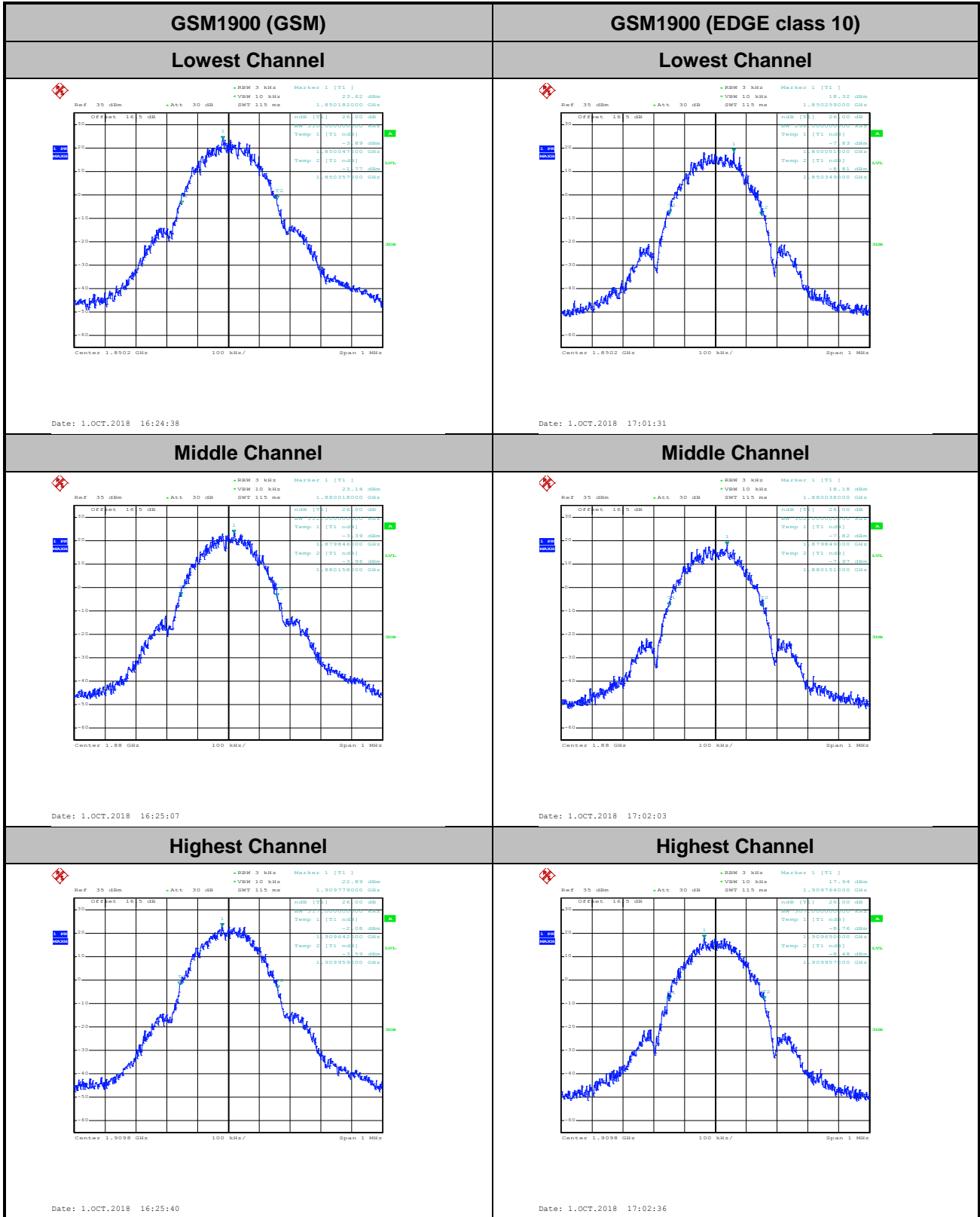



Occupied Bandwidth

Mode	GSM850 : 99% OBW(MHz)	
Mod.	GPRS class 8	EDGE class 8
Lowest CH	0.245	0.248
Middle CH	0.244	0.245
Highest CH	0.244	0.245

Mode	GSM1900 : 99% OBW(MHz)	
Mod.	GSM	EDGE class 10
Lowest CH	0.247	0.248
Middle CH	0.246	0.249
Highest CH	0.243	0.244

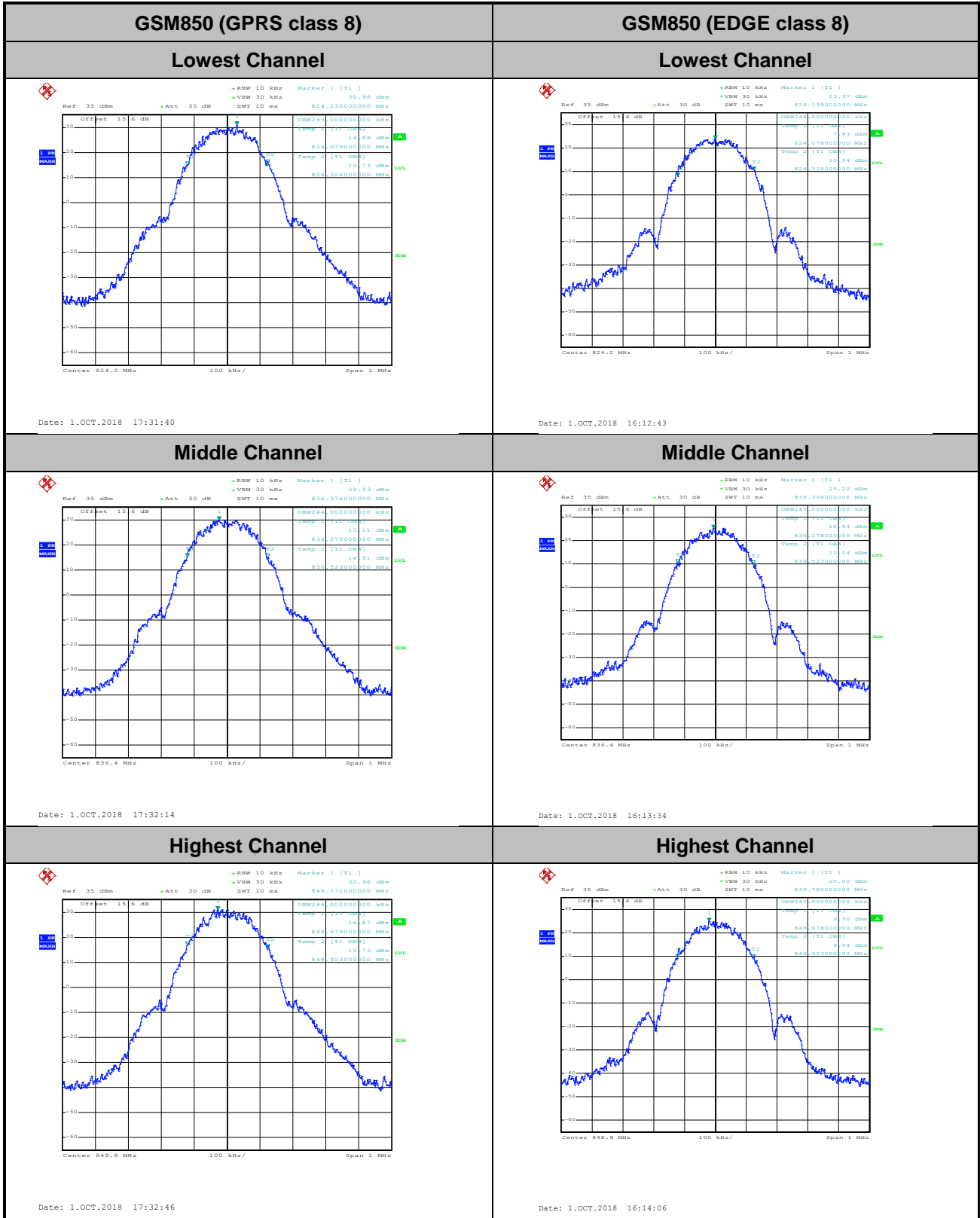

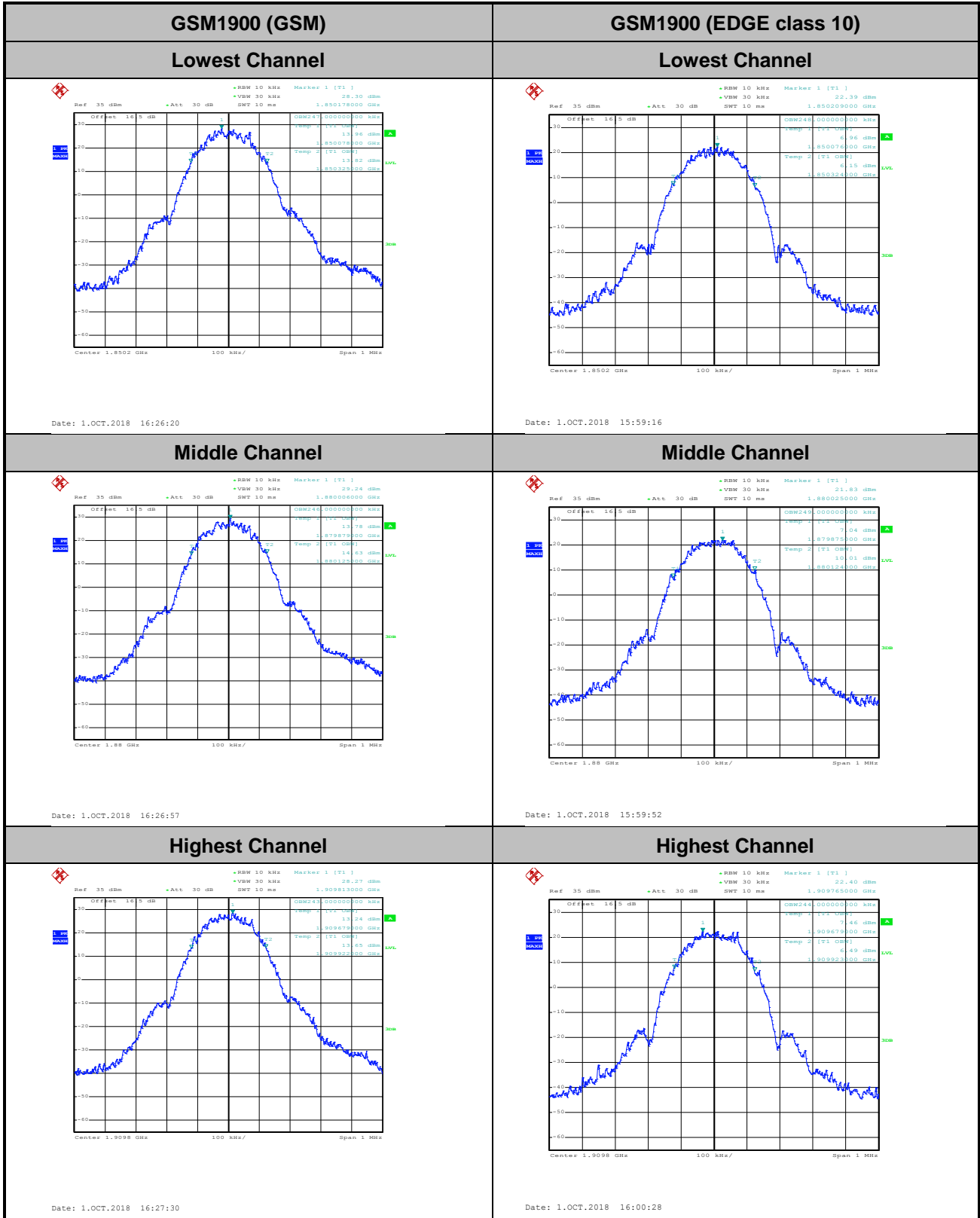



Conducted Band Edge

GSM850 (GPRS class 8)

Lowest Band Edge

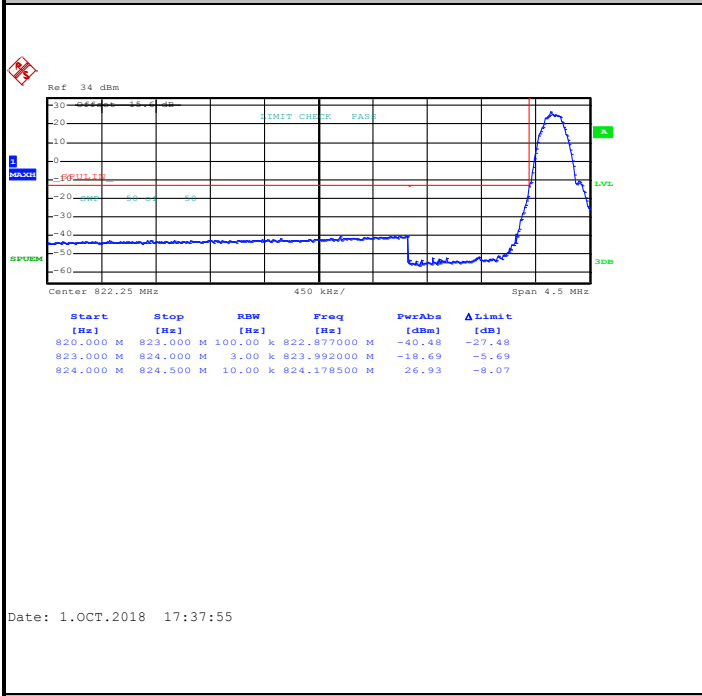

Highest Band Edge

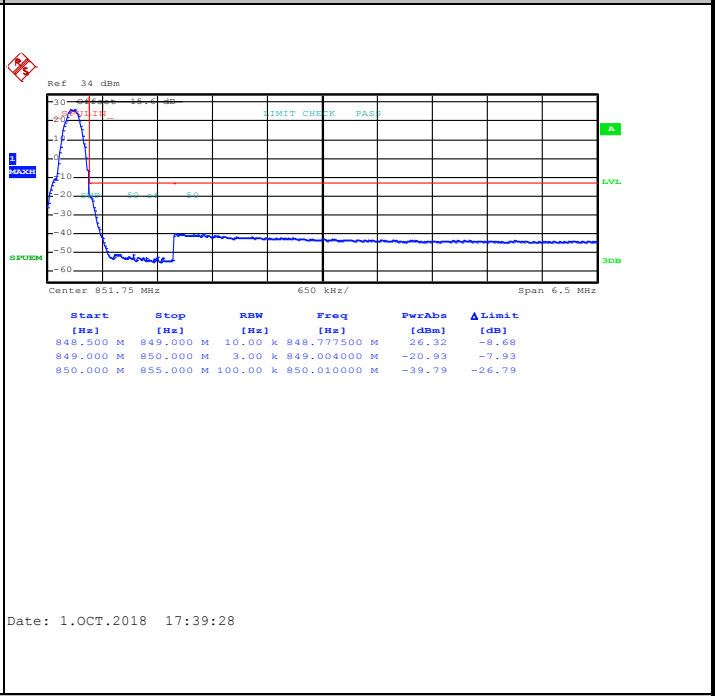

GSM850 (EDGE class 8)

Lowest Band Edge

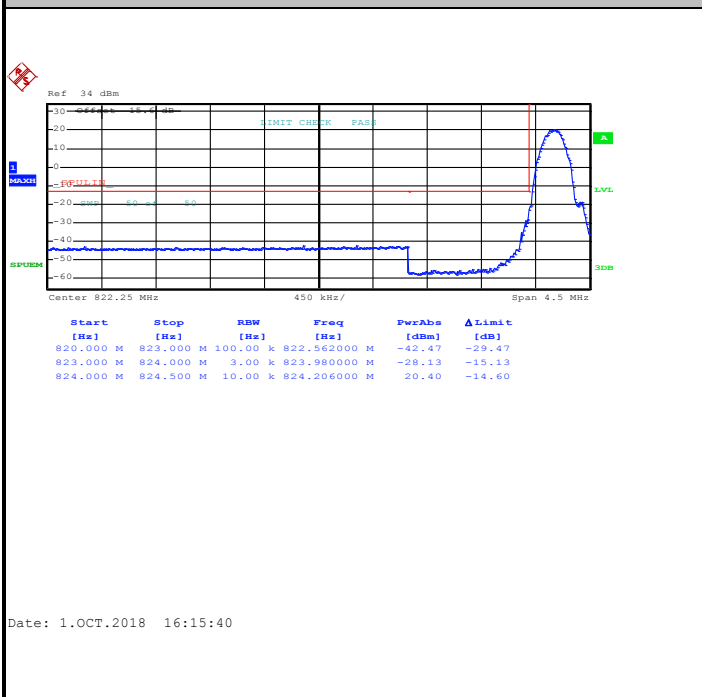

Highest Band Edge

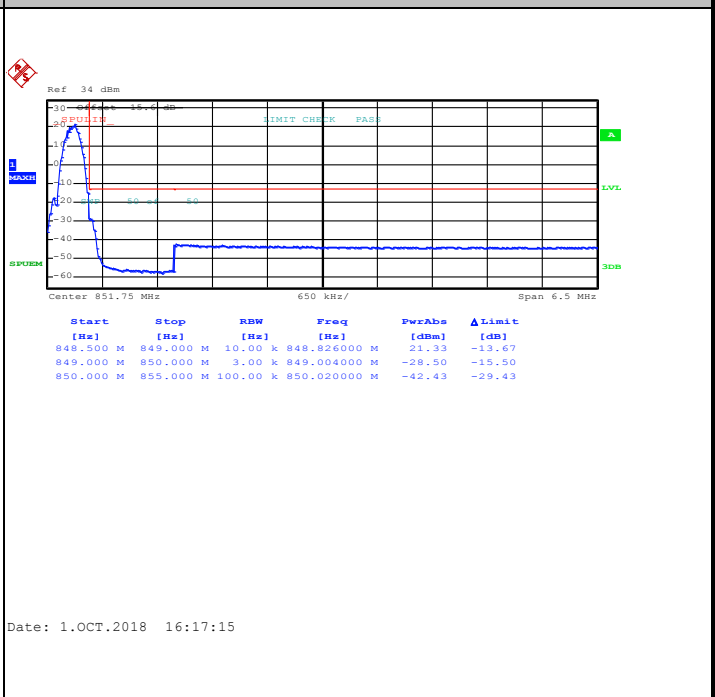



GSM1900 (GSM)

Lowest Band Edge

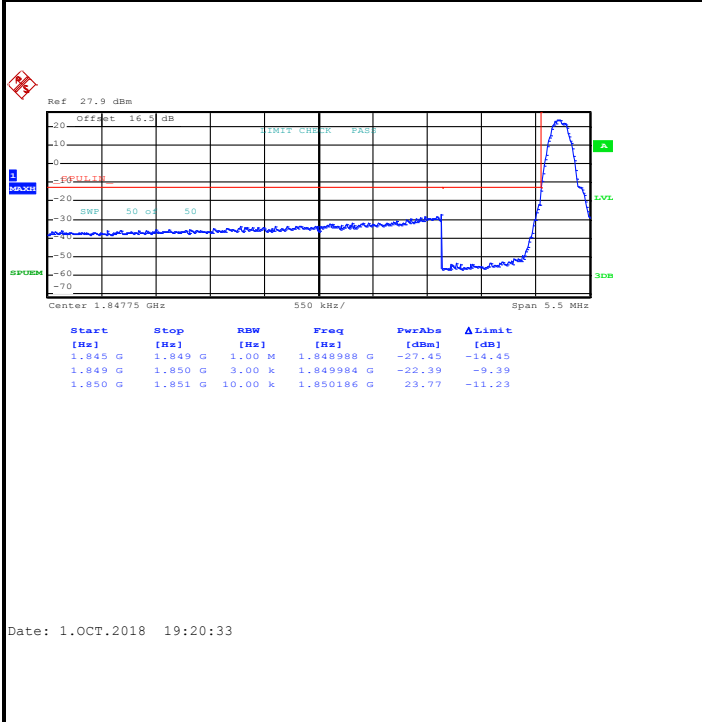

Highest Band Edge

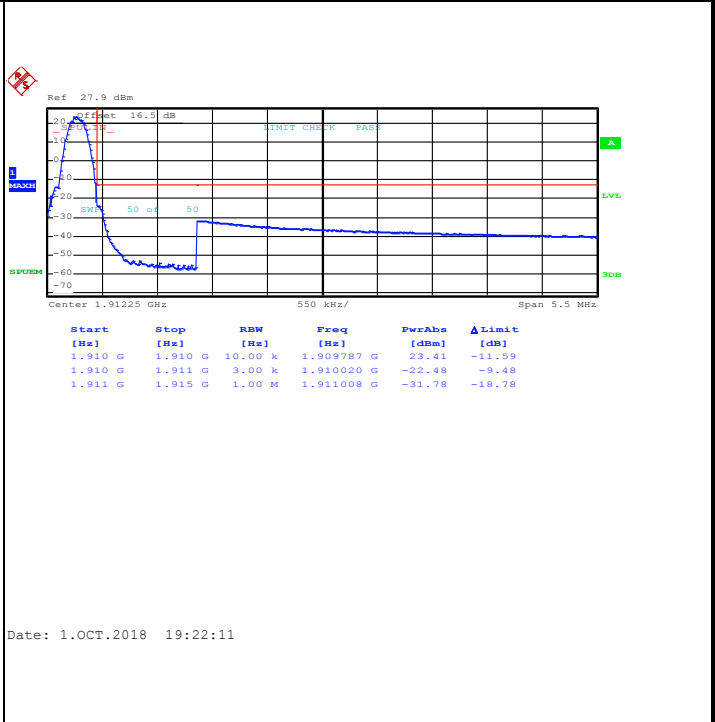

GSM1900 (EDGE class 10)

Lowest Band Edge

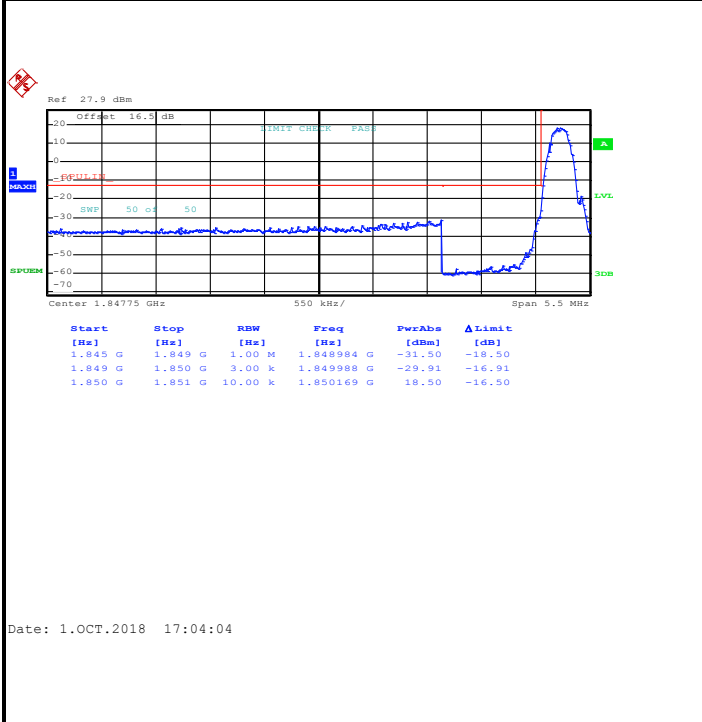

Highest Band Edge

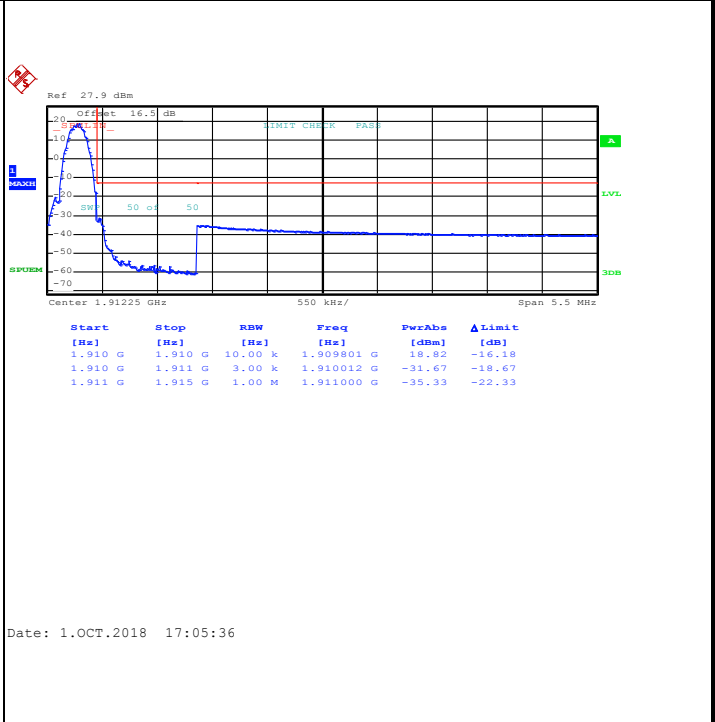



Conducted Spurious Emission

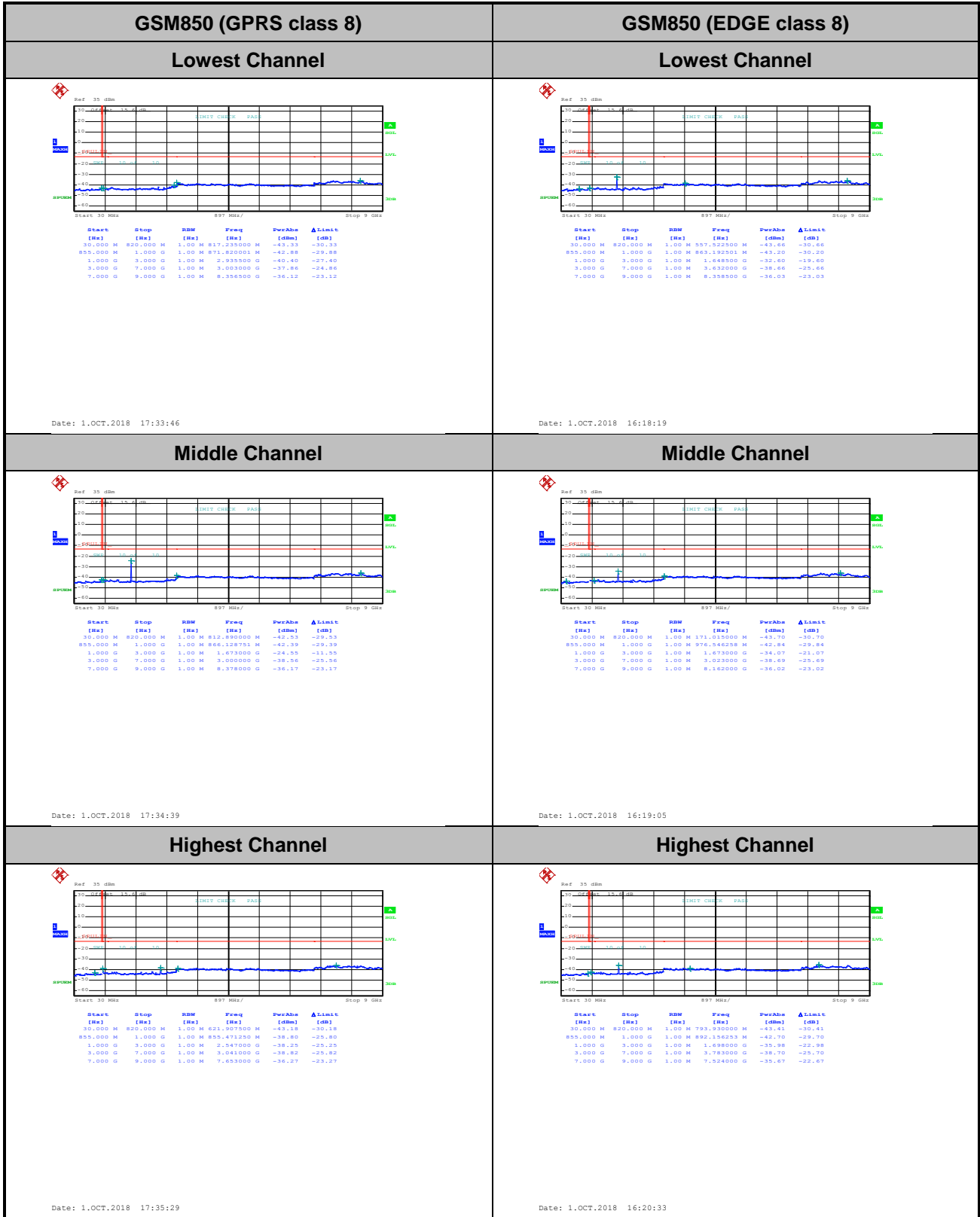

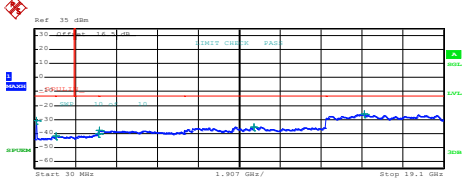
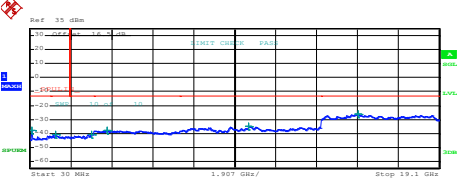
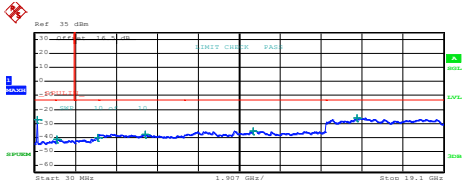
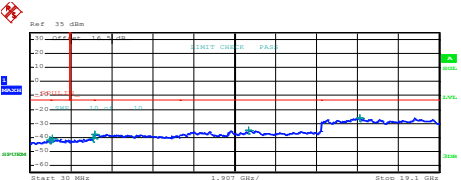
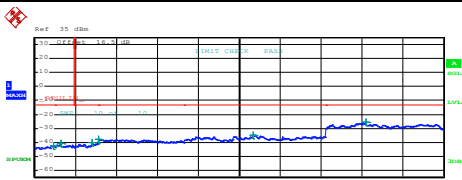
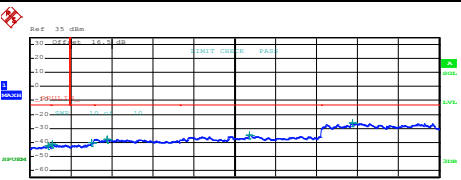

GSM1900 (GSM)	GSM1900 (EDGE class 10)																																																																																				
Lowest Channel	Lowest Channel																																																																																				
 <table border="1" data-bbox="239 577 638 672"> <thead> <tr> <th>Start [Hz]</th> <th>Stop [Hz]</th> <th>RBW [Hz]</th> <th>Freq [Hz]</th> <th>PwrAbs [dBm]</th> <th>ΔLimit [dB]</th> </tr> </thead> <tbody> <tr><td>30,000 M</td><td>1,000 G</td><td>1,000 M</td><td>111,960000 M</td><td>-30.76</td><td>-27.73</td></tr> <tr><td>1,000 G</td><td>1,845 G</td><td>1,000 M</td><td>1,034850 G</td><td>-41.78</td><td>-28.78</td></tr> <tr><td>1,845 G</td><td>3,000 G</td><td>1,000 M</td><td>2,989850 G</td><td>-40.40</td><td>-27.40</td></tr> <tr><td>3,000 G</td><td>7,000 G</td><td>1,000 M</td><td>3,040000 G</td><td>-37.65</td><td>-24.65</td></tr> <tr><td>7,000 G</td><td>13,600 G</td><td>1,000 M</td><td>10,238950 G</td><td>-35.30</td><td>-22.30</td></tr> <tr><td>13,600 G</td><td>19,100 G</td><td>1,000 M</td><td>15,406000 G</td><td>-26.20</td><td>-13.20</td></tr> </tbody> </table> <p>Date: 1.OCT.2018 17:24:45</p>	Start [Hz]	Stop [Hz]	RBW [Hz]	Freq [Hz]	PwrAbs [dBm]	ΔLimit [dB]	30,000 M	1,000 G	1,000 M	111,960000 M	-30.76	-27.73	1,000 G	1,845 G	1,000 M	1,034850 G	-41.78	-28.78	1,845 G	3,000 G	1,000 M	2,989850 G	-40.40	-27.40	3,000 G	7,000 G	1,000 M	3,040000 G	-37.65	-24.65	7,000 G	13,600 G	1,000 M	10,238950 G	-35.30	-22.30	13,600 G	19,100 G	1,000 M	15,406000 G	-26.20	-13.20	 <table border="1" data-bbox="893 577 1292 672"> <thead> <tr> <th>Start [Hz]</th> <th>Stop [Hz]</th> <th>RBW [Hz]</th> <th>Freq [Hz]</th> <th>PwrAbs [dBm]</th> <th>ΔLimit [dB]</th> </tr> </thead> <tbody> <tr><td>30,000 M</td><td>1,000 G</td><td>1,000 M</td><td>111,720000 M</td><td>-37.90</td><td>-24.96</td></tr> <tr><td>1,000 G</td><td>1,845 G</td><td>1,000 M</td><td>1,212517 G</td><td>-40.76</td><td>-27.76</td></tr> <tr><td>1,845 G</td><td>3,000 G</td><td>1,000 M</td><td>2,992265 G</td><td>-40.58</td><td>-27.58</td></tr> <tr><td>3,000 G</td><td>7,000 G</td><td>1,000 M</td><td>3,600000 G</td><td>-37.91</td><td>-24.91</td></tr> <tr><td>7,000 G</td><td>13,600 G</td><td>1,000 M</td><td>10,210075 G</td><td>-35.02</td><td>-22.02</td></tr> <tr><td>13,600 G</td><td>19,100 G</td><td>1,000 M</td><td>15,308438 G</td><td>-26.16</td><td>-13.16</td></tr> </tbody> </table> <p>Date: 1.OCT.2018 17:06:31</p>	Start [Hz]	Stop [Hz]	RBW [Hz]	Freq [Hz]	PwrAbs [dBm]	ΔLimit [dB]	30,000 M	1,000 G	1,000 M	111,720000 M	-37.90	-24.96	1,000 G	1,845 G	1,000 M	1,212517 G	-40.76	-27.76	1,845 G	3,000 G	1,000 M	2,992265 G	-40.58	-27.58	3,000 G	7,000 G	1,000 M	3,600000 G	-37.91	-24.91	7,000 G	13,600 G	1,000 M	10,210075 G	-35.02	-22.02	13,600 G	19,100 G	1,000 M	15,308438 G	-26.16	-13.16
Start [Hz]	Stop [Hz]	RBW [Hz]	Freq [Hz]	PwrAbs [dBm]	ΔLimit [dB]																																																																																
30,000 M	1,000 G	1,000 M	111,960000 M	-30.76	-27.73																																																																																
1,000 G	1,845 G	1,000 M	1,034850 G	-41.78	-28.78																																																																																
1,845 G	3,000 G	1,000 M	2,989850 G	-40.40	-27.40																																																																																
3,000 G	7,000 G	1,000 M	3,040000 G	-37.65	-24.65																																																																																
7,000 G	13,600 G	1,000 M	10,238950 G	-35.30	-22.30																																																																																
13,600 G	19,100 G	1,000 M	15,406000 G	-26.20	-13.20																																																																																
Start [Hz]	Stop [Hz]	RBW [Hz]	Freq [Hz]	PwrAbs [dBm]	ΔLimit [dB]																																																																																
30,000 M	1,000 G	1,000 M	111,720000 M	-37.90	-24.96																																																																																
1,000 G	1,845 G	1,000 M	1,212517 G	-40.76	-27.76																																																																																
1,845 G	3,000 G	1,000 M	2,992265 G	-40.58	-27.58																																																																																
3,000 G	7,000 G	1,000 M	3,600000 G	-37.91	-24.91																																																																																
7,000 G	13,600 G	1,000 M	10,210075 G	-35.02	-22.02																																																																																
13,600 G	19,100 G	1,000 M	15,308438 G	-26.16	-13.16																																																																																
Middle Channel	Middle Channel																																																																																				
 <table border="1" data-bbox="239 1093 638 1187"> <thead> <tr> <th>Start [Hz]</th> <th>Stop [Hz]</th> <th>RBW [Hz]</th> <th>Freq [Hz]</th> <th>PwrAbs [dBm]</th> <th>ΔLimit [dB]</th> </tr> </thead> <tbody> <tr><td>30,000 M</td><td>1,000 G</td><td>1,000 M</td><td>141,792500 M</td><td>-27.57</td><td>-24.57</td></tr> <tr><td>1,000 G</td><td>1,845 G</td><td>1,000 M</td><td>1,073304 G</td><td>-41.32</td><td>-28.32</td></tr> <tr><td>1,845 G</td><td>3,000 G</td><td>1,000 M</td><td>2,955786 G</td><td>-40.03</td><td>-27.03</td></tr> <tr><td>3,000 G</td><td>7,000 G</td><td>1,000 M</td><td>3,116800 G</td><td>-37.82</td><td>-24.82</td></tr> <tr><td>7,000 G</td><td>13,600 G</td><td>1,000 M</td><td>10,224925 G</td><td>-35.26</td><td>-22.26</td></tr> <tr><td>13,600 G</td><td>19,100 G</td><td>1,000 M</td><td>15,404313 G</td><td>-26.06</td><td>-13.06</td></tr> </tbody> </table> <p>Date: 1.OCT.2018 17:25:36</p>	Start [Hz]	Stop [Hz]	RBW [Hz]	Freq [Hz]	PwrAbs [dBm]	ΔLimit [dB]	30,000 M	1,000 G	1,000 M	141,792500 M	-27.57	-24.57	1,000 G	1,845 G	1,000 M	1,073304 G	-41.32	-28.32	1,845 G	3,000 G	1,000 M	2,955786 G	-40.03	-27.03	3,000 G	7,000 G	1,000 M	3,116800 G	-37.82	-24.82	7,000 G	13,600 G	1,000 M	10,224925 G	-35.26	-22.26	13,600 G	19,100 G	1,000 M	15,404313 G	-26.06	-13.06	 <table border="1" data-bbox="893 1093 1292 1187"> <thead> <tr> <th>Start [Hz]</th> <th>Stop [Hz]</th> <th>RBW [Hz]</th> <th>Freq [Hz]</th> <th>PwrAbs [dBm]</th> <th>ΔLimit [dB]</th> </tr> </thead> <tbody> <tr><td>30,000 M</td><td>1,000 G</td><td>1,000 M</td><td>948,832500 M</td><td>-42.02</td><td>-29.02</td></tr> <tr><td>1,000 G</td><td>1,845 G</td><td>1,000 M</td><td>1,0302601 G</td><td>-40.79</td><td>-27.79</td></tr> <tr><td>1,845 G</td><td>3,000 G</td><td>1,000 M</td><td>2,971519 G</td><td>-40.67</td><td>-27.67</td></tr> <tr><td>3,000 G</td><td>7,000 G</td><td>1,000 M</td><td>3,032000 G</td><td>-37.94</td><td>-24.94</td></tr> <tr><td>7,000 G</td><td>13,600 G</td><td>1,000 M</td><td>10,222450 G</td><td>-34.86</td><td>-21.86</td></tr> <tr><td>13,600 G</td><td>19,100 G</td><td>1,000 M</td><td>15,384083 G</td><td>-26.23</td><td>-13.23</td></tr> </tbody> </table> <p>Date: 1.OCT.2018 17:07:23</p>	Start [Hz]	Stop [Hz]	RBW [Hz]	Freq [Hz]	PwrAbs [dBm]	ΔLimit [dB]	30,000 M	1,000 G	1,000 M	948,832500 M	-42.02	-29.02	1,000 G	1,845 G	1,000 M	1,0302601 G	-40.79	-27.79	1,845 G	3,000 G	1,000 M	2,971519 G	-40.67	-27.67	3,000 G	7,000 G	1,000 M	3,032000 G	-37.94	-24.94	7,000 G	13,600 G	1,000 M	10,222450 G	-34.86	-21.86	13,600 G	19,100 G	1,000 M	15,384083 G	-26.23	-13.23
Start [Hz]	Stop [Hz]	RBW [Hz]	Freq [Hz]	PwrAbs [dBm]	ΔLimit [dB]																																																																																
30,000 M	1,000 G	1,000 M	141,792500 M	-27.57	-24.57																																																																																
1,000 G	1,845 G	1,000 M	1,073304 G	-41.32	-28.32																																																																																
1,845 G	3,000 G	1,000 M	2,955786 G	-40.03	-27.03																																																																																
3,000 G	7,000 G	1,000 M	3,116800 G	-37.82	-24.82																																																																																
7,000 G	13,600 G	1,000 M	10,224925 G	-35.26	-22.26																																																																																
13,600 G	19,100 G	1,000 M	15,404313 G	-26.06	-13.06																																																																																
Start [Hz]	Stop [Hz]	RBW [Hz]	Freq [Hz]	PwrAbs [dBm]	ΔLimit [dB]																																																																																
30,000 M	1,000 G	1,000 M	948,832500 M	-42.02	-29.02																																																																																
1,000 G	1,845 G	1,000 M	1,0302601 G	-40.79	-27.79																																																																																
1,845 G	3,000 G	1,000 M	2,971519 G	-40.67	-27.67																																																																																
3,000 G	7,000 G	1,000 M	3,032000 G	-37.94	-24.94																																																																																
7,000 G	13,600 G	1,000 M	10,222450 G	-34.86	-21.86																																																																																
13,600 G	19,100 G	1,000 M	15,384083 G	-26.23	-13.23																																																																																
Highest Channel	Highest Channel																																																																																				
 <table border="1" data-bbox="239 1608 638 1702"> <thead> <tr> <th>Start [Hz]</th> <th>Stop [Hz]</th> <th>RBW [Hz]</th> <th>Freq [Hz]</th> <th>PwrAbs [dBm]</th> <th>ΔLimit [dB]</th> </tr> </thead> <tbody> <tr><td>30,000 M</td><td>1,000 G</td><td>1,000 M</td><td>922,420000 M</td><td>-40.20</td><td>-27.20</td></tr> <tr><td>1,000 G</td><td>1,845 G</td><td>1,000 M</td><td>1,233431 G</td><td>-40.73</td><td>-27.73</td></tr> <tr><td>1,845 G</td><td>3,000 G</td><td>1,000 M</td><td>2,733587 G</td><td>-40.36</td><td>-27.36</td></tr> <tr><td>3,000 G</td><td>7,000 G</td><td>1,000 M</td><td>3,003000 G</td><td>-37.87</td><td>-24.87</td></tr> <tr><td>7,000 G</td><td>13,600 G</td><td>1,000 M</td><td>10,209250 G</td><td>-34.99</td><td>-21.99</td></tr> <tr><td>13,600 G</td><td>19,100 G</td><td>1,000 M</td><td>15,470688 G</td><td>-25.80</td><td>-12.80</td></tr> </tbody> </table> <p>Date: 1.OCT.2018 17:26:23</p>	Start [Hz]	Stop [Hz]	RBW [Hz]	Freq [Hz]	PwrAbs [dBm]	ΔLimit [dB]	30,000 M	1,000 G	1,000 M	922,420000 M	-40.20	-27.20	1,000 G	1,845 G	1,000 M	1,233431 G	-40.73	-27.73	1,845 G	3,000 G	1,000 M	2,733587 G	-40.36	-27.36	3,000 G	7,000 G	1,000 M	3,003000 G	-37.87	-24.87	7,000 G	13,600 G	1,000 M	10,209250 G	-34.99	-21.99	13,600 G	19,100 G	1,000 M	15,470688 G	-25.80	-12.80	 <table border="1" data-bbox="893 1608 1292 1702"> <thead> <tr> <th>Start [Hz]</th> <th>Stop [Hz]</th> <th>RBW [Hz]</th> <th>Freq [Hz]</th> <th>PwrAbs [dBm]</th> <th>ΔLimit [dB]</th> </tr> </thead> <tbody> <tr><td>30,000 M</td><td>1,000 G</td><td>1,000 M</td><td>854,050000 M</td><td>-42.40</td><td>-29.40</td></tr> <tr><td>1,000 G</td><td>1,845 G</td><td>1,000 M</td><td>1,046053 G</td><td>-41.48</td><td>-28.48</td></tr> <tr><td>1,845 G</td><td>3,000 G</td><td>1,000 M</td><td>2,893670 G</td><td>-40.06</td><td>-27.06</td></tr> <tr><td>3,000 G</td><td>7,000 G</td><td>1,000 M</td><td>3,620000 G</td><td>-37.64</td><td>-24.64</td></tr> <tr><td>7,000 G</td><td>13,600 G</td><td>1,000 M</td><td>10,239775 G</td><td>-34.65</td><td>-21.65</td></tr> <tr><td>13,600 G</td><td>19,100 G</td><td>1,000 M</td><td>15,060938 G</td><td>-26.36</td><td>-13.36</td></tr> </tbody> </table> <p>Date: 1.OCT.2018 17:08:09</p>	Start [Hz]	Stop [Hz]	RBW [Hz]	Freq [Hz]	PwrAbs [dBm]	ΔLimit [dB]	30,000 M	1,000 G	1,000 M	854,050000 M	-42.40	-29.40	1,000 G	1,845 G	1,000 M	1,046053 G	-41.48	-28.48	1,845 G	3,000 G	1,000 M	2,893670 G	-40.06	-27.06	3,000 G	7,000 G	1,000 M	3,620000 G	-37.64	-24.64	7,000 G	13,600 G	1,000 M	10,239775 G	-34.65	-21.65	13,600 G	19,100 G	1,000 M	15,060938 G	-26.36	-13.36
Start [Hz]	Stop [Hz]	RBW [Hz]	Freq [Hz]	PwrAbs [dBm]	ΔLimit [dB]																																																																																
30,000 M	1,000 G	1,000 M	922,420000 M	-40.20	-27.20																																																																																
1,000 G	1,845 G	1,000 M	1,233431 G	-40.73	-27.73																																																																																
1,845 G	3,000 G	1,000 M	2,733587 G	-40.36	-27.36																																																																																
3,000 G	7,000 G	1,000 M	3,003000 G	-37.87	-24.87																																																																																
7,000 G	13,600 G	1,000 M	10,209250 G	-34.99	-21.99																																																																																
13,600 G	19,100 G	1,000 M	15,470688 G	-25.80	-12.80																																																																																
Start [Hz]	Stop [Hz]	RBW [Hz]	Freq [Hz]	PwrAbs [dBm]	ΔLimit [dB]																																																																																
30,000 M	1,000 G	1,000 M	854,050000 M	-42.40	-29.40																																																																																
1,000 G	1,845 G	1,000 M	1,046053 G	-41.48	-28.48																																																																																
1,845 G	3,000 G	1,000 M	2,893670 G	-40.06	-27.06																																																																																
3,000 G	7,000 G	1,000 M	3,620000 G	-37.64	-24.64																																																																																
7,000 G	13,600 G	1,000 M	10,239775 G	-34.65	-21.65																																																																																
13,600 G	19,100 G	1,000 M	15,060938 G	-26.36	-13.36																																																																																



Frequency Stability

Test Conditions Temperature (°C)	Middle Channel Voltage (Volt)	GSM850 (GPRS class 8)	GSM850 (EDGE class 8)	Limit 2.5ppm
		Deviation (ppm)		Result
50	Normal Voltage	0.0634	0.0072	PASS
40	Normal Voltage	0.0622	0.0048	
30	Normal Voltage	0.0048	0.0036	
20(Ref.)	Normal Voltage	0.0000	0.0000	
10	Normal Voltage	0.0072	0.0048	
0	Normal Voltage	0.0048	0.0036	
-10	Normal Voltage	0.0108	0.0012	
-20	Normal Voltage	0.0132	0.0036	
-30	Normal Voltage	0.0227	0.0012	
20	Maximum Voltage	0.0012	0.0000	
20	Normal Voltage	0.0000	0.0000	
20	Battery End Point	0.0000	0.0000	



Test Conditions	Middle Channel	GSM1900 (GSM)	GSM1900 (EDGE class 10)	Limit Note 2.
Temperature (°C)	Voltage (Volt)	Deviation (ppm)		Result
50	Normal Voltage	0.0394	0.0282	PASS
40	Normal Voltage	0.0335	0.0303	
30	Normal Voltage	0.0005	0.0335	
20(Ref.)	Normal Voltage	0.0000	0.0000	
10	Normal Voltage	0.0037	0.0016	
0	Normal Voltage	0.0048	0.0037	
-10	Normal Voltage	0.0043	0.0032	
-20	Normal Voltage	0.0053	0.0069	
-30	Normal Voltage	0.0074	0.0074	
20	Maximum Voltage	0.0005	0.0016	
20	Normal Voltage	0.0000	0.0000	
20	Battery End Point	0.0005	0.0011	

Note:

- 1. Normal Voltage = 3.85V. ; Battery End Point (BEP) = 3.4 V. ; Maximum Voltage =4.4 V
- 2. The frequency fundamental emissions stay within the authorized frequency block.



A3. WCDMA

Peak-to-Average Ratio

Mode	WCDMA Band V	WCDMA Band II	WCDMA Band IV	Limit: 13dB
Mod.	RMC 12.2Kbps	RMC 12.2Kbps	RMC 12.2Kbps	Result
Lowest CH	2.28	2.48	1.88	PASS
Middle CH	2.36	2.16	2.60	
Highest CH	1.96	2.08	2.20	

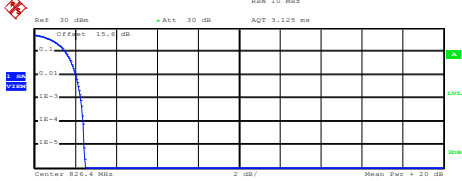
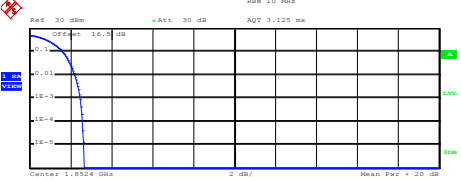
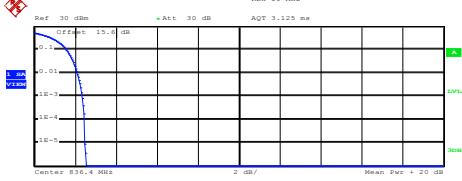
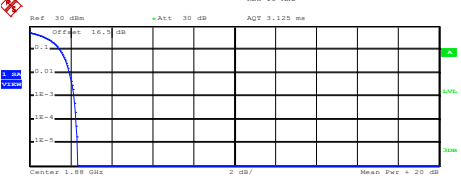
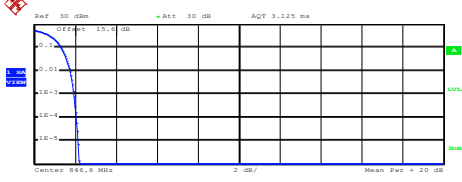
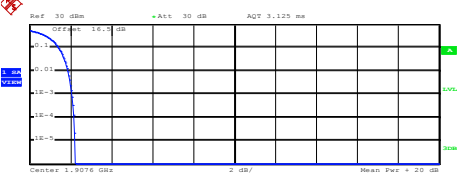

WCDMA Band V (RMC 12.2Kbps)	WCDMA Band II (RMC 12.2Kbps)																
<p style="text-align: center;">Lowest Channel</p>  <p>Center 826.4 MHz 2 dB/ Mean Per = 20 dB</p> <p>Complementary Cumulative Distribution Function (100000 samples)</p> <p>Trace 1</p> <p>Mean 24.94 dBm Peak 27.43 dBm Crest 2.49 dB</p> <table border="0"> <tr><td>10 %</td><td>1.52 dB</td></tr> <tr><td>1 %</td><td>2.04 dB</td></tr> <tr><td>.1 %</td><td>2.28 dB</td></tr> <tr><td>.01 %</td><td>2.40 dB</td></tr> </table> <p>Date: 1.OCT.2018 18:21:54</p>	10 %	1.52 dB	1 %	2.04 dB	.1 %	2.28 dB	.01 %	2.40 dB	<p style="text-align: center;">Lowest Channel</p>  <p>Center 1.8524 GHz 2 dB/ Mean Per = 20 dB</p> <p>Complementary Cumulative Distribution Function (100000 samples)</p> <p>Trace 1</p> <p>Mean 24.57 dBm Peak 27.22 dBm Crest 2.65 dB</p> <table border="0"> <tr><td>10 %</td><td>1.60 dB</td></tr> <tr><td>1 %</td><td>2.20 dB</td></tr> <tr><td>.1 %</td><td>2.48 dB</td></tr> <tr><td>.01 %</td><td>2.60 dB</td></tr> </table> <p>Date: 1.OCT.2018 17:49:26</p>	10 %	1.60 dB	1 %	2.20 dB	.1 %	2.48 dB	.01 %	2.60 dB
10 %	1.52 dB																
1 %	2.04 dB																
.1 %	2.28 dB																
.01 %	2.40 dB																
10 %	1.60 dB																
1 %	2.20 dB																
.1 %	2.48 dB																
.01 %	2.60 dB																
<p style="text-align: center;">Middle Channel</p>  <p>Center 836.4 MHz 2 dB/ Mean Per = 20 dB</p> <p>Complementary Cumulative Distribution Function (100000 samples)</p> <p>Trace 1</p> <p>Mean 24.89 dBm Peak 27.43 dBm Crest 2.54 dB</p> <table border="0"> <tr><td>10 %</td><td>1.56 dB</td></tr> <tr><td>1 %</td><td>2.12 dB</td></tr> <tr><td>.1 %</td><td>2.36 dB</td></tr> <tr><td>.01 %</td><td>2.44 dB</td></tr> </table> <p>Date: 1.OCT.2018 18:22:05</p>	10 %	1.56 dB	1 %	2.12 dB	.1 %	2.36 dB	.01 %	2.44 dB	<p style="text-align: center;">Middle Channel</p>  <p>Center 1.88 GHz 2 dB/ Mean Per = 20 dB</p> <p>Complementary Cumulative Distribution Function (100000 samples)</p> <p>Trace 1</p> <p>Mean 24.59 dBm Peak 26.94 dBm Crest 2.35 dB</p> <table border="0"> <tr><td>10 %</td><td>1.48 dB</td></tr> <tr><td>1 %</td><td>1.96 dB</td></tr> <tr><td>.1 %</td><td>2.16 dB</td></tr> <tr><td>.01 %</td><td>2.28 dB</td></tr> </table> <p>Date: 1.OCT.2018 17:49:35</p>	10 %	1.48 dB	1 %	1.96 dB	.1 %	2.16 dB	.01 %	2.28 dB
10 %	1.56 dB																
1 %	2.12 dB																
.1 %	2.36 dB																
.01 %	2.44 dB																
10 %	1.48 dB																
1 %	1.96 dB																
.1 %	2.16 dB																
.01 %	2.28 dB																
<p style="text-align: center;">Highest Channel</p>  <p>Center 846.6 MHz 2 dB/ Mean Per = 20 dB</p> <p>Complementary Cumulative Distribution Function (100000 samples)</p> <p>Trace 1</p> <p>Mean 24.80 dBm Peak 27.01 dBm Crest 2.21 dB</p> <table border="0"> <tr><td>10 %</td><td>1.32 dB</td></tr> <tr><td>1 %</td><td>1.76 dB</td></tr> <tr><td>.1 %</td><td>1.96 dB</td></tr> <tr><td>.01 %</td><td>2.08 dB</td></tr> </table> <p>Date: 1.OCT.2018 18:22:15</p>	10 %	1.32 dB	1 %	1.76 dB	.1 %	1.96 dB	.01 %	2.08 dB	<p style="text-align: center;">Highest Channel</p>  <p>Center 1.9076 GHz 2 dB/ Mean Per = 20 dB</p> <p>Complementary Cumulative Distribution Function (100000 samples)</p> <p>Trace 1</p> <p>Mean 24.59 dBm Peak 26.80 dBm Crest 2.20 dB</p> <table border="0"> <tr><td>10 %</td><td>1.40 dB</td></tr> <tr><td>1 %</td><td>1.88 dB</td></tr> <tr><td>.1 %</td><td>2.08 dB</td></tr> <tr><td>.01 %</td><td>2.16 dB</td></tr> </table> <p>Date: 1.OCT.2018 17:49:46</p>	10 %	1.40 dB	1 %	1.88 dB	.1 %	2.08 dB	.01 %	2.16 dB
10 %	1.32 dB																
1 %	1.76 dB																
.1 %	1.96 dB																
.01 %	2.08 dB																
10 %	1.40 dB																
1 %	1.88 dB																
.1 %	2.08 dB																
.01 %	2.16 dB																



WCDMA Band IV (RMC 12.2Kbps)

Lowest Channel

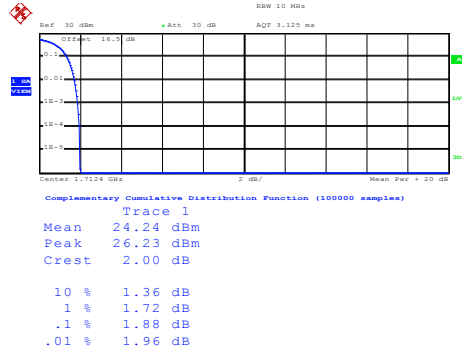

Date: 1.OCT.2018 18:04:19

Middle Channel

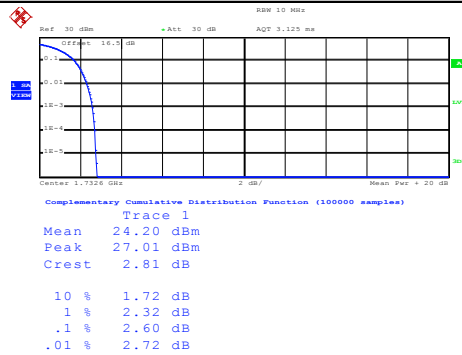

Date: 1.OCT.2018 18:04:31

Highest Channel

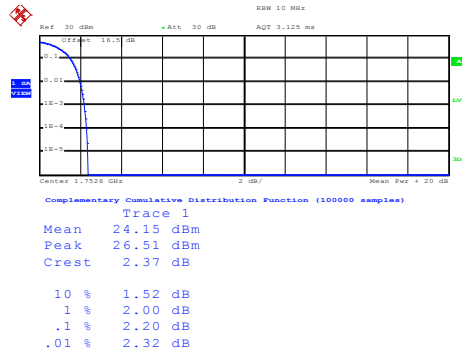

Date: 1.OCT.2018 18:04:42



26dB Bandwidth

Mode	WCDMA Band V 26dB BW(MHz)	WCDMA Band II 26dB BW(MHz)	WCDMA Band IV 26dB BW(MHz)
Mod.	RMC 12.2Kbps	RMC 12.2Kbps	RMC 12.2Kbps
Lowest CH	4.74	4.72	4.79
Middle CH	4.74	4.76	4.70
Highest CH	4.82	4.78	4.75



WCDMA Band V (RMC 12.2Kbps)

Lowest Channel

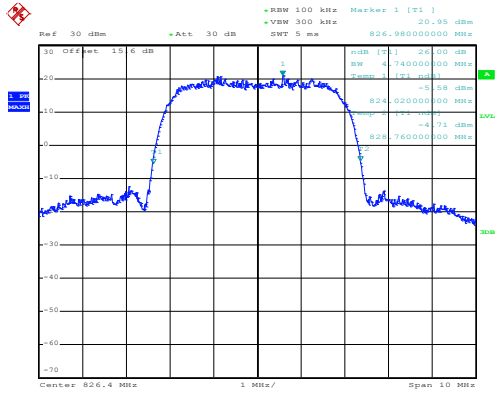

Date: 1.OCT.2018 18:14:19

WCDMA Band II (RMC 12.2Kbps)

Lowest Channel

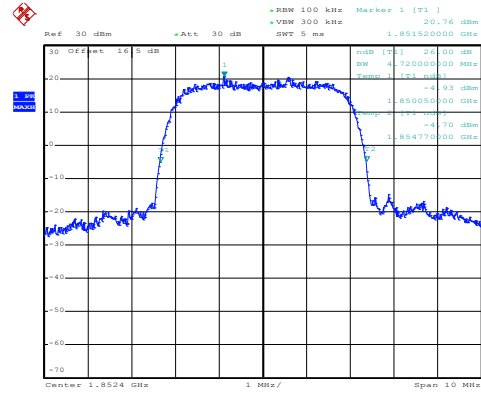

Date: 1.OCT.2018 17:42:22

Middle Channel

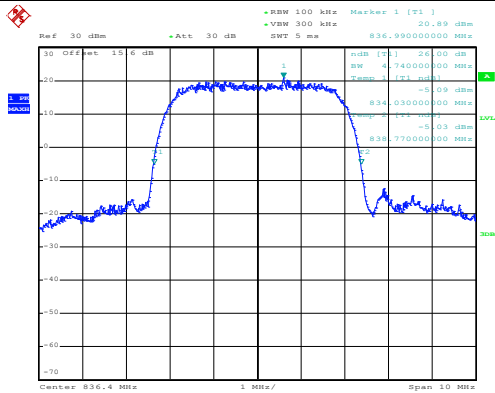

Date: 1.OCT.2018 18:14:53

Middle Channel

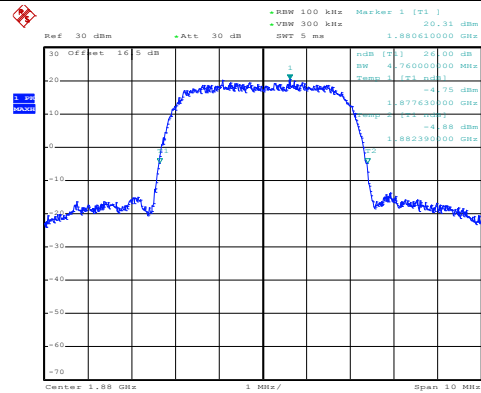

Date: 1.OCT.2018 17:42:57

Highest Channel

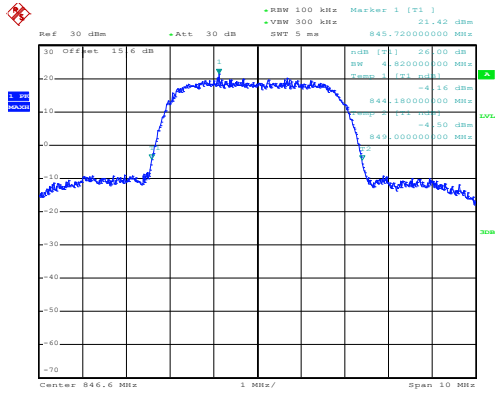

Date: 1.OCT.2018 18:15:26

Highest Channel

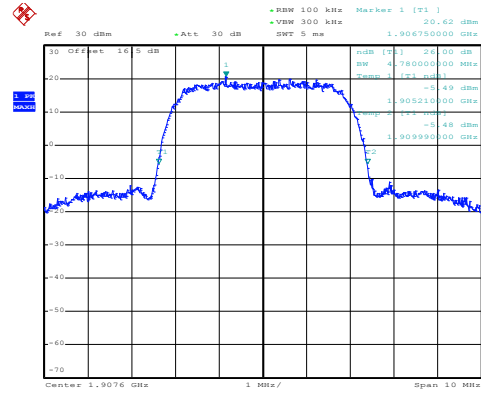

Date: 1.OCT.2018 17:43:32



WCDMA Band IV (RMC 12.2Kbps)

Lowest Channel

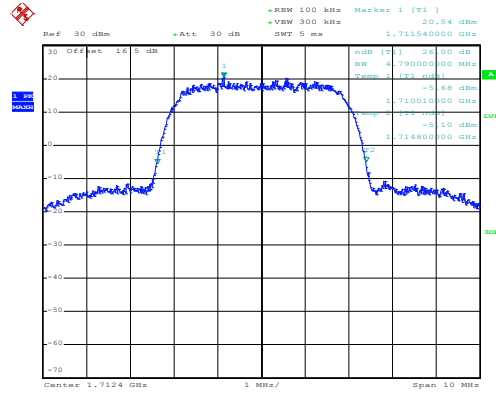

Date: 1.OCT.2018 17:58:37

Middle Channel

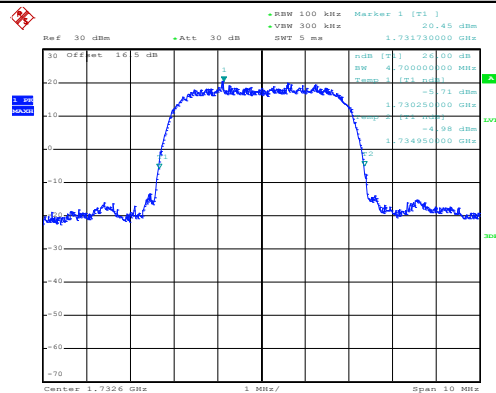

Date: 1.OCT.2018 17:59:07

Highest Channel

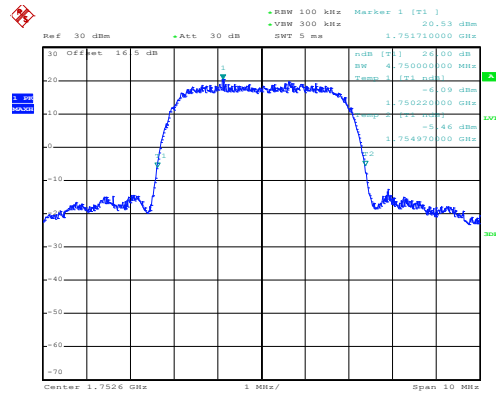

Date: 1.OCT.2018 17:59:45



Occupied Bandwidth

Mode	WCDMA Band V 99% OBW(MHz)	WCDMA Band II 99% OBW(MHz)	WCDMA Band IV 99% OBW(MHz)
Mod.	RMC 12.2Kbps	RMC 12.2Kbps	RMC 12.2Kbps
Lowest CH	4.16	4.14	4.18
Middle CH	4.15	4.15	4.15
Highest CH	4.20	4.16	4.15



WCDMA Band V (RMC 12.2Kbps)

Lowest Channel

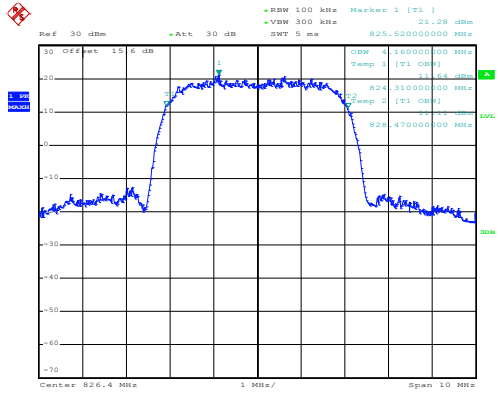

Date: 1.OCT.2018 18:18:06

WCDMA Band II (RMC 12.2Kbps)

Lowest Channel

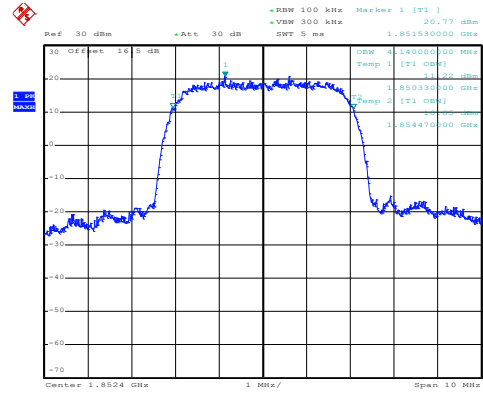

Date: 1.OCT.2018 17:44:11

Middle Channel

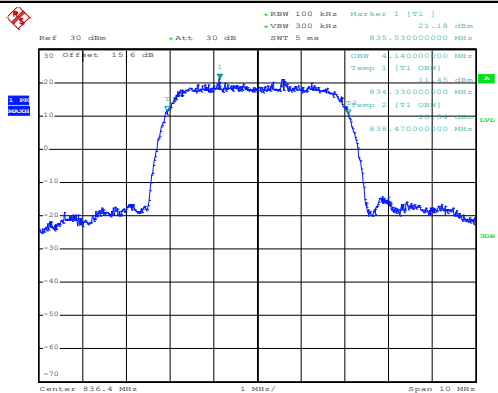

Date: 1.OCT.2018 18:18:37

Middle Channel

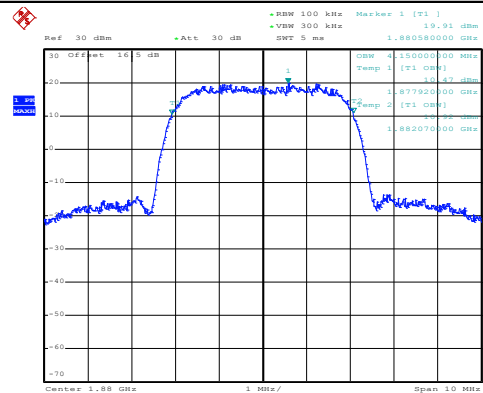

Date: 1.OCT.2018 17:44:43

Highest Channel

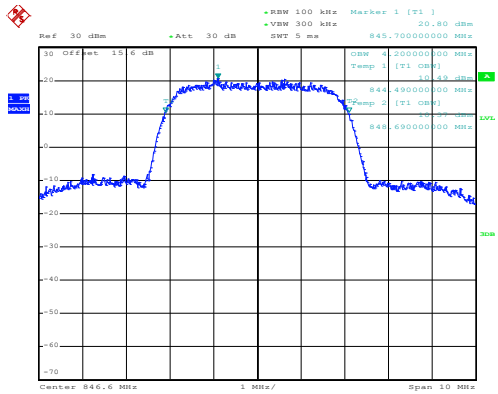

Date: 1.OCT.2018 18:19:09

Highest Channel

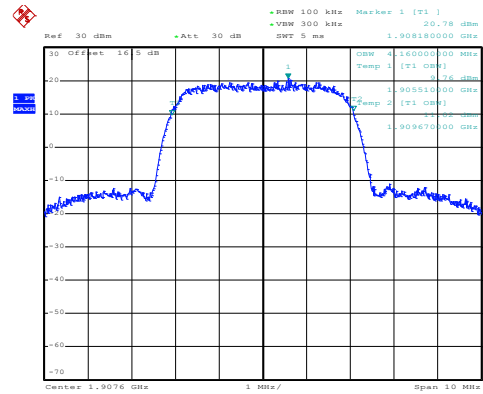

Date: 1.OCT.2018 17:45:17

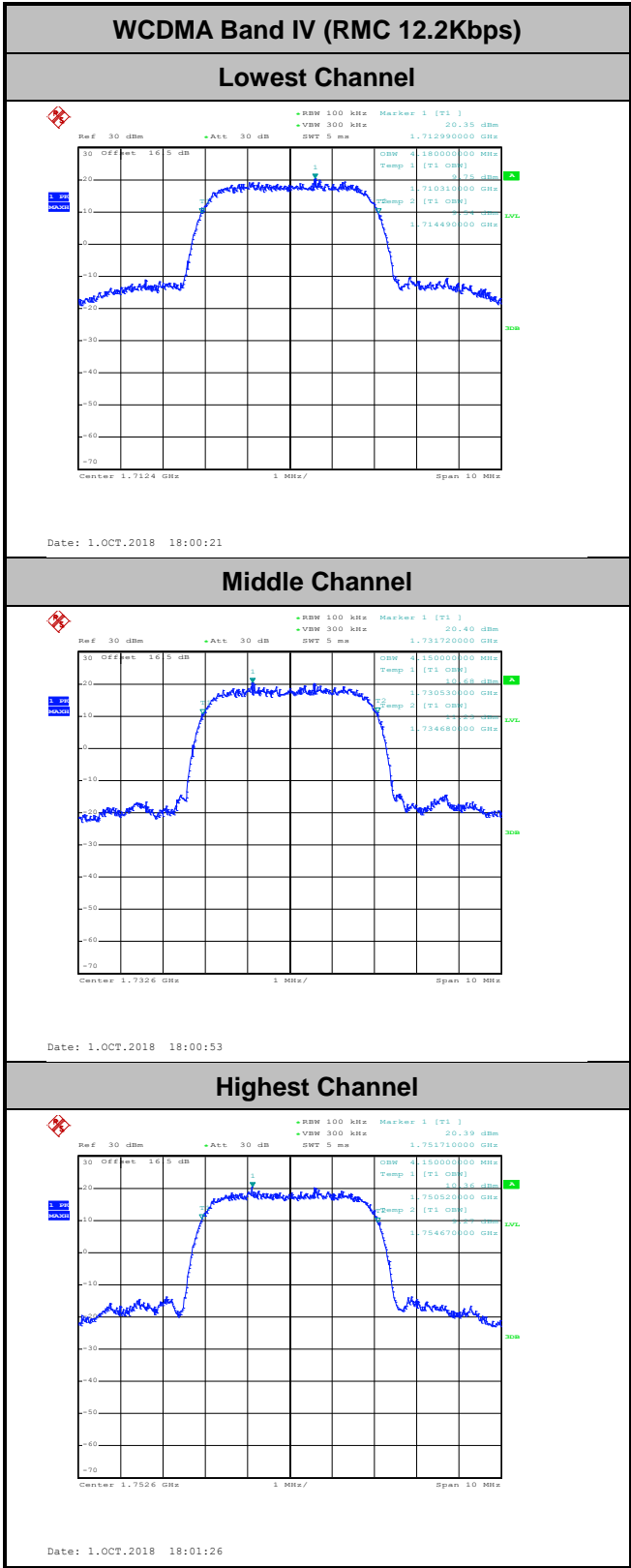



Conducted Band Edge

WCDMA Band V (RMC 12.2Kbps)

Lowest Band Edge

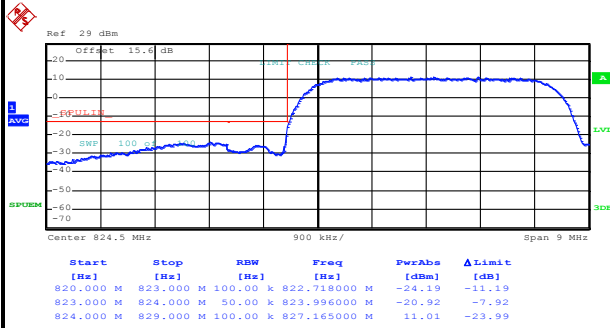

Date: 1.OCT.2018 18:25:01

Highest Band Edge

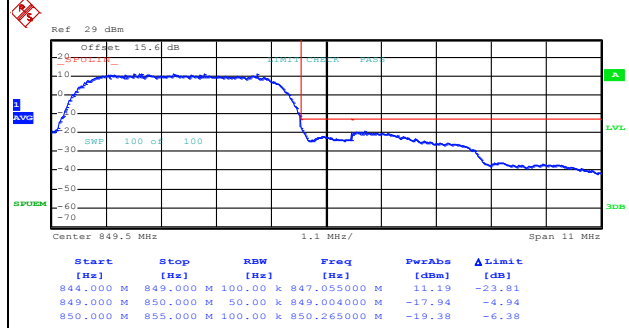

Date: 1.OCT.2018 18:27:45



WCDMA Band II (RMC 12.2Kbps)

Lowest Band Edge

Highest Band Edge

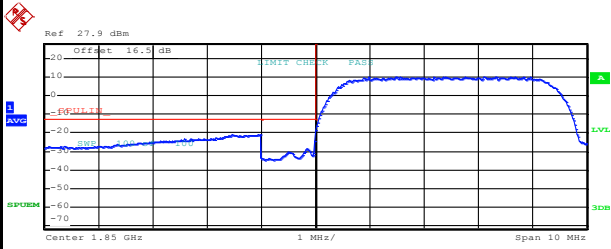

Start [Hz]	Stop [Hz]	RBW [Hz]	Freq [Hz]	PwrAbs [dBm]	ΔLimit [dB]
1.845 G	1.849 G	1.00 M	1.848976 G	-20.84	-7.84
1.849 G	1.850 G	50.00 k	1.849996 G	-25.19	-12.19
1.850 G	1.855 G	100.00 k	1.853105 G	10.27	-24.73

Date: 1.OCT.2018 19:13:22

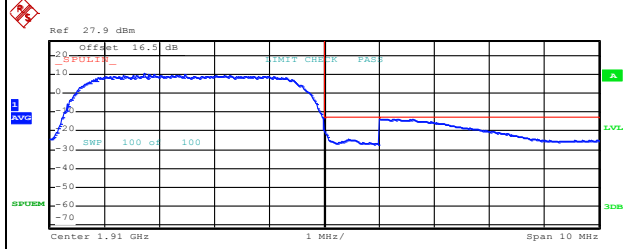

Start [Hz]	Stop [Hz]	RBW [Hz]	Freq [Hz]	PwrAbs [dBm]	ΔLimit [dB]
1.905 G	1.910 G	100.00 k	1.906710 G	10.43	-24.57
1.910 G	1.911 G	50.00 k	1.910012 G	-20.20	-7.20
1.911 G	1.915 G	1.00 M	1.911280 G	-13.72	-0.72

Date: 11.OCT.2018 16:52:10



WCDMA Band IV (RMC 12.2Kbps)

Lowest Band Edge

Highest Band Edge

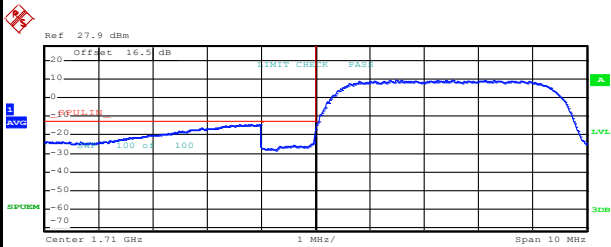

Start [Hz]	Stop [Hz]	RBW [Hz]	Freq [Hz]	PwrAbs [dBm]	ΔLimit [dB]
1.705 G	1.709 G	1.00 M	1.708792 G	-14.57	-1.57
1.709 G	1.710 G	50.00 k	1.709996 G	-21.36	-8.36
1.710 G	1.715 G	100.00 k	1.712245 G	9.71	-25.29

Date: 1.OCT.2018 19:08:43

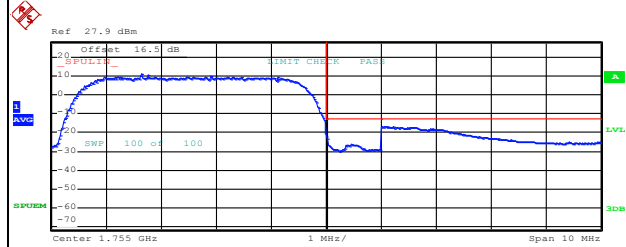

Start [Hz]	Stop [Hz]	RBW [Hz]	Freq [Hz]	PwrAbs [dBm]	ΔLimit [dB]
1.750 G	1.755 G	100.00 k	1.751630 G	11.12	-23.88
1.755 G	1.756 G	50.00 k	1.755004 G	-22.44	-9.44
1.756 G	1.760 G	1.00 M	1.756116 G	-17.04	-4.04

Date: 1.OCT.2018 18:10:22



Conducted Spurious Emission

WCDMA Band V (RMC 12.2Kbps)	WCDMA Band II (RMC 12.2Kbps)																																																																														
<p align="center">Lowest Channel</p> <table border="1"> <thead> <tr> <th>Start [MHz]</th> <th>Stop [MHz]</th> <th>RBW [Hz]</th> <th>Freq [Hz]</th> <th>PwrAbs [dBm]</th> <th>ΔLimit [dB]</th> </tr> </thead> <tbody> <tr><td>30.000 M</td><td>820.000 M</td><td>1.00 M</td><td>818.015000 M</td><td>-21.04</td><td>-8.04</td></tr> <tr><td>835.000 M</td><td>1.000 G</td><td>1.00 M</td><td>912.238754 M</td><td>-42.97</td><td>-29.97</td></tr> <tr><td>1.000 G</td><td>3.000 G</td><td>1.00 M</td><td>2.999000 G</td><td>-42.37</td><td>-29.37</td></tr> <tr><td>3.000 G</td><td>7.000 G</td><td>1.00 M</td><td>3.595000 G</td><td>-38.52</td><td>-25.52</td></tr> <tr><td>7.000 G</td><td>9.000 G</td><td>1.00 M</td><td>8.014500 G</td><td>-36.23</td><td>-23.23</td></tr> </tbody> </table> <p>Date: 1.OCT.2018 18:20:03</p>	Start [MHz]	Stop [MHz]	RBW [Hz]	Freq [Hz]	PwrAbs [dBm]	ΔLimit [dB]	30.000 M	820.000 M	1.00 M	818.015000 M	-21.04	-8.04	835.000 M	1.000 G	1.00 M	912.238754 M	-42.97	-29.97	1.000 G	3.000 G	1.00 M	2.999000 G	-42.37	-29.37	3.000 G	7.000 G	1.00 M	3.595000 G	-38.52	-25.52	7.000 G	9.000 G	1.00 M	8.014500 G	-36.23	-23.23	<p align="center">Lowest Channel</p> <table border="1"> <thead> <tr> <th>Start [MHz]</th> <th>Stop [MHz]</th> <th>RBW [Hz]</th> <th>Freq [Hz]</th> <th>PwrAbs [dBm]</th> <th>ΔLimit [dB]</th> </tr> </thead> <tbody> <tr><td>30.000 M</td><td>1.000 G</td><td>1.00 M</td><td>168.715000 M</td><td>-40.65</td><td>-27.65</td></tr> <tr><td>1.000 G</td><td>3.000 G</td><td>1.00 M</td><td>1.844789 G</td><td>-23.84</td><td>-10.84</td></tr> <tr><td>3.000 G</td><td>7.000 G</td><td>1.00 M</td><td>1.932071 G</td><td>-21.77</td><td>-8.77</td></tr> <tr><td>7.000 G</td><td>9.000 G</td><td>1.00 M</td><td>4.084000 G</td><td>-37.98</td><td>-24.98</td></tr> <tr><td>13.600 G</td><td>19.100 G</td><td>1.00 M</td><td>10.215025 G</td><td>-34.44</td><td>-21.44</td></tr> <tr><td>13.600 G</td><td>19.100 G</td><td>1.00 M</td><td>15.263750 G</td><td>-25.56</td><td>-12.56</td></tr> </tbody> </table> <p>Date: 1.OCT.2018 17:46:08</p>	Start [MHz]	Stop [MHz]	RBW [Hz]	Freq [Hz]	PwrAbs [dBm]	ΔLimit [dB]	30.000 M	1.000 G	1.00 M	168.715000 M	-40.65	-27.65	1.000 G	3.000 G	1.00 M	1.844789 G	-23.84	-10.84	3.000 G	7.000 G	1.00 M	1.932071 G	-21.77	-8.77	7.000 G	9.000 G	1.00 M	4.084000 G	-37.98	-24.98	13.600 G	19.100 G	1.00 M	10.215025 G	-34.44	-21.44	13.600 G	19.100 G	1.00 M	15.263750 G	-25.56	-12.56
Start [MHz]	Stop [MHz]	RBW [Hz]	Freq [Hz]	PwrAbs [dBm]	ΔLimit [dB]																																																																										
30.000 M	820.000 M	1.00 M	818.015000 M	-21.04	-8.04																																																																										
835.000 M	1.000 G	1.00 M	912.238754 M	-42.97	-29.97																																																																										
1.000 G	3.000 G	1.00 M	2.999000 G	-42.37	-29.37																																																																										
3.000 G	7.000 G	1.00 M	3.595000 G	-38.52	-25.52																																																																										
7.000 G	9.000 G	1.00 M	8.014500 G	-36.23	-23.23																																																																										
Start [MHz]	Stop [MHz]	RBW [Hz]	Freq [Hz]	PwrAbs [dBm]	ΔLimit [dB]																																																																										
30.000 M	1.000 G	1.00 M	168.715000 M	-40.65	-27.65																																																																										
1.000 G	3.000 G	1.00 M	1.844789 G	-23.84	-10.84																																																																										
3.000 G	7.000 G	1.00 M	1.932071 G	-21.77	-8.77																																																																										
7.000 G	9.000 G	1.00 M	4.084000 G	-37.98	-24.98																																																																										
13.600 G	19.100 G	1.00 M	10.215025 G	-34.44	-21.44																																																																										
13.600 G	19.100 G	1.00 M	15.263750 G	-25.56	-12.56																																																																										
<p align="center">Middle Channel</p> <table border="1"> <thead> <tr> <th>Start [MHz]</th> <th>Stop [MHz]</th> <th>RBW [Hz]</th> <th>Freq [Hz]</th> <th>PwrAbs [dBm]</th> <th>ΔLimit [dB]</th> </tr> </thead> <tbody> <tr><td>30.000 M</td><td>820.000 M</td><td>1.00 M</td><td>790.967500 M</td><td>-44.17</td><td>-31.17</td></tr> <tr><td>835.000 M</td><td>1.000 G</td><td>1.00 M</td><td>916.483754 M</td><td>-42.17</td><td>-29.17</td></tr> <tr><td>1.000 G</td><td>3.000 G</td><td>1.00 M</td><td>2.847500 G</td><td>-42.33</td><td>-29.33</td></tr> <tr><td>3.000 G</td><td>7.000 G</td><td>1.00 M</td><td>5.229000 G</td><td>-38.27</td><td>-25.27</td></tr> <tr><td>7.000 G</td><td>9.000 G</td><td>1.00 M</td><td>8.104500 G</td><td>-35.83</td><td>-22.83</td></tr> </tbody> </table> <p>Date: 1.OCT.2018 18:20:51</p>	Start [MHz]	Stop [MHz]	RBW [Hz]	Freq [Hz]	PwrAbs [dBm]	ΔLimit [dB]	30.000 M	820.000 M	1.00 M	790.967500 M	-44.17	-31.17	835.000 M	1.000 G	1.00 M	916.483754 M	-42.17	-29.17	1.000 G	3.000 G	1.00 M	2.847500 G	-42.33	-29.33	3.000 G	7.000 G	1.00 M	5.229000 G	-38.27	-25.27	7.000 G	9.000 G	1.00 M	8.104500 G	-35.83	-22.83	<p align="center">Middle Channel</p> <table border="1"> <thead> <tr> <th>Start [MHz]</th> <th>Stop [MHz]</th> <th>RBW [Hz]</th> <th>Freq [Hz]</th> <th>PwrAbs [dBm]</th> <th>ΔLimit [dB]</th> </tr> </thead> <tbody> <tr><td>30.000 M</td><td>1.000 G</td><td>1.00 M</td><td>142.277500 M</td><td>-40.58</td><td>-27.58</td></tr> <tr><td>1.000 G</td><td>3.000 G</td><td>1.00 M</td><td>3.039950 G</td><td>-42.28</td><td>-29.28</td></tr> <tr><td>3.000 G</td><td>7.000 G</td><td>1.00 M</td><td>2.972604 G</td><td>-40.89</td><td>-27.89</td></tr> <tr><td>7.000 G</td><td>9.000 G</td><td>1.00 M</td><td>3.104000 G</td><td>-37.96</td><td>-24.96</td></tr> <tr><td>13.600 G</td><td>19.100 G</td><td>1.00 M</td><td>10.215025 G</td><td>-34.50</td><td>-21.50</td></tr> <tr><td>13.600 G</td><td>19.100 G</td><td>1.00 M</td><td>15.051313 G</td><td>-26.46</td><td>-13.46</td></tr> </tbody> </table> <p>Date: 1.OCT.2018 17:48:19</p>	Start [MHz]	Stop [MHz]	RBW [Hz]	Freq [Hz]	PwrAbs [dBm]	ΔLimit [dB]	30.000 M	1.000 G	1.00 M	142.277500 M	-40.58	-27.58	1.000 G	3.000 G	1.00 M	3.039950 G	-42.28	-29.28	3.000 G	7.000 G	1.00 M	2.972604 G	-40.89	-27.89	7.000 G	9.000 G	1.00 M	3.104000 G	-37.96	-24.96	13.600 G	19.100 G	1.00 M	10.215025 G	-34.50	-21.50	13.600 G	19.100 G	1.00 M	15.051313 G	-26.46	-13.46
Start [MHz]	Stop [MHz]	RBW [Hz]	Freq [Hz]	PwrAbs [dBm]	ΔLimit [dB]																																																																										
30.000 M	820.000 M	1.00 M	790.967500 M	-44.17	-31.17																																																																										
835.000 M	1.000 G	1.00 M	916.483754 M	-42.17	-29.17																																																																										
1.000 G	3.000 G	1.00 M	2.847500 G	-42.33	-29.33																																																																										
3.000 G	7.000 G	1.00 M	5.229000 G	-38.27	-25.27																																																																										
7.000 G	9.000 G	1.00 M	8.104500 G	-35.83	-22.83																																																																										
Start [MHz]	Stop [MHz]	RBW [Hz]	Freq [Hz]	PwrAbs [dBm]	ΔLimit [dB]																																																																										
30.000 M	1.000 G	1.00 M	142.277500 M	-40.58	-27.58																																																																										
1.000 G	3.000 G	1.00 M	3.039950 G	-42.28	-29.28																																																																										
3.000 G	7.000 G	1.00 M	2.972604 G	-40.89	-27.89																																																																										
7.000 G	9.000 G	1.00 M	3.104000 G	-37.96	-24.96																																																																										
13.600 G	19.100 G	1.00 M	10.215025 G	-34.50	-21.50																																																																										
13.600 G	19.100 G	1.00 M	15.051313 G	-26.46	-13.46																																																																										
<p align="center">Highest Channel</p> <table border="1"> <thead> <tr> <th>Start [MHz]</th> <th>Stop [MHz]</th> <th>RBW [Hz]</th> <th>Freq [Hz]</th> <th>PwrAbs [dBm]</th> <th>ΔLimit [dB]</th> </tr> </thead> <tbody> <tr><td>30.000 M</td><td>820.000 M</td><td>1.00 M</td><td>639.287500 M</td><td>-44.07</td><td>-31.07</td></tr> <tr><td>835.000 M</td><td>1.000 G</td><td>1.00 M</td><td>855.108750 M</td><td>-28.84</td><td>-15.84</td></tr> <tr><td>1.000 G</td><td>3.000 G</td><td>1.00 M</td><td>2.990000 G</td><td>-42.89</td><td>-29.89</td></tr> <tr><td>3.000 G</td><td>7.000 G</td><td>1.00 M</td><td>5.148000 G</td><td>-38.72</td><td>-25.72</td></tr> <tr><td>7.000 G</td><td>9.000 G</td><td>1.00 M</td><td>8.034000 G</td><td>-36.01</td><td>-23.01</td></tr> </tbody> </table> <p>Date: 1.OCT.2018 18:21:38</p>	Start [MHz]	Stop [MHz]	RBW [Hz]	Freq [Hz]	PwrAbs [dBm]	ΔLimit [dB]	30.000 M	820.000 M	1.00 M	639.287500 M	-44.07	-31.07	835.000 M	1.000 G	1.00 M	855.108750 M	-28.84	-15.84	1.000 G	3.000 G	1.00 M	2.990000 G	-42.89	-29.89	3.000 G	7.000 G	1.00 M	5.148000 G	-38.72	-25.72	7.000 G	9.000 G	1.00 M	8.034000 G	-36.01	-23.01	<p align="center">Highest Channel</p> <table border="1"> <thead> <tr> <th>Start [MHz]</th> <th>Stop [MHz]</th> <th>RBW [Hz]</th> <th>Freq [Hz]</th> <th>PwrAbs [dBm]</th> <th>ΔLimit [dB]</th> </tr> </thead> <tbody> <tr><td>30.000 M</td><td>1.000 G</td><td>1.00 M</td><td>168.487500 M</td><td>-40.27</td><td>-27.27</td></tr> <tr><td>1.000 G</td><td>3.000 G</td><td>1.00 M</td><td>1.838663 G</td><td>-42.43</td><td>-29.43</td></tr> <tr><td>3.000 G</td><td>7.000 G</td><td>1.00 M</td><td>1.932071 G</td><td>-21.70</td><td>-8.70</td></tr> <tr><td>7.000 G</td><td>9.000 G</td><td>1.00 M</td><td>3.045000 G</td><td>-37.57</td><td>-24.57</td></tr> <tr><td>13.600 G</td><td>19.100 G</td><td>1.00 M</td><td>10.222450 G</td><td>-35.09</td><td>-22.09</td></tr> <tr><td>13.600 G</td><td>19.100 G</td><td>1.00 M</td><td>15.045325 G</td><td>-25.63</td><td>-12.63</td></tr> </tbody> </table> <p>Date: 1.OCT.2018 17:49:10</p>	Start [MHz]	Stop [MHz]	RBW [Hz]	Freq [Hz]	PwrAbs [dBm]	ΔLimit [dB]	30.000 M	1.000 G	1.00 M	168.487500 M	-40.27	-27.27	1.000 G	3.000 G	1.00 M	1.838663 G	-42.43	-29.43	3.000 G	7.000 G	1.00 M	1.932071 G	-21.70	-8.70	7.000 G	9.000 G	1.00 M	3.045000 G	-37.57	-24.57	13.600 G	19.100 G	1.00 M	10.222450 G	-35.09	-22.09	13.600 G	19.100 G	1.00 M	15.045325 G	-25.63	-12.63
Start [MHz]	Stop [MHz]	RBW [Hz]	Freq [Hz]	PwrAbs [dBm]	ΔLimit [dB]																																																																										
30.000 M	820.000 M	1.00 M	639.287500 M	-44.07	-31.07																																																																										
835.000 M	1.000 G	1.00 M	855.108750 M	-28.84	-15.84																																																																										
1.000 G	3.000 G	1.00 M	2.990000 G	-42.89	-29.89																																																																										
3.000 G	7.000 G	1.00 M	5.148000 G	-38.72	-25.72																																																																										
7.000 G	9.000 G	1.00 M	8.034000 G	-36.01	-23.01																																																																										
Start [MHz]	Stop [MHz]	RBW [Hz]	Freq [Hz]	PwrAbs [dBm]	ΔLimit [dB]																																																																										
30.000 M	1.000 G	1.00 M	168.487500 M	-40.27	-27.27																																																																										
1.000 G	3.000 G	1.00 M	1.838663 G	-42.43	-29.43																																																																										
3.000 G	7.000 G	1.00 M	1.932071 G	-21.70	-8.70																																																																										
7.000 G	9.000 G	1.00 M	3.045000 G	-37.57	-24.57																																																																										
13.600 G	19.100 G	1.00 M	10.222450 G	-35.09	-22.09																																																																										
13.600 G	19.100 G	1.00 M	15.045325 G	-25.63	-12.63																																																																										



WCDMA Band IV (RMC 12.2Kbps)

Lowest Channel

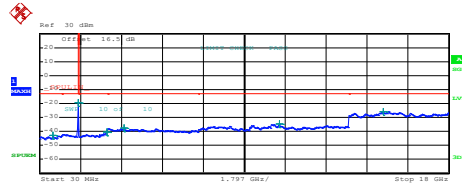

Start [Hz]	Stop [Hz]	RBW [Hz]	Freq [Hz]	PwrAbs [dBm]	ΔLimit [dB]
30.0000 M	1.0000 G	1.00 M	613.2121000 M	-42.74	-29.36
1.0000 G	1.7000 G	1.00 M	1.704471 G	-19.18	-6.18
1.7000 G	3.0000 G	1.00 M	2.995040 G	-40.61	-27.61
3.0000 G	7.0000 G	1.00 M	3.731000 G	-37.83	-24.83
7.0000 G	13.6000 G	1.00 M	10.559050 G	-34.76	-21.76
13.6000 G	18.0000 G	1.00 M	15.142200 G	-29.66	-12.66

Date: 1.OCT.2018 18:02:21

Middle Channel

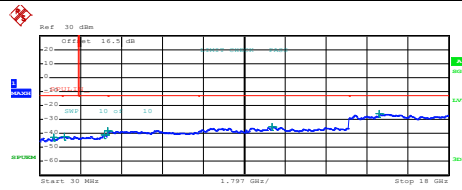

Start [Hz]	Stop [Hz]	RBW [Hz]	Freq [Hz]	PwrAbs [dBm]	ΔLimit [dB]
30.0000 M	1.0000 G	1.00 M	647.4050000 M	-42.77	-29.77
1.0000 G	1.7000 G	1.00 M	1.7090940 G	-42.09	-29.09
1.7000 G	3.0000 G	1.00 M	2.860190 G	-40.97	-27.97
3.0000 G	7.0000 G	1.00 M	3.021000 G	-37.99	-24.98
7.0000 G	13.6000 G	1.00 M	10.025150 G	-34.99	-21.98
13.6000 G	18.0000 G	1.00 M	14.952450 G	-26.02	-13.02

Date: 1.OCT.2018 18:03:12

Highest Channel

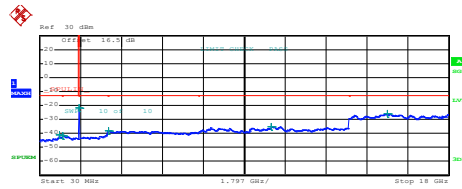

Start [Hz]	Stop [Hz]	RBW [Hz]	Freq [Hz]	PwrAbs [dBm]	ΔLimit [dB]
30.0000 M	1.0000 G	1.00 M	889.6825000 M	-41.37	-28.32
1.0000 G	1.7000 G	1.00 M	1.029257 G	-41.69	-28.69
1.7000 G	3.0000 G	1.00 M	1.760800 G	-21.67	-8.67
3.0000 G	7.0000 G	1.00 M	3.035000 G	-38.00	-25.00
7.0000 G	13.6000 G	1.00 M	10.213375 G	-35.01	-22.01
13.6000 G	18.0000 G	1.00 M	15.302250 G	-29.79	-12.79

Date: 1.OCT.2018 18:04:02



Frequency Stability

Test Conditions	Middle Channel	WCDMA Band V (RMC 12.2Kbps)	Limit
Temperature (°C)	Voltage (Volt)	Deviation (ppm)	2.5ppm Result
50	Normal Voltage	0.0012	PASS
40	Normal Voltage	0.0012	
30	Normal Voltage	0.0048	
20(Ref.)	Normal Voltage	0.0000	
10	Normal Voltage	0.0012	
0	Normal Voltage	0.0215	
-10	Normal Voltage	0.0012	
-20	Normal Voltage	0.0239	
-30	Normal Voltage	0.0227	
20	Maximum Voltage	0.0000	
20	Normal Voltage	0.0000	
20	Battery End Point	0.0000	

Note:

- 1. Normal Voltage = 3.85V. ; Battery End Point (BEP) = 3.4 V. ; Maximum Voltage =4.4 V
- 2. The frequency fundamental emissions stay within the authorized frequency block.



Test Conditions	Middle Channel	WCDMA Band II (RMC 12.2Kbps)	Limit Note 2.
Temperature (°C)	Voltage (Volt)	Deviation (ppm)	Result
50	Normal Voltage	0.0027	PASS
40	Normal Voltage	0.0027	
30	Normal Voltage	0.0005	
20(Ref.)	Normal Voltage	0.0000	
10	Normal Voltage	0.0032	
0	Normal Voltage	0.0032	
-10	Normal Voltage	0.0043	
-20	Normal Voltage	0.0043	
-30	Normal Voltage	0.0043	
20	Maximum Voltage	0.0005	
20	Normal Voltage	0.0000	
20	Battery End Point	0.0005	

Note:

- 1. Normal Voltage = 3.85V. ; Battery End Point (BEP) = 3.4 V. ; Maximum Voltage =4.4 V
- 2. The frequency fundamental emissions stay within the authorized frequency block.



Test Conditions	Middle Channel	WCDMA Band IV (RMC 12.2Kbps)	Limit Note 2.
Temperature (°C)	Voltage (Volt)	Deviation (ppm)	Result
50	Normal Voltage	0.0000	PASS
40	Normal Voltage	0.0006	
30	Normal Voltage	0.0006	
20(Ref.)	Normal Voltage	0.0000	
10	Normal Voltage	0.0000	
0	Normal Voltage	0.0006	
-10	Normal Voltage	0.0369	
-20	Normal Voltage	0.0358	
-30	Normal Voltage	0.0323	
20	Maximum Voltage	0.0006	
20	Normal Voltage	0.0000	
20	Battery End Point	0.0012	

Note:

1. Normal Voltage = 3.85V. ; Battery End Point (BEP) = 3.4 V. ; Maximum Voltage =4.4 V
2. The frequency fundamental emissions stay within the authorized frequency block.



Appendix B. Test Results of ERP/EIRP and Radiated Test

ERP/EIRP

Channel	Mode	Conducted		ERP	
		Power (dBm)	Power (Watts)	ERP(dBm)	ERP(W)
Lowest	GSM850 GPRS class 8 GT - LC = -3.85 dB	32.96	1.9770	26.96	0.4966
Middle		32.93	1.9634	26.93	0.4932
Highest		32.99	1.9907	26.99	0.5000
Lowest	GSM850 EDGE class 8 GT - LC = -3.85 dB	26.86	0.4853	20.86	0.1219
Middle		26.89	0.4887	20.89	0.1227
Highest		26.72	0.4699	20.72	0.1180
Lowest	WCDMA Band V RMC 12.2Kbps GT - LC = -3.85 dB	24.55	0.2851	18.55	0.0716
Middle		24.42	0.2767	18.42	0.0695
Highest		24.51	0.2825	18.51	0.0710
Limit	ERP < 7W	Result		PASS	

Channel	Mode	Conducted		EIRP	
		Power (dBm)	Power (Watts)	EIRP(dBm)	EIRP(W)
Lowest	GSM1900 GSM GT - LC = -2.05 dB	29.69	0.9311	27.64	0.5808
Middle		29.62	0.9162	27.57	0.5715
Highest		29.78	0.9506	27.73	0.5929
Lowest	GSM1900 EDGE class 10 GT - LC = -2.05 dB	25.67	0.3690	23.62	0.2301
Middle		25.81	0.3811	23.76	0.2377
Highest		25.96	0.3945	23.91	0.2460
Lowest	WCDMA Band II RMC 12.2Kbps GT - LC = -2.05 dB	24.43	0.2773	22.38	0.1730
Middle		24.37	0.2735	22.32	0.1706
Highest		24.47	0.2799	22.42	0.1746
Limit	EIRP < 2W	Result		PASS	

Channel	Mode	Conducted		EIRP	
		Power (dBm)	Power (Watts)	EIRP(dBm)	EIRP(W)
Lowest	WCDMA Band IV RMC 12.2Kbps GT - LC = -1.38 dB	24.36	0.2729	22.98	0.1986
Middle		24.43	0.2773	23.05	0.2018
Highest		24.36	0.2729	22.98	0.1986
Limit	EIRP < 1W	Result		PASS	



Radiated Spurious Emission

GPRS850

GPRS 850									
Channel	Frequency (MHz)	ERP (dBm)	Limit (dBm)	Over Limit (dB)	SPA Reading (dBm)	S.G. Power (dBm)	TX Cable loss (dB)	TX Antenna Gain (dBi)	Polarization (H/V)
Lowest	1648	-56.64	-13	-43.64	-66.55	-63.59	0.53	9.63	H
	2472	-46.40	-13	-33.40	-59.84	-54.38	0.65	10.78	H
	3296	-56.25	-13	-43.25	-72.39	-65.33	0.76	11.99	H
									H
									H
									H
									H
	1648	-55.85	-13	-42.85	-65.47	-62.8	0.53	9.63	V
	2472	-43.34	-13	-30.34	-56.27	-51.32	0.65	10.78	V
	3296	-57.02	-13	-44.02	-73.13	-66.1	0.76	11.99	V
									V
									V
									V
									V



Middle	1672	-51.24	-13	-38.24	-61.33	-58.24	0.53	9.68	H
	2512	-44.38	-13	-31.38	-57.8	-52.38	0.66	10.81	H
	3344	-57.57	-13	-44.57	-73.77	-66.79	0.76	12.13	H
									H
									H
									H
									H
	1672	-54.91	-13	-41.91	-64.6	-61.91	0.53	9.68	V
	2512	-46.46	-13	-33.46	-60.29	-54.46	0.66	10.81	V
	3344	-57.58	-13	-44.58	-73.59	-66.8	0.76	12.13	V
									V
									V
									V
									V
Highest	1696	-46.80	-13	-33.80	-57.18	-53.85	0.53	9.73	H
	2544	-42.56	-13	-29.56	-56.04	-50.57	0.67	10.83	H
	3392	-54.34	-13	-41.34	-70.65	-63.7	0.77	12.28	H
	4248	-56.77	-13	-43.77	-74.38	-66.08	0.84	12.30	H
									H
									H
									H
	1696	-55.20	-13	-42.20	-64.96	-62.25	0.53	9.73	V
	2544	-40.03	-13	-27.03	-53.88	-48.04	0.67	10.83	V
	3392	-52.96	-13	-39.96	-68.86	-62.32	0.77	12.28	V
	4248	-54.42	-13	-41.42	-73.3	-63.73	0.84	12.30	V
									V
									V
									V

Remark: Spurious emissions within 30-1000MHz were found more than 20dB below limit line.



EDGE 850

EDGE 850									
Channel	Frequency (MHz)	ERP (dBm)	Limit (dBm)	Over Limit (dB)	SPA Reading (dBm)	S.G. Power (dBm)	TX Cable loss (dB)	TX Antenna Gain (dBi)	Polarization (H/V)
Lowest	1648	-56.36	-13	-43.36	-66.27	-63.31	0.53	9.63	H
	2472	-45.65	-13	-32.65	-59.09	-53.63	0.65	10.78	H
	3296	-57.72	-13	-44.72	-73.86	-66.8	0.76	11.99	H
									H
									H
									H
									H
	1648	-58.00	-13	-45.00	-67.62	-64.95	0.53	9.63	V
	2472	-42.64	-13	-29.64	-56.57	-50.62	0.65	10.78	V
	3296	-58.01	-13	-45.01	-74.12	-67.09	0.76	11.99	V
									V
									V
									V
									V
Middle	1672	-53.10	-13	-40.10	-63.19	-60.1	0.53	9.68	H
	2512	-43.01	-13	-30.01	-56.43	-51.01	0.66	10.81	H
	3344	-55.97	-13	-42.97	-72.17	-65.19	0.76	12.13	H
									H
									H
									H
									H
	1672	-56.62	-13	-43.62	-66.31	-63.62	0.53	9.68	V
	2512	-41.17	-13	-28.17	-55	-49.17	0.66	10.81	V
	3344	-57.95	-13	-44.95	-73.96	-67.17	0.76	12.13	V
									V
									V
									V
									V



Highest	1696	-46.25	-13	-33.25	-56.63	-53.3	0.53	9.73	H
	2544	-43.20	-13	-30.20	-56.68	-51.21	0.67	10.83	H
	3392	-52.08	-13	-39.08	-68.39	-61.44	0.77	12.28	H
									H
									H
									H
									H
	1696	-47.67	-13	-34.67	-57.43	-54.72	0.53	9.73	V
	2544	-45.80	-13	-32.80	-59.65	-53.81	0.67	10.83	V
	3392	-52.83	-13	-39.83	-68.73	-62.19	0.77	12.28	V
									V
									V
									V
									V

Remark: Spurious emissions within 30-1000MHz were found more than 20dB below limit line.



WCDMA 850

WCDMA 850									
Channel	Frequency (MHz)	ERP (dBm)	Limit (dBm)	Over Limit (dB)	SPA Reading (dBm)	S.G. Power (dBm)	TX Cable loss (dB)	TX Antenna Gain (dBi)	Polarization (H/V)
Lowest	1648	-61.97	-13	-48.97	-71.88	-68.92	0.53	9.63	H
	2472	-58.60	-13	-45.60	-72.04	-66.58	0.65	10.78	H
	3305.6	-58.25	-13	-45.25	-74.38	-67.36	0.76	12.02	H
									H
									H
									H
									H
	1648	-63.31	-13	-50.31	-72.93	-70.26	0.53	9.63	V
	2472	-58.12	-13	-45.12	-72.05	-66.1	0.65	10.78	V
	3305.6	-58.48	-13	-45.48	-74.58	-67.59	0.76	12.02	V
									V
									V
									V
									V
Middle	1672	-57.83	-13	-44.83	-67.92	-64.83	0.53	9.68	H
	2512	-58.89	-13	-45.89	-72.31	-66.89	0.66	10.81	H
	3344	-57.85	-13	-44.85	-74.05	-67.07	0.76	12.13	H
									H
									H
									H
									H
	1672	-60.47	-13	-47.47	-70.16	-67.47	0.53	9.68	V
	2512	-58.86	-13	-45.86	-72.69	-66.86	0.66	10.81	V
	3344	-58.29	-13	-45.29	-74.3	-67.51	0.76	12.13	V
									V
									V
									V
									V
								V	



Highest	1696	-59.96	-13	-46.96	-70.34	-67.01	0.53	9.73	H
	2544	-58.78	-13	-45.78	-72.26	-66.79	0.67	10.83	H
	3392	-58.42	-13	-45.42	-74.73	-67.78	0.77	12.28	H
									H
									H
									H
									H
	1696	-62.41	-13	-49.41	-72.17	-69.46	0.53	9.73	V
	2544	-58.87	-13	-45.87	-72.72	-66.88	0.67	10.83	V
	3392	-58.50	-13	-45.50	-74.4	-67.86	0.77	12.28	V
									V
									V
									V
									V

Remark: Spurious emissions within 30-1000MHz were found more than 20dB below limit line.



WCDMA 1700

WCDMA 1700									
Channel	Frequency (MHz)	EIRP (dBm)	Limit (dBm)	Over Limit (dB)	SPA Reading (dBm)	S.G. Power (dBm)	TX Cable loss (dB)	TX Antenna Gain (dBi)	Polarization (H/V)
Lowest	3420	-53.35	-13	-40.35	-70.42	-64.94	0.77	12.36	H
	5136	-52.27	-13	-39.27	-72.51	-63.77	0.97	12.47	H
	6846	-51.45	-13	-38.45	-75.03	-62.27	0.82	11.64	H
									H
									H
									H
									H
	3420	-51.49	-13	-38.49	-68.37	-63.08	0.77	12.36	V
	5136	-50.15	-13	-37.15	-70.56	-61.65	0.97	12.47	V
	6846	-45.69	-13	-32.69	-69.74	-56.51	0.82	11.64	V
									V
									V
									V
									V
Middle	3468	-51.69	-13	-38.69	-68.79	-63.42	0.78	12.50	H
	5196	-52.96	-13	-39.96	-73.31	-64.56	0.99	12.59	H
	6924	-50.88	-13	-37.88	-74.65	-61.35	0.99	11.47	H
									H
									H
									H
									H
	3468	-50.88	-13	-37.88	-68.37	-62.61	0.78	12.50	V
	5196	-50.81	-13	-37.81	-71.32	-62.41	0.99	12.59	V
	6924	-45.67	-13	-32.67	-69.82	-56.14	0.99	11.47	V
									V
									V
									V
									V



Highest	3504	-54.46	-13	-41.46	-71.58	-66.28	0.78	12.60	H
	5256	-53.84	-13	-40.84	-74.38	-65.54	1.01	12.71	H
	7014	-49.93	-13	-36.93	-73.94	-60.04	1.17	11.27	H
									H
									H
									H
									H
	3504	-51.84	-13	-38.84	-69.93	-63.66	0.78	12.60	V
	5256	-51.47	-13	-38.47	-72.15	-63.17	1.01	12.71	V
	7014	-47.52	-13	-34.52	-71.82	-57.63	1.17	11.27	V
									V
									V
									V
									V

Remark: Spurious emissions within 30-1000MHz were found more than 20dB below limit line.



GPRS 1900

GPRS 1900									
Channel	Frequency (MHz)	EIRP (dBm)	Limit (dBm)	Over Limit (dB)	SPA Reading (dBm)	S.G. Power (dBm)	TX Cable loss (dB)	TX Antenna Gain (dBi)	Polarization (H/V)
Lowest	3702	-53.99	-13	-40.99	-70.98	-65.78	0.72	12.52	H
	5550	-47.31	-13	-34.31	-69.17	-59.48	1.00	13.17	H
	7398	-50.79	-13	-37.79	-75.91	-60.19	1.18	10.58	H
									H
									H
									H
									H
	3702	-58.30	-13	-45.30	-76.46	-70.09	0.72	12.52	V
	5550	-39.71	-13	-26.71	-61.66	-51.88	1.00	13.17	V
	7398	-51.15	-13	-38.15	-76.06	-60.55	1.18	10.58	V
									V
									V
									V
									V
Middle	3762	-52.25	-13	-39.25	-69.4	-64.06	0.69	12.50	H
	5640	-48.41	-13	-35.41	-70.13	-60.54	0.98	13.12	H
	7518	-51.14	-13	-38.14	-76.05	-60.41	1.18	10.45	H
									H
									H
									H
									H
	3762	-51.64	-13	-38.64	-70	-63.45	0.69	12.50	V
	5640	-48.75	-13	-35.75	-70.64	-60.88	0.98	13.12	V
	7518	-51.42	-13	-38.42	-76.38	-60.69	1.18	10.45	V
									V
									V
									V
									V
								V	



Highest	3822	-48.28	-13	-35.28	-65.55	-60.06	0.69	12.47	H
	5730	-46.91	-13	-33.91	-68.65	-58.98	0.99	13.06	H
	7638	-50.80	-13	-37.80	-75.98	-60.4	1.18	10.79	H
									H
									H
									H
									H
	3822	-50.87	-13	-37.87	-69.36	-62.65	0.69	12.47	V
	5730	-49.05	-13	-36.05	-71	-61.12	0.99	13.06	V
	7638	-51.17	-13	-38.17	-76.1	-60.77	1.18	10.79	V
									V
									V
									V
									V

Remark: Spurious emissions within 30-1000MHz were found more than 20dB below limit line.



EDGE1900

EDGE 1900									
Channel	Frequency (MHz)	EIRP (dBm)	Limit (dBm)	Over Limit (dB)	SPA Reading (dBm)	S.G. Power (dBm)	TX Cable loss (dB)	TX Antenna Gain (dBi)	Polarization (H/V)
Lowest	3702	-58.30	-13	-45.30	-75.29	-70.09	0.72	12.52	H
	5550	-47.40	-13	-34.40	-69.26	-59.57	1.00	13.17	H
	7398	-51.02	-13	-38.02	-76.14	-60.42	1.18	10.58	H
									H
									H
									H
									H
	3702	-54.56	-13	-41.56	-72.72	-66.35	0.72	12.52	V
	5550	-48.33	-13	-35.33	-70.28	-60.5	1.00	13.17	V
	7398	-50.82	-13	-37.82	-75.73	-60.22	1.18	10.58	V
									V
									V
									V
									V
Middle	3762	-53.61	-13	-40.61	-70.76	-65.42	0.69	12.50	H
	5640	-47.57	-13	-34.57	-69.29	-59.7	0.98	13.12	H
	7518	-51.19	-13	-38.19	-76.1	-60.46	1.18	10.45	H
									H
									H
									H
									H
	3762	-54.04	-13	-41.04	-72.4	-65.85	0.69	12.50	V
	5640	-45.85	-13	-32.85	-67.74	-57.98	0.98	13.12	V
	7518	-51.46	-13	-38.46	-76.42	-60.73	1.18	10.45	V
									V
									V
									V
									V



Highest	3822	-47.70	-13	-34.70	-64.97	-59.48	0.69	12.47	H
	5730	-47.78	-13	-34.78	-69.52	-59.85	0.99	13.06	H
	7638	-51.04	-13	-38.04	-76.22	-60.64	1.18	10.79	H
									H
									H
									H
									H
	3822	-51.83	-13	-38.83	-70.32	-63.61	0.69	12.47	V
	5730	-48.97	-13	-35.97	-70.92	-61.04	0.99	13.06	V
	7638	-50.41	-13	-37.41	-75.34	-60.01	1.18	10.79	V
									V
									V
									V
									V

Remark: Spurious emissions within 30-1000MHz were found more than 20dB below limit line.



WCDMA 1900

WCDMA 1900									
Channel	Frequency (MHz)	EIRP (dBm)	Limit (dBm)	Over Limit (dB)	SPA Reading (dBm)	S.G. Power (dBm)	TX Cable loss (dB)	TX Antenna Gain (dBi)	Polarization (H/V)
Lowest	3708	-46.40	-13	-33.40	-63.6	-58.2	0.72	12.52	H
	5562	-53.33	-13	-40.33	-74.76	-65.5	1.00	13.16	H
	7410	-50.22	-13	-37.22	-75.01	-59.6	1.18	10.56	H
									H
									H
									H
									H
	3708	-49.40	-13	-36.40	-67.42	-61.2	0.72	12.52	V
	5562	-51.93	-13	-38.93	-73.28	-64.1	1.00	13.16	V
	7410	-50.72	-13	-37.72	-75.07	-60.1	1.18	10.56	V
									V
									V
									V
									V
Middle	3756	-48.40	-13	-35.40	-65.41	-60.2	0.69	12.50	H
	5640	-52.17	-13	-39.17	-73.71	-64.3	0.98	13.12	H
	7524	-46.21	-13	-33.21	-71.11	-55.5	1.18	10.47	H
									H
									H
									H
									H
	3756	-50.60	-13	-37.60	-68.87	-62.4	0.69	12.50	V
	5640	-51.17	-13	-38.17	-72.48	-63.3	0.98	13.12	V
	7524	-47.31	-13	-34.31	-71.8	-56.6	1.18	10.47	V
									V
									V
									V
									V
								V	



Highest	3816	-46.41	-13	-33.41	-63.39	-58.2	0.69	12.47	H
	5724	-51.73	-13	-38.73	-73.26	-63.8	0.99	13.07	H
	7632	-43.71	-13	-30.71	-68.96	-53.3	1.18	10.77	H
									H
									H
									H
									H
	3816	-50.41	-13	-37.41	-68.88	-62.2	0.69	12.47	V
	5724	-49.43	-13	-36.43	-71.14	-61.5	0.99	13.07	V
	7632	-44.51	-13	-31.51	-69.11	-54.1	1.18	10.77	V
									V
									V
									V
									V

Remark: Spurious emissions within 30-1000MHz were found more than 20dB below limit line.