



FCC RADIO TEST REPORT

FCC ID : PY7-35228T
Equipment : GSM/WCDMA/LTE Phone+Bluetooth,
DTS/UNII a/b/g/n/ac and NFC
Brand Name : Sony
Applicant : Sony Mobile Communications Inc.
4-12-3 Higashi-Shinagawa, Shinagawa-ku,
Tokyo, 140-0002, Japan
Manufacturer : Sony Mobile Communications Inc.
4-12-3 Higashi-Shinagawa, Shinagawa-ku,
Tokyo, 140-0002, Japan
Standard : FCC Part 15 Subpart C §15.247

The product was received on Aug. 31, 2018 and testing was started from Sep. 14, 2018 and completed on Nov. 24, 2018. We, SPORTON INTERNATIONAL INC., would like to declare that the tested sample has been evaluated in accordance with the test procedures and has been in compliance with the applicable technical standards.

The report must not be used by the client to claim product certification, approval, or endorsement by TAF or any agency of government.

The test results in this report apply exclusively to the tested model / sample. Without written approval of SPORTON INTERNATIONAL INC. EMC & Wireless Communications Laboratory, the test report shall not be reproduced except in full.

Approved by: Jones Tsai

SPORTON INTERNATIONAL INC. EMC & Wireless Communications Laboratory
No. 52, Huaya 1st Rd., Guishan Dist., Taoyuan City, Taiwan (R.O.C.)



Table of Contents

| | |
|---|-----------|
| History of this test report..... | 3 |
| Summary of Test Result | 4 |
| 1 General Description..... | 5 |
| 1.1 Product Feature of Equipment Under Test | 5 |
| 1.2 Modification of EUT | 5 |
| 1.3 Testing Location | 6 |
| 1.4 Applicable Standards..... | 6 |
| 2 Test Configuration of Equipment Under Test | 7 |
| 2.1 Carrier Frequency Channel..... | 7 |
| 2.2 Test Mode..... | 8 |
| 2.3 Connection Diagram of Test System..... | 9 |
| 2.4 Support Unit used in test configuration and system..... | 10 |
| 2.5 EUT Operation Test Setup..... | 10 |
| 2.6 Measurement Results Explanation Example | 10 |
| 3 Test Result | 11 |
| 3.1 6dB and 99% Bandwidth Measurement | 11 |
| 3.2 Output Power Measurement | 18 |
| 3.3 Power Spectral Density Measurement | 19 |
| 3.4 Conducted Band Edges and Spurious Emission Measurement..... | 26 |
| 3.5 Radiated Band Edges and Spurious Emission Measurement..... | 35 |
| 3.6 AC Conducted Emission Measurement..... | 39 |
| 3.7 Antenna Requirements | 41 |
| 4 List of Measuring Equipment..... | 42 |
| 5 Uncertainty of Evaluation..... | 44 |
| Appendix A. Conducted Test Results | |
| Appendix B. AC Conducted Emission Test Result | |
| Appendix C. Radiated Spurious Emission | |
| Appendix D. Radiated Spurious Emission Plots | |
| Appendix E. Duty Cycle Plots | |



Summary of Test Result

| Report Clause | Ref Std. Clause | Test Items | Result (PASS/FAIL) | Remark |
|---------------|-----------------------|--|--------------------|---|
| 3.1 | 15.247(a)(2) | 6dB Bandwidth | Pass | - |
| 3.1 | 2.1049 | 99% Occupied Bandwidth | Reporting only | - |
| 3.2 | 15.247(b)(3) | Peak Output Power | Pass | - |
| 3.3 | 15.247(e) | Power Spectral Density | Pass | - |
| 3.4 | 15.247(d) | Conducted Band Edges and Spurious Emission | Pass | - |
| 3.5 | 15.247(d) | Radiated Band Edges and Spurious Emission | Pass | Under limit 3.09 dB at 41.610 MHz |
| 3.6 | 15.207 | AC Conducted Emission | Pass | Under limit 11.56 dB at 1.066 MHz |
| 3.7 | 15.203 & 15.247(b) | Antenna Requirement | Pass | - |

Reviewed by: Wii Chang

Report Producer: Natasha Hsieh



1 General Description

1.1 Product Feature of Equipment Under Test

GSM/WCDMA/LTE, Bluetooth, DTS/UNII a/b/g/n/ac, FM Receiver, NFC, and GNSS.

| Standards-related Product Specification | |
|---|---------------------------------|
| Antenna Type / Gain | PIFA Antenna with gain -3.2 dBi |

| EUT Information List | | | |
|----------------------|------------|------------|----------------------------|
| HW Version | SW Version | S/N | Performed Test Item |
| A | 1.129 | CQ3001BTLD | RF conducted measurement |
| | | CQ3001BN5M | Radiated Spurious Emission |
| | | CQ3001BMVB | AC Conducted Emission |

| Accessory List | |
|----------------|---|
| AC Adapter | Model Name: UCH32 |
| | S/N: 6218W30200215 (for radiated emission) 6218W30200140 (for conducted emission) |
| | Model Name: MH410c |
| Earphone | S/N: N/A |
| | Model Name: UCB24 |
| USB Cable | S/N: N/A |

Note:

1. Above EUT list used are electrically identical per declared by manufacturer.
2. Above the accessories list are used to exercise the EUT during test, and the serial number of each type of accessories is listed in each section of this report. .
3. For other wireless features of this EUT, test report will be issued separately.

1.2 Modification of EUT

No modifications are made to the EUT during all test items.



1.3 Testing Location

Sporton Lab is accredited to ISO 17025 by Taiwan Accreditation Foundation (TAF code : 1190) and the FCC designation No. TW1190 and TW0007 under the FCC 2.948(e) by Mutual Recognition Agreement (MRA) in FCC Test.

| | | |
|---------------------------|---|---------|
| Test Site | SPORTON INTERNATIONAL INC. | |
| Test Site Location | No.52, Huaya 1st Rd., Guishan Dist., Taoyuan City, Taiwan (R.O.C.) TEL: +886-3-327-3456 FAX: +886-3-328-4978 | |
| Test Site No. | Sporton Site No. | |
| | TH05-HY | CO05-HY |

Note: The test site complies with ANSI C63.4 2014 requirement.

| | | |
|---------------------------|---|--|
| Test Site | SPORTON INTERNATIONAL INC. | |
| Test Site Location | No.58, Aly. 75, Ln. 564, Wenhua 3rd, Rd., Guishan Dist., Taoyuan City, Taiwan (R.O.C.) TEL: +886-3-327-0868 FAX: +886-3-327-0855 | |
| Test Site No. | Sporton Site No. | |
| | 03CH11-HY | |

Note: The test site complies with ANSI C63.4 2014 requirement.

1.4 Applicable Standards

According to the specifications of the manufacturer, the EUT must comply with the requirements of the following standards:

- ♦ FCC Part 15 Subpart C §15.247
- ♦ FCC KDB Publication No. 558074 D01 DTS Meas. Guidance v05
- ♦ FCC KDB 414788 D01 Radiated Test Site v01r01.
- ♦ ANSI C63.10-2013

Remark:

1. All test items were verified and recorded according to the standards and without any deviation during the test.
2. This EUT has also been tested and complied with the requirements of FCC Part 15, Subpart B, recorded in a separate test report.



2 Test Configuration of Equipment Under Test

2.1 Carrier Frequency Channel

| Frequency Band | Channel | Freq. (MHz) | Channel | Freq. (MHz) |
|-----------------|---------|-------------|---------|-------------|
| 2400-2483.5 MHz | 0 | 2402 | 21 | 2444 |
| | 1 | 2404 | 22 | 2446 |
| | 2 | 2406 | 23 | 2448 |
| | 3 | 2408 | 24 | 2450 |
| | 4 | 2410 | 25 | 2452 |
| | 5 | 2412 | 26 | 2454 |
| | 6 | 2414 | 27 | 2456 |
| | 7 | 2416 | 28 | 2458 |
| | 8 | 2418 | 29 | 2460 |
| | 9 | 2420 | 30 | 2462 |
| | 10 | 2422 | 31 | 2464 |
| | 11 | 2424 | 32 | 2466 |
| | 12 | 2426 | 33 | 2468 |
| | 13 | 2428 | 34 | 2470 |
| | 14 | 2430 | 35 | 2472 |
| | 15 | 2432 | 36 | 2474 |
| | 16 | 2434 | 37 | 2476 |
| | 17 | 2436 | 38 | 2478 |
| | 18 | 2438 | 39 | 2480 |
| | 19 | 2440 | - | - |
| 20 | 2442 | - | - | |



2.2 Test Mode

- a. The EUT has been associated with peripherals and configuration operated in a manner tended to maximize its emission characteristics in a typical application. Frequency range investigated: conduction emission (150 kHz to 30 MHz), radiation emission (9 kHz to the 10th harmonic of the highest fundamental frequency or to 40 GHz, whichever is lower). For radiated measurement, pre-scanned in three orthogonal panels, X, Y, Z. The worst cases (X plane) were recorded in this report.
- b. AC power line Conducted Emission was tested under maximum output power.

The following summary table is showing all test modes to demonstrate in compliance with the standard.

| Summary table of Test Cases | |
|------------------------------|--|
| Test Item | Data Rate / Modulation |
| | Bluetooth – LE / GFSK |
| Conducted Test Cases | Mode 1: Bluetooth Tx CH00_2402 MHz_1Mbps Mode 2: Bluetooth Tx CH19_2440 MHz_1Mbps Mode 3: Bluetooth Tx CH39_2480 MHz_1Mbps Mode 4: Bluetooth Tx CH00_2402 MHz_2Mbps Mode 5: Bluetooth Tx CH19_2440 MHz_2Mbps Mode 6: Bluetooth Tx CH39_2480 MHz_2Mbps |
| Radiated Test Cases | Mode 1: Bluetooth Tx CH00_2402 MHz_1Mbps Mode 2: Bluetooth Tx CH19_2440 MHz_1Mbps Mode 3: Bluetooth Tx CH39_2480 MHz_1Mbps Mode 4: Bluetooth Tx CH00_2402 MHz_2Mbps Mode 5: Bluetooth Tx CH19_2440 MHz_2Mbps Mode 6: Bluetooth Tx CH39_2480 MHz_2Mbps |
| AC Conducted Emission | Mode 1: Bluetooth Link + WLAN (2.4GHz) Link + Earphone + Battery + USB Cable (Charging from Adapter) |

2.3 Connection Diagram of Test System

<Bluetooth Tx Mode>

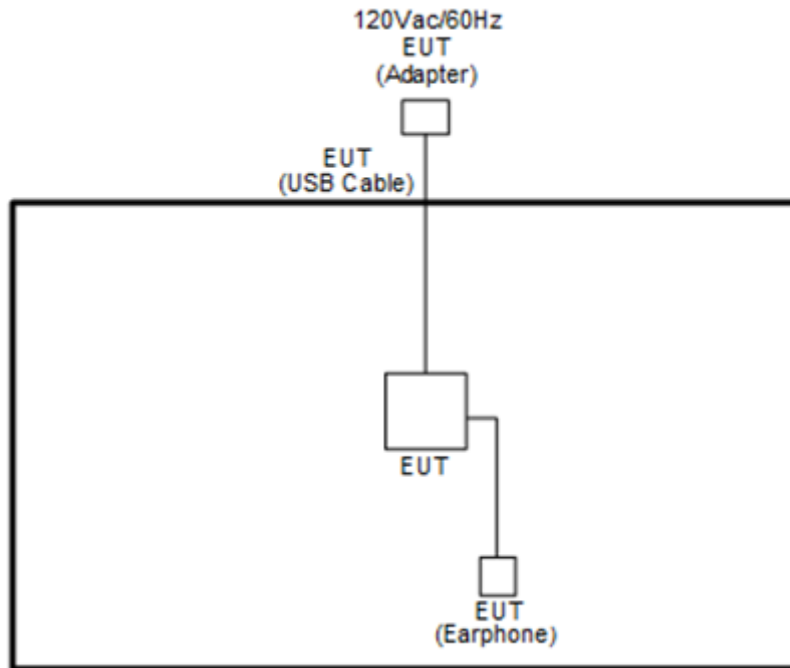

<AC Conducted Emissions>

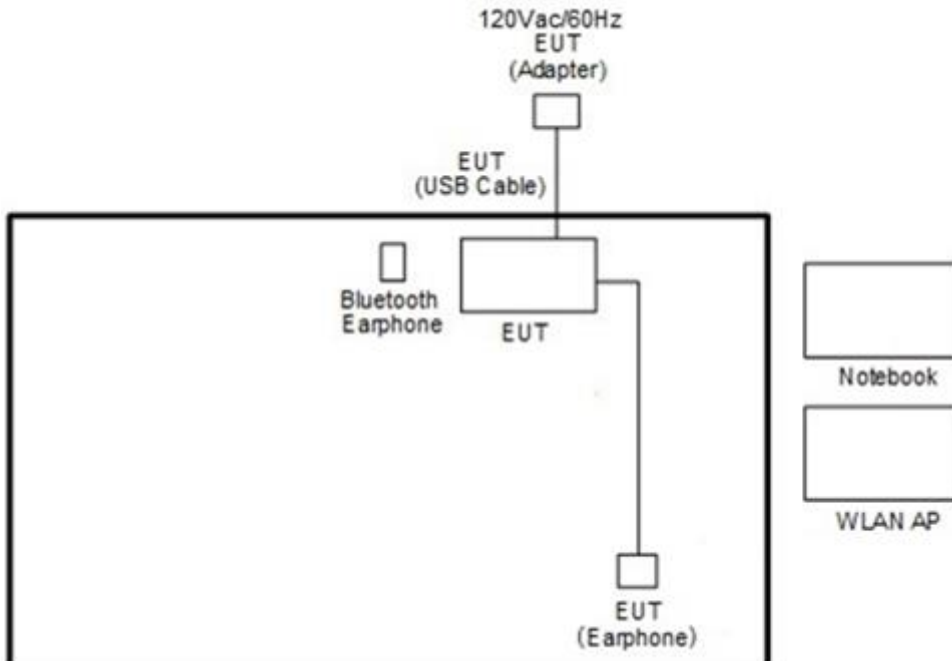



2.4 Support Unit used in test configuration and system

| Item | Equipment | Trade Name | Model Name | FCC ID | Data Cable | Power Cord |
|------|--------------------|------------|------------|--|------------|--|
| 1. | WLAN AP | ASUS | RT-AC66U | MSQ-RTAC66U | N/A | Unshielded, 1.8 m |
| 2. | Bluetooth Earphone | Sony | SBH20 | PY7-RD0010 | N/A | N/A |
| 3. | Notebook | DELL | P20G | FCC DoC/ Contains FCC ID: QDS-BRCM1051 | N/A | AC I/P: Unshielded, 1.2 m DC O/P: Shielded, 1.8 m |
| 4. | SD Card | SanDisk | MicroSD HC | FCC DoC | N/A | N/A |

2.5 EUT Operation Test Setup

The RF test items, utility “QRCT” was installed in Notebook which was programmed in order to make the EUT get into the engineering modes to provide channel selection, power level, data rate and the application type and for continuous transmitting signals.

2.6 Measurement Results Explanation Example

For all conducted test items:

The offset level is set in the spectrum analyzer to compensate the RF cable loss and attenuator factor between EUT conducted output port and spectrum analyzer. With the offset compensation, the spectrum analyzer reading level is exactly the EUT RF output level.

Example :

The spectrum analyzer offset is derived from RF cable loss and attenuator factor.

Offset = RF cable loss + attenuator factor.

Following shows an offset computation example with cable loss 4.2 dB and 10dB attenuator.

$$\begin{aligned} \text{Offset(dB)} &= \text{RF cable loss(dB)} + \text{attenuator factor(dB)}. \\ &= 4.2 + 10 = 14.2 \text{ (dB)} \end{aligned}$$

3 Test Result

3.1 6dB and 99% Bandwidth Measurement

3.1.1 Limit of 6dB and 99% Bandwidth

The minimum 6 dB bandwidth shall be at least 500 kHz.

3.1.2 Measuring Instruments

See list of measuring equipment of this test report.

3.1.3 Test Procedures

1. The testing follows FCC KDB Publication No. 558074 D01 DTS Meas. Guidance v05.
2. The RF output of EUT was connected to the spectrum analyzer by RF cable and attenuator. The path loss was compensated to the results for each measurement.
3. Set to the maximum power setting and enable the EUT transmit continuously.
4. Make the measurement with the spectrum analyzer's resolution bandwidth (RBW) = 100 kHz. Set the Video bandwidth (VBW) = 300 kHz. In order to make an accurate measurement. The 6 dB bandwidth must be greater than 500 kHz.
5. For 99% Bandwidth Measurement, the spectrum analyzer's resolution bandwidth (RBW) is set 1-5% of the emission bandwidth and set the Video bandwidth (VBW) $\geq 3 * RBW$.
6. Measure and record the results in the test report.

3.1.4 Test Setup

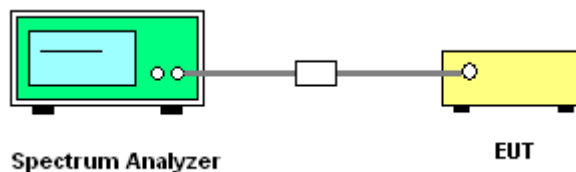



3.1.5 Test Result of 6dB Bandwidth

Please refer to Appendix A.

<1 Mbps>

6 dB Bandwidth Plot on Channel 00

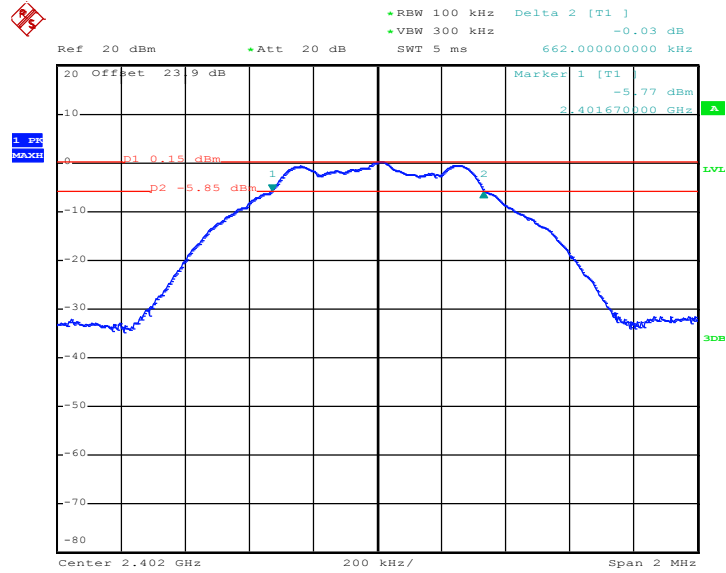

Date: 21.SEP.2018 18:29:15

6 dB Bandwidth Plot on Channel 19

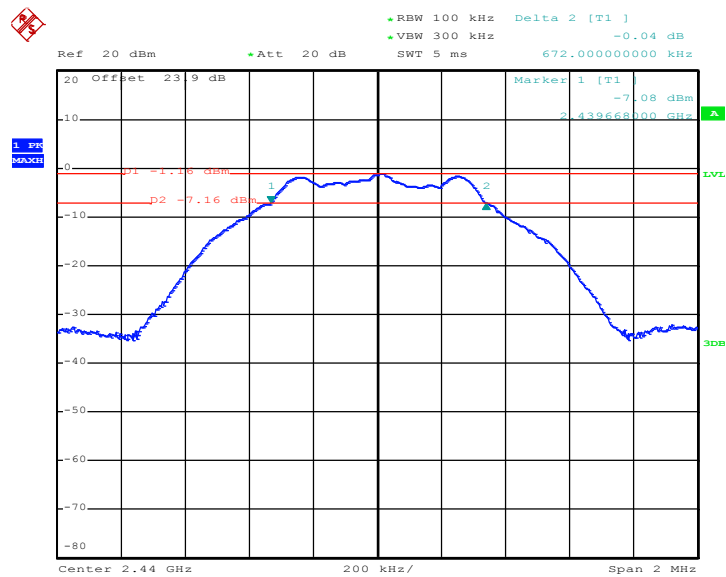

Date: 21.SEP.2018 18:33:11



6 dB Bandwidth Plot on Channel 39

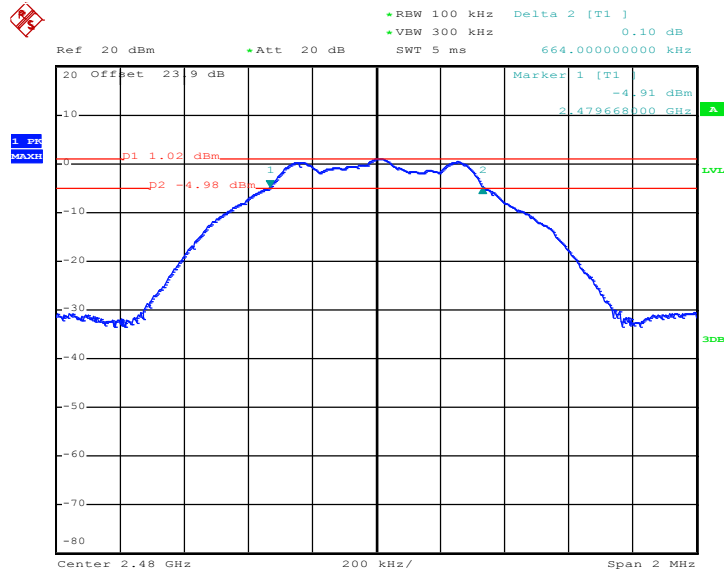

Date: 21.SEP.2018 18:36:00

<2 Mbps>

6 dB Bandwidth Plot on Channel 00

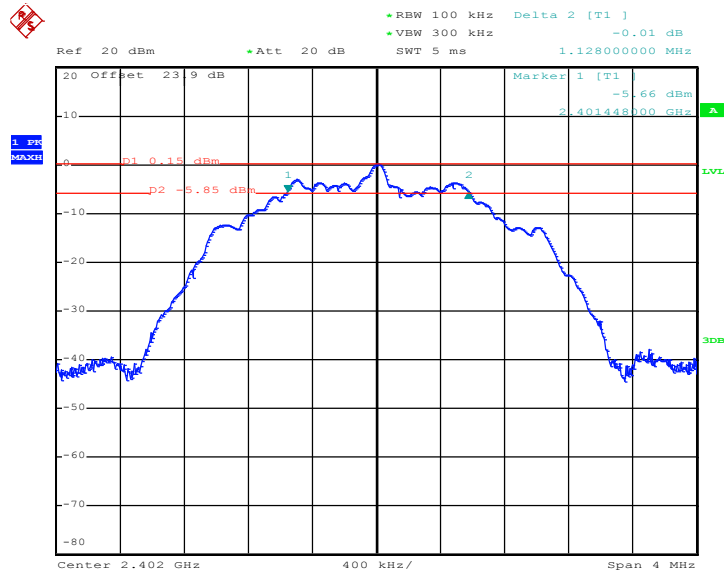

Date: 21.SEP.2018 18:40:25



6 dB Bandwidth Plot on Channel 19

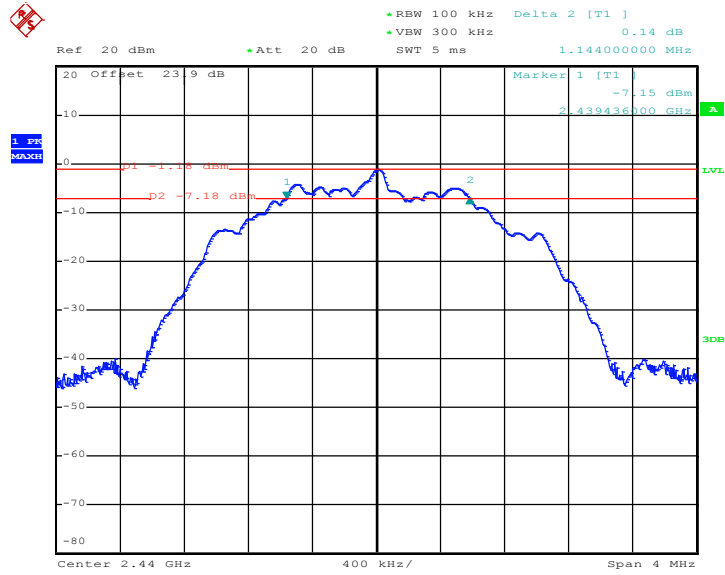

Date: 21.SEP.2018 18:43:21

6 dB Bandwidth Plot on Channel 39

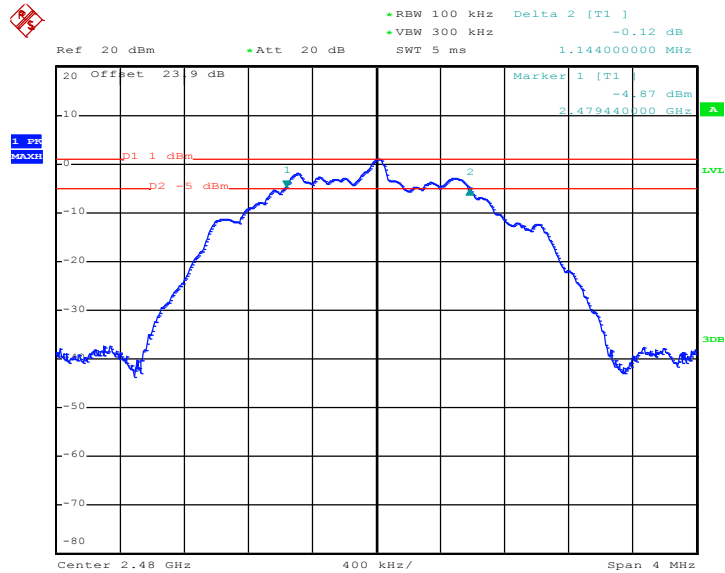

Date: 21.SEP.2018 18:46:54



3.1.6 Test Result of 99% Occupied Bandwidth

Please refer to Appendix A.

<1 Mbps>

99% Bandwidth Plot on Channel 00

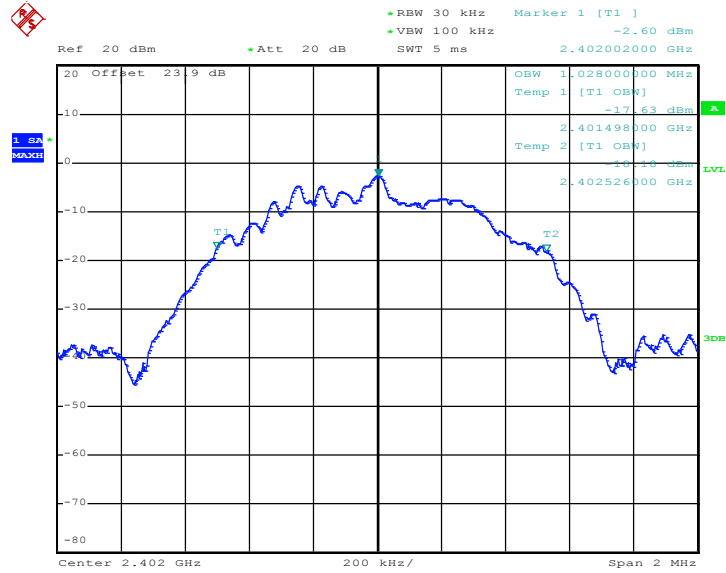

Date: 21.SEP.2018 18:31:57

99% Occupied Bandwidth Plot on Channel 19

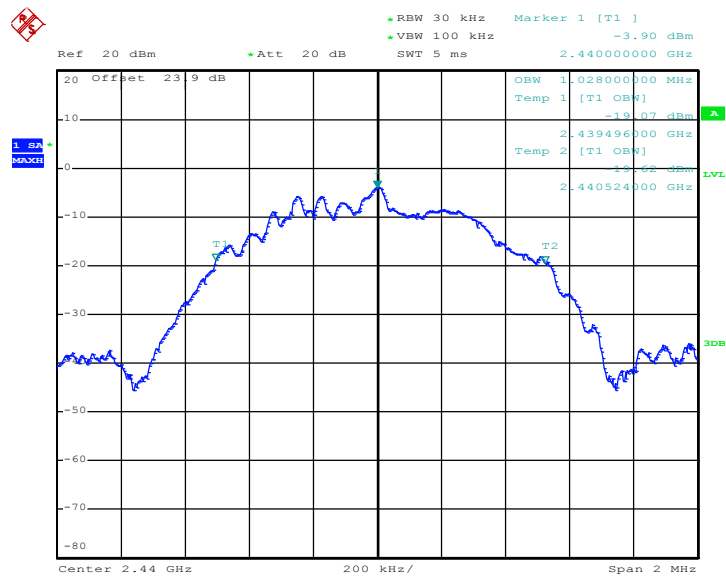

Date: 21.SEP.2018 18:34:54



99% Occupied Bandwidth Plot on Channel 39

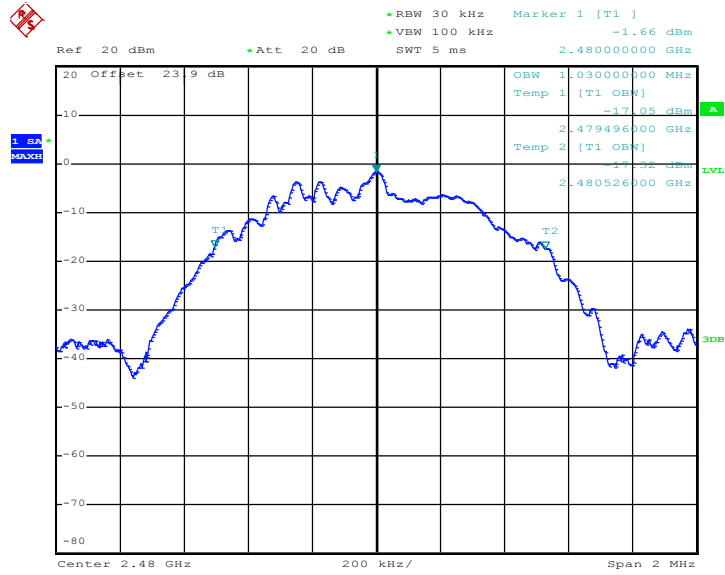

Date: 21.SEP.2018 18:39:07

<2 Mbps>

99% Bandwidth Plot on Channel 00

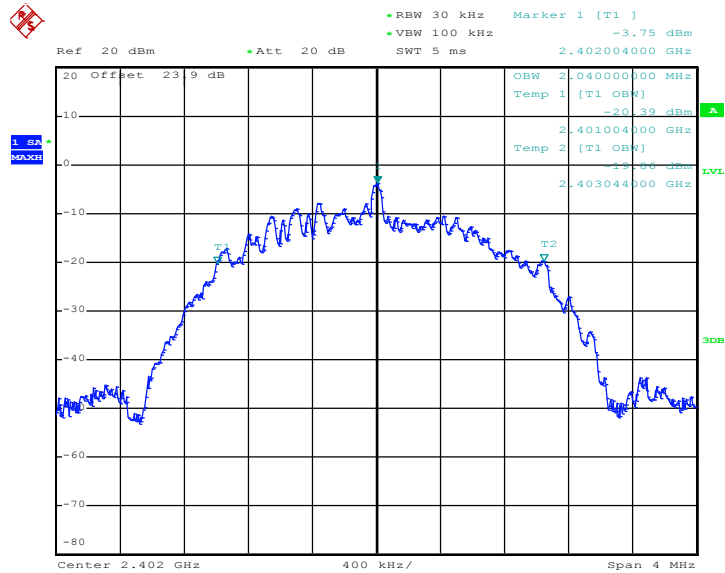

Date: 21.SEP.2018 18:42:29



99% Occupied Bandwidth Plot on Channel 19

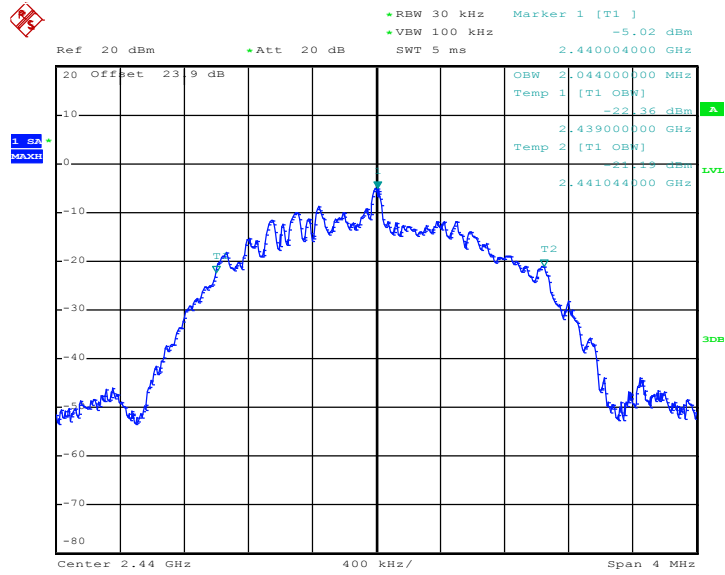

Date: 21.SEP.2018 18:45:35

99% Occupied Bandwidth Plot on Channel 39

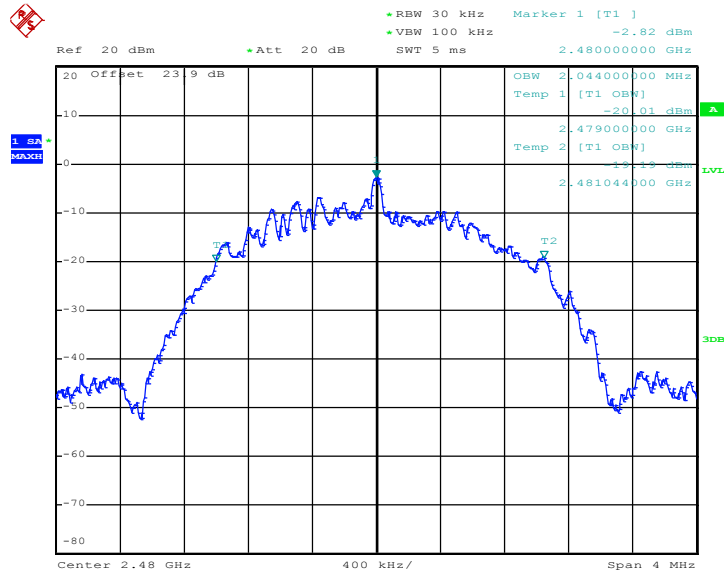

Date: 21.SEP.2018 18:48:48

Note : The occupied channel bandwidth is maintained within the band of operation for all of the modulations.

3.2 Output Power Measurement

3.2.1 Limit of Output Power

For systems using digital modulation in the 2400-2483.5MHz, the limit for peak output power is 30dBm. If transmitting antenna of directional gain greater than 6dBi is used, the peak output power from the intentional radiator shall be reduced below the above stated value by the amount in dB that the directional gain of the antenna exceeds 6 dBi. In case of point-to-point operation, the limit has to be reduced by 1dB for every 3dB that the directional gain of the antenna exceeds 6dBi.

3.2.2 Measuring Instruments

See list of measuring equipment of this test report.

3.2.3 Test Procedures

1. For Peak Power, the testing follows the Measurement Procedure of FCC KDB No. 558074 DTS D01 Meas. Guidance v05 section 9.1.3 PKPM1 Peak power meter method.
2. For Average Power, the testing follows the Measurement Procedure of FCC KDB No. 558074 DTS D01 Meas. Guidance v05 section 9.2.3.1 Method AVGPM.
3. The RF output of EUT was connected to the power meter by RF cable and attenuator.
4. The path loss was compensated to the results for each measurement.
5. Set to the maximum power setting and enable the EUT transmit continuously.
6. Measure the conducted output power and record the results in the test report.

3.2.4 Test Setup

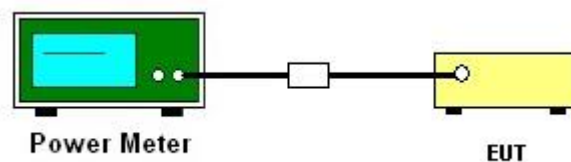

3.2.5 Test Result of Peak Output Power

Please refer to Appendix A.

3.2.6 Test Result of Average Output Power (Reporting Only)

Please refer to Appendix A.

3.3 Power Spectral Density Measurement

3.3.1 Limit of Power Spectral Density

The peak power spectral density shall not be greater than 8dBm in any 3kHz band at any time interval of continuous transmission.

3.3.2 Measuring Instruments

See list of measuring equipment of this test report.

3.3.3 Test Procedures

1. The testing follows Measurement Procedure 10.2 Method PKPSD of FCC KDB Publication No. 558074 D01 DTS Meas. Guidance v05
2. The RF output of EUT was connected to the spectrum analyzer by RF cable and attenuator. The path loss was compensated to the results for each measurement.
3. Set to the maximum power setting and enable the EUT transmit continuously.
4. Make the measurement with the spectrum analyzer's resolution bandwidth (RBW) = 3 kHz. Video bandwidth VBW = 10 kHz In order to make an accurate measurement, set the span to 1.5 times DTS Channel Bandwidth. (6dB BW)
5. Detector = peak, Sweep time = auto couple, Trace mode = max hold, Allow trace to fully stabilize. Use the peak marker function to determine the maximum power level.
6. Measure and record the results in the test report.
7. The Measured power density (dBm)/ 100kHz is a reference level and used as 20dBc down limit line for Conducted Band Edges and Conducted Spurious Emission.

3.3.4 Test Setup

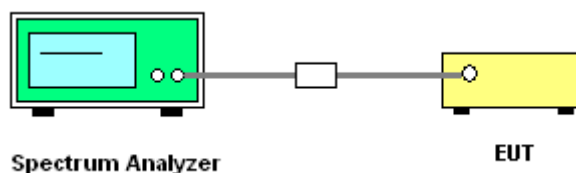

3.3.5 Test Result of Power Spectral Density

Please refer to Appendix A.



3.3.6 Test Result of Power Spectral Density Plots (100kHz)

<1 Mbps>

PSD 100kHz Plot on Channel 00

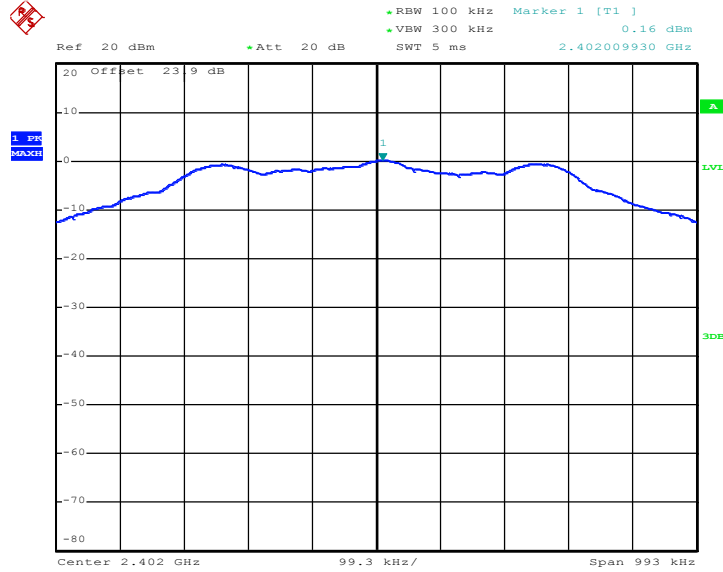

Date: 21.SEP.2018 18:30:06

PSD 100kHz Plot on Channel 19

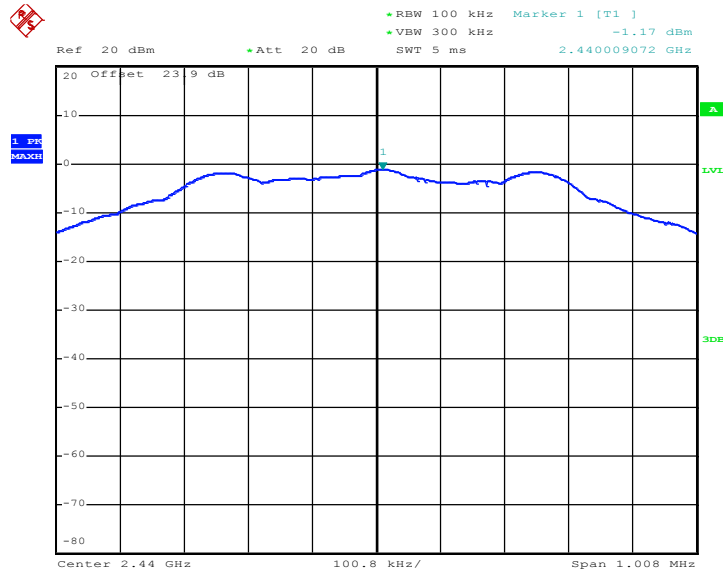

Date: 21.SEP.2018 18:33:48



PSD 100kHz Plot on Channel 39

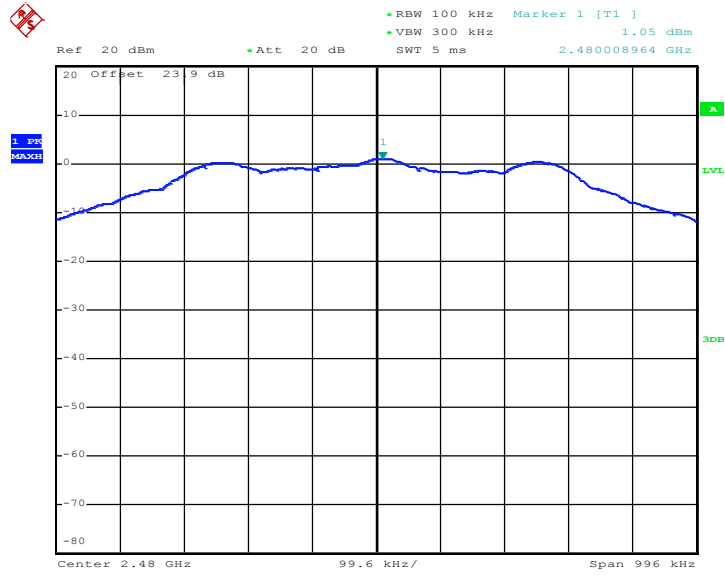

Date: 21.SEP.2018 18:37:15

<2 Mbps>

PSD 100kHz Plot on Channel 00

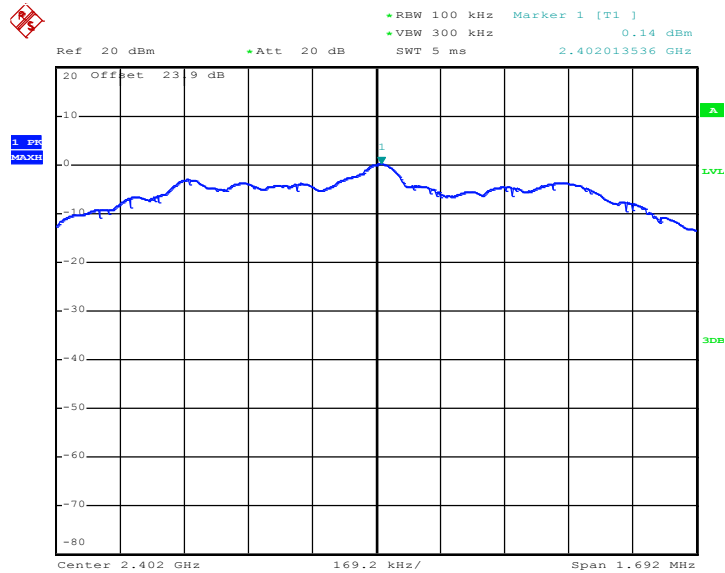

Date: 21.SEP.2018 18:41:05



PSD 100kHz Plot on Channel 19

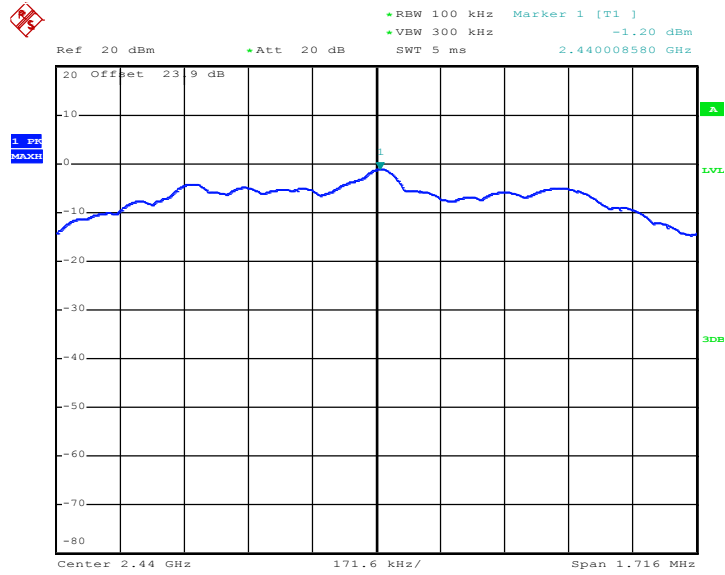

Date: 21.SEP.2018 18:44:11

PSD 100kHz Plot on Channel 39

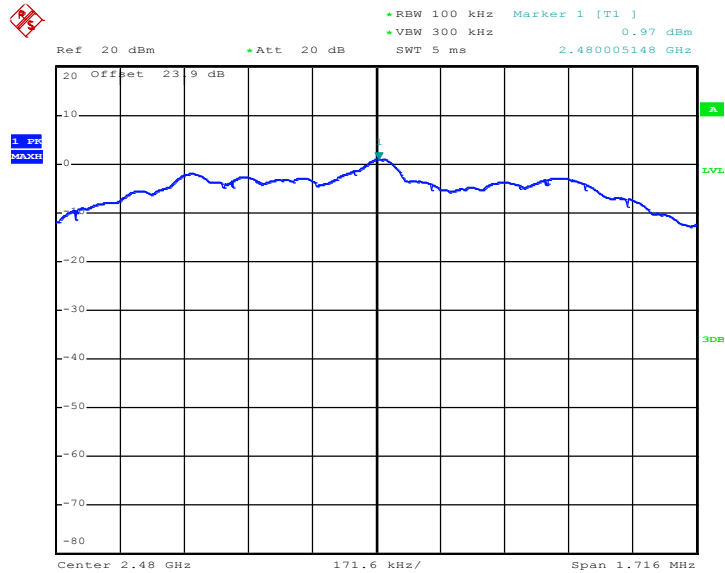

Date: 21.SEP.2018 18:47:20



3.3.7 Test Result of Power Spectral Density Plots (3kHz)

<1 Mbps>

PSD 3kHz Plot on Channel 00

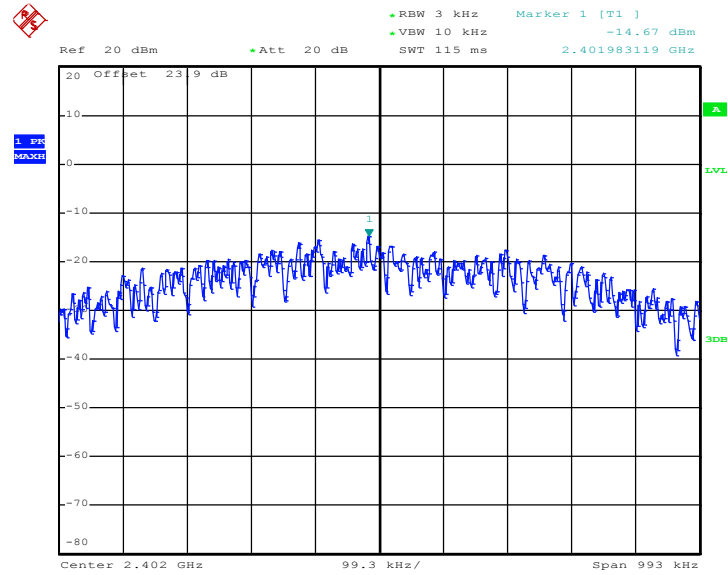

Date: 21.SEP.2018 18:29:50

PSD 3kHz Plot on Channel 19

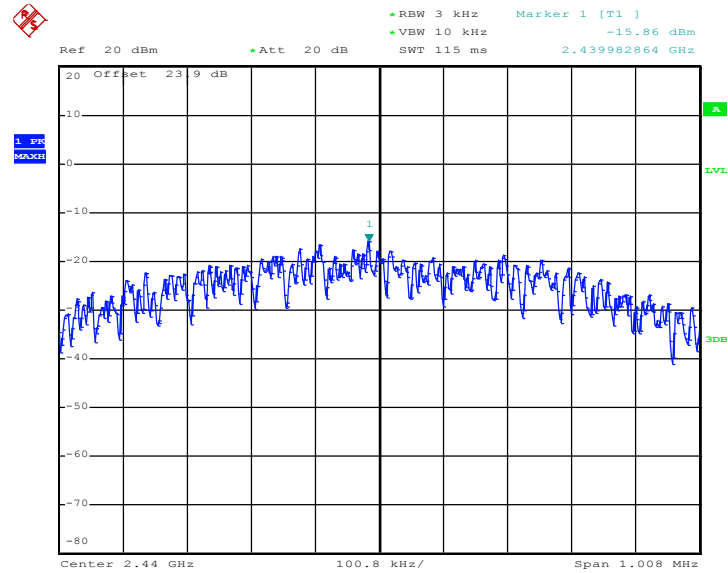

Date: 21.SEP.2018 18:33:34



PSD 3kHz Plot on Channel 39

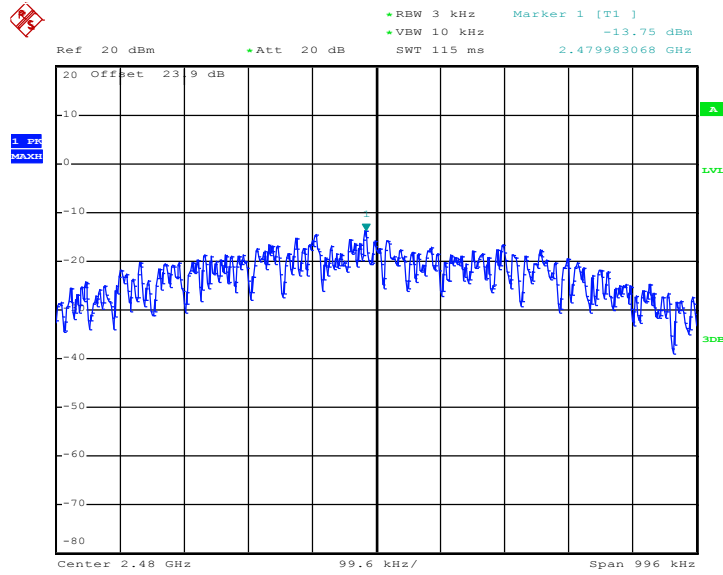

Date: 21.SEP.2018 18:37:02

<2 Mbps>

PSD 3kHz Plot on Channel 00

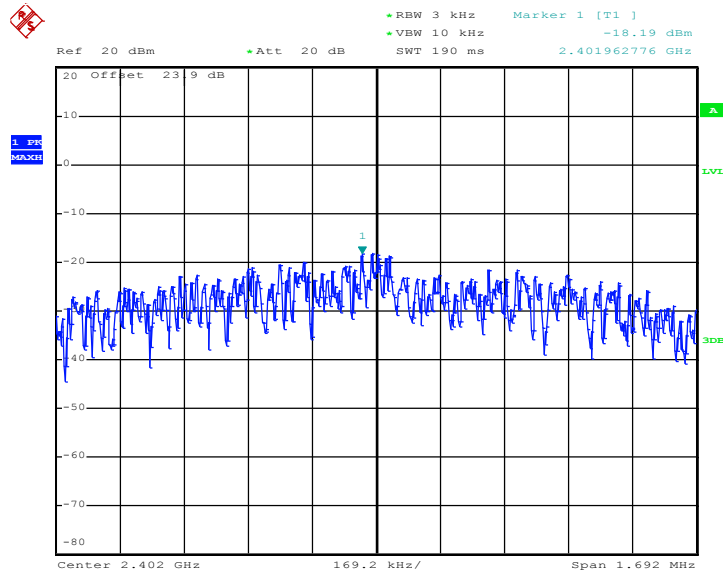

Date: 21.SEP.2018 18:40:50



PSD 3kHz Plot on Channel 19

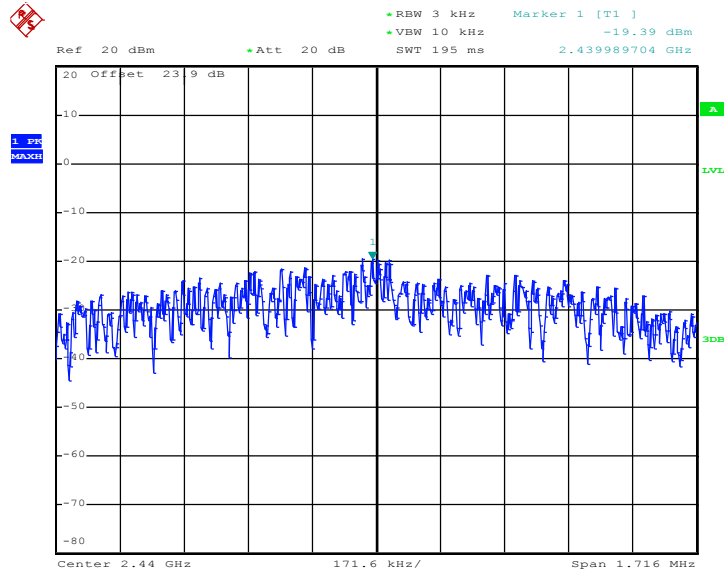

Date: 21.SEP.2018 18:43:52

PSD 3kHz Plot on Channel 39

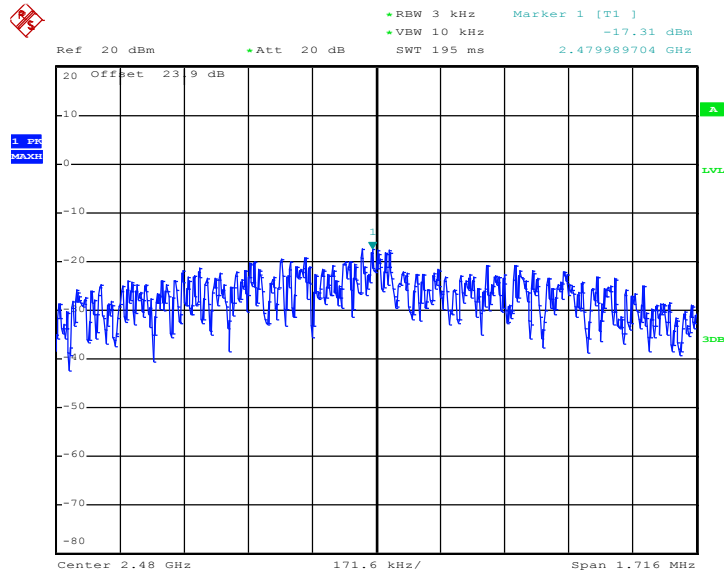

Date: 21.SEP.2018 18:47:07

3.4 Conducted Band Edges and Spurious Emission Measurement

3.4.1 Limit of Conducted Band Edges and Spurious Emission

All harmonics/spurious must be at least 20 dB down from the highest emission level within the authorized band.

3.4.2 Measuring Instruments

See list of measuring equipment of this test report.

3.4.3 Test Procedure

1. The testing follows FCC KDB Publication No. 558074 D01 DTS Meas. Guidance v05
2. The RF output of EUT was connected to the spectrum analyzer by RF cable and attenuator. The path loss was compensated to the results for each measurement.
3. Set to the maximum power setting and enable the EUT transmit continuously.
4. Set RBW = 100 kHz, VBW=300 kHz, Peak Detector. Unwanted Emissions measured in any 100 kHz bandwidth outside of the authorized frequency band shall be attenuated by at least 20 dB relative to the maximum in-band peak PSD level in 100 kHz when maximum peak conducted output power procedure is used. If the transmitter complies with the conducted power limits based on the use of RMS averaging over a time interval, the attenuation required under this paragraph shall be 30 dB instead of 20 dB.
5. Measure and record the results in the test report.
6. The RF fundamental frequency should be excluded against the limit line in the operating frequency band.

3.4.4 Test Setup

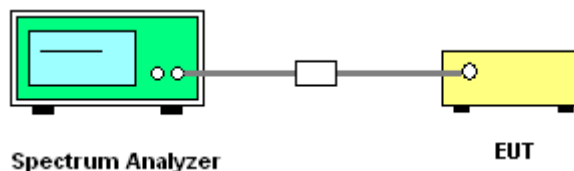



3.4.5 Test Result of Conducted Band Edges Plots

<1 Mbps>

Low Band Edge Plot on Channel 00

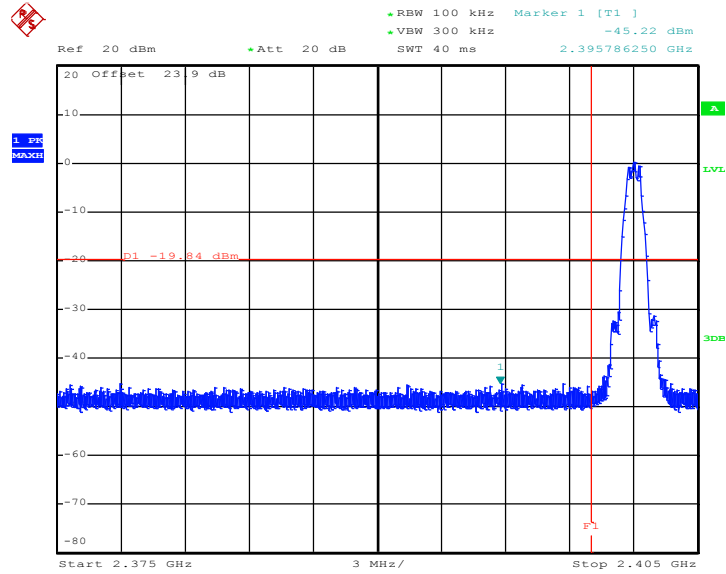

Date: 21.SEP.2018 18:31:08

High Band Edge Plot on Channel 39

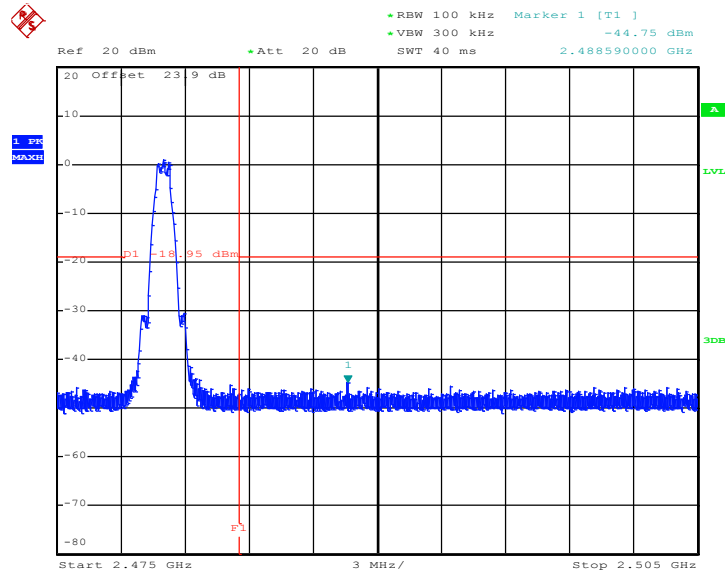

Date: 21.SEP.2018 18:38:13



<2 Mbps>

Low Band Edge Plot on Channel 00

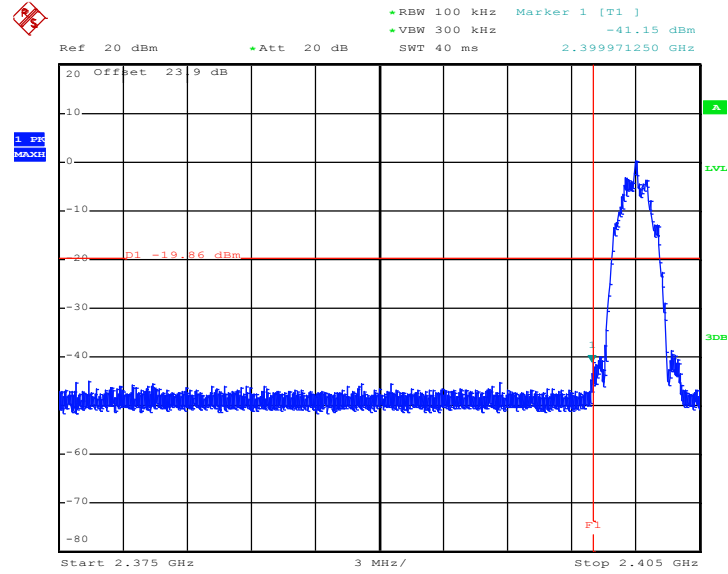

Date: 21.SEP.2018 18:41:32

High Band Edge Plot on Channel 39

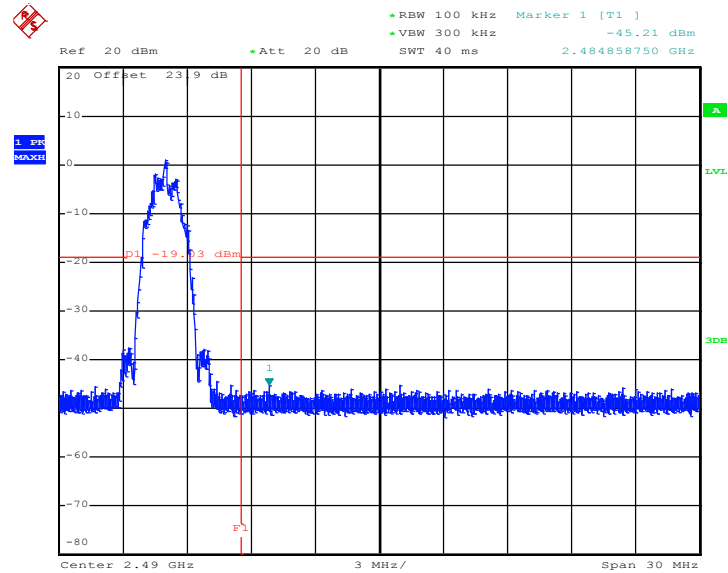

Date: 21.SEP.2018 18:48:00



3.4.6 Test Result of Conducted Spurious Emission Plots

<1 Mbps>

Conducted Spurious Emission Plot on Bluetooth LE 1Mbps

GFSK Channel 00

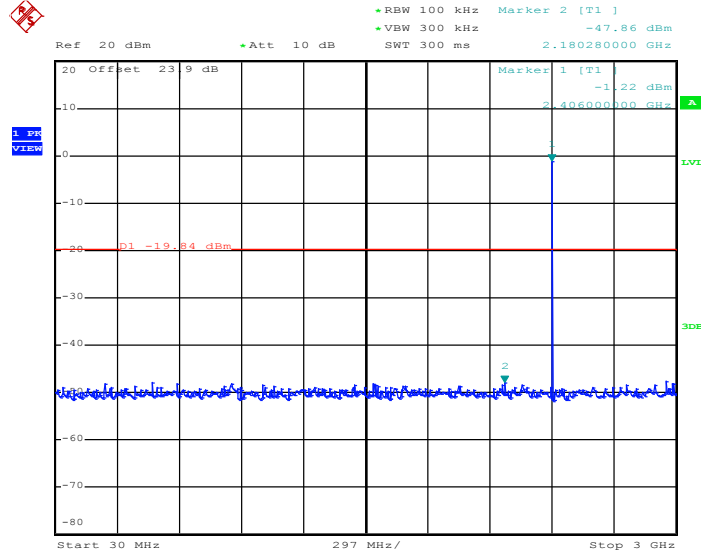

Date: 21.SEP.2018 18:31:26

Conducted Spurious Emission Plot on Bluetooth LE 1Mbps

GFSK Channel 00

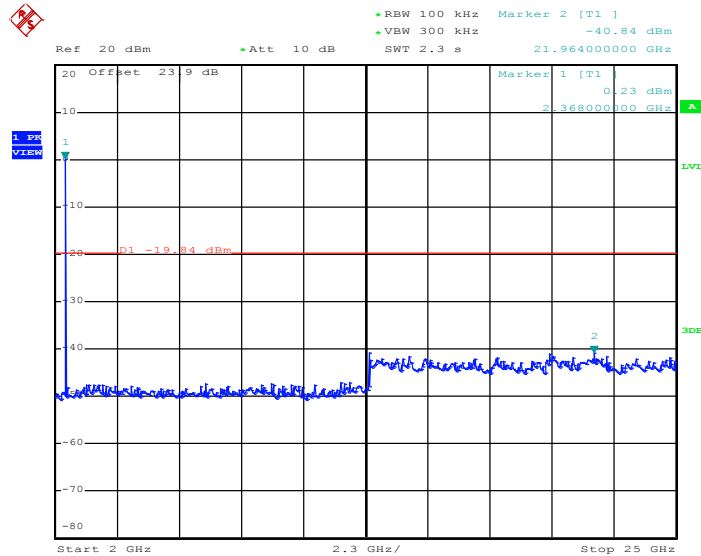

Date: 21.SEP.2018 18:31:42



Conducted Spurious Emission Plot on Bluetooth LE 1Mbps GFSK Channel 19

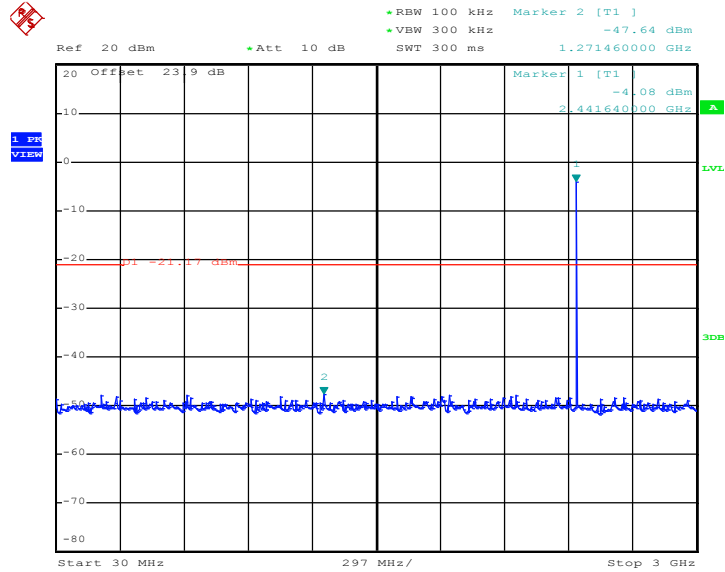

Date: 21.SEP.2018 18:34:13

Conducted Spurious Emission Plot on Bluetooth LE 1Mbps GFSK Channel 19

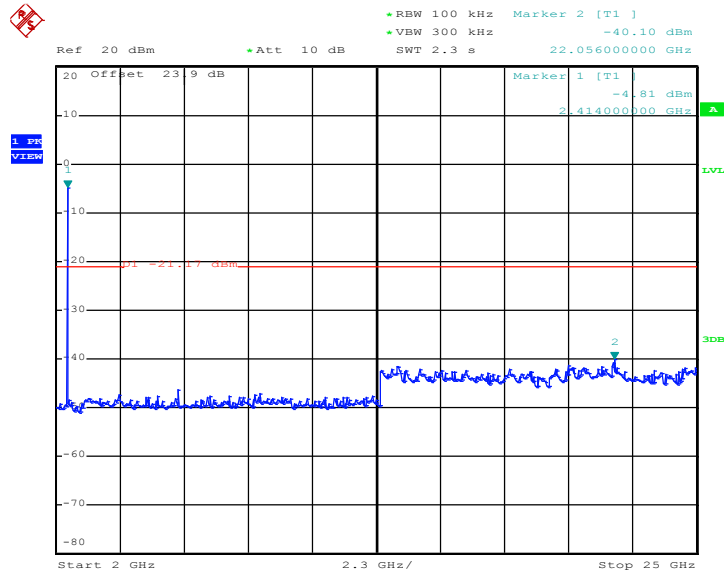

Date: 21.SEP.2018 18:34:40



Conducted Spurious Emission Plot on Bluetooth LE 1Mbps GFSK Channel 39

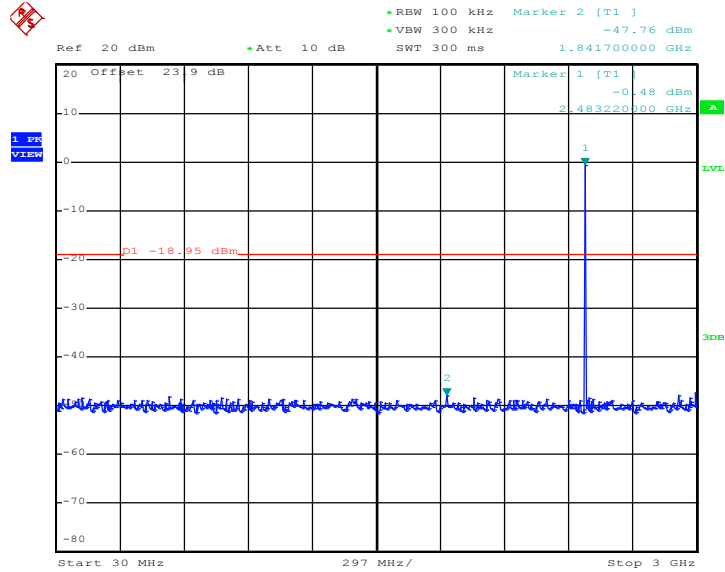

Date: 21.SEP.2018 18:38:33

Conducted Spurious Emission Plot on Bluetooth LE 1Mbps GFSK Channel 39

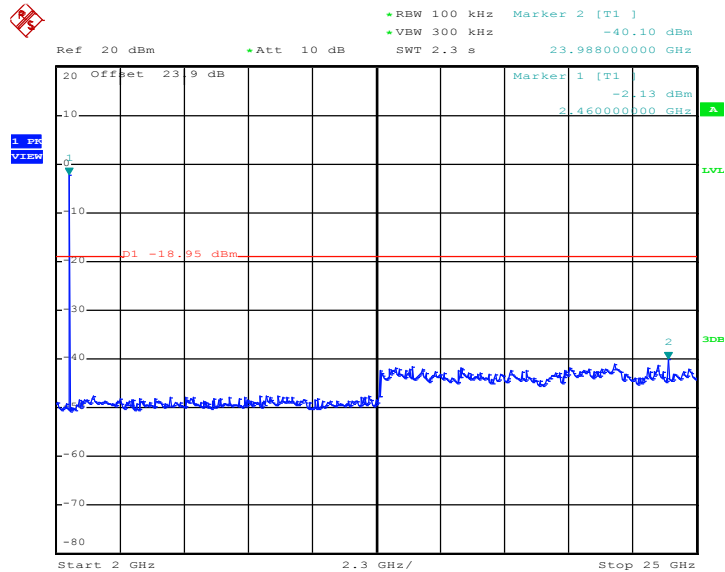

Date: 21.SEP.2018 18:38:48



<2 Mbps>

Conducted Spurious Emission Plot on Bluetooth LE 2Mbps
GFSK Channel 00

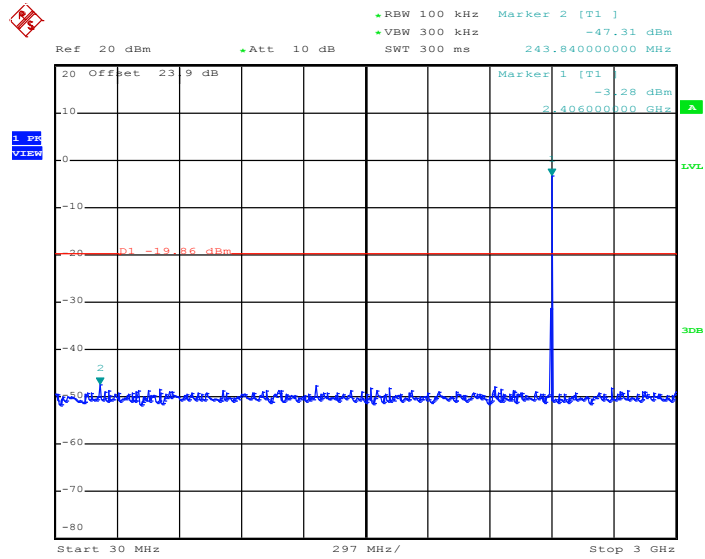

Date: 21.SEP.2018 18:41:59

Conducted Spurious Emission Plot on Bluetooth LE 2Mbps
GFSK Channel 00

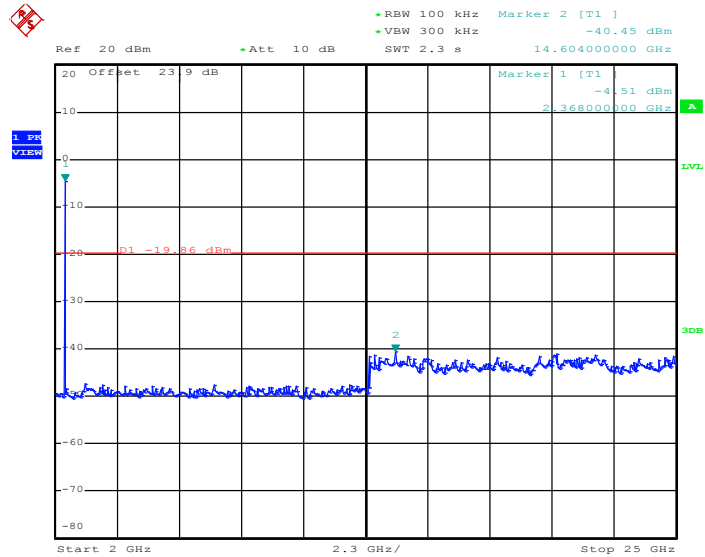

Date: 21.SEP.2018 18:42:15



Conducted Spurious Emission Plot on Bluetooth LE 2Mbps GFSK Channel 19

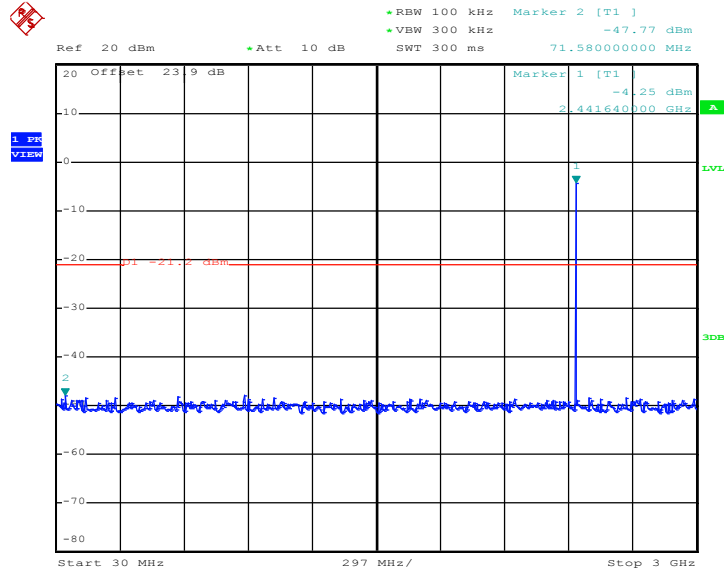

Date: 21.SEP.2018 18:45:05

Conducted Spurious Emission Plot on Bluetooth LE 2Mbps GFSK Channel 19

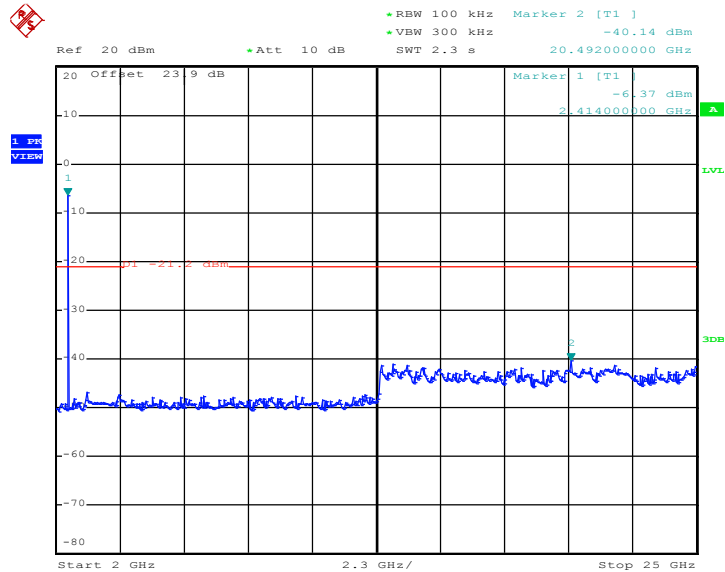

Date: 21.SEP.2018 18:45:20



Conducted Spurious Emission Plot on Bluetooth LE 2Mbps GFSK Channel 39

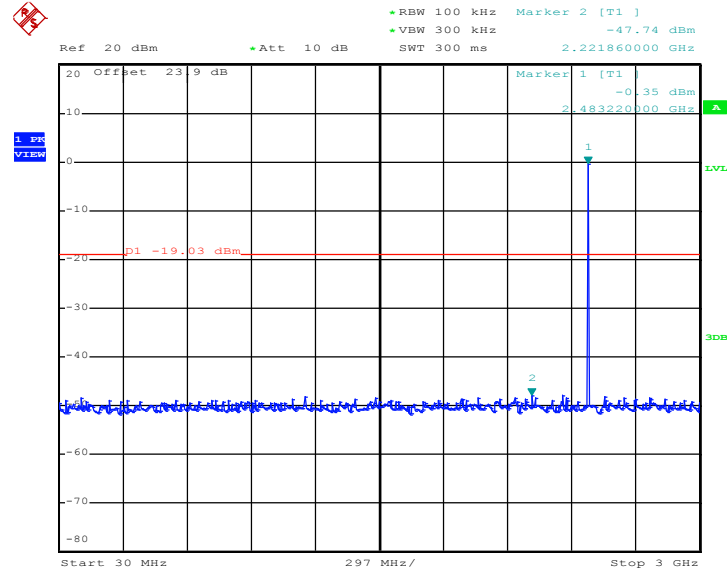

Date: 21.SEP.2018 18:48:17

Conducted Spurious Emission Plot on Bluetooth LE 2Mbps GFSK Channel 39

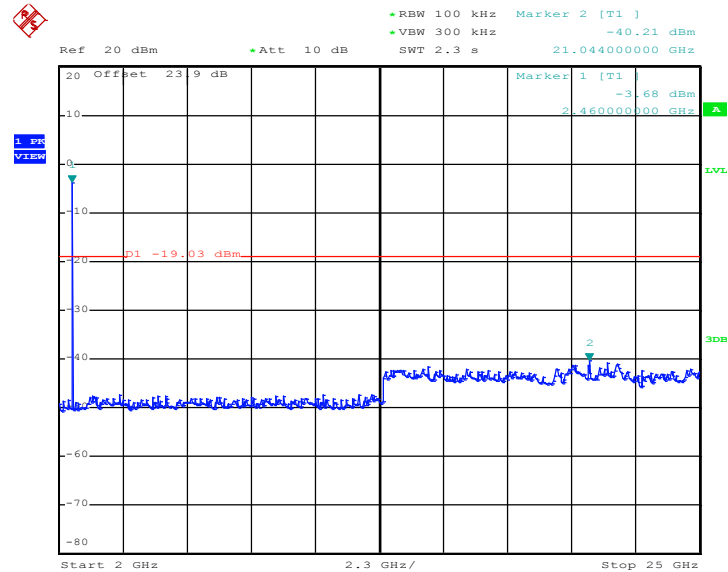

Date: 21.SEP.2018 18:48:33



3.5 Radiated Band Edges and Spurious Emission Measurement

3.5.1 Limit of Radiated Band Edges and Spurious Emission

In any 100 kHz bandwidth outside the intentional radiator frequency band, all harmonics/spurious must be at least 20 dB below the highest emission level within the authorized band. If the output power of this device was measured by spectrum analyzer, the attenuation under this paragraph shall be 30 dB instead of 20 dB. In addition, radiated emissions which fall in the restricted bands must also comply with the limits as below.

| Frequency (MHz) | Field Strength (microvolts/meter) | Measurement Distance (meters) |
|-----------------|-----------------------------------|-------------------------------|
| 0.009 – 0.490 | 2400/F(kHz) | 300 |
| 0.490 – 1.705 | 24000/F(kHz) | 30 |
| 1.705 – 30.0 | 30 | 30 |
| 30 – 88 | 100 | 3 |
| 88 – 216 | 150 | 3 |
| 216 - 960 | 200 | 3 |
| Above 960 | 500 | 3 |

3.5.2 Measuring Instruments

See list of measuring equipment of this test report.

**3.5.3 Test Procedures**

1. The testing follows FCC KDB Publication No. 558074 D01 DTS Meas. Guidance v05
2. The EUT was arranged to its worst case and then tune the antenna tower (from 1 m to 4 m) and turntable (from 0 degree to 360 degrees) to find the maximum reading. A pre-amp and a high pass filter are used for the test in order to get better signal level.
3. The EUT was placed on a turntable with 0.8 meter for frequency below 1GHz and 1.5 meter for frequency above 1GHz respectively above ground.
4. The EUT was set 3 meters from the interference receiving antenna, which was mounted on the top of a variable height antenna tower.
5. Corrected Reading: Antenna Factor + Cable Loss + Read Level - Preamp Factor = Level
6. For testing below 1GHz, if the emission level of the EUT in peak mode was 3 dB lower than the limit specified, then peak values of EUT will be reported, otherwise, the emissions will be repeated one by one using the CISPR quasi-peak method and reported.
7. For testing above 1GHz, the emission level of the EUT in peak mode was 20dB lower than average limit (that means the emission level in average mode also complies with the limit in average mode), then peak values of EUT will be reported, otherwise, the emissions will be measured in average mode again and reported.
8. Use the following spectrum analyzer settings:
 - (1) Span shall wide enough to fully capture the emission being measured;
 - (2) Set RBW=100 kHz for $f < 1$ GHz; $VBW \geq RBW$; Sweep = auto; Detector function = peak; Trace = max hold;
 - (3) Set RBW = 1 MHz, VBW= 3MHz for $f \geq 1$ GHz for peak measurement.
For average measurement:
 - $VBW = 10$ Hz, when duty cycle is no less than 98 percent.
 - $VBW \geq 1/T$, when duty cycle is less than 98 percent where T is the minimum transmission duration over which the transmitter is on and is transmitting at its maximum power control level for the tested mode of operation.

3.5.4 Test Setup

For radiated emissions below 30MHz

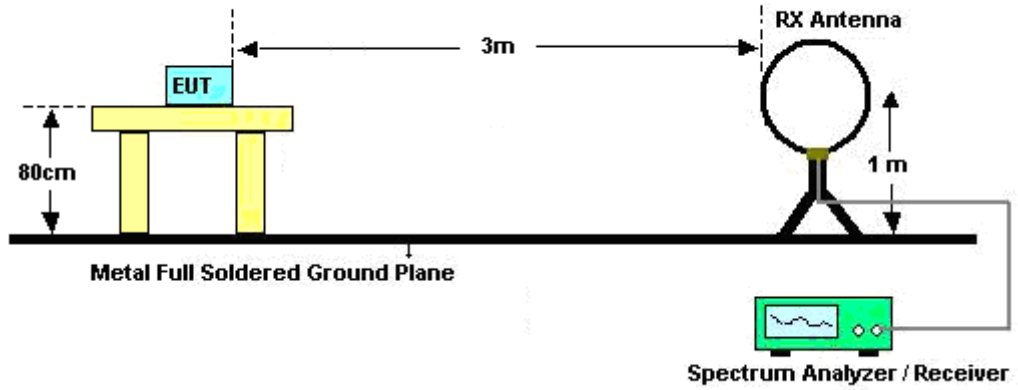

For radiated emissions from 30MHz to 1GHz

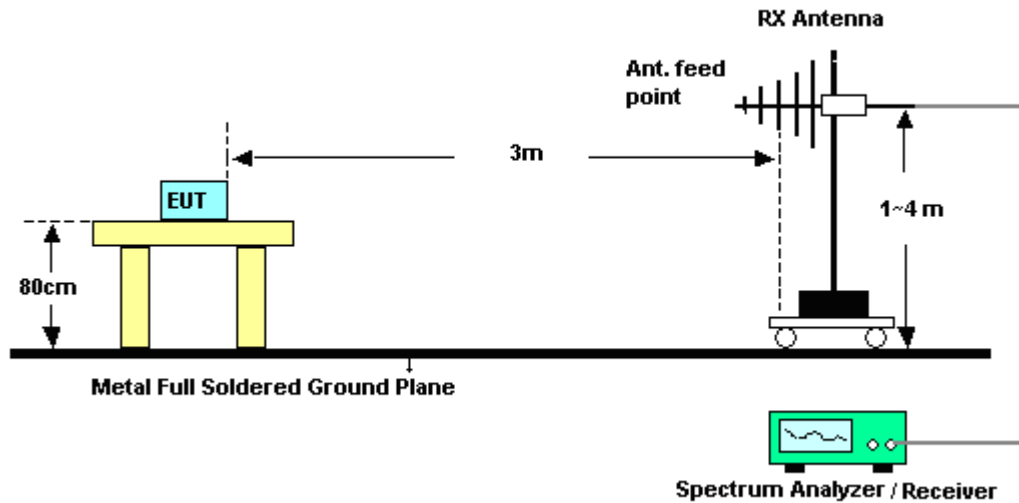

For radiated emissions above 1GHz

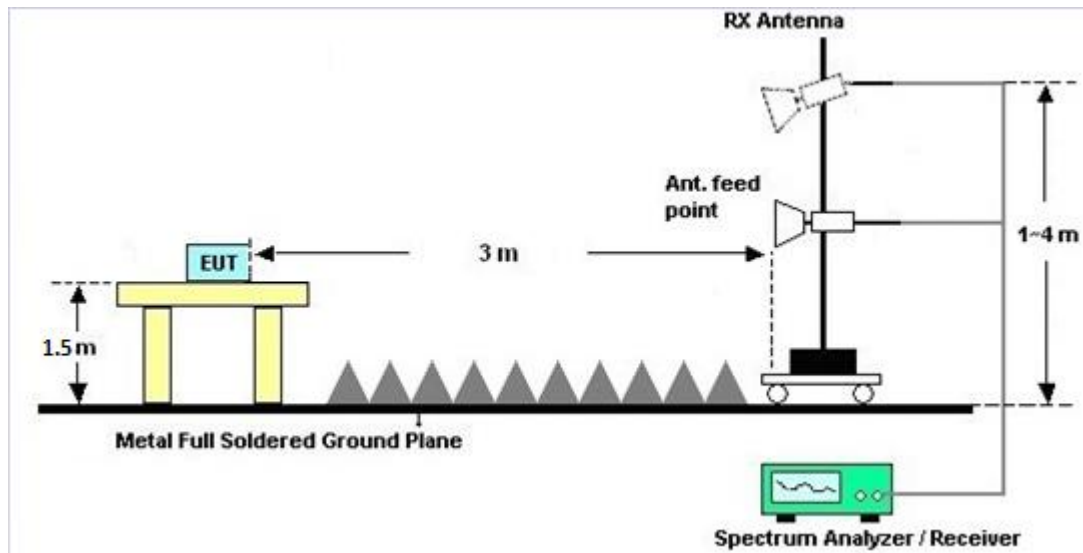

3.5.5 Test Results of Radiated Spurious Emissions (9 kHz ~ 30 MHz)

The low frequency, which started from 9 kHz to 30MHz, was pre-scanned and the result which was 20dB lower than the limit line was not reported.

There is a comparison data of both open-field test site and alternative test site - semi-Anechoic chamber according to 414788 D01 Radiated Test Site v01r01, and the result came out very similar.

3.5.6 Test Result of Radiated Spurious at Band Edges

Please refer to Appendix C and D.

3.5.7 Duty Cycle

Please refer to Appendix E.

3.5.8 Test Result of Radiated Spurious Emission (30MHz ~ 10th Harmonic)

Please refer to Appendix C and D.



3.6 AC Conducted Emission Measurement

3.6.1 Limit of AC Conducted Emission

For equipment that is designed to be connected to the public utility (AC) power line, the radio frequency voltage that is conducted back onto the AC power line on any frequency or frequencies within the band 150 kHz to 30 MHz shall not exceed the limits in the following table.

| Frequency of emission (MHz) | Conducted limit (dB μ V) | |
|-----------------------------|------------------------------|-----------|
| | Quasi-peak | Average |
| 0.15-0.5 | 66 to 56* | 56 to 46* |
| 0.5-5 | 56 | 46 |
| 5-30 | 60 | 50 |

*Decreases with the logarithm of the frequency.

3.6.2 Measuring Instruments

See list of measuring equipment of this test report.

3.6.3 Test Procedures

1. The EUT was placed 0.4 meter from the conducting wall of the shielding room was kept at least 80 centimeters from any other grounded conducting surface.
2. Connect EUT to the power mains through a line impedance stabilization network (LISN).
3. All the support units are connecting to the other LISN.
4. The LISN provides 50 ohm coupling impedance for the measuring instrument.
5. The FCC states that a 50 ohm, 50 microhenry LISN should be used.
6. Both sides of AC line were checked for maximum conducted interference.
7. The frequency range from 150 kHz to 30 MHz was searched.
8. Set the test-receiver system to Peak Detect Function and specified bandwidth (IF Bandwidth = 9kHz) with Maximum Hold Mode. Then measurement is also conducted by Average Detector and Quasi-Peak Detector Function respectively.

3.6.4 Test Setup

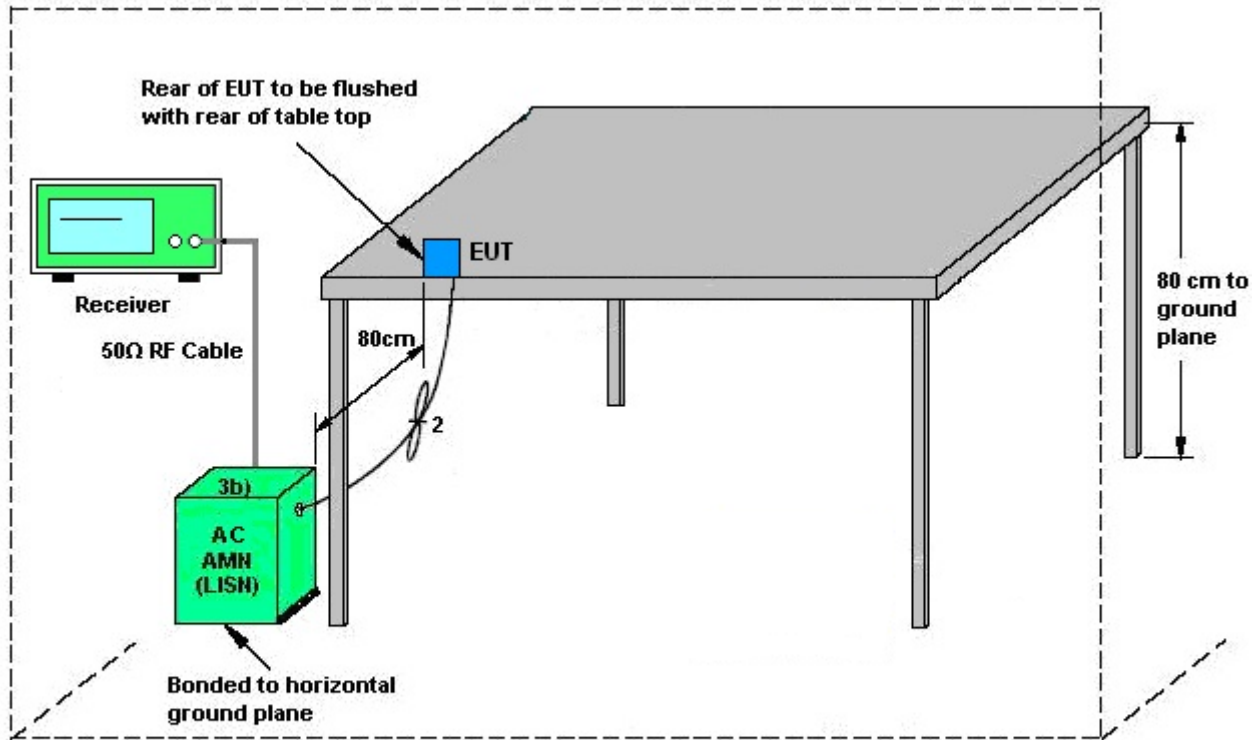

AMN = Artificial mains network (LISH)
 AE = Associated equipment
 EUT = Equipment under test
 ISN = Impedance stabilization network

3.6.5 Test Result of AC Conducted Emission

Please refer to Appendix B.



3.7 Antenna Requirements

3.7.1 Standard Applicable

If directional gain of transmitting antennas is greater than 6dBi, the power shall be reduced by the same level in dB comparing to gain minus 6dBi. The use of a permanently attached antenna or of an antenna that uses a unique coupling to the intentional radiator shall be considered sufficient to comply with the rule.

3.7.2 Antenna Anti-Replacement Construction

An embedded-in antenna design is used.

3.7.3 Antenna Gain

The antenna peak gain of EUT is less than 6 dBi. Therefore, it is not necessary to reduce maximum peak output power limit.



4 List of Measuring Equipment

| Instrument | Manufacturer | Model No. | Serial No. | Characteristics | Calibration Date | Test Date | Due Date | Remark |
|-----------------------|-------------------|-------------------------|--------------------|-------------------------------------|------------------|---------------------------------|---------------|--------------------------|
| Hygrometer | Testo | DTM-303A | TP157075 | N/A | Mar. 06, 2018 | Sep. 14, 2018~ Sep. 21, 2018 | Mar. 05, 2019 | Conducted (TH05-HY) |
| Power Meter | Agilent | E4416A | GB412923 44 | N/A | Dec. 20, 2017 | Sep. 14, 2018~ Sep. 21, 2018 | Dec. 19, 2018 | Conducted (TH05-HY) |
| Power Sensor | Agilent | E9327A | US404415 48 | 50MHz~18GHz | Dec. 20, 2017 | Sep. 14, 2018~ Sep. 21, 2018 | Dec. 19, 2018 | Conducted (TH05-HY) |
| Spectrum Analyzer | Rohde & Schwarz | FSP40 | 100057 | 9kHz-40GHz | Nov. 21, 2017 | Sep. 14, 2018~ Sep. 21, 2018 | Nov. 20, 2018 | Conducted (TH05-HY) |
| Spectrum Analyzer | Rohde & Schwarz | FSV30 | 103738-kt | 9kHz-30GHz | May. 22, 2018 | Sep. 14, 2018~ Sep. 21, 2018 | May. 21, 2019 | Conducted (TH05-HY) |
| Switch Box & RF Cable | Burgeon | ETF-058 | EC130048 4 | N/A | Mar. 01, 2018 | Sep. 14, 2018~ Sep. 21, 2018 | Feb. 28, 2019 | Conducted (TH05-HY) |
| AC Power Source | ChainTek | APC-1000W | N/A | N/A | N/A | Nov. 20, 2018 | N/A | Conduction (CO05-HY) |
| EMI Test Receiver | Rohde & Schwarz | ESR3 | 102388 | 9KHz~3.6GHz | Dec. 08, 2017 | Nov. 20, 2018 | Dec. 07, 2018 | Conduction (CO05-HY) |
| Hygrometer | Testo | 608-H1 | 34913912 | N/A | Mar. 06, 2018 | Nov. 20, 2018 | Mar. 05, 2019 | Conduction (CO05-HY) |
| LISN | Rohde & Schwarz | ENV216 | 100080 | 9kHz~30MHz | Nov. 30, 2017 | Nov. 20, 2018 | Nov. 29, 2018 | Conduction (CO05-HY) |
| Software | Rohde & Schwarz | EMC32 V10.30 | N/A | N/A | N/A | Nov. 20, 2018 | N/A | Conduction (CO05-HY) |
| LF Cable | HUBER + SUHNER | RG-214/U | LF01 | N/A | Jan. 03, 2018 | Nov. 20, 2018 | Jan. 02, 2019 | Conduction (CO05-HY) |
| Pulse Limiter | Rohde & Schwarz | ESH3-Z2 | 100851 | N/A | Jan. 03, 2018 | Nov. 20, 2018 | Jan. 02, 2019 | Conduction (CO05-HY) |
| Amplifier | MITEQ | TTA1840-35- HG | 1871923 | 18GHz~40GHz, VSWR : 2.5:1 max | Jul. 16, 2018 | Nov. 22, 2018~ Nov. 24, 2018 | Jul. 15, 2019 | Radiation (03CH11-HY) |
| Amplifier | SONOMA | 310N | 187312 | 9kHz~1GHz | Jan. 16, 2018 | Nov. 22, 2018~ Nov. 24, 2018 | Jan. 15, 2019 | Radiation (03CH11-HY) |
| Bilog Antenna | TESEQ | CBL 6111D&N-6- 06 | 35414&AT- N0602 | 30MHz~1GHz | Oct. 13, 2018 | Nov. 22, 2018~ Nov. 24, 2018 | Oct. 12, 2019 | Radiation (03CH11-HY) |
| Horn Antenna | SCHWARZBE CK | BBHA 9120 D | 9120D-132 6 | 1GHz ~ 18GHz | Oct. 30, 2018 | Nov. 22, 2018~ Nov. 24, 2018 | Oct. 29, 2019 | Radiation (03CH11-HY) |
| Hygrometer | TECPEL | DTN-303B | TP140325 | N/A | Nov. 05, 2018 | Nov. 22, 2018~ Nov. 24, 2018 | Nov 04, 2019 | Radiation (03CH11-HY) |
| Loop Antenna | Rohde & Schwarz | HFH2-Z2 | 100488 | 9 kHz~30 MHz | Nov. 22, 2018 | Nov. 22, 2018~ Nov. 24, 2018 | Nov. 21, 2019 | Radiation (03CH11-HY) |
| Preamplifier | Keysight | 83017A | MY532700 80 | 1GHz~26.5GHz | Nov. 14, 2018 | Nov. 22, 2018~ Nov. 24, 2018 | Nov. 13, 2020 | Radiation (03CH11-HY) |
| Spectrum Analyzer | Keysight | N9010A | MY542004 86 | 10Hz ~ 44GHz | Oct. 19, 2018 | Nov. 22, 2018~ Nov. 24, 2018 | Oct. 18, 2019 | Radiation (03CH11-HY) |



| Instrument | Manufacturer | Model No. | Serial No. | Characteristics | Calibration Date | Test Date | Due Date | Remark |
|-------------------------|-------------------|-------------------------------------|----------------------|-------------------------------|------------------|---------------------------------|---------------|--------------------------|
| Controller | EMEC | EM 1000 | N/A | Control Turn table & Ant Mast | N/A | Nov. 22, 2018~ Nov. 24, 2018 | N/A | Radiation (03CH11-HY) |
| Antenna Mast | EMEC | AM-BS-4500 -B | N/A | 1~4m | N/A | Nov. 22, 2018~ Nov. 24, 2018 | N/A | Radiation (03CH11-HY) |
| Turn Table | EMEC | TT 2000 | N/A | 0~360 Degree | N/A | Nov. 22, 2018~ Nov. 24, 2018 | N/A | Radiation (03CH11-HY) |
| Preamplifier | Jet-Power | JPA0118-55- 303K | 17100018 00054001 | 1GHz~18GHz | Apr. 16, 2018 | Nov. 22, 2018~ Nov. 24, 2018 | Apr. 15, 2019 | Radiation (03CH11-HY) |
| SHF-EHF Horn Antenna | SCHWARZBE CK | BBHA 9170 | BBHA9170 584 | 18GHz- 40GHz | Nov. 27, 2017 | Nov. 22, 2018~ Nov. 24, 2018 | Nov. 26, 2018 | Radiation (03CH11-HY) |
| Software | Audix | E3 6.2009-8-24 | RK-00104 2 | N/A | N/A | Nov. 22, 2018~ Nov. 24, 2018 | N/A | Radiation (03CH11-HY) |
| RF Cable | HUBER + SUHNER | SUCOFLEX 104 | MY9837/4 PE | 9kHz-30MHz | Mar. 14, 2018 | Nov. 22, 2018~ Nov. 24, 2018 | Mar. 13, 2019 | Radiation (03CH11-HY) |
| RF Cable | HUBER + SUHNER | SUCOFLEX 102 | MY2859/2 | 30MHz-40GHz | Mar. 14, 2018 | Nov. 22, 2018~ Nov. 24, 2018 | Mar. 13, 2019 | Radiation (03CH11-HY) |
| RF Cable | HUBER + SUHNER | SUCOFLEX 104 | MY9837/4 PE | 30M-18G | Mar. 14, 2018 | Nov. 22, 2018~ Nov. 24, 2018 | Mar. 13, 2019 | Radiation (03CH11-HY) |
| RF Cable | HUBER + SUHNER | SUCOFLEX 102 | MY4274/2 | 30MHz-40GHz | Mar. 14, 2018 | Nov. 22, 2018~ Nov. 24, 2018 | Mar. 13, 2019 | Radiation (03CH11-HY) |
| Filter | Wainwright | WLK4-1000- 1530-8000-4 0SS | SN11 | 1G Low Pass | Sep. 16, 2018 | Nov. 22, 2018~ Nov. 24, 2018 | Sep. 15, 2019 | Radiation (03CH11-HY) |
| Filter | Wainwright | WHKX12-27 00-3000-180 00-60SS | SN3 | 2.7G High Pass | Sep. 16, 2018 | Nov. 22, 2018~ Nov. 24, 2018 | Sep. 15, 2019 | Radiation (03CH11-HY) |



5 Uncertainty of Evaluation

Uncertainty of Conducted Emission Measurement (150 kHz ~ 30 MHz)

| | |
|---|------|
| Measuring Uncertainty for a Level of Confidence of 95% ($U = 2Uc(y)$) | 2.20 |
|---|------|

Uncertainty of Radiated Emission Measurement (30 MHz ~ 1000 MHz)

| | |
|---|------|
| Measuring Uncertainty for a Level of Confidence of 95% ($U = 2Uc(y)$) | 5.20 |
|---|------|

Uncertainty of Radiated Emission Measurement (1000 MHz ~ 18000 MHz)

| | |
|---|------|
| Measuring Uncertainty for a Level of Confidence of 95% ($U = 2Uc(y)$) | 5.50 |
|---|------|

Uncertainty of Radiated Emission Measurement (18000 MHz ~ 40000 MHz)

| | |
|---|------|
| Measuring Uncertainty for a Level of Confidence of 95% ($U = 2Uc(y)$) | 5.20 |
|---|------|

Appendix A. Test Result of Conducted Test Items

<For 1Mbps>

| | | | | |
|----------------|-------------------------|--------------------|-------|----|
| Test Engineer: | Shiang Wang / Allen Lin | Temperature: | 21~25 | °C |
| Test Date: | 2018/9/14~2018/9/21 | Relative Humidity: | 51~54 | % |

TEST RESULTS DATA
6dB and 99% Occupied Bandwidth

| Mod. | Data Rate | NTX | CH. | Freq. (MHz) | 99% Occupied BW (MHz) | 6dB BW (MHz) | 6dB BW Limit (MHz) | Pass/Fail |
|------|-----------|-----|-----|-------------|-----------------------|--------------|--------------------|-----------|
| BLE | 1Mbps | 1 | 0 | 2402 | 1.028 | 0.662 | 0.50 | Pass |
| BLE | 1Mbps | 1 | 19 | 2440 | 1.028 | 0.672 | 0.50 | Pass |
| BLE | 1Mbps | 1 | 39 | 2480 | 1.030 | 0.664 | 0.50 | Pass |

TEST RESULTS DATA
Peak Power Table

| Mod. | Data Rate | NTX | CH. | Freq. (MHz) | Peak Conducted Power (dBm) | Conducted Power Limit (dBm) | DG (dBi) | EIRP Power (dBm) | EIRP Power Limit (dBm) | Pass /Fail |
|------|-----------|-----|-----|-------------|----------------------------|-----------------------------|----------|------------------|------------------------|------------|
| BLE | 1Mbps | 1 | 0 | 2402 | 1.16 | 30.00 | -3.20 | -2.04 | 36.00 | Pass |
| BLE | 1Mbps | 1 | 19 | 2440 | 0.12 | 30.00 | -3.20 | -3.08 | 36.00 | Pass |
| BLE | 1Mbps | 1 | 39 | 2480 | 2.15 | 30.00 | -3.20 | -1.05 | 36.00 | Pass |

TEST RESULTS DATA
Average Power Table
(Reporting Only)

| Mod. | Data Rate | NTX | CH. | Freq. (MHz) | Duty Factor (dB) | Average Conducted Power (dBm) |
|------|-----------|-----|-----|-------------|------------------|-------------------------------|
| BLE | 1Mbps | 1 | 0 | 2402 | 2.04 | 0.58 |
| BLE | 1Mbps | 1 | 19 | 2440 | 2.04 | -0.61 |
| BLE | 1Mbps | 1 | 39 | 2480 | 2.04 | 1.61 |

TEST RESULTS DATA
Peak Power Density

| Mod. | Data Rate | NTX | CH. | Freq. (MHz) | Peak PSD (dBm /100kHz) | Peak PSD (dBm /3kHz) | DG (dBi) | Peak PSD Limit (dBm /3kHz) | Pass/Fail |
|------|-----------|-----|-----|-------------|------------------------|----------------------|----------|----------------------------|-----------|
| BLE | 1Mbps | 1 | 0 | 2402 | 0.16 | -14.67 | -3.20 | 8.00 | Pass |
| BLE | 1Mbps | 1 | 19 | 2440 | -1.17 | -15.86 | -3.20 | 8.00 | Pass |
| BLE | 1Mbps | 1 | 39 | 2480 | 1.05 | -13.75 | -3.20 | 8.00 | Pass |

Note: PSD (dBm/ 100kHz) is a reference level used for Conducted Band Edges and Conducted Spurious Emission 20dBc limit.

<For 2Mbps>

| | | | | |
|----------------|-------------------------|--------------------|-------|----|
| Test Engineer: | Shiang Wang / Allen Lin | Temperature: | 21~25 | °C |
| Test Date: | 2018/9/14~2018/9/21 | Relative Humidity: | 51~54 | % |

TEST RESULTS DATA
6dB and 99% Occupied Bandwidth

| Mod. | Data Rate | NTX | CH. | Freq. (MHz) | 99% Occupied BW (MHz) | 6dB BW (MHz) | 6dB BW Limit (MHz) | Pass/Fail |
|--------|-----------|-----|-----|-------------|-----------------------|--------------|--------------------|-----------|
| BLE5.0 | 2Mbps | 1 | 0 | 2402 | 2.040 | 1.128 | 0.50 | Pass |
| BLE5.0 | 2Mbps | 1 | 19 | 2440 | 2.044 | 1.144 | 0.50 | Pass |
| BLE5.0 | 2Mbps | 1 | 39 | 2480 | 2.044 | 1.144 | 0.50 | Pass |

TEST RESULTS DATA
Peak Power Table

| Mod. | Data Rate | NTX | CH. | Freq. (MHz) | Peak Conducted Power (dBm) | Conducted Power Limit (dBm) | DG (dBi) | EIRP Power (dBm) | EIRP Power Limit (dBm) | Pass /Fail |
|--------|-----------|-----|-----|-------------|----------------------------|-----------------------------|----------|------------------|------------------------|------------|
| BLE5.0 | 2Mbps | 1 | 0 | 2402 | 1.46 | 30.00 | -3.20 | -1.74 | 36.00 | Pass |
| BLE5.0 | 2Mbps | 1 | 19 | 2440 | 0.38 | 30.00 | -3.20 | -2.82 | 36.00 | Pass |
| BLE5.0 | 2Mbps | 1 | 39 | 2480 | 2.33 | 30.00 | -3.20 | -0.87 | 36.00 | Pass |

TEST RESULTS DATA
Average Power Table
(Reporting Only)

| Mod. | Data Rate | NTX | CH. | Freq. (MHz) | Duty Factor (dB) | Average Conducted Power (dBm) |
|--------|-----------|-----|-----|-------------|------------------|-------------------------------|
| BLE5.0 | 2Mbps | 1 | 0 | 2402 | 4.83 | 0.66 |
| BLE5.0 | 2Mbps | 1 | 19 | 2440 | 4.83 | -0.57 |
| BLE5.0 | 2Mbps | 1 | 39 | 2480 | 4.83 | 1.65 |

TEST RESULTS DATA
Peak Power Density

| Mod. | Data Rate | NTX | CH. | Freq. (MHz) | Peak PSD (dBm /100kHz) | Peak PSD (dBm /3kHz) | DG (dBi) | Peak PSD Limit (dBm /3kHz) | Pass/Fail |
|--------|-----------|-----|-----|-------------|------------------------|----------------------|----------|----------------------------|-----------|
| BLE5.0 | 2Mbps | 1 | 0 | 2402 | 0.14 | -18.19 | -3.20 | 8.00 | Pass |
| BLE5.0 | 2Mbps | 1 | 19 | 2440 | -1.20 | -19.39 | -3.20 | 8.00 | Pass |
| BLE5.0 | 2Mbps | 1 | 39 | 2480 | 0.97 | -17.31 | -3.20 | 8.00 | Pass |

Note: PSD (dBm/ 100kHz) is a reference level used for Conducted Band Edges and Conducted Spurious Emission 20dBc limit.



Appendix B. AC Conducted Emission Test Results

| | | | |
|-----------------|-------------|---------------------|---------|
| Test Engineer : | Jimmy Chang | Temperature : | 22~23°C |
| | | Relative Humidity : | 58~60% |

EUT Information

Report NO : 882923-01
 Test Mode : Mode 1
 Test Voltage : 120Vac/60Hz
 Phase : Line

Full Spectrum

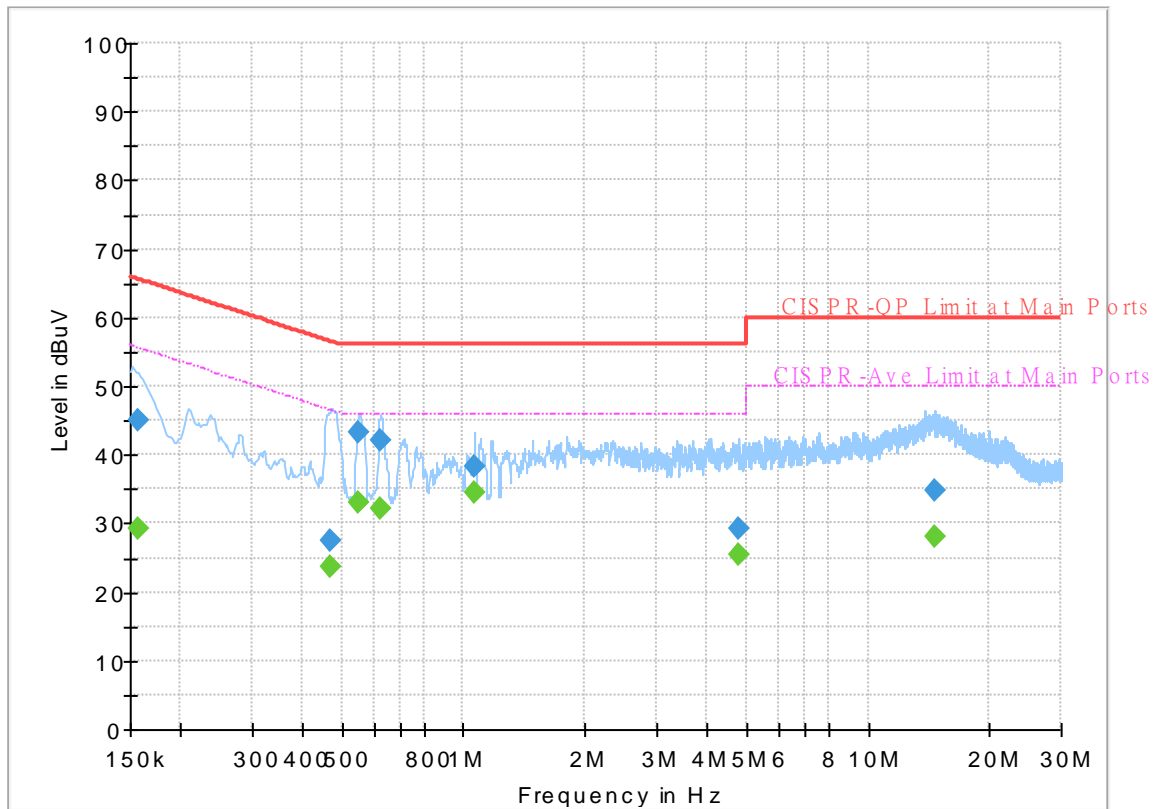

Final_Result

| Frequency (MHz) | QuasiPeak (dBuV) | CAverage (dBuV) | Limit (dBuV) | Margin (dB) | Line | Filter | Corr. (dB) |
|-----------------|------------------|-----------------|--------------|-------------|------|--------|------------|
| 0.156750 | --- | 29.33 | 55.63 | 26.30 | L1 | OFF | 19.5 |
| 0.156750 | 45.14 | --- | 65.63 | 20.49 | L1 | OFF | 19.5 |
| 0.469500 | --- | 23.78 | 46.52 | 22.74 | L1 | OFF | 19.5 |
| 0.469500 | 27.50 | --- | 56.52 | 29.02 | L1 | OFF | 19.5 |
| 0.552750 | --- | 32.94 | 46.00 | 13.06 | L1 | OFF | 19.5 |
| 0.552750 | 43.31 | --- | 56.00 | 12.69 | L1 | OFF | 19.5 |
| 0.622500 | --- | 32.18 | 46.00 | 13.82 | L1 | OFF | 19.6 |
| 0.622500 | 42.24 | --- | 56.00 | 13.76 | L1 | OFF | 19.6 |
| 1.065750 | --- | 34.44 | 46.00 | 11.56 | L1 | OFF | 19.6 |
| 1.065750 | 38.21 | --- | 56.00 | 17.79 | L1 | OFF | 19.6 |
| 4.814250 | --- | 25.48 | 46.00 | 20.52 | L1 | OFF | 19.7 |
| 4.814250 | 29.13 | --- | 56.00 | 26.87 | L1 | OFF | 19.7 |
| 14.624250 | --- | 27.94 | 50.00 | 22.06 | L1 | OFF | 20.1 |
| 14.624250 | 34.87 | --- | 60.00 | 25.13 | L1 | OFF | 20.1 |

EUT Information

Report NO : 882923-01
 Test Mode : Mode 1
 Test Voltage : 120Vac/60Hz
 Phase : Neutral

Full Spectrum

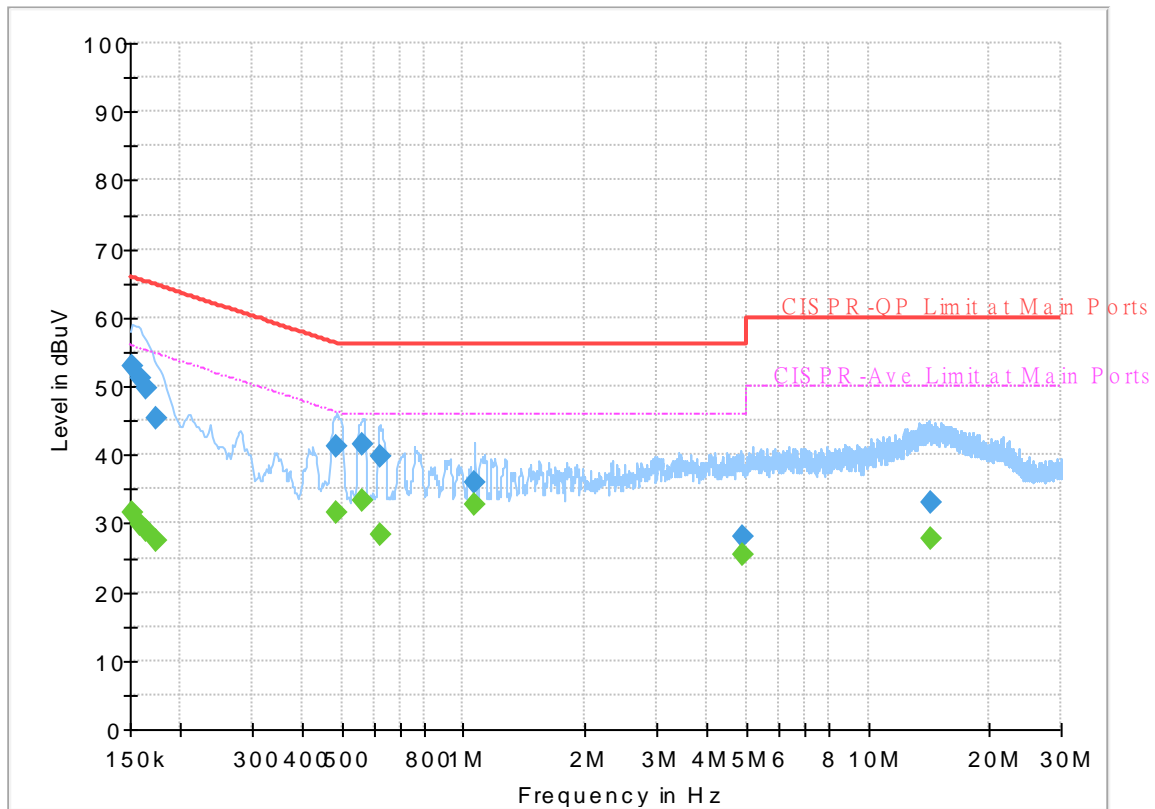

Final_Result

| Frequency (MHz) | QuasiPeak (dBuV) | CAverage (dBuV) | Limit (dBuV) | Margin (dB) | Line | Filter | Corr. (dB) |
|-----------------|------------------|-----------------|--------------|-------------|------|--------|------------|
| 0.152250 | --- | 31.68 | 55.88 | 24.20 | N | OFF | 19.5 |
| 0.152250 | 52.81 | --- | 65.88 | 13.07 | N | OFF | 19.5 |
| 0.159000 | --- | 29.87 | 55.52 | 25.65 | N | OFF | 19.5 |
| 0.159000 | 51.15 | --- | 65.52 | 14.37 | N | OFF | 19.5 |
| 0.163500 | --- | 29.09 | 55.28 | 26.19 | N | OFF | 19.5 |
| 0.163500 | 49.73 | --- | 65.28 | 15.55 | N | OFF | 19.5 |
| 0.174750 | --- | 27.39 | 54.73 | 27.34 | N | OFF | 19.5 |
| 0.174750 | 45.40 | --- | 64.73 | 19.33 | N | OFF | 19.5 |
| 0.483000 | --- | 31.46 | 46.29 | 14.83 | N | OFF | 19.5 |
| 0.483000 | 41.10 | --- | 56.29 | 15.19 | N | OFF | 19.5 |
| 0.564000 | --- | 33.39 | 46.00 | 12.61 | N | OFF | 19.5 |
| 0.564000 | 41.61 | --- | 56.00 | 14.39 | N | OFF | 19.5 |
| 0.620250 | --- | 28.38 | 46.00 | 17.62 | N | OFF | 19.6 |
| 0.620250 | 39.86 | --- | 56.00 | 16.14 | N | OFF | 19.6 |
| 1.068000 | --- | 32.65 | 46.00 | 13.35 | N | OFF | 19.6 |
| 1.068000 | 35.89 | --- | 56.00 | 20.11 | N | OFF | 19.6 |
| 4.920000 | --- | 25.52 | 46.00 | 20.48 | N | OFF | 19.7 |
| 4.920000 | 27.97 | --- | 56.00 | 28.03 | N | OFF | 19.7 |
| 14.381250 | --- | 27.75 | 50.00 | 22.25 | N | OFF | 20.1 |
| 14.381250 | 33.10 | --- | 60.00 | 26.90 | N | OFF | 20.1 |



Appendix C. Radiated Spurious Emission

| | | | |
|-----------------|--------------------------------|---------------------|---------|
| Test Engineer : | Hao Hsu, Ken Wu, and Chuan Zhu | Temperature : | 21~26°C |
| | | Relative Humidity : | 51~56% |

2.4GHz 2400~2483.5MHz

BLE 1Mbps (Band Edge @ 3m)

| BLE | Note | Frequency | Level | Over Limit | Limit Line | Read Level | Antenna Factor | Path Loss | Preamp Factor | Ant Pos | Table Pos | Peak Avg. | Pol. | |
|-------------------------|------|-----------|------------|------------|------------|------------|----------------|-----------|---------------|---------|-----------|-----------|---------|---|
| | | (MHz) | (dBμV/m) | (dB) | (dBμV/m) | (dBμV) | (dB/m) | (dB) | (dB) | (cm) | (deg) | (P/A) | (H/V) | |
| BLE CH 00 2402MHz | | 2357.67 | 52.74 | -21.26 | 74 | 42.35 | 27.57 | 16.46 | 33.64 | 105 | 113 | P | H | |
| | | 2320.71 | 43.4 | -10.6 | 54 | 32.93 | 27.72 | 16.4 | 33.65 | 105 | 113 | A | H | |
| | * | 2402 | 93.99 | - | - | 83.7 | 27.4 | 16.52 | 33.63 | 105 | 113 | P | H | |
| | * | 2402 | 93.41 | - | - | 83.12 | 27.4 | 16.52 | 33.63 | 105 | 113 | A | H | |
| | | | | | | | | | | | | | H | |
| | | | | | | | | | | | | | H | |
| | | | 2384.445 | 52.11 | -21.89 | 74 | 41.78 | 27.46 | 16.5 | 33.63 | 314 | 100 | P | V |
| | | | 2353.89 | 43.47 | -10.53 | 54 | 33.08 | 27.58 | 16.45 | 33.64 | 314 | 100 | A | V |
| | * | | 2402 | 90.22 | - | - | 79.93 | 27.4 | 16.52 | 33.63 | 314 | 100 | P | V |
| | * | | 2402 | 89.71 | - | - | 79.42 | 27.4 | 16.52 | 33.63 | 314 | 100 | A | V |
| | | | | | | | | | | | | | V | |
| | | | | | | | | | | | | V | | |
| BLE CH 19 2440MHz | | 2327.85 | 52.75 | -21.25 | 74 | 42.3 | 27.69 | 16.41 | 33.65 | 114 | 111 | P | H | |
| | | 2327.4 | 43.26 | -10.74 | 54 | 32.81 | 27.69 | 16.41 | 33.65 | 114 | 111 | A | H | |
| | * | 2440 | 93.13 | - | - | 82.87 | 27.32 | 16.55 | 33.61 | 114 | 111 | P | H | |
| | * | 2440 | 92.59 | - | - | 82.33 | 27.32 | 16.55 | 33.61 | 114 | 111 | A | H | |
| | | | 2487.76 | 52.07 | -21.93 | 74 | 41.77 | 27.3 | 16.59 | 33.59 | 114 | 111 | P | H |
| | | | 2483.52 | 43.12 | -10.88 | 54 | 32.83 | 27.3 | 16.59 | 33.6 | 114 | 111 | A | H |
| | | | 2364.6 | 52.34 | -21.66 | 74 | 41.97 | 27.54 | 16.47 | 33.64 | 341 | 100 | P | V |
| | | | 2381.1 | 43.25 | -10.75 | 54 | 32.91 | 27.48 | 16.49 | 33.63 | 341 | 100 | A | V |
| | * | | 2440 | 90.24 | - | - | 79.98 | 27.32 | 16.55 | 33.61 | 341 | 100 | P | V |
| | * | | 2440 | 89.77 | - | - | 79.51 | 27.32 | 16.55 | 33.61 | 341 | 100 | A | V |
| | | | 2499.6 | 52.31 | -21.69 | 74 | 42 | 27.3 | 16.6 | 33.59 | 341 | 100 | P | V |
| | | | 2497.2 | 43.28 | -10.72 | 54 | 32.97 | 27.3 | 16.6 | 33.59 | 341 | 100 | A | V |



| | | | | | | | | | | | | | |
|----------------------------------|---|---------|-------|--------|----|-------|------|-------|-------|-----|-----|---|---|
| BLE CH 39 2480MHz | * | 2480 | 96.96 | - | - | 86.68 | 27.3 | 16.58 | 33.6 | 100 | 111 | P | H |
| | * | 2480 | 96.31 | - | - | 86.03 | 27.3 | 16.58 | 33.6 | 100 | 111 | A | H |
| | | 2498.4 | 52.27 | -21.73 | 74 | 41.96 | 27.3 | 16.6 | 33.59 | 100 | 111 | P | H |
| | | 2484.64 | 43.24 | -10.76 | 54 | 32.95 | 27.3 | 16.59 | 33.6 | 100 | 111 | A | H |
| | | | | | | | | | | | | | H |
| | | | | | | | | | | | | | H |
| | * | 2480 | 93.43 | - | - | 83.15 | 27.3 | 16.58 | 33.6 | 322 | 100 | P | V |
| | * | 2480 | 92.86 | - | - | 82.58 | 27.3 | 16.58 | 33.6 | 322 | 100 | A | V |
| | | 2494.24 | 52.29 | -21.71 | 74 | 41.98 | 27.3 | 16.6 | 33.59 | 322 | 100 | P | V |
| | | 2493.08 | 43.25 | -10.75 | 54 | 32.95 | 27.3 | 16.59 | 33.59 | 322 | 100 | A | V |
| | | | | | | | | | | | | | V |
| | | | | | | | | | | | | | V |
| Remark | <ol style="list-style-type: none"> 1. No other spurious found. 2. All results are PASS against Peak and Average limit line. | | | | | | | | | | | | |



2.4GHz 2400~2483.5MHz
BLE 1Mbps (Harmonic @ 3m)

| BLE | Note | Frequency (MHz) | Level (dBμV/m) | Over Limit (dB) | Limit Line (dBμV/m) | Read Level (dBμV) | Antenna Factor (dB/m) | Path Loss (dB) | Preamp Factor (dB) | Ant Pos (cm) | Table Pos (deg) | Peak Avg. (P/A) | Pol. (H/V) |
|-------------------------|--|----------------------|---------------------|-------------------------|-----------------------------|---------------------------|-------------------------------|------------------------|----------------------------|----------------------|-------------------------|-------------------------|-----------------|
| BLE CH 00 2402MHz | | 4804 | 37.62 | -36.38 | 74 | 55.03 | 31.1 | 10.07 | 58.58 | 100 | 0 | P | H |
| | | | | | | | | | | | | | H |
| | | | | | | | | | | | | | H |
| | | | | | | | | | | | | | H |
| | | 4804 | 37.52 | -36.48 | 74 | 54.93 | 31.1 | 10.07 | 58.58 | 100 | 0 | P | V |
| | | | | | | | | | | | | | V |
| | | | | | | | | | | | | | V |
| BLE CH 19 2440MHz | | 4880 | 39.9 | -34.1 | 74 | 57.26 | 31.04 | 10.15 | 58.55 | 100 | 0 | P | H |
| | | 7320 | 40.82 | -33.18 | 74 | 50.61 | 36.54 | 12.48 | 58.81 | 100 | 0 | P | H |
| | | | | | | | | | | | | | H |
| | | | | | | | | | | | | | H |
| | | 4880 | 38.8 | -35.2 | 74 | 56.16 | 31.04 | 10.15 | 58.55 | 100 | 0 | P | V |
| | | 7320 | 41.09 | -32.91 | 74 | 50.88 | 36.54 | 12.48 | 58.81 | 100 | 0 | P | V |
| | | | | | | | | | | | | | V |
| BLE CH 39 2480MHz | | 4960 | 40.42 | -33.58 | 74 | 57.39 | 31.32 | 10.22 | 58.51 | 100 | 0 | P | H |
| | | 7440 | 41.55 | -32.45 | 74 | 51.26 | 36.48 | 12.47 | 58.66 | 100 | 0 | P | H |
| | | | | | | | | | | | | | H |
| | | | | | | | | | | | | | H |
| | | 4960 | 38.52 | -35.48 | 74 | 55.49 | 31.32 | 10.22 | 58.51 | 100 | 0 | P | V |
| | | 7440 | 41.61 | -32.39 | 74 | 51.32 | 36.48 | 12.47 | 58.66 | 100 | 0 | P | V |
| | | | | | | | | | | | | | V |
| Remark | 1. No other spurious found. | | | | | | | | | | | | |
| | 2. All results are PASS against Peak and Average limit line. | | | | | | | | | | | | |



2.4GHz 2400~2483.5MHz
BLE 2Mbps (Band Edge @ 3m)

| BLE | Note | Frequency (MHz) | Level (dBµV/m) | Over Limit (dB) | Limit Line (dBµV/m) | Read Level (dBµV) | Antenna Factor (dB/m) | Path Loss (dB) | Preamp Factor (dB) | Ant Pos (cm) | Table Pos (deg) | Peak Avg. (P/A) | Pol. (H/V) | |
|----------------------------------|------|----------------------|---------------------|-------------------------|-----------------------------|---------------------------|-------------------------------|------------------------|----------------------------|----------------------|-------------------------|-------------------------|-----------------|---|
| BLE CH 00 2402MHz | | 2331.945 | 52.64 | -21.36 | 74 | 42.2 | 27.67 | 16.42 | 33.65 | 105 | 113 | P | H | |
| | | 2318.4 | 45.36 | -8.64 | 54 | 34.89 | 27.73 | 16.4 | 33.66 | 105 | 113 | A | H | |
| | * | 2402 | 94.02 | - | - | 83.73 | 27.4 | 16.52 | 33.63 | 105 | 113 | P | H | |
| | * | 2402 | 92.67 | - | - | 82.38 | 27.4 | 16.52 | 33.63 | 105 | 113 | A | H | |
| | | | | | | | | | | | | | H | |
| | | | | | | | | | | | | | | H |
| | | | 2338.35 | 53.64 | -20.36 | 74 | 43.21 | 27.65 | 16.43 | 33.65 | 314 | 100 | P | V |
| | | | 2389.275 | 45.32 | -8.68 | 54 | 35.01 | 27.44 | 16.5 | 33.63 | 314 | 100 | A | V |
| | * | | 2402 | 90.22 | - | - | 79.93 | 27.4 | 16.52 | 33.63 | 314 | 100 | P | V |
| | * | | 2402 | 88.8 | - | - | 78.51 | 27.4 | 16.52 | 33.63 | 314 | 100 | A | V |
| | | | | | | | | | | | | | | V |
| | | | | | | | | | | | | | | V |
| BLE CH 19 2440MHz | | 2319.38 | 53.12 | -20.88 | 74 | 42.66 | 27.72 | 16.4 | 33.66 | 113 | 111 | P | H | |
| | | 2382.24 | 45.16 | -8.84 | 54 | 34.83 | 27.47 | 16.49 | 33.63 | 113 | 111 | A | H | |
| | * | 2440 | 93.21 | - | - | 82.95 | 27.32 | 16.55 | 33.61 | 113 | 111 | P | H | |
| | * | 2440 | 91.73 | - | - | 81.47 | 27.32 | 16.55 | 33.61 | 113 | 111 | A | H | |
| | | | 2497.97 | 52.33 | -21.67 | 74 | 42.02 | 27.3 | 16.6 | 33.59 | 113 | 111 | P | H |
| | | | 2486.7 | 44.92 | -9.08 | 54 | 34.62 | 27.3 | 16.59 | 33.59 | 113 | 111 | A | H |
| | | | 2355.78 | 52.83 | -21.17 | 74 | 42.44 | 27.58 | 16.45 | 33.64 | 341 | 100 | P | V |
| | | | 2372.58 | 45.15 | -8.85 | 54 | 34.8 | 27.51 | 16.48 | 33.64 | 341 | 100 | A | V |
| | * | | 2440 | 90.52 | - | - | 80.26 | 27.32 | 16.55 | 33.61 | 341 | 100 | P | V |
| | * | | 2440 | 89.32 | - | - | 79.06 | 27.32 | 16.55 | 33.61 | 341 | 100 | A | V |
| | | | 2494.68 | 52.81 | -21.19 | 74 | 42.5 | 27.3 | 16.6 | 33.59 | 341 | 100 | P | V |
| | | | 2499.93 | 44.65 | -9.35 | 54 | 34.34 | 27.3 | 16.6 | 33.59 | 341 | 100 | A | V |



| | | | | | | | | | | | | | |
|----------------------------------|---|---------|-------|--------|----|-------|------|-------|-------|-----|-----|---|---|
| BLE CH 39 2480MHz | * | 2480 | 96.92 | - | - | 86.64 | 27.3 | 16.58 | 33.6 | 100 | 111 | P | H |
| | * | 2480 | 95.63 | - | - | 85.35 | 27.3 | 16.58 | 33.6 | 100 | 111 | A | H |
| | | 2499.16 | 53.64 | -20.36 | 74 | 43.33 | 27.3 | 16.6 | 33.59 | 100 | 111 | P | H |
| | | 2493.6 | 45.4 | -8.6 | 54 | 35.1 | 27.3 | 16.59 | 33.59 | 100 | 111 | A | H |
| | | | | | | | | | | | | | H |
| | | | | | | | | | | | | | H |
| | * | 2480 | 93.66 | - | - | 83.38 | 27.3 | 16.58 | 33.6 | 323 | 99 | P | V |
| | * | 2480 | 92.35 | - | - | 82.07 | 27.3 | 16.58 | 33.6 | 323 | 99 | A | V |
| | | 2495.8 | 53.33 | -20.67 | 74 | 43.02 | 27.3 | 16.6 | 33.59 | 323 | 99 | P | V |
| | | 2488 | 44.83 | -9.17 | 54 | 34.53 | 27.3 | 16.59 | 33.59 | 323 | 99 | A | V |
| | | | | | | | | | | | | | V |
| | | | | | | | | | | | | | V |
| Remark | <ol style="list-style-type: none"> 1. No other spurious found. 2. All results are PASS against Peak and Average limit line. | | | | | | | | | | | | |



2.4GHz 2400~2483.5MHz
BLE 2Mbps (Harmonic @ 3m)

| BLE | Note | Frequency (MHz) | Level (dBμV/m) | Over Limit (dB) | Limit Line (dBμV/m) | Read Level (dBμV) | Antenna Factor (dB/m) | Path Loss (dB) | Preamp Factor (dB) | Ant Pos (cm) | Table Pos (deg) | Peak Avg. (P/A) | Pol. (H/V) | |
|-------------------------|--|----------------------|---------------------|-------------------------|-----------------------------|---------------------------|-------------------------------|------------------------|----------------------------|----------------------|-------------------------|-------------------------|-----------------|---|
| BLE CH 00 2402MHz | | 4804 | 37.02 | -36.98 | 74 | 54.43 | 31.1 | 10.07 | 58.58 | 100 | 0 | P | H | |
| | | | | | | | | | | | | | H | |
| | | | | | | | | | | | | | H | |
| | | | | | | | | | | | | | H | |
| | | 4804 | 37.25 | -36.75 | 74 | 54.66 | 31.1 | 10.07 | 58.58 | 100 | 0 | P | V | |
| | | | | | | | | | | | | | | V |
| | | | | | | | | | | | | | | V |
| BLE CH 19 2440MHz | | 4880 | 39.7 | -34.3 | 74 | 57.06 | 31.04 | 10.15 | 58.55 | 100 | 0 | P | H | |
| | | 7320 | 41.11 | -32.89 | 74 | 50.9 | 36.54 | 12.48 | 58.81 | 100 | 0 | P | H | |
| | | | | | | | | | | | | | H | |
| | | | | | | | | | | | | | H | |
| | | 4880 | 37.22 | -36.78 | 74 | 54.58 | 31.04 | 10.15 | 58.55 | 100 | 0 | P | V | |
| | | 7320 | 40.87 | -33.13 | 74 | 50.66 | 36.54 | 12.48 | 58.81 | 100 | 0 | P | V | |
| | | | | | | | | | | | | | | V |
| BLE CH 39 2480MHz | | 4960 | 39.83 | -34.17 | 74 | 56.8 | 31.32 | 10.22 | 58.51 | 100 | 0 | P | H | |
| | | 7440 | 42.31 | -31.69 | 74 | 52.02 | 36.48 | 12.47 | 58.66 | 100 | 0 | P | H | |
| | | | | | | | | | | | | | H | |
| | | | | | | | | | | | | | H | |
| | | 4960 | 38.44 | -35.56 | 74 | 55.41 | 31.32 | 10.22 | 58.51 | 100 | 0 | P | V | |
| | | 7440 | 42.52 | -31.48 | 74 | 52.23 | 36.48 | 12.47 | 58.66 | 100 | 0 | P | V | |
| | | | | | | | | | | | | | | V |
| Remark | 1. No other spurious found. | | | | | | | | | | | | | |
| | 2. All results are PASS against Peak and Average limit line. | | | | | | | | | | | | | |



Emission below 1GHz

2.4GHz BLE (LF)

| BLE | Note | Frequency | Level | Over | Limit | Read | Antenna | Path | Preamp | Ant | Table | Peak | Pol. | |
|---------------------|--|-----------|------------|--------|------------|----------|----------|--------|--------|--------|---------|---------|-------|---|
| | | (MHz) | (dBμV/m) | (dB) | Line | Level | Factor | Loss | Factor | Pos | Pos | Avg. | (H/V) | |
| | | | | | (dBμV/m) | (dBμV) | (dB/m) | (dB) | (dB) | (cm) | (deg) | (P/A) | | |
| 2.4GHz BLE LF | | 39.45 | 26.42 | -13.58 | 40 | 38.72 | 19.34 | 0.85 | 32.49 | | | P | H | |
| | | 143.13 | 29.11 | -14.39 | 43.5 | 42.82 | 17.11 | 1.62 | 32.44 | | | P | H | |
| | | 176.34 | 28.51 | -14.99 | 43.5 | 44.08 | 14.99 | 1.85 | 32.41 | | | P | H | |
| | | 734.7 | 31.27 | -14.73 | 46 | 32.46 | 27.59 | 3.59 | 32.37 | | | P | H | |
| | | 883.1 | 31.82 | -14.18 | 46 | 30.46 | 29.11 | 4 | 31.75 | | | P | H | |
| | | 953.1 | 33.95 | -12.05 | 46 | 30.25 | 30.71 | 4.16 | 31.17 | 100 | 0 | P | H | |
| | | | | | | | | | | | | | | H |
| | | | | | | | | | | | | | | H |
| | | | | | | | | | | | | | | H |
| | | | | | | | | | | | | | | H |
| | | | | | | | | | | | | | | H |
| | | | | | | | | | | | | | | H |
| | | | 41.61 | 36.91 | -3.09 | 40 | 50.28 | 18.24 | 0.88 | 32.49 | 100 | 0 | P | V |
| | | | 45.12 | 35.6 | -4.4 | 40 | 50.63 | 16.52 | 0.94 | 32.49 | | | P | V |
| | | | 81.84 | 27.61 | -12.39 | 40 | 45.5 | 13.31 | 1.28 | 32.48 | | | P | V |
| | | | 766.9 | 30.76 | -15.24 | 46 | 31.48 | 27.88 | 3.68 | 32.28 | | | P | V |
| | | | 902 | 32.34 | -13.66 | 46 | 30.95 | 29 | 4.03 | 31.64 | | | P | V |
| | | | 953.8 | 33.49 | -12.51 | 46 | 29.75 | 30.74 | 4.16 | 31.16 | | | P | V |
| | | | | | | | | | | | | | | V |
| | | | | | | | | | | | | | | V |
| | | | | | | | | | | | | | V | |
| | | | | | | | | | | | | | V | |
| | | | | | | | | | | | | | V | |
| | | | | | | | | | | | | | V | |
| Remark | 1. No other spurious found. 2. All results are PASS against limit line. | | | | | | | | | | | | | |



Note symbol

| | |
|-----|--|
| * | Fundamental Frequency which can be ignored. However, the level of any unwanted emissions shall not exceed the level of the fundamental frequency. |
| ! | Test result is over limit line. |
| P/A | Peak or Average |
| H/V | Horizontal or Vertical |



A calculation example for radiated spurious emission is shown as below:

| BLE | Note | Frequency | Level | Over Limit | Limit Line | Read Level | Antenna Factor | Path Loss | Preamp Factor | Ant Pos | Table Pos | Peak Avg. | Pol. |
|-------------------------|------|-----------|------------|------------|------------|------------|----------------|-----------|---------------|---------|-----------|-----------|---------|
| | | (MHz) | (dBμV/m) | (dB) | (dBμV/m) | (dBμV) | (dB/m) | (dB) | (dB) | (cm) | (deg) | (P/A) | (H/V) |
| BLE CH 00 2402MHz | | 2390 | 55.45 | -18.55 | 74 | 54.51 | 32.22 | 4.58 | 35.86 | 103 | 308 | P | H |
| | | 2390 | 43.54 | -10.46 | 54 | 42.6 | 32.22 | 4.58 | 35.86 | 103 | 308 | A | H |

- Path Loss(dB) = Cable loss(dB) + Filter loss(dB) + Attenuator loss(dB)
- Level(dBμV/m) =
Antenna Factor(dB/m) + Path Loss(dB) + Read Level(dBμV) - Preamp Factor(dB)
- Over Limit(dB) = Level(dBμV/m) – Limit Line(dBμV/m)

For Peak Limit @ 2390MHz:

- Level(dBμV/m)
= Antenna Factor(dB/m) + Path Loss(dB) + Read Level(dBμV) - Preamp Factor(dB)
= 32.22(dB/m) + 4.58(dB) + 54.51(dBμV) – 35.86 (dB)
= 55.45 (dBμV/m)
- Over Limit(dB)
= Level(dBμV/m) – Limit Line(dBμV/m)
= 55.45(dBμV/m) – 74(dBμV/m)
= -18.55(dB)

For Average Limit @ 2390MHz:

- Level(dBμV/m)
= Antenna Factor(dB/m) + Path Loss(dB) + Read Level(dBμV) - Preamp Factor(dB)
= 32.22(dB/m) + 4.58(dB) + 42.6(dBμV) – 35.86 (dB)
= 43.54 (dBμV/m)
- Over Limit(dB)
= Level(dBμV/m) – Limit Line(dBμV/m)
= 43.54(dBμV/m) – 54(dBμV/m)
= -10.46(dB)

Both peak and average measured complies with the limit line, so test result is “PASS”.



Appendix D. Radiated Spurious Emission Plots

| | | | |
|-----------------|--------------------------------|---------------------|---------|
| Test Engineer : | Hao Hsu, Ken Wu, and Chuan Zhu | Temperature : | 21~26°C |
| | | Relative Humidity : | 51~56% |

Note symbol

| | |
|----|-----------------------|
| -L | Low channel location |
| -R | High channel location |

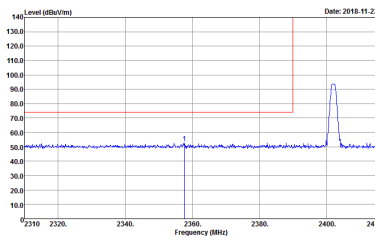
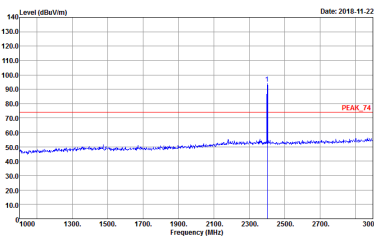
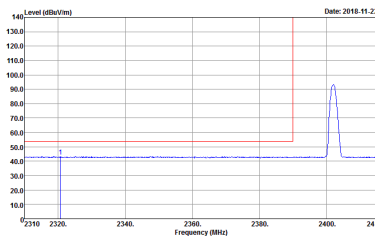
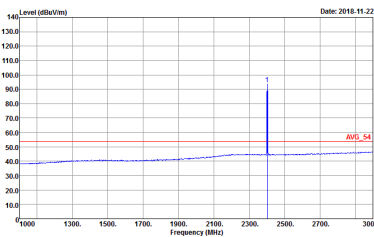

2.4GHz 2400~2483.5MHz
BLE 1Mbps (Band Edge @ 3m)

| BLE | 2.4GHz 2400~2483.5MHz Band Edge @ 3m | |
|------------------|--|--|
| BLE CH00 2402MHz | | |
| Horizontal | | Fundamental |
| Peak |  <p>Site : 03CH11-HY Condition : PEAK_BE_74 3m HORN 9120D-HF HORIZONTAL Detector : RBW:1000.000KHz VBW:3000.000KHz SWT:Auto Project : 882923-01</p> |  <p>Site : 03CH11-HY Condition : PEAK_74 3m HORN 9120D-HF HORIZONTAL Detector : RBW:1000.000KHz VBW:3000.000KHz SWT:Auto Project : 882923-01</p> |
| Avg. |  <p>Site : 03CH11-HY Condition : AVG_BE_54 3m HORN 9120D-HF HORIZONTAL Detector : RBW:1000.000KHz VBW:3.000KHz SWT:Auto Project : 882923-01</p> |  <p>Site : 03CH11-HY Condition : AVG_54 3m HORN 9120D-HF HORIZONTAL Detector : RBW:1000.000KHz VBW:3.000KHz SWT:Auto Project : 882923-01</p> |

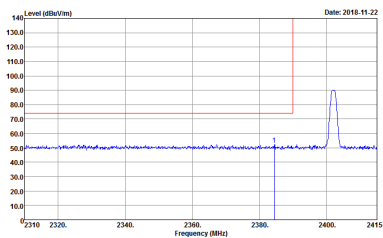
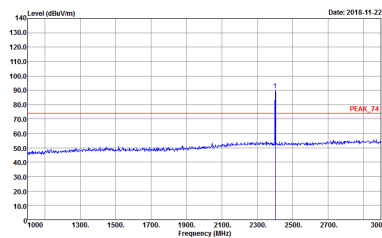
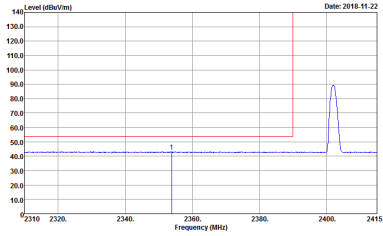
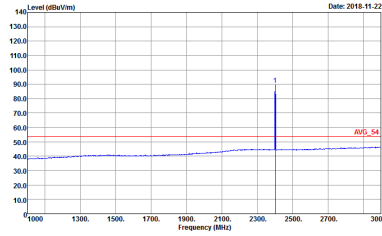

| BLE | 2.4GHz 2400~2483.5MHz Band Edge @ 3m | |
|------------------|--|--|
| BLE CH00 2402MHz | | |
| Vertical | | Fundamental |
| Peak |  <p>Date: 2018-11-22</p> <p>Site : 03CH11-HY Condition : PEAK_BE_74 3m HORN 9120D-HF VERTICAL Detector : Peak Project : 882923-01</p> |  <p>Date: 2018-11-22</p> <p>Site : 03CH11-HY Condition : PEAK_74 3m HORN 9120D-HF VERTICAL Detector : Peak Project : 882923-01</p> |
| Avg |  <p>Date: 2018-11-22</p> <p>Site : 03CH11-HY Condition : AVG_BE_54 3m HORN 9120D-HF VERTICAL Detector : Peak Project : 882923-01</p> |  <p>Date: 2018-11-22</p> <p>Site : 03CH11-HY Condition : AVG_54 3m HORN 9120D-HF VERTICAL Detector : Peak Project : 882923-01</p> |

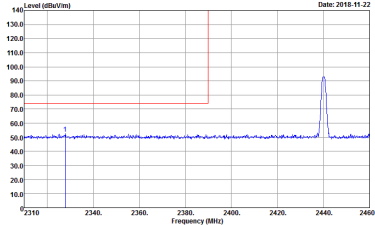
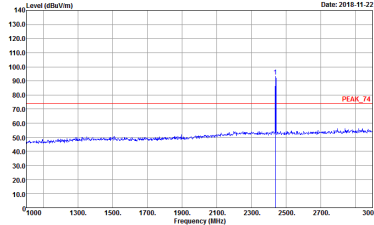
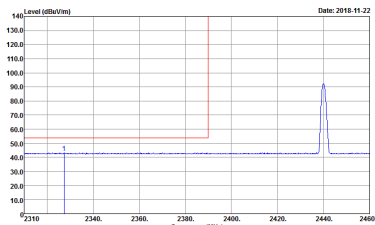
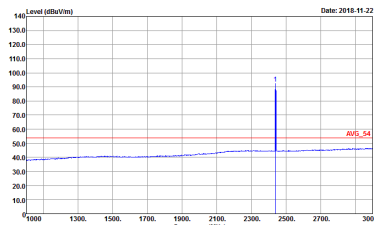

| BLE | 2.4GHz 2400~2483.5MHz Band Edge @ 3m | |
|----------------------|--|--|
| BLE CH19 2440MHz - L | | |
| Horizontal | | Fundamental |
| Peak |  <p>Date: 2018-11-22</p> <p>Site : 03CH11-HY Condition : PEAK_BE_74 3m HORN 9120D-HF HORIZONTAL RBW:1000.000KHz VBW:3000.000KHz SWT:Auto Detector : Peak Project : 882923-01</p> |  <p>Date: 2018-11-22</p> <p>Site : 03CH11-HY Condition : PEAK_74 3m HORN 9120D-HF HORIZONTAL RBW:1000.000KHz VBW:3000.000KHz SWT:Auto Detector : Peak Project : 882923-01</p> |
| Avg. |  <p>Date: 2018-11-22</p> <p>Site : 03CH11-HY Condition : AVG_BE_54 3m HORN 9120D-HF HORIZONTAL RBW:1000.000KHz VBW:3000.000KHz SWT:Auto Detector : Peak Project : 882923-01</p> |  <p>Date: 2018-11-22</p> <p>Site : 03CH11-HY Condition : AVG_54 3m HORN 9120D-HF HORIZONTAL RBW:1000.000KHz VBW:3000.000KHz SWT:Auto Detector : Peak Project : 882923-01</p> |

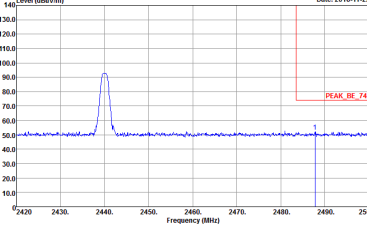
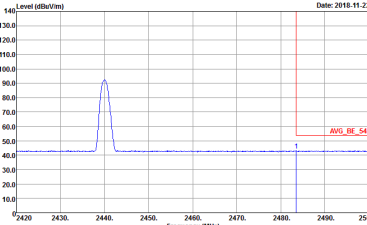

| BLE | 2.4GHz 2400~2483.5MHz Band Edge @ 3m | |
|----------------------|---|-------------|
| BLE CH19 2440MHz - R | | |
| Horizontal | | Fundamental |
| Peak |  <p>Site : 03CH11-HY Condition : PEAK_BE_74 3m HORN 91200-HF HORIZONTAL Detector : Peak Project : 882923-01</p> | Left blank |
| Avg. |  <p>Site : 03CH11-HY Condition : AVG_BE_54 3m HORN 91200-HF HORIZONTAL Detector : Peak Project : 882923-01</p> | Left blank |

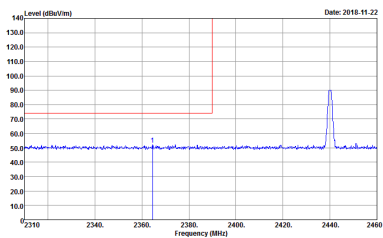
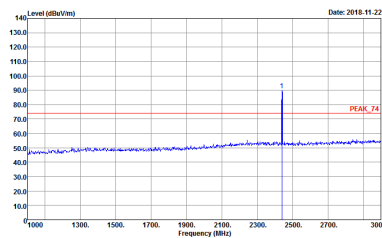
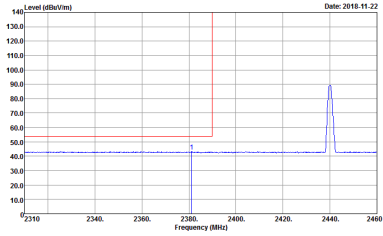
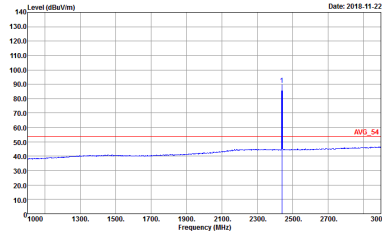

| BLE | 2.4GHz 2400~2483.5MHz Band Edge @ 3m | |
|----------------------|--|--|
| BLE CH19 2440MHz - L | | |
| Vertical | | Fundamental |
| Peak |  <p>Site : 03CH11-HY Condition : PEAK_BE_74 3m HORN 9120D-HF VERTICAL Detector : Peak Project : 882923-01</p> |  <p>Site : 03CH11-HY Condition : PEAK_74 3m HORN 9120D-HF VERTICAL Detector : Peak Project : 882923-01</p> |
| Avg. |  <p>Site : 03CH11-HY Condition : AVG_BE_54 3m HORN 9120D-HF VERTICAL Detector : Peak Project : 882923-01</p> |  <p>Site : 03CH11-HY Condition : AVG_54 3m HORN 9120D-HF VERTICAL Detector : Peak Project : 882923-01</p> |

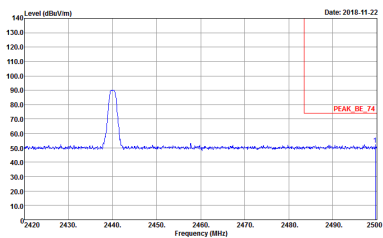
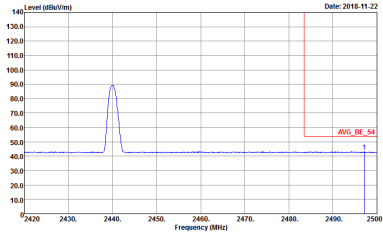

| BLE | 2.4GHz 2400~2483.5MHz Band Edge @ 3m | |
|--------------------|--|-------------------|
| | BLE CH19 2440MHz - R | |
| | Vertical | Fundamental |
| <p>Peak</p> |  <p>Site : 03CH11-HY Condition : PEAK_BE_74 3m HORN 91200-HF VERTICAL Detector : Peak Project : 882923-01</p> | <p>Left blank</p> |
| <p>Avg.</p> |  <p>Site : 03CH11-HY Condition : AVG_BE_54 3m HORN 91200-HF VERTICAL Detector : Peak Project : 882923-01</p> | <p>Left blank</p> |

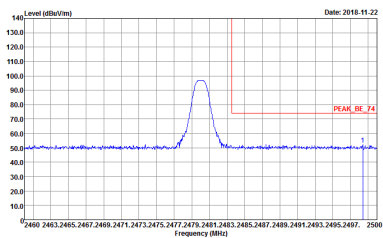
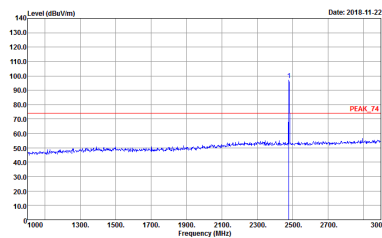
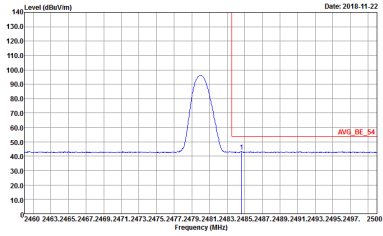
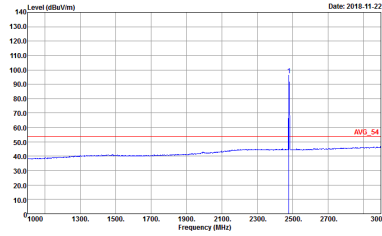

| BLE | 2.4GHz 2400~2483.5MHz Band Edge @ 3m | |
|------------------|--|--|
| BLE CH39 2480MHz | | |
| Horizontal | | Fundamental |
| Peak |  <p>Site : 03CH11-HY Condition : PEAK_BE_74 3m HORN 9120D-HF HORIZONTAL Detector : Peak Project : 882923-01</p> |  <p>Site : 03CH11-HY Condition : PEAK_74 3m HORN 9120D-HF HORIZONTAL Detector : Peak Project : 882923-01</p> |
| Avg. |  <p>Site : 03CH11-HY Condition : AVG_BE_54 3m HORN 9120D-HF HORIZONTAL Detector : Peak Project : 882923-01</p> |  <p>Site : 03CH11-HY Condition : AVG_54 3m HORN 9120D-HF HORIZONTAL Detector : Peak Project : 882923-01</p> |

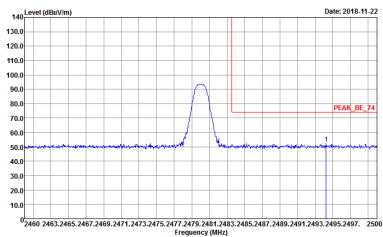
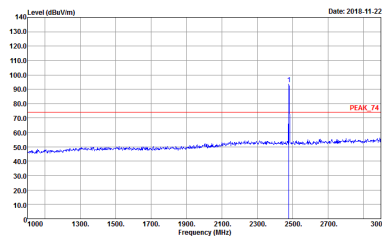
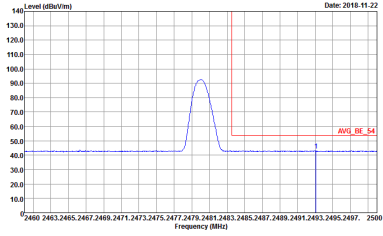
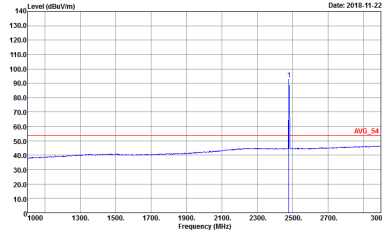

| BLE | 2.4GHz 2400~2483.5MHz Band Edge @ 3m | |
|------------------|---|---|
| BLE CH39 2480MHz | | |
| Vertical | | Fundamental |
| Peak |  <p>Level (dBm/100kHz) vs Frequency (MHz) plot showing a peak at 2480 MHz. The peak level is approximately 100 dBm/100kHz. The plot includes a red line indicating the peak level and a blue line for the spectrum. The x-axis ranges from 2460 to 2500 MHz, and the y-axis ranges from 10.0 to 140.0 dBm/100kHz.</p> <p>Site : 03CH11-HY Condition : PEAK_BE_74 3m HORN 9120D-HF VERTICAL RBW:1000.000KHz VBW:3000.000KHz SWT:Auto Detector : Peak Project : 882923-01</p> |  <p>Level (dBm/100kHz) vs Frequency (MHz) plot showing a peak at 2480 MHz. The peak level is approximately 100 dBm/100kHz. The plot includes a red line indicating the peak level and a blue line for the spectrum. The x-axis ranges from 1900 to 3000 MHz, and the y-axis ranges from 10.0 to 140.0 dBm/100kHz.</p> <p>Site : 03CH11-HY Condition : PEAK_74 3m HORN 9120D-HF VERTICAL RBW:1000.000KHz VBW:3000.000KHz SWT:Auto Detector : Peak Project : 882923-01</p> |
| Avg. |  <p>Level (dBm/100kHz) vs Frequency (MHz) plot showing an average level at 2480 MHz. The average level is approximately 50 dBm/100kHz. The plot includes a red line indicating the average level and a blue line for the spectrum. The x-axis ranges from 2460 to 2500 MHz, and the y-axis ranges from 10.0 to 140.0 dBm/100kHz.</p> <p>Site : 03CH11-HY Condition : AVG_BE_54 3m HORN 9120D-HF VERTICAL RBW:1000.000KHz VBW:3.000KHz SWT:Auto Detector : Peak Project : 882923-01</p> |  <p>Level (dBm/100kHz) vs Frequency (MHz) plot showing an average level at 2480 MHz. The average level is approximately 50 dBm/100kHz. The plot includes a red line indicating the average level and a blue line for the spectrum. The x-axis ranges from 1900 to 3000 MHz, and the y-axis ranges from 10.0 to 140.0 dBm/100kHz.</p> <p>Site : 03CH11-HY Condition : AVG_54 3m HORN 9120D-HF VERTICAL RBW:1000.000KHz VBW:3.000KHz SWT:Auto Detector : Peak Project : 882923-01</p> |

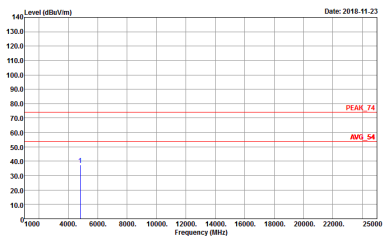
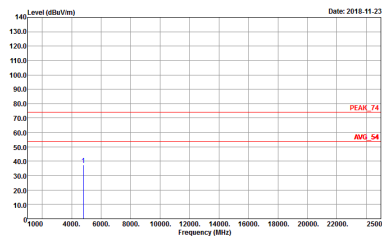

2.4GHz 2400~2483.5MHz
BLE 1Mbps (Harmonic @ 3m)

| | | |
|----------------------|---|--|
| BLE | 2.4GHz 2400~2483.5MHz Harmonic @ 3m | |
| | BLE CH00 2402MHz | |
| | Horizontal | Vertical |
| <p>Peak Avg.</p> |  <p>Site : 03CH11-HY Condition : PEAK_74 3m HORN 91200-HF HORIZONTAL Detector : Peak Project : 882923-01</p> |  <p>Site : 03CH11-HY Condition : PEAK_74 3m HORN 91200-HF VERTICAL Detector : Peak Project : 882923-01</p> |



| BLE | 2.4GHz 2400~2483.5MHz Harmonic @ 3m | |
|---------------------------------------|--|--|
| BLE CH19 2440MHz | | |
| | Horizontal | Vertical |
| <p>Peak</p> <p>Avg.</p> | <p>Horizontal spectrum plot showing Level (dBuV/m) vs Frequency (MHz). The plot displays two distinct peaks at approximately 5.0 MHz and 6.0 MHz. The y-axis ranges from 0 to 140 dBuV/m, and the x-axis ranges from 0 to 25000 MHz. A red horizontal line indicates the peak level at approximately 74 dBuV/m, and another red line indicates the average level at approximately 54 dBuV/m.</p> <p>Site : 03CH11-1F Condition : PEAK_74 3m HORN 9120D-HF HORIZONTAL Detector : Peak Project : 882923-01</p> | <p>Vertical spectrum plot showing Level (dBuV/m) vs Frequency (MHz). The plot displays two distinct peaks at approximately 5.0 MHz and 6.0 MHz. The y-axis ranges from 0 to 140 dBuV/m, and the x-axis ranges from 0 to 25000 MHz. A red horizontal line indicates the peak level at approximately 74 dBuV/m, and another red line indicates the average level at approximately 54 dBuV/m.</p> <p>Site : 03CH11-1F Condition : PEAK_74 3m HORN 9120D-HF VERTICAL Detector : Peak Project : 882923-01</p> |

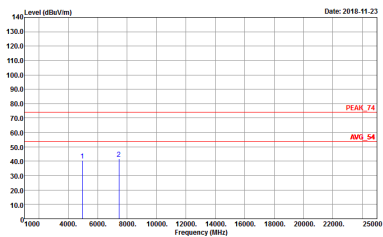
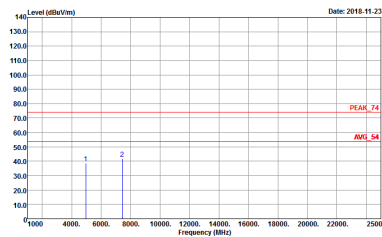

| BLE | 2.4GHz 2400~2483.5MHz Harmonic @ 3m | |
|-------------|---|--|
| | BLE CH39 2480MHz | |
| | Horizontal | Vertical |
| Peak |  <p>Site : 03CH11-1F Condition : PEAK_74 3m HORN 9120D-HF HORIZONTAL Detector : Peak Project : 882923-01</p> |  <p>Site : 03CH11-1F Condition : PEAK_74 3m HORN 9120D-HF VERTICAL Detector : Peak Project : 882923-01</p> |



2.4GHz 2400~2483.5MHz
BLE 2Mbps (Band Edge @ 3m)

Table with 2 columns (Horizontal, Fundamental) and 2 rows (Peak, Avg.). Each cell contains a spectral plot and technical details like Site, Condition, Detector, and Project.

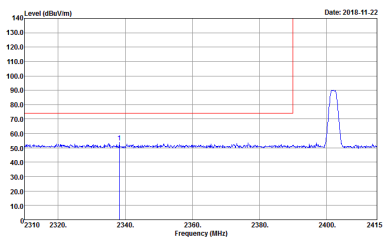
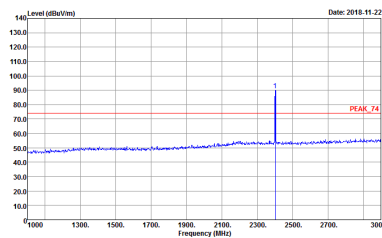
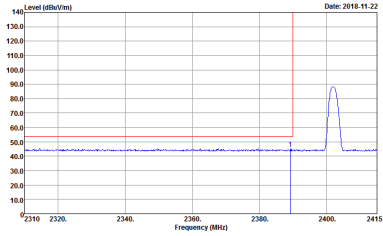
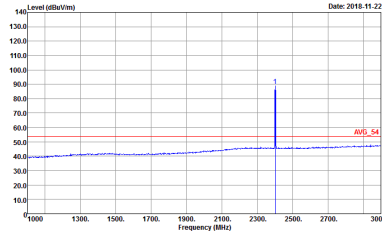

| BLE | 2.4GHz 2400~2483.5MHz Band Edge @ 3m | |
|------------------|--|--|
| BLE CH00 2402MHz | | |
| Vertical | | Fundamental |
| Peak |  <p>Level (dBm/100kHz) vs Frequency (MHz) plot for Vertical Peak. The plot shows a sharp peak at approximately 2402 MHz. The y-axis ranges from 10.0 to 140.0 dBm/100kHz, and the x-axis ranges from 2310 to 2415 MHz. A red horizontal line is drawn at approximately 80 dBm/100kHz.</p> <p>Site : 03CH11-HY Condition : PEAK_BE_74 3m HORN 9120D-HF VERTICAL Detector : Peak Project : 882923-01</p> |  <p>Level (dBm/100kHz) vs Frequency (MHz) plot for Fundamental Peak. The plot shows a sharp peak at approximately 2402 MHz. The y-axis ranges from 10.0 to 140.0 dBm/100kHz, and the x-axis ranges from 1900 to 3000 MHz. A red horizontal line is drawn at approximately 80 dBm/100kHz, labeled 'PEAK_74'.</p> <p>Site : 03CH11-HY Condition : PEAK_74 3m HORN 9120D-HF VERTICAL Detector : Peak Project : 882923-01</p> |
| Avg |  <p>Level (dBm/100kHz) vs Frequency (MHz) plot for Vertical Avg. The plot shows a sharp peak at approximately 2402 MHz. The y-axis ranges from 10.0 to 140.0 dBm/100kHz, and the x-axis ranges from 2310 to 2415 MHz. A red horizontal line is drawn at approximately 80 dBm/100kHz.</p> <p>Site : 03CH11-HY Condition : AVG_BE_54 3m HORN 9120D-HF VERTICAL Detector : Peak Project : 882923-01</p> |  <p>Level (dBm/100kHz) vs Frequency (MHz) plot for Fundamental Avg. The plot shows a sharp peak at approximately 2402 MHz. The y-axis ranges from 10.0 to 140.0 dBm/100kHz, and the x-axis ranges from 1900 to 3000 MHz. A red horizontal line is drawn at approximately 80 dBm/100kHz, labeled 'AVG_54'.</p> <p>Site : 03CH11-HY Condition : AVG_54 3m HORN 9120D-HF VERTICAL Detector : Peak Project : 882923-01</p> |

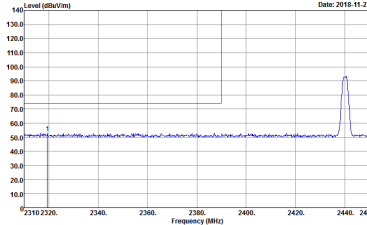
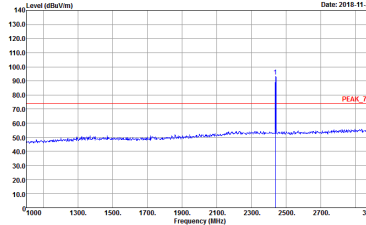
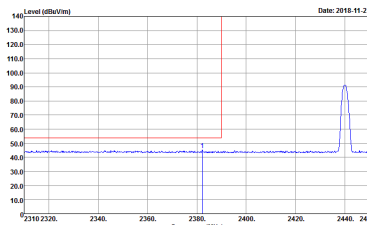
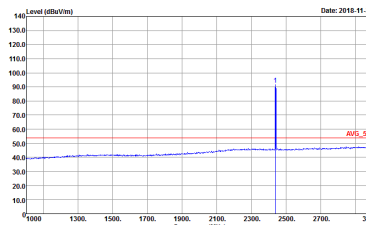

| BLE | 2.4GHz 2400~2483.5MHz Band Edge @ 3m | |
|----------------------|---|---|
| BLE CH19 2440MHz - L | | |
| | Horizontal | Fundamental |
| Peak |  <p>Date: 2018-11-22</p> <p>Site : 03CH11-HY Condition : PEAK_BE_74 3m HORN 9120D-HF HORIZONTAL RBW:1000.000KHz VBW:3000.000KHz SWT:Auto Detector : Peak Project : 882923-01</p> |  <p>Date: 2018-11-22</p> <p>Site : 03CH11-HY Condition : PEAK_74 3m HORN 9120D-HF HORIZONTAL RBW:1000.000KHz VBW:3000.000KHz SWT:Auto Detector : Peak Project : 882923-01</p> |
| Avg. |  <p>Date: 2018-11-22</p> <p>Site : 03CH11-HY Condition : AVG_BE_54 3m HORN 9120D-HF HORIZONTAL RBW:1000.000KHz VBW:10.000KHz SWT:Auto Detector : Peak Project : 882923-01</p> |  <p>Date: 2018-11-22</p> <p>Site : 03CH11-HY Condition : AVG_54 3m HORN 9120D-HF HORIZONTAL RBW:1000.000KHz VBW:10.000KHz SWT:Auto Detector : Peak Project : 882923-01</p> |



| BLE | 2.4GHz 2400~2483.5MHz Band Edge @ 3m | |
|----------------------|---|-------------------|
| BLE CH19 2440MHz - R | | |
| Horizontal | | Fundamental |
| <p>Peak</p> | <p>Site : 03CH11-HY Condition : PEAK_BE_74 3m HORN 91200-HF HORIZONTAL RBW:1000.000KHz VBW:3000.000KHz SWT:Auto Detector : Peak Project : 882923-01</p> | <p>Left blank</p> |
| <p>Avg.</p> | <p>Site : 03CH11-HY Condition : AVG_BE_54 3m HORN 91200-HF HORIZONTAL RBW:1000.000KHz VBW:10.000KHz SWT:Auto Detector : Peak Project : 882923-01</p> | <p>Left blank</p> |

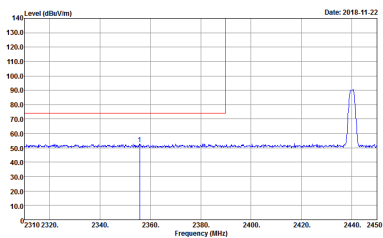
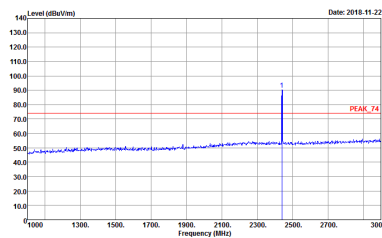
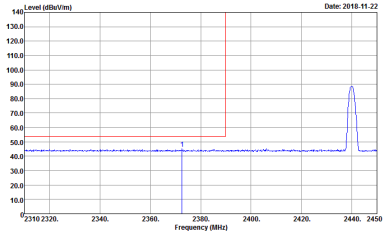
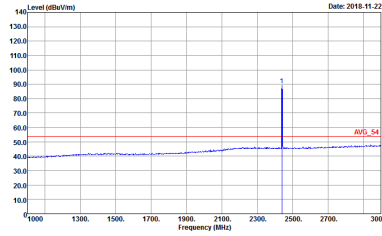

| BLE | 2.4GHz 2400~2483.5MHz Band Edge @ 3m | |
|----------------------|--|--|
| BLE CH19 2440MHz - L | | |
| Vertical | | Fundamental |
| Peak |  <p>Level (dBm/1m) vs Frequency (MHz) plot showing a peak at 2440 MHz. The y-axis ranges from 10.0 to 140.0 dBm/1m, and the x-axis ranges from 2310 to 2450 MHz. A red line indicates the peak level at approximately 85 dBm/1m.</p> <p>Site : 03CH11-HY Condition : PEAK_BE_74 3m HORN 9120D-HF VERTICAL Detector : RBW:1000.000KHz VBW:3000.000KHz SWT:Auto Detector : Peak Project : 882923-01</p> |  <p>Level (dBm/1m) vs Frequency (MHz) plot showing a peak at 2440 MHz. The y-axis ranges from 10.0 to 140.0 dBm/1m, and the x-axis ranges from 1000 to 3000 MHz. A red line indicates the peak level at approximately 75 dBm/1m, labeled 'PEAK_74'.</p> <p>Site : 03CH11-HY Condition : PEAK_74 3m HORN 9120D-HF VERTICAL Detector : RBW:1000.000KHz VBW:3000.000KHz SWT:Auto Detector : Peak Project : 882923-01</p> |
| Avg. |  <p>Level (dBm/1m) vs Frequency (MHz) plot showing an average level at 2440 MHz. The y-axis ranges from 10.0 to 140.0 dBm/1m, and the x-axis ranges from 2310 to 2450 MHz. A red line indicates the average level at approximately 55 dBm/1m.</p> <p>Site : 03CH11-HY Condition : AVG_BE_54 3m HORN 9120D-HF VERTICAL Detector : RBW:1000.000KHz VBW:10.000KHz SWT:Auto Detector : Peak Project : 882923-01</p> |  <p>Level (dBm/1m) vs Frequency (MHz) plot showing an average level at 2440 MHz. The y-axis ranges from 10.0 to 140.0 dBm/1m, and the x-axis ranges from 1000 to 3000 MHz. A red line indicates the average level at approximately 55 dBm/1m, labeled 'AVG_54'.</p> <p>Site : 03CH11-HY Condition : AVG_54 3m HORN 9120D-HF VERTICAL Detector : RBW:1000.000KHz VBW:10.000KHz SWT:Auto Detector : Peak Project : 882923-01</p> |

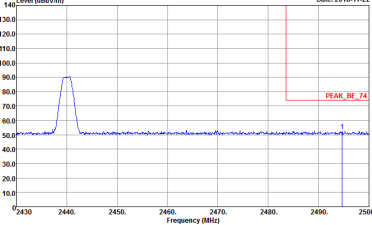
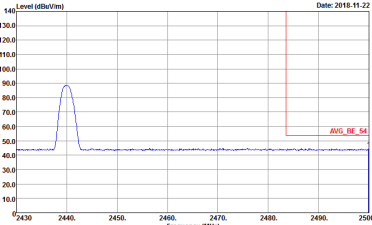

| BLE | 2.4GHz 2400~2483.5MHz Band Edge @ 3m | |
|----------------------|---|-------------------|
| BLE CH19 2440MHz - R | | |
| Vertical | | Fundamental |
| <p>Peak</p> |  <p>Date: 2018-11-22</p> <p>Site : 03CH11-HY Condition : PEAK_BE_74 3m HORN 91200-HF VERTICAL RBW:1000.000KHz VBW:3000.000KHz SWT:Auto Detector : Peak Project : 882923-01</p> | <p>Left blank</p> |
| <p>Avg.</p> |  <p>Date: 2018-11-22</p> <p>Site : 03CH11-HY Condition : AVG_BE_54 3m HORN 91200-HF VERTICAL RBW:1000.000KHz VBW:10.000KHz SWT:Auto Detector : Peak Project : 882923-01</p> | <p>Left blank</p> |

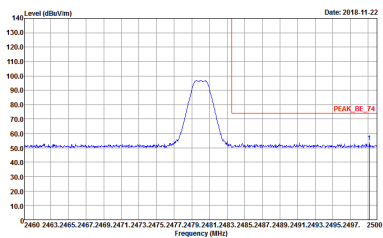
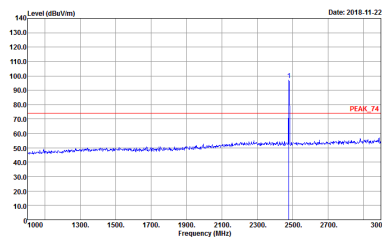
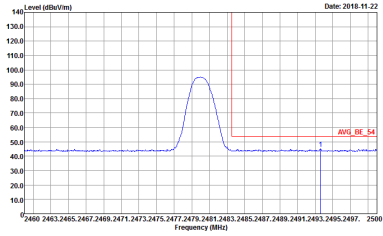
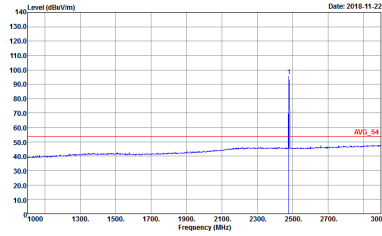

| BLE | 2.4GHz 2400~2483.5MHz Band Edge @ 3m | |
|------------------|--|--|
| BLE CH39 2480MHz | | |
| Horizontal | | Fundamental |
| Peak |  <p>Site : 03CH11-HY Condition : PEAK_BE_74 3m HORN 9120D-HF HORIZONTAL Detector : Peak Project : 882923-01</p> |  <p>Site : 03CH11-HY Condition : PEAK_74 3m HORN 9120D-HF HORIZONTAL Detector : Peak Project : 882923-01</p> |
| Avg. |  <p>Site : 03CH11-HY Condition : AVG_BE_54 3m HORN 9120D-HF HORIZONTAL Detector : Peak Project : 882923-01</p> |  <p>Site : 03CH11-HY Condition : AVG_54 3m HORN 9120D-HF HORIZONTAL Detector : Peak Project : 882923-01</p> |

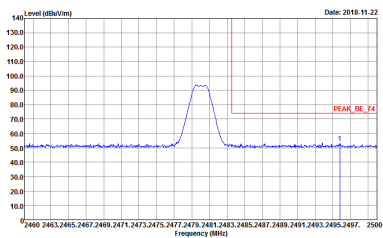
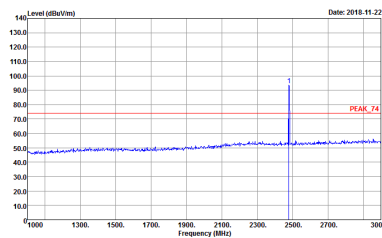
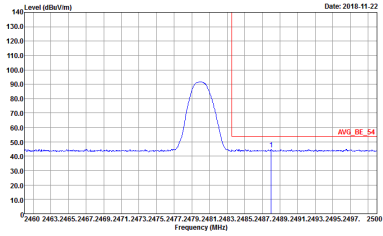
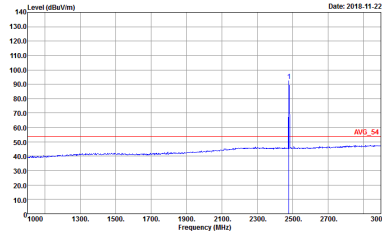

| BLE | 2.4GHz 2400~2483.5MHz Band Edge @ 3m | |
|------------------|---|--|
| BLE CH39 2480MHz | | |
| Vertical | | Fundamental |
| Peak |  <p>Level (dBm/100kHz) vs Frequency (MHz) plot showing a peak at 2480 MHz. The peak level is approximately 95 dBm/100kHz. A red horizontal line indicates the peak level at 95.0 dBm/100kHz, labeled 'PEAK_BE_74'.</p> <p>Site : 03CH11-HY Condition : PEAK_BE_74 3m HORN 91200-HF VERTICAL RBW:1000.000KHz VBW:3000.000KHz SWT:Auto Detector : Peak Project : 882923-01</p> |  <p>Level (dBm/100kHz) vs Frequency (MHz) plot showing a sharp peak at 2480 MHz. The peak level is approximately 100 dBm/100kHz. A red horizontal line indicates the peak level at 100.0 dBm/100kHz, labeled 'PEAK_74'.</p> <p>Site : 03CH11-HY Condition : PEAK_74 3m HORN 91200-HF VERTICAL RBW:1000.000KHz VBW:3000.000KHz SWT:Auto Detector : Peak Project : 882923-01</p> |
| Avg. |  <p>Level (dBm/100kHz) vs Frequency (MHz) plot showing a peak at 2480 MHz. The average level is approximately 90 dBm/100kHz. A red horizontal line indicates the average level at 90.0 dBm/100kHz, labeled 'AVG_BE_54'.</p> <p>Site : 03CH11-HY Condition : AVG_BE_54 3m HORN 91200-HF VERTICAL RBW:1000.000KHz VBW:10.000KHz SWT:Auto Detector : Peak Project : 882923-01</p> |  <p>Level (dBm/100kHz) vs Frequency (MHz) plot showing a sharp peak at 2480 MHz. The average level is approximately 100 dBm/100kHz. A red horizontal line indicates the average level at 100.0 dBm/100kHz, labeled 'AVG_54'.</p> <p>Site : 03CH11-HY Condition : AVG_54 3m HORN 91200-HF VERTICAL RBW:1000.000KHz VBW:10.000KHz SWT:Auto Detector : Peak Project : 882923-01</p> |



2.4GHz 2400~2483.5MHz
BLE 2Mbps (Harmonic @ 3m)

Table with 2 columns: Horizontal and Vertical. Each column contains a graph of Level (dBuV/m) vs Frequency (MHz) for BLE CH00 2402MHz. The graphs show a peak at approximately 4.5 MHz. The table also includes a 'Peak Avg.' label and technical details for both orientations.

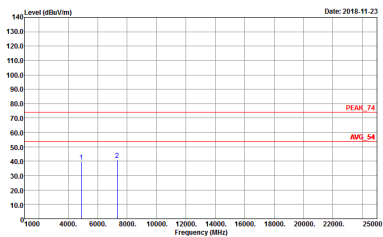
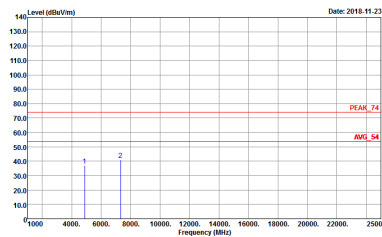

| BLE | 2.4GHz 2400~2483.5MHz Harmonic @ 3m | |
|---------------------------------------|---|--|
| | BLE CH19 2440MHz | |
| | Horizontal | Vertical |
| <p>Peak</p> <p>Avg.</p> |  <p>Site : 03CH11-1F Condition : PEAK_74 3m HORN 9120D-HF HORIZONTAL Detector : Peak Project : 882923-01</p> |  <p>Site : 03CH11-1F Condition : PEAK_74 3m HORN 9120D-HF VERTICAL Detector : Peak Project : 882923-01</p> |

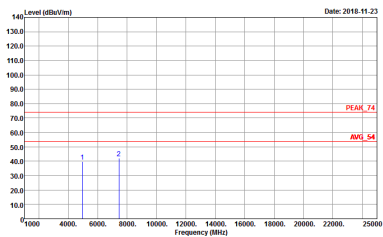
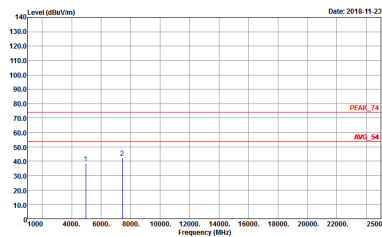

| | | |
|------|--|---|
| BLE | 2.4GHz 2400~2483.5MHz Harmonic @ 3m | |
| | BLE CH39 2480MHz | |
| | Horizontal | Vertical |
| Peak |  <p>Site : 03CH11-1F Condition : PEAK_74 3m HORN 9120D-HF HORIZONTAL Detector : Peak Project : 882923-01</p> |  <p>Site : 03CH11-1F Condition : PEAK_74 3m HORN 9120D-HF VERTICAL Detector : Peak Project : 882923-01</p> |



Emission below 1GHz

2.4GHz BLE (LF)

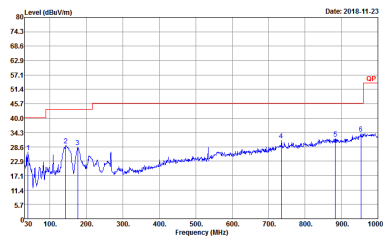
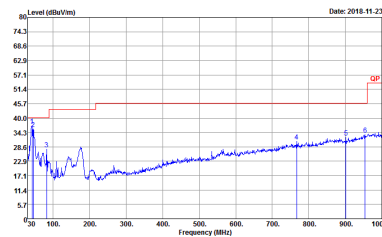
| BLE | 2.4GHz 2400~2483.5MHz | |
|----------------------|---|--|
| BLE LF | | |
| Horizontal | | Vertical |
| <p>QP / Peak</p> |  <p>Site : 03CH11-HY Condition : QP 3m BE-LOG 6111D-LF_ETC HORIZONTAL Detector : Peak Project : 882923-01</p> |  <p>Site : 03CH11-HY Condition : QP 3m BE-LOG 6111D-LF_ETC VERTICAL Detector : Peak Project : 882923-01</p> |



Appendix E. Duty Cycle Plots

| Band | Duty Cycle(%) | T(us) | 1/T(kHz) | VBW Setting | Duty Factor(dB) |
|-------------------------|---------------|-------|----------|-------------|-----------------|
| Bluetooth LE for 1 Mbps | 62.5 | 390 | 2.56 | 3kHz | 2.04 |
| Bluetooth LE for 2 Mbps | 32.91 | 206 | 4.85 | 10kHz | 4.83 |



Bluetooth - LE

<1 Mbps>

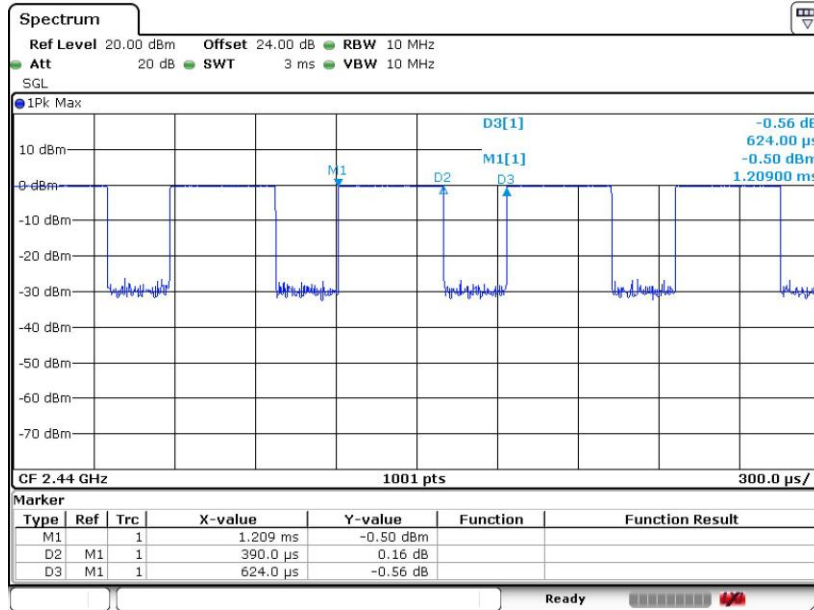

Date: 14.SEP.2018 07:08:39

<2 Mbps>

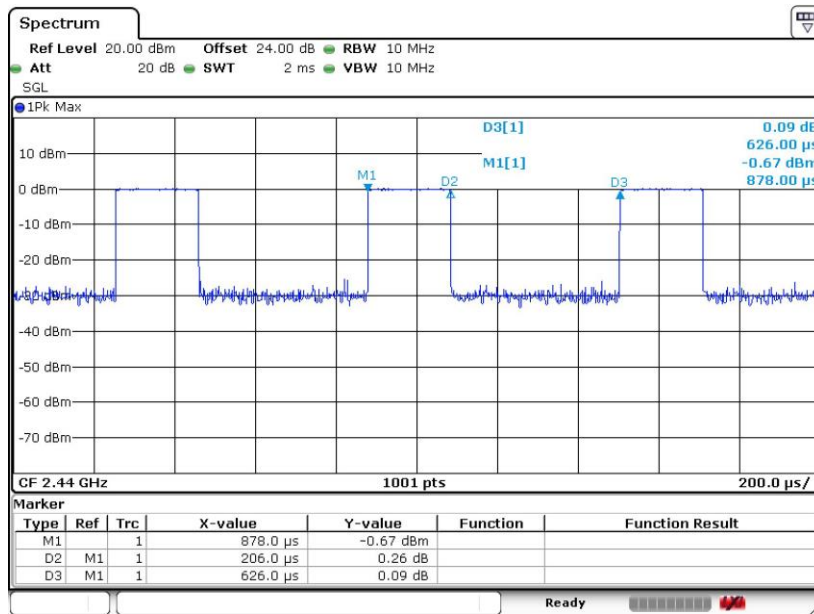

Date: 14.SEP.2018 07:07:36

—THE END—