



FCC RF Test Report

APPLICANT : Sony Mobile Communications Inc.
EQUIPMENT : GSM/WCDMA/LTE Phone+Bluetooth,
DTS/UNII a/b/g/n and NFC
BRAND NAME : Sony
FCC ID : PY7-35228S
STANDARD : FCC Part 15 Subpart C §15.247
CLASSIFICATION : (DTS) Digital Transmission System

The product was received on Aug. 21, 2017 and testing was completed on Sep. 05, 2017. We, SPORTON INTERNATIONAL INC., would like to declare that the tested sample has been evaluated in accordance with the test procedures and has been in compliance with the applicable technical standards.

The test results in this report apply exclusively to the tested model / sample. Without written approval of SPORTON INTERNATIONAL INC., the test report shall not be reproduced except in full.

Reviewed by: Joseph Lin / Supervisor

Approved by: Jones Tsai / Manager



SPORTON INTERNATIONAL INC.

No. 52, Hwa Ya 1st Rd., Hwa Ya Technology Park, Kwei-Shan District, Tao Yuan City, Taiwan, R.O.C.



TABLE OF CONTENTS

REVISION HISTORY.....3

SUMMARY OF TEST RESULT4

1 GENERAL DESCRIPTION5

 1.1 Applicant5

 1.2 Manufacturer.....5

 1.3 Product Feature of Equipment Under Test.....5

 1.4 Modification of EUT6

 1.5 Testing Location7

 1.6 Applicable Standards.....7

2 TEST CONFIGURATION OF EQUIPMENT UNDER TEST8

 2.1 Carrier Frequency and Channel8

 2.2 Test Mode.....9

 2.3 Connection Diagram of Test System.....10

 2.4 Support Unit used in test configuration and system11

 2.5 EUT Operation Test Setup11

 2.6 Measurement Results Explanation Example.....11

3 TEST RESULT.....12

 3.1 6dB and 99% Bandwidth Measurement12

 3.2 Output Power Measurement.....14

 3.3 Power Spectral Density Measurement15

 3.4 Conducted Band Edges and Spurious Emission Measurement17

 3.5 Radiated Band Edges and Spurious Emission Measurement27

 3.6 AC Conducted Emission Measurement.....31

 3.7 Antenna Requirements33

4 LIST OF MEASURING EQUIPMENT34

5 UNCERTAINTY OF EVALUATION.....36

APPENDIX A. CONDUCTED TEST RESULTS

APPENDIX B. AC CONDUCTED EMISSION TEST RESULT

APPENDIX C. RADIATED SPURIOUS EMISSION

APPENDIX D. RADIATED SPURIOUS EMISSION PLOTS

APPENDIX E. DUTY CYCLE PLOTS



REVISION HISTORY

REPORT NO.	VERSION	DESCRIPTION	ISSUED DATE
FR782113C	Rev. 01	Initial issue of report	Oct. 30, 2017



SUMMARY OF TEST RESULT

Report Section	FCC Rule	Description	Limit	Result	Remark
3.1	15.247(a)(2)	6dB Bandwidth	$\geq 0.5\text{MHz}$	Pass	-
3.1	-	99% Bandwidth	-	Pass	-
3.2	15.247(b)	Power Output Measurement	$\leq 30\text{dBm}$	Pass	-
3.3	15.247(e)	Power Spectral Density	$\leq 8\text{dBm}/3\text{kHz}$	Pass	-
3.4	15.247(d)	Conducted Band Edges	$\leq 20\text{dBc}$	Pass	-
		Conducted Spurious Emission		Pass	-
3.5	15.247(d)	Radiated Band Edges and Radiated Spurious Emission	15.209(a) & 15.247(d)	Pass	Under limit 3.23 dB at 2483.520 MHz
3.6	15.207	AC Conducted Emission	15.207(a)	Pass	Under limit 8.30 dB at 3.126 MHz, 3.286 MHz, and 3.262 MHz
3.7	15.203 & 15.247(b)	Antenna Requirement	N/A	Pass	-



1 General Description

1.1 Applicant

Sony Mobile Communications Inc.

4-12-3 Higashi-Shinagawa, Shinagawa-ku, Tokyo, 140-0002, Japan

1.2 Manufacturer

Sony Mobile Communications Inc.

4-12-3 Higashi-Shinagawa, Shinagawa-ku, Tokyo, 140-0002, Japan

1.3 Product Feature of Equipment Under Test

GSM/WCDMA/LTE, Bluetooth, DTS/UNII a/b/g/n, FM Receiver, NFC, and GPS.

Product Specification subjective to this standard	
Antenna Type	PIFA Antenna with gain -1.20 dBi

EUT Information List			
HW Version	SW Version	S/N	Performed Test Item
A	1.8	WUJ01Q223V	RF conducted measurement
		WUJ01Q2211	Radiated Spurious Emission
		WUJ01Q223T	AC Conducted Emission



Accessory List	
AC Adapter	Model Name: EP800
	S/N: 2916W46610569 (for radiated emission) 3015W41612282 (for conducted emission)
Earphone	Model Name: MH410c
	S/N: N/A
USB Cable	Model Name: UCB20
	S/N: 1635A91C00314D8 (for radiated emission) 1635A9100031498 (for conducted emission)

Note:

1. Above EUT list and accessory list used are electrically identical per declared by manufacturer.
2. Above the accessories list are used to exercise the EUT during test.
3. For other wireless features of this EUT, test report will be issued separately.

1.4 Modification of EUT

No modifications are made to the EUT during all test items.



1.5 Testing Location

Sporton Lab is accredited to ISO 17025 by Taiwan Accreditation Foundation (TAF code : 1190) and the FCC designation No. TW1190 and TW0007 under the FCC 2.948(e) by Mutual Recognition Agreement (MRA) in FCC Test.

Test Site	SPORTON INTERNATIONAL INC.	
Test Site Location	No. 52, Hwa Ya 1 st Rd., Hwa Ya Technology Park, Kwei-Shan District, Tao Yuan City, Taiwan, R.O.C. TEL: +886-3-327-3456 FAX: +886-3-328-4978	
Test Site No.	Sporton Site No.	
	TH05-HY	CO05-HY

Note: The test site complies with ANSI C63.4 2014 requirement.

Test Site	SPORTON INTERNATIONAL INC.	
Test Site Location	No.58, Aly. 75, Ln. 564, Wenhua 3rd Rd. Guishan Dist, Taoyuan City, Taiwan (R.O.C.) TEL: +886-3-327-0868 FAX: +886-3-327-0855	
Test Site No.	Sporton Site No.	
	03CH10-HY	

Note: The test site complies with ANSI C63.4 2014 requirement.

1.6 Applicable Standards

According to the specifications of the manufacturer, the EUT must comply with the requirements of the following standards:

- ♦ FCC Part 15 Subpart C §15.247
- ♦ FCC KDB Publication No. 558074 D01 DTS Meas. Guidance v04
- ♦ ANSI C63.10-2013

Remark:

1. All test items were verified and recorded according to the standards and without any deviation during the test.
2. This EUT has also been tested and complied with the requirements of FCC Part 15, Subpart B, recorded in a separate test report.



2 Test Configuration of Equipment Under Test

- a. The EUT has been associated with peripherals and configuration operated in a manner tended to maximize its emission characteristics in a typical application. Frequency range investigated: conduction emission (150 kHz to 30 MHz), radiation emission (9 kHz to the 10th harmonic of the highest fundamental frequency or to 40 GHz, whichever is lower). For radiated measurement, pre-scanned in three orthogonal panels, X, Y, Z. The worst cases (X plane) were recorded in this report.

- b. AC power line Conducted Emission was tested under maximum output power.

2.1 Carrier Frequency and Channel

Frequency Band	Channel	Freq. (MHz)	Channel	Freq. (MHz)
2400-2483.5 MHz	1	2412	7	2442
	2	2417	8	2447
	3	2422	9	2452
	4	2427	10	2457
	5	2432	11	2462
	6	2437	-	-



2.2 Test Mode

Final test mode of conducted test items and radiated spurious emissions are considering the modulation and worse data rates as below table.

Modulation	Data Rate
802.11b	1 Mbps
802.11g	6 Mbps
802.11n HT20	MCS0

Test Cases	
AC Conducted Emission	Mode 1: Bluetooth Link + WLAN (2.4GHz) Link + Earphone + Battery + USB Cable (Charging from Adapter)

2.3 Connection Diagram of Test System

<WLAN Tx Mode>

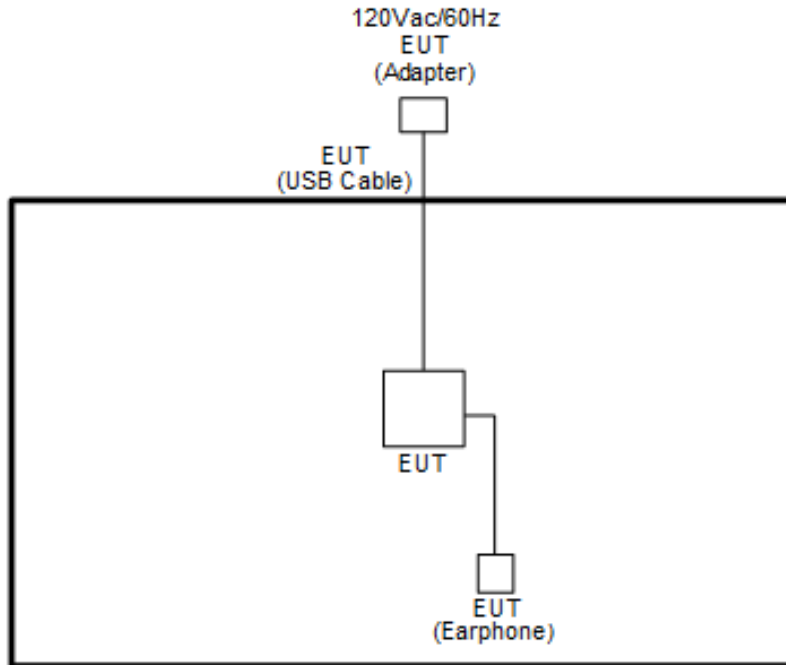

<AC Conducted Emission Mode>

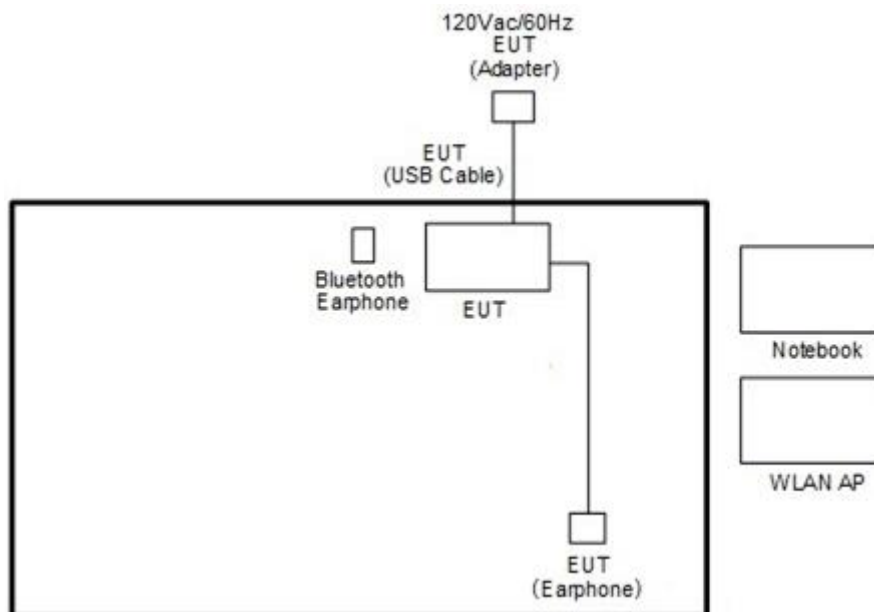



2.4 Support Unit used in test configuration and system

Item	Equipment	Trade Name	Model Name	FCC ID	Data Cable	Power Cord
1.	Bluetooth Earphone	Sony	SBH20	PY7-RD0010	N/A	N/A
2.	WLAN AP	ASUS	RT-AC66U	MSQ-RTAC66U	N/A	Unshielded,1.8m
3.	Notebook	DELL	Latitude E6320	FCC DoC/ Contains FCC ID: QDS-BRCM1054	N/A	AC I/P: Unshielded, 1.2 m DC O/P: Shielded, 1.8 m
4.	SD Card	SanDisk	MicroSD HC	FCC DoC	N/A	N/A

2.5 EUT Operation Test Setup

For RF test items, an engineering test program was provided and enabled to make EUT transmitting signals.

2.6 Measurement Results Explanation Example

For all conducted test items:

The offset level is set in the spectrum analyzer to compensate the RF cable loss and attenuator factor between EUT conducted output port and spectrum analyzer. With the offset compensation, the spectrum analyzer reading level is exactly the EUT RF output level.

Example :

The spectrum analyzer offset is derived from RF cable loss and attenuator factor.

Offset = RF cable loss + attenuator factor.

Following shows an offset computation example with cable loss 4.2 dB and 10dB attenuator.

$$\begin{aligned}
 \text{Offset(dB)} &= \text{RF cable loss(dB)} + \text{attenuator factor(dB)}. \\
 &= 4.2 + 10 = 14.2 \text{ (dB)}
 \end{aligned}$$

3 Test Result

3.1 6dB and 99% Bandwidth Measurement

3.1.1 Limit of 6dB and 99% Bandwidth

The minimum 6 dB bandwidth shall be at least 500 kHz.

3.1.2 Measuring Instruments

The measuring equipment is listed in the section 4 of this test report.

3.1.3 Test Procedures

1. The testing follows FCC KDB Publication No. 558074 DTS D01 Meas. Guidance v04.
2. The RF output of EUT was connected to the spectrum analyzer by RF cable and attenuator. The path loss was compensated to the results for each measurement.
3. Set to the maximum power setting and enable the EUT transmit continuously.
4. Make the measurement with the spectrum analyzer's resolution bandwidth (RBW) = 100 kHz. Set the Video bandwidth (VBW) = 300 kHz. In order to make an accurate measurement. The 6 dB bandwidth must be greater than 500 kHz.
5. For 99% Bandwidth Measurement, the spectrum analyzer's resolution bandwidth (RBW) = 1MHz and set the Video bandwidth (VBW) = 3MHz.
6. Measure and record the results in the test report.

3.1.4 Test Setup





3.1.5 Test Result of 6dB and 99% Occupied Bandwidth

Please refer to Appendix A.

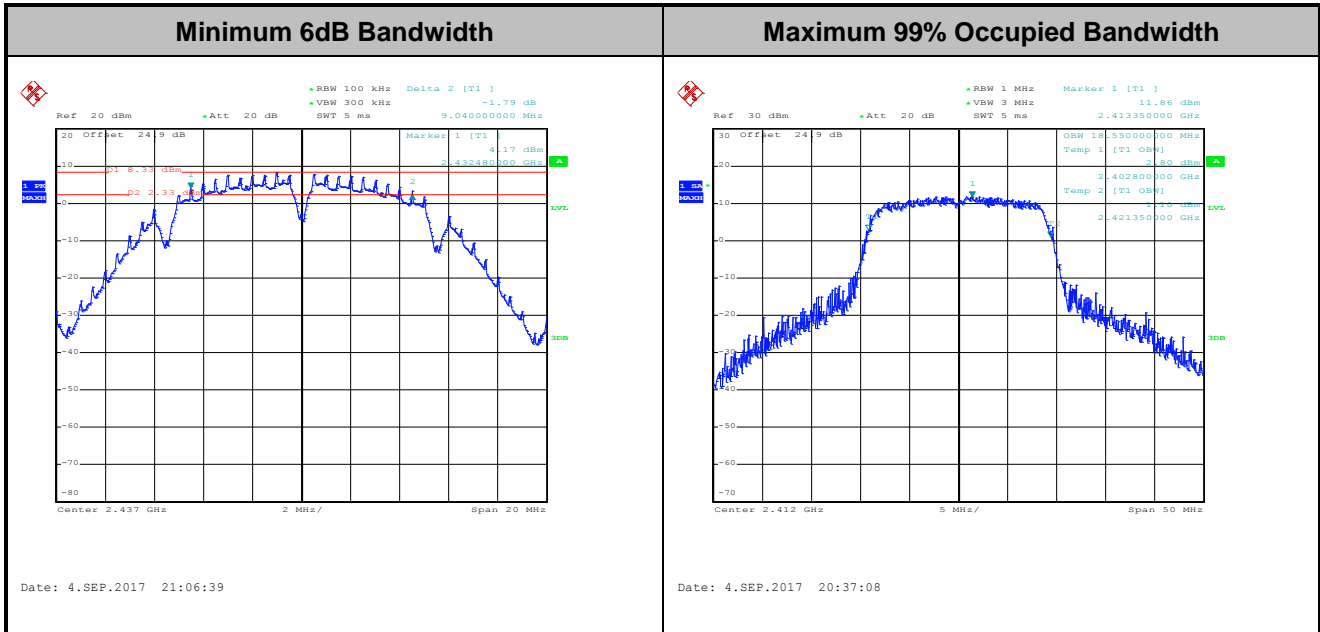

Note : The occupied channel bandwidth is maintained within the band of operation for all of the modulations.

3.2 Output Power Measurement

3.2.1 Limit of Output Power

For systems using digital modulation in the 2400-2483.5MHz, the limit for peak output power is 30dBm. If transmitting antenna of directional gain greater than 6dBi are used the peak output power from the intentional radiator shall be reduced below the above stated value by the amount in dB that the directional gain of the antenna exceeds 6 dBi. In case of point-to-point operation, the limit has to be reduced by 1dB for every 3dB that the directional gain of the antenna exceeds 6dBi.

3.2.2 Measuring Instruments

The measuring equipment is listed in the section 4 of this test report.

3.2.3 Test Procedures

1. The testing follows the Measurement Procedure of FCC KDB No. 558074 DTS D01 Meas. Guidance v04 section 9.1.3 PKPM1 Peak power meter method.
2. The RF output of EUT was connected to the power meter by RF cable and attenuator. The path loss was compensated to the results for each measurement.
3. Set to the maximum power setting and enable the EUT transmit continuously.
4. Measure the conducted output power and record the results in the test report.

3.2.4 Test Setup

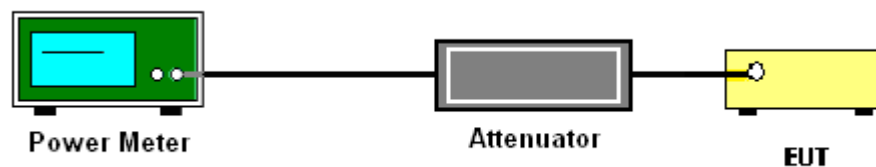

3.2.5 Test Result of Peak Output Power

Please refer to Appendix A.

3.2.6 Test Result of Average output Power (Reporting Only)

Please refer to Appendix A.

3.3 Power Spectral Density Measurement

3.3.1 Limit of Power Spectral Density

The peak power spectral density shall not be greater than 8dBm in any 3kHz band at any time interval of continuous transmission.

3.3.2 Measuring Instruments

The measuring equipment is listed in the section 4 of this test report.

3.3.3 Test Procedures

1. The testing follows Measurement Procedure 10.2 Method PKPSD of FCC KDB Publication No. 558074 D01 DTS Meas. Guidance v04
2. The RF output of EUT was connected to the spectrum analyzer by RF cable and attenuator. The path loss was compensated to the results for each measurement.
3. Set to the maximum power setting and enable the EUT transmit continuously.
4. Make the measurement with the spectrum analyzer's resolution bandwidth (RBW) = 3 kHz. Video bandwidth VBW = 10 kHz In order to make an accurate measurement, set the span to 1.5 times DTS Channel Bandwidth. (6dB BW)
5. Detector = peak, Sweep time = auto couple, Trace mode = max hold, Allow trace to fully stabilize. Use the peak marker function to determine the maximum power level.
6. Measure and record the results in the test report.

3.3.4 Test Setup

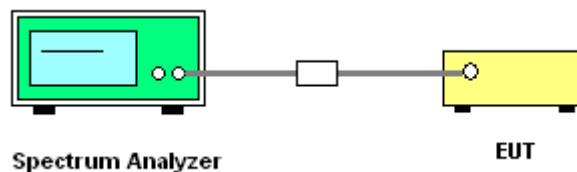



3.3.5 Test Result of Power Spectral Density

Please refer to Appendix A.

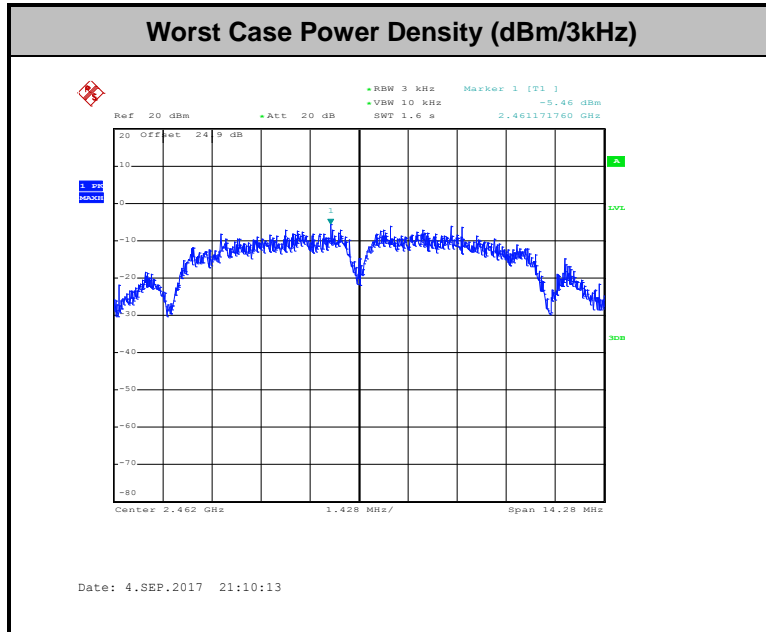

3.4 Conducted Band Edges and Spurious Emission Measurement

3.4.1 Limit of Conducted Band Edges and Spurious Emission Measurement

In any 100 kHz bandwidth outside of the authorized frequency band, the emissions which fall in the non-restricted bands shall be attenuated at least 20 dB / 30dB relative to the maximum PSD level in 100 kHz by RF conducted measurement.

3.4.2 Measuring Instruments

The measuring equipment is listed in the section 4 of this test report.

3.4.3 Test Procedures

1. The testing follows FCC KDB Publication No. 558074 D01 DTS Meas. Guidance v04.
2. The RF output of EUT was connected to the spectrum analyzer by RF cable and attenuator. The path loss was compensated to the results for each measurement.
3. Set to the maximum power setting and enable the EUT transmit continuously.
4. Set RBW = 100 kHz, VBW=300 kHz, Peak Detector. Unwanted Emissions measured in any 100 kHz bandwidth outside of the authorized frequency band shall be attenuated by at least 20 dB relative to the maximum in-band peak PSD level in 100 kHz when maximum peak conducted output power procedure is used. If the transmitter complies with the conducted power limits based on the use of RMS averaging over a time interval, the attenuation required under this paragraph shall be 30 dB instead of 20 dB.
5. Measure and record the results in the test report.
6. The RF fundamental frequency should be excluded against the limit line in the operating frequency band.

3.4.4 Test Setup

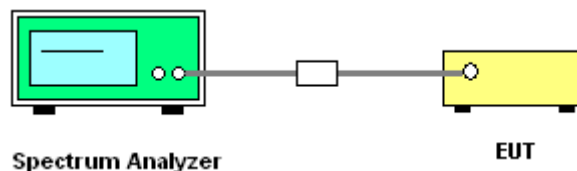



3.4.5 Test Result of Conducted Band Edges and Spurious Emission

Test Mode :	802.11b	Temperature :	21~25°C
Test Band :	2.4GHz Low	Relative Humidity :	51~54%
Test Channel :	01	Test Engineer :	Allen Lin, Shiming Liu and Aking chang

WLAN 802.11b Channel 01

100kHz PSD reference Level

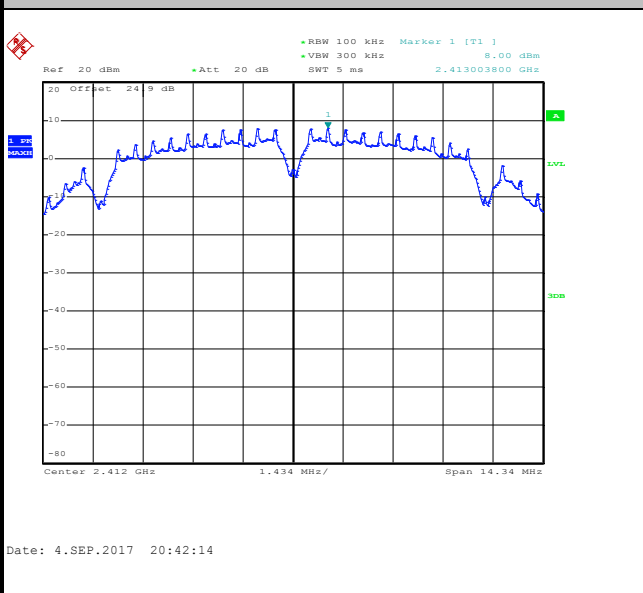

Low Channel Plot

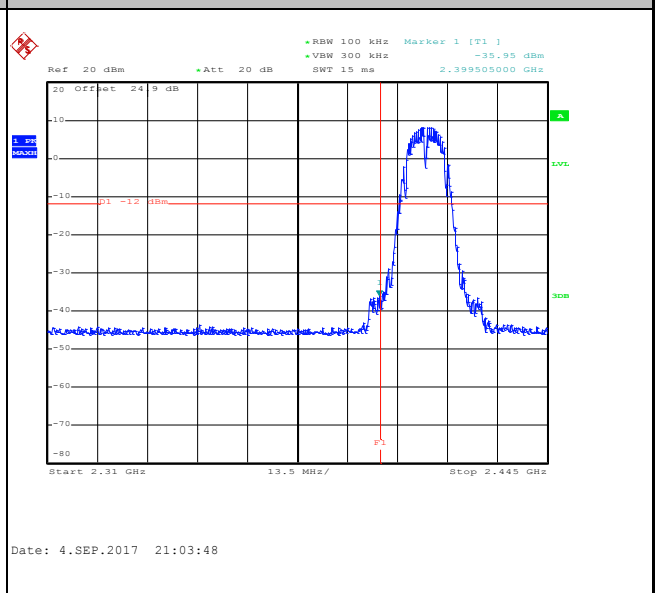

Spurious Emission 30MHz~3GHz

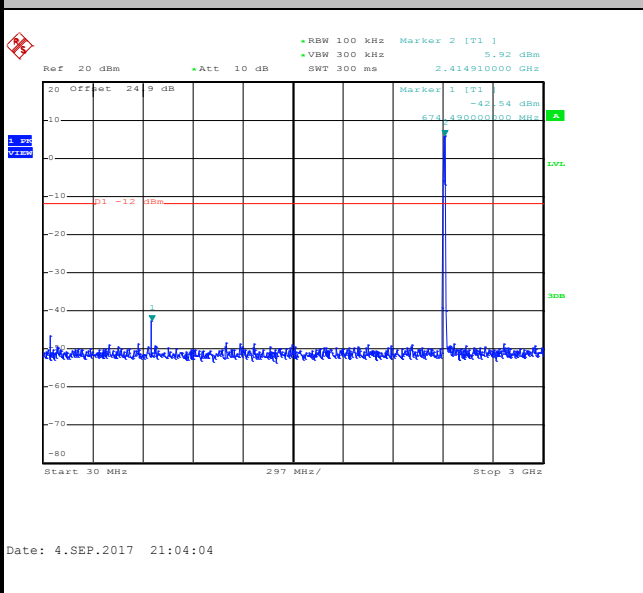

Spurious Emission 2GHz~25GHz

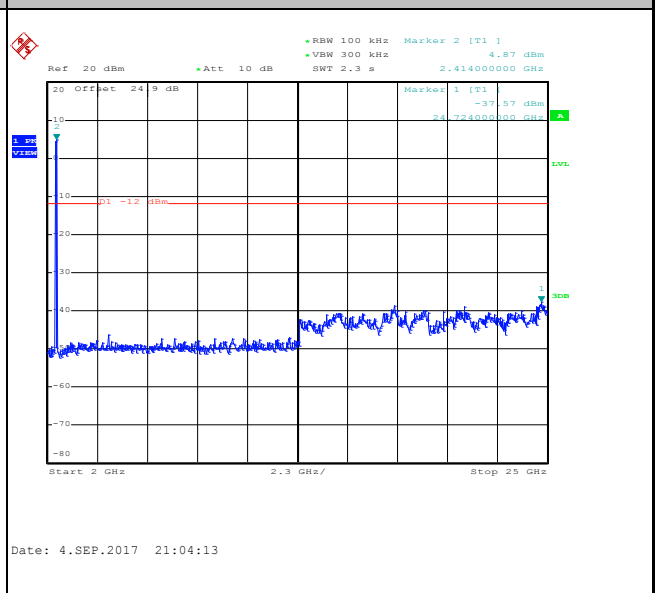



Test Mode :	802.11b	Temperature :	21~25°C
Test Band :	2.4GHz Mid	Relative Humidity :	51~54%
Test Channel :	06	Test Engineer :	Allen Lin, Shiming Liu and Aking chang

WLAN 802.11b Channel 06

100kHz PSD reference Level

Mid Channel Plot

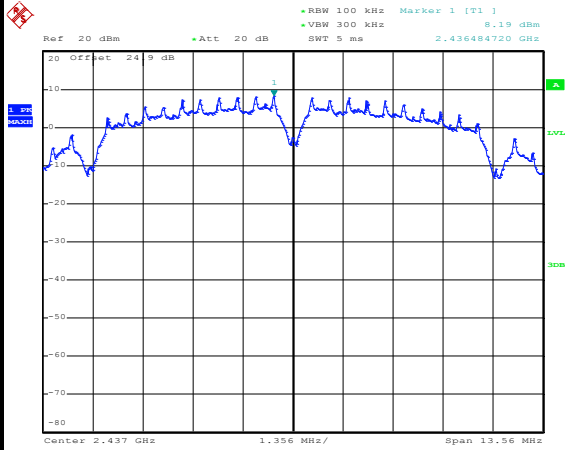

Date: 4.SEP.2017 21:07:09

Spurious Emission 30MHz~3GHz

Spurious Emission 2GHz~25GHz

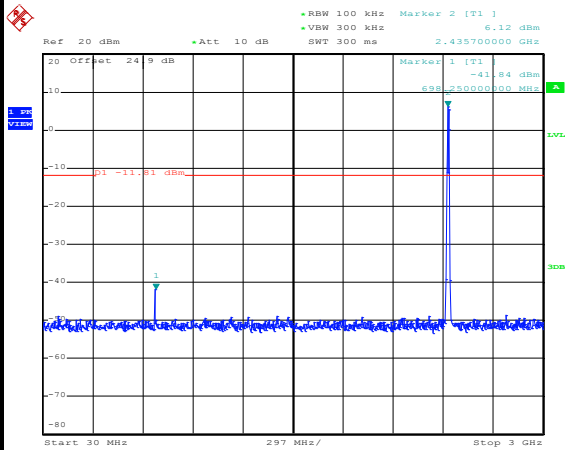

Date: 22.SEP.2017 13:49:32

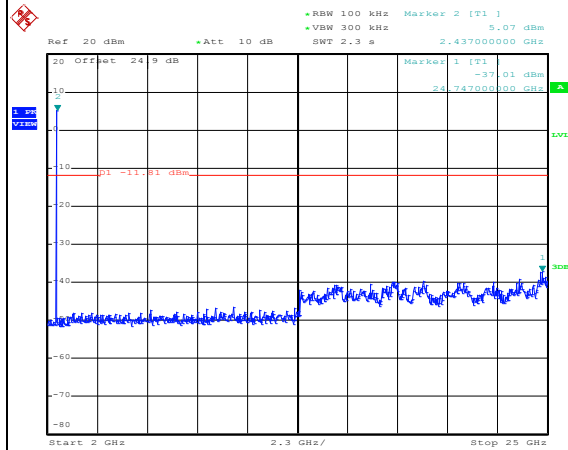

Date: 22.SEP.2017 13:49:41



Test Mode :	802.11b	Temperature :	21~25°C
Test Band :	2.4GHz High	Relative Humidity :	51~54%
Test Channel :	11	Test Engineer :	Allen Lin, Shiming Liu and Aking chang

WLAN 802.11b Channel 11

100kHz PSD reference Level

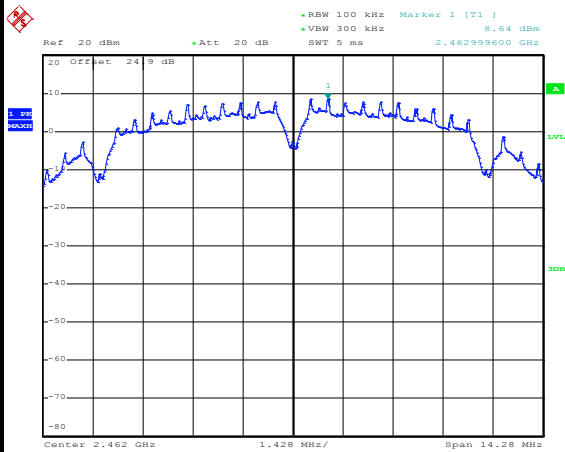

Date: 4.SEP.2017 21:10:25

High Channel Plot

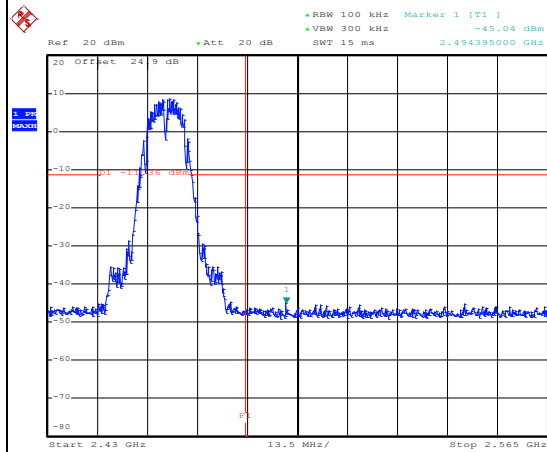

Date: 4.SEP.2017 21:10:52

Spurious Emission 30MHz~3GHz

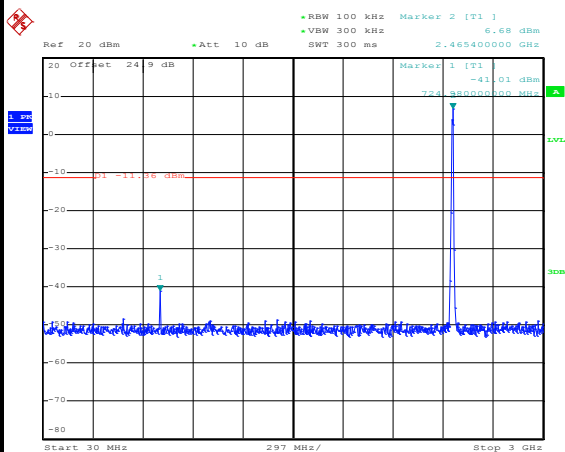

Date: 4.SEP.2017 21:11:15

Spurious Emission 2GHz~25GHz

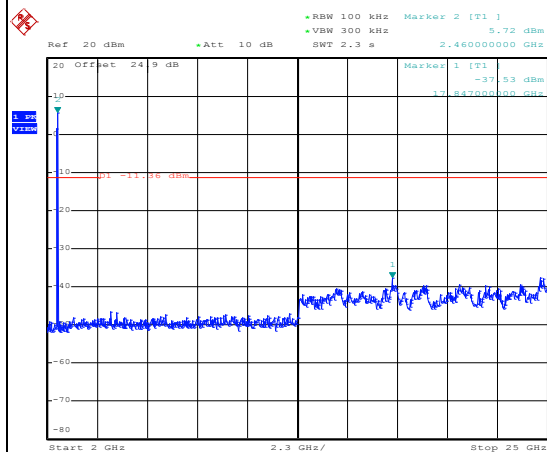

Date: 4.SEP.2017 21:11:23



Test Mode :	802.11g	Temperature :	21~25°C
Test Band :	2.4GHz Low	Relative Humidity :	51~54%
Test Channel :	01	Test Engineer :	Allen Lin, Shiming Liu and Aking chang

WLAN 802.11g Channel 01

100kHz PSD reference Level

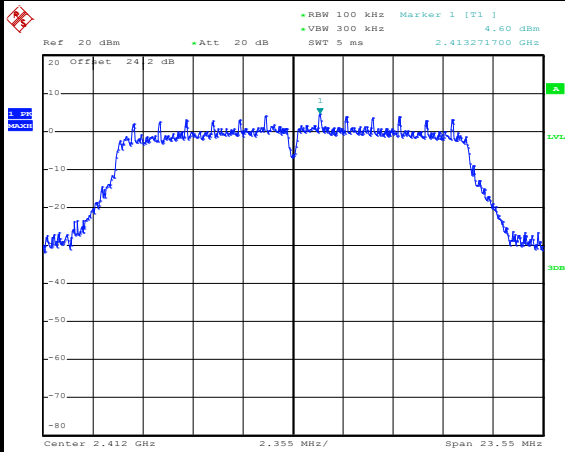

Date: 29.AUG.2017 05:17:18

Low Channel Plot

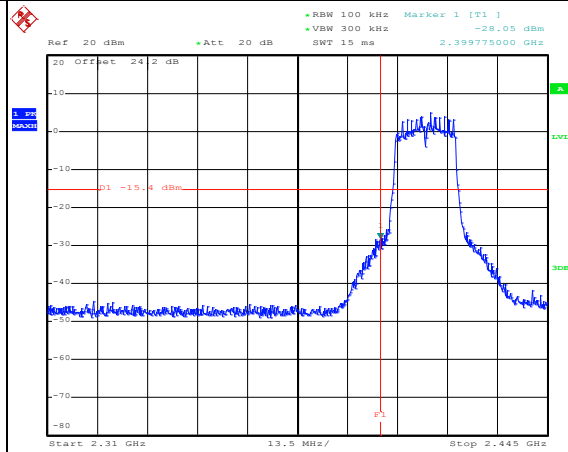

Date: 29.AUG.2017 05:17:47

Spurious Emission 30MHz~3GHz

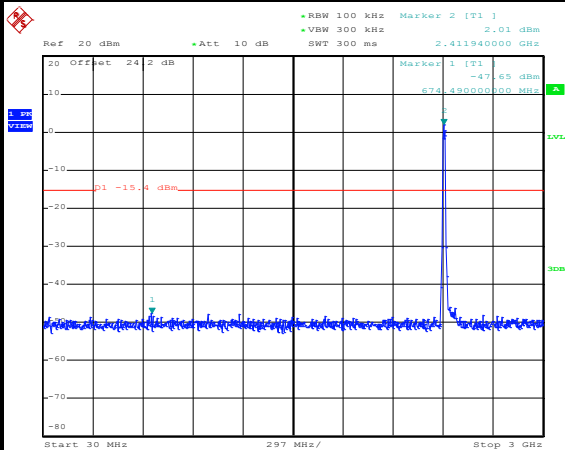

Date: 29.AUG.2017 05:17:58

Spurious Emission 2GHz~25GHz

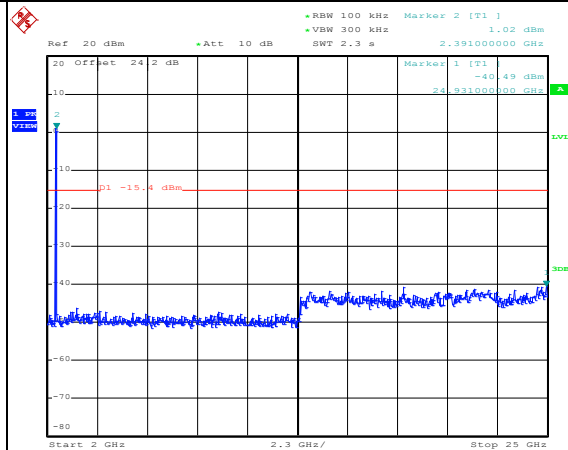

Date: 29.AUG.2017 05:18:07



Test Mode :	802.11g	Temperature :	21~25°C
Test Band :	2.4GHz Mid	Relative Humidity :	51~54%
Test Channel :	06	Test Engineer :	Allen Lin, Shiming Liu and Aking chang

WLAN 802.11g Channel 06

100kHz PSD reference Level

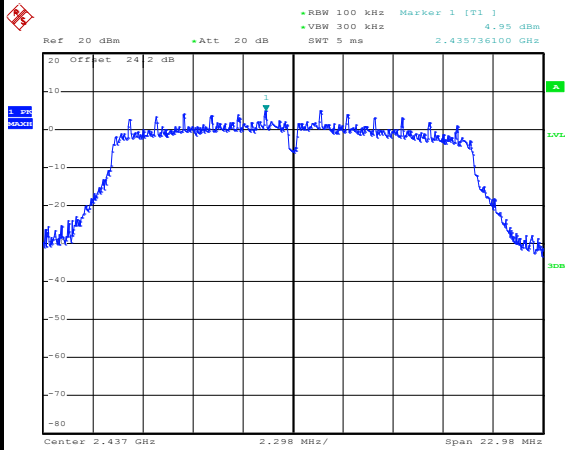

Date: 29.AUG.2017 05:21:29

Mid Channel Plot

Spurious Emission 30MHz~3GHz

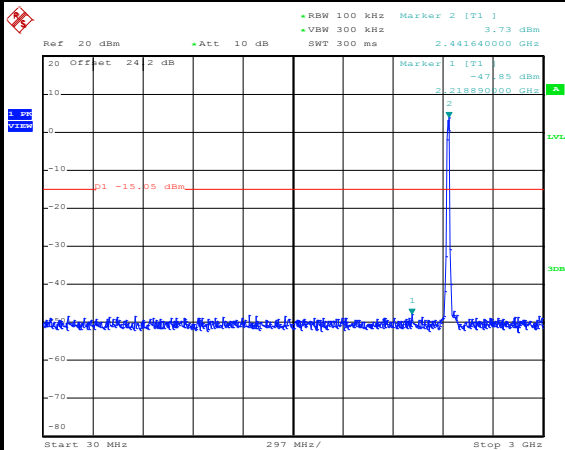

Date: 29.AUG.2017 05:22:02

Spurious Emission 2GHz~25GHz

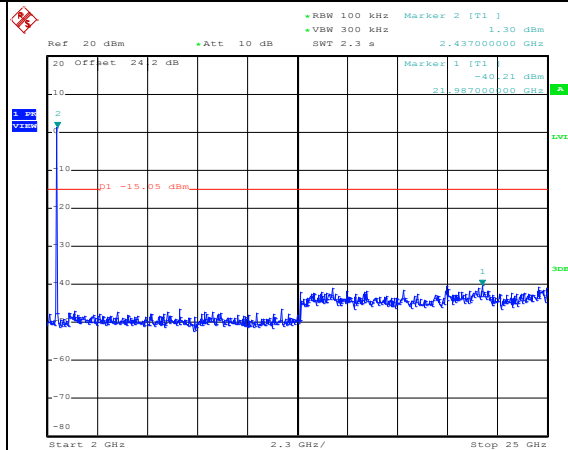

Date: 29.AUG.2017 05:22:11



Test Mode :	802.11g	Temperature :	21~25°C
Test Band :	2.4GHz High	Relative Humidity :	51~54%
Test Channel :	11	Test Engineer :	Allen Lin, Shiming Liu and Aking chang

WLAN 802.11g Channel 11

100kHz PSD reference Level

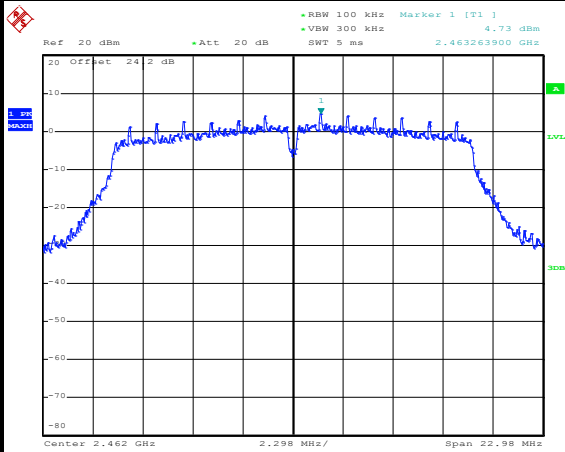

Date: 29.AUG.2017 05:28:49

High Channel Plot

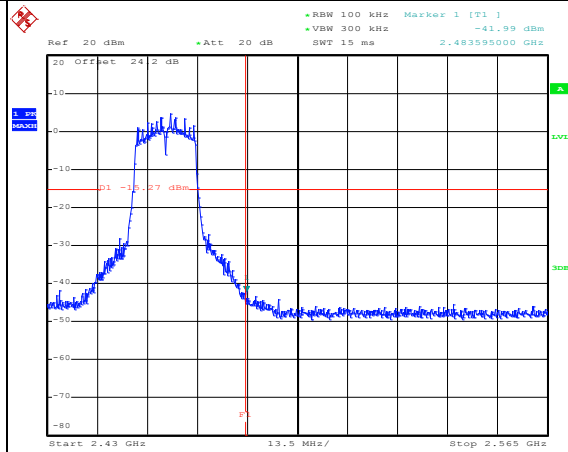

Date: 29.AUG.2017 05:29:34

Spurious Emission 30MHz~3GHz

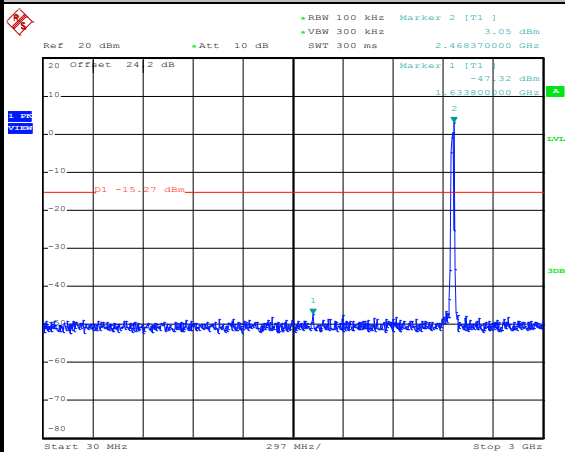

Date: 29.AUG.2017 05:29:58

Spurious Emission 2GHz~25GHz

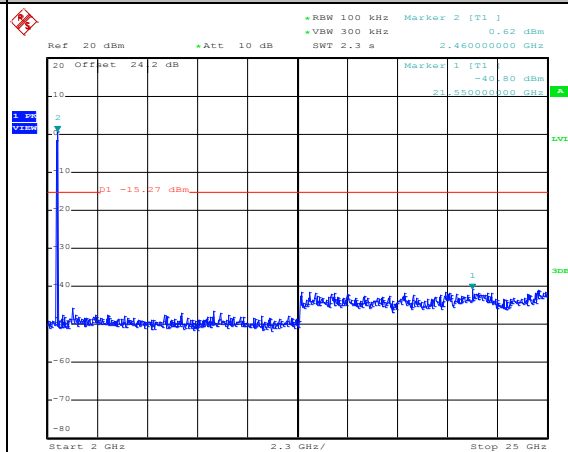

Date: 29.AUG.2017 05:30:07



Test Mode :	802.11n HT20	Temperature :	21~25°C
Test Band :	2.4GHz Low	Relative Humidity :	51~54%
Test Channel :	01	Test Engineer :	Allen Lin, Shiming Liu and Aking chang

WLAN 802.11n HT20 Channel 01

100kHz PSD reference Level

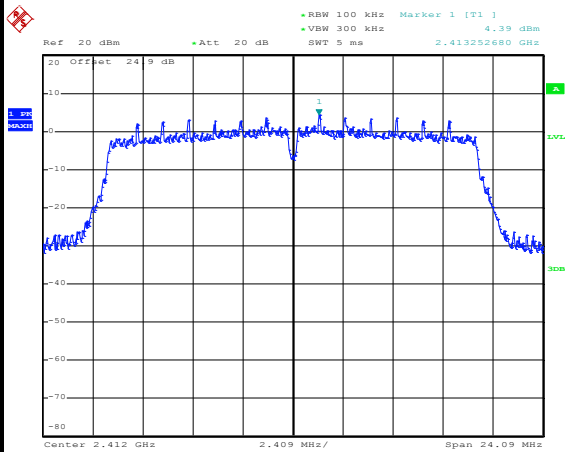

Date: 4.SEP.2017 20:35:57

Low Channel Plot

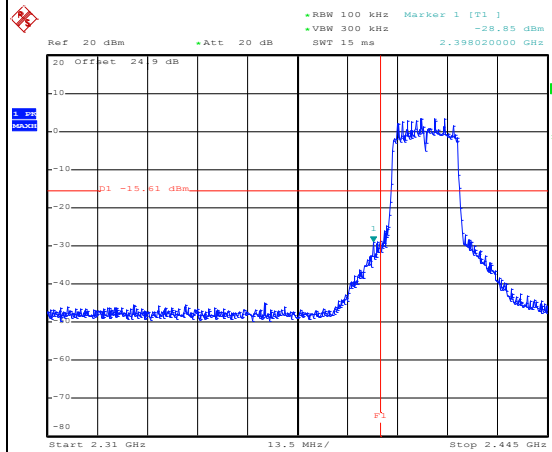

Date: 4.SEP.2017 20:36:12

Spurious Emission 30MHz~3GHz

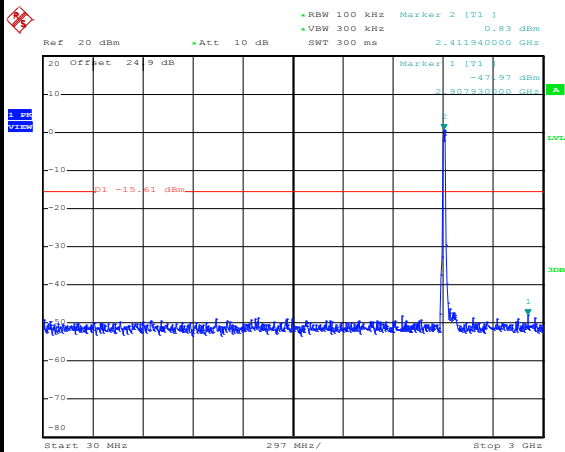

Date: 4.SEP.2017 20:36:23

Spurious Emission 2GHz~25GHz

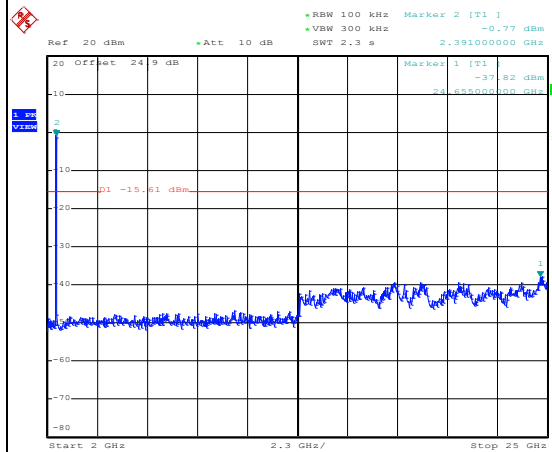

Date: 4.SEP.2017 20:36:32



Test Mode :	802.11n HT20	Temperature :	21~25°C
Test Band :	2.4GHz Mid	Relative Humidity :	51~54%
Test Channel :	06	Test Engineer :	Allen Lin, Shiming Liu and Aking chang

WLAN 802.11n HT20 Channel 06

100kHz PSD reference Level

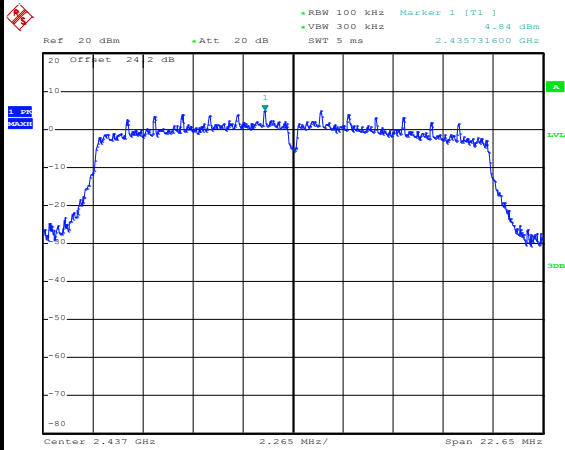

Date: 29.AUG.2017 05:38:12

Mid Channel Plot

Spurious Emission 30MHz~3GHz

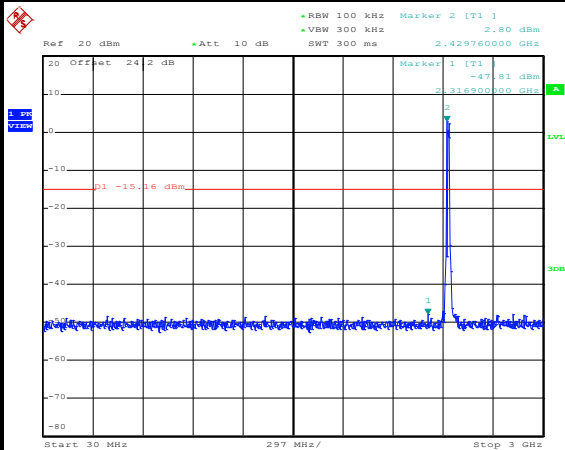

Date: 29.AUG.2017 05:38:25

Spurious Emission 2GHz~25GHz

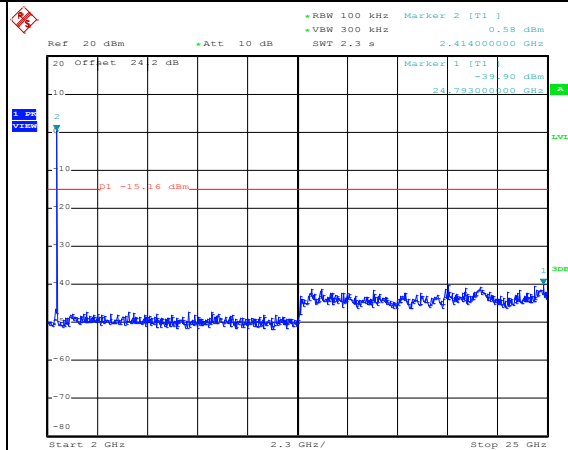

Date: 29.AUG.2017 05:38:34



Test Mode :	802.11n HT20	Temperature :	21~25°C
Test Band :	2.4GHz High	Relative Humidity :	51~54%
Test Channel :	11	Test Engineer :	Allen Lin, Shiming Liu and Aking chang

WLAN 802.11n HT20 Channel 11

100kHz PSD reference Level

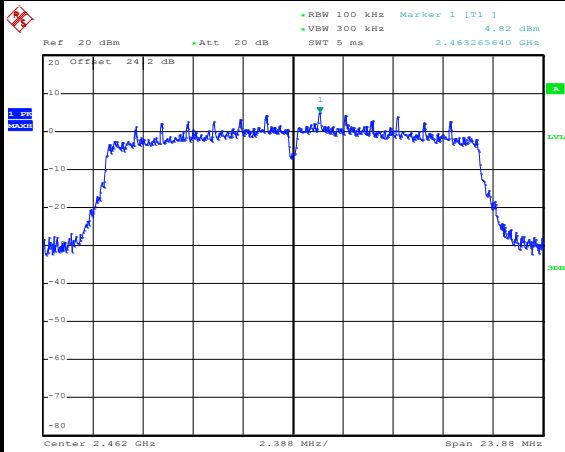

Date: 29.AUG.2017 05:41:19

High Channel Plot

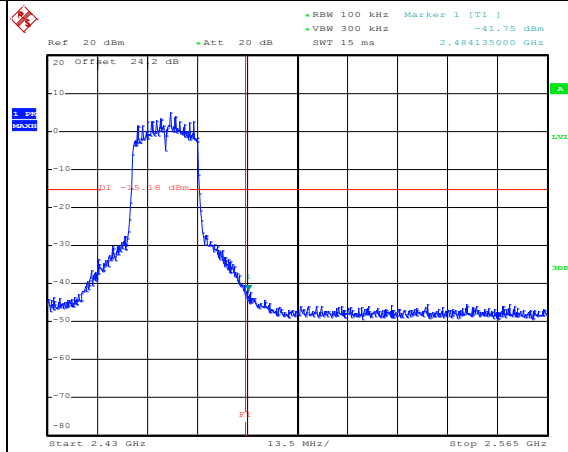

Date: 29.AUG.2017 05:41:58

Spurious Emission 30MHz~3GHz

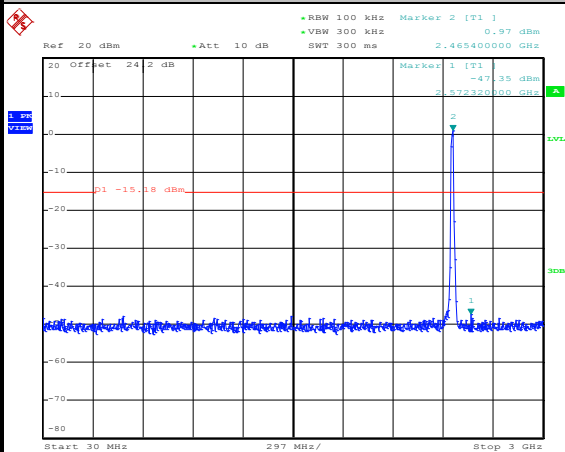

Date: 29.AUG.2017 05:42:14

Spurious Emission 2GHz~25GHz

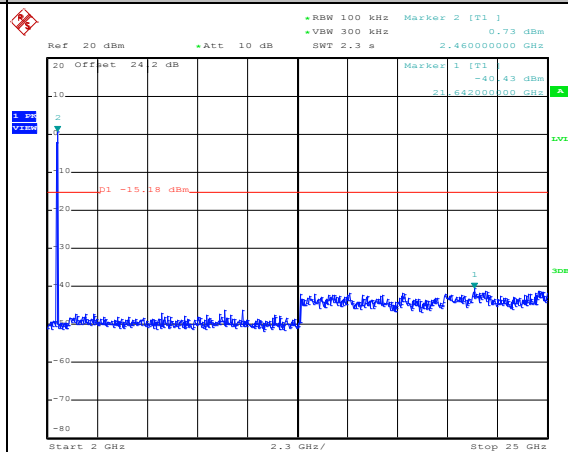

Date: 29.AUG.2017 05:42:23



3.5 Radiated Band Edges and Spurious Emission Measurement

3.5.1 Limit of Radiated band edge and Spurious Emission Measurement

In any 100 kHz bandwidth outside the intentional radiator frequency band, all harmonics/spurious must be at least 20 dB below the highest emission level within the authorized band. If the output power of this device was measured by spectrum analyzer, the attenuation under this paragraph shall be 30 dB instead of 20 dB. In addition, radiated emissions which fall in the restricted bands must also comply with the limits as below.

Frequency (MHz)	Field Strength (microvolts/meter)	Measurement Distance (meters)
0.009 – 0.490	2400/F(kHz)	300
0.490 – 1.705	24000/F(kHz)	30
1.705 – 30.0	30	30
30 – 88	100	3
88 – 216	150	3
216 - 960	200	3
Above 960	500	3

3.5.2 Measuring Instruments

The measuring equipment is listed in the section 4 of this test report.



3.5.3 Test Procedures

1. The testing follows FCC KDB Publication No. 558074 D01 DTS Meas. Guidance v04.
2. The EUT was arranged to its worst case and then tune the antenna tower (from 1 m to 4 m) and turntable (from 0 degree to 360 degrees) to find the maximum reading. A pre-amp and a high pass filter are used for the test in order to get better signal level.
3. The EUT was placed on a turntable with 0.8 meter for frequency below 1GHz and 1.5 meter for frequency above 1GHz respectively above ground.
4. The EUT was set 3 meters from the interference receiving antenna, which was mounted on the top of a variable height antenna tower.
5. Corrected Reading: Antenna Factor + Cable Loss + Read Level - Preamp Factor = Level
6. For testing below 1GHz, if the emission level of the EUT in peak mode was 3 dB lower than the limit specified, then peak values of EUT will be reported, otherwise, the emissions will be repeated one by one using the CISPR quasi-peak method and reported.
7. For testing above 1GHz, the emission level of the EUT in peak mode was 20dB lower than average limit (that means the emission level in average mode also complies with the limit in average mode), then peak values of EUT will be reported, otherwise, the emissions will be measured in average mode again and reported.
8. Use the following spectrum analyzer settings:
 - (1) Span shall wide enough to fully capture the emission being measured;
 - (2) Set RBW=100 kHz for $f < 1$ GHz; VBW \geq RBW; Sweep = auto; Detector function = peak; Trace = max hold;
 - (3) Set RBW = 1 MHz, VBW= 3MHz for $f \geq 1$ GHz for peak measurement.
For average measurement:
 - VBW = 10 Hz, when duty cycle is no less than 98 percent.
 - VBW $\geq 1/T$, when duty cycle is less than 98 percent where T is the minimum transmission duration over which the transmitter is on and is transmitting at its maximum power control level for the tested mode of operation.

3.5.4 Test Setup

For radiated emissions below 30MHz



For radiated emissions from 30MHz to 1GHz

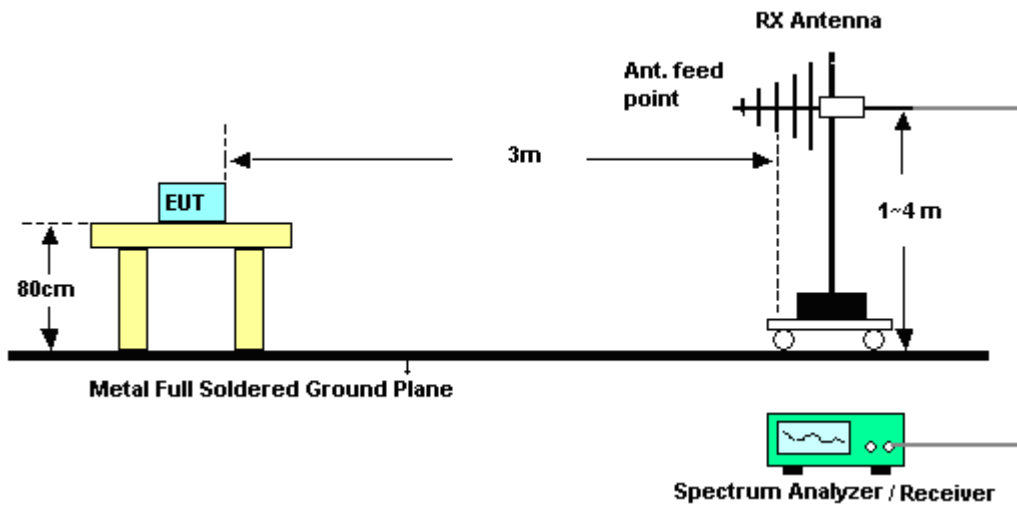

For radiated emissions above 1GHz

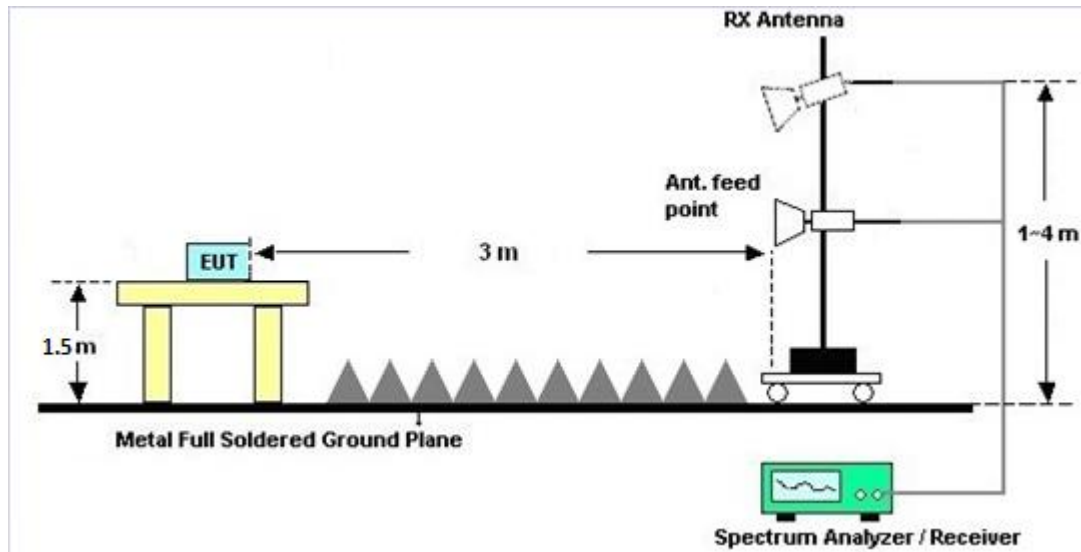

3.5.5 Test Results of Radiated Spurious Emissions (9kHz ~ 30MHz)

The low frequency, which started from 9 kHz to 30MHz, was pre-scanned and the result which was 20dB lower than the limit line was not reported.

There is a comparison data of both open-field test site and semi-Anechoic chamber, and the result came out very similar.

3.5.6 Test Result of Radiated Spurious at Band Edges

Please refer to Appendix C and D.

3.5.7 Duty Cycle

Please refer to Appendix E.

3.5.8 Test Result of Radiated Spurious Emission (30MHz ~ 10th Harmonic)

Please refer to Appendix C and D.



3.6 AC Conducted Emission Measurement

3.6.1 Limit of AC Conducted Emission

For equipment that is designed to be connected to the public utility (AC) power line, the radio frequency voltage that is conducted back onto the AC power line on any frequency or frequencies within the band 150 kHz to 30 MHz shall not exceed the limits in the following table.

Frequency of Emission (MHz)	Conducted Limit (dB μ V)	
	Quasi-Peak	Average
0.15-0.5	66 to 56*	56 to 46*
0.5-5	56	46
5-30	60	50

*Decreases with the logarithm of the frequency.

3.6.2 Measuring Instruments

The measuring equipment is listed in the section 4 of this test report.

3.6.3 Test Procedures

1. The EUT was placed 0.4 meter from the conducting wall of the shielding room, and it was kept at least 80 centimeters from any other grounded conducting surface.
2. Connect EUT to the power mains through a line impedance stabilization network (LISN).
3. All the support units are connecting to the other LISN.
4. The LISN provides 50 ohm coupling impedance for the measuring instrument.
5. The FCC states that a 50 ohm, 50 microhenry LISN should be used.
6. Both sides of AC line were checked for maximum conducted interference.
7. The frequency range from 150 kHz to 30 MHz was searched.
8. Set the test-receiver system to Peak Detect Function and specified bandwidth (IF bandwidth = 9kHz) with Maximum Hold Mode.

3.6.4 Test Setup

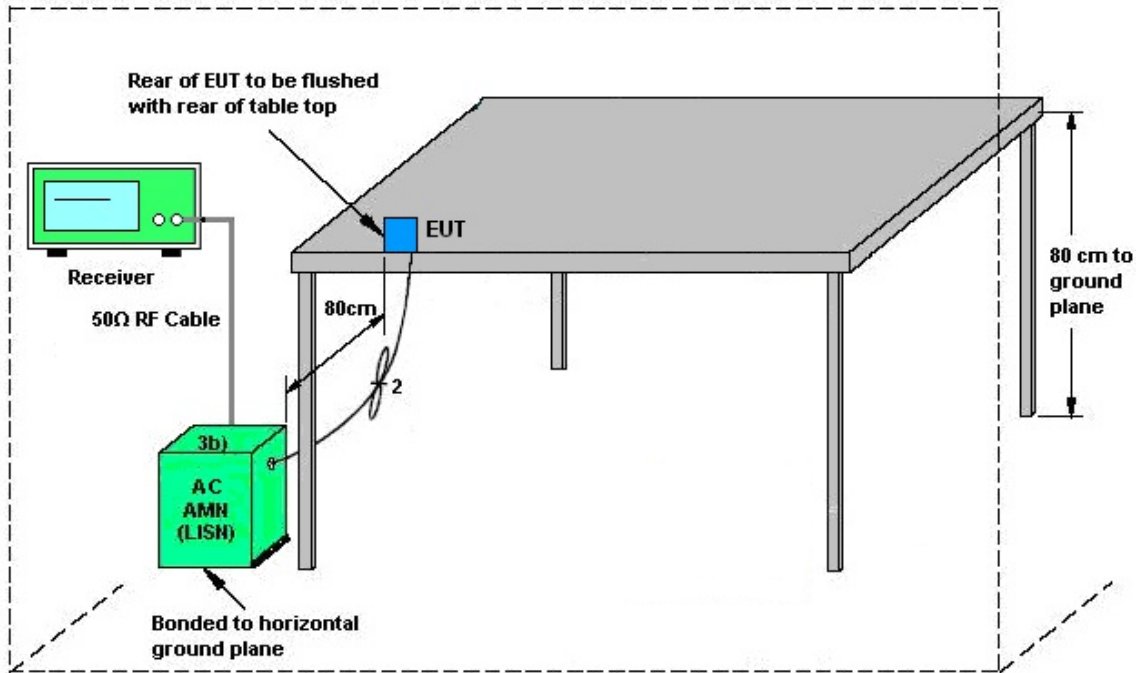

AMN = Artificial mains network (LISN)
 AE = Associated equipment
 EUT = Equipment under test
 ISN = Impedance stabilization network

3.6.5 Test Result of AC Conducted Emission

Please refer to Appendix B.



3.7 Antenna Requirements

3.7.1 Standard Applicable

If directional gain of transmitting antennas is greater than 6dBi, the power shall be reduced by the same level in dB comparing to gain minus 6dBi. The use of a permanently attached antenna or of an antenna that uses a unique coupling to the intentional radiator shall be considered sufficient to comply with the rule.

3.7.2 Antenna Anti-Replacement Construction

An embedded-in antenna design is used.

3.7.3 Antenna Gain

The antenna peak gain of EUT is less than 6 dBi. Therefore, it is not necessary to reduce maximum peak output power limit.



4 List of Measuring Equipment

Instrument	Manufacturer	Model No.	Serial No.	Characteristics	Calibration Date	Test Date	Due Date	Remark
Power Meter	Anritsu	ML2495A	0932001	N/A	Sep. 29, 2016	Aug. 24, 2017~ Sep. 04, 2017	Sep. 28, 2017	Conducted (TH05-HY)
Power Sensor	Anritsu	MA2411B	0846202	300MHz~40GHz z	Sep. 29, 2016	Aug. 24, 2017~ Sep. 04, 2017	Sep. 28, 2017	Conducted (TH05-HY)
Spectrum Analyzer	Rohde & Schwarz	FSP30	101067	9kHz ~ 30GHz	Nov. 17, 2016	Aug. 24, 2017~ Sep. 04, 2017	Nov. 16, 2017	Conducted (TH05-HY)
Hygrometer	TECEPEL	DTM-303B	TP157151	N/A	Mar. 20, 2017	Aug. 24, 2017~ Sep. 04, 2017	Mar. 19, 2018	Conducted (TH05-HY)
RF Cable	HUBER + SUHNER	SUCOFLEX 104	MY842095 21	1GHz~26GHz	Dec. 02, 2016	Aug. 24, 2017~ Sep. 04, 2017	Dec. 01, 2017	Conducted (TH05-HY)
AC Power Source	ChainTek	APC-1000W	N/A	N/A	N/A	Aug. 26, 2017	N/A	Conduction (CO05-HY)
EMI Test Receiver	Rohde & Schwarz	ESCI 7	100724	9kHz~7GHz	Aug. 30, 2016	Aug. 26, 2017	Aug. 29, 2017	Conduction (CO05-HY)
Hygrometer	Testo	608-H1	34913912	N/A	May 02, 2017	Aug. 26, 2017	May 01, 2018	Conduction (CO05-HY)
LISN	Rohde & Schwarz	ENV216	100080	9kHz~30MHz	Nov. 29, 2016	Aug. 26, 2017	Nov. 28, 2017	Conduction (CO05-HY)
LF Cable	HUBER + SUHNER	RG-214/U	LF01	N/A	Jan. 05, 2017	Aug. 26, 2017	Jan. 04, 2018	Conduction (CO05-HY)
Test Software	N/A	EMC32	8.40.0	N/A	N/A	Aug. 26, 2017	N/A	Conduction (CO05-HY)
Loop Antenna	Rohde & Schwarz	HFH2-Z2	100315	9 kHz~30 MHz	May. 15, 2017	Aug. 28, 2017~ Sep. 05, 2017	May. 14, 2019	Radiation (03CH10-HY)
Bilog Antenna	TESEQ	CBL 6111D&00800 N1D01N-06	35413&02	30MHz~1GHz	Jan. 07, 2017	Aug. 28, 2017~ Sep. 05, 2017	Jan. 06, 2018	Radiation (03CH10-HY)
Horn Antenna	SCHWARZBECK	BBHA 9120 D	9120D-132 5	1GHz ~ 18GHz	Sep. 30, 2016	Aug. 28, 2017~ Sep. 05, 2017	Sep. 29, 2017	Radiation (03CH10-HY)
SHF-EHF Horn Antenna	SCHWARZBECK	BBHA 9170	BBHA9170 584	18GHz- 40GHz	Nov. 08, 2016	Aug. 28, 2017~ Sep. 05, 2017	Nov. 07, 2017	Radiation (03CH10-HY)
Spectrum Analyzer	Keysight	N9010A	MY542004 85	10Hz ~ 44GHz	Oct. 17, 2016	Aug. 28, 2017~ Sep. 05, 2017	Oct. 16, 2017	Radiation (03CH10-HY)
EMI Test Receiver	Agilent	N9038A (MXE)	MY532900 45	20Hz to 8.4GHz	Jan. 19, 2017	Aug. 28, 2017~ Sep. 05, 2017	Jan. 18, 2018	Radiation (03CH10-HY)
Amplifier	SONOMA	310N	187311	9kHz~1GHz	Oct. 26, 2016	Aug. 28, 2017~ Sep. 05, 2017	Oct. 25, 2017	Radiation (03CH10-HY)
Preamplifier	Keysight	83017A	MY532700 78	1GHz~26.5GHz	Oct. 26, 2016	Aug. 28, 2017~ Sep. 05, 2017	Oct. 25, 2017	Radiation (03CH10-HY)
Preamplifier	MITEQ	TTA1840-35- HG	1871923	18GHz~40GHz, VSWR : 2.5:1 max	Jul. 21, 2017	Aug. 28, 2017~ Sep. 05, 2017	Jul. 20, 2018	Radiation (03CH10-HY)
Preamplifier	MITEQ	AMF-7D-0010 1800-30-10P	1815698	1GHz~18GHz	Dec. 01, 2016	Aug. 28, 2017~ Sep. 05, 2017	Nov. 30, 2017	Radiation (03CH10-HY)



Instrument	Manufacturer	Model No.	Serial No.	Characteristics	Calibration Date	Test Date	Due Date	Remark
Hygrometer	TECEP	DTM-303B	TP140320	N/A	Nov. 14, 2016	Aug. 28, 2017~ Sep. 05, 2017	Nov. 13, 2017	Radiation (03CH10-HY)
RF Cable	HUBER + SUHNER	SUCOFLEX 104	MY249564 MY249524 MY283184	25GHz~40GHz	Sep. 30, 2016	Aug. 28, 2017~ Sep. 05, 2017	Sep. 29, 2017	Radiation (03CH10-HY)
RF Cable	HUBER + SUHNER	SUCOFLEX 104	MY249564 MY249524 MY283184	30MHz~1GHz	Sep. 30, 2016	Aug. 28, 2017~ Sep. 05, 2017	Sep. 29, 2017	Radiation (03CH10-HY)
RF Cable	HUBER + SUHNER	SUCOFLEX 104	MY249564 MY249524 MY283184	1GHz~25GHz	Sep. 30, 2016	Aug. 28, 2017~ Sep. 05, 2017	Sep. 29, 2017	Radiation (03CH10-HY)
Controller	EMEC	EM 1000	N/A	Control Turn table & Ant Mast	N/A	Aug. 28, 2017~ Sep. 05, 2017	N/A	Radiation (03CH10-HY)
Antenna Mast	EMEC	AM-BS-4500- B	N/A	1~4m	N/A	Aug. 28, 2017~ Sep. 05, 2017	N/A	Radiation (03CH10-HY)
Turn Table	EMEC	TT 2200	N/A	0~360 Degree	N/A	Aug. 28, 2017~ Sep. 05, 2017	N/A	Radiation (03CH10-HY)
Test Software	Audix	E3	6.2009-8-2 4	N/A	N/A	Aug. 28, 2017~ Sep. 05, 2017	N/A	Radiation (03CH10-HY)
Filter	Wainwright	WLKS1200-1 2SS	SN2	1.2G Low Pass	Sep. 19, 2016	Aug. 28, 2017~ Sep. 05, 2017	Sep. 18, 2017	Radiation (03CH10-HY)
Filter	Wainwright	WHKX12-270 0-3000-18000 -60SS	SN2	3G High Pass	Sep. 20, 2016	Aug. 28, 2017~ Sep. 05, 2017	Sep. 19, 2017	Radiation (03CH10-HY)



5 Uncertainty of Evaluation

Uncertainty of Conducted Emission Measurement (150kHz ~ 30MHz)

Measuring Uncertainty for a Level of Confidence of 95% ($U = 2Uc(y)$)	2.70
---	------

Uncertainty of Radiated Emission Measurement (30 MHz ~ 1000 MHz)

Measuring Uncertainty for a Level of Confidence of 95% ($U = 2Uc(y)$)	5.60
---	------

Uncertainty of Radiated Emission Measurement (1000 MHz ~ 18000 MHz)

Measuring Uncertainty for a Level of Confidence of 95% ($U = 2Uc(y)$)	5.90
---	------

Uncertainty of Radiated Emission Measurement (18000 MHz ~ 40000 MHz)

Measuring Uncertainty for a Level of Confidence of 95% ($U = 2Uc(y)$)	5.20
---	------

Appendix A. Test Result of Conducted Test Items

Test Engineer:	Allen Lin/Shiming Liu /Aking chang	Temperature:	21~25	°C
Test Date:	2017/8/24~2017/9/4	Relative Humidity:	51~54	%

TEST RESULTS DATA
6dB and 99% Occupied Bandwidth

2.4GHz Band								
Mod.	Data Rate	N _{TX}	CH.	Freq. (MHz)	99% Occupied BW (MHz)	6dB BW (MHz)	6dB BW Limit (MHz)	Pass/Fail
11b	1Mbps	1	1	2412	12.65	9.56	0.50	Pass
11b	1Mbps	1	6	2437	12.55	9.04	0.50	Pass
11b	1Mbps	1	11	2462	12.60	9.52	0.50	Pass
11g	6Mbps	1	1	2412	17.65	15.70	0.50	Pass
11g	6Mbps	1	6	2437	17.45	15.32	0.50	Pass
11g	6Mbps	1	11	2462	17.50	15.32	0.50	Pass
HT20	MCS0	1	1	2412	18.55	16.06	0.50	Pass
HT20	MCS0	1	6	2437	18.10	15.10	0.50	Pass
HT20	MCS0	1	11	2462	18.15	15.92	0.50	Pass

TEST RESULTS DATA
Peak Power Table

2.4GHz Band										
Mod.	Data Rate	N _{TX}	CH.	Freq. (MHz)	Peak Conducted Power (dBm)	Conducted Power Limit (dBm)	DG (dBi)	EIRP Power (dBm)	EIRP Power Limit (dBm)	Pass /Fail
11b	1Mbps	1	1	2412	20.04	30.00	-1.20	18.84	36.00	Pass
11b	1Mbps	1	6	2437	20.10	30.00	-1.20	18.90	36.00	Pass
11b	1Mbps	1	11	2462	20.08	30.00	-1.20	18.88	36.00	Pass
11g	6Mbps	1	1	2412	23.55	30.00	-1.20	22.35	36.00	Pass
11g	6Mbps	1	6	2437	23.47	30.00	-1.20	22.27	36.00	Pass
11g	6Mbps	1	11	2462	23.34	30.00	-1.20	22.14	36.00	Pass
HT20	MCS0	1	1	2412	23.72	30.00	-1.20	22.52	36.00	Pass
HT20	MCS0	1	6	2437	23.52	30.00	-1.20	22.32	36.00	Pass
HT20	MCS0	1	11	2462	23.31	30.00	-1.20	22.11	36.00	Pass

TEST RESULTS DATA
Average Power Table
(Reporting Only)

2.4GHz Band						
Mod.	Data Rate	N _{TX}	CH.	Freq. (MHz)	Duty Factor (dB)	Average Conducted Power (dBm)
11b	1Mbps	1	1	2412	0.00	16.93
11b	1Mbps	1	6	2437	0.00	16.98
11b	1Mbps	1	11	2462	0.00	16.96
11g	6Mbps	1	1	2412	0.15	14.99
11g	6Mbps	1	6	2437	0.15	14.98
11g	6Mbps	1	11	2462	0.15	14.80
HT20	MCS0	1	1	2412	0.13	14.99
HT20	MCS0	1	6	2437	0.13	14.98
HT20	MCS0	1	11	2462	0.13	14.84

TEST RESULTS DATA
Peak Power Density

2.4GHz Band								
Mod.	Data Rate	N _{TX}	CH.	Freq. (MHz)	Peak PSD (dBm /3kHz)	DG (dBi)	Peak PSD Limit (dBm /3kHz)	Pass/Fail
11b	1Mbps	1	1	2412	-5.97	-1.20	8.00	Pass
11b	1Mbps	1	6	2437	-5.92	-1.20	8.00	Pass
11b	1Mbps	1	11	2462	-5.46	-1.20	8.00	Pass
11g	6Mbps	1	1	2412	-10.29	-1.20	8.00	Pass
11g	6Mbps	1	6	2437	-9.62	-1.20	8.00	Pass
11g	6Mbps	1	11	2462	-10.03	-1.20	8.00	Pass
HT20	MCS0	1	1	2412	-11.17	-1.20	8.00	Pass
HT20	MCS0	1	6	2437	-10.70	-1.20	8.00	Pass
HT20	MCS0	1	11	2462	-10.20	-1.20	8.00	Pass



Appendix B. AC Conducted Emission Test Results

Test Engineer :	Shareef Yu	Temperature :	26~27°C
		Relative Humidity :	58~62%

EUT Information

Test Mode : Mode 1
 Test Voltage : 120Vac/60Hz
 Phase : Line

ENV216 Auto Test FCC Power Bar - L

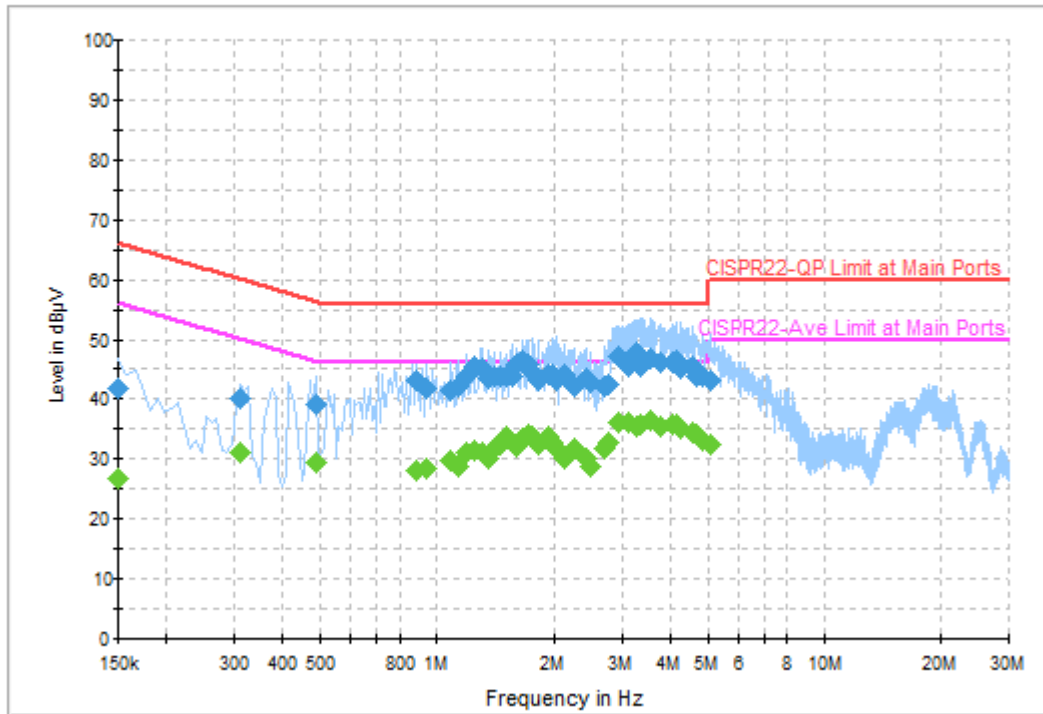

Final Result 1

Frequency (MHz)	QuasiPeak (dBµV)	Filter	Line	Corr. (dB)	Margin (dB)	Limit (dBµV)
0.150000	41.8	Off	L1	19.6	24.2	66.0
0.310000	40.3	Off	L1	19.5	19.7	60.0
0.486000	39.3	Off	L1	19.5	16.9	56.2
0.886000	43.2	Off	L1	19.5	12.8	56.0
0.942000	41.7	Off	L1	19.5	14.3	56.0
1.086000	41.5	Off	L1	19.5	14.5	56.0
1.142000	42.2	Off	L1	19.5	13.8	56.0
1.190000	43.9	Off	L1	19.5	12.1	56.0
1.246000	45.4	Off	L1	19.5	10.6	56.0
1.302000	45.1	Off	L1	19.5	10.9	56.0
1.358000	43.5	Off	L1	19.5	12.5	56.0
1.406000	43.9	Off	L1	19.5	12.1	56.0
1.462000	43.9	Off	L1	19.5	12.1	56.0
1.510000	43.7	Off	L1	19.5	12.3	56.0
1.566000	43.6	Off	L1	19.6	12.4	56.0
1.606000	45.9	Off	L1	19.6	10.1	56.0
1.662000	46.5	Off	L1	19.5	9.5	56.0
1.718000	45.9	Off	L1	19.5	10.1	56.0
1.774000	44.5	Off	L1	19.6	11.5	56.0
1.838000	43.1	Off	L1	19.6	12.9	56.0
1.942000	44.2	Off	L1	19.6	11.8	56.0
1.998000	44.1	Off	L1	19.6	11.9	56.0
2.030000	43.1	Off	L1	19.5	12.9	56.0
2.126000	44.0	Off	L1	18.1	12.0	56.0
2.262000	42.2	Off	L1	18.7	13.8	56.0

2.438000	43.4	Off	L1	19.1	12.6	56.0
2.494000	42.7	Off	L1	19.1	13.3	56.0
2.702000	42.3	Off	L1	19.3	13.7	56.0
2.758000	42.6	Off	L1	19.4	13.4	56.0
2.958000	47.3	Off	L1	19.5	8.7	56.0
3.134000	45.3	Off	L1	19.5	10.7	56.0
3.262000	47.7	Off	L1	19.5	8.3	56.0
3.350000	45.5	Off	L1	19.5	10.5	56.0
3.566000	46.8	Off	L1	19.6	9.2	56.0
3.798000	46.1	Off	L1	19.6	9.9	56.0
4.046000	46.2	Off	L1	19.6	9.8	56.0
4.150000	46.6	Off	L1	19.6	9.4	56.0
4.270000	45.0	Off	L1	19.6	11.0	56.0
4.566000	45.5	Off	L1	19.6	10.5	56.0
4.694000	43.8	Off	L1	19.6	12.2	56.0
4.862000	43.8	Off	L1	19.6	12.2	56.0
5.078000	43.2	Off	L1	19.6	16.8	60.0

Final Result 2

Frequency (MHz)	Average (dB μ V)	Filter	Line	Corr. (dB)	Margin (dB)	Limit (dB μ V)
0.150000	26.6	Off	L1	19.6	29.4	56.0
0.310000	31.1	Off	L1	19.5	18.9	50.0
0.486000	29.5	Off	L1	19.5	16.7	46.2
0.886000	28.1	Off	L1	19.5	17.9	46.0
0.942000	28.4	Off	L1	19.5	17.6	46.0
1.086000	29.6	Off	L1	19.5	16.4	46.0
1.142000	28.9	Off	L1	19.5	17.1	46.0
1.190000	31.0	Off	L1	19.5	15.0	46.0
1.246000	31.3	Off	L1	19.5	14.7	46.0
1.302000	31.0	Off	L1	19.5	15.0	46.0
1.358000	30.0	Off	L1	19.5	16.0	46.0
1.406000	31.9	Off	L1	19.5	14.1	46.0
1.462000	32.4	Off	L1	19.5	13.6	46.0
1.510000	33.7	Off	L1	19.5	12.3	46.0
1.566000	32.7	Off	L1	19.6	13.3	46.0
1.606000	32.2	Off	L1	19.6	13.8	46.0
1.662000	33.3	Off	L1	19.5	12.7	46.0
1.718000	33.9	Off	L1	19.5	12.1	46.0
1.774000	33.7	Off	L1	19.6	12.3	46.0
1.838000	32.4	Off	L1	19.6	13.6	46.0
1.942000	33.8	Off	L1	19.6	12.2	46.0
1.998000	32.8	Off	L1	19.6	13.2	46.0
2.030000	31.6	Off	L1	19.5	14.4	46.0
2.126000	30.0	Off	L1	18.1	16.0	46.0
2.262000	31.9	Off	L1	18.7	14.1	46.0
2.438000	30.2	Off	L1	19.1	15.8	46.0
2.494000	28.7	Off	L1	19.1	17.3	46.0
2.702000	31.8	Off	L1	19.3	14.2	46.0
2.758000	32.8	Off	L1	19.4	13.2	46.0
2.958000	36.0	Off	L1	19.5	10.0	46.0
3.134000	36.3	Off	L1	19.5	9.7	46.0
3.262000	35.5	Off	L1	19.5	10.5	46.0
3.350000	35.7	Off	L1	19.5	10.3	46.0
3.566000	36.3	Off	L1	19.6	9.7	46.0
3.798000	35.6	Off	L1	19.6	10.4	46.0
4.046000	35.8	Off	L1	19.6	10.2	46.0
4.150000	35.7	Off	L1	19.6	10.3	46.0
4.270000	35.0	Off	L1	19.6	11.0	46.0
4.566000	34.4	Off	L1	19.6	11.6	46.0
4.694000	34.1	Off	L1	19.6	11.9	46.0
4.862000	33.2	Off	L1	19.6	12.8	46.0
5.078000	32.6	Off	L1	19.6	17.4	50.0

EUT Information

Test Mode : Mode 1
 Test Voltage : 120Vac/60Hz
 Phase : Neutral

ENV216 Auto Test FCC Power Bar - N

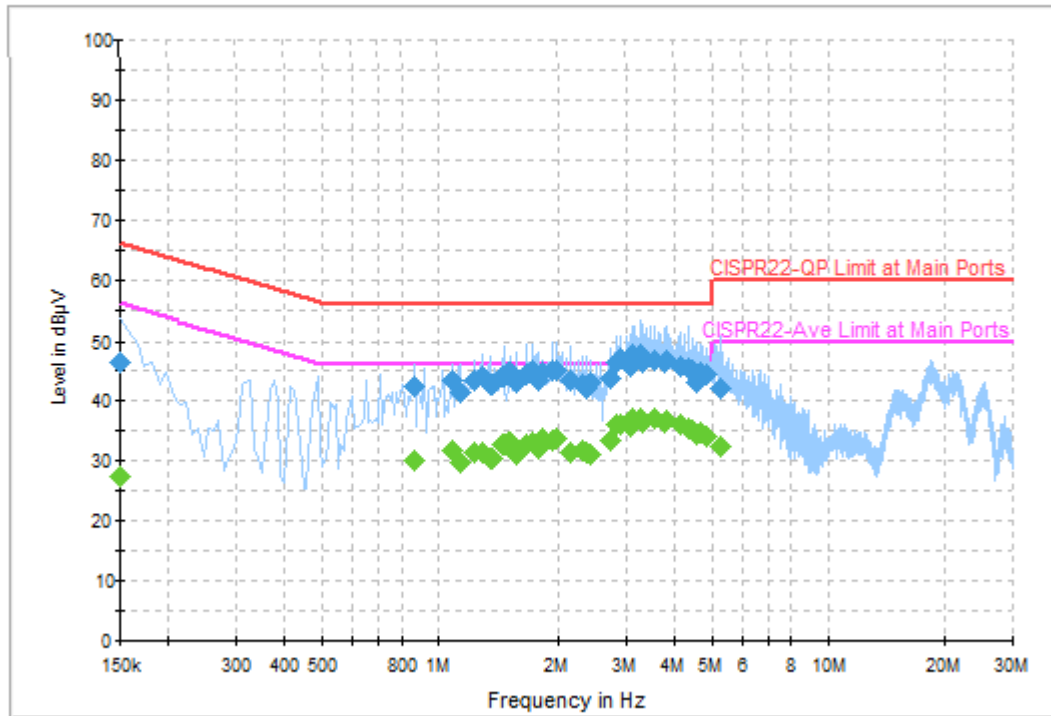

Final Result 1

Frequency (MHz)	QuasiPeak (dBµV)	Filter	Line	Corr. (dB)	Margin (dB)	Limit (dBµV)
0.150000	46.5	Off	N	19.5	19.5	66.0
0.862000	42.5	Off	N	19.5	13.5	56.0
1.078000	43.3	Off	N	19.5	12.7	56.0
1.134000	41.6	Off	N	19.5	14.4	56.0
1.238000	43.3	Off	N	19.5	12.7	56.0
1.294000	44.1	Off	N	19.5	11.9	56.0
1.350000	42.7	Off	N	19.5	13.3	56.0
1.454000	44.3	Off	N	19.5	11.7	56.0
1.510000	44.7	Off	N	19.5	11.3	56.0
1.566000	43.2	Off	N	19.5	12.8	56.0
1.670000	44.5	Off	N	19.5	11.5	56.0
1.726000	45.0	Off	N	19.5	11.0	56.0
1.782000	43.6	Off	N	19.5	12.4	56.0
1.830000	44.9	Off	N	19.5	11.1	56.0
1.942000	45.0	Off	N	19.5	11.0	56.0
1.990000	45.1	Off	N	19.5	10.9	56.0
2.158000	43.3	Off	N	18.3	12.7	56.0
2.318000	42.9	Off	N	18.8	13.1	56.0
2.374000	42.2	Off	N	18.9	13.8	56.0
2.422000	43.1	Off	N	19.0	12.9	56.0
2.750000	43.7	Off	N	19.4	12.3	56.0
2.854000	46.6	Off	N	19.4	9.4	56.0
2.910000	47.0	Off	N	19.4	9.0	56.0
3.078000	45.8	Off	N	19.5	10.2	56.0
3.126000	47.7	Off	N	19.5	8.3	56.0

3.286000	47.7	Off	N	19.5	8.3	56.0
3.334000	46.5	Off	N	19.5	9.5	56.0
3.550000	46.8	Off	N	19.5	9.2	56.0
3.766000	46.4	Off	N	19.6	9.6	56.0
3.822000	46.8	Off	N	19.6	9.2	56.0
4.142000	45.8	Off	N	19.6	10.2	56.0
4.358000	45.5	Off	N	19.6	10.5	56.0
4.470000	45.1	Off	N	19.6	10.9	56.0
4.566000	43.2	Off	N	19.6	12.8	56.0
4.686000	44.9	Off	N	19.6	11.1	56.0
4.846000	44.6	Off	N	19.6	11.4	56.0
5.270000	42.1	Off	N	19.6	17.9	60.0

Final Result 2

Frequency (MHz)	Average (dBμV)	Filter	Line	Corr. (dB)	Margin (dB)	Limit (dBμV)
0.150000	27.3	Off	N	19.5	28.7	56.0
0.862000	30.2	Off	N	19.5	15.8	46.0
1.078000	31.7	Off	N	19.5	14.3	46.0
1.134000	29.7	Off	N	19.5	16.3	46.0
1.238000	31.5	Off	N	19.5	14.5	46.0
1.294000	31.5	Off	N	19.5	14.5	46.0
1.350000	30.5	Off	N	19.5	15.5	46.0
1.454000	32.9	Off	N	19.5	13.1	46.0
1.510000	33.2	Off	N	19.5	12.8	46.0
1.566000	31.2	Off	N	19.5	14.8	46.0
1.670000	32.7	Off	N	19.5	13.3	46.0
1.726000	33.2	Off	N	19.5	12.8	46.0
1.782000	32.0	Off	N	19.5	14.0	46.0
1.830000	33.9	Off	N	19.5	12.1	46.0
1.942000	33.5	Off	N	19.5	12.5	46.0
1.990000	33.9	Off	N	19.5	12.1	46.0
2.158000	31.4	Off	N	18.3	14.6	46.0
2.318000	31.8	Off	N	18.8	14.2	46.0
2.374000	31.5	Off	N	18.9	14.5	46.0
2.422000	31.1	Off	N	19.0	14.9	46.0
2.750000	33.4	Off	N	19.4	12.6	46.0
2.854000	36.0	Off	N	19.4	10.0	46.0
2.910000	36.2	Off	N	19.4	9.8	46.0
3.078000	35.7	Off	N	19.5	10.3	46.0
3.126000	37.1	Off	N	19.5	8.9	46.0
3.286000	37.1	Off	N	19.5	9.0	46.0
3.334000	36.5	Off	N	19.5	9.5	46.0
3.550000	37.0	Off	N	19.5	9.0	46.0
3.766000	36.5	Off	N	19.6	9.5	46.0
3.822000	36.8	Off	N	19.6	9.2	46.0
4.142000	36.1	Off	N	19.6	9.9	46.0
4.358000	35.6	Off	N	19.6	10.4	46.0
4.470000	35.1	Off	N	19.6	10.9	46.0
4.566000	34.4	Off	N	19.6	11.6	46.0
4.686000	34.7	Off	N	19.6	11.3	46.0
4.846000	34.2	Off	N	19.6	11.8	46.0
5.270000	32.5	Off	N	19.6	17.5	50.0



Appendix C. Radiated Spurious Emission

Test Engineer :	Tsung lee, Stan Hsieh and Kyle Chuang	Temperature :	22~24°C
		Relative Humidity :	43~44%

2.4GHz 2400~2483.5MHz

WIFI 802.11b (Band Edge @ 3m)

WIFI Ant. 1	Note	Frequency (MHz)	Level (dBμV/m)	Over Limit (dB)	Limit Line (dBμV/m)	Read Level (dBμV)	Antenna Factor (dB/m)	Cable Loss (dB)	Preamp Factor (dB)	Ant Pos (cm)	Table Pos (deg)	Peak Avg. (P/A)	Pol. (H/V)	
802.11b CH 01 2412MHz		2389.59	51.29	-22.71	74	43.17	26.93	4.43	33.22	100	92	P	H	
		2389.905	40.76	-13.24	54	32.63	26.93	4.43	33.21	100	92	A	H	
	*	2412	107.68	-	-	99.45	26.99	4.47	33.21	100	92	P	H	
	*	2412	104.63	-	-	96.4	26.99	4.47	33.21	100	92	A	H	
													H	
														H
			2348.115	50.36	-23.64	74	42.47	26.74	4.4	33.23	386	64	P	V
			2390	40.25	-13.75	54	32.12	26.93	4.43	33.21	386	64	A	V
	*		2412	106.88	-	-	98.65	26.99	4.47	33.21	386	64	P	V
	*		2412	103.8	-	-	95.57	26.99	4.47	33.21	386	64	A	V
														V
														V
802.11b CH 06 2437MHz		2380.28	50.13	-23.87	74	42.07	26.87	4.43	33.22	100	94	P	H	
		2389.94	40.35	-13.65	54	32.22	26.93	4.43	33.21	100	94	A	H	
	*	2437	109.29	-	-	100.91	27.11	4.48	33.19	100	94	P	H	
	*	2437	106.18	-	-	97.8	27.11	4.48	33.19	100	94	A	H	
			2484.32	52.15	-21.85	74	43.57	27.24	4.53	33.17	100	94	P	H
			2483.5	42.16	-11.84	54	33.58	27.24	4.53	33.17	100	94	A	H
			2334.5	50.39	-23.61	74	42.59	26.68	4.38	33.24	379	67	P	V
			2389.94	39.8	-14.2	54	31.67	26.93	4.43	33.21	379	67	A	V
	*		2437	107.52	-	-	99.14	27.11	4.48	33.19	379	67	P	V
	*		2437	104.41	-	-	96.03	27.11	4.48	33.19	379	67	A	V
			2484.88	50.51	-23.49	74	41.93	27.24	4.53	33.17	379	67	P	V
			2483.55	40.78	-13.22	54	32.2	27.24	4.53	33.17	379	67	A	V



802.11b CH 11 2462MHz	*	2462	108.52	-	-	100.04	27.18	4.5	33.18	100	91	P	H
	*	2462	105.38	-	-	96.9	27.18	4.5	33.18	100	91	A	H
		2483.88	52.72	-21.28	74	44.14	27.24	4.53	33.17	100	91	P	H
		2483.52	43.13	-10.87	54	34.55	27.24	4.53	33.17	100	91	A	H
													H
													H
	*	2462	106.29	-	-	97.81	27.18	4.5	33.18	373	64	P	V
	*	2462	103.19	-	-	94.71	27.18	4.5	33.18	373	64	A	V
		2487.2	51.36	-22.64	74	42.78	27.24	4.53	33.17	373	64	P	V
		2483.52	41.52	-12.48	54	32.94	27.24	4.53	33.17	373	64	A	V
													V
													V
Remark	1. No other spurious found. 2. All results are PASS against Peak and Average limit line.												



**2.4GHz 2400~2483.5MHz
WIFI 802.11b (Harmonic @ 3m)**

WIFI Ant. 1	Note	Frequency (MHz)	Level (dBμV/m)	Over Limit (dB)	Limit Line (dBμV/m)	Read Level (dBμV)	Antenna Factor (dB/m)	Cable Loss (dB)	Preamp Factor (dB)	Ant Pos (cm)	Table Pos (deg)	Peak Avg. (P/A)	Pol. (H/V)	
802.11b CH 01 2412MHz		4824	47.9	-26.1	74	66.89	32.09	6.74	58.31	100	0	P	H	
													H	
													H	
													H	
			4824	45.39	-28.61	74	64.38	32.09	6.74	58.31	100	0	P	V
														V
														V
802.11b CH 06 2437MHz		4874	43.54	-30.46	74	62.3	32.21	6.79	58.24	100	0	P	H	
		7311	42.94	-31.06	74	56.31	36.86	8.46	59.09	100	0	P	H	
													H	
													H	
			4874	38.66	-35.34	74	57.42	32.21	6.79	58.24	100	0	P	V
			7311	42.96	-31.04	74	56.33	36.86	8.46	59.09	100	0	P	V
														V
802.11b CH 11 2462MHz		4924	49.44	-24.56	74	67.99	32.33	6.83	58.18	100	0	P	H	
		7386	41.94	-32.06	74	55.1	37.15	8.48	59.14	100	0	P	H	
													H	
													H	
			4924	44.84	-29.16	74	63.39	32.33	6.83	58.18	100	0	P	V
			7386	43.89	-30.11	74	57.05	37.15	8.48	59.14	100	0	P	V
														V
Remark	1. No other spurious found.													
	2. All results are PASS against Peak and Average limit line.													



**2.4GHz 2400~2483.5MHz
WIFI 802.11g (Band Edge @ 3m)**

WIFI Ant. 1	Note	Frequency (MHz)	Level (dBμV/m)	Over Limit (dB)	Limit Line (dBμV/m)	Read Level (dBμV)	Antenna Factor (dB/m)	Cable Loss (dB)	Preamp Factor (dB)	Ant Pos (cm)	Table Pos (deg)	Peak Avg. (P/A)	Pol. (H/V)	
802.11g CH 01 2412MHz		2389.17	56.21	-17.79	74	48.09	26.93	4.43	33.22	100	91	P	H	
		2389.905	44.52	-9.48	54	36.39	26.93	4.43	33.21	100	91	A	H	
	*	2412	107.43	-	-	99.2	26.99	4.47	33.21	100	91	P	H	
	*	2412	99.93	-	-	91.7	26.99	4.47	33.21	100	91	A	H	
													H	
													H	
			2389.905	52.66	-21.34	74	44.53	26.93	4.43	33.21	387	63	P	V
			2390	42.81	-11.19	54	34.68	26.93	4.43	33.21	387	63	A	V
	*		2412	105.62	-	-	97.39	26.99	4.47	33.21	387	63	P	V
	*		2412	98.26	-	-	90.03	26.99	4.47	33.21	387	63	A	V
													V	
													V	
802.11g CH 06 2437MHz		2387.14	50.3	-23.7	74	42.18	26.93	4.43	33.22	100	91	P	H	
		2388.82	41.86	-12.14	54	33.74	26.93	4.43	33.22	100	91	A	H	
	*	2437	108.4	-	-	100.02	27.11	4.48	33.19	100	91	P	H	
	*	2437	100.88	-	-	92.5	27.11	4.48	33.19	100	91	A	H	
			2487.47	54.7	-19.3	74	46.12	27.24	4.53	33.17	100	91	P	H
			2483.5	44.86	-9.14	54	36.28	27.24	4.53	33.17	100	91	A	H
			2367.82	50.65	-23.35	74	42.67	26.8	4.42	33.22	377	59	P	V
			2389.38	40.81	-13.19	54	32.69	26.93	4.43	33.22	377	59	A	V
	*		2437	107.08	-	-	98.7	27.11	4.48	33.19	377	59	P	V
	*		2437	99.1	-	-	90.72	27.11	4.48	33.19	377	59	A	V
			2489.15	51.92	-22.08	74	43.28	27.3	4.53	33.17	377	59	P	V
			2483.5	42.62	-11.38	54	34.04	27.24	4.53	33.17	377	59	A	V



802.11g CH 11 2462MHz	*	2462	108.36	-	-	99.88	27.18	4.5	33.18	100	90	P	H
	*	2462	101.11	-	-	92.63	27.18	4.5	33.18	100	90	A	H
		2483.64	61.26	-12.74	74	52.68	27.24	4.53	33.17	100	90	P	H
		2483.6	49.5	-4.5	54	40.92	27.24	4.53	33.17	100	90	A	H
													H
													H
	*	2462	106	-	-	97.52	27.18	4.5	33.18	372	67	P	V
	*	2462	98.36	-	-	89.88	27.18	4.5	33.18	372	67	A	V
		2484.16	56.75	-17.25	74	48.17	27.24	4.53	33.17	372	67	P	V
		2483.56	45.91	-8.09	54	37.33	27.24	4.53	33.17	372	67	A	V
													V
													V
Remark	1. No other spurious found. 2. All results are PASS against Peak and Average limit line.												



**2.4GHz 2400~2483.5MHz
WIFI 802.11g (Harmonic @ 3m)**

WIFI Ant. 1	Note	Frequency (MHz)	Level (dBμV/m)	Over Limit (dB)	Limit Line (dBμV/m)	Read Level (dBμV)	Antenna Factor (dB/m)	Cable Loss (dB)	Preamp Factor (dB)	Ant Pos (cm)	Table Pos (deg)	Peak Avg. (P/A)	Pol. (H/V)	
802.11g CH 01 2412MHz		4824	43.8	-30.2	74	62.79	32.09	6.74	58.31	100	0	P	H	
													H	
													H	
													H	
			4824	38.81	-35.19	74	57.8	32.09	6.74	58.31	100	0	P	V
														V
														V
802.11g CH 06 2437MHz		4874	40.2	-33.8	74	58.96	32.21	6.79	58.24	100	0	P	H	
		7311	43.96	-30.04	74	57.33	36.86	8.46	59.09	100	0	P	H	
													H	
													H	
			4874	38	-36	74	56.76	32.21	6.79	58.24	100	0	P	V
			7311	42.47	-31.53	74	55.84	36.86	8.46	59.09	100	0	P	V
														V
802.11g CH 11 2462MHz		4924	45.17	-28.83	74	63.72	32.33	6.83	58.18	100	0	P	H	
		7386	42.13	-31.87	74	55.29	37.15	8.48	59.14	100	0	P	H	
													H	
													H	
			4924	39.66	-34.34	74	58.21	32.33	6.83	58.18	100	0	P	V
			7386	42.46	-31.54	74	55.62	37.15	8.48	59.14	100	0	P	V
														V
Remark	1. No other spurious found.													
	2. All results are PASS against Peak and Average limit line.													



**2.4GHz 2400~2483.5MHz
WIFI 802.11n HT20 (Band Edge @ 3m)**

WIFI Ant. 1	Note	Frequency (MHz)	Level (dBμV/m)	Over Limit (dB)	Limit Line (dBμV/m)	Read Level (dBμV)	Antenna Factor (dB/m)	Cable Loss (dB)	Preamp Factor (dB)	Ant Pos (cm)	Table Pos (deg)	Peak Avg. (P/A)	Pol. (H/V)	
802.11n HT20 CH 01 2412MHz		2389.905	63.13	-10.87	74	55	26.93	4.43	33.21	100	91	P	H	
		2390	46.46	-7.54	54	38.33	26.93	4.43	33.21	100	91	A	H	
	*	2412	107.44	-	-	99.21	26.99	4.47	33.21	100	91	P	H	
	*	2412	99.15	-	-	90.92	26.99	4.47	33.21	100	91	A	H	
													H	
													H	
			2389.275	57.67	-16.33	74	49.55	26.93	4.43	33.22	390	63	P	V
			2390	44.8	-9.2	54	36.67	26.93	4.43	33.21	390	63	A	V
		*	2412	104.79	-	-	96.56	26.99	4.47	33.21	390	63	P	V
		*	2412	97.3	-	-	89.07	26.99	4.47	33.21	390	63	A	V
													V	
													V	
802.11n HT20 CH 06 2437MHz		2389.52	50.47	-23.53	74	42.35	26.93	4.43	33.22	100	92	P	H	
		2389.94	42.07	-11.93	54	33.94	26.93	4.43	33.21	100	92	A	H	
	*	2437	108.48	-	-	100.1	27.11	4.48	33.19	100	92	P	H	
	*	2437	100.8	-	-	92.42	27.11	4.48	33.19	100	92	A	H	
			2484.88	53.91	-20.09	74	45.33	27.24	4.53	33.17	100	92	P	H
			2483.69	45.12	-8.88	54	36.54	27.24	4.53	33.17	100	92	A	H
			2384.9	50.69	-23.31	74	42.63	26.87	4.43	33.22	380	62	P	V
			2387.14	40.82	-13.18	54	32.7	26.93	4.43	33.22	380	62	A	V
		*	2437	106.94	-	-	98.56	27.11	4.48	33.19	380	62	P	V
		*	2437	99.19	-	-	90.81	27.11	4.48	33.19	380	62	A	V
		2483.76	52.12	-21.88	74	43.54	27.24	4.53	33.17	380	62	P	V	
		2483.5	42.29	-11.71	54	33.71	27.24	4.53	33.17	380	62	A	V	



802.11n HT20 CH 11 2462MHz	*	2462	108.04	-	-	99.56	27.18	4.5	33.18	100	92	P	H
	*	2462	100.52	-	-	92.04	27.18	4.5	33.18	100	92	A	H
		2483.64	65.79	-8.21	74	57.21	27.24	4.53	33.17	100	92	P	H
		2483.52	50.77	-3.23	54	42.19	27.24	4.53	33.17	100	92	A	H
													H
													H
	*	2462	105.63	-	-	97.15	27.18	4.5	33.18	371	60	P	V
	*	2462	98.25	-	-	89.77	27.18	4.5	33.18	371	60	A	V
		2483.52	60.84	-13.16	74	52.26	27.24	4.53	33.17	371	60	P	V
		2484.12	47.77	-6.23	54	39.19	27.24	4.53	33.17	371	60	A	V
													V
												V	
Remark	1. No other spurious found. 2. All results are PASS against Peak and Average limit line.												



**2.4GHz 2400~2483.5MHz
WIFI 802.11n HT20 (Harmonic @ 3m)**

WIFI Ant. 1	Note	Frequency (MHz)	Level (dBµV/m)	Over Limit (dB)	Limit Line (dBµV/m)	Read Level (dBµV)	Antenna Factor (dB/m)	Cable Loss (dB)	Preamp Factor (dB)	Ant Pos (cm)	Table Pos (deg)	Peak Avg. (P/A)	Pol. (H/V)	
802.11n HT20 CH 01 2412MHz		4824	43.36	-30.64	74	62.35	32.09	6.74	58.31	100	0	P	H	
													H	
													H	
													H	
			4824	39.71	-34.29	74	58.7	32.09	6.74	58.31	100	0	P	V
														V
														V
802.11n HT20 CH 06 2437MHz		4874	39.81	-34.19	74	58.57	32.21	6.79	58.24	100	0	P	H	
		7311	42.54	-31.46	74	55.91	36.86	8.46	59.09	100	0	P	H	
													H	
													H	
			4874	37.85	-36.15	74	56.61	32.21	6.79	58.24	100	0	P	V
			7311	42.86	-31.14	74	56.23	36.86	8.46	59.09	100	0	P	V
														V
802.11n HT20 CH 11 2462MHz		4924	44.17	-29.83	74	62.72	32.33	6.83	58.18	100	0	P	H	
		7386	43.18	-30.82	74	56.34	37.15	8.48	59.14	100	0	P	H	
													H	
													H	
			4924	40.57	-33.43	74	59.12	32.33	6.83	58.18	100	0	P	V
			7386	42.18	-31.82	74	55.34	37.15	8.48	59.14	100	0	P	V
														V
Remark	1. No other spurious found.													
	2. All results are PASS against Peak and Average limit line.													



**Emission below 1GHz
2.4GHz WIFI 802.11b (LF)**

WIFI	Note	Frequency	Level	Over	Limit	Read	Antenna	Cable	Preamp	Ant	Table	Peak	Pol.	
Ant.				Limit	Line	Level	Factor	Loss	Factor	Pos	Pos	Avg.		
1		(MHz)	(dBμV/m)	(dB)	(dBμV/m)	(dBμV)	(dB/m)	(dB)	(dB)	(cm)	(deg)	(P/A)	(H/V)	
2.4GHz 802.11b LF		41.07	23.95	-16.05	40	37	18.9	0.69	32.75	-	-	P	H	
		97.5	24.88	-18.62	43.5	40.68	15.76	0.97	32.77	-	-	P	H	
		129.36	25.99	-17.51	43.5	39.79	17.55	1.12	32.76	-	-	P	H	
		574.4	26.08	-19.92	46	30.49	25.77	2.21	32.97	-	-	P	H	
		729.8	29.48	-16.52	46	31.67	27.7	2.48	32.96	-	-	P	H	
		946.8	32.51	-13.49	46	30.1	30.61	2.78	31.78	100	0	P	H	
														H
														H
														H
														H
														H
														H
			31.62	32.75	-7.25	40	41.55	23.34	0.53	32.75	-	-	P	V
			38.1	35.72	-4.28	40	47.38	20.46	0.53	32.75	100	0	P	V
			97.23	28.44	-15.06	43.5	44.38	15.62	0.97	32.77	-	-	P	V
			560.4	25.88	-20.12	46	29.85	26.18	2.21	32.95	-	-	P	V
			752.9	29.87	-16.13	46	31.44	28.26	2.51	32.94	-	-	P	V
			956.6	32.53	-13.47	46	29.62	30.98	2.79	31.67	-	-	P	V
														V
														V
													V	
													V	
													V	
													V	
													V	
Remark	1. No other spurious found. 2. All results are PASS against limit line.													



**Emission below 1GHz
2.4GHz WIFI 802.11g (LF)**

WIFI	Note	Frequency	Level	Over	Limit	Read	Antenna	Cable	Preamp	Ant	Table	Peak	Pol.	
Ant.				Limit	Line	Level	Factor	Loss	Factor	Pos	Pos	Avg.		
1		(MHz)	(dBμV/m)	(dB)	(dBμV/m)	(dBμV)	(dB/m)	(dB)	(dB)	(cm)	(deg)	(P/A)	(H/V)	
2.4GHz 802.11g LF		40.8	23.7	-16.3	40	36.75	18.9	0.69	32.75	-	-	P	H	
		99.12	24.89	-18.61	43.5	40.54	15.91	0.97	32.77	-	-	P	H	
		132.06	26	-17.5	43.5	39.82	17.52	1.12	32.76	-	-	P	H	
		562.5	26.03	-19.97	46	30.07	26.12	2.21	32.95	-	-	P	H	
		730.5	29.58	-16.42	46	31.73	27.74	2.48	32.96	-	-	P	H	
		956.6	32.5	-13.5	46	29.59	30.98	2.79	31.67	100	0	P	H	
														H
														H
														H
														H
														H
														H
			42.15	35.42	-4.58	40	49.52	17.85	0.69	32.75	100	0	P	V
			77.79	25.06	-14.94	40	43.77	13.02	0.86	32.76	-	-	P	V
			96.96	27.87	-15.63	43.5	43.81	15.62	0.97	32.77	-	-	P	V
			659.1	28.39	-17.61	46	31.96	26.47	2.35	32.99	-	-	P	V
			841.1	30.46	-15.54	46	30.74	29.06	2.65	32.65	-	-	P	V
			958	33.31	-12.69	46	30.32	31.05	2.79	31.66	-	-	P	V
														V
														V
													V	
													V	
													V	
													V	
													V	
Remark	1. No other spurious found. 2. All results are PASS against limit line.													



Emission below 1GHz
2.4GHz WIFI 802.11n HT20 (LF)

Table with 14 columns: WIFI, Note, Frequency, Level, Over, Limit, Read, Antenna, Cable, Preamp, Ant, Table, Peak, Pol. Contains data for 2.4GHz HT20 LF and a Remark section at the bottom.



Note symbol

*	Fundamental Frequency which can be ignored. However, the level of any unwanted emissions shall not exceed the level of the fundamental frequency.
!	Test result is over limit line.
P/A	Peak or Average
H/V	Horizontal or Vertical



A calculation example for radiated spurious emission is shown as below:

WIFI	Note	Frequency	Level	Over	Limit	Read	Antenna	Cable	Preamp	Ant	Table	Peak	Pol.
Ant.				Limit	Line	Level	Factor	Loss	Factor	Pos	Pos	Avg.	
1		(MHz)	(dBμV/m)	(dB)	(dBμV/m)	(dBμV)	(dB/m)	(dB)	(dB)	(cm)	(deg)	(P/A)	(H/V)
802.11b		2390	55.45	-18.55	74	54.51	32.22	4.58	35.86	103	308	P	H
CH 01													
2412MHz		2390	43.54	-10.46	54	42.6	32.22	4.58	35.86	103	308	A	H

- Level(dBμV/m) =
Antenna Factor(dB/m) + Cable Loss(dB) + Read Level(dBμV) - Preamp Factor(dB)
- Over Limit(dB) = Level(dBμV/m) – Limit Line(dBμV/m)

For Peak Limit @ 2390MHz:

- Level(dBμV/m)
= Antenna Factor(dB/m) + Cable Loss(dB) + Read Level(dBμV) - Preamp Factor(dB)
= 32.22(dB/m) + 4.58(dB) + 54.51(dBμV) – 35.86 (dB)
= 55.45 (dBμV/m)
- Over Limit(dB)
= Level(dBμV/m) – Limit Line(dBμV/m)
= 55.45(dBμV/m) – 74(dBμV/m)
= -18.55(dB)

For Average Limit @ 2390MHz:

- Level(dBμV/m)
= Antenna Factor(dB/m) + Cable Loss(dB) + Read Level(dBμV) - Preamp Factor(dB)
= 32.22(dB/m) + 4.58(dB) + 42.6(dBμV) – 35.86 (dB)
= 43.54 (dBμV/m)
- Over Limit(dB)
= Level(dBμV/m) – Limit Line(dBμV/m)
= 43.54(dBμV/m) – 54(dBμV/m)
= -10.46(dB)

Both peak and average measured complies with the limit line, so test result is “PASS”.



Appendix D. Radiated Spurious Emission Plots

Test Engineer :	Tsung lee, Stan Hsieh and Kyle Chuang	Temperature :	22~24°C
		Relative Humidity :	43~44%

Note symbol

-L	Low channel location
-R	High channel location



**2.4GHz 2400~2483.5MHz
WIFI 802.11b (Band Edge @ 3m)**

WIFI	2.4GHz 2400~2483.5MHz Band Edge @ 3m	
ANT	802.11b CH01 2412MHz	
1	Horizontal	Fundamental
Peak	<p>Site : 03CH10-HY Condition : PEAK BE 74 3m HORN 9120D-HF HORIZONTAL</p>	<p>Site : 03CH10-HY Condition : PEAK 74 3m HORN 9120D-HF HORIZONTAL</p>
Avg.	<p>Site : 03CH10-HY Condition : AVG BE 54 3m HORN 9120D-HF HORIZONTAL</p>	<p>Site : 03CH10-HY Condition : AVG 54 3m HORN 9120D-HF HORIZONTAL</p>



WIFI	2.4GHz 2400~2483.5MHz Band Edge @ 3m	
ANT	802.11b CH01 2412MHz	
1	Vertical	Fundamental
Peak	<p>Site : 03CH10-HY Condition : PEAK BE 74 3m HORN 9120D-HF VERTICAL</p>	<p>Site : 03CH10-HY Condition : PEAK 74 3m HORN 9120D-HF VERTICAL</p>
Avg.	<p>Site : 03CH10-HY Condition : AV6 BE 54 3m HORN 9120D-HF VERTICAL</p>	<p>Site : 03CH10-HY Condition : AV6 54 3m HORN 9120D-HF VERTICAL</p>

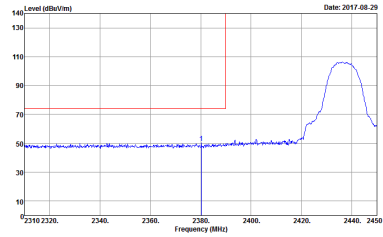
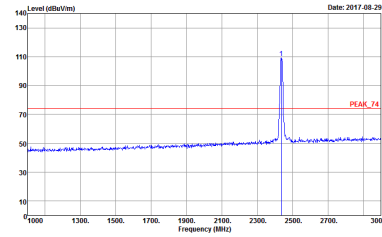
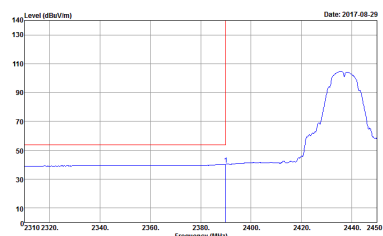
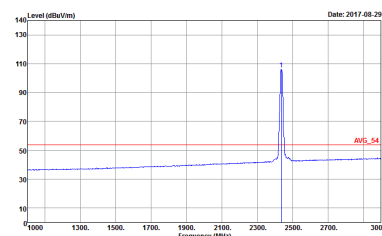

WIFI	2.4GHz 2400~2483.5MHz Band Edge @ 3m	
ANT	802.11b CH06 2437MHz - L	
1	Horizontal	Fundamental
Peak	 <p>Site : 03CH10-HY Condition : PEAK BE 74 3m HORN 9120D-HF HORIZONTAL</p>	 <p>Site : 03CH10-HY Condition : PEAK 74 3m HORN 9120D-HF HORIZONTAL</p>
Avg.	 <p>Site : 03CH10-HY Condition : AV6 BE 54 3m HORN 9120D-HF HORIZONTAL</p>	 <p>Site : 03CH10-HY Condition : AV6 54 3m HORN 9120D-HF HORIZONTAL</p>



WIFI	2.4GHz 2400~2483.5MHz Band Edge @ 3m	
ANT	802.11b CH06 2437MHz - R	
1	Horizontal	Fundamental
Peak	<p>Site : 03CH10-HY Condition : PEAK_BE 74 3m HORN 9120D-HF HORIZONTAL</p>	Left blank
Avg.	<p>Site : 03CH10-HY Condition : AVG_BE 54 3m HORN 9120D-HF HORIZONTAL</p>	Left blank



WIFI	2.4GHz 2400~2483.5MHz Band Edge @ 3m	
ANT	802.11b CH06 2437MHz - L	
1	Vertical	Fundamental
Peak	<p>Site : 03CH10-HY Condition : PEAK BE 74 3m HORN 9120D-HF VERTICAL</p>	<p>Site : 03CH10-HY Condition : PEAK 74 3m HORN 9120D-HF VERTICAL</p>
Avg.	<p>Site : 03CH10-HY Condition : AV6 BE 54 3m HORN 9120D-HF VERTICAL</p>	<p>Site : 03CH10-HY Condition : AV6 54 3m HORN 9120D-HF VERTICAL</p>



WIFI	2.4GHz 2400~2483.5MHz Band Edge @ 3m	
ANT	802.11b CH06 2437MHz - R	
1	Vertical	Fundamental
Peak	<p>Site : 03CH10-HY Condition : PEAK_BE 74 3m HORN 91200-HF VERTICAL</p>	Left blank
Avg.	<p>Site : 03CH10-HY Condition : AVG_BE 54 3m HORN 91200-HF VERTICAL</p>	Left blank



WIFI	2.4GHz 2400~2483.5MHz Band Edge @ 3m	
ANT	802.11b CH11 2462MHz	
1	Horizontal	Fundamental
Peak	<p>Site : 03CH10-HY Condition : PEAK_BE 74 3m HORN 9120D-HF HORIZONTAL</p>	<p>Site : 03CH10-HY Condition : PEAK_74 3m HORN 9120D-HF HORIZONTAL</p>
Avg.	<p>Site : 03CH10-HY Condition : AV6_BE 54 3m HORN 9120D-HF HORIZONTAL</p>	<p>Site : 03CH10-HY Condition : AV6_54 3m HORN 9120D-HF HORIZONTAL</p>



WIFI	2.4GHz 2400~2483.5MHz Band Edge @ 3m	
ANT	802.11b CH11 2462MHz	
1	Vertical	Fundamental
Peak	<p>Site : 03CH10-HY Condition : PEAK_BE_74 3m HORN 9120D-HF VERTICAL</p>	<p>Site : 03CH10-HY Condition : PEAK_74 3m HORN 9120D-HF VERTICAL</p>
Avg.	<p>Site : 03CH10-HY Condition : AVG_BE_54 3m HORN 9120D-HF VERTICAL</p>	<p>Site : 03CH10-HY Condition : AVG_54 3m HORN 9120D-HF VERTICAL</p>



2.4GHz 2400~2483.5MHz
WIFI 802.11g (Band Edge @ 3m)

WIFI	2.4GHz 2400~2483.5MHz Band Edge @ 3m	
ANT	802.11g CH01 2412MHz	
1	Horizontal	Fundamental
Peak	<p>Site : 03CH10-HY Condition : PEAK BE 74 3m HORN 9120D-HF HORIZONTAL</p>	<p>Site : 03CH10-HY Condition : PEAK 74 3m HORN 9120D-HF HORIZONTAL</p>
Avg.	<p>Site : 03CH10-HY Condition : AVG BE 54 3m HORN 9120D-HF HORIZONTAL</p>	<p>Site : 03CH10-HY Condition : AVG 54 3m HORN 9120D-HF HORIZONTAL</p>



WIFI	2.4GHz 2400~2483.5MHz Band Edge @ 3m	
ANT	802.11g CH01 2412MHz	
1	Vertical	Fundamental
Peak	<p>Site : 03CH10-HY Condition : PEAK BE 74 3m HORN 9120D-HF VERTICAL</p>	<p>Site : 03CH10-HY Condition : PEAK 74 3m HORN 9120D-HF VERTICAL</p>
Avg.	<p>Site : 03CH10-HY Condition : AV6 BE 54 3m HORN 9120D-HF VERTICAL</p>	<p>Site : 03CH10-HY Condition : AV6 54 3m HORN 9120D-HF VERTICAL</p>

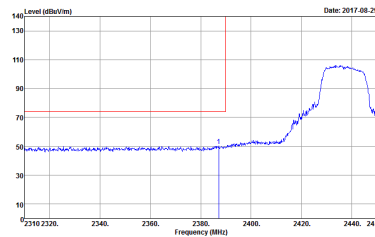
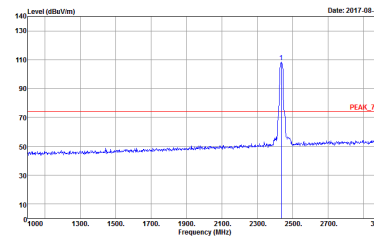
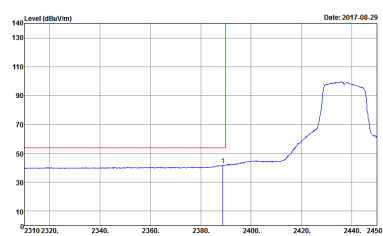
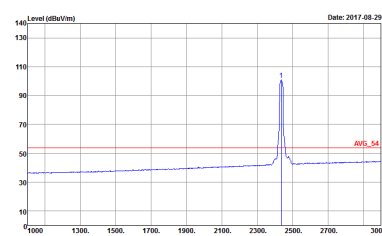

WIFI	2.4GHz 2400~2483.5MHz Band Edge @ 3m	
ANT	802.11g CH06 2437MHz - L	
1	Horizontal	Fundamental
Peak	 <p>Site : 03CH10-HY Condition : PEAK BE 74 3m HORN 9120D-HF HORIZONTAL</p>	 <p>Site : 03CH10-HY Condition : PEAK 74 3m HORN 9120D-HF HORIZONTAL</p>
Avg.	 <p>Site : 03CH10-HY Condition : AV6 BE 54 3m HORN 9120D-HF HORIZONTAL</p>	 <p>Site : 03CH10-HY Condition : AV6 54 3m HORN 9120D-HF HORIZONTAL</p>



WIFI	2.4GHz 2400~2483.5MHz Band Edge @ 3m	
ANT	802.11g CH06 2437MHz - R	
1	Horizontal	Fundamental
Peak	<p>Site : 03CH10-HY Condition : PEAK_BE_74 3m HORN 9120D-HF HORIZONTAL</p>	Left blank
Avg.	<p>Site : 03CH10-HY Condition : AVG_BE_54 3m HORN 9120D-HF HORIZONTAL</p>	Left blank



WIFI	2.4GHz 2400~2483.5MHz Band Edge @ 3m	
ANT	802.11g CH06 2437MHz - L	
1	Vertical	Fundamental
Peak	<p>Site : 03CH10-HY Condition : PEAK BE 74 3m HORN 9120D-HF VERTICAL</p>	<p>Site : 03CH10-HY Condition : PEAK 74 3m HORN 9120D-HF VERTICAL</p>
Avg.	<p>Site : 03CH10-HY Condition : AV6 BE 54 3m HORN 9120D-HF VERTICAL</p>	<p>Site : 03CH10-HY Condition : AV6 54 3m HORN 9120D-HF VERTICAL</p>



WIFI	2.4GHz 2400~2483.5MHz Band Edge @ 3m	
ANT	802.11g CH06 2437MHz - R	
1	Vertical	Fundamental
Peak	<p>Site : 03CH10-HY Condition : PEAK_BE_74 3m HORN 91200-HF VERTICAL</p>	Left Blank
Avg.	<p>Site : 03CH10-HY Condition : AVG_BE_54 3m HORN 91200-HF VERTICAL</p>	Left Blank



WIFI	2.4GHz 2400~2483.5MHz Band Edge @ 3m	
ANT	802.11g CH11 2462MHz	
1	Horizontal	Fundamental
Peak	<p>Site : 03CH10-HY Condition : PEAK BE 74 3m HORN 9120D-HF HORIZONTAL</p>	<p>Site : 03CH10-HY Condition : PEAK 74 3m HORN 9120D-HF HORIZONTAL</p>
Avg.	<p>Site : 03CH10-HY Condition : AVG BE 54 3m HORN 9120D-HF HORIZONTAL</p>	<p>Site : 03CH10-HY Condition : AVG 54 3m HORN 9120D-HF HORIZONTAL</p>



WIFI	2.4GHz 2400~2483.5MHz Band Edge @ 3m	
ANT	802.11g CH11 2462MHz	
1	Vertical	Fundamental
Peak	<p>Site : 03CH10-HY Condition : PEAK_BE_74 3m HORN 9120D-HF VERTICAL</p>	<p>Site : 03CH10-HY Condition : PEAK_74 3m HORN 9120D-HF VERTICAL</p>
Avg.	<p>Site : 03CH10-HY Condition : AVG_BE_54 3m HORN 9120D-HF VERTICAL</p>	<p>Site : 03CH10-HY Condition : AVG_54 3m HORN 9120D-HF VERTICAL</p>



2.4GHz 2400~2483.5MHz
WIFI 802.11n HT20 (Band Edge @ 3m)

Table with 4 columns: WIFI, ANT, 1, and two sub-columns for Horizontal and Fundamental. Rows are labeled Peak and Avg. Each cell contains a spectral plot with site and condition details.



WIFI	2.4GHz 2400~2483.5MHz Band Edge @ 3m	
ANT	802.11n HT20 CH01 2412MHz	
1	Vertical	Fundamental
Peak	<p>Site : 03CH10-HY Condition : PEAK BE 74 3m HORN 9120D-HF VERTICAL</p>	<p>Site : 03CH10-HY Condition : PEAK 74 3m HORN 9120D-HF VERTICAL</p>
Avg.	<p>Site : 03CH10-HY Condition : AV6 BE 54 3m HORN 9120D-HF VERTICAL</p>	<p>Site : 03CH10-HY Condition : AV6 54 3m HORN 9120D-HF VERTICAL</p>

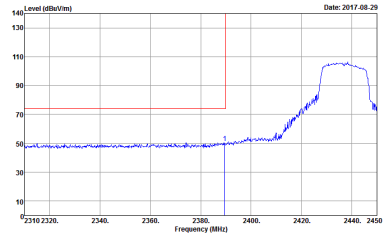
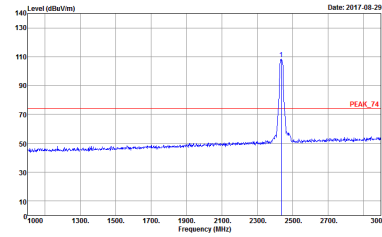
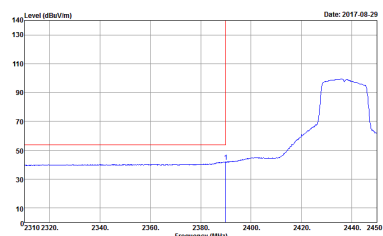
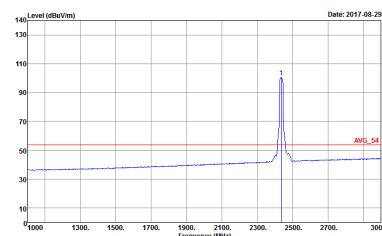

WIFI	2.4GHz 2400~2483.5MHz Band Edge @ 3m	
ANT	802.11n HT20 CH06 2437MHz - L	
1	Horizontal	Fundamental
Peak	 <p>Site : 03CH10-HY Condition : PEAK BE 74 3m HORN 9120D-HF HORIZONTAL</p>	 <p>Site : 03CH10-HY Condition : PEAK 74 3m HORN 9120D-HF HORIZONTAL</p>
Avg.	 <p>Site : 03CH10-HY Condition : AV6 BE 54 3m HORN 9120D-HF HORIZONTAL</p>	 <p>Site : 03CH10-HY Condition : AV6 54 3m HORN 9120D-HF HORIZONTAL</p>



WIFI	2.4GHz 2400~2483.5MHz Band Edge @ 3m	
ANT	802.11n HT20 CH06 2437MHz - R	
1	Horizontal	Fundamental
Peak	<p>Site : 03CH10-HY Condition : PEAK BE 74 3m HORN 9120D-HF HORIZONTAL</p>	Left blank
Avg.	<p>Site : 03CH10-HY Condition : AVG BE 54 3m HORN 9120D-HF HORIZONTAL</p>	Left blank



WIFI	2.4GHz 2400~2483.5MHz Band Edge @ 3m	
ANT	802.11n HT20 CH06 2437MHz - L	
1	Vertical	Fundamental
Peak	<p>Site : 03CH10-HY Condition : PEAK BE 74 3m HORN 9120D-HF VERTICAL</p>	<p>Site : 03CH10-HY Condition : PEAK 74 3m HORN 9120D-HF VERTICAL</p>
Avg.	<p>Site : 03CH10-HY Condition : AV6 54 3m HORN 9120D-HF VERTICAL</p>	<p>Site : 03CH10-HY Condition : AV6 54 3m HORN 9120D-HF VERTICAL</p>



WIFI	2.4GHz 2400~2483.5MHz Band Edge @ 3m	
ANT	802.11n HT20 CH06 2437MHz - R	
1	Vertical	Fundamental
Peak	<p>Site : 03CH10-HY Condition : PEAK_BE_74 3m HORN 91200-HF VERTICAL</p>	Left Blank
Avg.	<p>Site : 03CH10-HY Condition : AVG_BE_54 3m HORN 91200-HF VERTICAL</p>	Left Blank

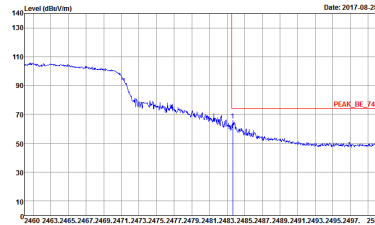
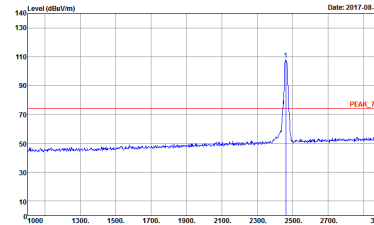
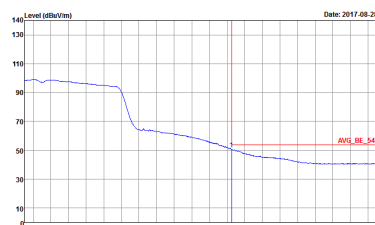
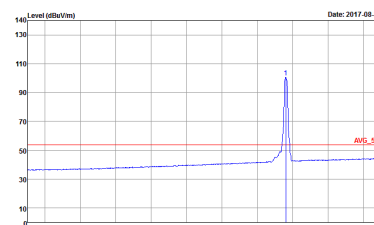

WIFI	2.4GHz 2400~2483.5MHz Band Edge @ 3m	
ANT	802.11n HT20 CH11 2462MHz	
1	Horizontal	Fundamental
<p>Peak</p>	 <p>Site : 03CH10-HY Condition : PEAK BE 74 3m HORN 9120D-HF HORIZONTAL</p>	 <p>Site : 03CH10-HY Condition : PEAK 74 3m HORN 9120D-HF HORIZONTAL</p>
<p>Avg.</p>	 <p>Site : 03CH10-HY Condition : AVG BE 54 3m HORN 9120D-HF HORIZONTAL</p>	 <p>Site : 03CH10-HY Condition : AVG 54 3m HORN 9120D-HF HORIZONTAL</p>



WIFI	2.4GHz 2400~2483.5MHz Fundamental @ 3m	
ANT	802.11n HT20 CH11 2462MHz	
1	Vertical	Fundamental
Peak	<p>Site : 03CH10-HY Condition : PEAK_BE_74 3m HORN 9120D-HF VERTICAL</p>	<p>Site : 03CH10-HY Condition : PEAK_74 3m HORN 9120D-HF VERTICAL</p>
Avg.	<p>Site : 03CH10-HY Condition : AVG_BE_54 3m HORN 9120D-HF VERTICAL</p>	<p>Site : 03CH10-HY Condition : AVG_54 3m HORN 9120D-HF VERTICAL</p>



2.4GHz 2400~2483.5MHz
WIFI 802.11b (Harmonic @ 3m)

WIFI	2.4GHz 2400~2483.5MHz Harmonic @ 3m	
ANT	802.11b CH01 2412MHz	
1	Horizontal	Vertical
Peak Avg.	<p>Site : 03CH10-14Y Condition : PEAK 74 3m HORN 9170 40G 0584 HORIZONTAL</p>	<p>Site : 03CH10-14Y Condition : PEAK 74 3m HORN 9170 40G 0584 VERTICAL</p>



WIFI	2.4GHz 2400~2483.5MHz Harmonic @ 3m	
ANT	802.11b CH06 2437MHz	
1	Horizontal	Vertical
Peak Avg.	<p>Site : 03CH10-HY Condition : PEAK 74 3m HORN 9170 40G 0584 HORIZONTAL</p>	<p>Site : 03CH10-HY Condition : PEAK 74 3m HORN 9170 40G 0584 VERTICAL</p>

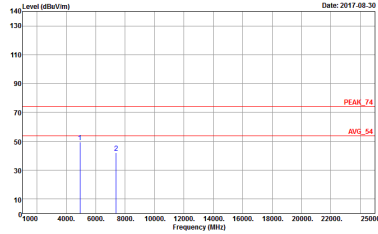
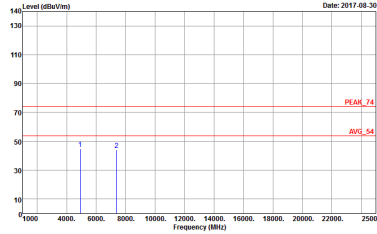

WIFI	2.4GHz 2400~2483.5MHz Harmonic @ 3m	
ANT	802.11b CH11 2462MHz	
1	Horizontal	Vertical
Peak Avg.	 <p>Site : 03CH10-HY Condition : PEAK 74 3m HORN 9170 40G 0584 HORIZONTAL</p>	 <p>Site : 03CH10-HY Condition : PEAK 74 3m HORN 9170 40G 0584 VERTICAL</p>



2.4GHz 2400~2483.5MHz
 WIFI 802.11g (Harmonic @ 3m)

WIFI	2.4GHz 2400~2483.5MHz Harmonic @ 3m	
ANT	802.11g CH01 2412MHz	
1	Horizontal	Vertical
Peak Avg.	<p>Site : 03CH10-14Y Condition : PEAK 74 3m HORN 9170 40G 0584 HORIZONTAL</p>	<p>Site : 03CH10-14Y Condition : PEAK 74 3m HORN 9170 40G 0584 VERTICAL</p>

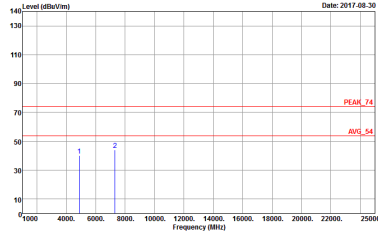
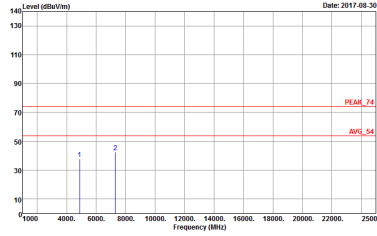

WIFI	2.4GHz 2400~2483.5MHz Harmonic @ 3m	
ANT	802.11g CH06 2437MHz	
1	Horizontal	Vertical
<p>Peak</p> <p>Avg.</p>	 <p>Site : 03CH10-HY Condition : PEAK_74 3m HORN 9170 40G 0584 HORIZONTAL</p>	 <p>Site : 03CH10-HY Condition : PEAK_74 3m HORN 9170 40G 0584 VERTICAL</p>



WIFI	2.4GHz 2400~2483.5MHz Harmonic @ 3m	
ANT	802.11g CH11 2462MHz	
1	Horizontal	Vertical
Peak Avg.	<p>Site : 03CH10-HY Condition : PEAK 74 3m HORN 9170 40G 0584 HORIZONTAL</p>	<p>Site : 03CH10-HY Condition : PEAK 74 3m HORN 9170 40G 0584 VERTICAL</p>



2.4GHz 2400~2483.5MHz
WIFI 802.11n HT20 (Harmonic @ 3m)

WIFI	2.4GHz 2400~2483.5MHz Harmonic @ 3m	
ANT	802.11n HT20 CH01 2412MHz	
1	Horizontal	Vertical
Peak Avg.	<p>Site : :03CH0-14Y Condition : :PEAK_74 3m HORN 9170 40G 0584 HORIZONTAL</p>	<p>Site : :03CH0-14Y Condition : :PEAK_74 3m HORN 9170 40G 0584 VERTICAL</p>



WIFI	2.4GHz 2400~2483.5MHz Harmonic @ 3m	
ANT	802.11n HT20 CH06 2437MHz	
1	Horizontal	Vertical
Peak Avg.	<p>Site : 03CH10-HY Condition : PEAK_74 3m HORN 9170 40G 0584 HORIZONTAL</p>	<p>Site : 03CH10-HY Condition : PEAK_74 3m HORN 9170 40G 0584 VERTICAL</p>

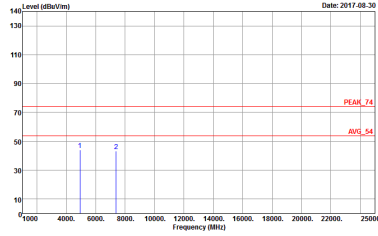
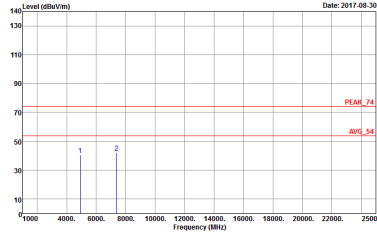

WIFI	2.4GHz 2400~2483.5MHz Harmonic @ 3m	
ANT	802.11n HT20 CH11 2462MHz	
1	Horizontal	Vertical
<p>Peak Avg.</p>	 <p>Site : 03CH10-HY Condition : PEAK_74 3m HORN 9170 40G 0584 HORIZONTAL</p>	 <p>Site : 03CH10-HY Condition : PEAK_74 3m HORN 9170 40G 0584 VERTICAL</p>



Emission below 1GHz
2.4GHz WIFI 802.11b (LF)

WIFI	2.4GHz 2400~2483.5MHz	
ANT	802.11b LF	
1	Horizontal	Vertical
QP / Peak	<p>Horizontal emission spectrum plot showing Level (dBuV/m) vs Frequency (MHz) from 50 to 1000 MHz. The plot shows a blue signal line with several peaks and a red step function. The date is 2017-09-05. Site: 03CH10-14Y, Condition: QP-3m BE-LOG 6111D-LF HORIZONTAL.</p>	<p>Vertical emission spectrum plot showing Level (dBuV/m) vs Frequency (MHz) from 50 to 1000 MHz. The plot shows a blue signal line with several peaks and a red step function. The date is 2017-09-05. Site: 03CH10-14Y, Condition: QP-3m BE-LOG 6111D-LF VERTICAL.</p>



Emission below 1GHz
2.4GHz WIFI 802.11g (LF)

WIFI	2.4GHz 2400~2483.5MHz	
ANT	802.11g LF	
1	Horizontal	Vertical
QP / Peak		



Emission below 1GHz
2.4GHz WIFI 802.11n HT20 (LF)

Table with 2 columns: Horizontal and Vertical. Row 1: WIFI 2.4GHz 2400~2483.5MHz. Row 2: ANT 802.11n HT20 LF. Row 3: 1. Row 4: QP / Peak. Each column contains a graph of Level (dBuV/m) vs Frequency (MHz) with a red QP line and a blue signal line.



Appendix E. Duty Cycle Plots

Band	Duty Cycle(%)	T(us)	1/T(kHz)	VBW Setting
802.11b	100.00	-	-	10Hz
802.11g	96.53	1390.00	0.72	1kHz
2.4GHz 802.11n HT20	97.04	1310.00	0.76	1kHz



802.11b

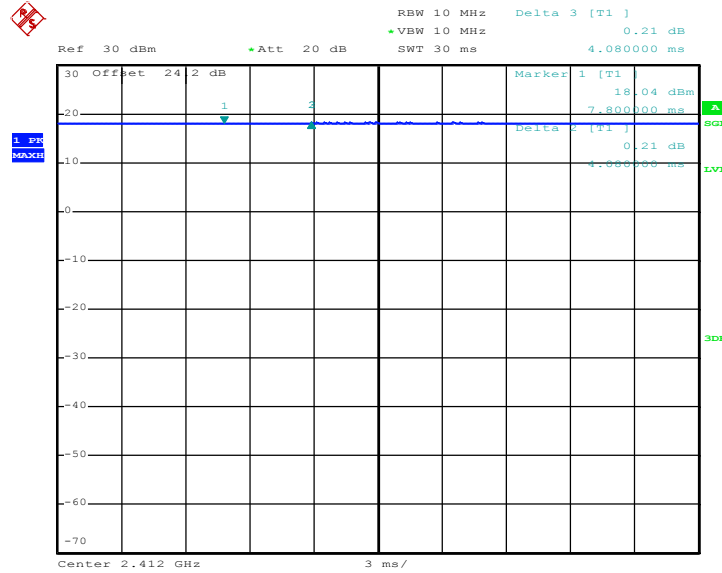

Date: 24.AUG.2017 09:34:51

802.11g

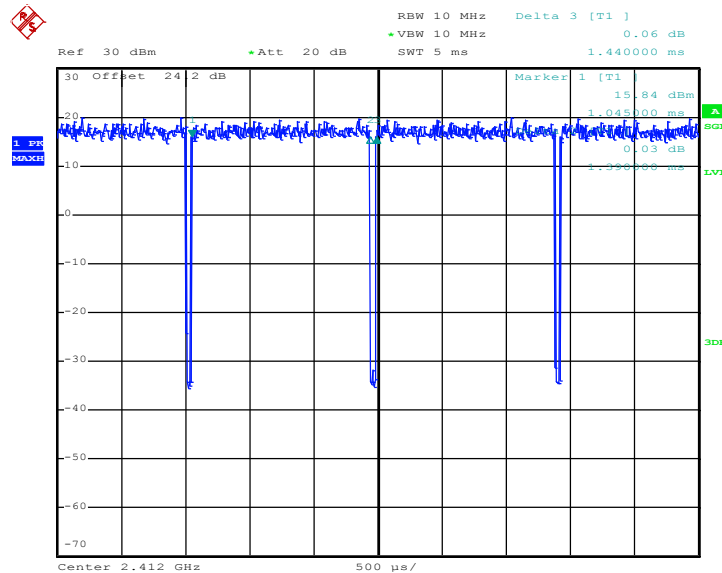

Date: 24.AUG.2017 09:36:23



802.11n HT20

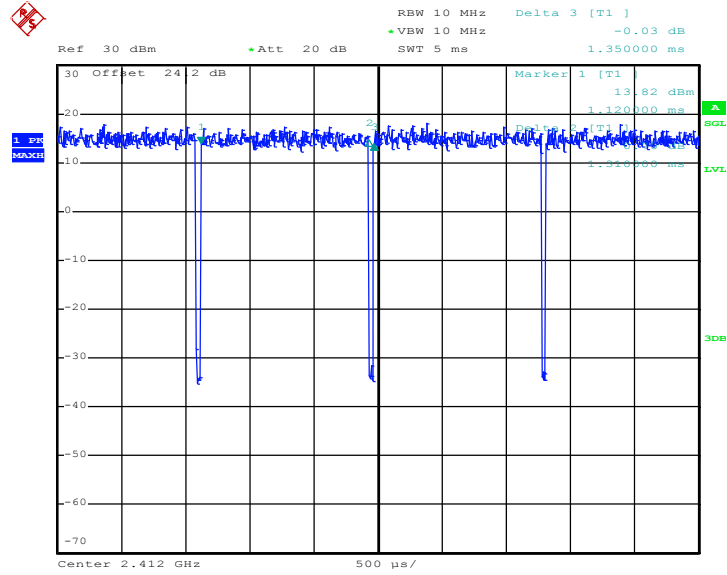

Date: 24.AUG.2017 09:37:12