



FCC RADIO TEST REPORT

FCC ID : PY7-34943G
Equipment : GSM/WCDMA/LTE Phone with BT, DTS/UNII
a/b/g/n/ac, NFC and GNSS
Brand Name : SONY
Applicant : Sony Corporation
1-7-1 Konan Minato-ku Tokyo, 108-0076 Japan
Manufacturer : Sony Corporation
1-7-1 Konan Minato-ku Tokyo, 108-0076 Japan
Standard : FCC Part 15 Subpart C §15.247
Test Date(s) : Dec. 12, 2021 ~ Jan. 28, 2022

We, Sporton International Inc. (Kunshan), would like to declare that the tested sample has been evaluated in accordance with the test procedures and has been in compliance with the applicable technical standards.

The test results in this report apply exclusively to the tested model / sample. Without written approval of Sporton International Inc. (Kunshan), the test report shall not be reproduced except in full.

Jason Jia

Reviewed by: Jason Jia / Supervisor

Alex Wang

Approved by: Alex Wang / Manager



Sporton International Inc. (Kunshan)

No. 1098, Pengxi North Road, Kunshan Economic Development Zone Jiangsu Province 215300
People's Republic of China



Table of Contents

History of this test report.....3

Summary of Test Result.....4

1 General Description.....5

 1.1 Product Feature of Equipment Under Test.....5

 1.2 Modification of EUT5

 1.3 Testing Location5

 1.4 Applicable Standards.....6

2 Test Configuration of Equipment Under Test.....7

 2.1 Carrier Frequency Channel7

 2.2 Test Mode.....8

 2.3 Connection Diagram of Test System.....9

 2.4 Support Unit used in test configuration and system10

 2.5 EUT Operation Test Setup10

 2.6 Measurement Results Explanation Example.....10

3 Test Result.....11

 3.1 Number of Channel Measurement11

 3.2 Hopping Channel Separation Measurement13

 3.3 Dwell Time Measurement.....17

 3.4 20dB and 99% Bandwidth Measurement19

 3.5 Output Power Measurement.....26

 3.6 Conducted Band Edges Measurement27

 3.7 Conducted Spurious Emission Measurement32

 3.8 Radiated Band Edges and Spurious Emission Measurement39

 3.9 AC Conducted Emission Measurement.....44

 3.10 Antenna Requirements.....46

4 List of Measuring Equipment47

5 Uncertainty of Evaluation48

Appendix A. Conducted Test Results

Appendix B. AC Conducted Emission Test Result

Appendix C. Radiated Spurious Emission

Appendix D. Radiated Spurious Emission Plots

Appendix E. Duty Cycle Plots



Summary of Test Result

Report Clause	Ref Std. Clause	Test Items	Result (PASS/FAIL)	Remark
3.1	15.247(a)(1)	Number of Channels	Pass	-
3.2	15.247(a)(1)	Hopping Channel Separation	Pass	-
3.3	15.247(a)(1)	Dwell Time of Each Channel	Pass	-
3.4	15.247(a)(1)	20dB Bandwidth	Pass	-
3.4	2.1049	99% Occupied Bandwidth	Reporting only	-
3.5	15.247(b)(1)	Peak Output Power	Pass	-
3.6	15.247(d)	Conducted Band Edges	Pass	-
3.7	15.247(d)	Conducted Spurious Emission	Pass	-
3.8	15.247(d)	Radiated Band Edges and Radiated Spurious Emission	Pass	Under limit 13.68 dB at 30.000 MHz
3.9	15.207	AC Conducted Emission	Pass	Under limit 13.53 dB at 0.209 MHz
3.10	15.203 & 15.247(b)	Antenna Requirement	Pass	-

Declaration of Conformity:

The test results with all measurement uncertainty excluded are presented in accordance with the regulation limits or requirements declared by manufacturers.

Comments and Explanations:

The declared of product specification for EUT presented in the report are provided by the manufacturer, and the manufacturer takes all the responsibilities for the accuracy of product specification.



1 General Description

1.1 Product Feature of Equipment Under Test

GSM/WCDMA/LTE, Bluetooth, DTS/UNII a/b/g/n/ac, NFC and GNSS.

Standards-related Product Specification	
Antenna Type / Gain	Ant. 6: PIFA Antenna with gain 2.3 dBi

Remark: The above EUT's information was declared by manufacturer. Please refer to Comments and Explanations in report summary.

EUT Information List			
HW Version	SW Version	IMEI Code	Performed Test Item
A	0.549	004402543254167/ 004402543254175	RF conducted measurement
		004402543253961	Radiated Spurious Emission
		004402543254142/ 004402543254159	AC Conducted Emission

Note: For other wireless features of this EUT, test report will be issued separately.

1.2 Modification of EUT

No modifications are made to the EUT during all test items.

1.3 Testing Location

Sporton International Inc. (Kunshan) is accredited to ISO/IEC 17025:2017 by American Association for Laboratory Accreditation with Certificate Number 5145.02.

Test Firm	Sporton International Inc. (Kunshan)		
Test Site Location	No. 1098, Pengxi North Road, Kunshan Economic Development Zone Jiangsu Province 215300 People's Republic of China TEL : +86-512-57900158 FAX : +86-512-57900958		
Test Site No.	Sporton Site No.	FCC Designation No.	FCC Test Firm Registration No.
	CO01-KS 03CH06-KS TH01-KS	CN1257	314309



1.4 Applicable Standards

According to the specifications of the manufacturer, the EUT must comply with the requirements of the following standards:

- ♦ FCC Part 15 Subpart C §15.247
- ♦ FCC KDB Publication No. 558074 D01 DTS Meas. Guidance v05r02
- ♦ FCC KDB 414788 D01 Radiated Test Site v01r01
- ♦ ANSI C63.10-2013

Remark:

1. All test items were verified and recorded according to the standards and without any deviation during the test.
2. This EUT has also been tested and complied with the requirements of FCC Part 15, Subpart B, recorded in a separate test report.



2 Test Configuration of Equipment Under Test

2.1 Carrier Frequency Channel

Frequency Band	Channel	Freq. (MHz)	Channel	Freq. (MHz)	Channel	Freq. (MHz)
2400-2483.5 MHz	0	2402	27	2429	54	2456
	1	2403	28	2430	55	2457
	2	2404	29	2431	56	2458
	3	2405	30	2432	57	2459
	4	2406	31	2433	58	2460
	5	2407	32	2434	59	2461
	6	2408	33	2435	60	2462
	7	2409	34	2436	61	2463
	8	2410	35	2437	62	2464
	9	2411	36	2438	63	2465
	10	2412	37	2439	64	2466
	11	2413	38	2440	65	2467
	12	2414	39	2441	66	2468
	13	2415	40	2442	67	2469
	14	2416	41	2443	68	2470
	15	2417	42	2444	69	2471
	16	2418	43	2445	70	2472
	17	2419	44	2446	71	2473
	18	2420	45	2447	72	2474
	19	2421	46	2448	73	2475
	20	2422	47	2449	74	2476
	21	2423	48	2450	75	2477
	22	2424	49	2451	76	2478
	23	2425	50	2452	77	2479
	24	2426	51	2453	78	2480
	25	2427	52	2454	-	-
	26	2428	53	2455	-	-



2.2 Test Mode

- a. The EUT has been associated with peripherals and configuration operated in a manner tended to maximize its emission characteristics in a typical application. Frequency range investigated: conduction emission (150 kHz to 30 MHz), radiation emission (9 kHz to the 10th harmonic of the highest fundamental frequency or to 40 GHz, whichever is lower). For radiated measurement, the measured emission level of the EUT was maximized by rotating the EUT on a turntable, adjusting the orientation of the EUT and EUT antenna in three orthogonal axis (X: flat, Y: portrait, Z: landscape), and adjusting the measurement antenna orientation, following C63.10 exploratory test procedures and find X plane as worst plane, and the worst mode of radiated spurious emissions is Bluetooth 1Mbps mode, and recorded in this report. The worst case position of the EUT was investigated under two configurations: EUT with AC adapter and earphone, EUT with standalone. The EUT with standalone configuration was determined to be worst-case configurations; therefore, all final tests were performed on the EUT with standalone
- b. AC power line Conducted Emission was tested under maximum output power.

The following summary table is showing all test modes to demonstrate in compliance with the standard.

Summary table of Test Cases			
Test Item	Data Rate / Modulation		
	Bluetooth BR 1Mbps GFSK	Bluetooth EDR 2Mbps $\pi/4$ -DQPSK	Bluetooth EDR 3Mbps 8-DPSK
Conducted Test Cases	Mode 1: CH00_2402 MHz	Mode 4: CH00_2402 MHz	Mode 7: CH00_2402 MHz
	Mode 2: CH39_2441 MHz	Mode 5: CH39_2441 MHz	Mode 8: CH39_2441 MHz
	Mode 3: CH78_2480 MHz	Mode 6: CH78_2480 MHz	Mode 9: CH78_2480 MHz
Radiated Test Cases	Bluetooth BR 1Mbps GFSK		
	Mode 1: CH00_2402 MHz for 1Mbps		
	Mode 2: CH39_2441 MHz for 1Mbps		
	Mode 3: CH78_2480 MHz for 1Mbps		
	Mode 4: CH00_2402 MHz for 2Mbps		
	Mode 5: CH39_2441 MHz for 2Mbps		
	Mode 6: CH78_2480 MHz for 2Mbps		
	Mode 7: CH00_2402 MHz for 3Mbps		
	Mode 8: CH39_2441 MHz for 3Mbps		
	Mode 9: CH78_2480 MHz for 3Mbps		
AC Conducted Emission	Mode 1 : GSM850 Idle + Bluetooth Link + WLAN (2.4GHz) Link + Earphone + USB Cable 1(Charging from Adapter)		

2.3 Connection Diagram of Test System

<AC Conducted Emission>

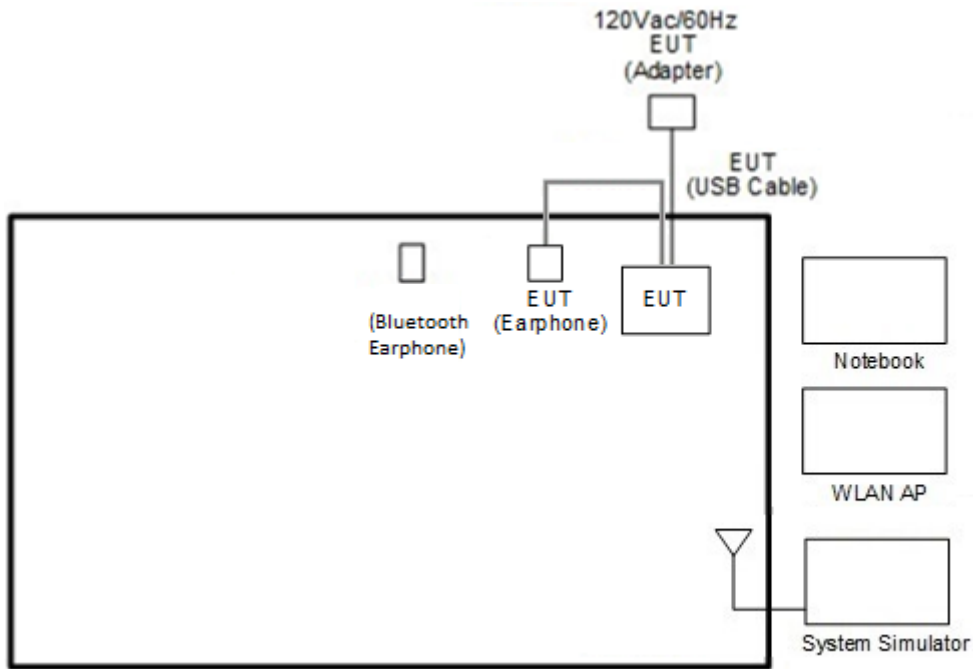

<Bluetooth Tx Mode>

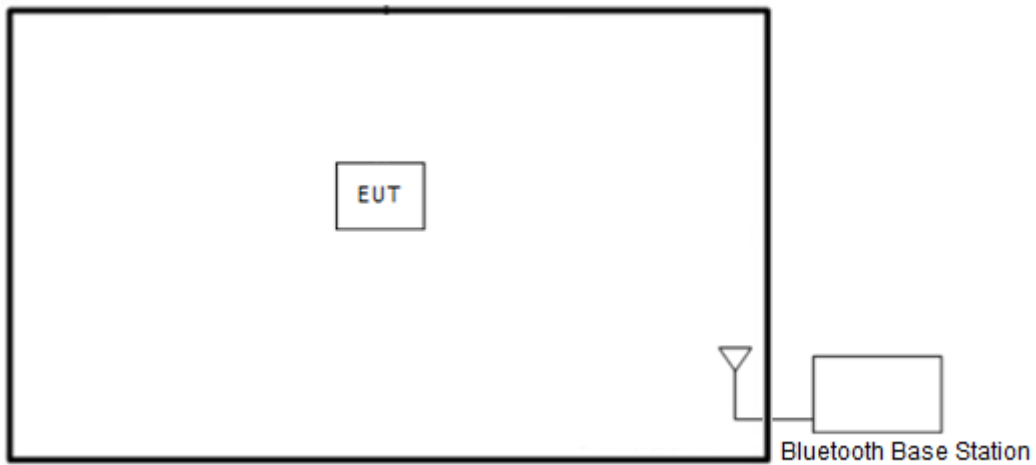

2.4 Support Unit used in test configuration and system

Item	Equipment	Brand Name	Model Name	FCC ID	Data Cable	Power Cord
1.	LTE Base Station	Anritus	MT8821C	N/A	N/A	Unshielded,1.8m
2.	BT Base Station	R&S	CBT	N/A	N/A	Unshielded, 1.8 m
3.	Notebook	Lenovo	G480	QDS-BRCM1050I	N/A	shielded cable DC O/P 1.8m , Unshielded AC I/P cable 1.8m
4.	WLAN AP	D-link	DIR-655	KA21R655B1	N/A	Unshielded,1.8m
5.	Bluetooth Earphone	Sony	SBH82D	PY7-33726V	N/A	N/A

2.5 EUT Operation Test Setup

The RF test items, utility “FTM” was installed in Notebook which was programmed in order to make the EUT get into the engineering modes to provide channel selection, power level, data rate and the application type and for continuous transmitting signals.

For AC power line conducted emissions, the EUT was set to connect with the WLAN AP under large package sizes transmission.

2.6 Measurement Results Explanation Example

For all conducted test items:

The offset level is set in the spectrum analyzer to compensate the RF cable loss between EUT conducted output port and spectrum analyzer. With the offset compensation, the spectrum analyzer reading level is exactly the EUT RF output level.

Example:

The spectrum analyzer offset is derived from RF cable loss.

Offset = RF cable loss.

Following shows an offset computation example with cable loss 5.8 dB.

$$\begin{aligned}
 \text{Offset(dB)} &= \text{RF cable loss(dB)}. \\
 &= 5.8 \text{ (dB)}
 \end{aligned}$$

3 Test Result

3.1 Number of Channel Measurement

3.1.1 Limits of Number of Hopping Frequency

Frequency hopping systems in the 2400-2483.5 MHz band shall use at least 15 channels.

3.1.2 Measuring Instruments

See list of measuring equipment of this test report.

3.1.3 Test Procedure

1. The testing follows ANSI C63.10-2013 clause 7.8.3.
2. The RF output of EUT was connected to the spectrum analyzer by RF cable and attenuator. The path loss was compensated to the results for each measurement.
3. Set the maximum power setting and enable the EUT to transmit continuously.
4. Enable the EUT hopping function.
5. Use the following spectrum analyzer settings: Span = the frequency band of operation; RBW = 300 kHz; VBW \geq RBW; Sweep = auto; Detector function = peak; Trace = max hold.
6. The number of hopping frequency used is defined as the number of total channel.
7. Record the measurement data derived from spectrum analyzer.

3.1.4 Test Setup

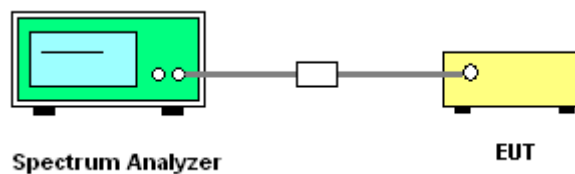



3.1.5 Test Result of Number of Hopping Frequency

Please refer to Appendix A.

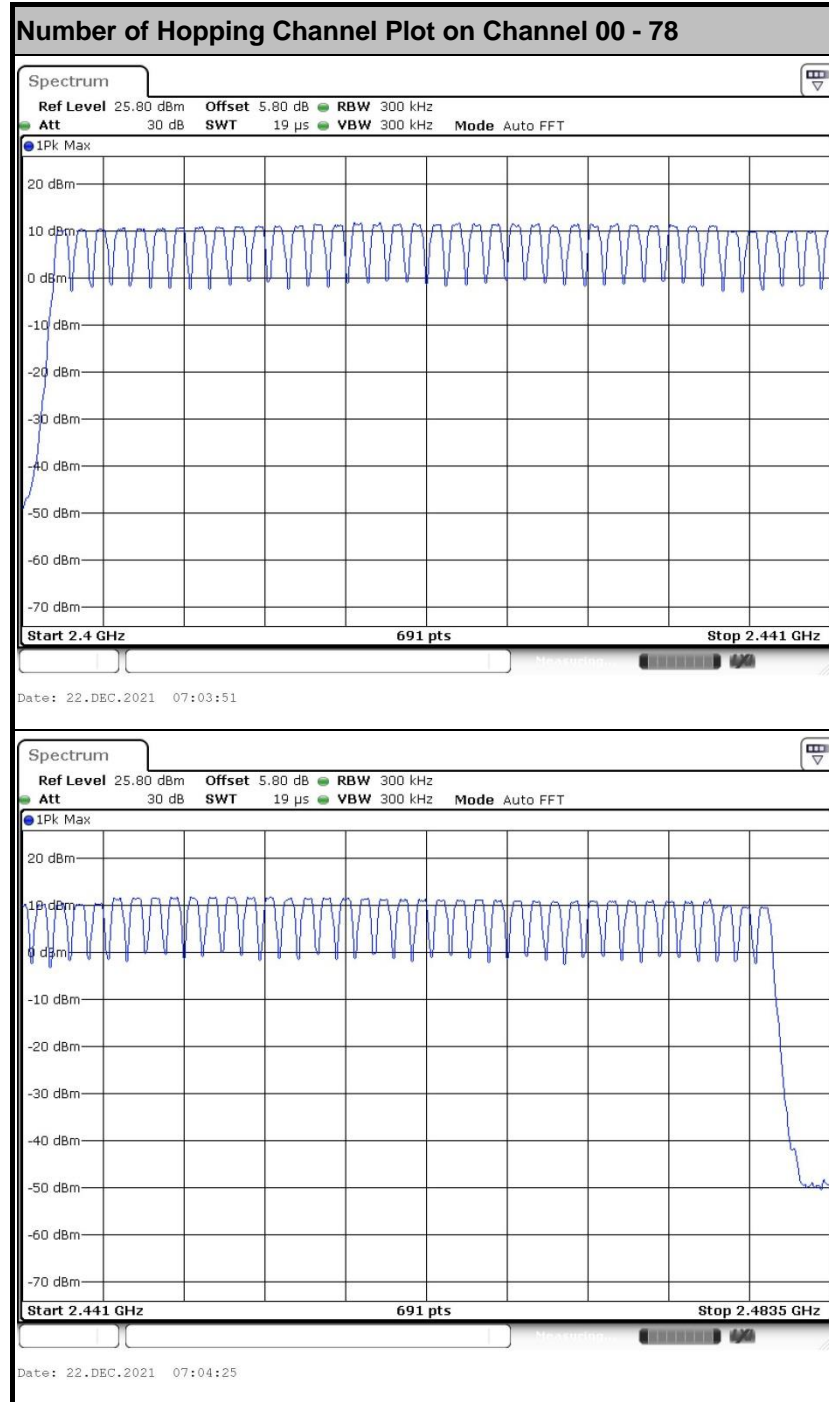

3.2 Hopping Channel Separation Measurement

3.2.1 Limit of Hopping Channel Separation

Frequency hopping systems operating in the 2400-2483.5 MHz band may have hopping channel carrier frequencies that are separated by 25 kHz or two-thirds of the 20 dB bandwidth of the hopping channel, whichever is greater.

3.2.2 Measuring Instruments

See list of measuring equipment of this test report.

3.2.3 Test Procedures

1. The testing follows ANSI C63.10-2013 clause 7.8.2.
2. The RF output of EUT was connected to the spectrum analyzer by RF cable and attenuator. The path loss was compensated to the results for each measurement.
3. Set the maximum power setting and enable the EUT to transmit continuously.
4. Enable the EUT hopping function.
5. Use the following spectrum analyzer settings:
Span = wide enough to capture the peaks of two adjacent channels;
RBW = 300 kHz; VBW \geq RBW; Sweep = auto; Detector function = peak; Trace = max hold.
6. Measure and record the results in the test report.

3.2.4 Test Setup

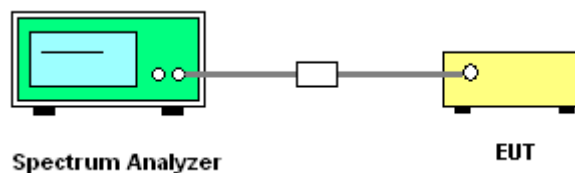

3.2.5 Test Result of Hopping Channel Separation

Please refer to Appendix A.



<1Mbps>

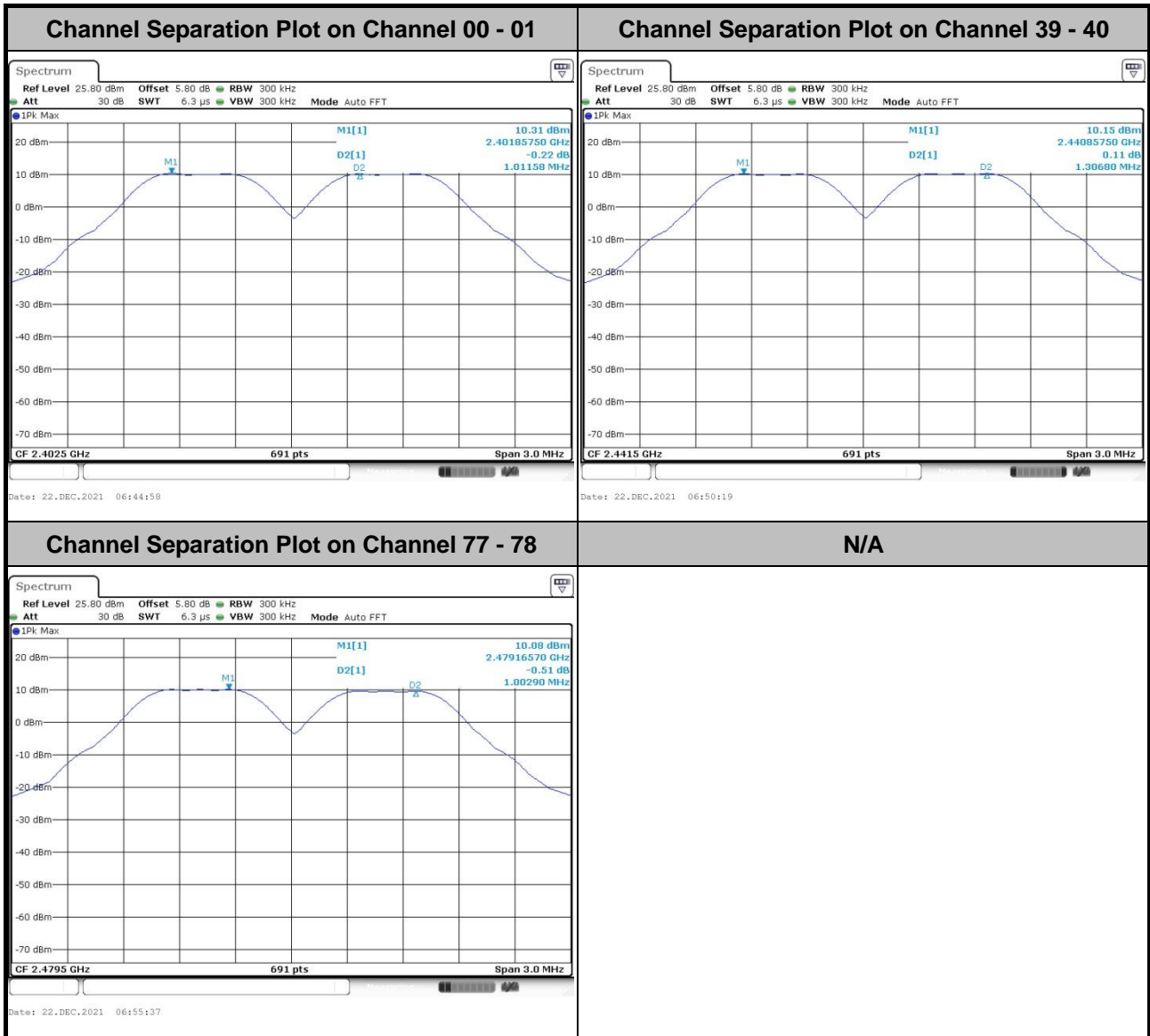



<2Mbps>

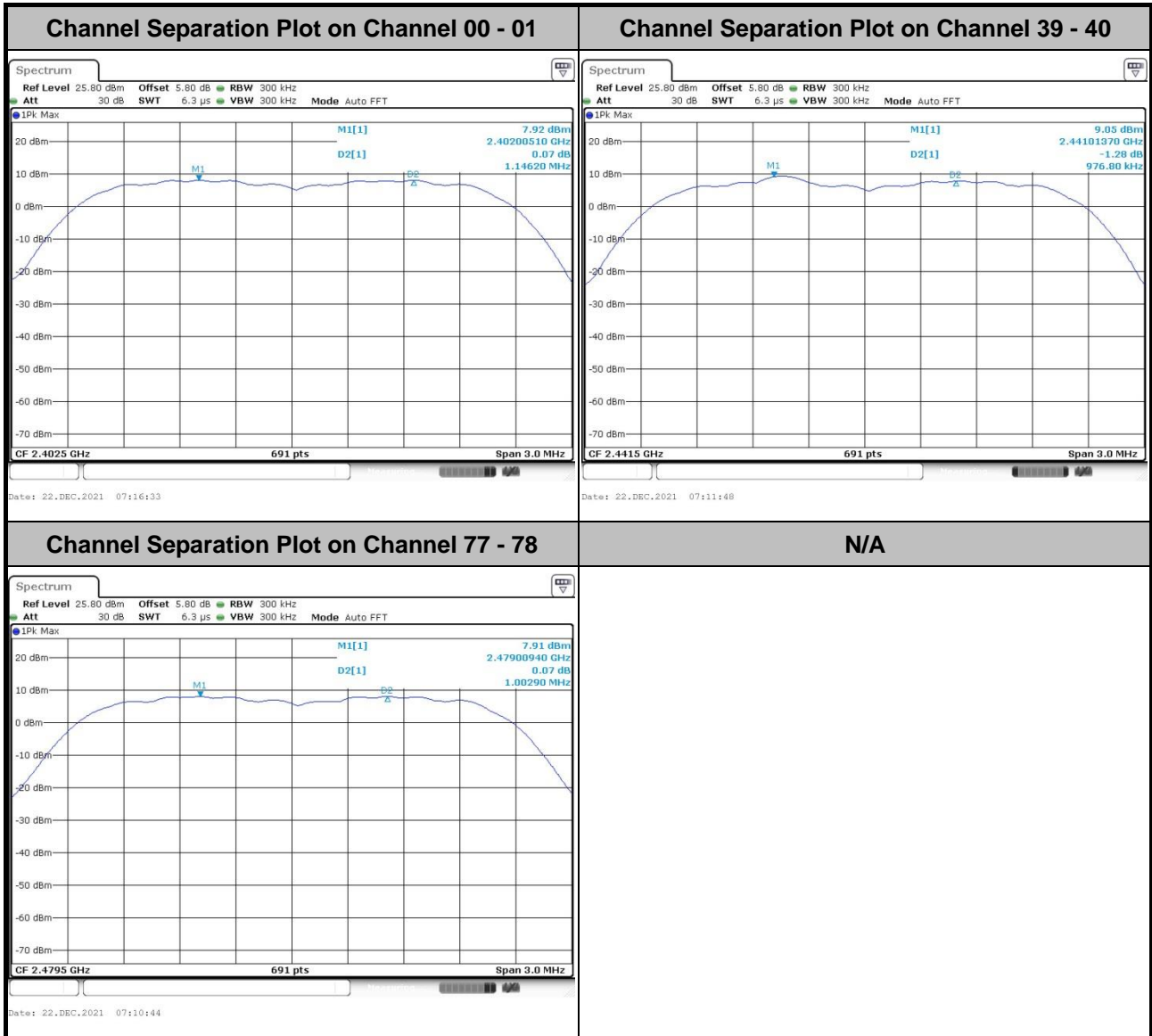



<3Mbps>

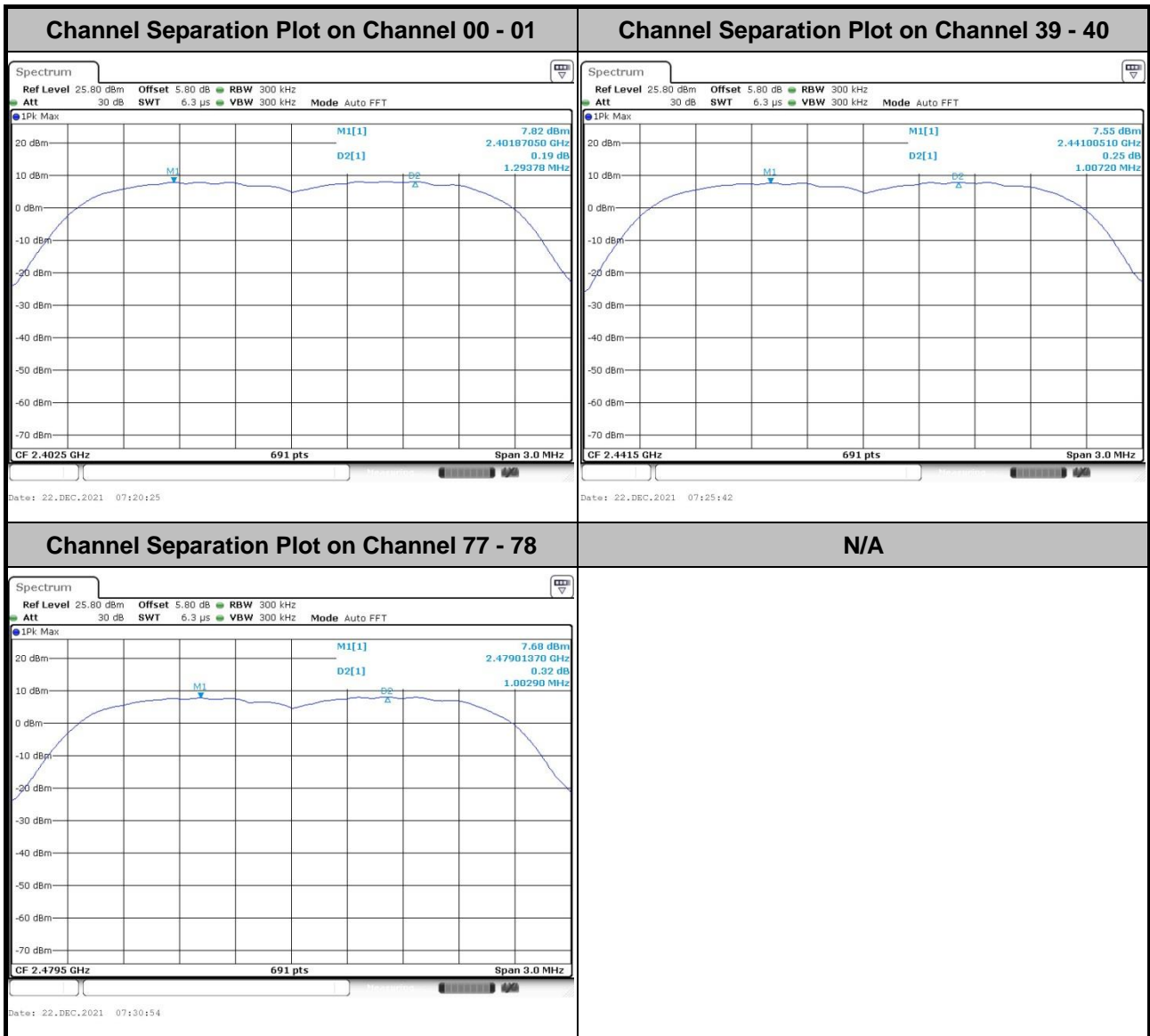

3.3 Dwell Time Measurement

3.3.1 Limit of Dwell Time

The average time of occupancy on any channel shall not be greater than 0.4 seconds within a period of 0.4 seconds multiplied by the number of hopping channels employed.

3.3.2 Measuring Instruments

See list of measuring equipment of this test report.

3.3.3 Test Procedures

1. The testing follows ANSI C63.10-2013 clause 7.8.4.
2. The RF output of EUT was connected to the spectrum analyzer by RF cable and attenuator. The path loss was compensated to the results for each measurement.
3. Set the maximum power setting and enable the EUT to transmit continuously.
4. Enable the EUT hopping function.
5. Use the following spectrum analyzer settings: Span = zero span, centered on a hopping channel; RBW = 1 MHz; VBW \geq RBW; Sweep = as necessary to capture the entire dwell time per hopping channel; Detector function = peak; Trace = max hold.
6. Measure and record the results in the test report.

3.3.4 Test Setup

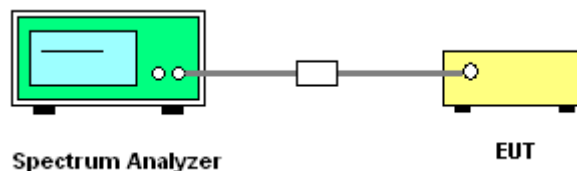



3.3.5 Test Result of Dwell Time

Please refer to Appendix A.

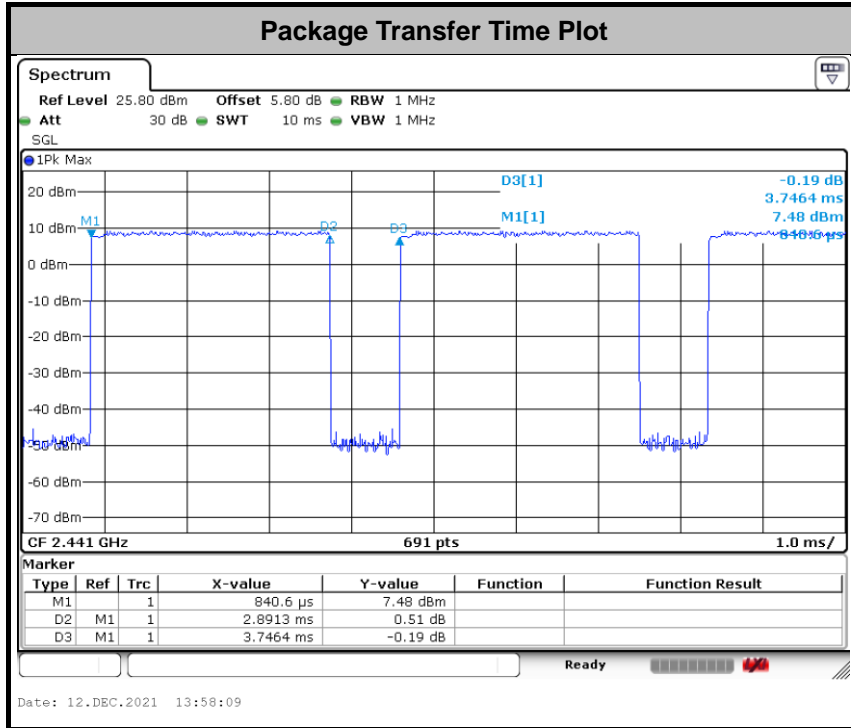

Remark:

- In normal mode, hopping rate is 1600 hops/s with 6 slots in 79 hopping channels. With channel hopping rate (1600 / 6 / 79) in Occupancy Time Limit (0.4 x 79) (s), Hops Over Occupancy Time comes to (1600 / 6 / 79) x (0.4 x 79) = 106.67 hops.
- In AFH mode, hopping rate is 800 hops/s with 6 slots in 20 hopping channels. With channel hopping rate (800 / 6 / 20) in Occupancy Time Limit (0.4 x 20) (s), Hops Over Occupancy Time comes to (800 / 6 / 20) x (0.4 x 20) = 53.33 hops.
- Dwell Time(s) = Hops Over Occupancy Time (hops) x Package Transfer Time

3.4 20dB and 99% Bandwidth Measurement

3.4.1 Limit of 20dB and 99% Bandwidth

Reporting only

3.4.2 Measuring Instruments

See list of measuring equipment of this test report.

3.4.3 Test Procedures

1. The testing follows ANSI C63.10-2013 clause 6.9.2 and 6.9.3.
2. The RF output of EUT was connected to the spectrum analyzer by RF cable and attenuator. The path loss was compensated to the results for each measurement.
3. Set the maximum power setting and enable the EUT to transmit continuously.
4. Use the following spectrum analyzer settings for 20 dB Bandwidth measurement.
Span = approximately 2 to 5 times the 20 dB bandwidth, centered on a hopping channel;
RBW \geq 1% of the 20 dB bandwidth; VBW \geq RBW; Sweep = auto; Detector function = peak;
Trace = max hold.
5. Use the following spectrum analyzer settings for 99 % Bandwidth measurement.
Span = approximately 1.5 to 5 times the 99% bandwidth, centered on a hopping channel;
RBW \geq 1-5% of the 99% bandwidth; VBW \geq 3 * RBW; Sweep = auto; Detector function = peak;
Trace = max hold.
6. Measure and record the results in the test report.

3.4.4 Test Setup

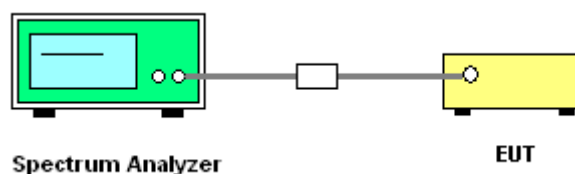

3.4.5 Test Result of 20dB Bandwidth

Please refer to Appendix A.



<1Mbps>

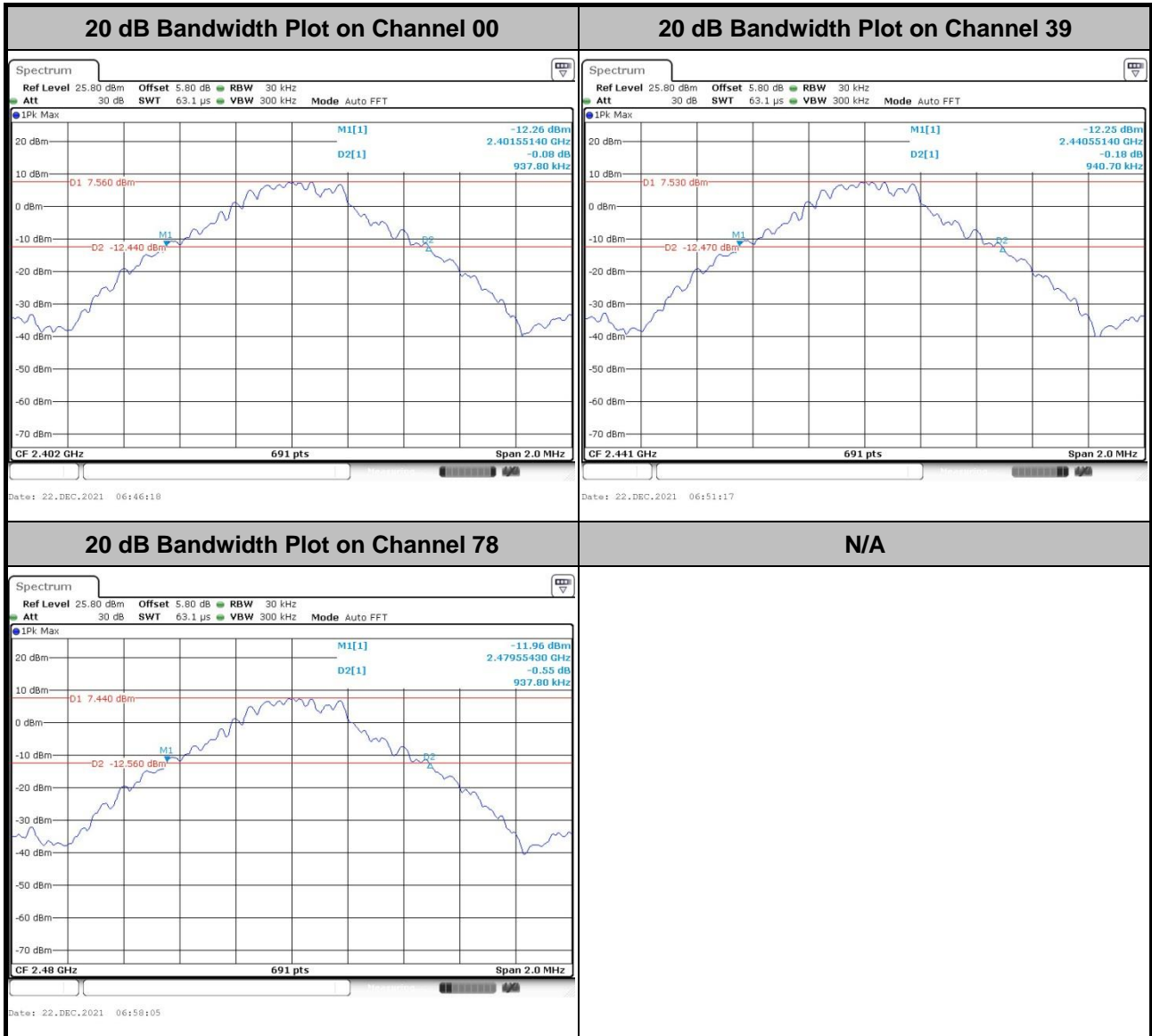



<2Mbps>

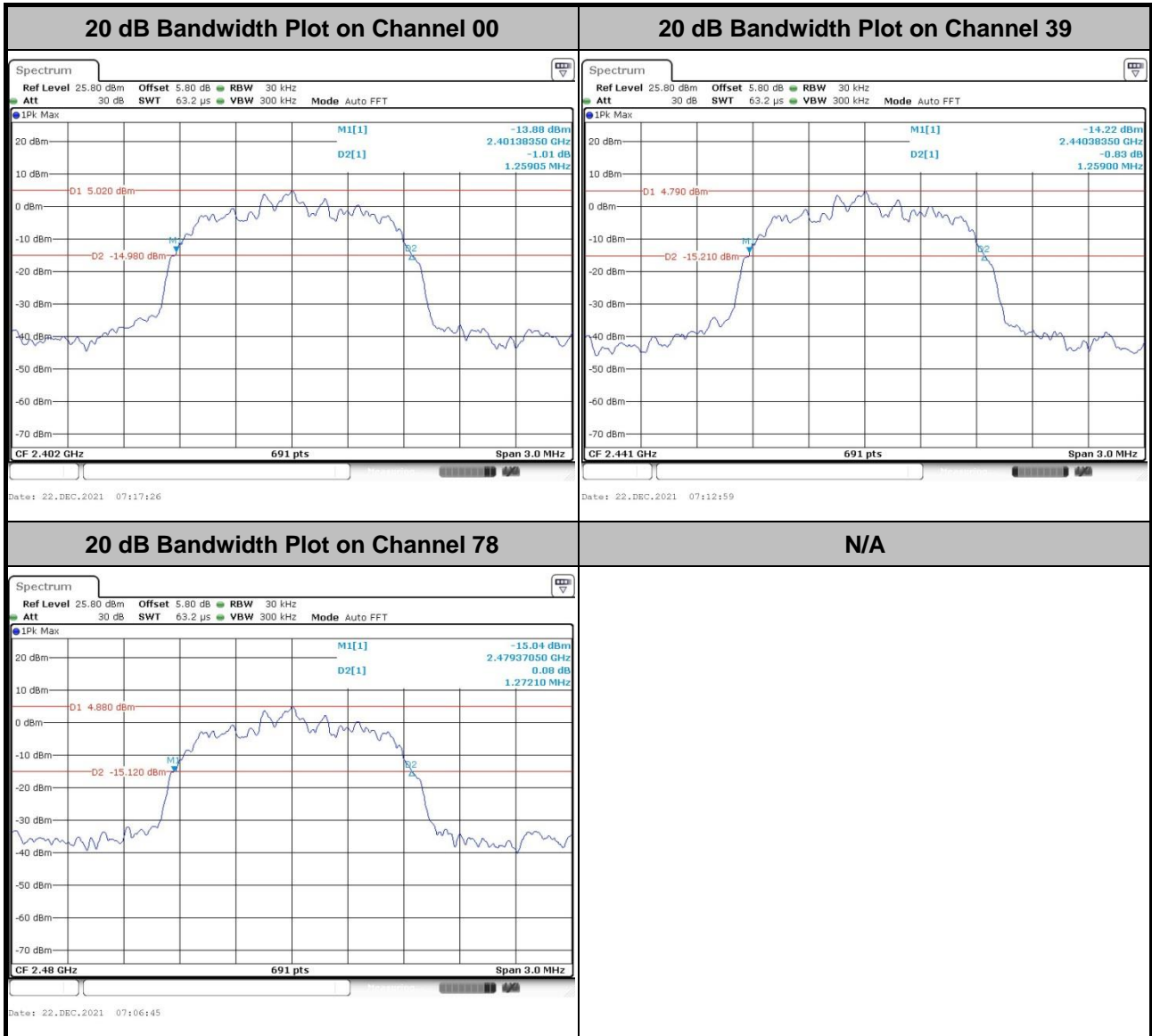



<3Mbps>

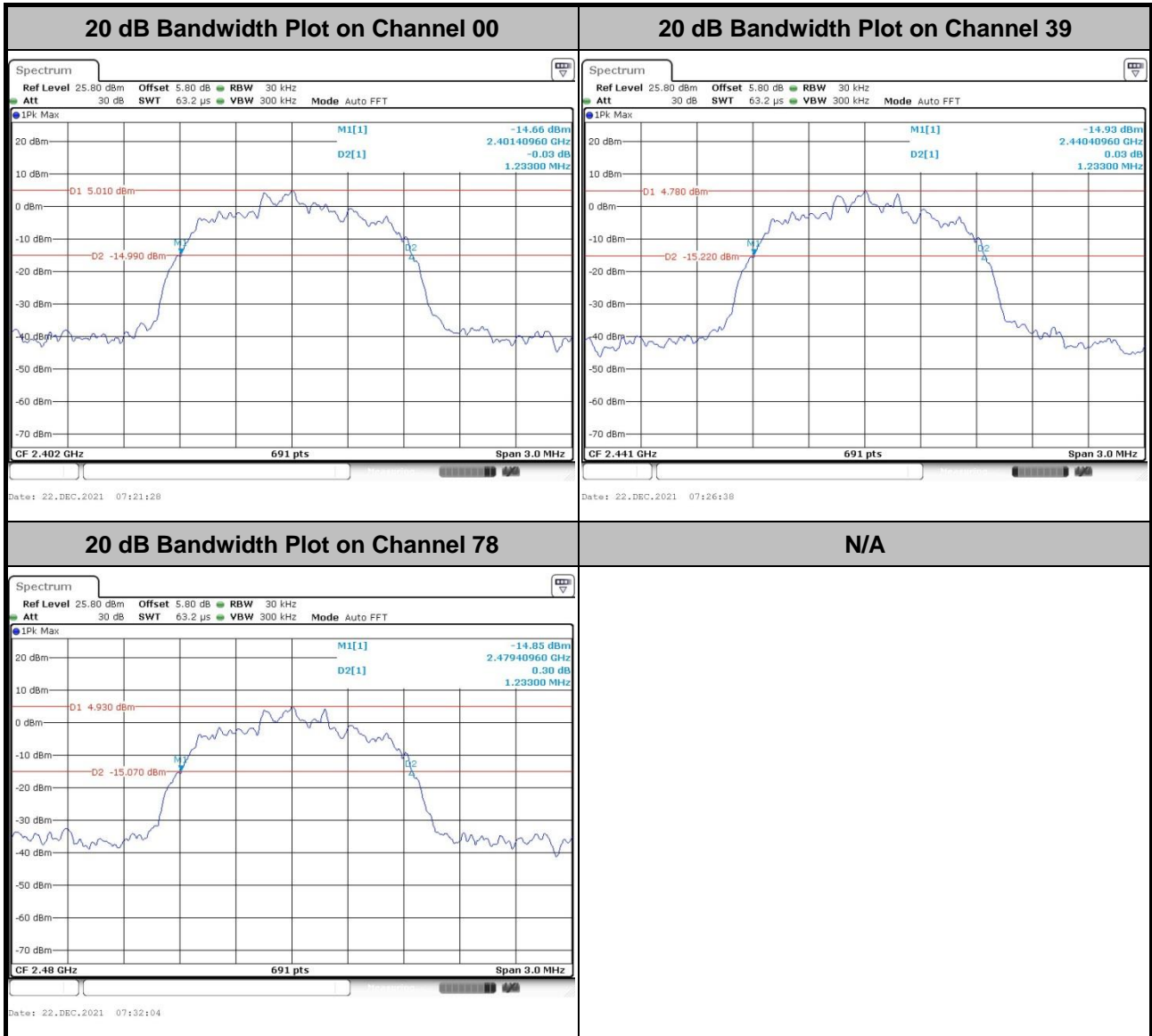



3.4.6 Test Result of 99% Occupied Bandwidth

Please refer to Appendix A.

<1Mbps>

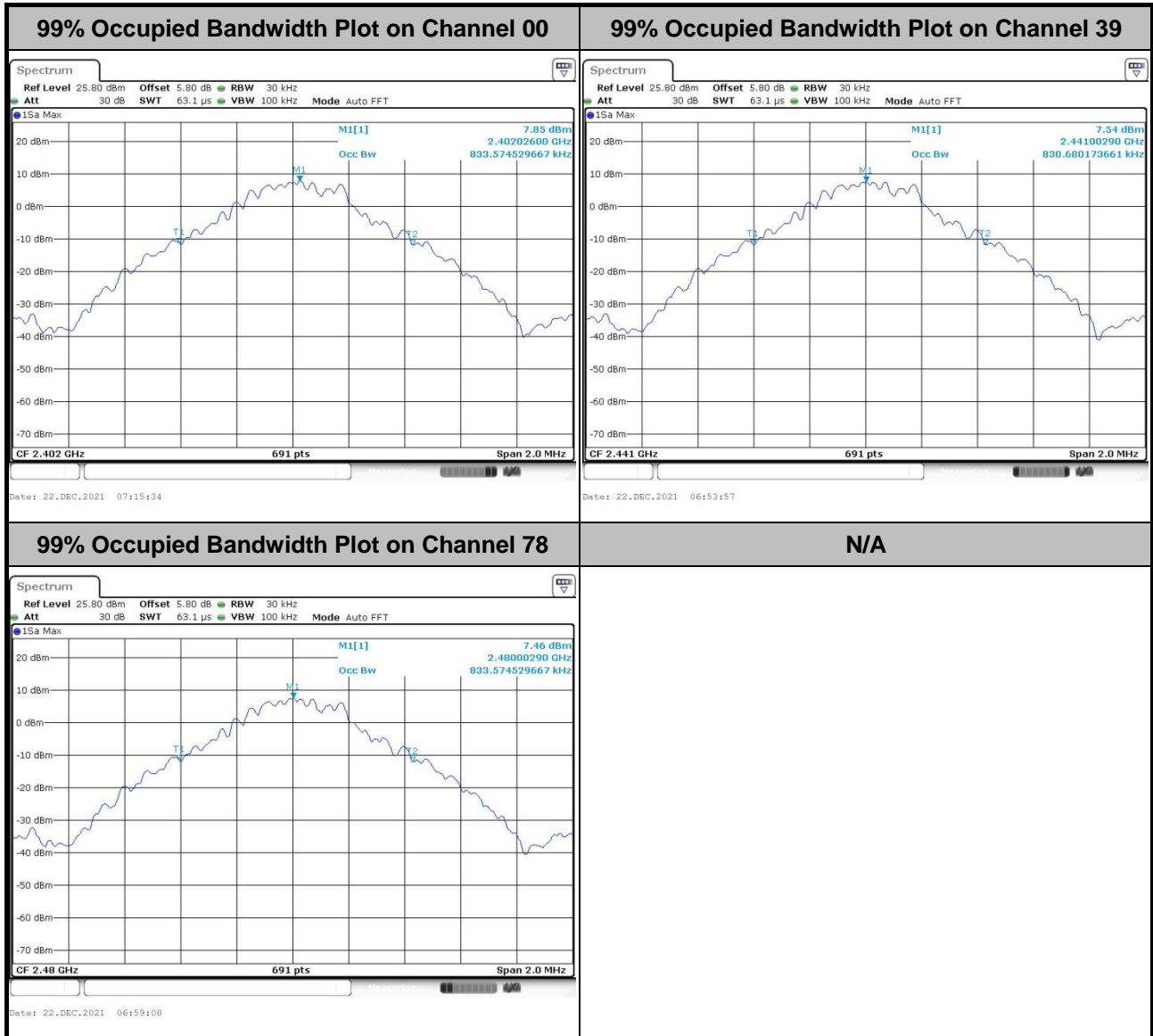

Note: The occupied channel bandwidth is maintained within the band of operation for all of the modulations.



<2Mbps>

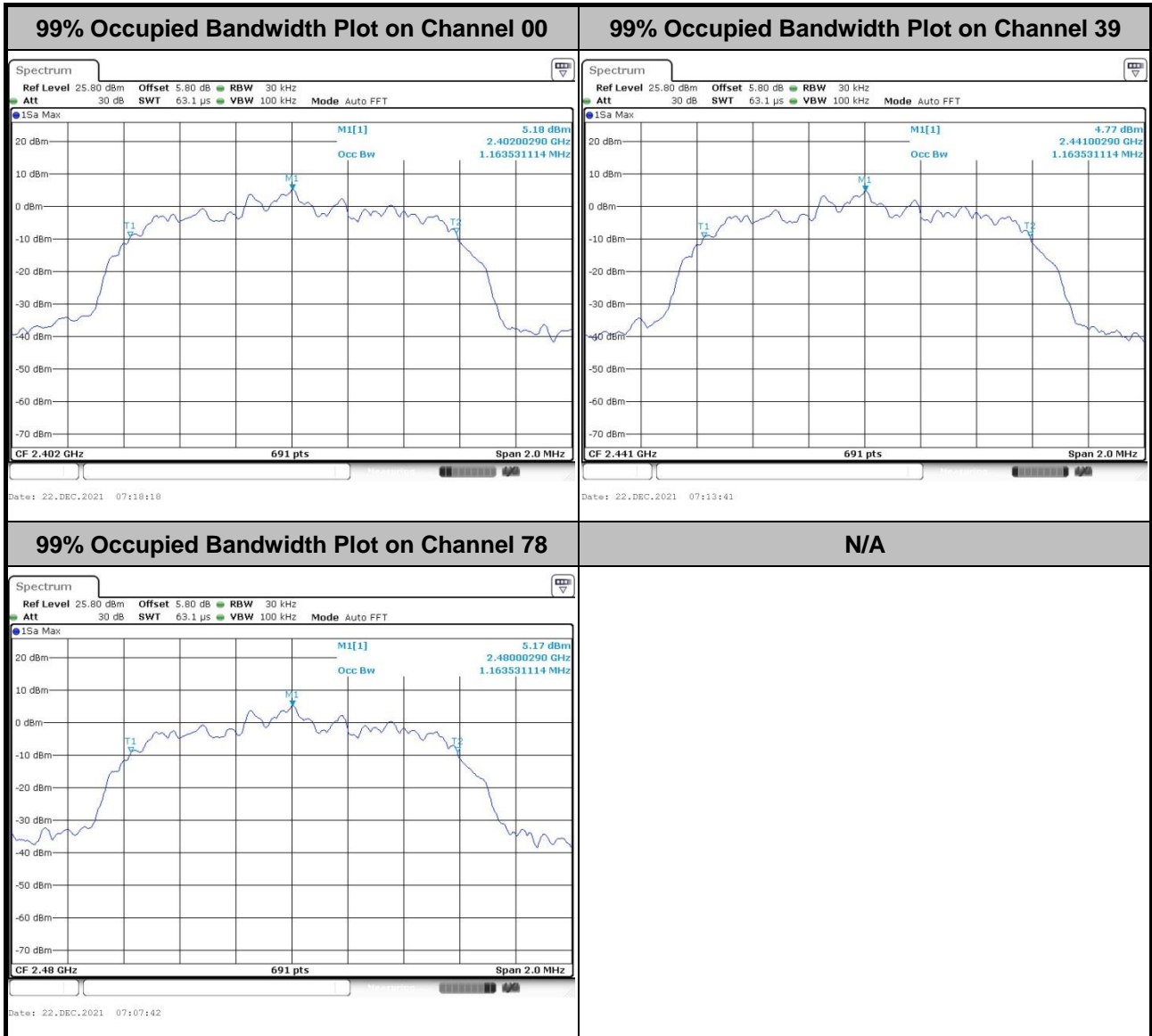

Note: The occupied channel bandwidth is maintained within the band of operation for all of the modulations.



<3Mbps>

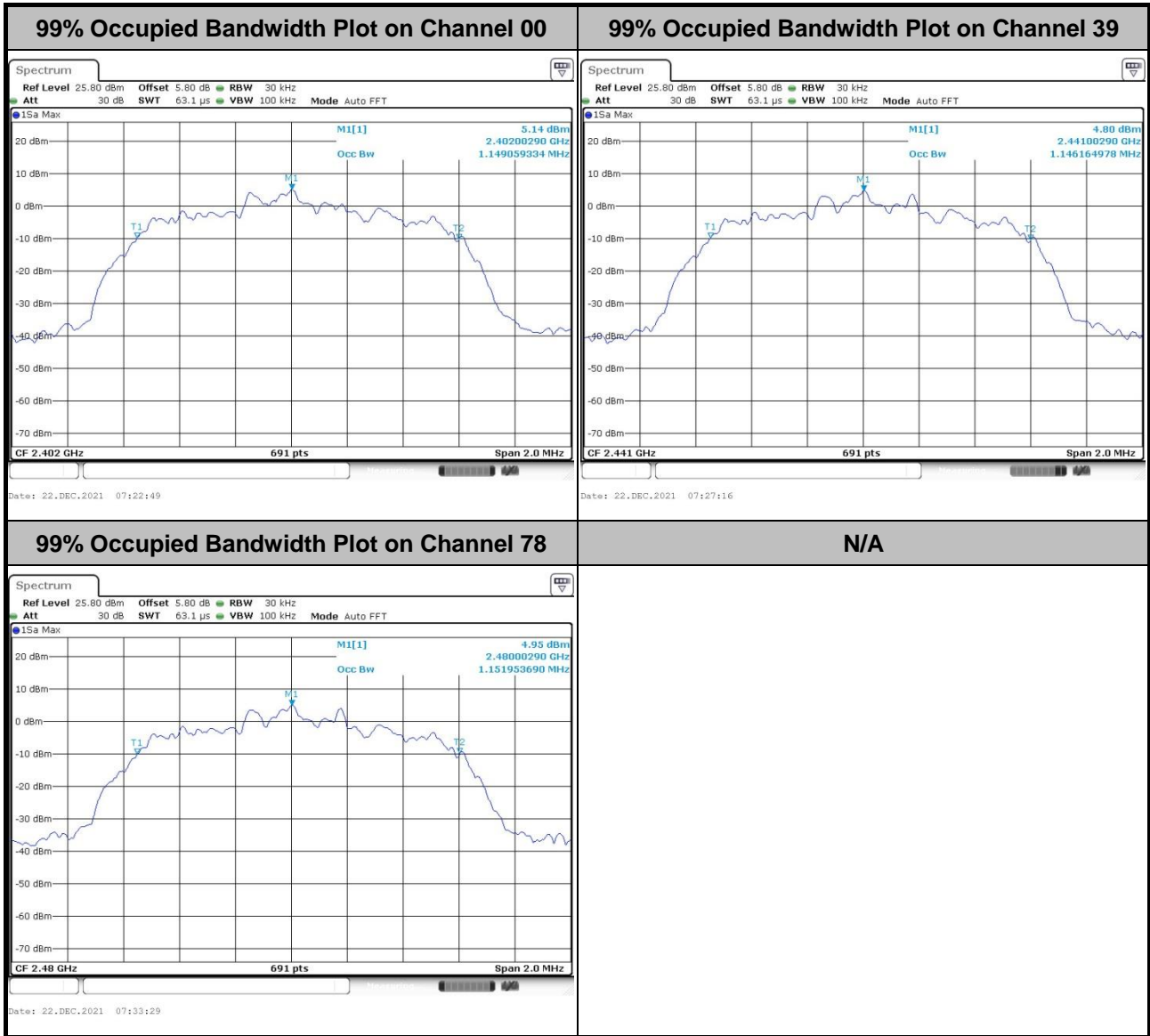

Note: The occupied channel bandwidth is maintained within the band of operation for all of the modulations.

3.5 Output Power Measurement

3.5.1 Limit of Output Power

The maximum peak conducted output power of the intentional radiator shall not exceed the following:
For frequency hopping systems operating in the 2400-2483.5 MHz band employing at least 75 non-overlapping hopping channels, and all frequency hopping systems in the 5725-5850 MHz band: 1 watt. For all other frequency hopping systems in the 2400-2483.5 MHz band 0.125 watts.

3.5.2 Measuring Instruments

See list of measuring equipment of this test report.

3.5.3 Test Procedures

1. The testing follows ANSI C63.10-2013 clause 7.8.5.
2. The RF output of EUT was connected to the power meter by RF cable and attenuator. The path loss was compensated to the results for each measurement.
3. Set the maximum power setting and enable the EUT to transmit continuously.
4. Measure the conducted output power with cable loss and record the results in the test report.
5. Measure and record the results in the test report.

3.5.4 Test Setup

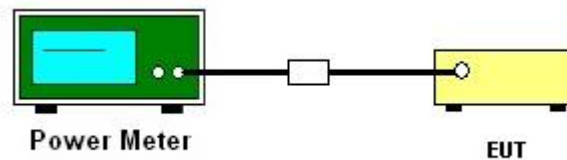

3.5.5 Test Result of Peak Output Power

Please refer to Appendix A.

3.6 Conducted Band Edges Measurement

3.6.1 Limit of Band Edges

In any 100 kHz bandwidth outside the intentional radiation frequency band, the radio frequency power shall be at least 20 dB below the highest level of the radiated power. In addition, radiated emissions which fall in the restricted bands must also comply with the radiated emission limits.

3.6.2 Measuring Instruments

See list of measuring equipment of this test report.

3.6.3 Test Procedures

1. The testing follows ANSI C63.10-2013 clause 7.8.6.
2. Set the maximum power setting and enable the EUT to transmit continuously.
3. Set RBW = 100 kHz, VBW = 300 kHz. Band edge emissions must be at least 20 dB down from the highest emission level within the authorized band as measured with a 100 kHz RBW. The attenuation shall be 30 dB instead of 20 dB when RMS conducted output power procedure is used.
4. Enable hopping function of the EUT and then repeat step 2 and 3.
5. Measure and record the results in the test report.

3.6.4 Test Setup

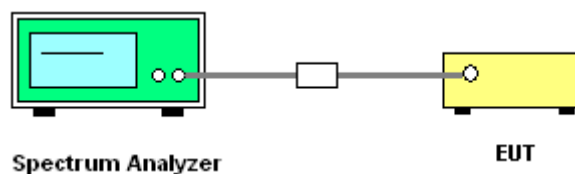



3.6.5 Test Result of Conducted Band Edges

<1Mbps>

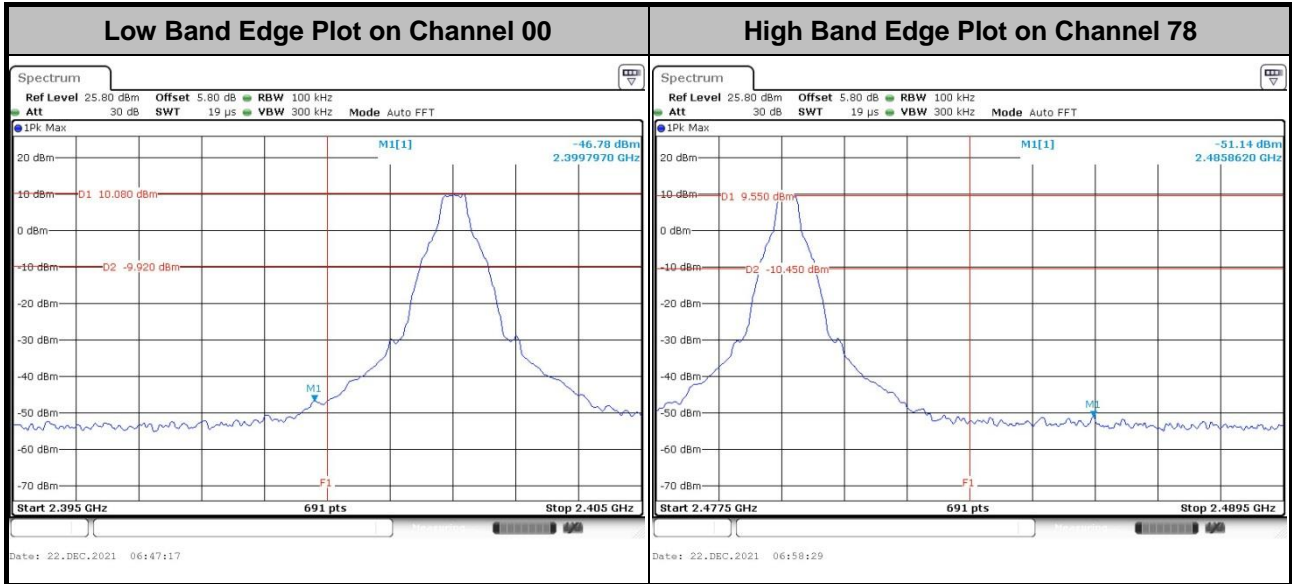

<2Mbps>

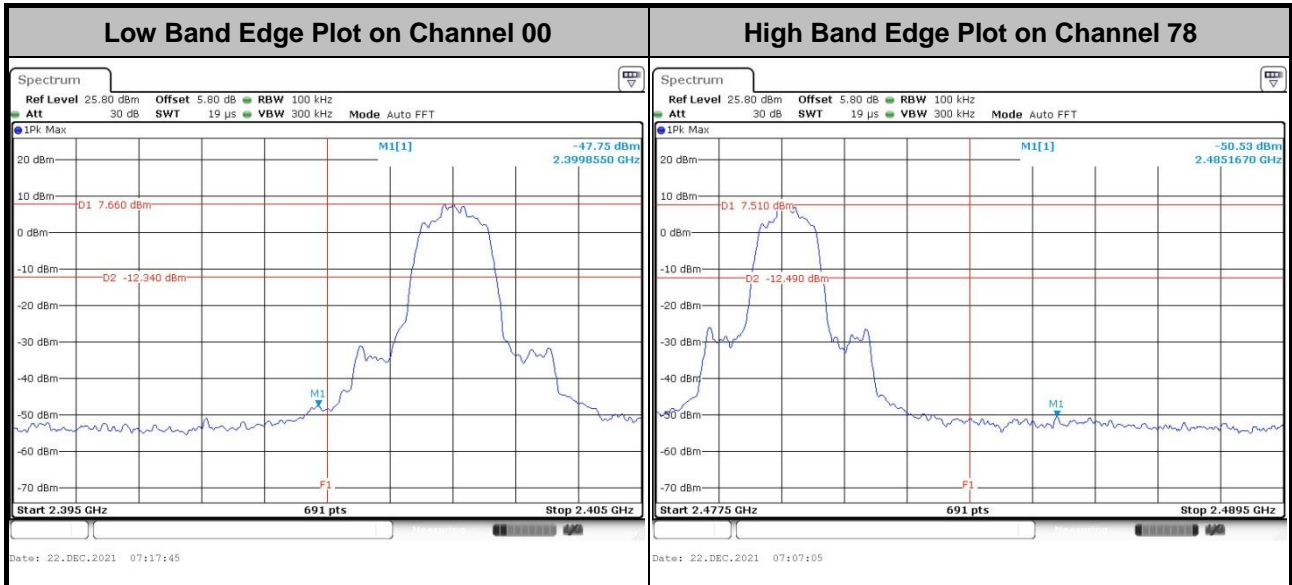



<3Mbps>

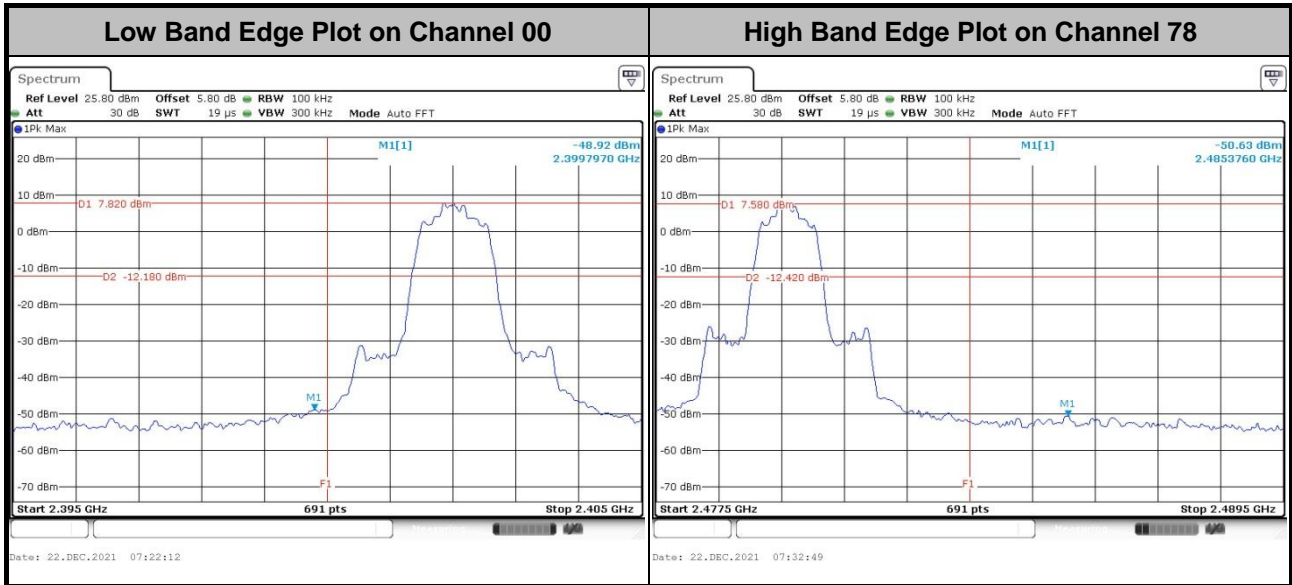



3.6.6 Test Result of Conducted Hopping Mode Band Edges

<1Mbps>

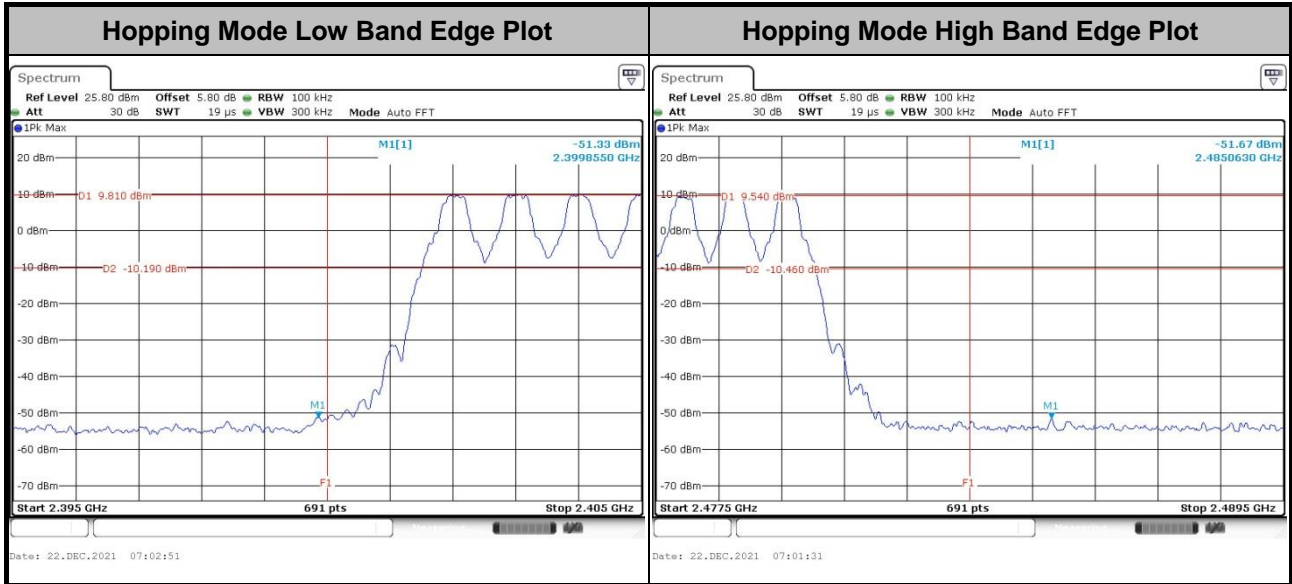

<2Mbps>

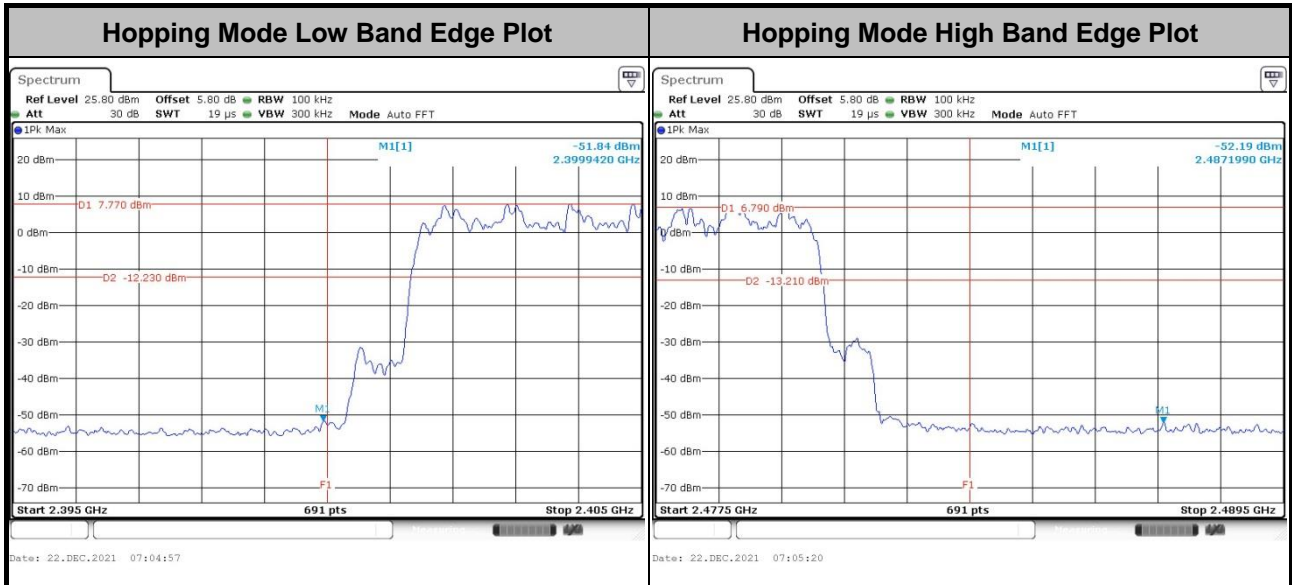



<3Mbps>

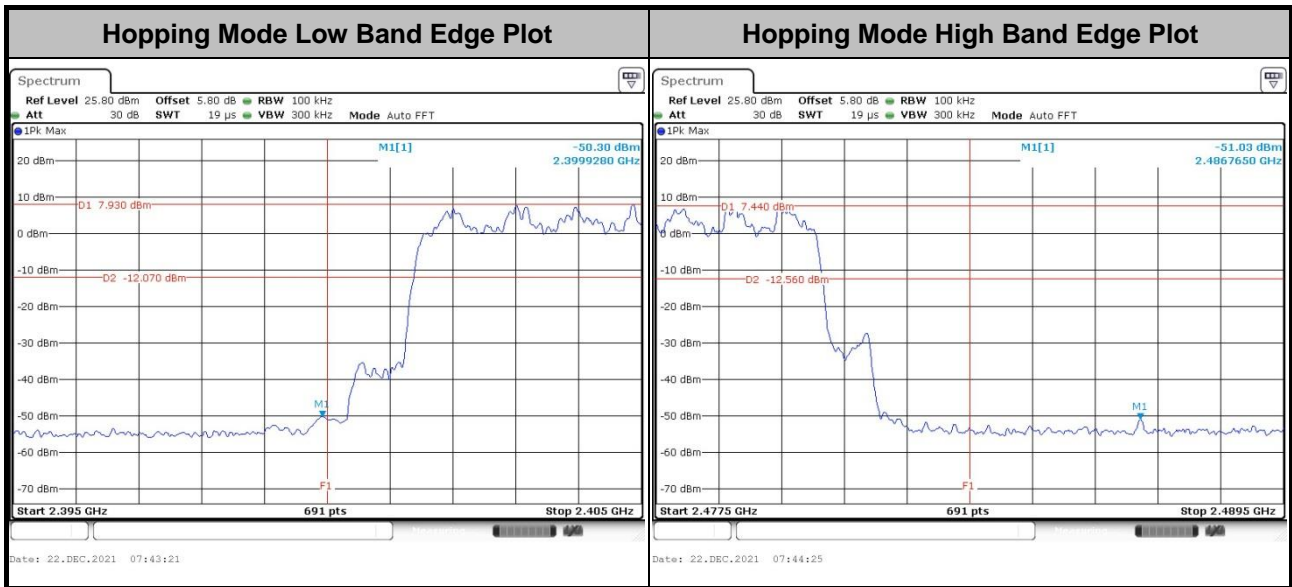

3.7 Conducted Spurious Emission Measurement

3.7.1 Limit of Spurious Emission Measurement

In any 100 kHz bandwidth outside the intentional radiation frequency band, the radio frequency power shall be at least 20 dB below the highest level of the radiated power. In addition, radiated emissions which fall in the restricted bands must also comply with the radiated emission limits.

3.7.2 Measuring Instruments

See list of measuring equipment of this test report.

3.7.3 Test Procedure

1. The testing follows ANSI C63.10-2013 clause 7.8.8.
2. The RF output of EUT was connected to the spectrum analyzer by RF cable and attenuator. The path loss was compensated to the results for each measurement.
3. Set the maximum power setting and enable the EUT to transmit continuously.
4. Set RBW = 100 kHz, VBW = 300 kHz, scan up through 10th harmonic. All harmonics / spurious must be at least 20 dB down from the highest emission level within the authorized band as measured with a 100 kHz RBW.
5. Measure and record the results in the test report.
6. The RF fundamental frequency should be excluded against the limit line in the operating frequency band.

3.7.4 Test Setup

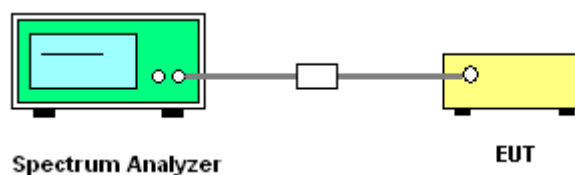



3.7.5 Test Result of Conducted Spurious Emission

<1Mbps>

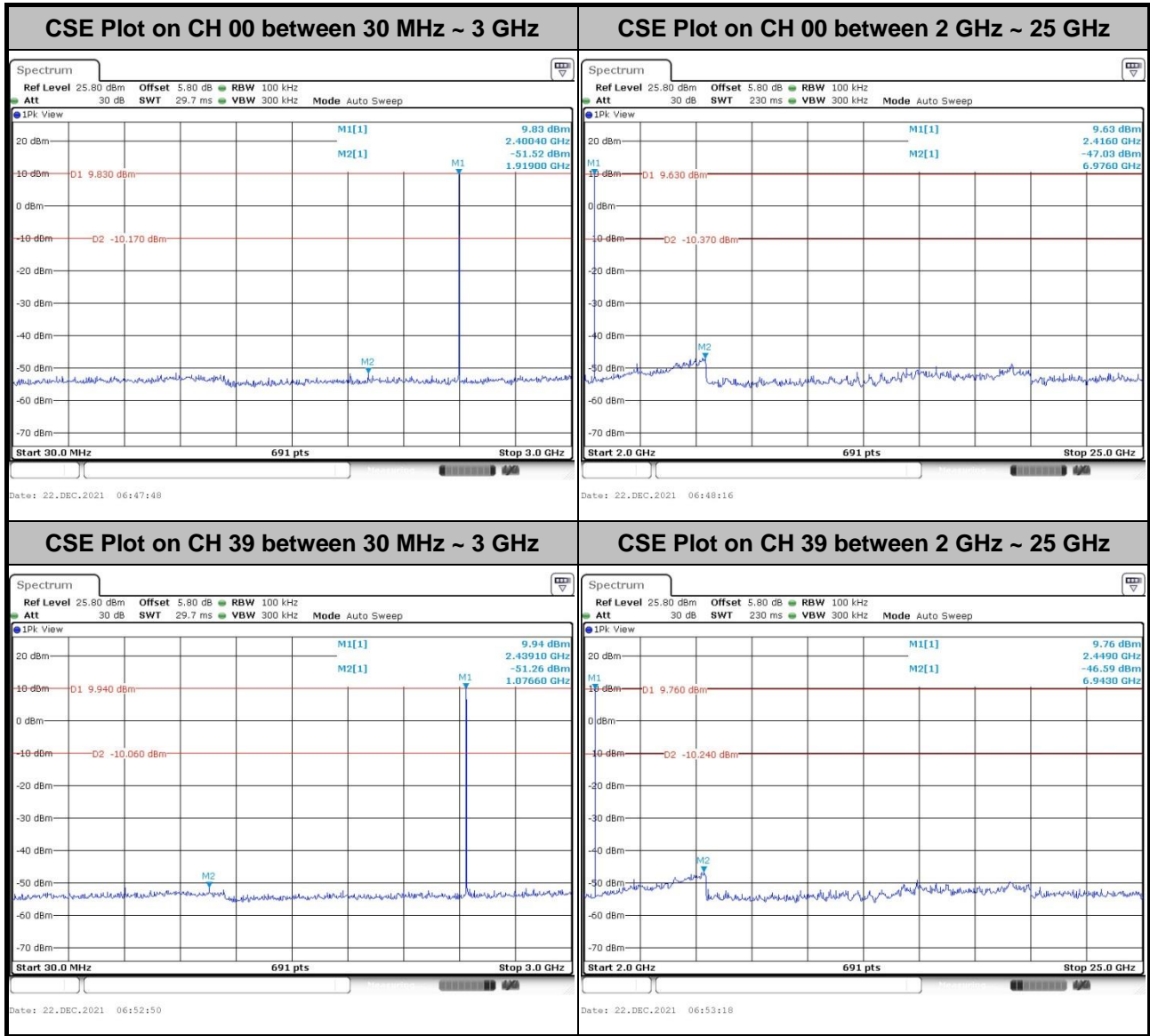

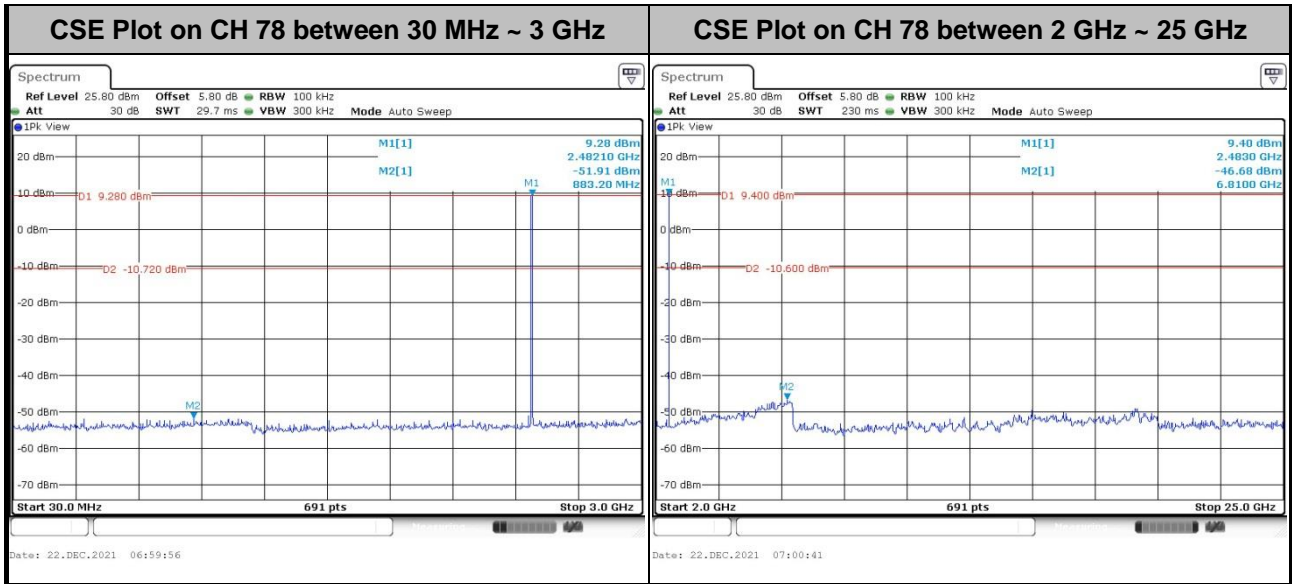



<2Mbps>

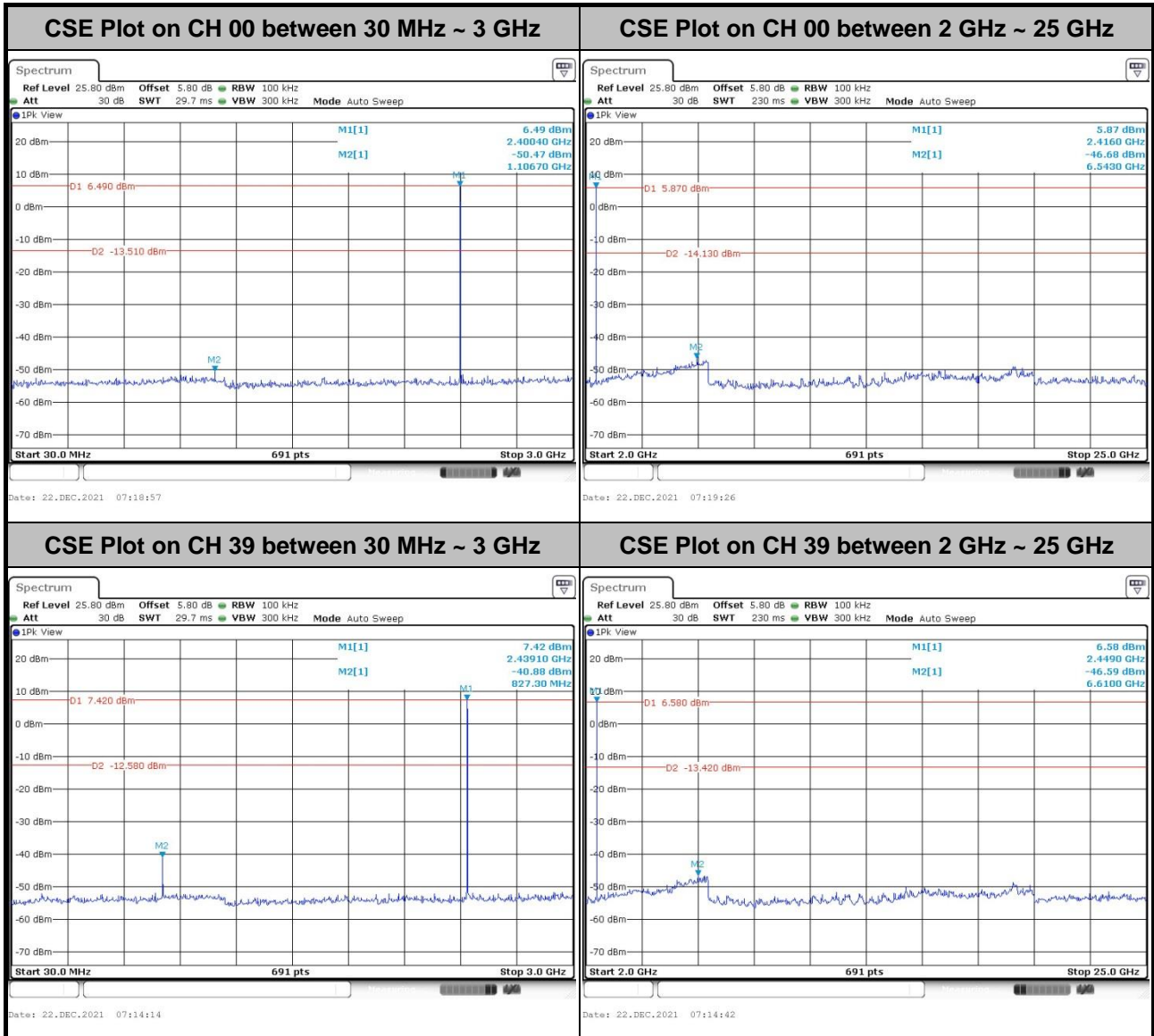

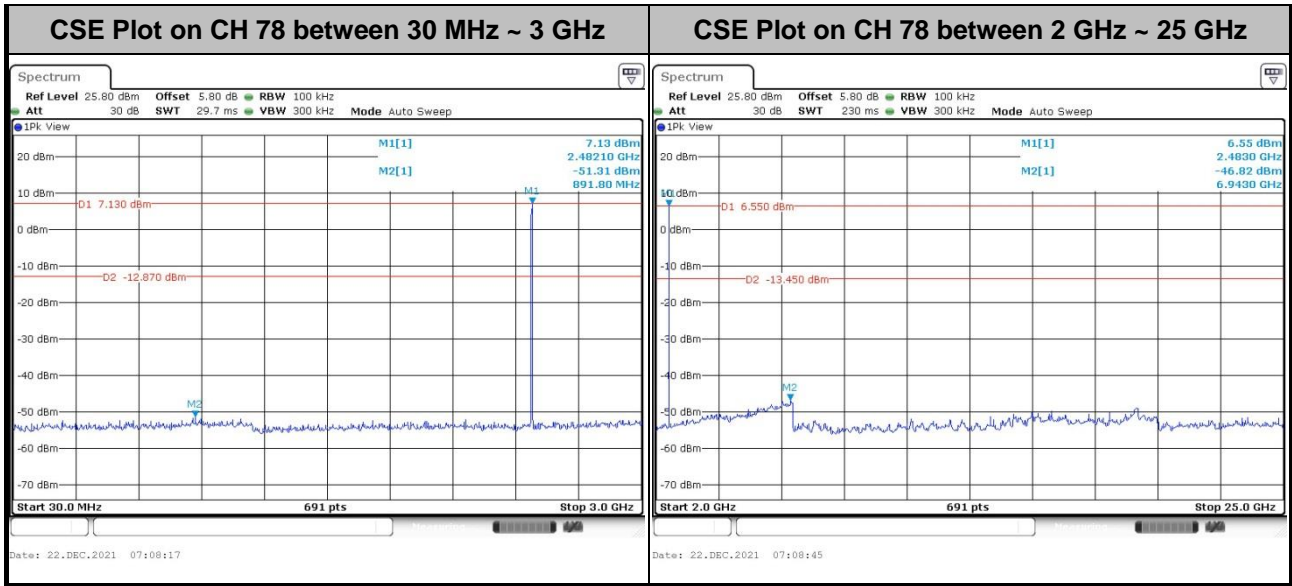



<3Mbps>

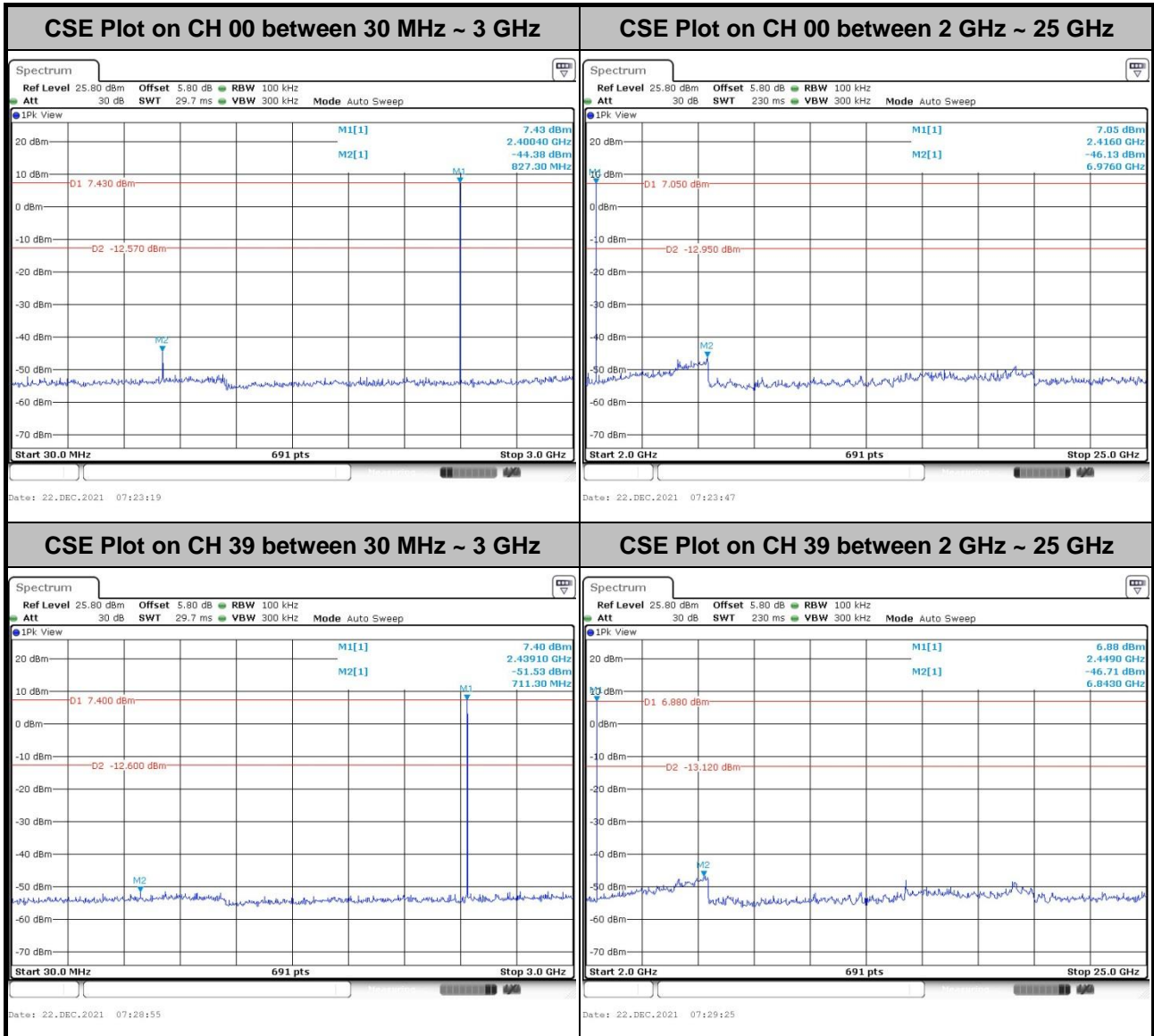

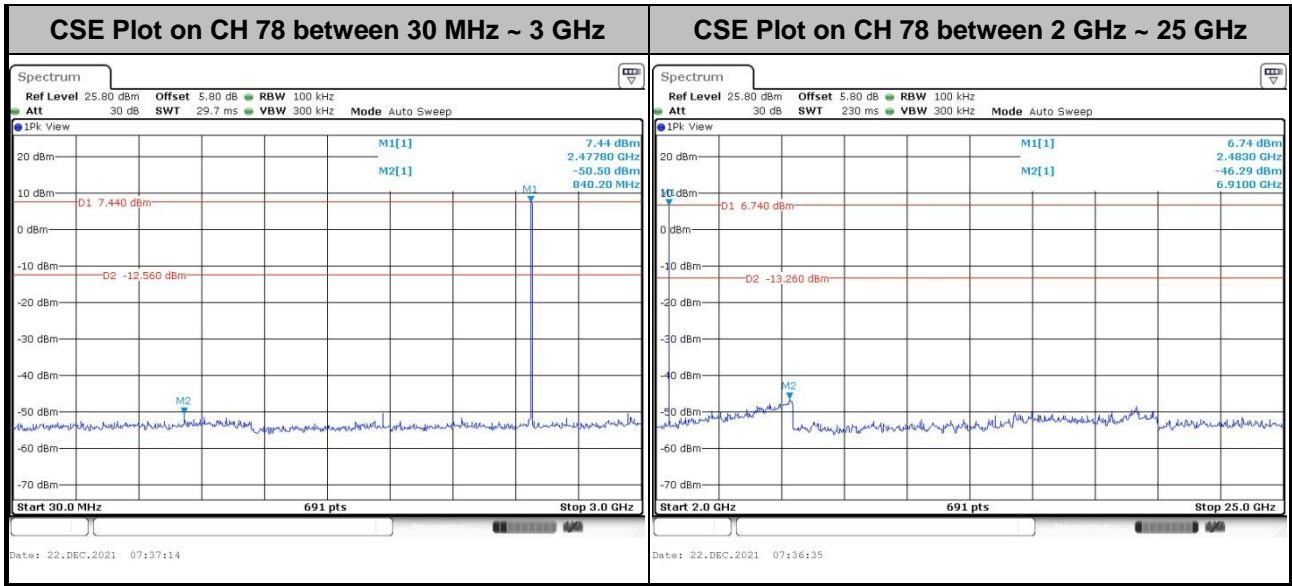



3.8 Radiated Band Edges and Spurious Emission Measurement

3.8.1 Limit of Radiated Band Edges and Spurious Emission

In any 100 kHz bandwidth outside the intentional radiator frequency band, all harmonics / spurious must be at least 20 dB below the highest emission level within the authorized band. In addition, radiated emissions which fall in the restricted bands must also comply with the limits as below.

Frequency (MHz)	Field Strength (microvolts/meter)	Measurement Distance (meters)
0.009 – 0.490	2400/F(kHz)	300
0.490 – 1.705	24000/F(kHz)	30
1.705 – 30.0	30	30
30 – 88	100	3
88 – 216	150	3
216 - 960	200	3
Above 960	500	3

3.8.2 Measuring Instruments

See list of measuring equipment of this test report.



3.8.3 Test Procedures

1. The EUT was placed on a turntable with 0.8 meter for frequency below 1 GHz and 1.5 meter for frequency above 1 GHz respectively above ground.
2. The EUT was set 3 meters from the interference receiving antenna, which was mounted on the top of a variable height antenna tower.
3. For each suspected emission, the EUT was arranged to its worst case and then tune the Antenna tower (from 1 m to 4 m) and turntable (from 0 degree to 360 degrees) to find the maximum reading. A pre-amp and a high pass filter are used for the test in order to get better signal level to comply with the guidelines.
4. Set the maximum power setting and enable the EUT to transmit continuously.
5. Use the following spectrum analyzer settings:
 - (1) Span shall wide enough to fully capture the emission being measured;
 - (2) Set RBW = 100 kHz for $f < 1$ GHz, RBW = 1 MHz for $f > 1$ GHz ; VBW \geq RBW; Sweep = auto; Detector function = peak; Trace = max hold for peak
 - (3) For average measurement: use duty cycle correction factor method per 15.35(c).
Duty cycle = On time/100 milliseconds
On time = $N_1 * L_1 + N_2 * L_2 + \dots + N_{n-1} * L_{n-1} + N_n * L_n$
Where N_1 is number of type 1 pulses, L_1 is length of type 1 pulses, etc.
Average Emission Level = Peak Emission Level + $20 * \log(\text{Duty cycle})$
6. Corrected Reading: Antenna Factor + Cable Loss + Read Level - Preamp Factor = Level
7. For testing below 1 GHz, if the emission level of the EUT in peak mode was 3 dB lower than the limit specified, then peak values of EUT will be reported, otherwise, the emissions will be repeated one by one using the CISPR quasi-peak method and reported.
8. For testing above 1 GHz, the emission level of the EUT in peak mode was 20 dB lower than average limit (that means the emission level in average mode also complies with the limit in average mode), then peak values of EUT will be reported, otherwise, the emissions will be measured in average mode again and reported.

Note: The average levels were calculated from the peak level corrected with duty cycle correction factor (-24.79dB) derived from $20 \log(\text{dwell time}/100\text{ms})$. This correction is only for signals that hop with the fundamental signal, such as band-edge and harmonic. Other spurious signals that are independent of the hopping signal would not use this correction.

3.8.4 Test Setup

For radiated test below 30MHz

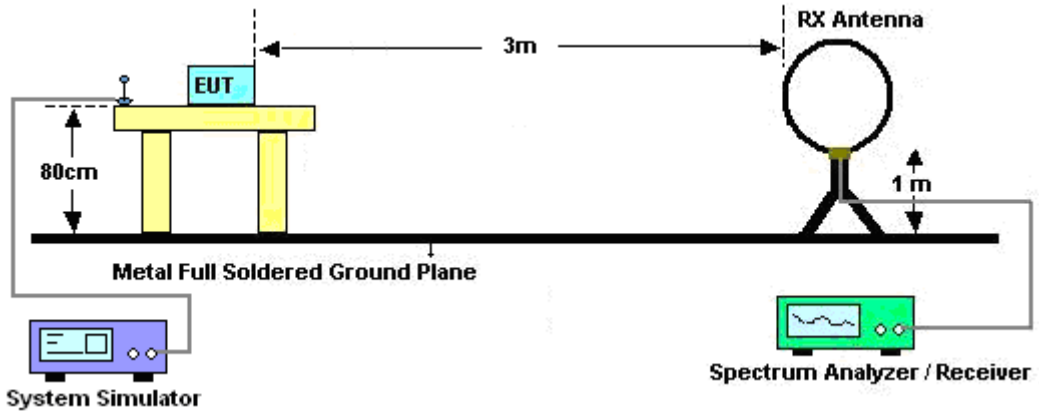

For radiated test from 30MHz to 1GHz

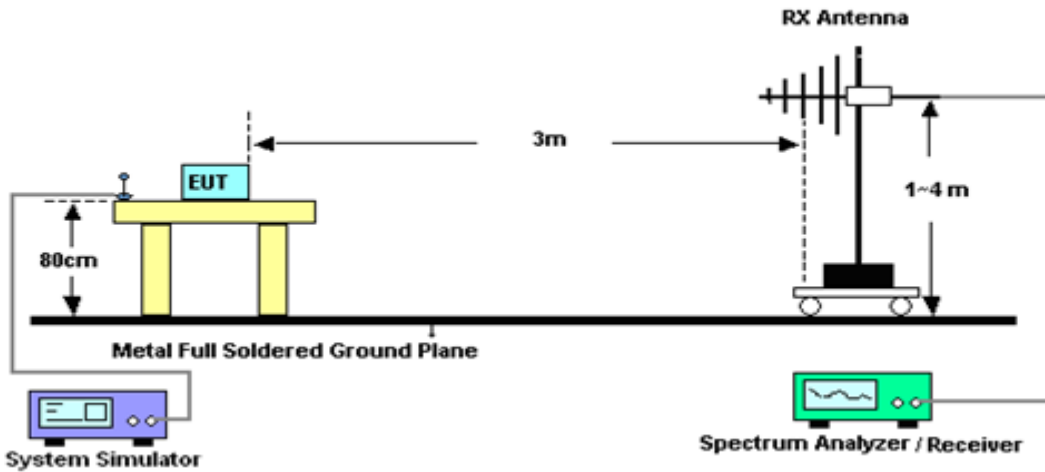

For radiated test from 1GHz to 18GHz

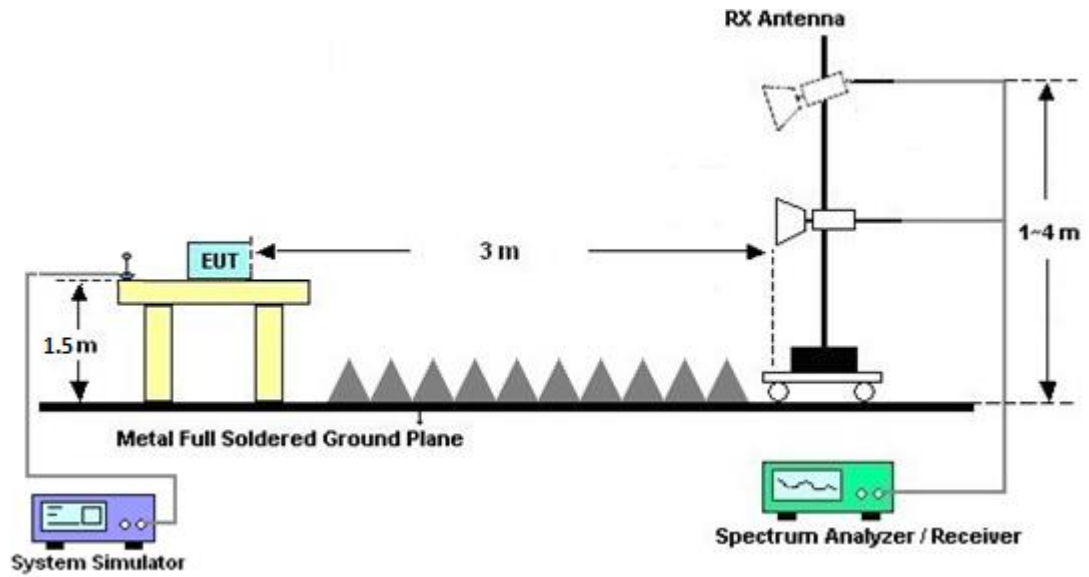

For radiated test above 18GHz

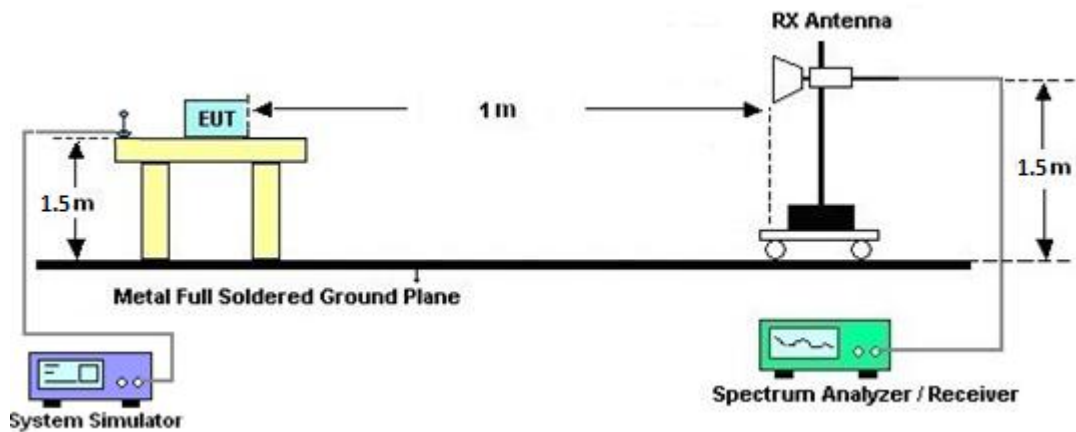



3.8.5 Test Results of Radiated Spurious Emissions (9 kHz ~ 30 MHz)

The low frequency, which started from 9 kHz to 30MHz, was pre-scanned and the result which was 20dB lower than the limit line was not reported.

There is adequate comparison measurement of both open-field test site and alternative test site - semi-Anechoic chamber according to 414788 D01 Radiated Test Site v01r01, and the result came out very similar.

3.8.6 Test Result of Radiated Spurious at Band Edges

Please refer to Appendix C and D.

3.8.7 Duty Cycle

Please refer to Appendix E.

3.8.8 Test Result of Radiated Spurious Emission (30MHz ~ 10th Harmonic)

Please refer to Appendix C and D.

3.9 AC Conducted Emission Measurement

3.9.1 Limit of AC Conducted Emission

For equipment that is designed to be connected to the public utility (AC) power line, the radio frequency voltage that is conducted back onto the AC power line on any frequency or frequencies within the band 150 kHz to 30 MHz shall not exceed the limits in the following table.

Frequency of emission (MHz)	Conducted limit (dB μ V)	
	Quasi-peak	Average
0.15-0.5	66 to 56*	56 to 46*
0.5-5	56	46
5-30	60	50

*Decreases with the logarithm of the frequency.

3.9.2 Measuring Instruments

See list of measuring equipment of this test report.

3.9.3 Test Procedures

1. The EUT was placed 0.4 meter from the conducting wall of the shielding room was kept at least 80 centimeters from any other grounded conducting surface.
2. Connect EUT to the power mains through a line impedance stabilization network (LISN).
3. All the support units are connecting to the other LISN.
4. The LISN provides 50 ohm coupling impedance for the measuring instrument.
5. The FCC states that a 50 ohm, 50 microhenry LISN shall be used.
6. Both sides of AC line were checked for maximum conducted interference.
7. The frequency range from 150 kHz to 30 MHz was searched.
8. Set the test-receiver system to Peak Detect Function and specified bandwidth (IF Bandwidth = 9kHz) with Maximum Hold Mode. Then measurement is also conducted by Average Detector and Quasi-Peak Detector Function respectively.

3.9.4 Test Setup

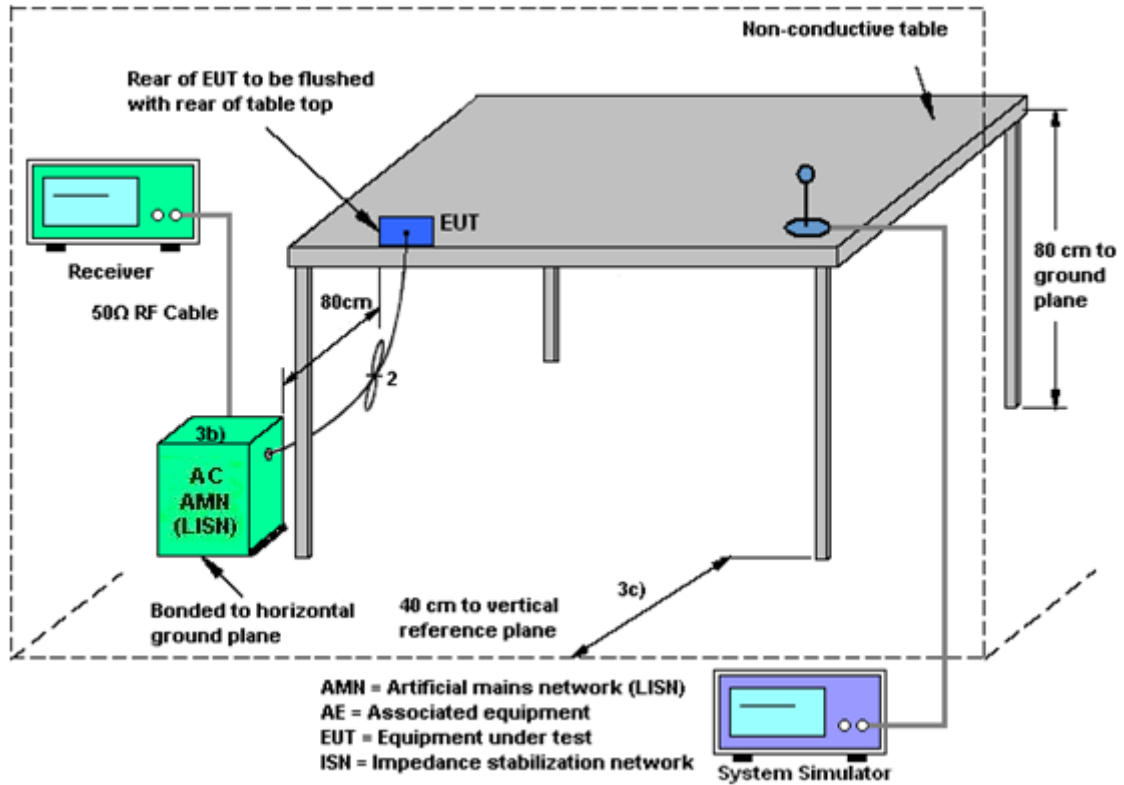

3.9.5 Test Result of AC Conducted Emission

Please refer to Appendix B.



3.10 Antenna Requirements

3.10.1 Standard Applicable

If directional gain of transmitting antennas is greater than 6 dBi, the power shall be reduced by the same level in dB comparing to gain minus 6 dBi. The use of a permanently attached antenna or of an antenna that uses a unique coupling to the intentional radiator shall be considered sufficient to comply with the rule.

3.10.2 Antenna Anti-Replacement Construction

An embedded-in antenna design is used.

3.10.3 Antenna Gain

The antenna peak gain of EUT is less than 6 dBi. Therefore, it is not necessary to reduce maximum peak output power limit.



4 List of Measuring Equipment

Instrument	Manufacturer	Model No.	Serial No.	Characteristics	Calibration Date	Test Date	Due Date	Remark
Spectrum Analyzer	R&S	FSV40	101040	10Hz~40GHz	Oct. 14, 2021	Dec. 12, 2021~ Dec. 22, 2021	Oct. 13, 2022	Conducted (TH01-KS)
Pulse Power Sensor	Anritsu	MA2411B	0917070	300MHz~40GHz	Jan. 07, 2021	Dec. 12, 2021~ Dec. 22, 2021	Jan. 06, 2022	Conducted (TH01-KS)
Power Meter	Anritsu	ML2495A	1005002	50MHz Bandwidth	Jan. 07, 2021	Dec. 12, 2021~ Dec. 22, 2021	Jan. 06, 2022	Conducted (TH01-KS)
EMI Test Receiver	Keysight	N9038A	MY564000 04	3Hz~8.5GHz;Max 30dBm	Oct. 16, 2021	Jan. 28, 2022	Oct. 15, 2022	Radiation (03CH06-KS)
EXA Spectrum Analyzer	Keysight	N9010A	MY551502 08	10Hz~44GHz	Apr. 12, 2021	Jan. 28, 2022	Apr. 11, 2022	Radiation (03CH06-KS)
Loop Antenna	R&S	HFH2-Z2	100321	9kHz~30MHz	Oct. 30, 2021	Jan. 28, 2022	Oct. 29, 2022	Radiation (03CH06-KS)
Bilog Antenna	TeseQ	CBL6111D	49921	30MHz~1GHz	May 27, 2021	Jan. 28, 2022	May 26, 2022	Radiation (03CH06-KS)
Double Ridge Horn Antenna	ETS-Lindgren	3117	00218652	1GHz~18GHz	Apr. 25, 2021	Jan. 28, 2022	Apr. 24, 2022	Radiation (03CH06-KS)
SHF-EHF Horn	Com-power	AH-840	101093	18GHz~40GHz	Jan. 05, 2022	Jan. 28, 2022	Jan. 04 2023	Radiation (03CH06-KS)
Amplifier	SONOMA	310N	187289	9KHz ~1GHZ	Apr. 12, 2021	Jan. 28, 2022	Apr. 11, 2022	Radiation (03CH06-KS)
Amplifier	MITEQ	EM18G40GG A	060728	18~40GHz	Jan. 05, 2022	Jan. 28, 2022	Jan. 04 2023	Radiation (03CH06-KS)
high gain Amplifier	MITEQ	AMF-7D-0010 1800-30-10P	2025788	1Ghz-18Ghz	Jul. 30, 2021	Jan. 28, 2022	Jul. 29, 2022	Radiation (03CH06-KS)
Amplifier	Keysight	83017A	MY532702 03	500MHz~26.5GHz	Apr. 13, 2021	Jan. 28, 2022	Apr. 12, 2022	Radiation (03CH06-KS)
AC Power Source	Chroma	61601	F1040900 04	N/A	NCR	Jan. 28, 2022	NCR	Radiation (03CH06-KS)
Turn Table	ChamPro	EM 1000-T	060762-T	0~360 degree	NCR	Jan. 28, 2022	NCR	Radiation (03CH06-KS)
Antenna Mast	ChamPro	EM 1000-A	060762-A	1 m~4 m	NCR	Jan. 28, 2022	NCR	Radiation (03CH06-KS)
EMI Receiver	R&S	ESCI7	100768	9kHz~7GHz;	Apr. 21, 2021	Dec. 20, 2021	Apr. 20, 2022	Conduction (CO01-KS)
AC LISN (for auxiliary equipment)	MessTec	AN3016	060103	9kHz~30MHz	Oct. 14, 2021	Dec. 20, 2021	Oct. 13, 2022	Conduction (CO01-KS)
AC LISN	MessTec	AN3016	060105	9kHz~30MHz	Apr. 13, 2021	Dec. 20, 2021	Apr. 12, 2022	Conduction (CO01-KS)
AC Power Source	Chroma	61602	ABP00000 0811	AC 0V~300V, 45Hz~1000Hz	Oct. 14, 2021	Dec. 20, 2021	Oct. 13, 2022	Conduction (CO01-KS)

NCR: No Calibration Required



5 Uncertainty of Evaluation

Uncertainty of Conducted Emission Measurement (150 kHz ~ 30 MHz)

Measuring Uncertainty for a Level of Confidence of 95% ($U = 2Uc(y)$)	2.94dB
---	--------

Uncertainty of Radiated Emission Measurement (30 MHz ~ 1000 MHz)

Measuring Uncertainty for a Level of Confidence of 95% ($U = 2Uc(y)$)	5.0dB
---	-------

Uncertainty of Radiated Emission Measurement (1000 MHz ~ 18000 MHz)

Measuring Uncertainty for a Level of Confidence of 95% ($U = 2Uc(y)$)	5.0dB
---	-------

Uncertainty of Radiated Emission Measurement (18000 MHz ~ 40000 MHz)

Measuring Uncertainty for a Level of Confidence of 95% ($U = 2Uc(y)$)	5.0dB
---	-------



Appendix A. Conducted Test Results

Bluetooth

Test Engineer:	Jack Fan	Temperature:	20~26	°C
Test Date:	2021/12/12~2021/12/22	Relative Humidity:	40~51	%

TEST RESULTS DATA**20dB and 99% Occupied Bandwidth and Hopping Channel Separation**

Mod.	Data Rate	NTX	CH.	Freq. (MHz)	20db BW (MHz)	99% Bandwidth (MHz)	Hopping Channel Separation Measurement (MHz)	Hopping Channel Separation Measurement Limit (MHz)	Pass/Fail
DH	1Mbps	1	0	2402	0.938	0.834	1011.580	0.6252	Pass
DH	1Mbps	1	39	2441	0.941	0.831	1306.800	0.6271	Pass
DH	1Mbps	1	78	2480	0.938	0.834	1002.900	0.6252	Pass
2DH	2Mbps	1	0	2402	1.259	1.164	1146.200	0.8394	Pass
2DH	2Mbps	1	39	2441	1.259	1.164	976.800	0.8393	Pass
2DH	2Mbps	1	78	2480	1.272	1.164	1002.900	0.8481	Pass
3DH	3Mbps	1	0	2402	1.233	1.149	1293.780	0.8220	Pass
3DH	3Mbps	1	39	2441	1.233	1.146	1007.200	0.8220	Pass
3DH	3Mbps	1	78	2480	1.233	1.152	1002.900	0.8220	Pass

TEST RESULTS DATA**Dwell Time**

Mod.	Hopping Channel Number Rate	Hops Over Occupancy Time(hops)	Package Transfer Time (msec) (MHz)	Dwell Time (sec)	Limits (sec)	Pass/Fail
Nomal	79	106.67	2.89	0.31	0.4	Pass
AFH	20	53.33	2.89	0.15	0.4	Pass

TEST RESULTS DATA**Peak Power Table**

DH	CH.	NTX	Peak Power (dBm)	Power Limit (dBm)	Test Result
DH1	0	1	10.07	20.97	Pass
	39	1	10.24	20.97	Pass
	78	1	9.97	20.97	Pass

2DH	CH.	NTX	Peak Power (dBm)	Power Limit (dBm)	Test Result
2DH1	0	1	9.41	20.97	Pass
	39	1	9.55	20.97	Pass
	78	1	9.36	20.97	Pass

3DH	CH.	NTX	Peak Power (dBm)	Power Limit (dBm)	Test Result
3DH1	0	1	9.69	20.97	Pass
	39	1	9.74	20.97	Pass
	78	1	9.66	20.97	Pass

TEST RESULTS DATA**Number of Hopping Frequency**

Number of Hopping (Channel)	Adaptive Frequency Hopping (Channel)	Limits (Channel)	Pass/Fail
79	79	> 15	Pass



Appendix B. AC Conducted Emission Test Results

Test Engineer :	Amos Zhang	Temperature :	25.3~26.2°C
		Relative Humidity :	38~40%
Test Voltage :	120Vac / 60Hz	Phase :	Line
Remark :	All emissions not reported here are more than 10 dB below the prescribed limit.		

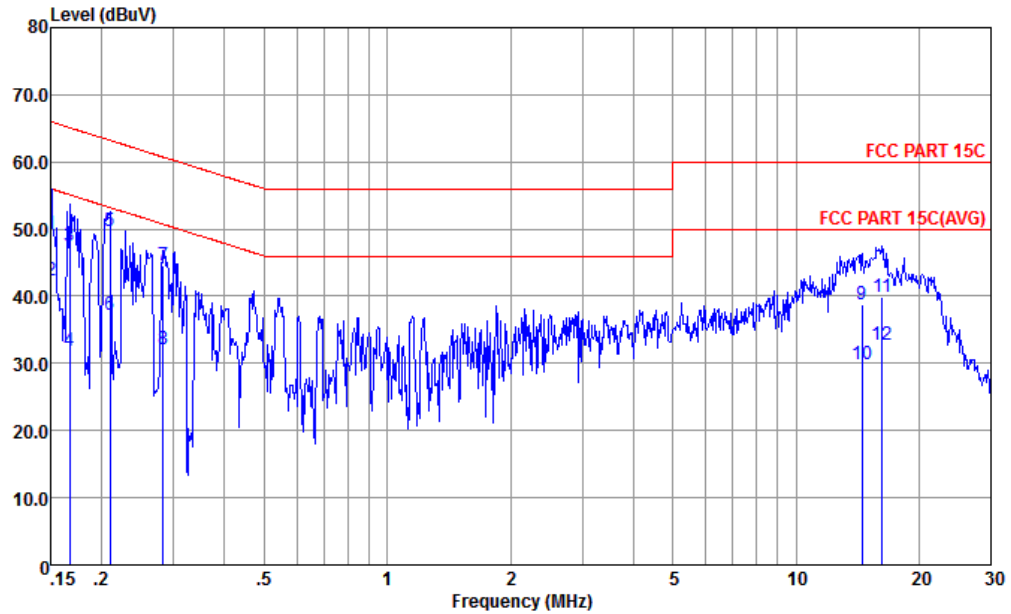

Site : CO01-KS
 Condition : FCC PART 15C LISN-060105-L LINE

	Freq	Level	Over	Limit	Read	LISN	Cable	Remark
	MHz	dBuV	dB	dBuV	dBuV	dB	dB	
1	0.150	49.30	-16.70	66.00	38.80	0.02	10.48	QP
2	0.150	42.40	-13.60	56.00	31.90	0.02	10.48	Average
3	0.167	47.36	-17.76	65.12	36.89	0.03	10.44	QP
4	0.167	31.76	-23.36	55.12	21.29	0.03	10.44	Average
5 *	0.209	49.70	-13.53	63.23	39.30	0.04	10.36	QP
6	0.209	37.30	-15.93	53.23	26.90	0.04	10.36	Average
7	0.283	44.58	-16.14	60.72	34.19	0.07	10.32	QP
8	0.283	31.98	-18.74	50.72	21.59	0.07	10.32	Average
9	14.517	38.89	-21.11	60.00	28.21	0.29	10.39	QP
10	14.517	29.89	-20.11	50.00	19.21	0.29	10.39	Average
11	16.226	39.97	-20.03	60.00	29.20	0.35	10.42	QP
12	16.226	32.67	-17.33	50.00	21.90	0.35	10.42	Average



Test Engineer :	Amos Zhang	Temperature :	25.3~26.2°C
		Relative Humidity :	38~40%
Test Voltage :	120Vac / 60Hz	Phase :	Neutral
Remark :	All emissions not reported here are more than 10 dB below the prescribed limit.		

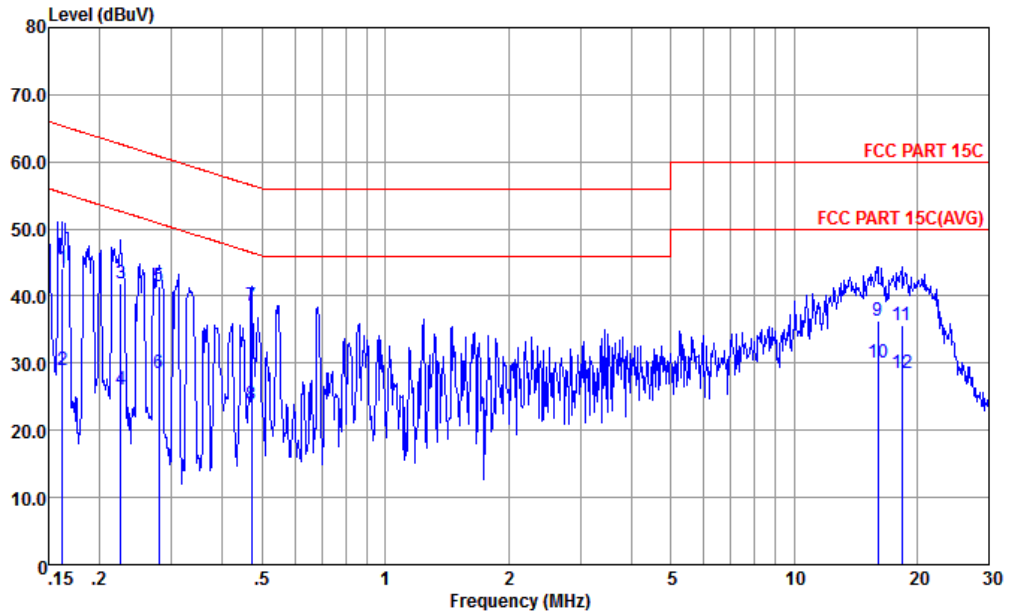

Site : CO01-KS
Condition : FCC PART 15C LISN-060105-N NEUTRAL

	Freq	Level	Over	Limit	Read	LISN	Cable	Remark
	MHz	dBuV	dB	dBuV	dBuV	dB	dB	
1	0.162	44.15	-21.19	65.34	33.59	0.11	10.45	QP
2	0.162	29.05	-26.29	55.34	18.49	0.11	10.45	Average
3	0.226	41.95	-20.66	62.61	31.50	0.10	10.35	QP
4	0.226	26.05	-26.56	52.61	15.60	0.10	10.35	Average
5	0.279	41.52	-19.33	60.85	31.10	0.10	10.32	QP
6	0.279	28.62	-22.23	50.85	18.20	0.10	10.32	Average
7 *	0.471	38.55	-17.94	56.49	28.20	0.11	10.24	QP
8	0.471	23.95	-22.54	46.49	13.60	0.11	10.24	Average
9	16.055	36.38	-23.62	60.00	25.60	0.36	10.42	QP
10	16.055	29.98	-20.02	50.00	19.20	0.36	10.42	Average
11	18.328	35.72	-24.28	60.00	24.81	0.45	10.46	QP
12	18.328	28.52	-21.48	50.00	17.61	0.45	10.46	Average

Note:

- Level(dBμV) = Read Level(dBμV) + LISN Factor(dB) + Cable Loss(dB)
- Over Limit(dB) = Level(dBμV) – Limit Line(dBμV)



Appendix C. Radiated Spurious Emission

Test Engineer :	Henry Li	Temperature :	22~23°C
		Relative Humidity :	41~42%

2.4GHz 2400~2483.5MHz

BT (Band Edge @ 3m)

BT	Note	Frequency	Level	Over	Limit	Read	Antenna	Path	Preamp	Ant	Table	Peak	Pol.
Ant				Limit	Line	Level	Factor	Loss	Factor	Pos	Pos	Avg.	
6		(MHz)	(dBμV/m)	(dB)	(dBμV/m)	(dBμV)	(dB/m)	(dB)	(dB)	(cm)	(deg)	(P/A)	(H/V)
BT CH00 2402MHz		2385.4	54.04	-19.96	74	48.85	30.94	7.13	32.88	187	65	P	H
		2385.4	29.25	-24.75	54	-	-	-	-	-	-	A	H
	*	2402	104.89	-	-	99.57	31	7.16	32.84	187	65	P	H
	*	2402	80.1	-	-	-	-	-	-	-	-	A	H
		2335.74	53.86	-20.14	74	48.98	30.77	7.07	32.96	340	100	P	V
		2335.74	29.07	-24.93	54	-	-	-	-	-	-	A	V
	*	2402	101.31	-	-	95.99	31	7.16	32.84	340	100	P	V
	*	2402	76.52	-	-	-	-	-	-	-	-	A	V
BT CH 78 2480MHz		2485.84	55.07	-18.93	74	49.27	31.17	7.27	32.64	122	70	P	H
		2485.84	30.28	-23.72	54	-	-	-	-	-	-	A	H
	*	2480	103.73	-	-	97.97	31.13	7.27	32.64	122	70	P	H
	*	2480	78.94	-	-	-	-	-	-	-	-	A	H
		2497.18	54.01	-19.99	74	48.11	31.17	7.3	32.57	362	100	P	V
		2497.18	29.22	-24.78	54	-	-	-	-	-	-	A	V
	*	2480	99.03	-	-	93.27	31.13	7.27	32.64	362	100	P	V
	*	2480	74.24	-	-	-	-	-	-	-	-	A	V
Remark	1. No other spurious found.												
	2. All results are PASS against Peak and Average limit line.												



2.4GHz 2400~2483.5MHz

BT (Harmonic @ 3m)

BT Ant 6	Note	Frequency (MHz)	Level (dBμV/m)	Over Limit (dB)	Limit Line (dBμV/m)	Read Level (dBμV)	Antenna Factor (dB/m)	Path Loss (dB)	Preamp Factor (dB)	Ant Pos (cm)	Table Pos (deg)	Peak Avg. (P/A)	Pol. (H/V)
BT CH 00 2402MHz		4800	41.54	-32.46	74	56.83	34.51	10.24	60.04	300	0	P	H
		4800	41.76	-32.24	74	57.05	34.51	10.24	60.04	100	0	P	V
BT CH 39 2441MHz		4875	42.36	-31.64	74	57.41	34.66	10.32	60.03	300	0	P	H
		7320	43.61	-30.39	74	54.8	36.56	12.77	60.52	300	0	P	H
		4875	42.55	-31.45	74	57.6	34.66	10.32	60.03	100	0	P	V
BT CH 78 2480MHz		7320	43.74	-30.26	74	54.93	36.56	12.77	60.52	100	0	P	V
		4875	42.36	-31.64	74	57.41	34.66	10.32	60.03	300	0	P	H
		7320	43.61	-30.39	74	54.8	36.56	12.77	60.52	300	0	P	H
		4875	42.55	-31.45	74	57.6	34.66	10.32	60.03	100	0	P	V
BT CH 78 2480MHz		7320	43.74	-30.26	74	54.93	36.56	12.77	60.52	100	0	P	V
		4875	42.36	-31.64	74	57.41	34.66	10.32	60.03	300	0	P	H
		7320	43.61	-30.39	74	54.8	36.56	12.77	60.52	300	0	P	H
		4875	42.55	-31.45	74	57.6	34.66	10.32	60.03	100	0	P	V
Remark	1. No other spurious found. 2. All results are PASS against Peak and Average limit line.												



Emission below 1GHz

2.4GHz BT (LF)

BT	Note	Frequency	Level	Over	Limit	Read	Antenna	Path	Preamp	Ant	Table	Peak	Pol.
Ant				Limit	Line	Level	Factor	Loss	Factor	Pos	Pos	Avg.	
6		(MHz)	(dBμV/m)	(dB)	(dBμV/m)	(dBμV)	(dB/m)	(dB)	(dB)	(cm)	(deg)	(P/A)	(H/V)
2.4GHz BT LF		30	21.64	-18.36	40	27.69	24.6	0.58	31.23	-	-	P	H
		153.19	18.26	-25.24	43.5	31.24	16.35	1.99	31.32	-	-	P	H
		163.86	18.1	-25.4	43.5	31.49	15.88	2.06	31.33	-	-	P	H
		290.93	25.91	-20.09	46	35.4	19.34	2.76	31.59	-	-	P	H
		313.24	26.64	-19.36	46	35.84	19.57	2.87	31.64	-	-	P	H
		737.13	27.8	-18.2	46	29.04	25.47	4.41	31.12	-	-	P	H
		30	26.32	-13.68	40	32.37	24.6	0.58	31.23	-	-	P	V
		53.28	20.28	-19.72	40	37.08	0.93	13.62	31.35	-	-	P	V
		297.72	20.85	-25.15	46	30.37	19.31	2.8	31.63	-	-	P	V
		538.28	21.99	-24.01	46	25.17	24.62	3.77	31.57	-	-	P	V
		741.98	27.88	-18.12	46	29.01	25.56	4.43	31.12	-	-	P	V
		869.05	28.92	-17.08	46	28.85	26.52	4.8	31.25	-	-	P	V
Remark	1. No other spurious found. 2. All results are PASS against limit line.												



Note symbol

*	Fundamental Frequency which can be ignored. However, the level of any unwanted emissions shall not exceed the level of the fundamental frequency.
!	Test result is over limit line.
P/A	Peak or Average
H/V	Horizontal or Vertical



A calculation example for radiated spurious emission is shown as below:

BT	Note	Frequency	Level	Over	Limit	Read	Antenna	Path	Preamp	Ant	Table	Peak	Pol.
		(MHz)	(dBμV/m)	(dB)	(dBμV/m)	(dBμV)	(dB/m)	(dB)	(dB)	(cm)	(deg)	(P/A)	(H/V)
BT CH 00 2402MHz		2390	55.45	-18.55	74	54.51	32.22	4.58	35.86	103	308	P	H
		2390	43.54	-10.46	54	42.6	32.22	4.58	35.86	103	308	A	H

1. Path Loss(dB) = Cable loss(dB) + Filter loss(dB) + Attenuator loss(dB)
2. Level(dBμV/m) =
Antenna Factor(dB/m) + Path Loss(dB) + Read Level(dBμV) - Preamp Factor(dB)
3. Over Limit(dB) = Level(dBμV/m) – Limit Line(dBμV/m)

For Peak Limit @ 2390MHz:

1. Level(dBμV/m)
= Antenna Factor(dB/m) + Path Loss(dB) + Read Level(dBμV) - Preamp Factor(dB)
= 32.22(dB/m) + 4.58(dB) + 54.51(dBμV) – 35.86 (dB)
= 55.45 (dBμV/m)
2. Over Limit(dB)
= Level(dBμV/m) – Limit Line(dBμV/m)
= 55.45(dBμV/m) – 74(dBμV/m)
= -18.55(dB)

For Average Limit @ 2390MHz:

1. Level(dBμV/m)
= Antenna Factor(dB/m) + Path Loss(dB) + Read Level(dBμV) - Preamp Factor(dB)
= 32.22(dB/m) + 4.58(dB) + 42.6(dBμV) – 35.86 (dB)
= 43.54 (dBμV/m)
2. Over Limit(dB)
= Level(dBμV/m) – Limit Line(dBμV/m)
= 43.54(dBμV/m) – 54(dBμV/m)
= -10.46(dB)

Both peak and average measured complies with the limit line, so test result is “PASS”.



Appendix D. Radiated Spurious Emission Plots

Test Engineer :	Henry Li	Temperature :	22~23°C
		Relative Humidity :	41~42%

2.4GHz 2400~2483.5MHz
BT (Band Edge @ 3m)

BT	2.4GHz 2400~2483.5MHz Band Edge @ 3m	
ANT	BT CH00 2402MHz	
6	Horizontal	Fundamental
Peak	<pre> Site : @30M0-15 Condition : FCC PART 15C 3m 3137 50 00218643 HORIZONTAL Project : FR1D0310 Mode : 1 Plane : X Polariz : Single-directivity IME1 : #6 : @MS : @MS Freq Level Over Limit Read CableAntenna Preamp A/Pos T/Pos Remark MHz dBuV/m dB dBuV/m dBuV dB dBuV/m dB cm cm 1 2385.48 54.04 -19.96 74.00 45.85 7.13 30.94 32.68 187 65 Peak </pre>	<pre> Site : @30M0-15 Condition : FCC PART 15C 3m 3137 50 00218643 HORIZONTAL Project : FR1D0310 Mode : 1 Plane : X Polariz : Single-directivity IME1 : #6 : @MS : @MS Freq Level Over Limit Read CableAntenna Preamp A/Pos T/Pos Remark MHz dBuV/m dB dBuV/m dBuV dB dBuV/m dB cm cm 1 * 2482.00 104.89 30.89 74.00 89.57 7.16 31.00 32.64 187 65 Peak </pre>



BT	2.4GHz 2400~2483.5MHz Band Edge @ 3m	
ANT	BT CH78 2480MHz	
6	Horizontal	Fundamental
<p>Peak</p>	<pre> Site : 83C8B6-K5 Condition : FCC PART 15C 3m 3117 5M 00218643 HORIZONTAL Project : R90:1000.000MHz V90:1000.000MHz SMT:Auto Model : (F)1200310 Plane : X Plane : Single-directivity IME1 : ME : DHS Freq Level Over Limit Read CabAntenna Preamp A/Pos T/Pos Remark MHz dBuV/m dB dBuV/m dBuV dB dB/m dB cm deg 1 2485.04 55.07 -18.93 74.00 49.27 7.27 31.17 32.64 122 70 Peak </pre>	<pre> Site : 83C8B6-K5 Condition : FCC PART 15C 3m 3117 5M 00218643 HORIZONTAL Project : R90:1000.000MHz V90:1000.000MHz SMT:Auto Model : (F)1200310 Plane : X Plane : Single-directivity IME1 : ME : DHS Freq Level Over Limit Read CabAntenna Preamp A/Pos T/Pos Remark MHz dBuV/m dB dBuV/m dBuV dB dB/m dB cm deg 1 * 2480.00 103.73 29.73 74.00 97.97 7.27 31.13 32.64 122 70 Peak </pre>



BT	2.4GHz 2400~2483.5MHz Band Edge @ 3m	
ANT	BT CH78 2480MHz	
6	Vertical	Fundamental
<p>Peak</p>	<pre> Site : 83C086-K5 Condition : FCC PART 15C 3e 3117 5M 00218043 VERTICAL Project : FR1D0310A Mode : 3 Plane : X : Single-directivity IMEI : 86 : DHS : Read CabAntenna Preamp A/Pos T/Pos : Loss Factor Factor Freq Level Over Limit Read CabAntenna Preamp A/Pos T/Pos MHz dBuV/m dB dBuV/m dBuV dB dB/m dB cm deg Remark 1 2497.18 54.81 -19.99 74.00 48.11 7.30 31.17 32.57 362 100 Peak </pre>	<pre> Site : 83C086-K5 Condition : FCC PART 15C 3e 3117 5M 00218043 VERTICAL Project : FR1D0310A Mode : 3 Plane : X : Single-directivity IMEI : 86 : DHS : Read CabAntenna Preamp A/Pos T/Pos : Loss Factor Factor Freq Level Over Limit Read CabAntenna Preamp A/Pos T/Pos MHz dBuV/m dB dBuV/m dBuV dB dB/m dB cm deg Remark 1 * 2480.00 99.83 25.83 74.00 93.27 7.27 31.13 32.64 362 100 Peak </pre>

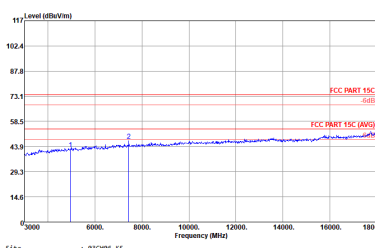
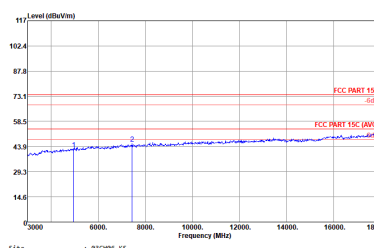

BT	2.4GHz 2400~2483.5MHz Harmonic @ 3m	
ANT	BT CH78 2480MHz	
6	Horizontal	Vertical
<p>Peak Avg.</p>	 <pre> Site : 83C980-K5 Condition : FCC PART 15C 3m 3137 SM 00318643 HORIZONTAL Project : FR1D0310 Model : 3 Plane : X Type : Single-directivity IME1 : ME : DHS Freq Level Over Limit Read CableAntenna Preamp A/Pos T/Pos Remark MHz dBuV/m dB dBuV/m dBuV dB dB/m dB cm deg 1 4965.00 42.45 -31.55 74.00 57.22 18.43 34.81 60.01 300 0 Peak 2 7440.00 47.24 -26.76 74.00 58.31 12.88 36.59 60.54 300 0 Peak </pre>	 <pre> Site : 83C980-K5 Condition : FCC PART 15C 3m 3137 SM 00318643 VERTICAL Project : FR1D0310 Model : 3 Plane : X Type : Single-directivity IME1 : ME : DHS Freq Level Over Limit Read CableAntenna Preamp A/Pos T/Pos Remark MHz dBuV/m dB dBuV/m dBuV dB dB/m dB cm deg 1 4965.00 42.49 -31.51 74.00 57.26 18.43 34.81 60.01 300 0 Peak 2 7440.00 45.59 -28.41 74.00 56.66 12.88 36.59 60.54 300 0 Peak </pre>



Emission below 1GHz
2.4GHz BT (LF)

BT	2.4GHz 2400~2483.5MHz																																																																																																																																																																											
ANT	BT LF																																																																																																																																																																											
6	Horizontal	Vertical																																																																																																																																																																										
QP / Peak	<pre> Site : 83086-K5 Condition : FCC PART 15C 3e CRL0112D SH23182 HORIZONTAL Project : (FR1D031) Node : 3 </pre> <table border="1"> <thead> <tr> <th>Peak</th> <th>Freq</th> <th>Level</th> <th>Limit</th> <th>Read</th> <th>Cable/Antenna</th> <th>Preamp</th> <th>A/Pos</th> <th>T/Pos</th> <th>Remark</th> </tr> <tr> <th></th> <th>MHz</th> <th>dBuV/m</th> <th>dB</th> <th>dBuV/m</th> <th>dB</th> <th>dB</th> <th>cm</th> <th>deg</th> <th></th> </tr> </thead> <tbody> <tr><td>1</td><td>30.00</td><td>21.64</td><td>-19.36</td><td>40.00</td><td>27.69</td><td>0.58</td><td>24.60</td><td>31.23</td><td>--- Peak</td></tr> <tr><td>2</td><td>151.19</td><td>18.50</td><td>-25.24</td><td>45.50</td><td>31.24</td><td>1.59</td><td>26.55</td><td>31.21</td><td>--- Peak</td></tr> <tr><td>3</td><td>163.86</td><td>18.10</td><td>-25.49</td><td>43.50</td><td>31.49</td><td>2.06</td><td>25.88</td><td>31.33</td><td>--- Peak</td></tr> <tr><td>4</td><td>206.93</td><td>25.91</td><td>-20.09</td><td>46.00</td><td>35.48</td><td>2.76</td><td>26.34</td><td>31.93</td><td>--- Peak</td></tr> <tr><td>5</td><td>313.24</td><td>26.64</td><td>-19.36</td><td>46.00</td><td>35.84</td><td>2.87</td><td>26.57</td><td>31.64</td><td>--- Peak</td></tr> <tr><td>6</td><td>737.13</td><td>27.00</td><td>-18.20</td><td>46.00</td><td>29.84</td><td>4.41</td><td>25.47</td><td>31.12</td><td>--- Peak</td></tr> </tbody> </table>	Peak	Freq	Level	Limit	Read	Cable/Antenna	Preamp	A/Pos	T/Pos	Remark		MHz	dBuV/m	dB	dBuV/m	dB	dB	cm	deg		1	30.00	21.64	-19.36	40.00	27.69	0.58	24.60	31.23	--- Peak	2	151.19	18.50	-25.24	45.50	31.24	1.59	26.55	31.21	--- Peak	3	163.86	18.10	-25.49	43.50	31.49	2.06	25.88	31.33	--- Peak	4	206.93	25.91	-20.09	46.00	35.48	2.76	26.34	31.93	--- Peak	5	313.24	26.64	-19.36	46.00	35.84	2.87	26.57	31.64	--- Peak	6	737.13	27.00	-18.20	46.00	29.84	4.41	25.47	31.12	--- Peak	<pre> Site : 83086-K5 Condition : FCC PART 15C 3e CRL0112D SH23182 VERTICAL Project : (FR1D031) Node : 3 </pre> <table border="1"> <thead> <tr> <th>Peak</th> <th>Freq</th> <th>Level</th> <th>Limit</th> <th>Read</th> <th>Cable/Antenna</th> <th>Preamp</th> <th>A/Pos</th> <th>T/Pos</th> <th>Remark</th> </tr> <tr> <th></th> <th>MHz</th> <th>dBuV/m</th> <th>dB</th> <th>dBuV/m</th> <th>dB</th> <th>dB</th> <th>cm</th> <th>deg</th> <th></th> </tr> </thead> <tbody> <tr><td>1</td><td>30.00</td><td>26.32</td><td>-13.68</td><td>40.00</td><td>32.37</td><td>0.58</td><td>24.60</td><td>31.23</td><td>--- Peak</td></tr> <tr><td>2</td><td>53.28</td><td>28.20</td><td>-19.72</td><td>40.00</td><td>37.80</td><td>0.93</td><td>19.62</td><td>31.35</td><td>--- Peak</td></tr> <tr><td>3</td><td>207.72</td><td>20.85</td><td>-25.15</td><td>46.00</td><td>30.37</td><td>2.08</td><td>19.31</td><td>31.63</td><td>--- Peak</td></tr> <tr><td>4</td><td>538.28</td><td>21.99</td><td>-24.81</td><td>46.00</td><td>25.37</td><td>3.77</td><td>24.62</td><td>31.57</td><td>--- Peak</td></tr> <tr><td>5</td><td>741.88</td><td>27.88</td><td>-18.12</td><td>46.00</td><td>29.81</td><td>4.43</td><td>25.56</td><td>31.12</td><td>--- Peak</td></tr> <tr><td>6</td><td>809.89</td><td>28.92</td><td>-17.08</td><td>46.00</td><td>28.85</td><td>4.80</td><td>26.52</td><td>31.25</td><td>--- Peak</td></tr> <tr><td>7</td><td>938.12</td><td>29.16</td><td>-16.84</td><td>46.00</td><td>28.87</td><td>4.90</td><td>26.81</td><td>30.68</td><td>--- Peak</td></tr> </tbody> </table>	Peak	Freq	Level	Limit	Read	Cable/Antenna	Preamp	A/Pos	T/Pos	Remark		MHz	dBuV/m	dB	dBuV/m	dB	dB	cm	deg		1	30.00	26.32	-13.68	40.00	32.37	0.58	24.60	31.23	--- Peak	2	53.28	28.20	-19.72	40.00	37.80	0.93	19.62	31.35	--- Peak	3	207.72	20.85	-25.15	46.00	30.37	2.08	19.31	31.63	--- Peak	4	538.28	21.99	-24.81	46.00	25.37	3.77	24.62	31.57	--- Peak	5	741.88	27.88	-18.12	46.00	29.81	4.43	25.56	31.12	--- Peak	6	809.89	28.92	-17.08	46.00	28.85	4.80	26.52	31.25	--- Peak	7	938.12	29.16	-16.84	46.00	28.87	4.90	26.81	30.68	--- Peak
	Peak	Freq	Level	Limit	Read	Cable/Antenna	Preamp	A/Pos	T/Pos	Remark																																																																																																																																																																		
	MHz	dBuV/m	dB	dBuV/m	dB	dB	cm	deg																																																																																																																																																																				
1	30.00	21.64	-19.36	40.00	27.69	0.58	24.60	31.23	--- Peak																																																																																																																																																																			
2	151.19	18.50	-25.24	45.50	31.24	1.59	26.55	31.21	--- Peak																																																																																																																																																																			
3	163.86	18.10	-25.49	43.50	31.49	2.06	25.88	31.33	--- Peak																																																																																																																																																																			
4	206.93	25.91	-20.09	46.00	35.48	2.76	26.34	31.93	--- Peak																																																																																																																																																																			
5	313.24	26.64	-19.36	46.00	35.84	2.87	26.57	31.64	--- Peak																																																																																																																																																																			
6	737.13	27.00	-18.20	46.00	29.84	4.41	25.47	31.12	--- Peak																																																																																																																																																																			
Peak	Freq	Level	Limit	Read	Cable/Antenna	Preamp	A/Pos	T/Pos	Remark																																																																																																																																																																			
	MHz	dBuV/m	dB	dBuV/m	dB	dB	cm	deg																																																																																																																																																																				
1	30.00	26.32	-13.68	40.00	32.37	0.58	24.60	31.23	--- Peak																																																																																																																																																																			
2	53.28	28.20	-19.72	40.00	37.80	0.93	19.62	31.35	--- Peak																																																																																																																																																																			
3	207.72	20.85	-25.15	46.00	30.37	2.08	19.31	31.63	--- Peak																																																																																																																																																																			
4	538.28	21.99	-24.81	46.00	25.37	3.77	24.62	31.57	--- Peak																																																																																																																																																																			
5	741.88	27.88	-18.12	46.00	29.81	4.43	25.56	31.12	--- Peak																																																																																																																																																																			
6	809.89	28.92	-17.08	46.00	28.85	4.80	26.52	31.25	--- Peak																																																																																																																																																																			
7	938.12	29.16	-16.84	46.00	28.87	4.90	26.81	30.68	--- Peak																																																																																																																																																																			