



CERTIFICATION TEST REPORT

Report Number. : 12132671-E4V2

Applicant : SONY MOBILE COMMUNICATIONS, INC.
4-12-3 HIGASHI-SHINAGAWA,
SHINAGAWA -KU, TOKYO, 140-0002, JAPAN

FCC ID : PY7-11821Y

EUT Description : GSM/WCDMA/LTE Phone with BT, DTS/UNII a/b/g/n/ac &
NFC

Test Standard(s) : FCC 47 CFR PART 15 SUBPART C

Date Of Issue:
March 08, 2018

Prepared by:
UL Verification Services Inc.
47173 Benicia Street
Fremont, CA 94538, U.S.A.
TEL: (510) 771-1000
FAX: (510) 661-0888



REPORT REVISION HISTORY

Rev.	Issue Date	Revisions	Revised By
V1	3/7/2018	Initial Issue	
V2	3/8/2018	Updated Section 5.5, 5.6, Added section 9.2,	Kiya Kedida

TABLE OF CONTENTS

REPORT REVISION HISTORY	2
TABLE OF CONTENTS	3
1. ATTESTATION OF TEST RESULTS	5
2. TEST METHODOLOGY	6
3. FACILITIES AND ACCREDITATION	6
4. CALIBRATION AND UNCERTAINTY	6
4.1. <i>MEASURING INSTRUMENT CALIBRATION</i>	<i>6</i>
4.2. <i>SAMPLE CALCULATION</i>	<i>6</i>
4.3. <i>MEASUREMENT UNCERTAINTY.....</i>	<i>7</i>
5. EQUIPMENT UNDER TEST.....	8
5.1. <i>EUT DESCRIPTION.....</i>	<i>8</i>
5.2. <i>MAXIMUM OUTPUT POWER.....</i>	<i>8</i>
5.3. <i>DESCRIPTION OF AVAILABLE ANTENNAS.....</i>	<i>8</i>
5.4. <i>SOFTWARE AND FIRMWARE.....</i>	<i>8</i>
5.5. <i>WORST-CASE CONFIGURATION AND MODE.....</i>	<i>9</i>
5.6. <i>DESCRIPTION OF TEST SETUP.....</i>	<i>10</i>
6. MEASUREMENT METHOD.....	13
7. TEST AND MEASUREMENT EQUIPMENT	14
8. ANTENNA PORT TEST RESULTS.....	15
8.1. <i>ON TIME AND DUTY CYCLE.....</i>	<i>15</i>
8.2. <i>99% BANDWIDTH.....</i>	<i>17</i>
8.2.1. <i>802.11b MODE</i>	<i>17</i>
8.2.2. <i>802.11g MODE</i>	<i>21</i>
8.2.3. <i>802.11n HT20 MODE</i>	<i>25</i>
8.3. <i>6 dB BANDWIDTH.....</i>	<i>29</i>
8.3.1. <i>802.11b MODE</i>	<i>29</i>
8.3.2. <i>802.11g MODE</i>	<i>33</i>
8.3.3. <i>802.11n HT20 MODE</i>	<i>37</i>
8.4. <i>OUTPUT POWER.....</i>	<i>41</i>
8.4.1. <i>802.11b MODE</i>	<i>42</i>
8.4.2. <i>802.11g MODE</i>	<i>43</i>
8.4.3. <i>802.11n HT20 MODE</i>	<i>44</i>
8.5. <i>POWER SPECTRAL DENSITY.....</i>	<i>45</i>
8.5.1. <i>802.11b MODE</i>	<i>45</i>

8.5.2.	802.11g MODE	49
8.5.3.	802.11n HT20 MODE	53
8.6.	<i>CONDUCTED SPURIOUS EMISSIONS</i>	57
8.6.1.	802.11b MODE	58
8.6.2.	802.11g MODE	62
8.6.3.	802.11n HT20 MODE	66
9.	RADIATED TEST RESULTS	70
9.1.	<i>TRANSMITTER ABOVE 1 GHz</i>	71
9.1.1.	TX ABOVE 1 GHz 802.11b MODE IN THE 2.4 GHz BAND	71
9.1.2.	TX ABOVE 1 GHz 802.11g MODE IN THE 2.4 GHz BAND	85
9.1.3.	TX ABOVE 1 GHz 802.11n HT20 MODE IN THE 2.4 GHz BAND.....	99
9.2.	<i>WORST-CASE BELOW 30 MHz</i>	113
9.3.	<i>Worst Case Below 1 GHz</i>	114
9.4.	<i>Worst Case 18-26 GHz</i>	116
10.	AC POWER LINE CONDUCTED EMISSIONS	118
10.1.1.	AC Power Line Norm	119
11.	SETUP PHOTOS	121

1. ATTESTATION OF TEST RESULTS

COMPANY NAME: SONY MOBILE COMMUNICATIONS, INC.
4-12-3 HIGASHI-SHINAGAWA,
SHINAGAWA -KU, TOKYO, 140-0002, JAPAN

EUT DESCRIPTION: GSM/WCDMA/LTE Phone with BT, DTS/UNII a/b/g/n/ac &
NFC

SERIAL NUMBER: BH90005YBB (RADIATED)
BH90009EBB (CONDUCTED)

DATE TESTED: FEBRUARY 12-19 & MARCH 2 , 2018

APPLICABLE STANDARDS	
STANDARD	TEST RESULTS
CFR 47 Part 15 Subpart C	Complies

UL Verification Services Inc. tested the above equipment in accordance with the requirements set forth in the above standards. All indications of Pass/Fail in this report are opinions expressed by UL Verification Services Inc. based on interpretations and/or observations of test results. Measurement Uncertainties were not taken into account and are published for informational purposes only. The test results show that the equipment tested is capable of demonstrating compliance with the requirements as documented in this report.

Note: The results documented in this report apply only to the tested sample, under the conditions and modes of operation as described herein. This document may not be altered or revised in any way unless done so by UL Verification Services Inc. and all revisions are duly noted in the revisions section. Any alteration of this document not carried out by UL Verification Services Inc. will constitute fraud and shall nullify the document. This report must not be used by the client to claim product certification, approval, or endorsement by NVLAP, NIST, any agency of the Federal Government, or any agency of the U.S. government.

Approved & Released For
UL Verification Services Inc. By:

Prepared By:

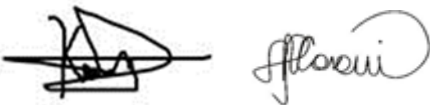

Kiya Kedida/Dan Corona
CONSUMER TECHNOLOGY DIVISION
Project Engineer/Operations Leader
UL Verification Services Inc.

Jason Qian
CONSUMER TECHNOLOGY DIVISION
Test Engineer
UL Verification Services Inc.

2. TEST METHODOLOGY

The tests documented in this report were performed in accordance with FCC CFR 47 Part 2, FCC CFR 47 Part 15, KDB 558074 D01 v04, KDB 662911 D01 v02r01 and ANSI C63.10-2013.

3. FACILITIES AND ACCREDITATION

The test sites and measurement facilities used to collect data are located at 47173 and 47266 Benicia Street, Fremont, California, USA. Line conducted emissions are measured only at the 47173 address. The following table identifies which facilities were utilized for radiated emission measurements documented in this report. Specific facilities are also identified in the test results sections.

47173 Benicia Street		47266 Benicia Street	
<input checked="" type="checkbox"/>	Chamber A (ISED:2324B-1)	<input type="checkbox"/>	Chamber D (ISED:22541-1)
<input checked="" type="checkbox"/>	Chamber B (ISED:2324B-2)	<input type="checkbox"/>	Chamber E (ISED:22541-2)
<input type="checkbox"/>	Chamber C (ISED:2324B-3)	<input type="checkbox"/>	Chamber F (ISED:22541-3)
		<input type="checkbox"/>	Chamber G (ISED:22541-4)
		<input type="checkbox"/>	Chamber H (ISED:22541-5)

The above test sites and facilities are covered under FCC Test Firm Registration # 208313. Chambers A through C are covered under ISED company address code 2324B with site numbers 2324B -1 through 2324B-3, respectively. Chambers D through H are covered under ISED Canada company address code 22541 with site numbers 22541 -1 through 22541-5, respectively.

UL Verification Services Inc. is accredited by NVLAP, Laboratory Code 200065-0. The full scope of accreditation can be viewed at <http://ts.nist.gov/standards/scopes/2000650.htm>.

4. CALIBRATION AND UNCERTAINTY

4.1. MEASURING INSTRUMENT CALIBRATION

The measuring equipment utilized to perform the tests documented in this report has been calibrated in accordance with the manufacturer's recommendations, and is traceable to recognized national standards.

4.2. SAMPLE CALCULATION

Where relevant, the following sample calculation is provided:

$$\begin{aligned} \text{Field Strength (dBuV/m)} &= \text{Measured Voltage (dBuV)} + \text{Antenna Factor (dB/m)} + \\ &\text{Cable Loss (dB)} - \text{Preamp Gain (dB)} \\ 36.5 \text{ dBuV} + 18.7 \text{ dB/m} + 0.6 \text{ dB} - 26.9 \text{ dB} &= 28.9 \text{ dBuV/m} \end{aligned}$$

4.3. MEASUREMENT UNCERTAINTY

Where relevant, the following measurement uncertainty levels have been estimated for tests performed on the apparatus:

PARAMETER	UNCERTAINTY
Worst Case Conducted Disturbance, 9KHz to 0.15 MHz	3.84 dB
Worst Case Conducted Disturbance, 0.15 to 30 MHz	3.65 dB
Worst Case Radiated Disturbance, 9KHz to 30 MHz	3.15 dB
Worst Case Radiated Disturbance, 30 to 1000 MHz	5.36 dB
Worst Case Radiated Disturbance, 1000 to 18000 MHz	4.32 dB
Worst Case Radiated Disturbance, 18000 to 26000 MHz	4.45 dB
Worst Case Radiated Disturbance, 26000 to 40000 MHz	5.24 dB

Uncertainty figures are valid to a confidence level of 95%.

5. EQUIPMENT UNDER TEST

5.1. EUT DESCRIPTION

The EUT is a GSM/WCDMA/LTE Phone with BT, DTS/UNII a/b/g/n/ac & NFC.

5.2. MAXIMUM OUTPUT POWER

The transmitter has a maximum conducted output power as follows:

Frequency Range (MHz)	Mode	Output Power (dBm)	Output Power (mW)
2Tx			
2412 - 2472	802.11b	15	31.62
2412 - 2472	802.11g	15.68	36.98
2412 - 2472	802.11n HT20 CDD	15.76	37.67

5.3. DESCRIPTION OF AVAILABLE ANTENNAS

The radio utilizes Loop Type antennas, with the following maximum gains:

Frequency Band (GHz)	Antenna Gain (dBi) CH0	Antenna Gain (dBi) CH1
2402-2480	-0.60	-8.40

5.4. SOFTWARE AND FIRMWARE

The firmware installed in the EUT during testing was s_atp_XXX_0_00333_A_11.
The test utility software used during testing was Tera Term Ver 4.79.

5.5. WORST-CASE CONFIGURATION AND MODE

Radiated emissions below 1GHz, above 18GHz, and AC power line conducted emission were performed with the EUT set to transmit at the channel with highest output power as a worst-case scenario.

Band edge and radiated emissions between 1GHz and 18GHz were performed with the EUT set to transmit at the highest power on low, middle and high channels.

The fundamental of the EUT was investigated in three orthogonal orientations X, Y, & Z, and it was determined that Y-Axis with AC/DC Adapter was worst-case orientation; therefore, all final radiated testing was performed with the EUT in Y-Axis with AC/DC Adapter orientation.

Worst-case data rates as provided by the client were:

802.11b mode: 1 Mbps

802.11g mode: 6 Mbps

802.11n HT20mode: MCS0

The CDD methodology is used for 2.4GHz (802.11g and 802.11n HT20) for more information; please refer to PY7-11821Y Theory of Operation.

The simultaneous mode (SISO 2.4GHz Chain 0 and 5GHz chain 1) was checked and stand-alone (MIMO) 2.4 GHz / 5GHz remain the worst case.

NOTE: SISO mode is covered by MIMO mode due to same maximum tune-up limit (power).

5.6. DESCRIPTION OF TEST SETUP

SUPPORT EQUIPMENT

Support Equipment List				
Description	Manufacturer	Model	Serial Number	FCC ID
Laptop	Lenovo	20B7S0A200	PC015REW	NA
AC Adapter	SONY	UCH12	4016W40310044	NA
DC Power Supply	Ametek	XT 15-4	T463	N/A

I/O CABLES (CONDUCTED TEST)

I/O Cable List						
Cable No	Port	# of identical ports	Connector Type	Cable Type	Cable Length (m)	Remarks
1	Antenna	1	RF	Shielded	0.2	To spectrum Analyzer
2	USB	1	USB	Shielded	1	N/A
3	DC	1	DC	Shielded	0.3	N/A

I/O CABLES (RADIATED AND CONDUCTED EMISSIONS)

I/O Cable List						
Cable No	Port	# of identical ports	Connector Type	Cable Type	Cable Length (m)	Remarks
1	USB	1	USB	Shielded	3	N/A

TEST SETUP

SETUP DIAGRAM FOR CONDUCTED TESTS

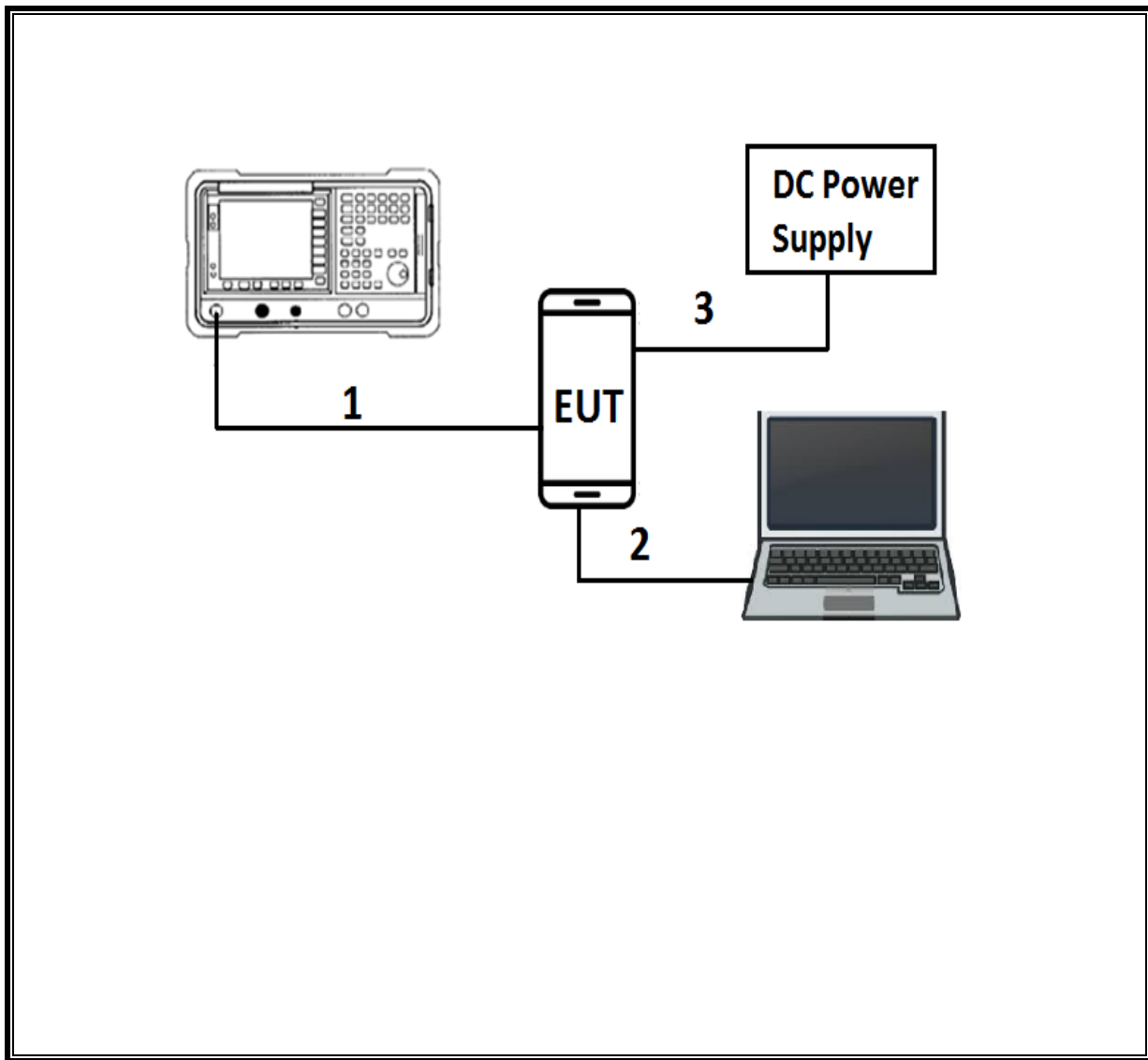

TEST SETUP

RADIATED AND AC LINE CONDUCTED EMISSIONS SETUP DIAGRAM

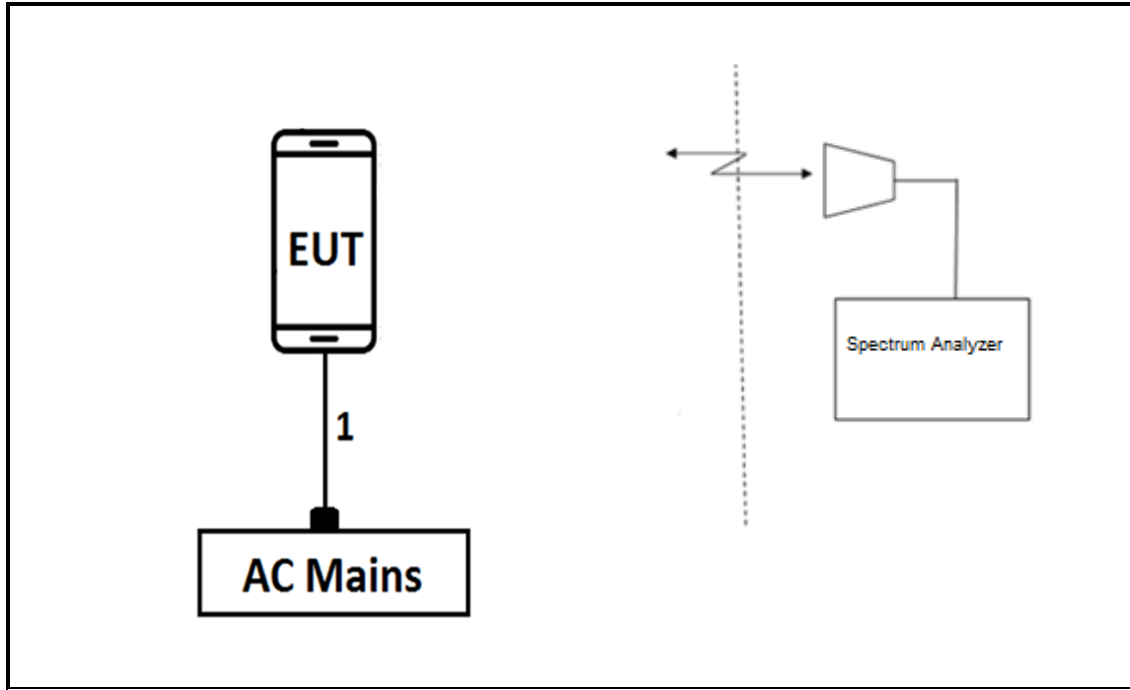

6. MEASUREMENT METHOD

On Time and Duty Cycle: KDB 558074 D01 v04, Section 6.

6 dB BW: KDB 558074 D01 v04, Section 8.1.

99% BW: ANSI C63.10-2013, Section 6.9.3.

Output Power: KDB 558074 D01 v04, Section 9.2.3.2.

Power Spectral Density: KDB 558074 D01 v04, Section 10.3.

Out-of-band emissions in non-restricted bands: KDB 558074 D01 v04, Section 11.1 (b).

Out-of-band emissions in restricted bands: KDB 558074 D01 v04, Section 12.1.

Band-edge: KDB 558074 D01 v04, Section 12.1.

AC Power Line Conducted Emissions: ANSI C63.10-2013, Section 6.2.

7. TEST AND MEASUREMENT EQUIPMENT

The following test and measurement equipment was utilized for the tests documented in this report:

TEST EQUIPMENT LIST					
Description	Manufacturer	Model	ID Num	Cal Due	Last Cal
Amplifier, 10KHz to 1GHz, 32dB	Agilent (Keysight) Technologies	8447D	T10	02/14/2019	02/14/2018
RF Preamplifier, 1 - 26GHz	Agilent	8449B	T404	07/23/2018	07/23/2017
Antenna, Broadband Hybrid, 30MHz to 2000MHz	Sunol Sciences Corp.	JB3	T243	06/15/2018	06/15/2017
Antenna, Horn 1-18GHz	ETS-Lindgren	3117	T863	06/09/2018	06/09/2017
Antenna, Horn 1-18GHz	ETS-Lindgren	3117	T862	06/09/2018	06/09/2017
Power Meter, P-series single channel	Agilent (Keysight) Technologies	N1911A	T1269	03/29/2018	03/29/2017
Power Sensor, P - series, 50MHz to 18GHz, Wideband	Agilent (Keysight) Technologies	N1921A	T1224	03/29/2018	03/29/2017
Amplifier, 1 - 18GHz	MITEQ	AFS42-00101800-25-S-42	T931	09/20/2018	09/20/2017
Amplifier, 1-8GHz	MITEQ	AMF-4D-01000800-30-29P	T1156	06/24/2018	06/24/2017
Spectrum Analyzer, PXA, 3Hz to 44GHz	Agilent (Keysight) Technologies	N9030A	T1466	04/11/2018	04/11/2017
Spectrum Analyzer, PXA, 3Hz to 44GHz	Agilent (Keysight) Technologies	N9030A	T1454	01/08/2019	01/08/2018
Spectrum Analyzer, PXA, 3Hz to 44GHz	Agilent (Keysight) Technologies	N9030A	T1113	12/21/2018	12/21/2017
Spectrum Analyzer, PXA, 3Hz to 44GHz	Agilent (Keysight) Technologies	N9030A	T1450	02/05/2019	02/05/2018
Antenna, Horn 18-26.5GHz	ARA	MWH-1826	T449	01/04/2019	01/04/2018
Antenna, Active Loop 9kHz-30MHz	Com-Power Corp.	AL-130R	T1866	10/10/2018	10/10/2017
Test Receiver, EMI, 10Hz-7GHz	Rhode&Schwarz	ESR	T1436	01/06/2019	01/06/2018
LISN	FISCHER	FCC-LISN-50/250-25-2-01	T1310	01/17/2019	01/17/2018

Test Software List			
Description	Manufacturer	Model	Version
Radiated Software	UL	UL EMC	Ver 9.5, December 1, 2016
Antenna Port Software	UL	UL RF	Ver 9.1, January 25, 2018

8. ANTENNA PORT TEST RESULTS

8.1. ON TIME AND DUTY CYCLE

LIMITS

None; for reporting purposes only.

PROCEDURE

KDB 789033 Zero-Span Spectrum Analyzer Method.

ON TIME AND DUTY CYCLE RESULTS

Mode	ON Time B (msec)	Period (msec)	Duty Cycle x (linear)	Duty Cycle (%)	Duty Cycle Correction Factor (dB)	1/B Minimum VBW (kHz)
2.4GHz Band						
802.11b 1TX	12.220	12.300	0.993	99.35%	0.00	0.010
802.11g 1TX	2.025	2.064	0.981	98.11%	0.00	0.010
802.11n HT20 1TX	2.509	2.568	0.977	97.70%	0.10	0.399

DUTY CYCLE PLOTS



8.2. 99% BANDWIDTH

LIMITS

None; for reporting purposes only.

RESULTS

8.2.1. 802.11b MODE

Channel	Frequency (MHz)	99% Bandwidth Chain 0 (MHz)	99% Bandwidth Chain 1 (MHz)
Low 1	2412	14.421	14.148
Mid 6	2437	13.929	13.937
High 11	2462	13.509	14.000
High 12	2467	13.895	13.936
High 13	2472	14.219	14.058

LOW CHANNEL 1

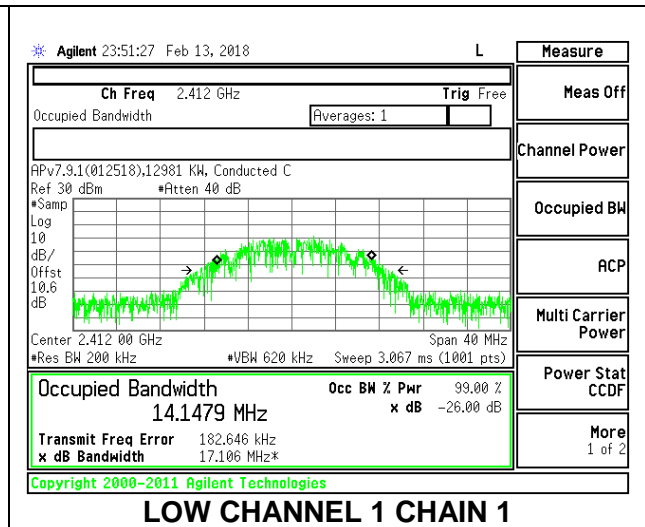
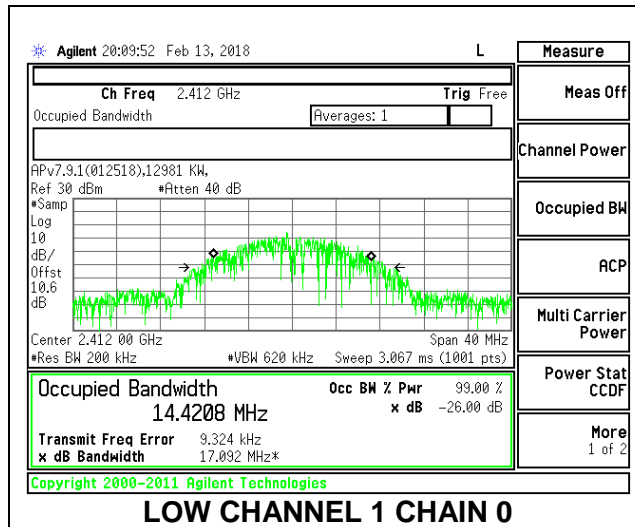

MID CHANNEL 6

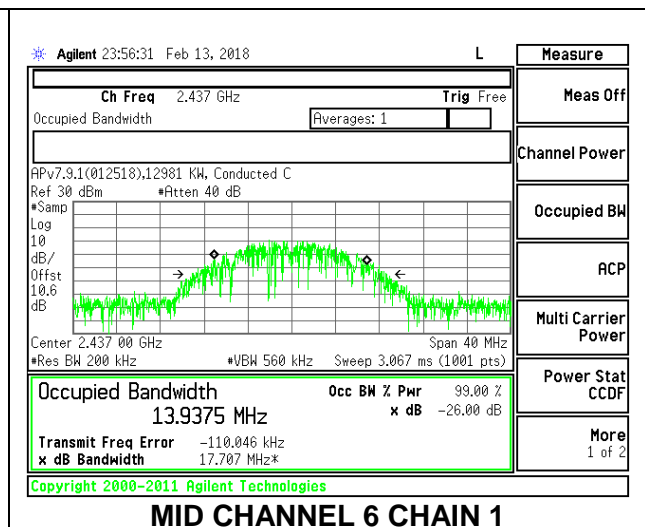
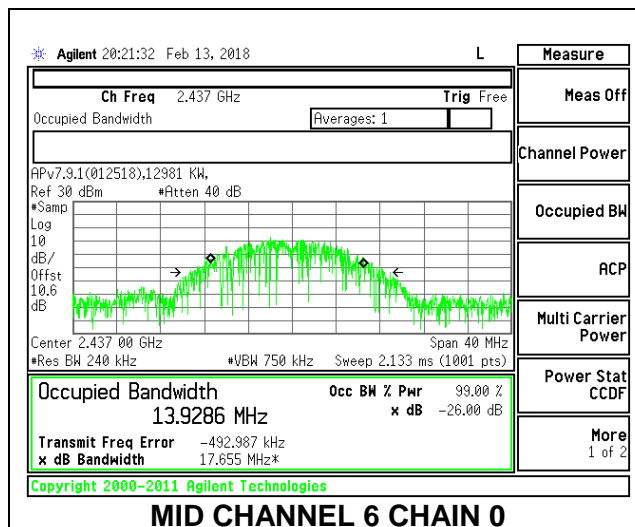

HIGH CHANNEL 11

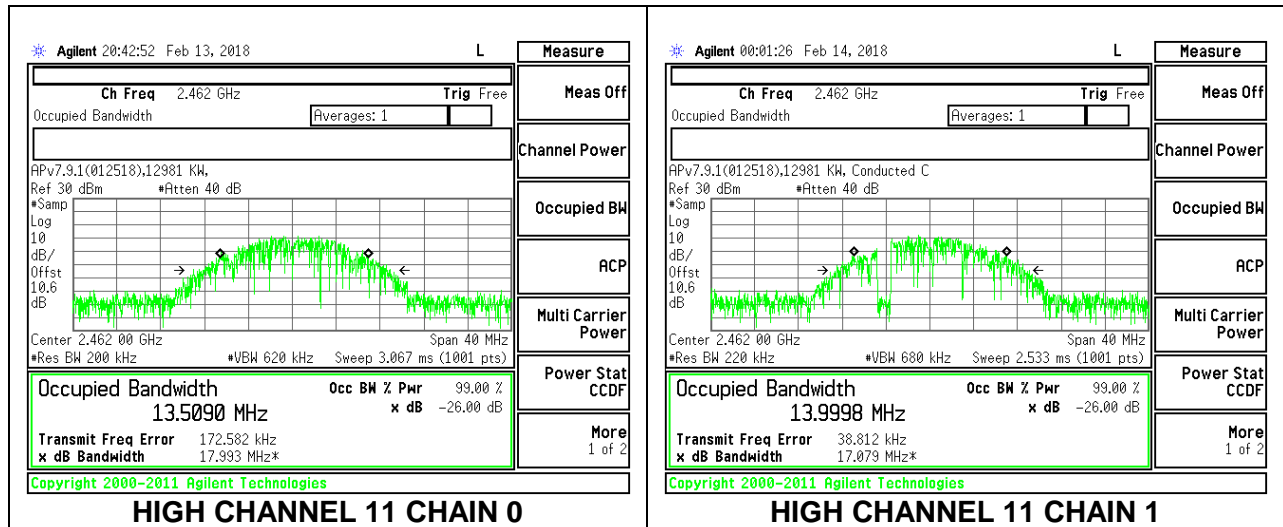

HIGH CHANNEL 12

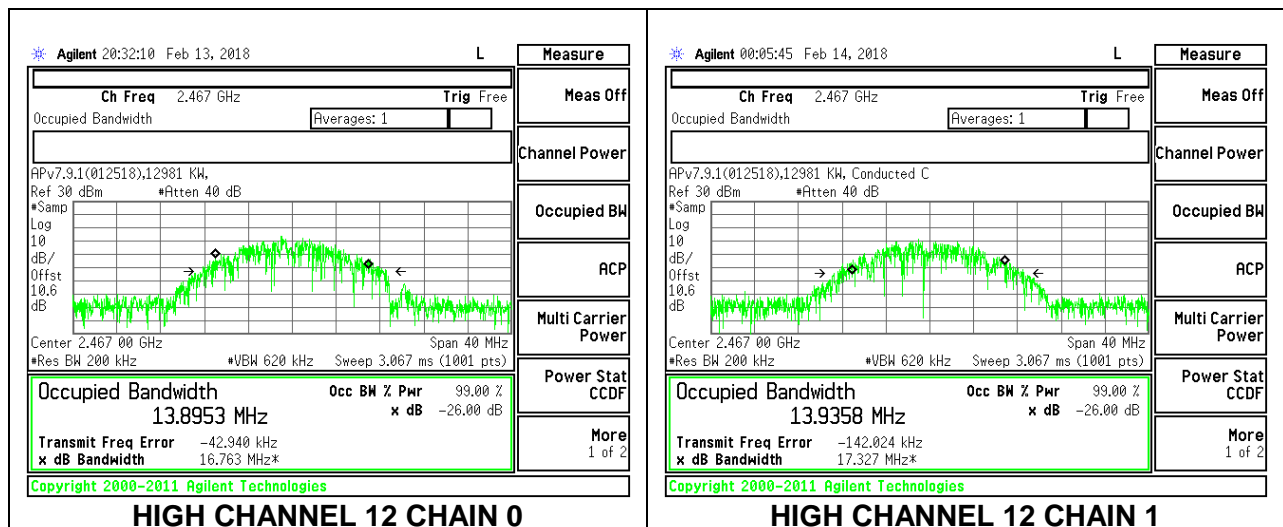

HIGH CHANNEL 13

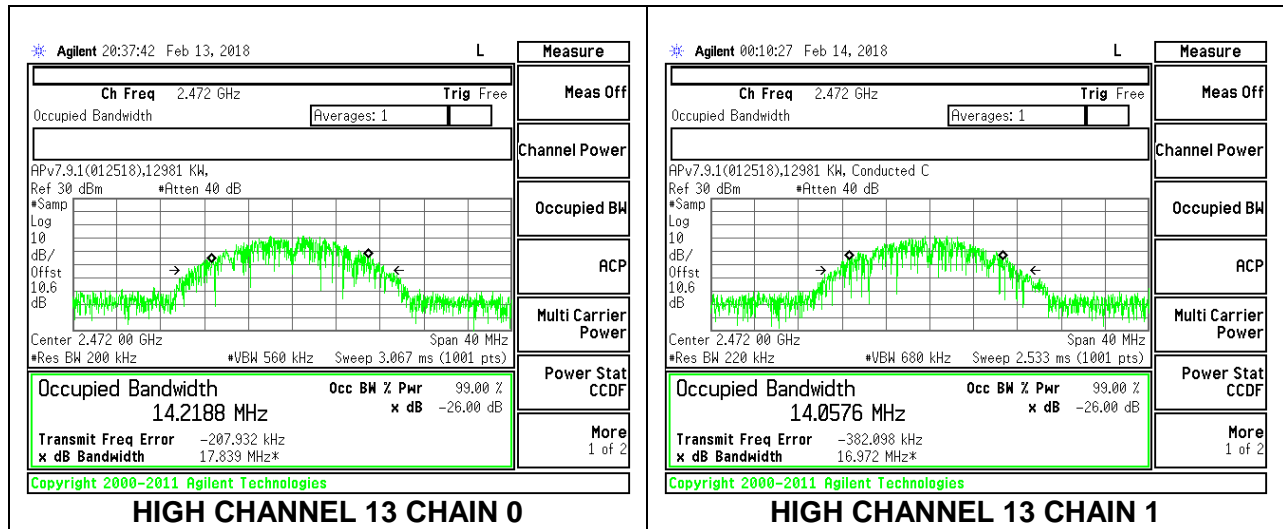

8.2.2. 802.11g MODE

Channel	Frequency (MHz)	99% Bandwidth Chain 0 (MHz)	99% Bandwidth Chain 1 (MHz)
Low 1	2412	16.580	16.451
Mid 6	2437	16.544	16.496
High 11	2462	16.432	16.445
High 12	2467	16.375	16.376
High 13	2472	16.601	16.577

LOW CHANNEL 1

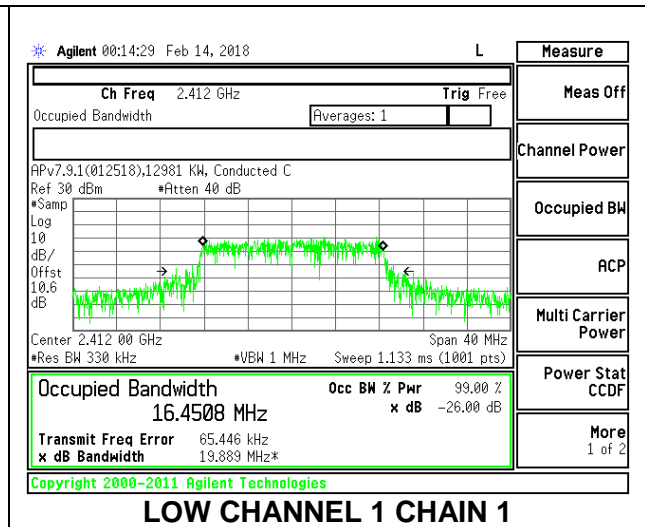
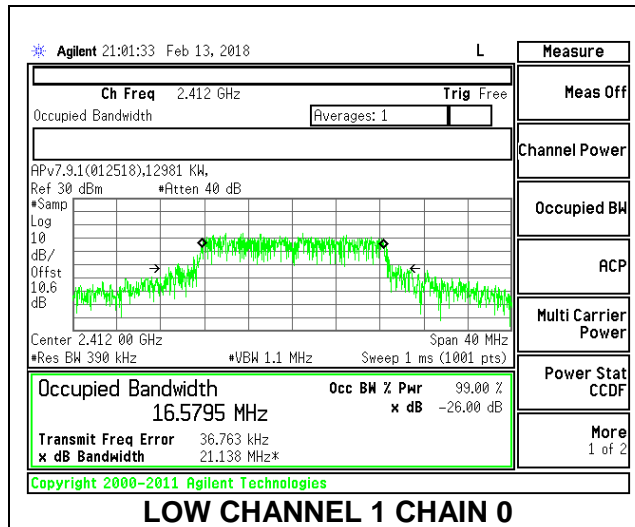

MID CHANNEL 6

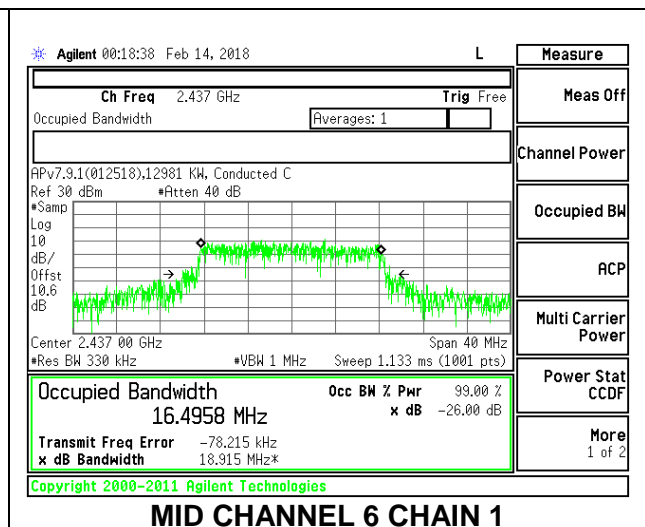
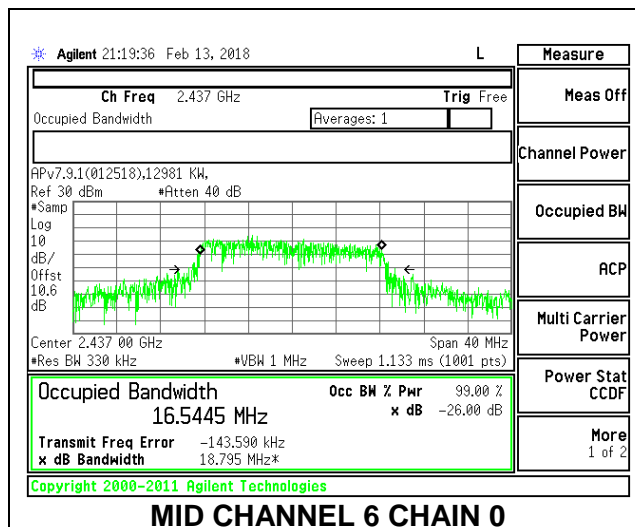

HIGH CHANNEL 11

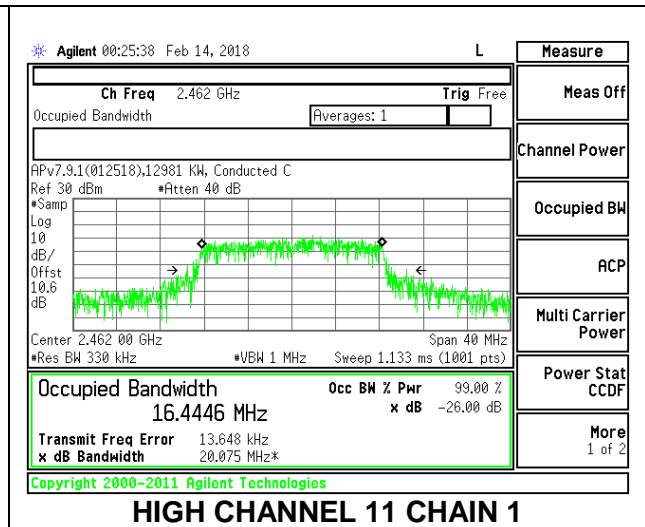
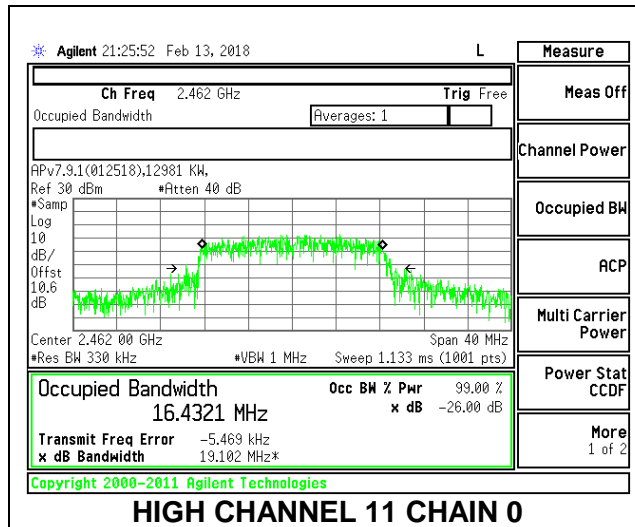

HIGH CHANNEL 12

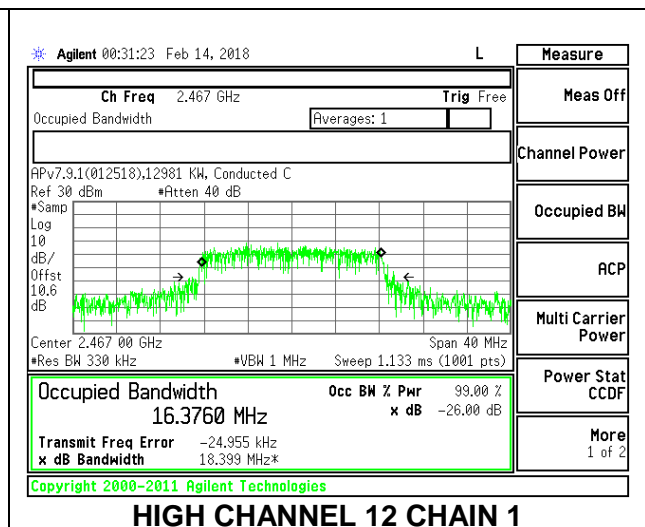
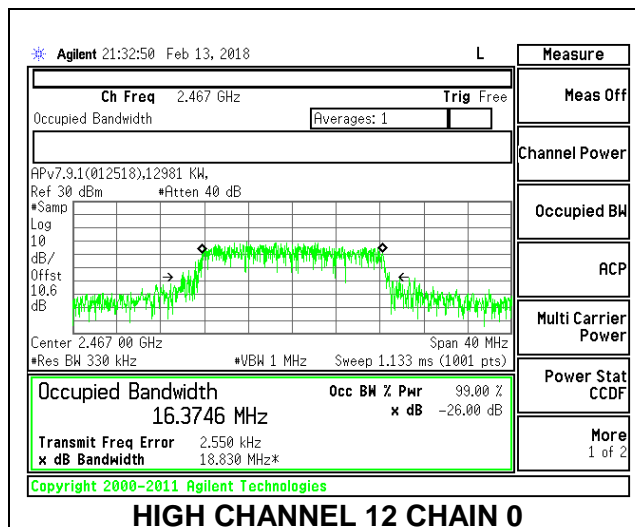

HIGH CHANNEL 13

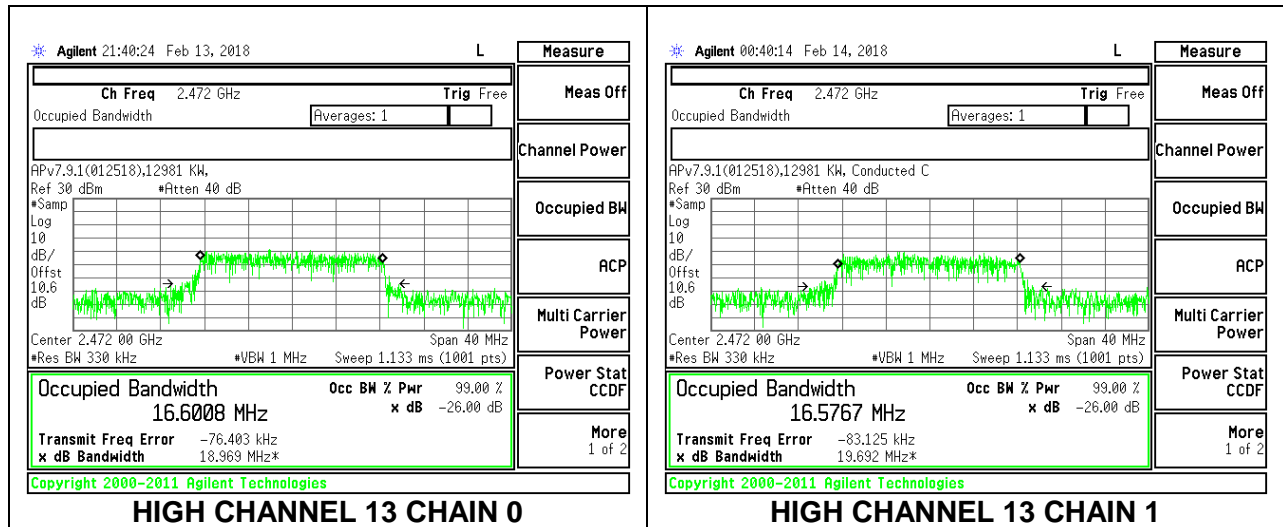

8.2.3. 802.11n HT20 MODE

Channel	Frequency (MHz)	99% Bandwidth Chain 0 (MHz)	99% Bandwidth Chain 1 (MHz)
Low 1	2412	17.873	17.604
Mid 6	2437	17.745	17.591
High 11	2462	17.647	17.643
High 12	2467	17.615	17.579
High 13	2472	17.749	17.716

LOW CHANNEL 1

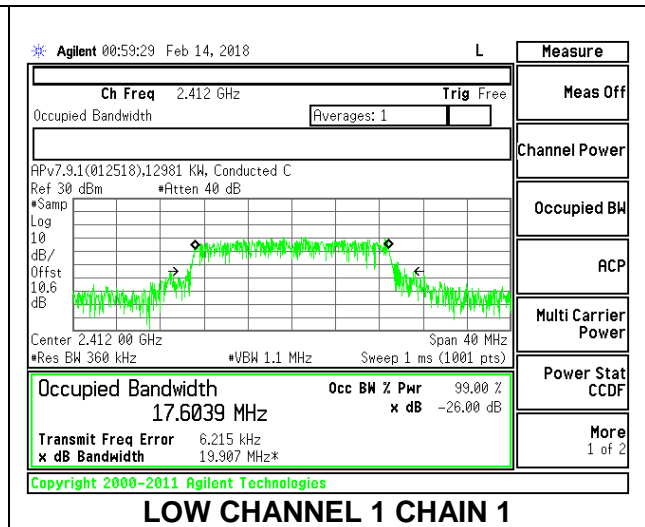
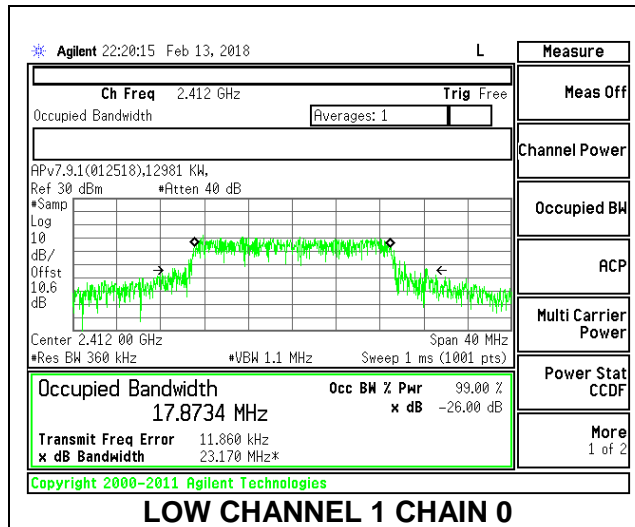

MID CHANNEL 6

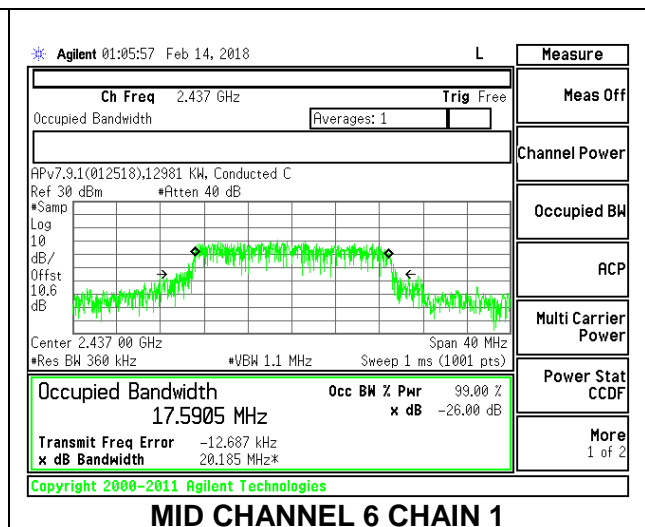
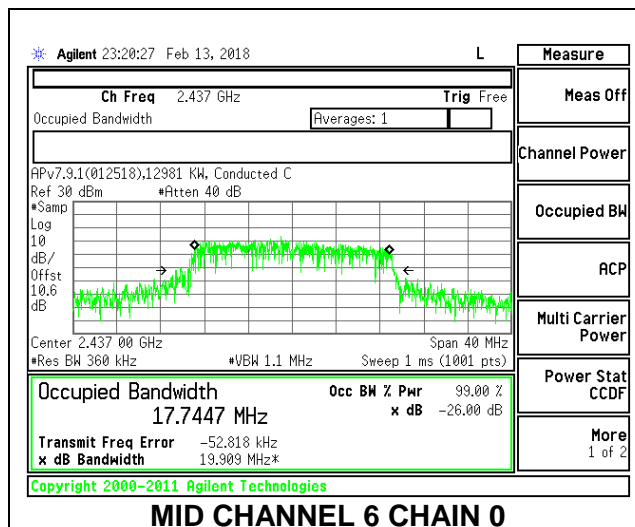

HIGH CHANNEL 11

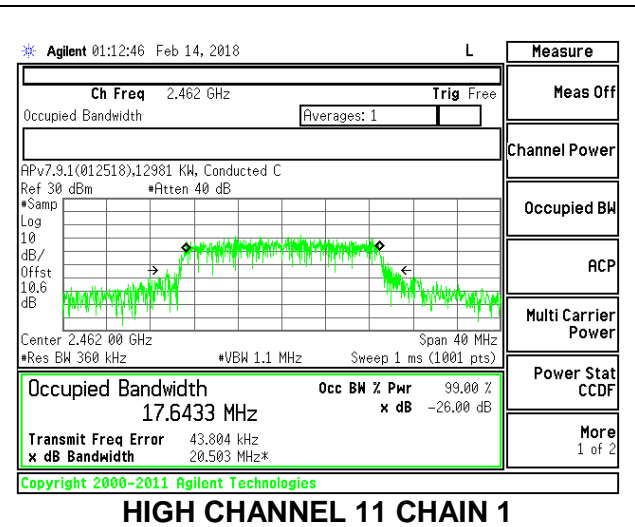
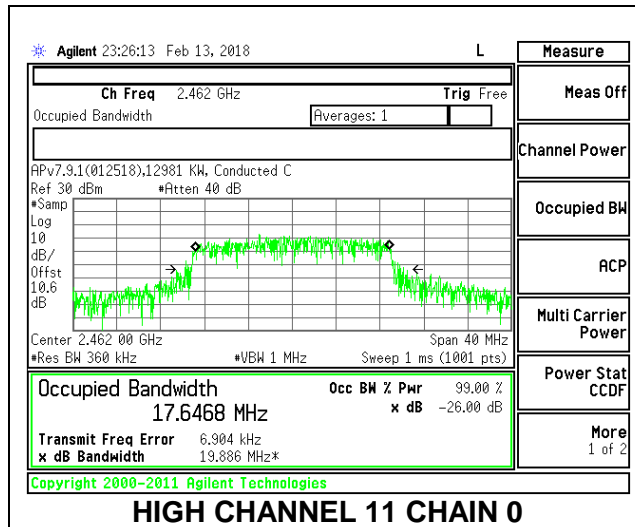

HIGH CHANNEL 12

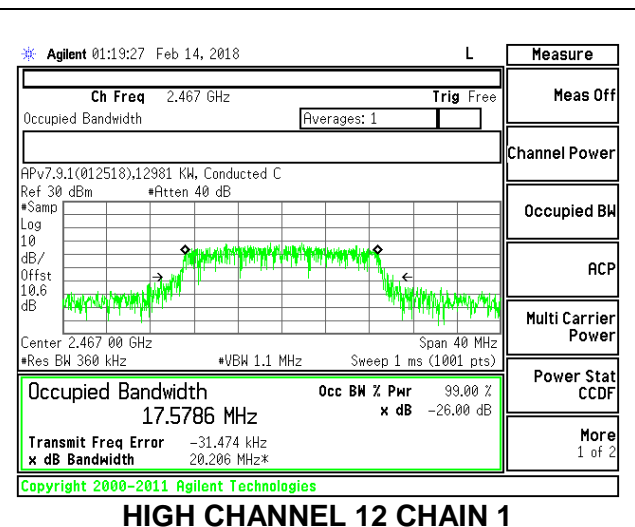
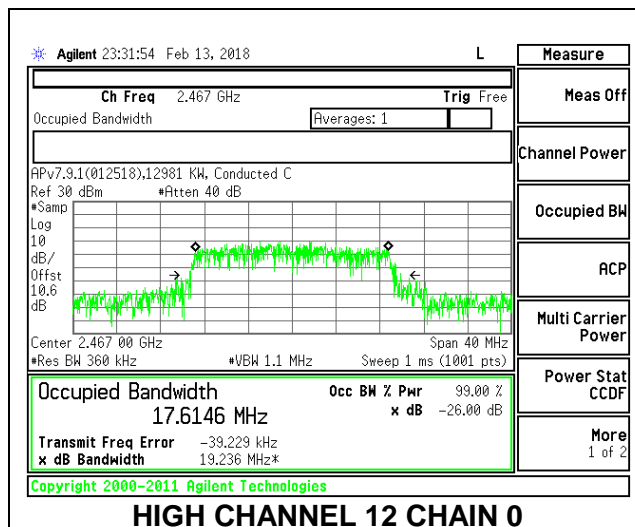

HIGH CHANNEL 13

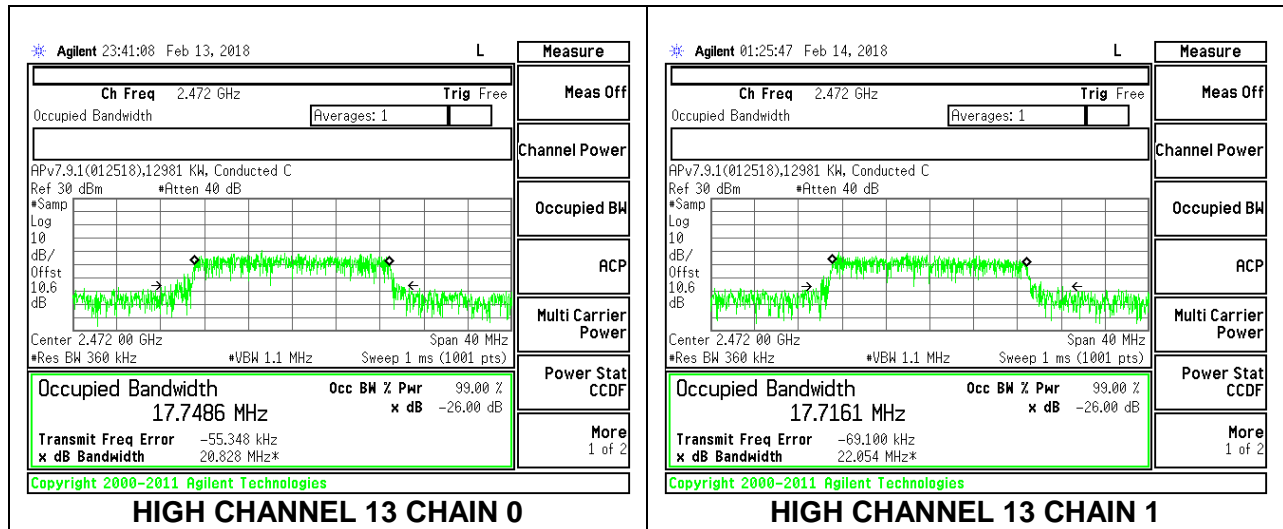

8.3. 6 dB BANDWIDTH

LIMITS

FCC §15.247 (a) (2)

The minimum 6 dB bandwidth shall be at least 500 kHz.

RESULTS

8.3.1. 802.11b MODE

Channel	Frequency (MHz)	6 dB BW Chain 0 (MHz)	6 dB BW Chain 1 (MHz)	Minimum Limit (MHz)
Low 1	2412	8.60	9.08	0.5
Mid 6	2437	8.08	7.56	0.5
High 11	2462	7.60	8.08	0.5
High 12	2467	8.60	8.08	0.5
High 13	2472	9.52	8.04	0.5

LOW CHANNEL 1

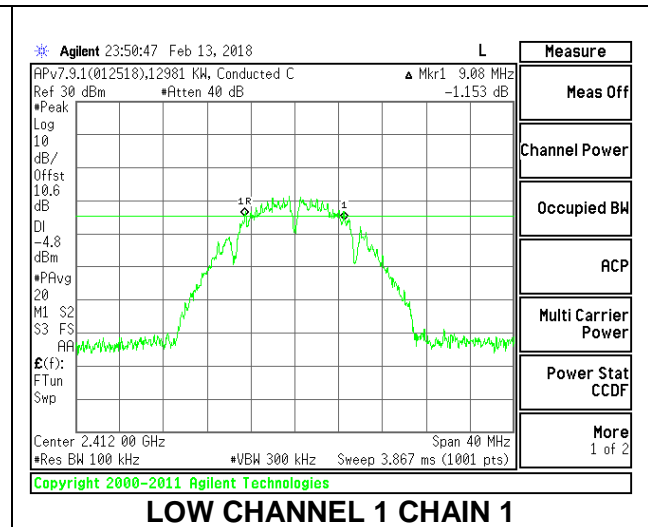
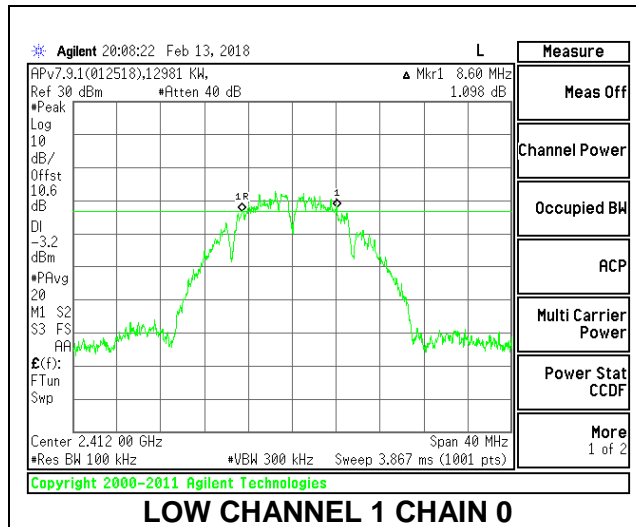

MID CHANNEL 6

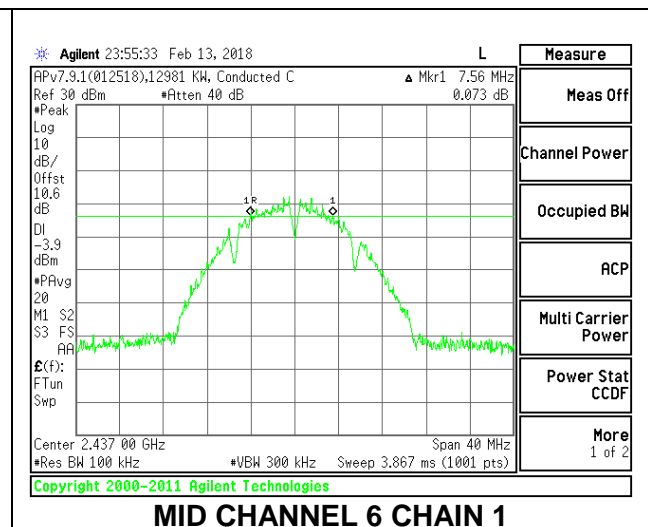
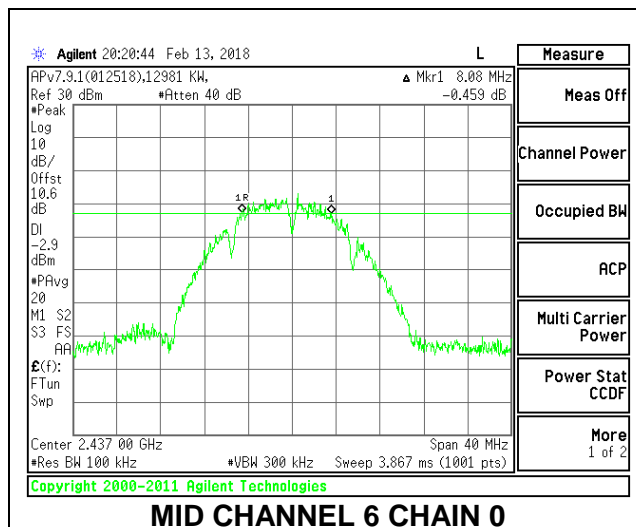

HIGH CHANNEL 11

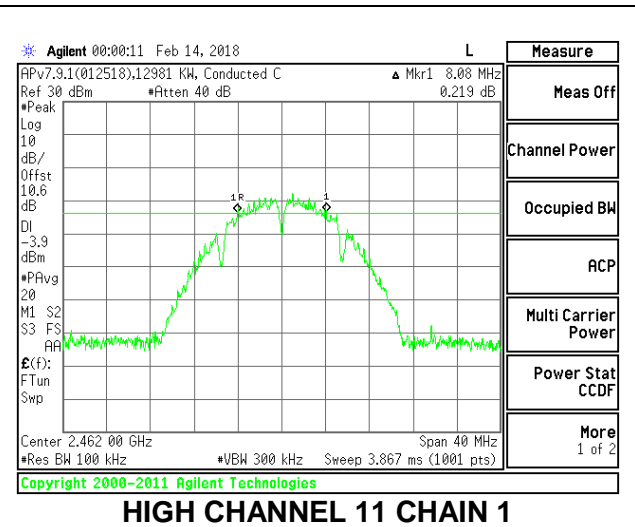
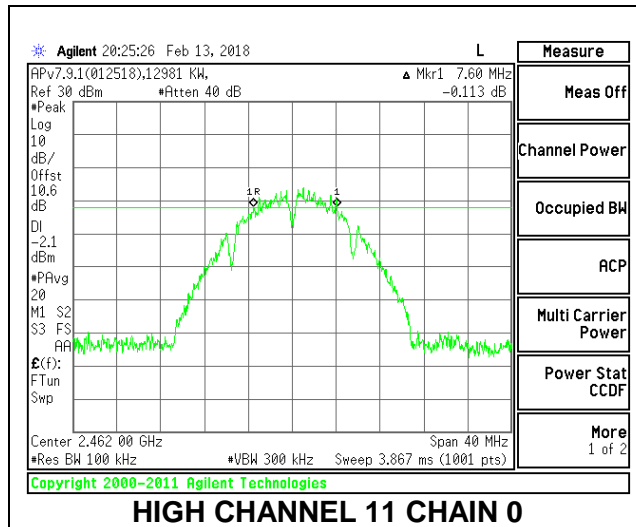

HIGH CHANNEL 12

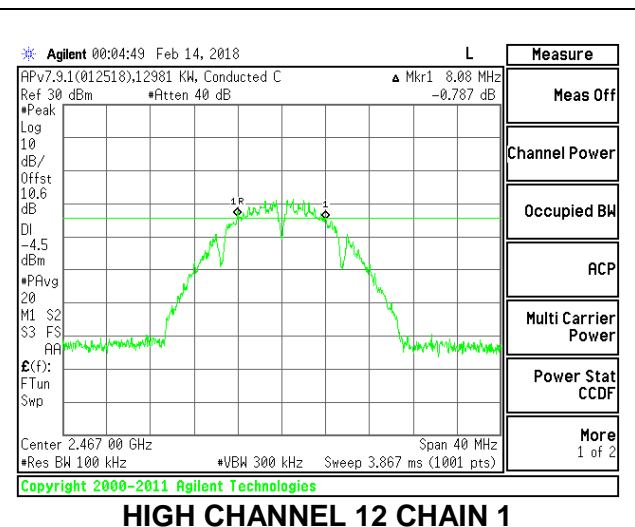
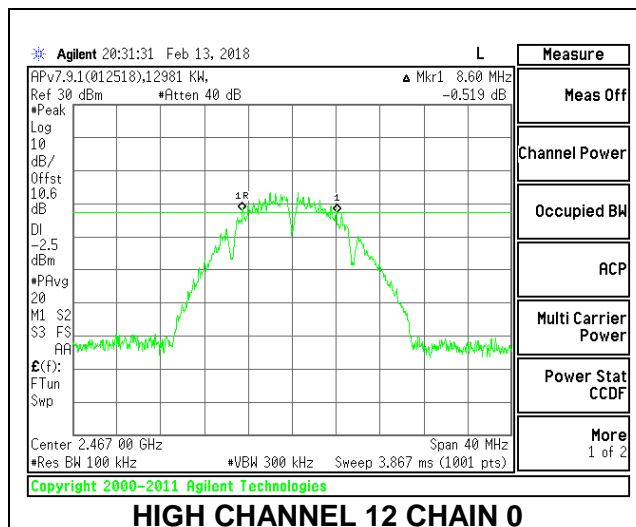

HIGH CHANNEL 13

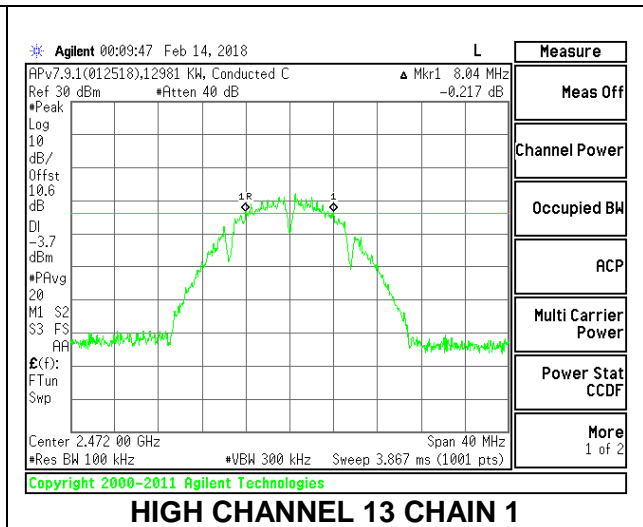
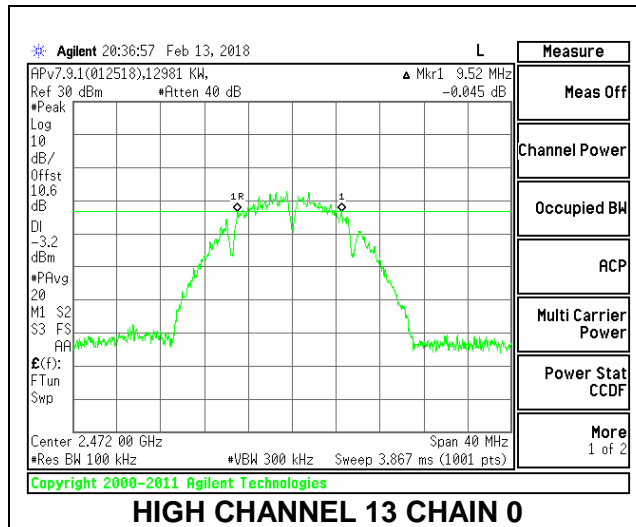

8.3.2. 802.11g MODE

Channel	Frequency (MHz)	6 dB BW Chain 0 (MHz)	6 dB BW Chain 1 (MHz)	Minimum Limit (MHz)
Low 1	2412	16.40	16.40	0.5
Mid 6	2437	16.44	15.72	0.5
High 11	2462	16.04	15.40	0.5
High 12	2467	16.32	15.40	0.5
High 13	2472	16.36	16.08	0.5

LOW CHANNEL 1

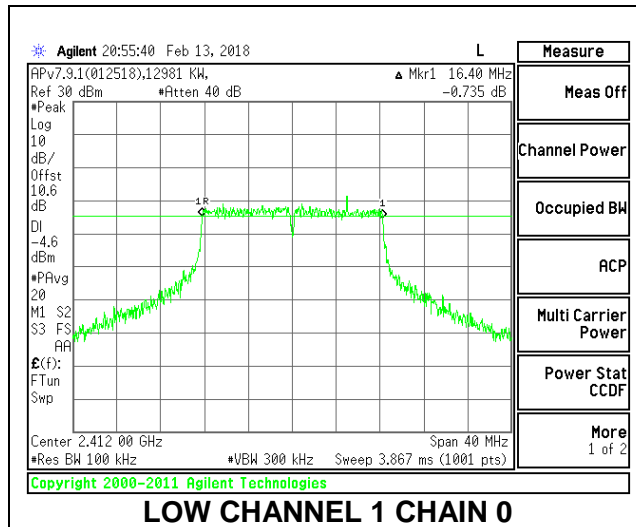

LOW CHANNEL 1 CHAIN 0

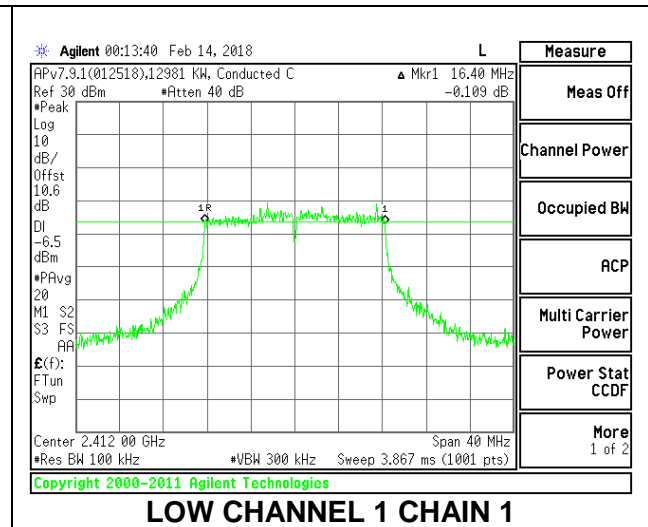

LOW CHANNEL 1 CHAIN 1

MID CHANNEL 6

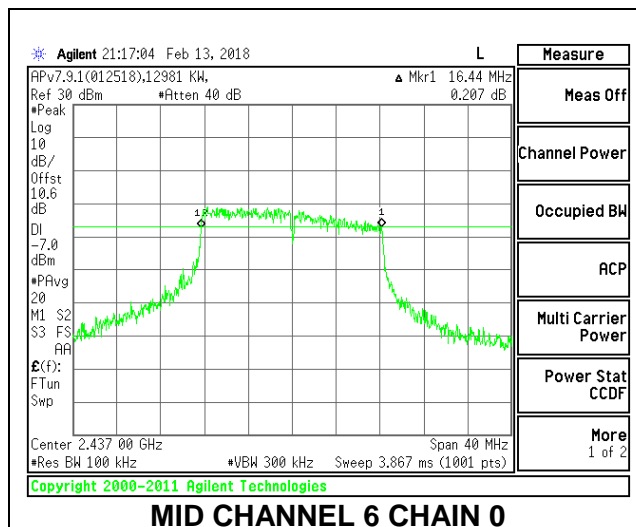

MID CHANNEL 6 CHAIN 0

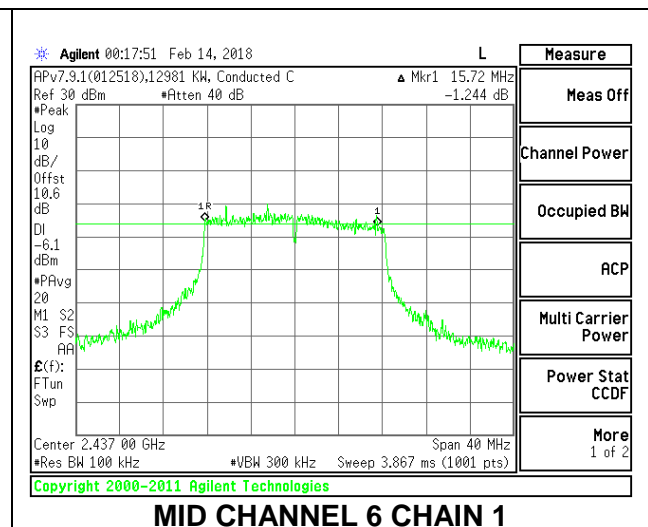

MID CHANNEL 6 CHAIN 1

HIGH CHANNEL 11

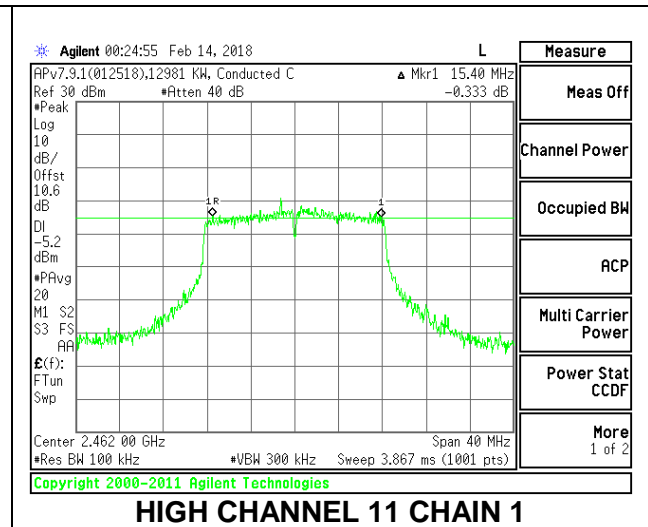
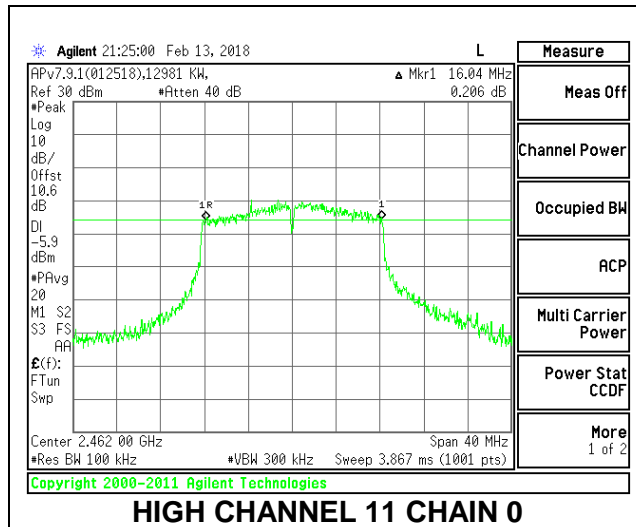

HIGH CHANNEL 12

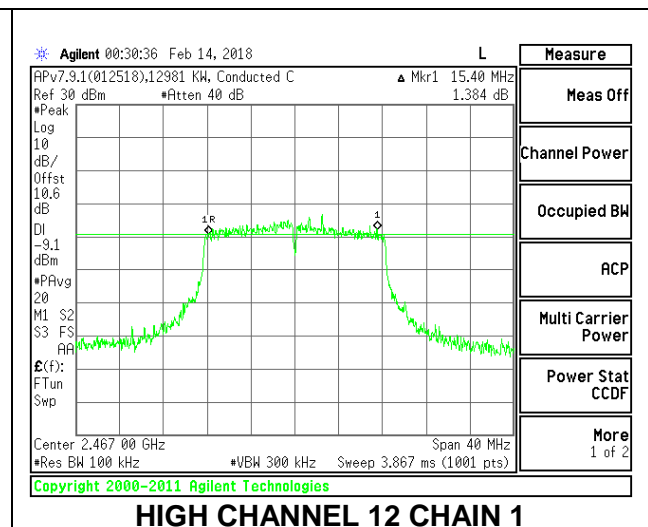
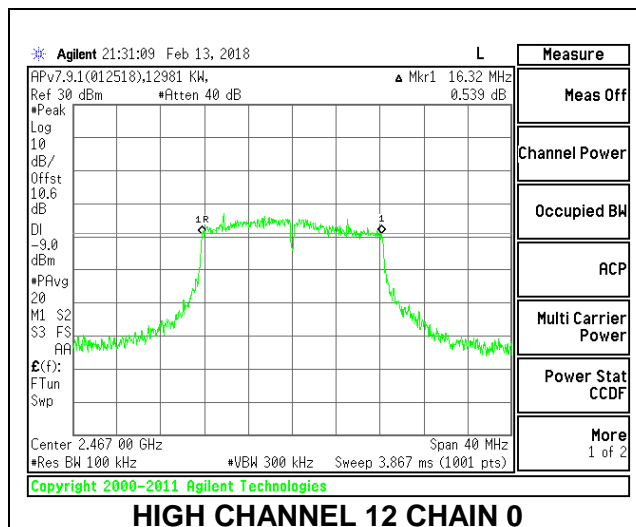

HIGH CHANNEL 13

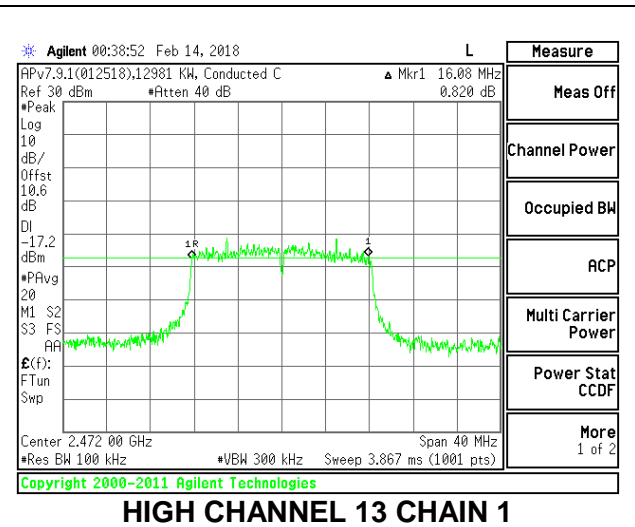
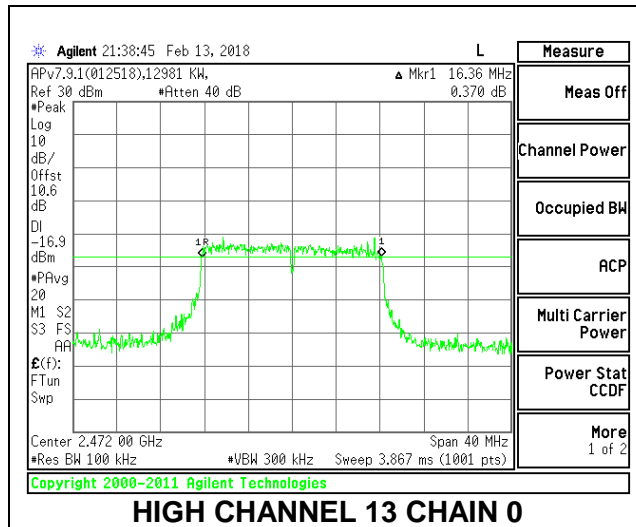

8.3.3. 802.11n HT20 MODE

Channel	Frequency (MHz)	6 dB BW Chain 0 (MHz)	6 dB BW Chain 1 (MHz)	Minimum Limit (MHz)
Low 1	2412	17.64	17.64	0.5
Mid 6	2437	16.60	16.72	0.5
High 11	2462	16.68	15.92	0.5
High 12	2467	17.08	16.88	0.5
High 13	2472	17.20	15.68	0.5

LOW CHANNEL 1

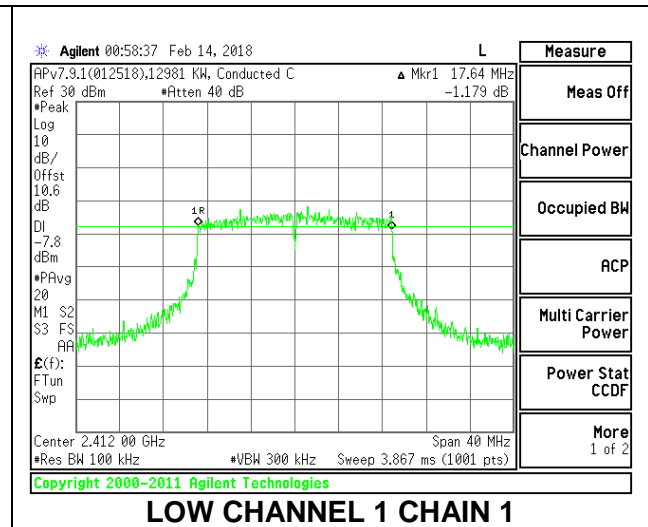
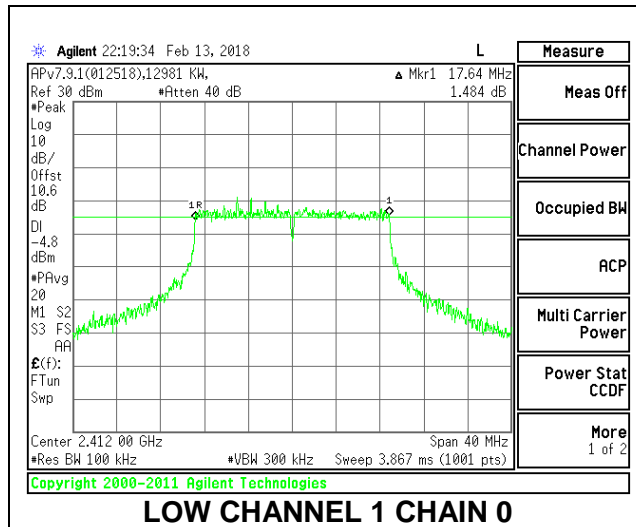

MID CHANNEL 6

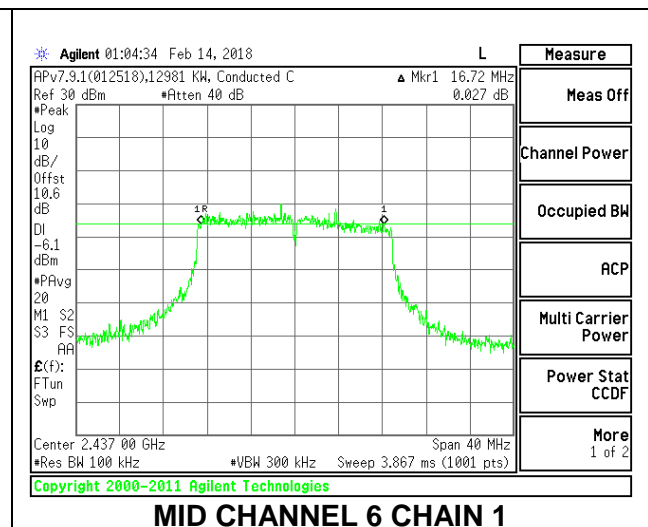
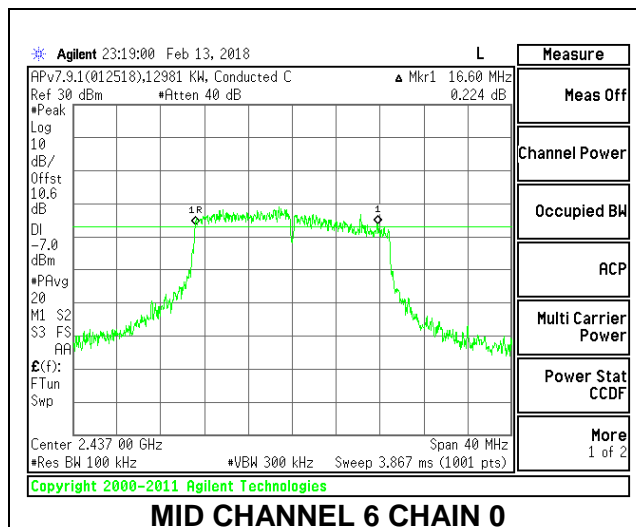

HIGH CHANNEL 11

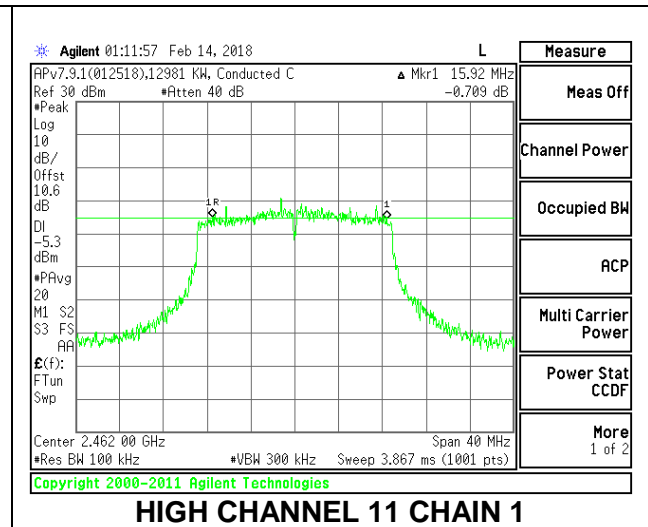
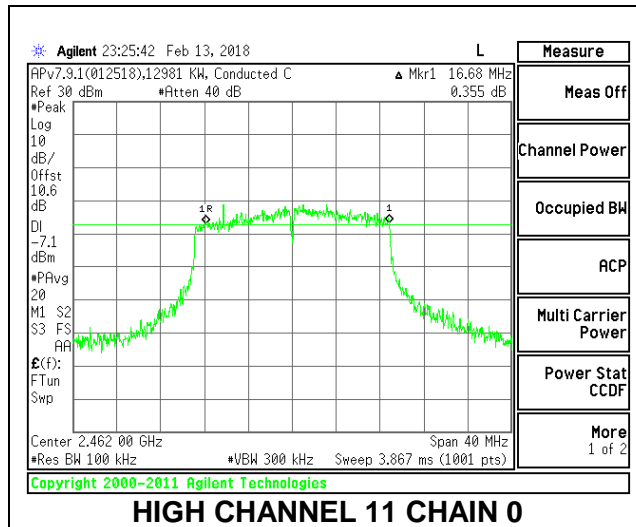

HIGH CHANNEL 12

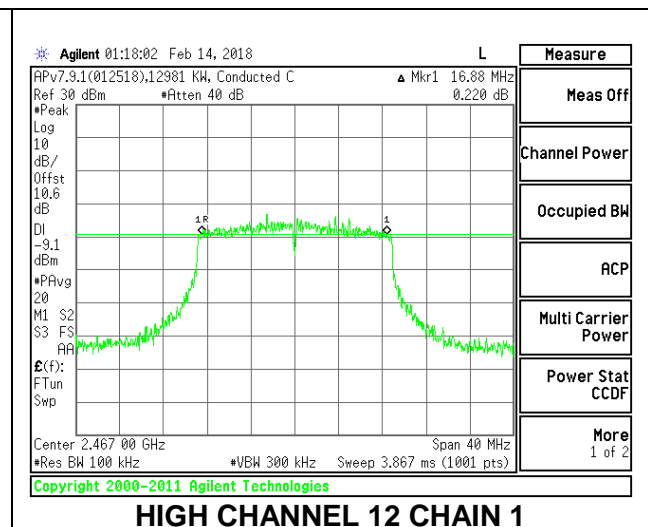
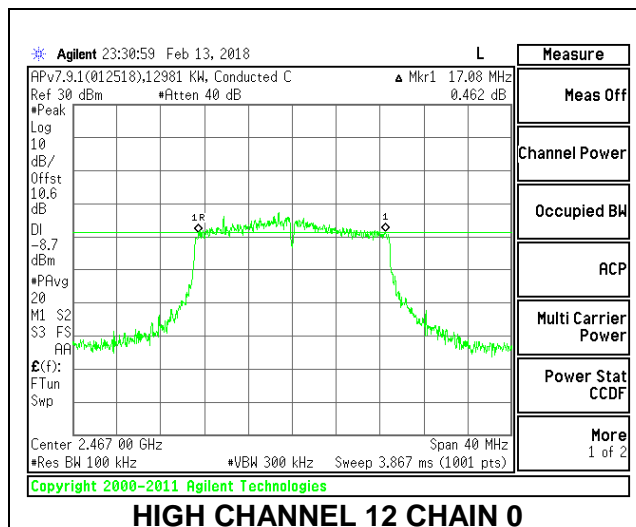

HIGH CHANNEL 13

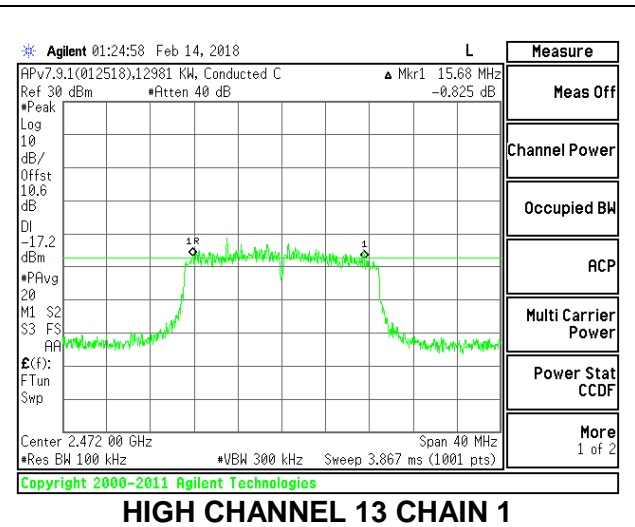
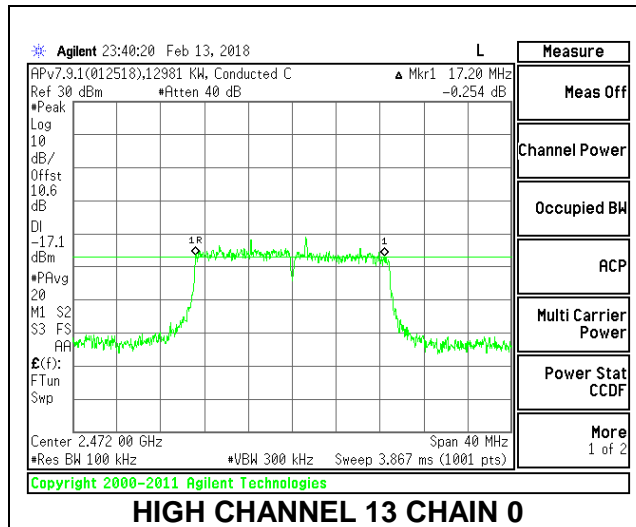

8.4. OUTPUT POWER

LIMITS

FCC §15.247 (b) (3)

For systems using digital modulation in the 902–928 MHz, 2400–2483.5 MHz, and 5725–5850 MHz bands: 1 Watt, based on the use of antennas with directional gains that do not exceed 6 dBi. If transmitting antennas of directional gain greater than 6 dBi are used, the conducted output power from the intentional radiator shall be reduced by the amount in dB that the directional gain of the antenna exceeds 6 dBi.

TEST PROCEDURE

The transmitter output is connected to a power meter. The cable assembly insertion loss was entered as an offset in the power meter to allow for a gated peak reading of power.

8.4.1. 802.11b MODE

The TX chains are uncorrelated and the antenna gain is unequal among the chains. The directional gain is:

Chain 0 Antenna Gain (dBi)	Chain 1 Antenna Gain (dBi)	Uncorrelated Chains Directional Gain (dBi)
-0.60	-8.40	-2.94

RESULTS

ID:	JM12056	Date:	02/14/18
------------	---------	--------------	----------

Limits

Channel	Frequency (MHz)	Directional Gain (dBi)	FCC Power Limit (dBm)	IC Power Limit (dBm)	IC EIRP Limit (dBm)	Max Power (dBm)
CH1	2412	-2.94	30.00	30	36	30.00
CH6	2437	-2.94	30.00	30	36	30.00
CH11	2462	-2.94	30.00	30	36	30.00
CH12	2467	-2.94	30.00	30	36	30.00
CH13	2472	-2.94	30.00	30	36	30.00

Results

Channel	Frequency (MHz)	Chain 0 Meas Power (dBm)	Chain 1 Meas Power (dBm)	Total Corr'd Power (dBm)	Power Limit (dBm)	Margin (dB)
CH1	2412	12.10	11.87	15.00	30.00	-15.00
CH6	2437	12.23	11.23	14.77	30.00	-15.23
CH11	2462	12.28	11.56	14.95	30.00	-15.05
CH12	2467	12.37	11.58	15.00	30.00	-15.00
CH13	2472	10.84	11.70	14.30	30.00	-15.70

Note: the power readings above were measured with gated method, and the measurement was taken only during the ON time. No duty cycle correction was necessary.

8.4.2. 802.11g MODE

The TX chains are uncorrelated and the antenna gain is unequal among the chains. The directional gain is:

Chain 0 Antenna Gain (dBi)	Chain 1 Antenna Gain (dBi)	Uncorrelated Chains Directional Gain (dBi)
-0.60	-8.40	-2.94

RESULTS

ID:	JM12056	Date:	02/14/18
------------	---------	--------------	----------

Limits

Channel	Frequency (MHz)	Directional Gain (dBi)	FCC Power Limit (dBm)	IC Power Limit (dBm)	IC EIRP Limit (dBm)	Max Power (dBm)
CH1	2412	-2.94	30.00	30	36	30.00
CH6	2437	-2.94	30.00	30	36	30.00
CH11	2462	-2.94	30.00	30	36	30.00
CH12	2467	-2.94	30.00	30	36	30.00
CH13	2472	-2.94	30.00	30	36	30.00

Results

Channel	Frequency (MHz)	Chain 0 Meas Power (dBm)	Chain 1 Meas Power (dBm)	Total Corr'd Power (dBm)	Power Limit (dBm)	Margin (dB)
CH1	2412	13.01	12.01	15.55	30.00	-14.45
CH6	2437	13.56	11.55	15.68	30.00	-14.32
CH11	2462	13.28	11.92	15.66	30.00	-14.34
CH12	2467	12.50	8.60	13.98	30.00	-16.02
CH13	2472	1.69	0.93	4.34	30.00	-25.66

Note: the power readings above were measured with gated method, and the measurement was taken only during the ON time. No duty cycle correction was necessary.

8.4.3. 802.11n HT20 MODE

The TX chains are uncorrelated and the antenna gain is unequal among the chains. The directional gain is:

Chain 0 Antenna Gain (dBi)	Chain 1 Antenna Gain (dBi)	Uncorrelated Chains Directional Gain (dBi)
-0.60	-8.40	-2.94

RESULTS

ID:	JM12056	Date:	02/14/18
------------	---------	--------------	----------

Limits

Channel	Frequency (MHz)	Directional Gain (dBi)	FCC Power Limit (dBm)	IC Power Limit (dBm)	IC EIRP Limit (dBm)	Max Power (dBm)
CH1	2412	-2.94	30.00	30	36	30.00
CH6	2437	-2.94	30.00	30	36	30.00
CH11	2462	-2.94	30.00	30	36	30.00
CH12	2467	-2.94	30.00	30	36	30.00
CH13	2472	-2.94	30.00	30	36	30.00

Results

Channel	Frequency (MHz)	Chain 0 Meas Power (dBm)	Chain 1 Meas Power (dBm)	Total Corr'd Power (dBm)	Power Limit (dBm)	Margin (dB)
CH1	2412	13.39	11.85	15.70	30.00	-14.30
CH6	2437	13.46	11.90	15.76	30.00	-14.24
CH11	2462	13.14	12.16	15.69	30.00	-14.31
CH12	2467	10.04	8.90	12.52	30.00	-17.48
CH13	2472	0.42	0.01	3.23	30.00	-26.77

Note: the power readings above were measured with gated method, and the measurement was taken only during the ON time. No duty cycle correction was necessary.

8.5. POWER SPECTRAL DENSITY

LIMITS

FCC §15.247 (e)

The power spectral density conducted from the transmitter to the antenna shall not be greater than 8 dBm in any 3 kHz band during any time interval of continuous transmission.

RESULTS

8.5.1. 802.11b MODE

Duty Cycle CF (dB)	0.00	Included in Calculations of Corr'd PSD
--------------------	------	--

PSD Results

Channel	Frequency (MHz)	Chain 0 Meas (dBm/ 3kHz)	Chain 1 Meas (dBm/ 3kHz)	Total Corr'd PSD (dBm/ 3kHz)	Limit (dBm/ 3kHz)	Margin (dB)
Low 1	2412	-9.65	-11.21	-7.35	8.0	-15.4
Mid 6	2437	-9.65	-11.18	-7.34	8.0	-15.3
High 11	2462	-8.85	-10.68	-6.66	8.0	-14.7
High 12	2467	-9.42	-10.91	-7.09	8.0	-15.1
High 13	2472	-10.30	-11.02	-7.63	8.0	-15.6

LOW CHANNEL 1

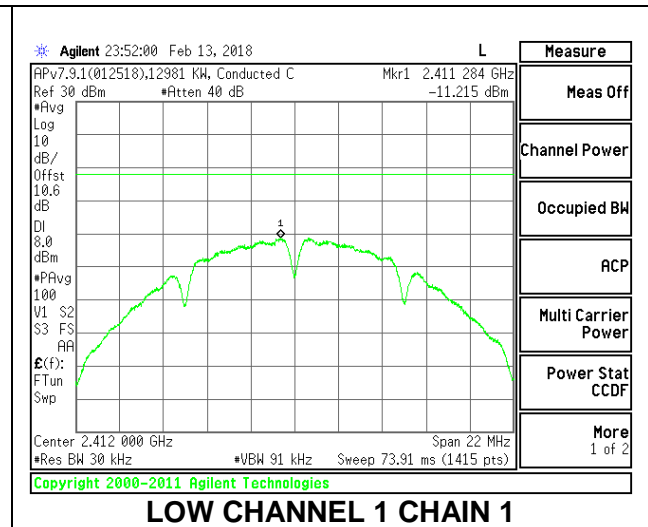
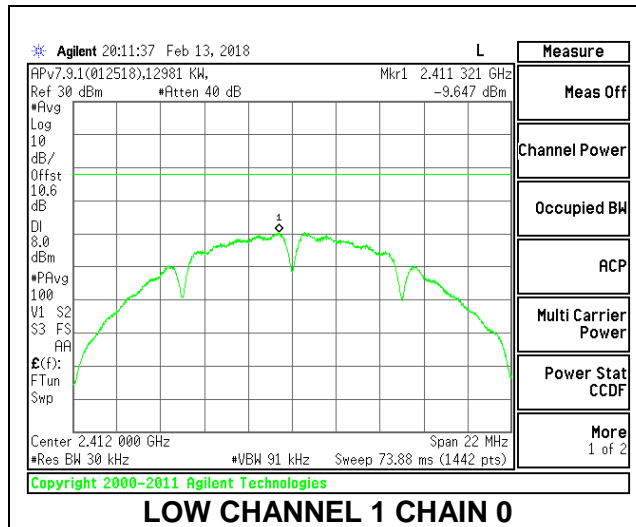

MID CHANNEL 6

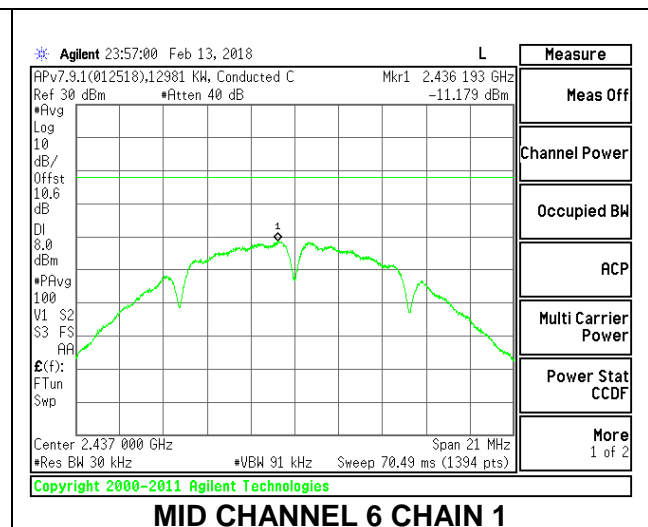
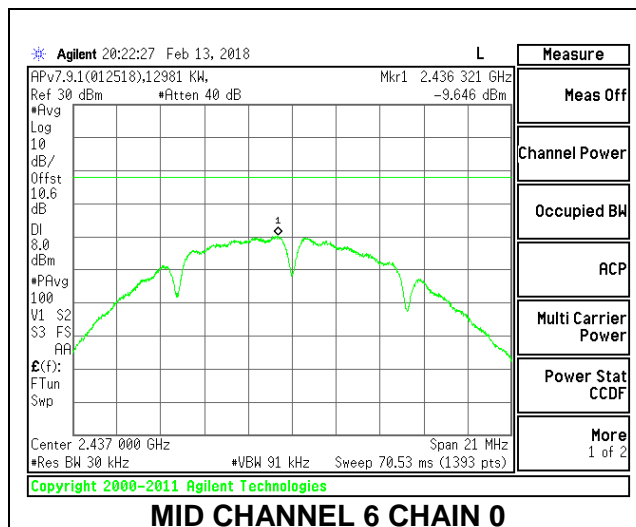

HIGH CHANNEL 11

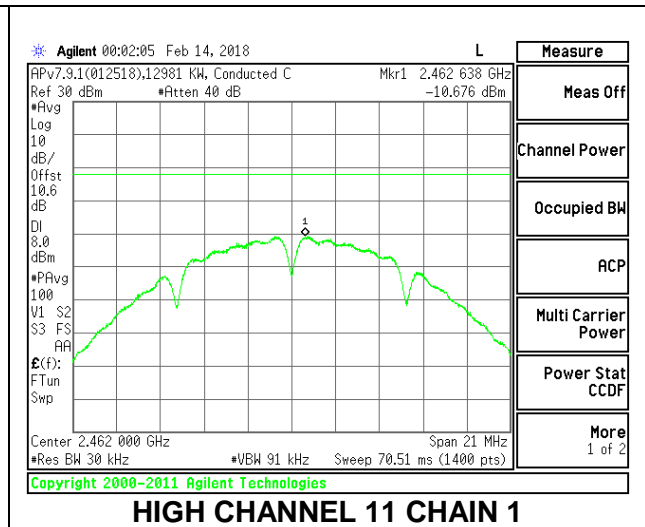
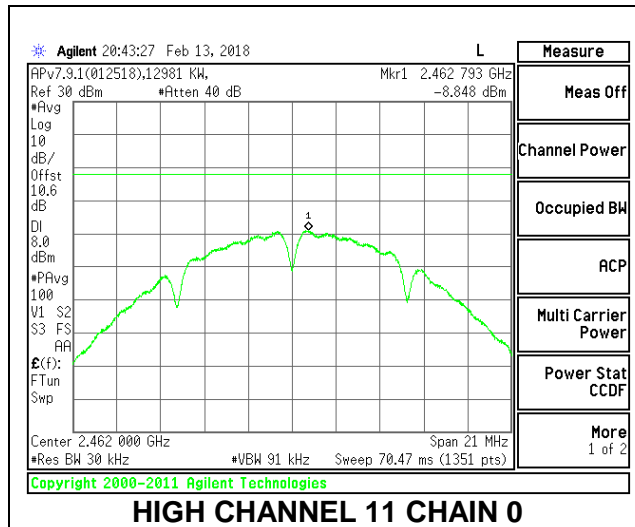

HIGH CHANNEL 12

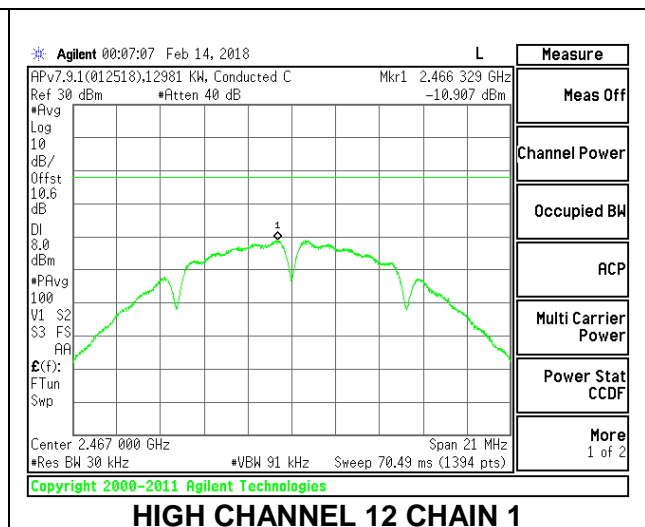
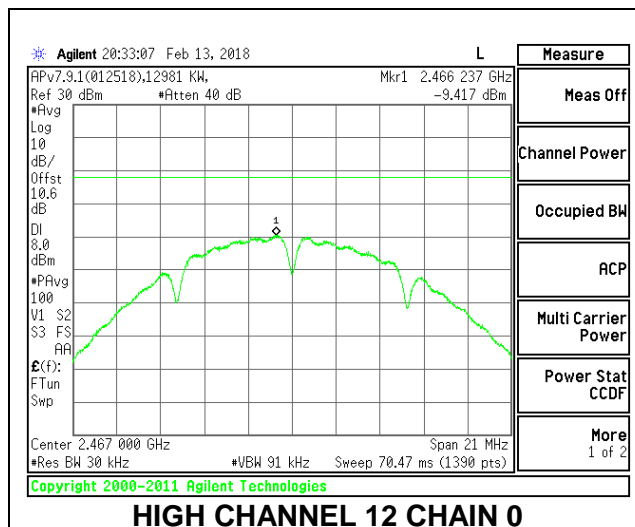

HIGH CHANNEL 13

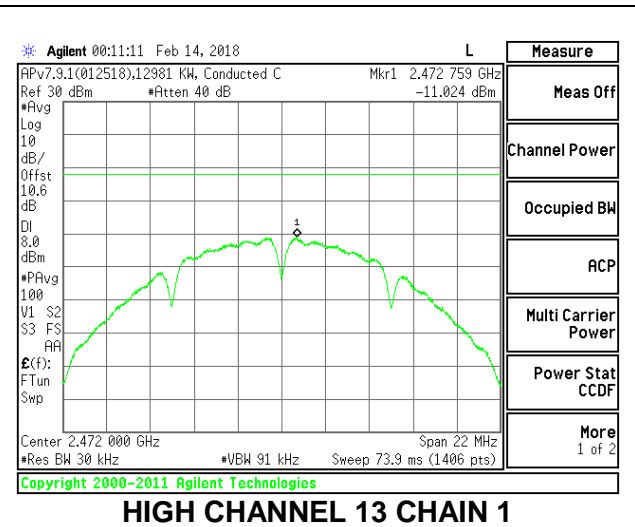
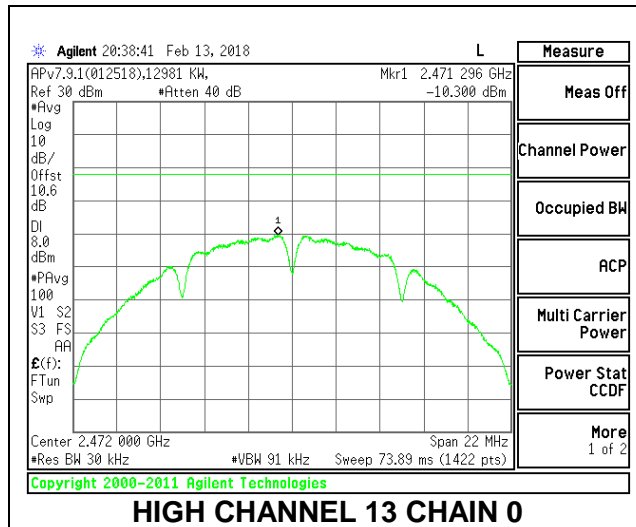

8.5.2. 802.11g MODE

Duty Cycle CF (dB)	0.00	Included in Calculations of Corr'd PSD
--------------------	------	--

PSD Results

Channel	Frequency (MHz)	Chain 0 Meas (dBm/ 3kHz)	Chain 1 Meas (dBm/ 3kHz)	Total Corr'd PSD (dBm/ 3kHz)	Limit (dBm/ 3kHz)	Margin (dB)
Low 1	2412	-11.80	-13.44	-9.53	8.0	-17.5
Mid 6	2437	-11.29	-13.43	-9.22	8.0	-17.2
High 11	2462	-10.69	-12.58	-8.52	8.0	-16.5
High 12	2467	-14.37	-15.59	-11.93	8.0	-19.9
High 13	2472	-22.82	-24.34	-20.50	8.0	-28.5

LOW CHANNEL 1

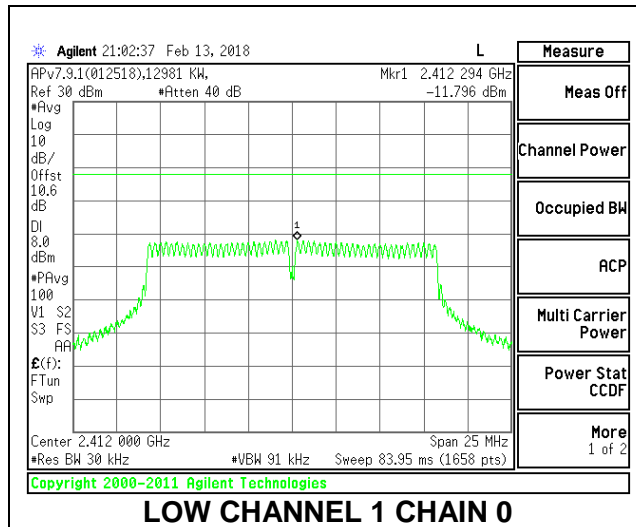

LOW CHANNEL 1 CHAIN 0

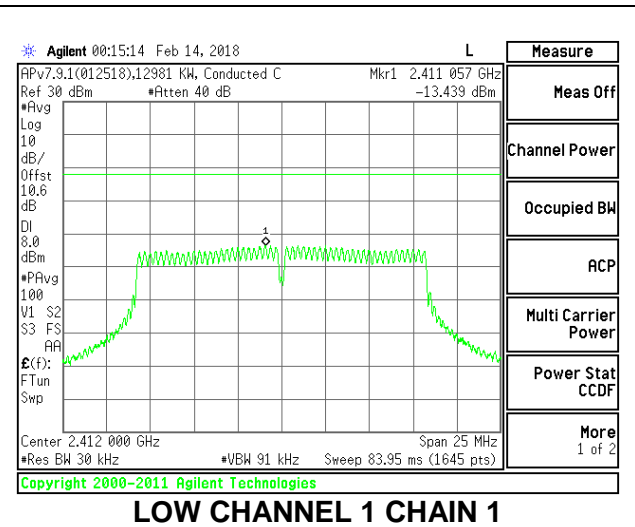

LOW CHANNEL 1 CHAIN 1

MID CHANNEL 6

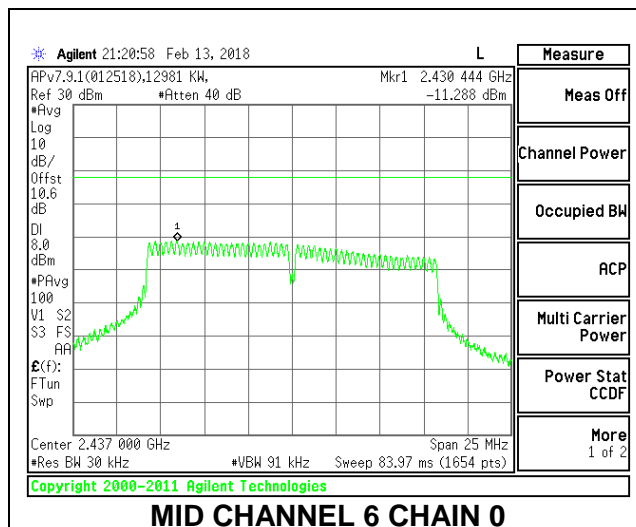

MID CHANNEL 6 CHAIN 0

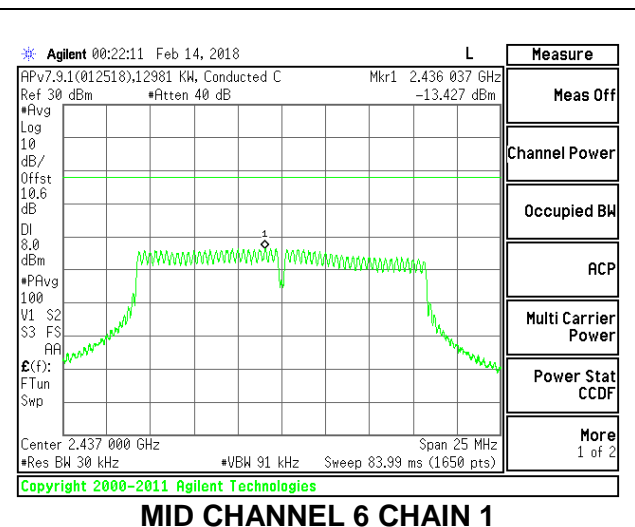

MID CHANNEL 6 CHAIN 1

HIGH CHANNEL 11

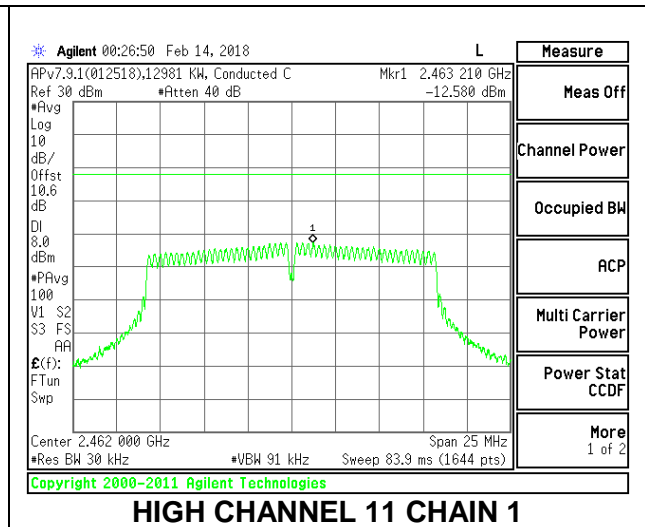
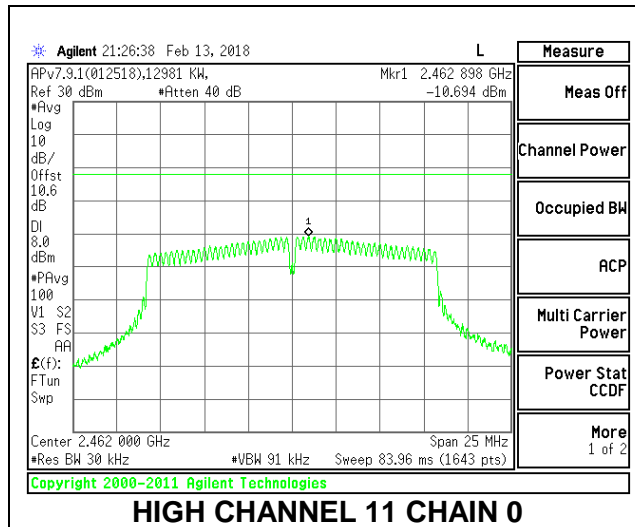

HIGH CHANNEL 12

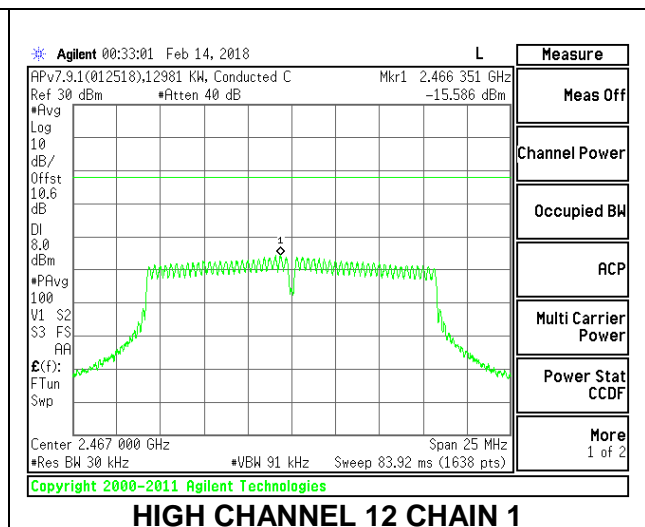
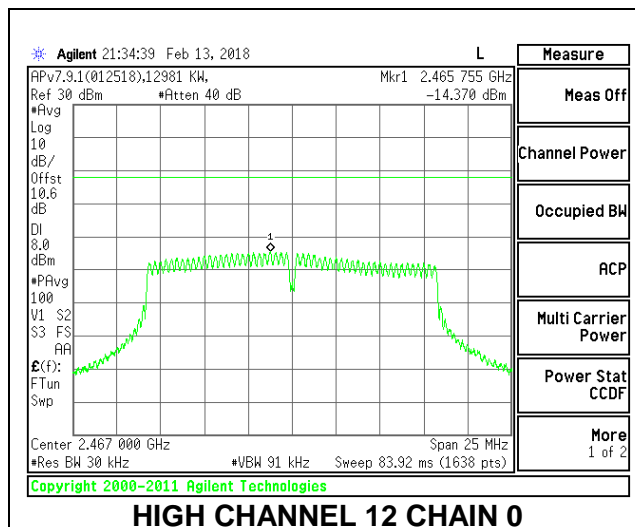

HIGH CHANNEL 13

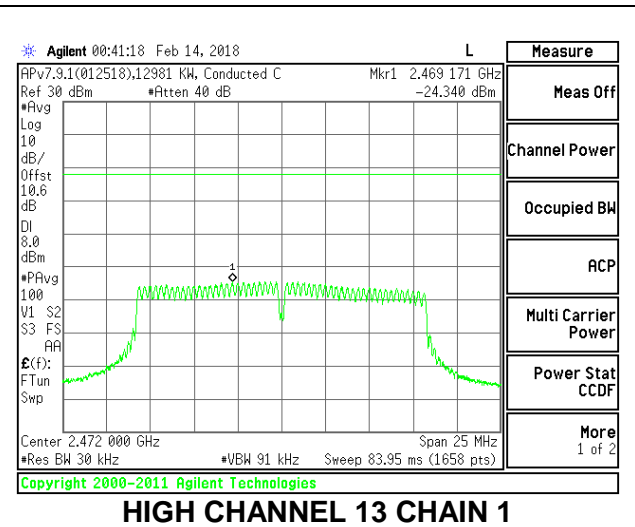
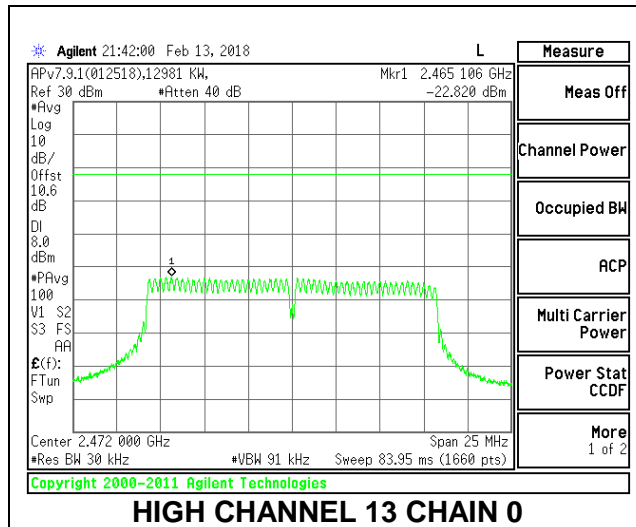

8.5.3. 802.11n HT20 MODE

Duty Cycle CF (dB)	0.10	Included in Calculations of Corr'd PSD
---------------------------	------	---

PSD Results

Channel	Frequency (MHz)	Chain 0 Meas (dBm/ 3kHz)	Chain 1 Meas (dBm/ 3kHz)	Total Corr'd PSD (dBm/ 3kHz)	Limit (dBm/ 3kHz)	Margin (dB)
Low 1	2412	-12.38	-13.70	-9.88	8.0	-17.9
Mid 6	2437	-12.24	-13.78	-9.83	8.0	-17.8
High 11	2462	-11.97	-13.01	-9.35	8.0	-17.3
High 12	2467	-14.66	-15.77	-12.07	8.0	-20.1
High 13	2472	-25.17	-25.64	-22.29	8.0	-30.3

LOW CHANNEL 1

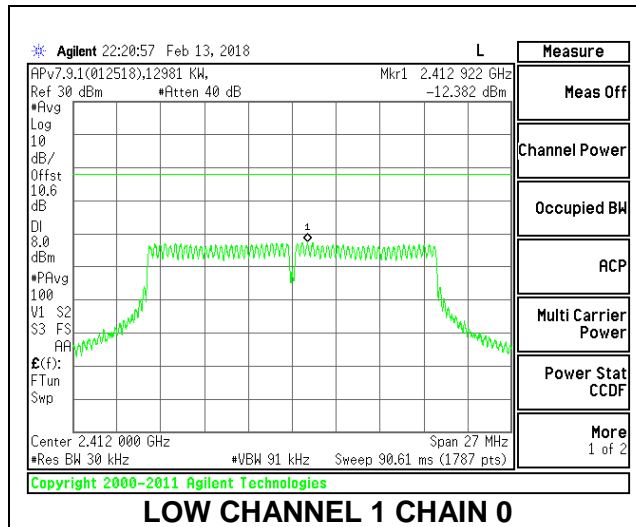

LOW CHANNEL 1 CHAIN 0

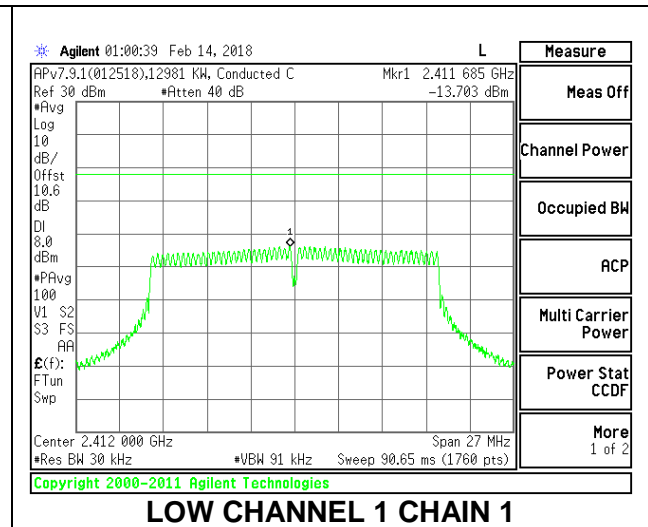

LOW CHANNEL 1 CHAIN 1

MID CHANNEL 6

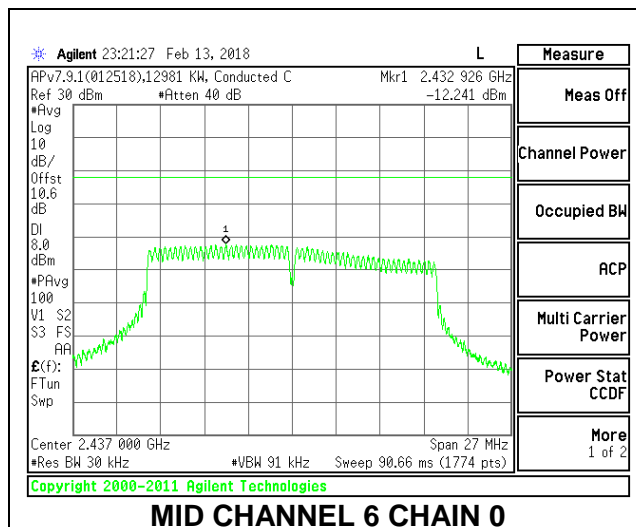

MID CHANNEL 6 CHAIN 0

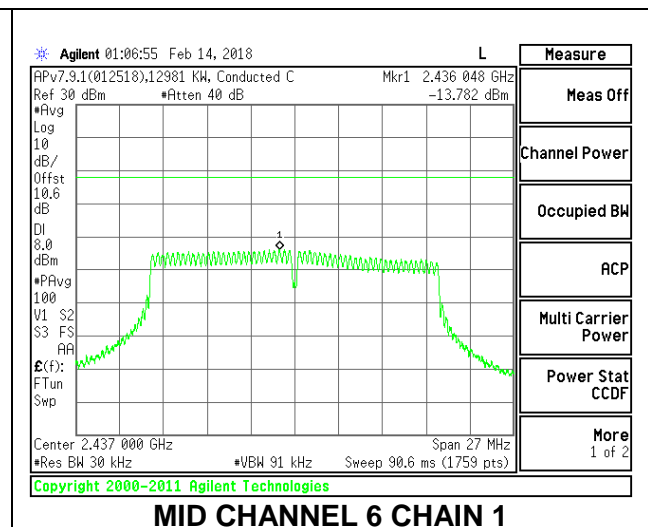

MID CHANNEL 6 CHAIN 1

HIGH CHANNEL 11

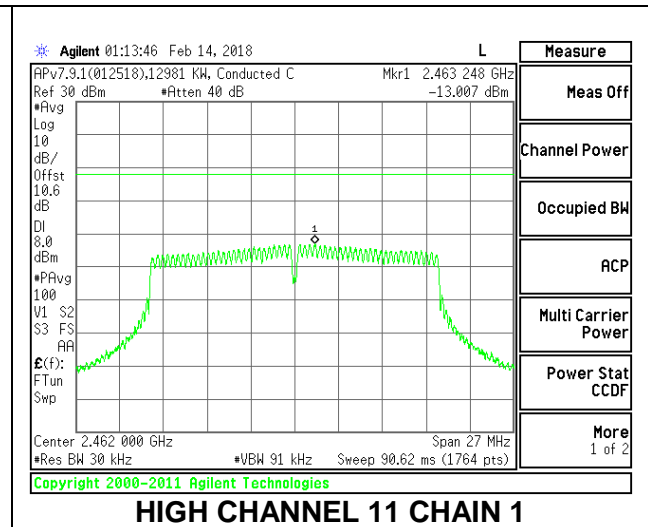
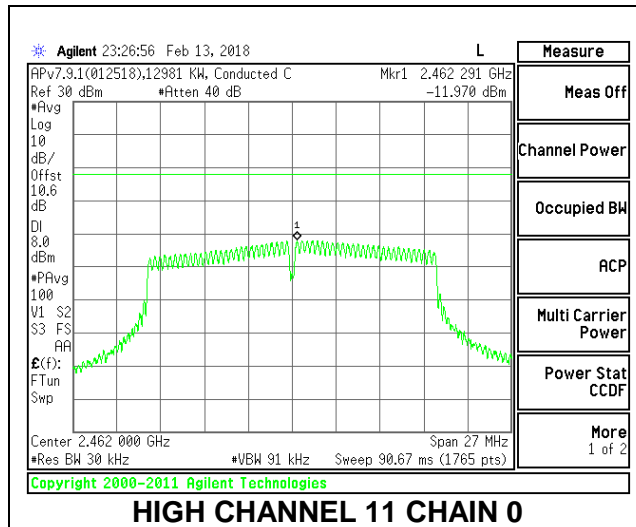

HIGH CHANNEL 12

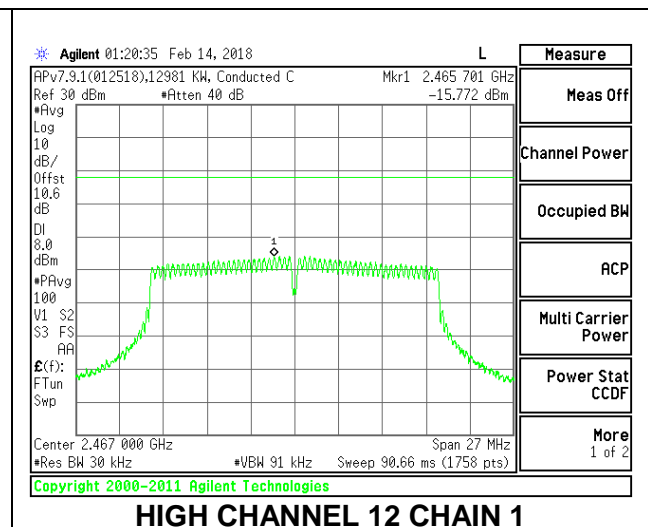
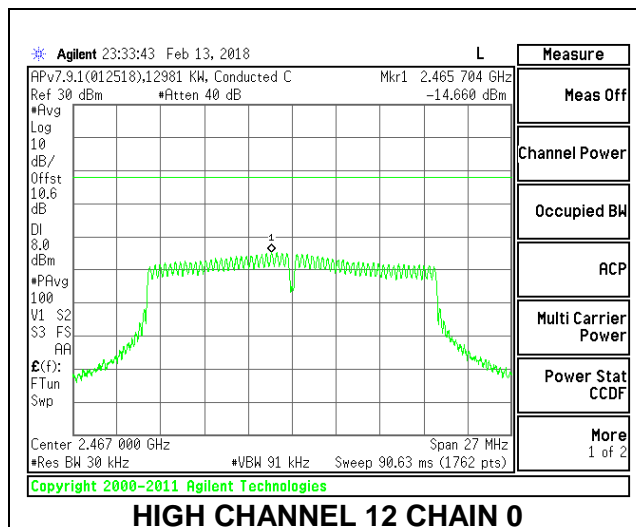

HIGH CHANNEL 13

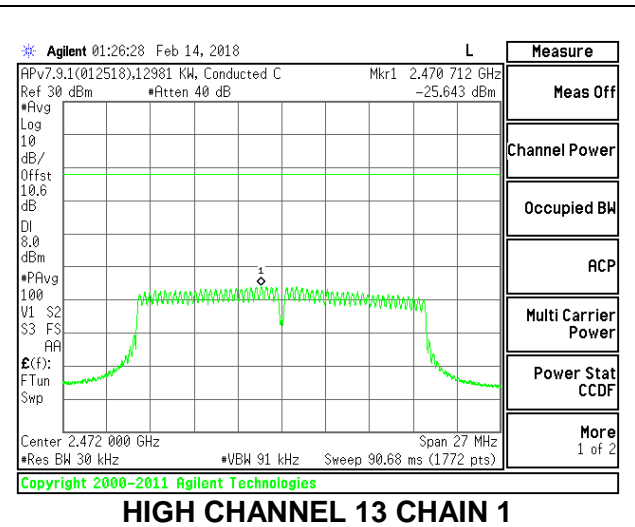
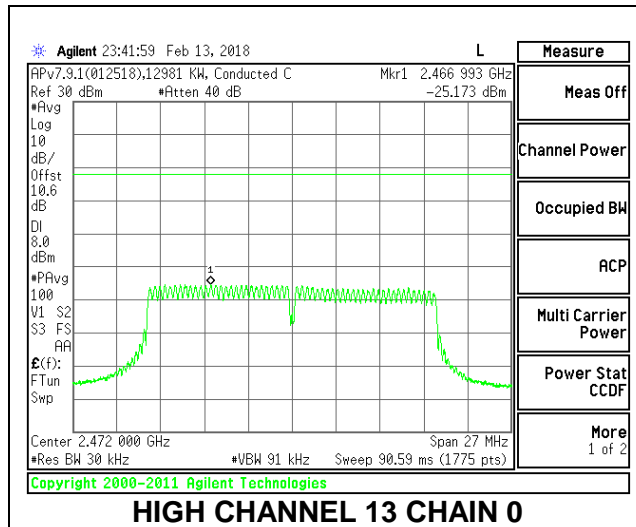

8.6. CONDUCTED SPURIOUS EMISSIONS

LIMITS

FCC §15.247 (d)

Output power was measured based on the use of Average measurement, therefore the required attenuation is 30 dB.

RESULTS

8.6.1. 802.11b MODE

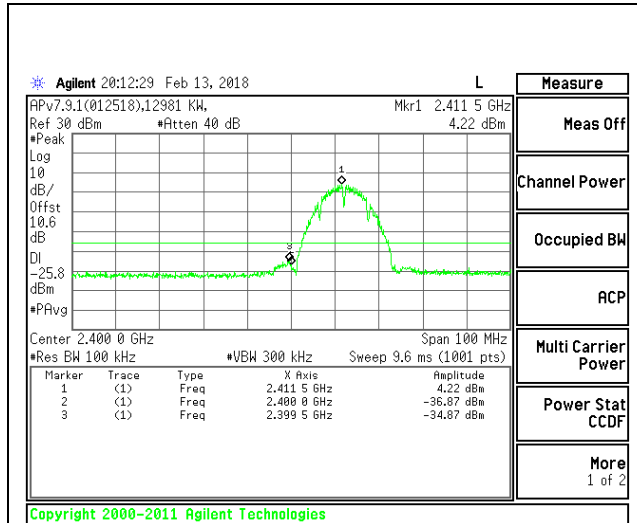

LOW CHANNEL 1 BANDEDGE CHAIN 0

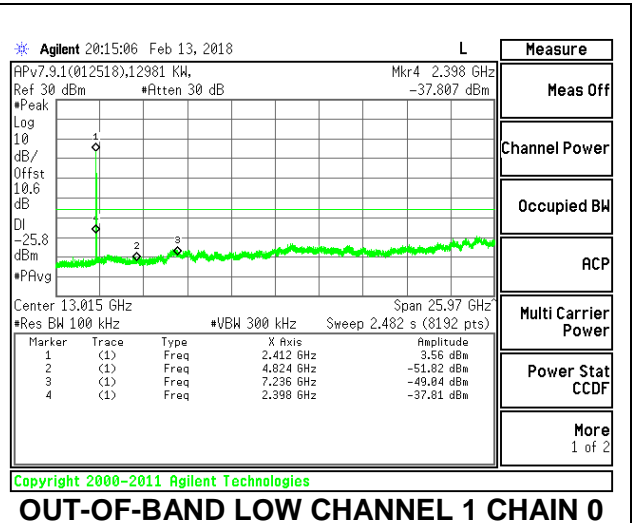

OUT-OF-BAND LOW CHANNEL 1 CHAIN 0

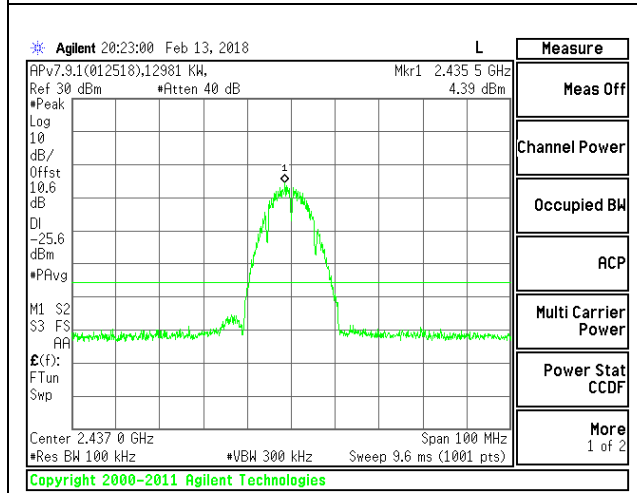

IN-BAND REFERENCE LEVEL CHAIN 0

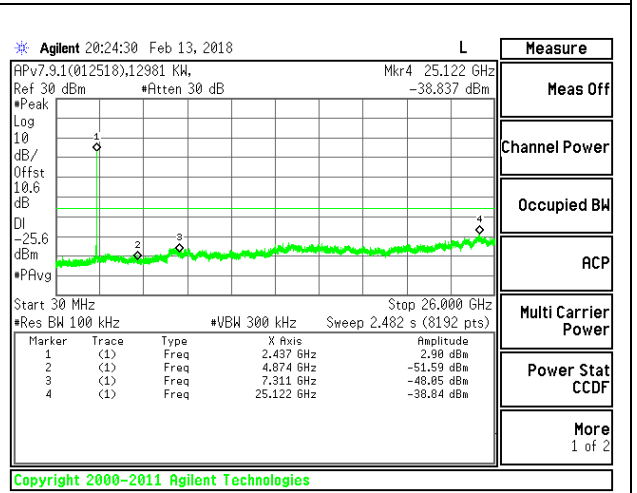

OUT-OF-BAND MID CHANNEL CHAIN 0

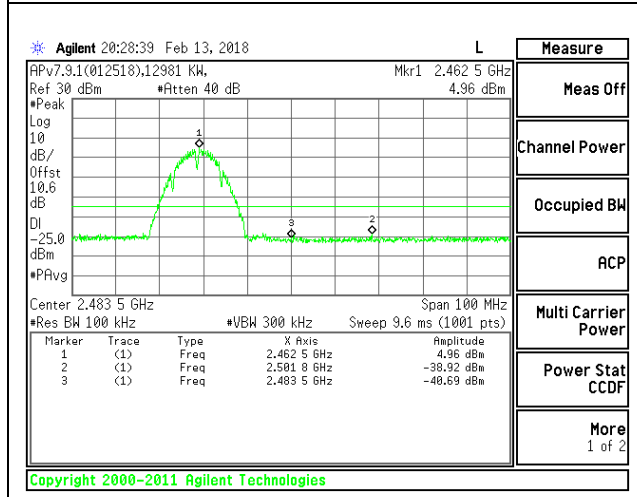

HIGH CHANNEL 11 BANDEDGE CHAIN 0

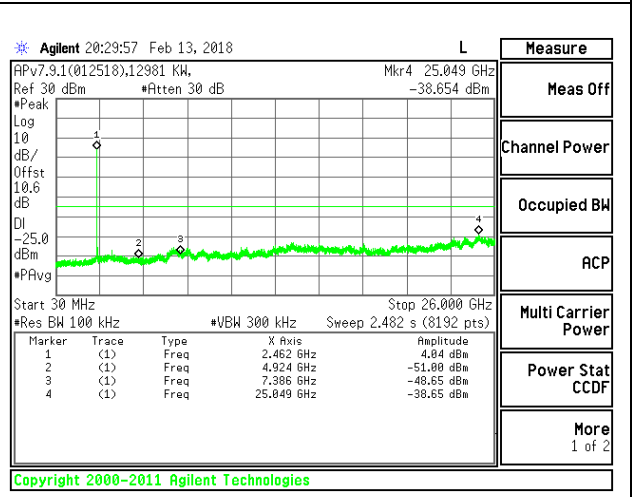

OUT-OF-BAND HIGH CHANNEL 11 CHAIN 0

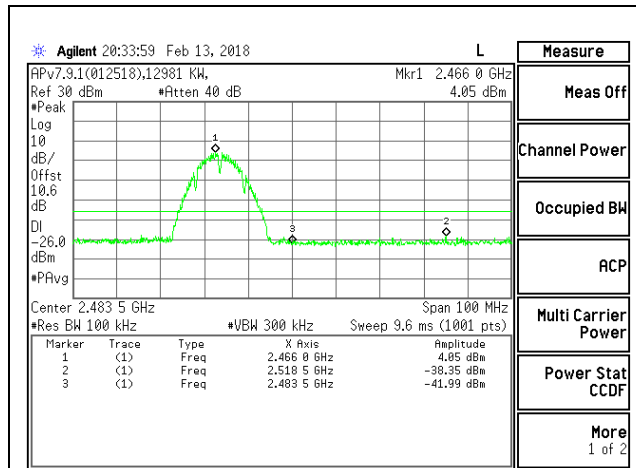

Copyright 2000-2011 Agilent Technologies

HIGH CHANNEL 12 BANDEDGE CHAIN 0

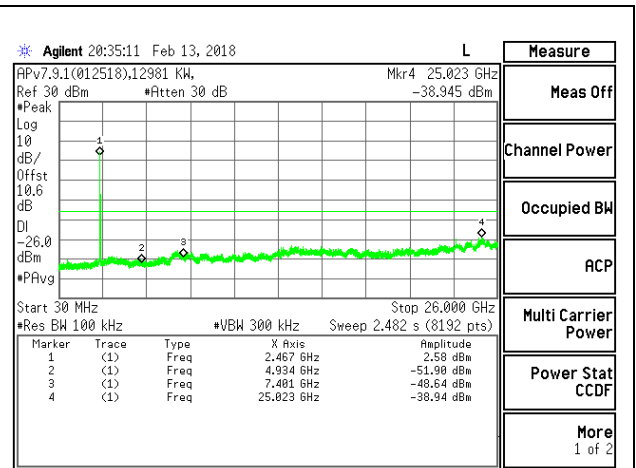

Copyright 2000-2011 Agilent Technologies

OUT-OF-BAND HIGH CHANNEL 12 CHAIN 0

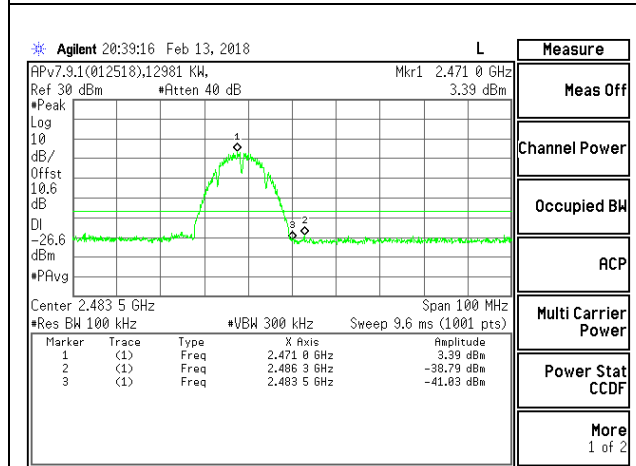

Copyright 2000-2011 Agilent Technologies

HIGH CHANNEL 13 BANDEDGE CHAIN 0

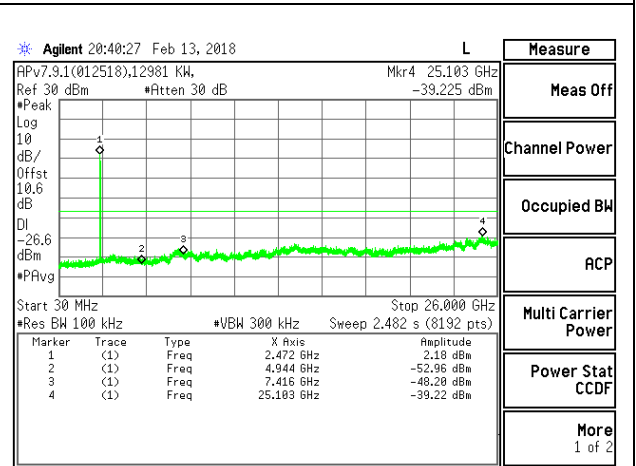

Copyright 2000-2011 Agilent Technologies

OUT-OF-BAND HIGH CHANNEL 13 CHAIN 0

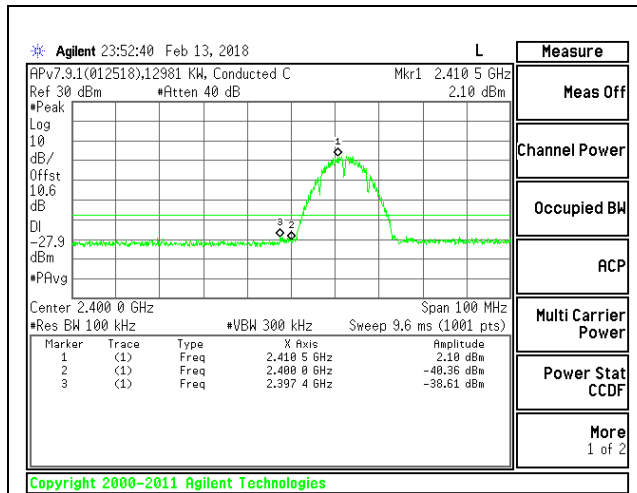

LOW CHANNEL 1 BANDEDGE CHAIN 1

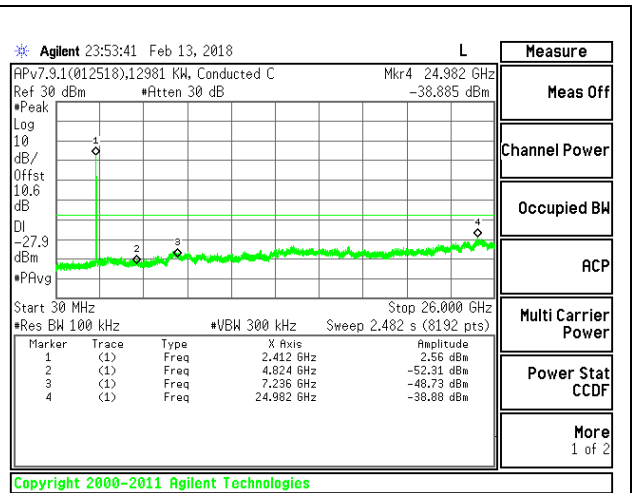

OUT-OF-BAND LOW CHANNEL 1 CHAIN 1

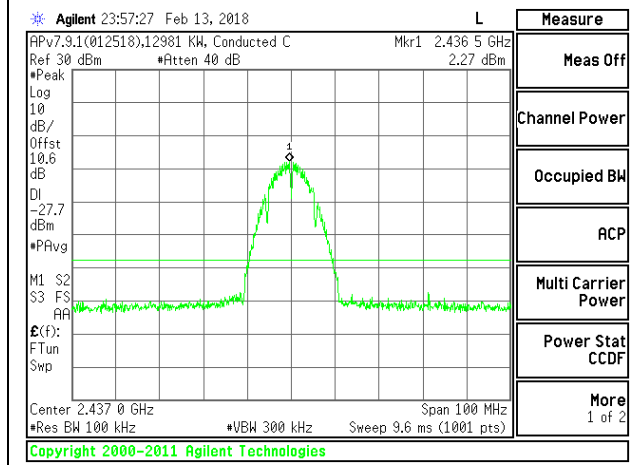

IN-BAND REFERENCE LEVEL CHAIN 1

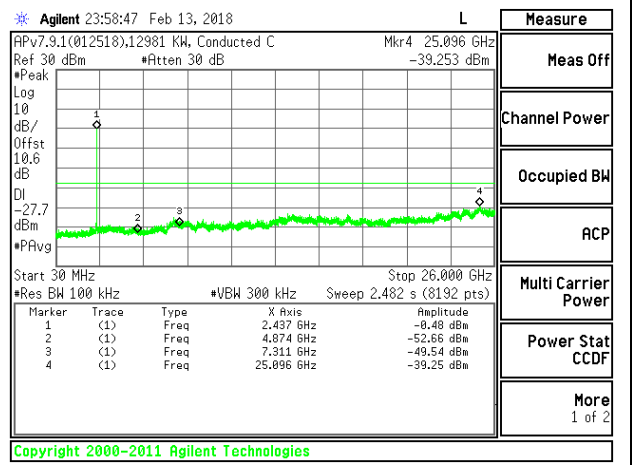

OUT-OF-BAND MID CHANNEL CHAIN 1

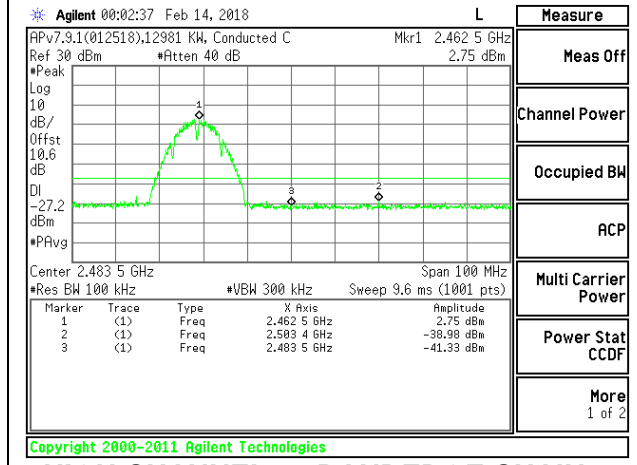

HIGH CHANNEL 11 BANDEDGE CHAIN 1

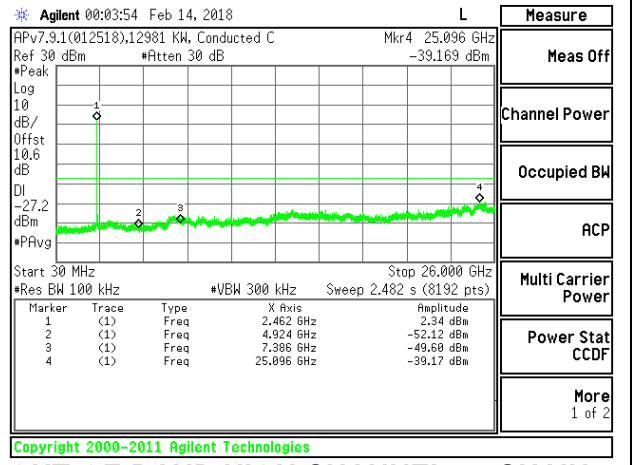

OUT-OF-BAND HIGH CHANNEL 11 CHAIN 1

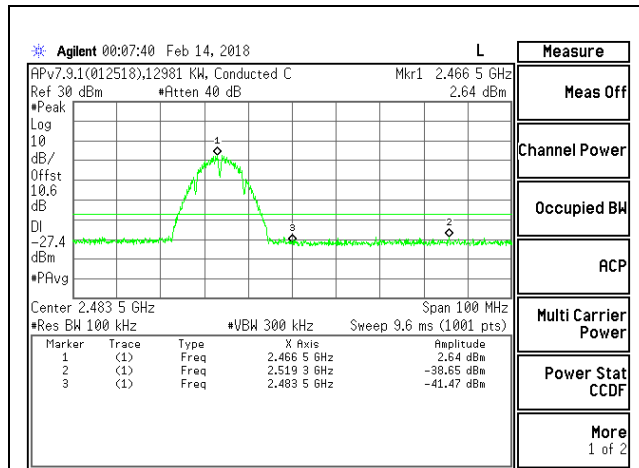

HIGH CHANNEL 12 BANDEDGE CHAIN 1

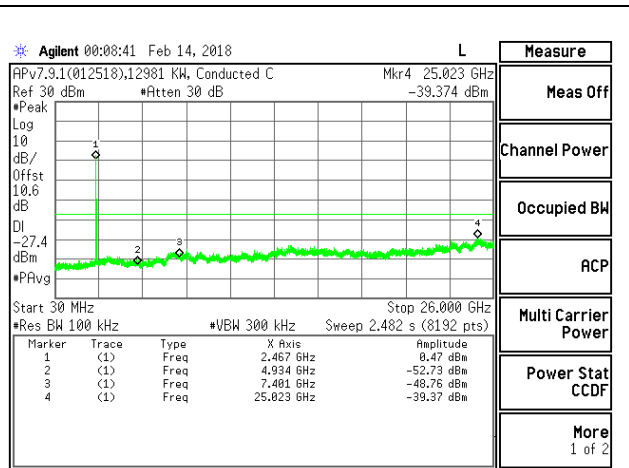

OUT-OF-BAND HIGH CHANNEL 12 CHAIN 1

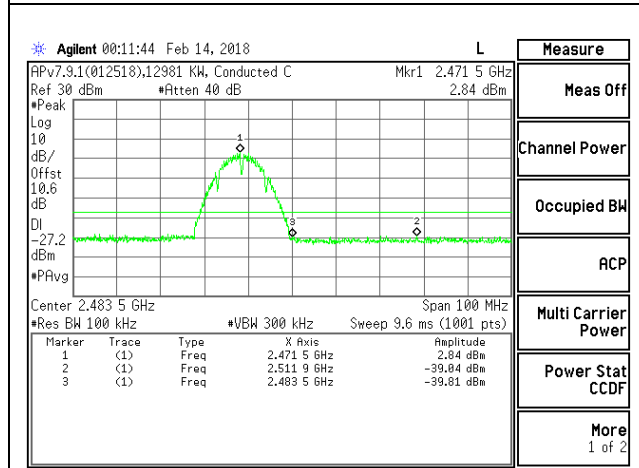

HIGH CHANNEL 13 BANDEDGE CHAIN 1

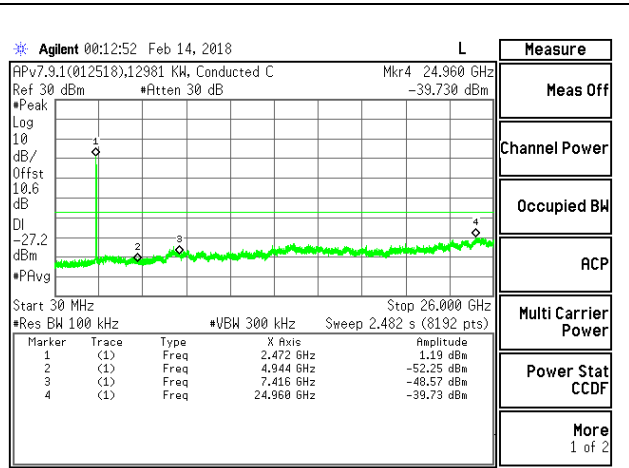

OUT-OF-BAND HIGH CHANNEL 13 CHAIN 1

8.6.2. 802.11g MODE

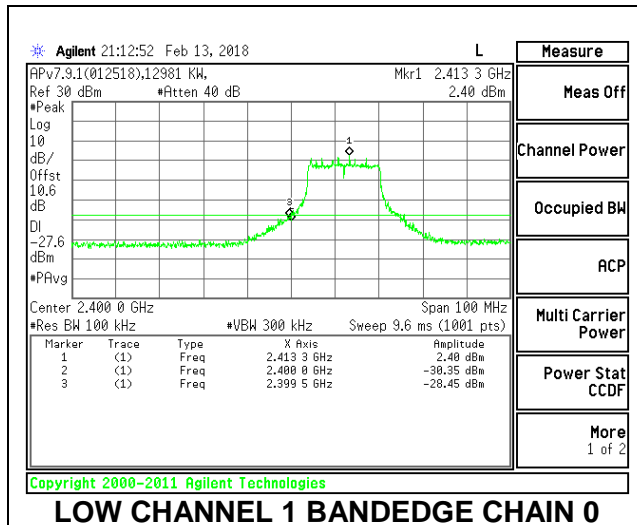

LOW CHANNEL 1 BANDEDGE CHAIN 0

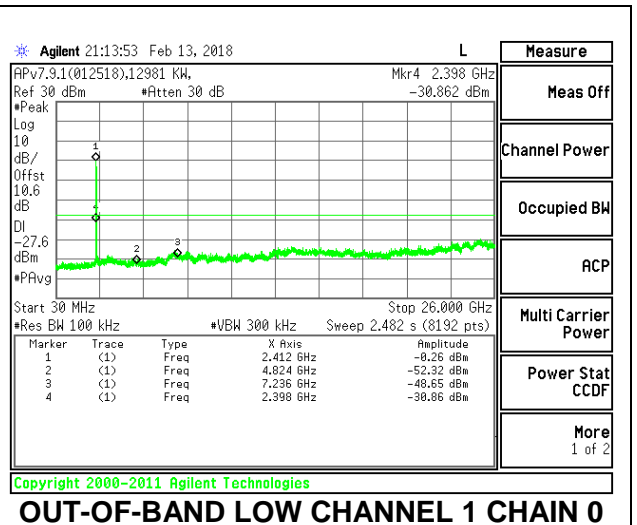

OUT-OF-BAND LOW CHANNEL 1 CHAIN 0

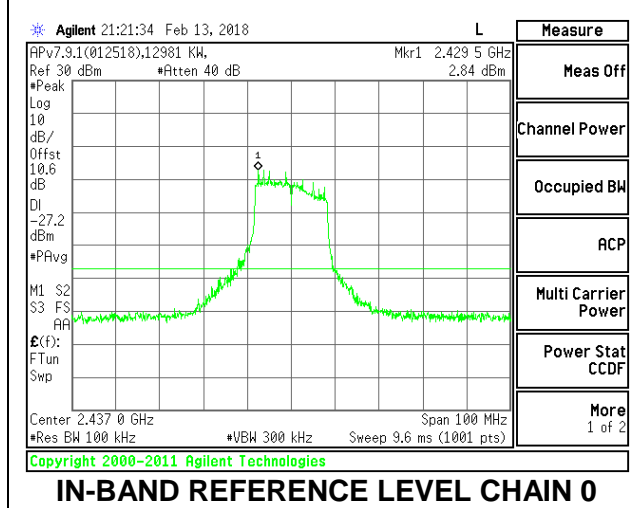

IN-BAND REFERENCE LEVEL CHAIN 0

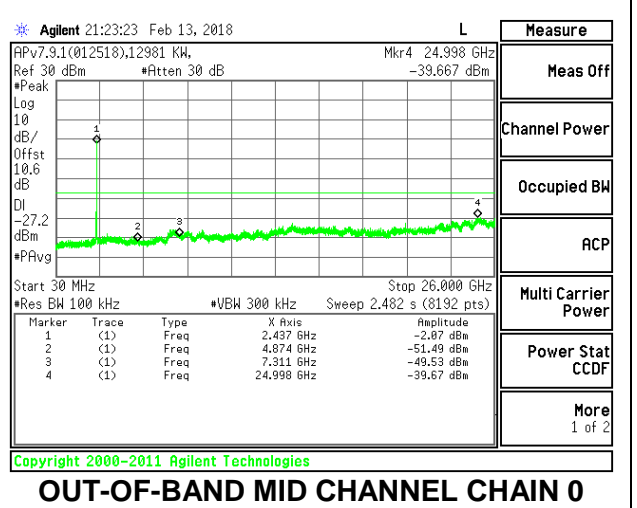

OUT-OF-BAND MID CHANNEL CHAIN 0

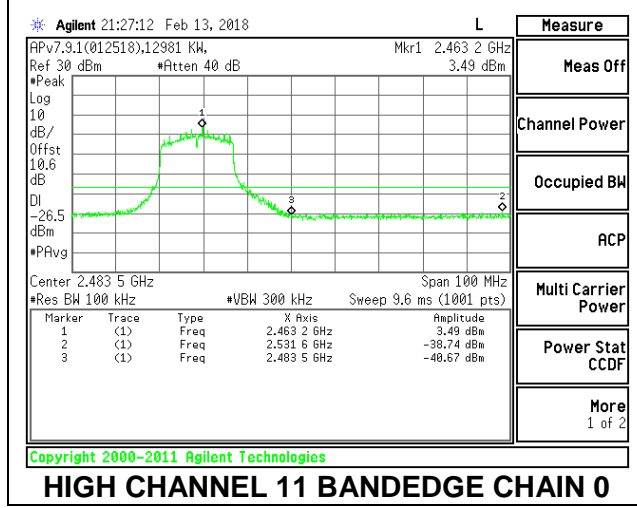

HIGH CHANNEL 11 BANDEDGE CHAIN 0

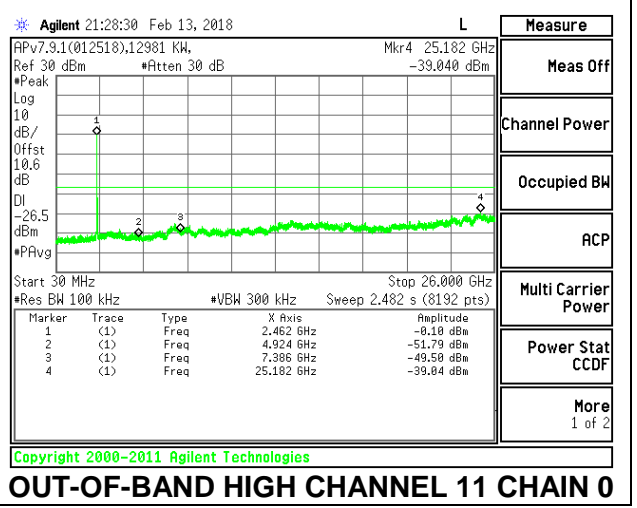

OUT-OF-BAND HIGH CHANNEL 11 CHAIN 0

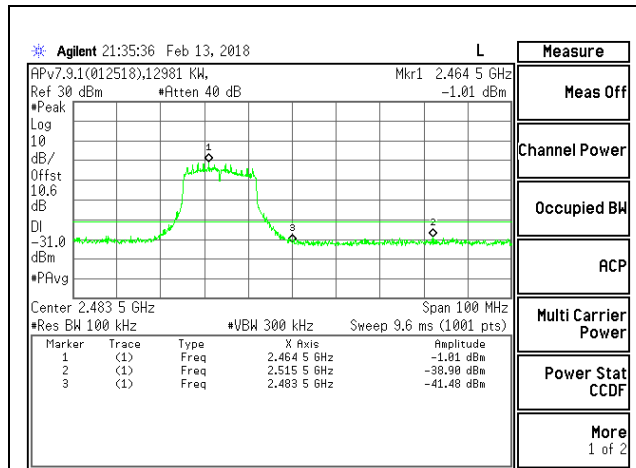

HIGH CHANNEL 12 BANDEDGE CHAIN 0

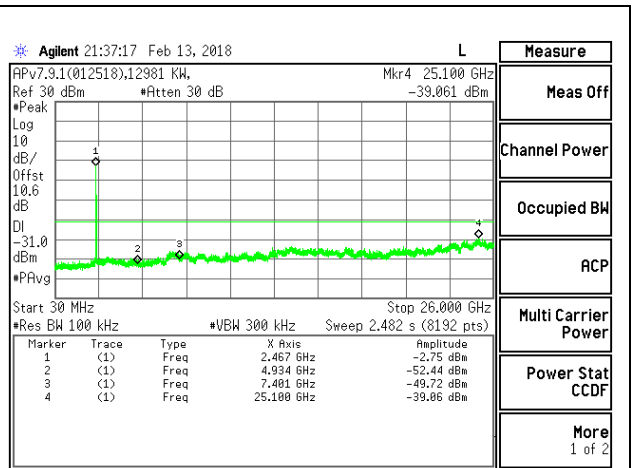

OUT-OF-BAND HIGH CHANNEL 12 CHAIN 0

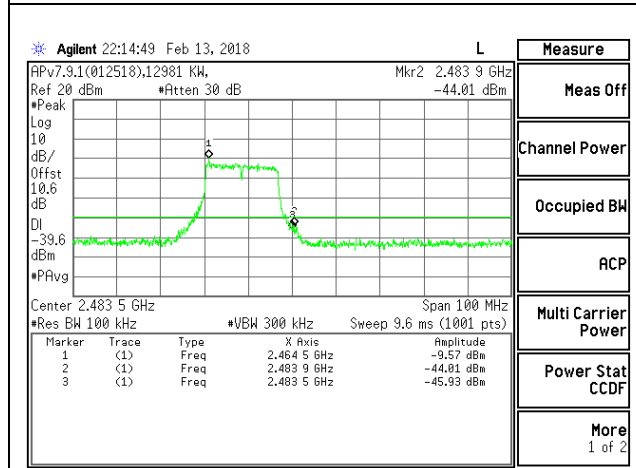

HIGH CHANNEL 13 BANDEDGE CHAIN 0

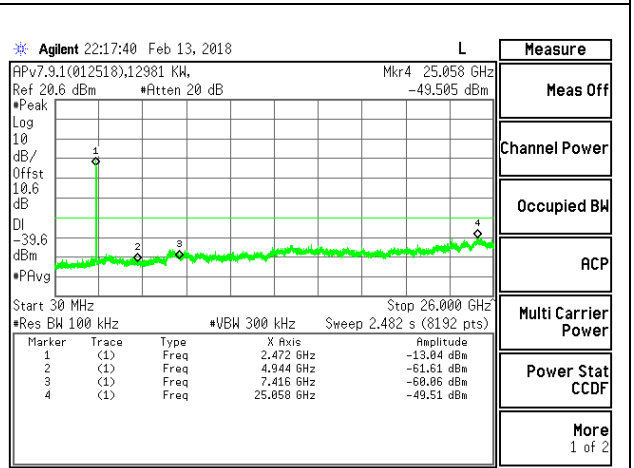

OUT-OF-BAND HIGH CHANNEL 13 CHAIN 0

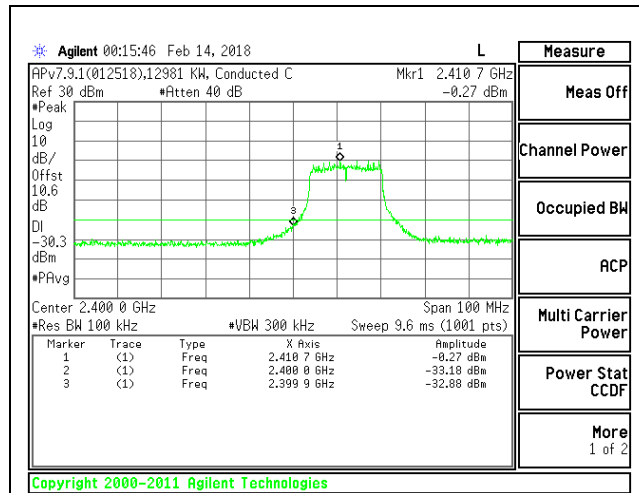

LOW CHANNEL 1 BANDEDGE CHAIN 1

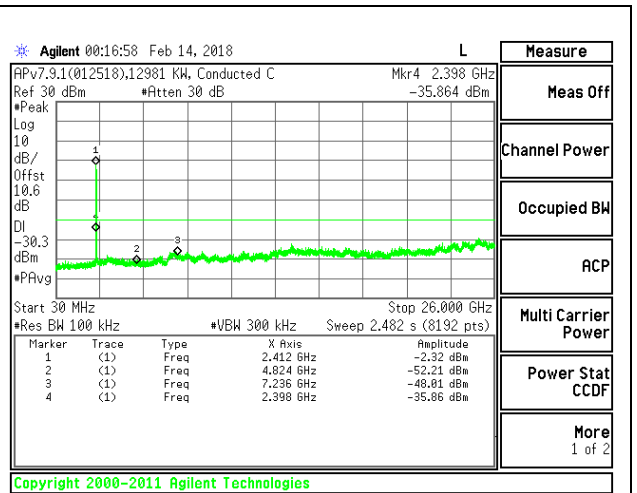

OUT-OF-BAND LOW CHANNEL 1 CHAIN 1

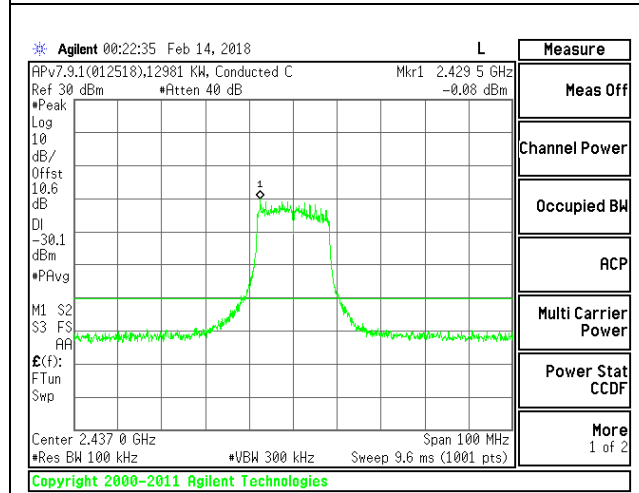

IN-BAND REFERENCE LEVEL CHAIN 1

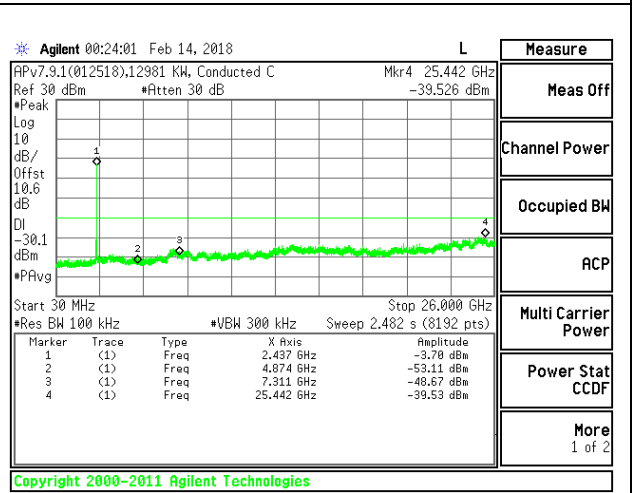

OUT-OF-BAND MID CHANNEL CHAIN 1

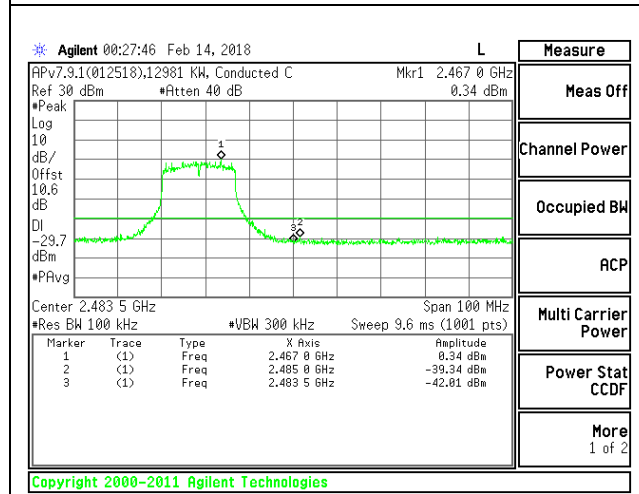

HIGH CHANNEL 11 BANDEDGE CHAIN 1

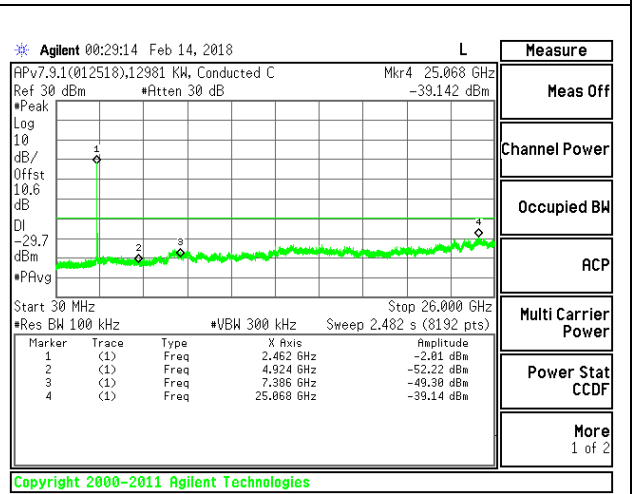

OUT-OF-BAND HIGH CHANNEL 11 CHAIN 1

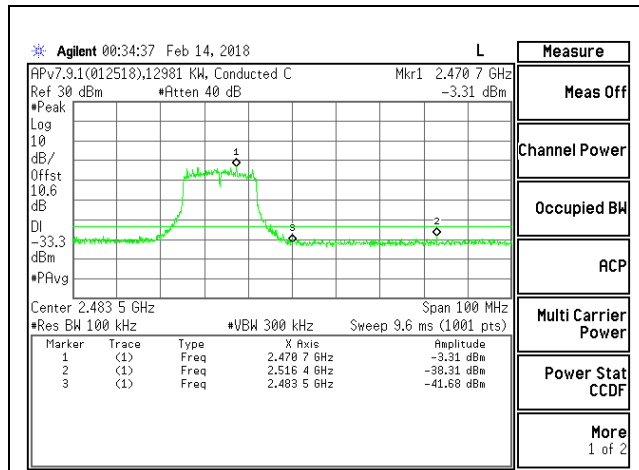

HIGH CHANNEL 12 BANDEDGE CHAIN 1

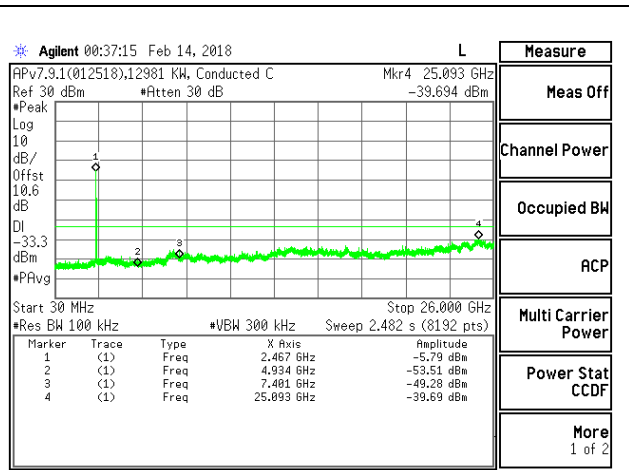

OUT-OF-BAND HIGH CHANNEL 12 CHAIN 1

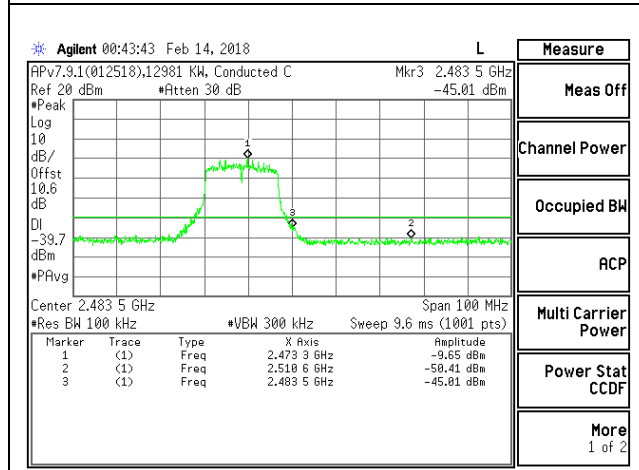

HIGH CHANNEL 13 BANDEDGE CHAIN 1

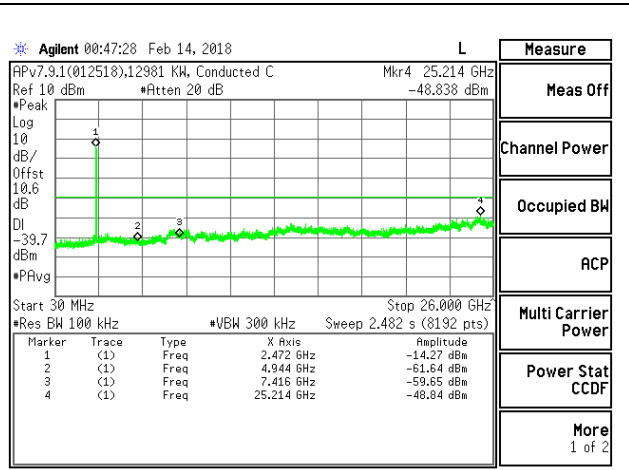

OUT-OF-BAND HIGH CHANNEL 13 CHAIN 1

8.6.3. 802.11n HT20 MODE

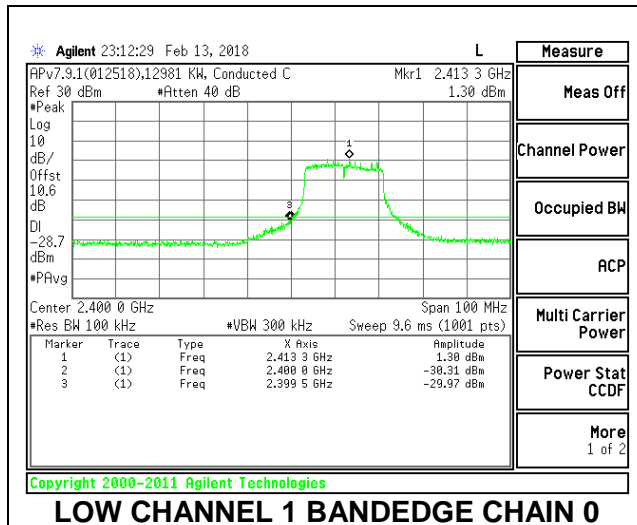

LOW CHANNEL 1 BANDEDGE CHAIN 0

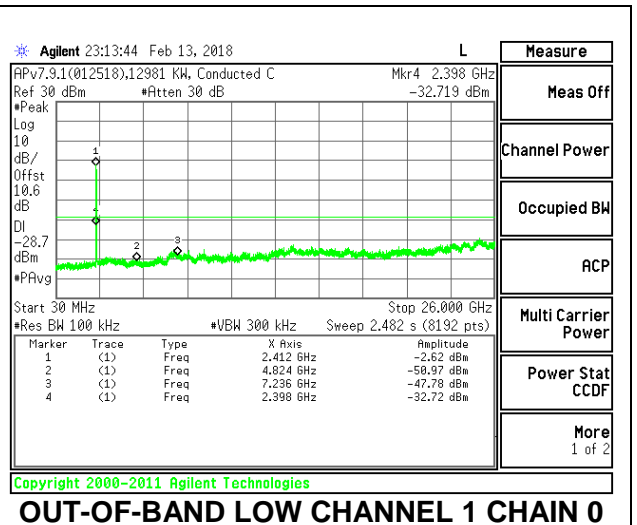

OUT-OF-BAND LOW CHANNEL 1 CHAIN 0

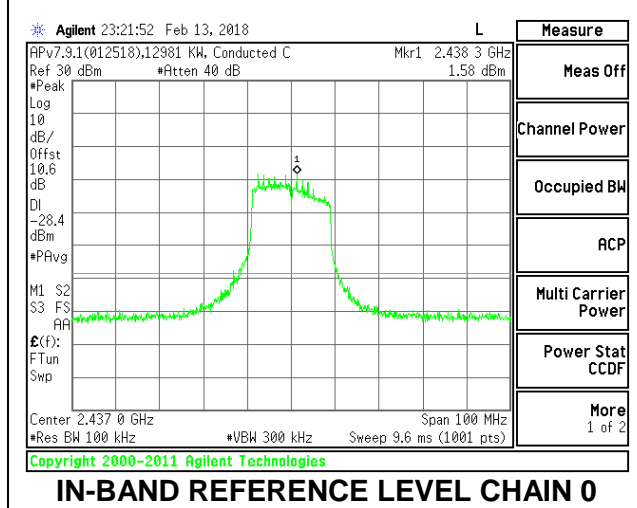

IN-BAND REFERENCE LEVEL CHAIN 0

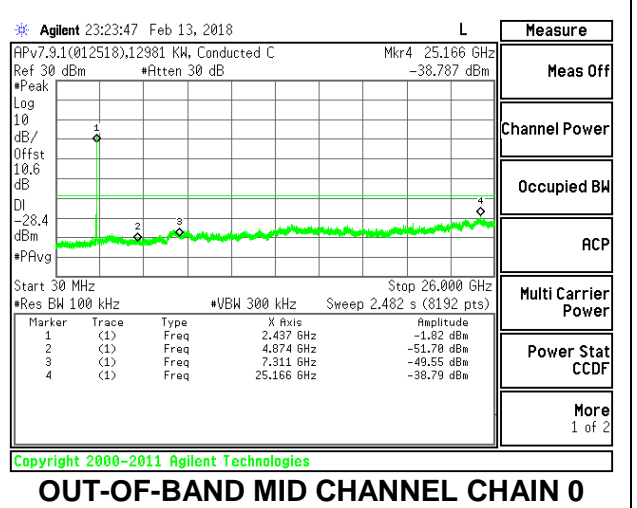

OUT-OF-BAND MID CHANNEL CHAIN 0

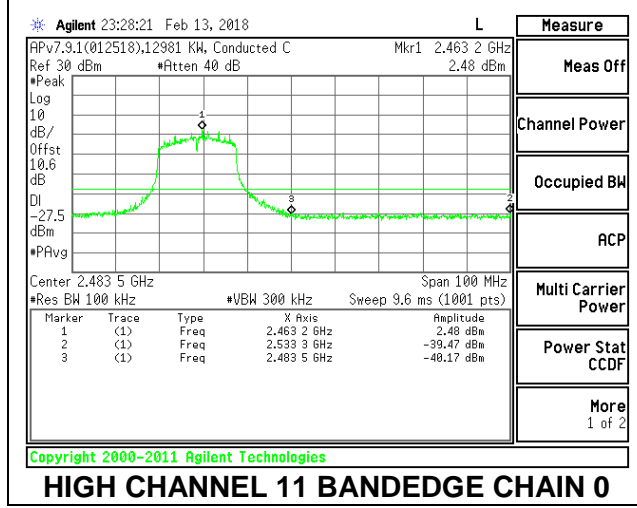

HIGH CHANNEL 11 BANDEDGE CHAIN 0

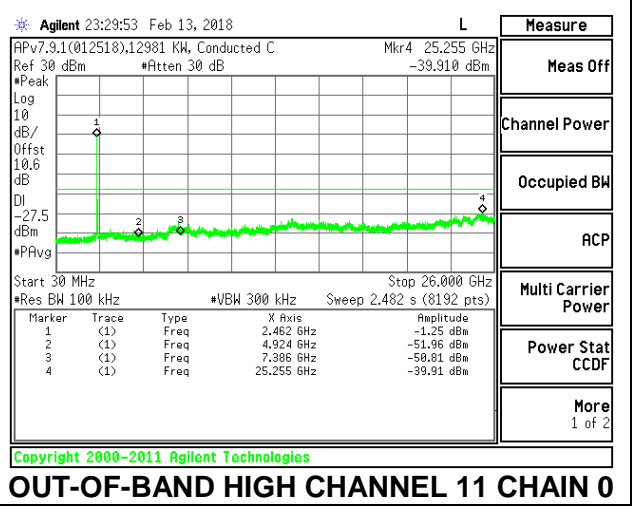

OUT-OF-BAND HIGH CHANNEL 11 CHAIN 0

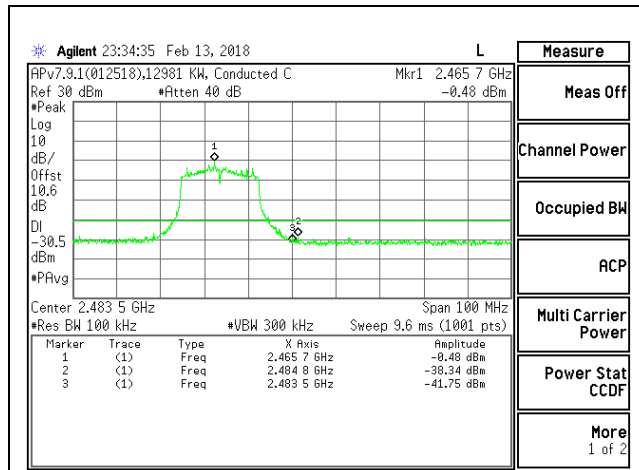

HIGH CHANNEL 12 BANDEDGE CHAIN 0

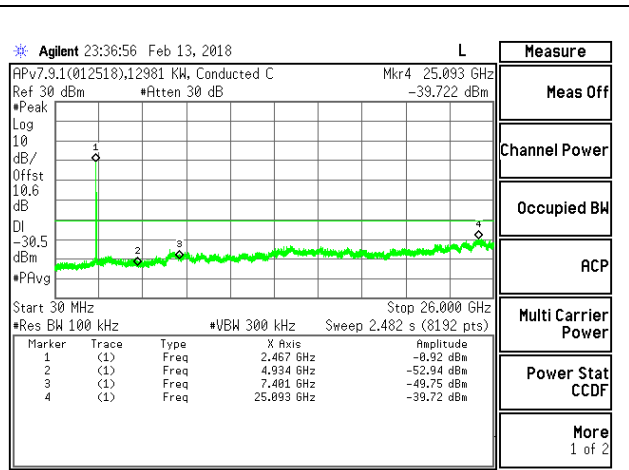

OUT-OF-BAND HIGH CHANNEL 12 CHAIN 0

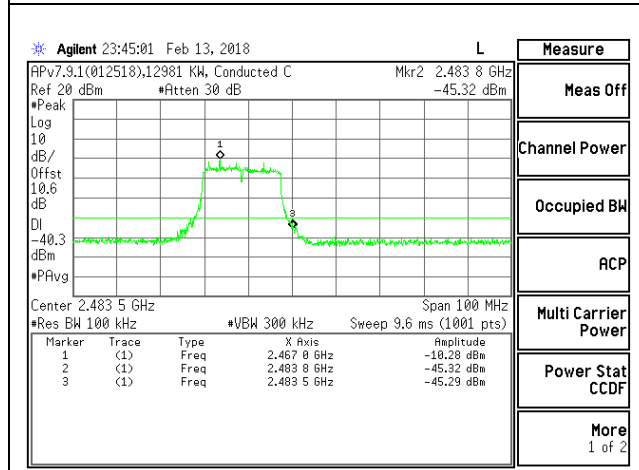

HIGH CHANNEL 13 BANDEDGE CHAIN 0

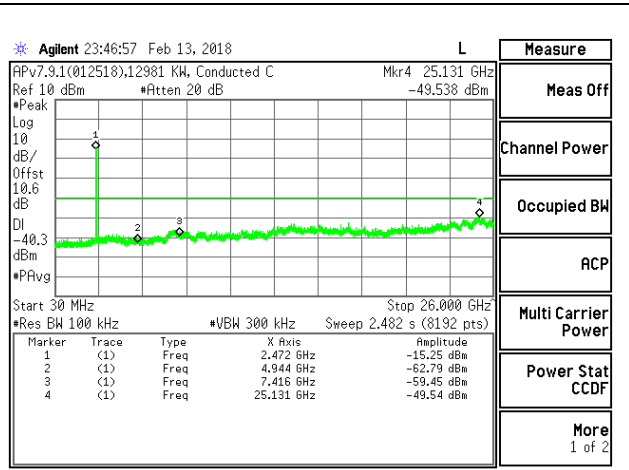

OUT-OF-BAND HIGH CHANNEL 13 CHAIN 0

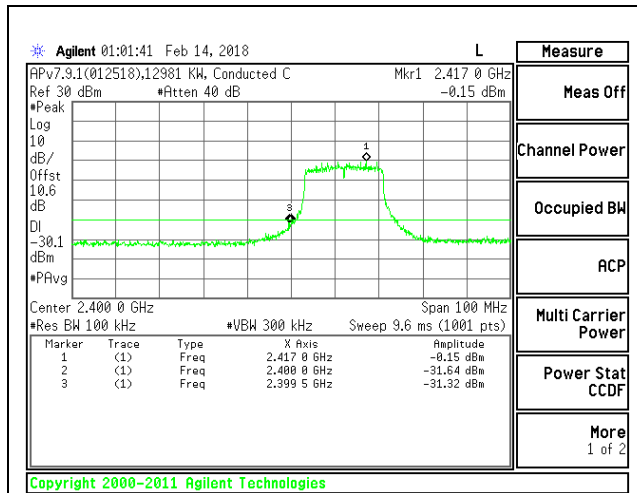

LOW CHANNEL 1 BANDEDGE CHAIN 1

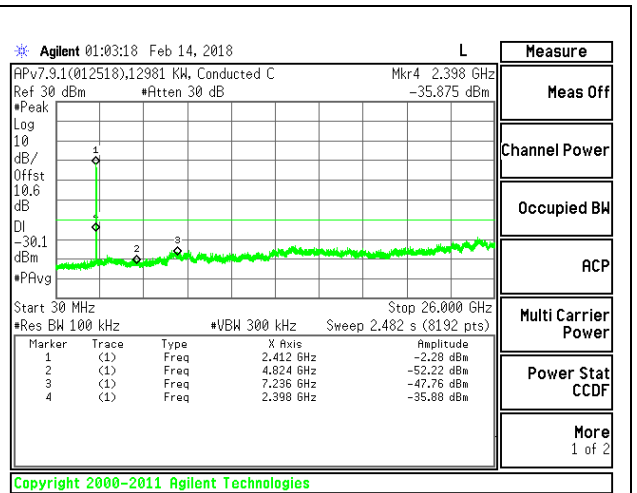

OUT-OF-BAND LOW CHANNEL 1 CHAIN 1

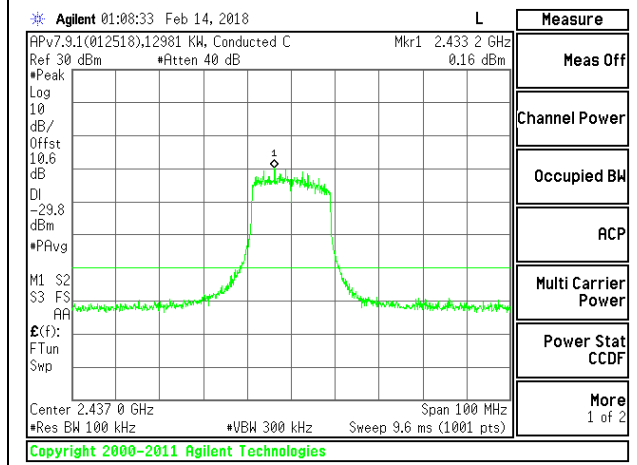

IN-BAND REFERENCE LEVEL CHAIN 1

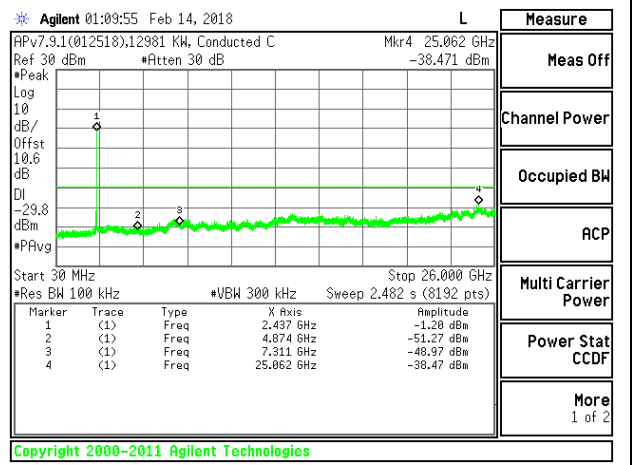

OUT-OF-BAND MID CHANNEL CHAIN 1

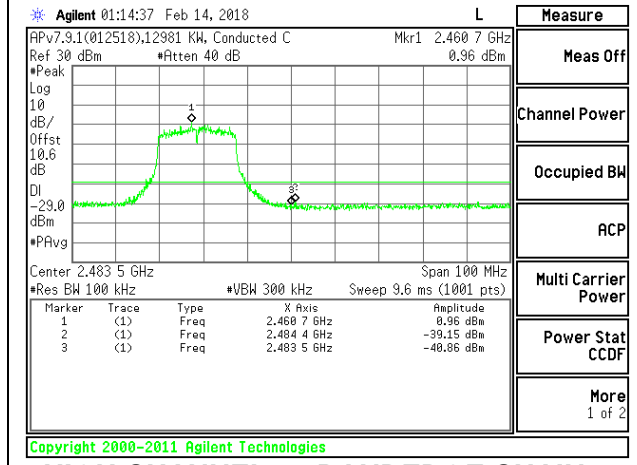

HIGH CHANNEL 11 BANDEDGE CHAIN 1

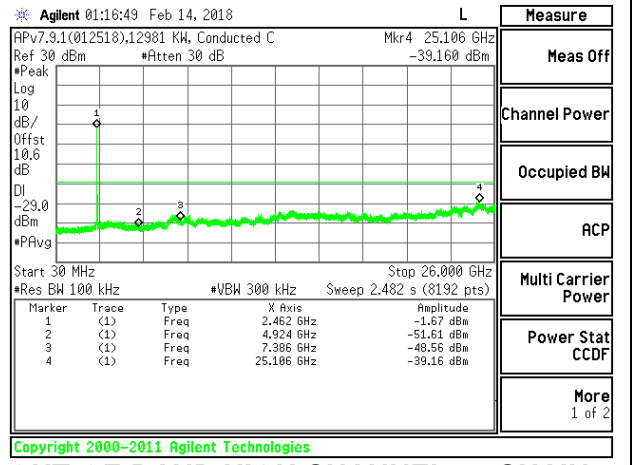

OUT-OF-BAND HIGH CHANNEL 11 CHAIN 1

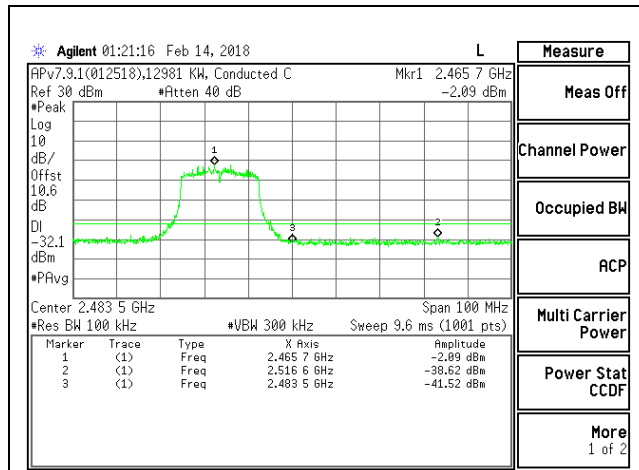

HIGH CHANNEL 12 BANDEDGE CHAIN 1

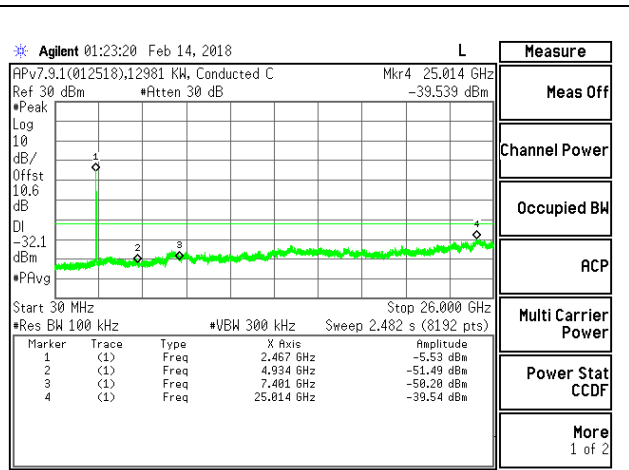

OUT-OF-BAND HIGH CHANNEL 12 CHAIN 1

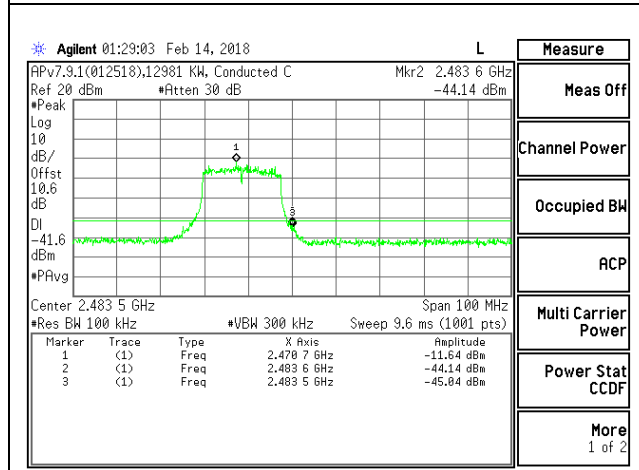

HIGH CHANNEL 13 BANDEDGE CHAIN 1

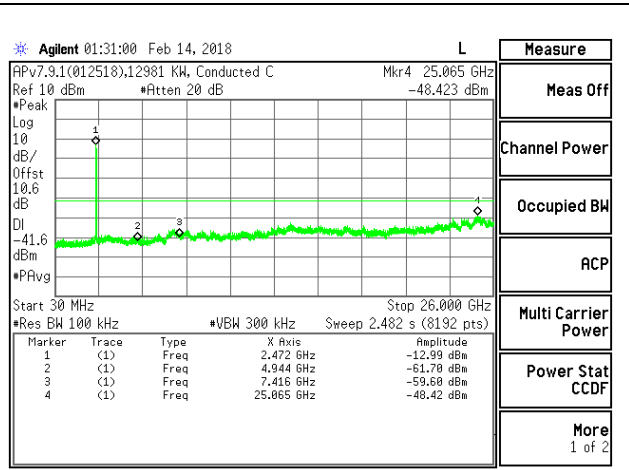

OUT-OF-BAND HIGH CHANNEL 13 CHAIN 1

9. RADIATED TEST RESULTS

LIMITS

FCC §15.205 and §15.209

Frequency Range (MHz)	Field Strength Limit (uV/m) at 3 m	Field Strength Limit (dBuV/m) at 3 m
0.009-0.490	2400/F(kHz) @ 300 m	-
0.490-1.705	24000/F(kHz) @ 30 m	-
1.705 - 30	30 @ 30m	-
30 - 88	100	40
88 - 216	150	43.5
216 - 960	200	46
Above 960	500	54

TEST PROCEDURE

The EUT is placed on a non-conducting table 80 cm above the ground plane for measurement below 1GHz; 1.5 m above the ground plane for measurement above 1GHz. The antenna to EUT distance is 3 meters. The EUT is configured in accordance with ANSI C63.10. The EUT is set to transmit in a continuous mode.

For measurements below 1 GHz the resolution bandwidth is set to 100 kHz for peak detection measurements or 120 kHz for quasi-peak detection measurements. Peak detection is used unless otherwise noted as quasi-peak.

For pre-scans above 1 GHz the resolution bandwidth is set to 1 MHz; the video bandwidth is set to 30 KHz for peak measurements.

For final measurements above 1 GHz the resolution bandwidth is set to 1 MHz; the video bandwidth is set to 3 MHz for peak measurements and as applicable for average measurements.

The spectrum from 1 GHz to 18 GHz is investigated with the transmitter set to the lowest, middle, and highest channels in each applicable band. Below 1GHz and above 18GHz emissions, the channel with the highest output power was tested.

The frequency range of interest is monitored at a fixed antenna height and EUT azimuth. The EUT is rotated through 360 degrees to maximize emissions received. The antenna is scanned from 1 to 4 meters above the ground plane to further maximize the emission. Measurements are made with the antenna polarized in both the vertical and the horizontal positions.

9.1. TRANSMITTER ABOVE 1 GHz

9.1.1. TX ABOVE 1 GHz 802.11b MODE IN THE 2.4 GHz BAND

BANDEDGE (LOW CHANNEL, CH 1)

HORIZONTAL RESULT

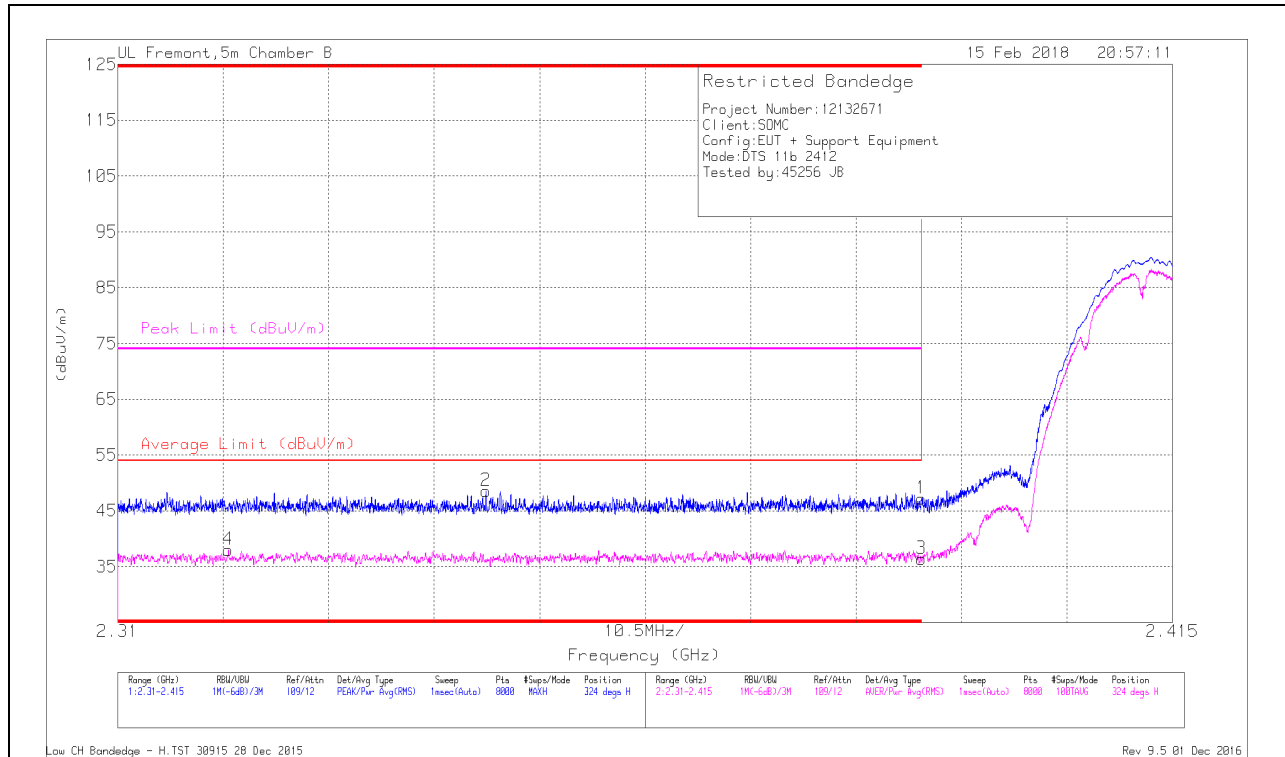

Marker	Frequency (GHz)	Meter Reading (dBuV)	Det	AF T863 (dB/m)	Amp/Cbl/Fitr/Pad (dB)	DC Corr (dB)	Corrected Reading (dBuV/m)	Average Limit (dBuV/m)	Margin (dB)	Peak Limit (dBuV/m)	PK Margin (dB)	Azimuth (Degs)	Height (cm)	Polarity
1	* 2.39	36.51	Pk	32	-21.3	0	47.21	-	-	74	-26.79	324	145	H
2	* 2.347	37.94	Pk	31.9	-21.3	0	48.54	-	-	74	-25.46	324	145	H
3	* 2.39	25.71	RMS	32	-21.3	0	36.41	54	-17.59	-	-	324	145	H
4	* 2.321	27.25	RMS	31.9	-21.2	0	37.95	54	-16.05	-	-	324	145	H

* - indicates frequency in CFR47 Pt 15 - Restricted Band

Pk - Peak detector

RMS - RMS detection

VERTICAL RESULT

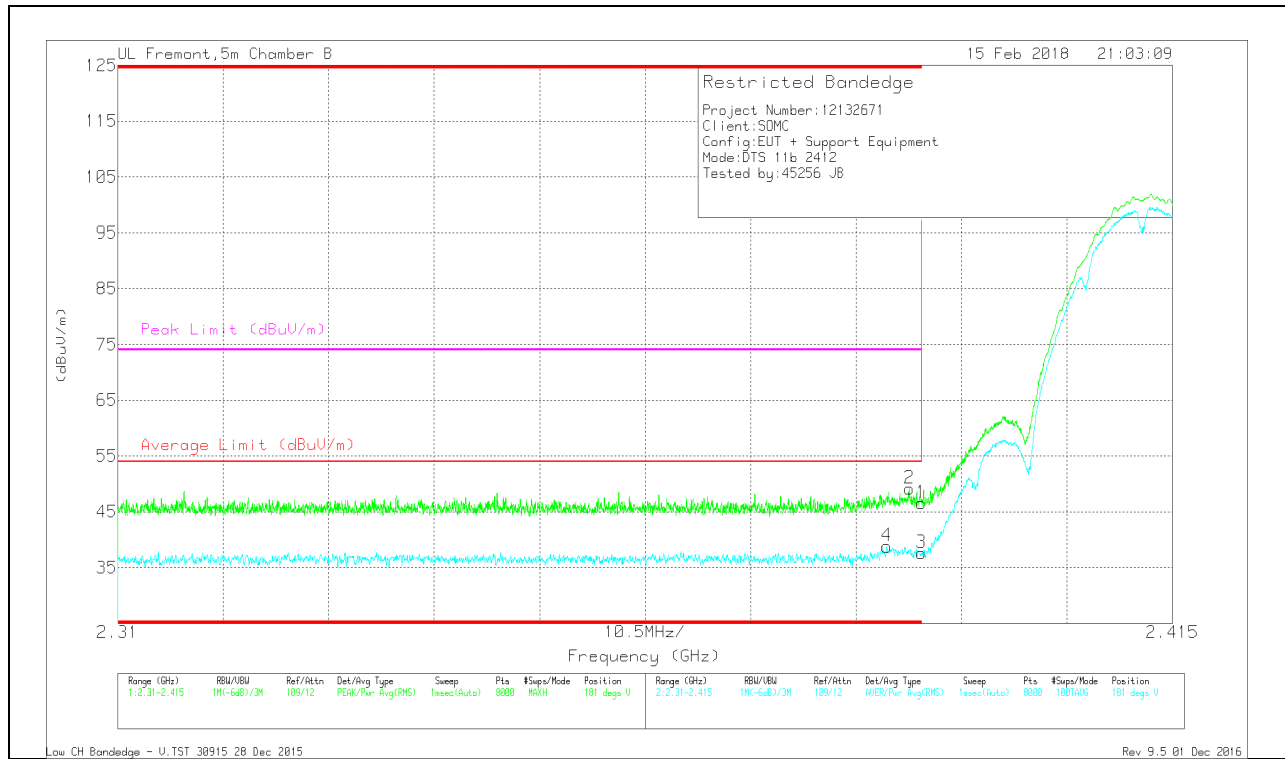

Marker	Frequency (GHz)	Meter Reading (dBuV)	Det	AF T863 (dBm)	Amp/Cb/Filt/Pad (dB)	DC Corr (dB)	Corrected Reading (dBuV/m)	Average Limit (dBuV/m)	Margin (dB)	Peak Limit (dBuV/m)	PK Margin (dB)	Azimuth (Dege)	Height (cm)	Polarity
1	* 2.39	35.82	Pk	32	-21.3	0	46.62	-	-	74	-27.48	181	166	V
2	* 2.389	38.45	PK	32	-21.3	0	49.15	-	-	74	-24.85	181	166	V
3	* 2.39	26.94	RMS	32	-21.3	0	37.64	54	-16.36	-	-	181	166	V
4	* 2.387	28.11	RMS	32	-21.3	0	38.81	54	-15.19	-	-	181	166	V

* - indicates frequency in CFR47 Pt 15 - Restricted Band

Pk - Peak detector

RMS - RMS detection

BANDEGE (HIGH CHANNEL, CH 11)

HORIZONTAL RESULT

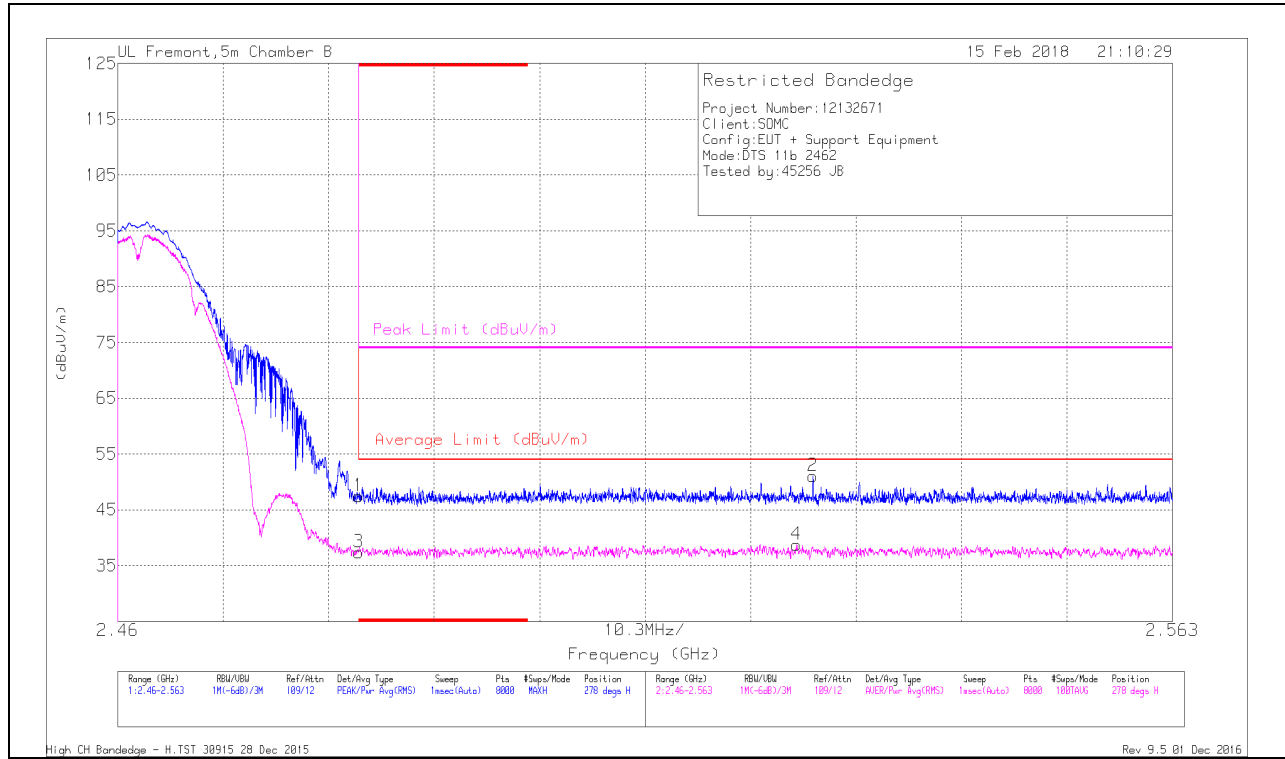

Marker	Frequency (GHz)	Meter Reading (dBuV)	Det	AF T863 (dBm)	Amp/CD/Filt/Pad (dB)	DC Corr (dB)	Corrected Reading (dBuV/m)	Average Limit (dBuV/m)	Margin (dB)	Peak Limit (dBuV/m)	PK Margin (dB)	Azimuth (Degs)	Height (cm)	Polarity
1	* 2.484	36.28	Pk	32.5	-21.3	0	47.48	-	-	74	-26.52	278	220	H
3	* 2.484	26.23	RMS	32.5	-21.3	0	37.43	54	-16.57	-	-	278	220	H
4	2.526	27.46	RMS	32.5	-21.2	0	38.76	54	-15.24	-	-	278	220	H
2	2.528	39.69	Pk	32.5	-21.2	0	50.99	-	-	74	-23.01	278	220	H

* - indicates frequency in CFR47 Pt 15 - Restricted Band
 Pk - Peak detector
 RMS - RMS detection

VERTICAL RESULT

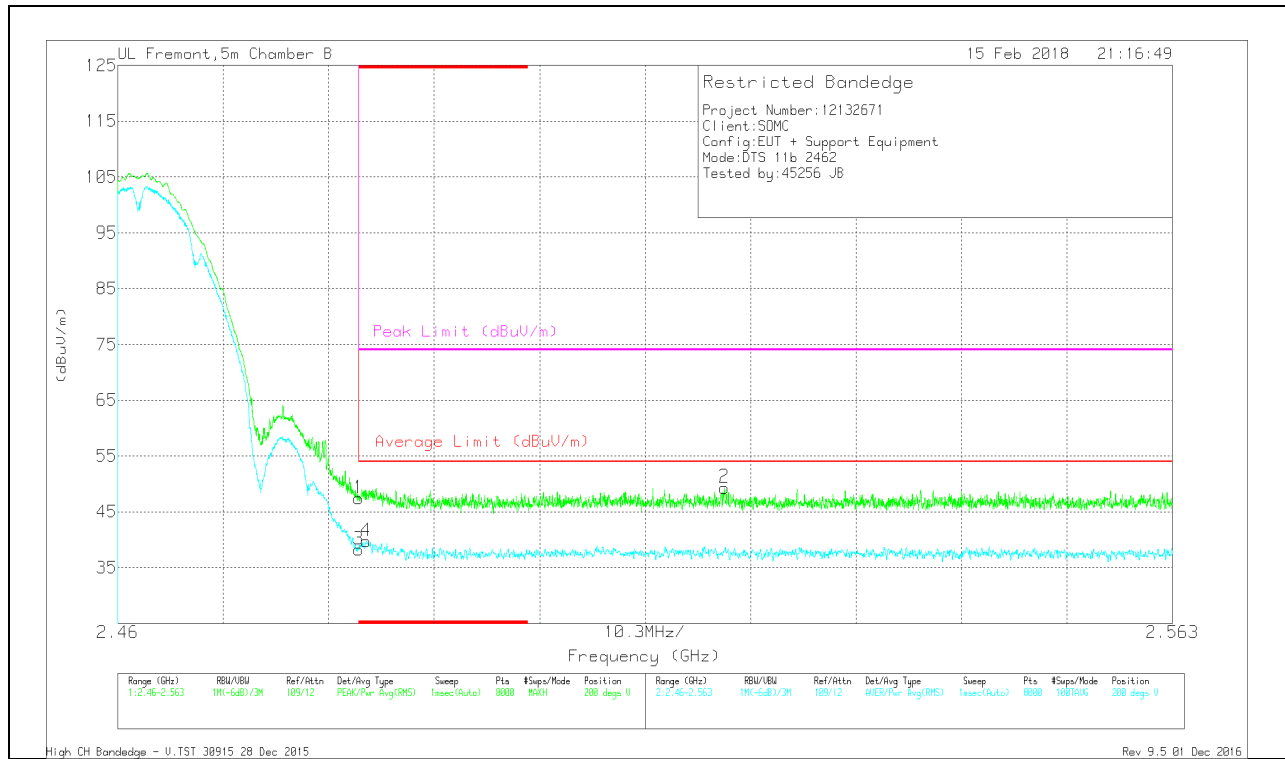

Marker	Frequency (GHz)	Meter Reading (dBuV)	Det	AP T863 (dBm)	Amp/Ch/IF/In/Pad (dB)	DC Corr (dB)	Corrected Reading (dBuV/m)	Average Limit (dBuV/m)	Margin (dB)	Peak Limit (dBuV/m)	PK Margin (dB)	Azimuth (Dege)	Height (cm)	Polarity
1	* 2.484	36.19	Pk	32.5	-21.3	0	47.39	-	-	74	-26.61	200	227	V
3	* 2.484	27	RMS	32.5	-21.3	0	38.2	54	-15.8	-	-	200	227	V
4	* 2.484	28.53	RMS	32.5	-21.3	0	39.73	54	-14.27	-	-	200	227	V
2	2.519	37.86	Pk	32.6	-21.1	0	49.36	-	-	74	-24.64	200	227	V

* - indicates frequency in CFR47 Pt 15 - Restricted Band
 Pk - Peak detector
 RMS - RMS detection

BANDEDGE (HIGH CHANNEL, CH 12)

HORIZONTAL RESULT

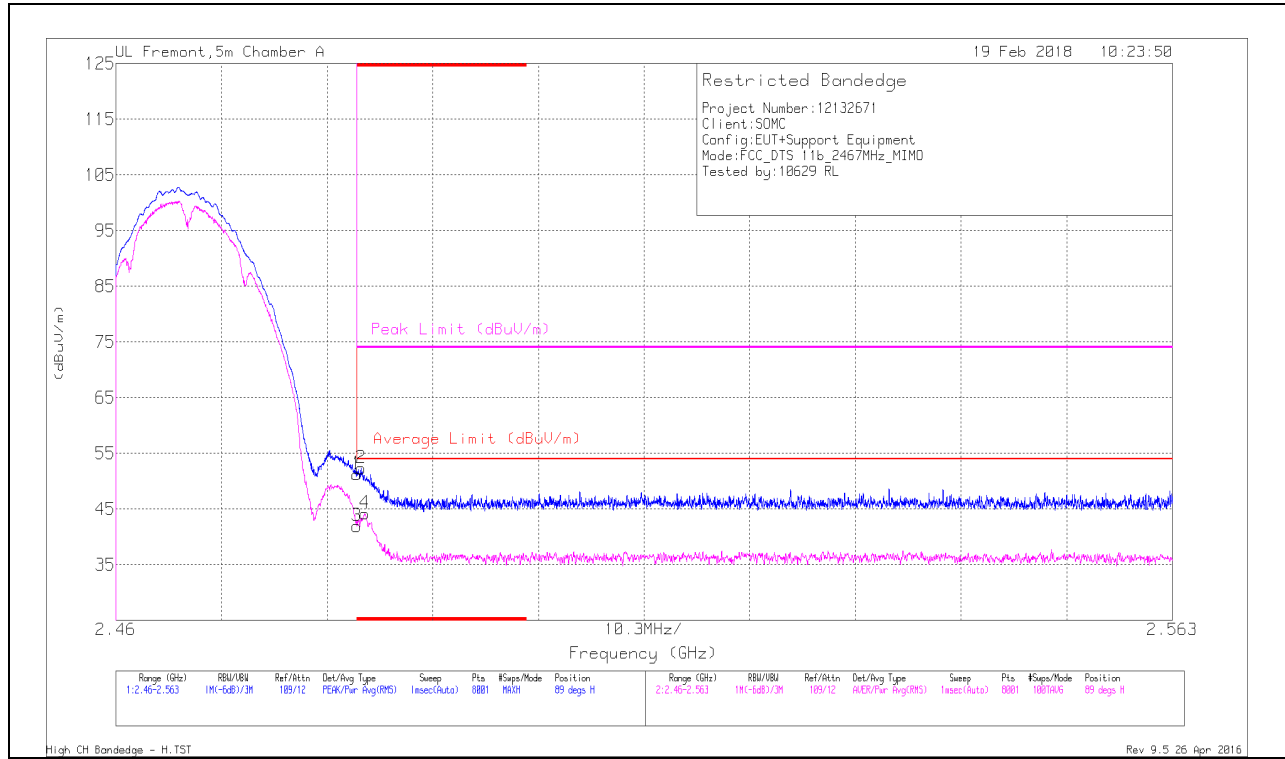

Marker	Frequency (GHz)	Meter Reading (dBuV)	Det	AF T862 (dB/m)	Amp/Cbl/Filtr/Pad (dB)	DC Corr (dB)	Corrected Reading (dBuV/m)	Average Limit (dBuV/m)	Margin (dB)	Peak Limit (dBuV/m)	PK Margin (dB)	Azimuth (Degs)	Height (cm)	Polarity
1	* 2.484	42.13	Pk	32.3	-23.2	0	51.23	-	-	74	-22.77	89	239	H
2	* 2.484	43.25	Pk	32.3	-23.2	0	52.35	-	-	74	-21.65	89	239	H
3	* 2.484	32.85	RMS	32.3	-23.2	0	41.95	54	-12.05	-	-	89	239	H
4	* 2.484	35.1	RMS	32.3	-23.2	0	44.2	54	-9.8	-	-	89	239	H

* - indicates frequency in CFR47 Pt 15 - Restricted Band
 Pk - Peak detector
 RMS - RMS detection

VERTICAL RESULT

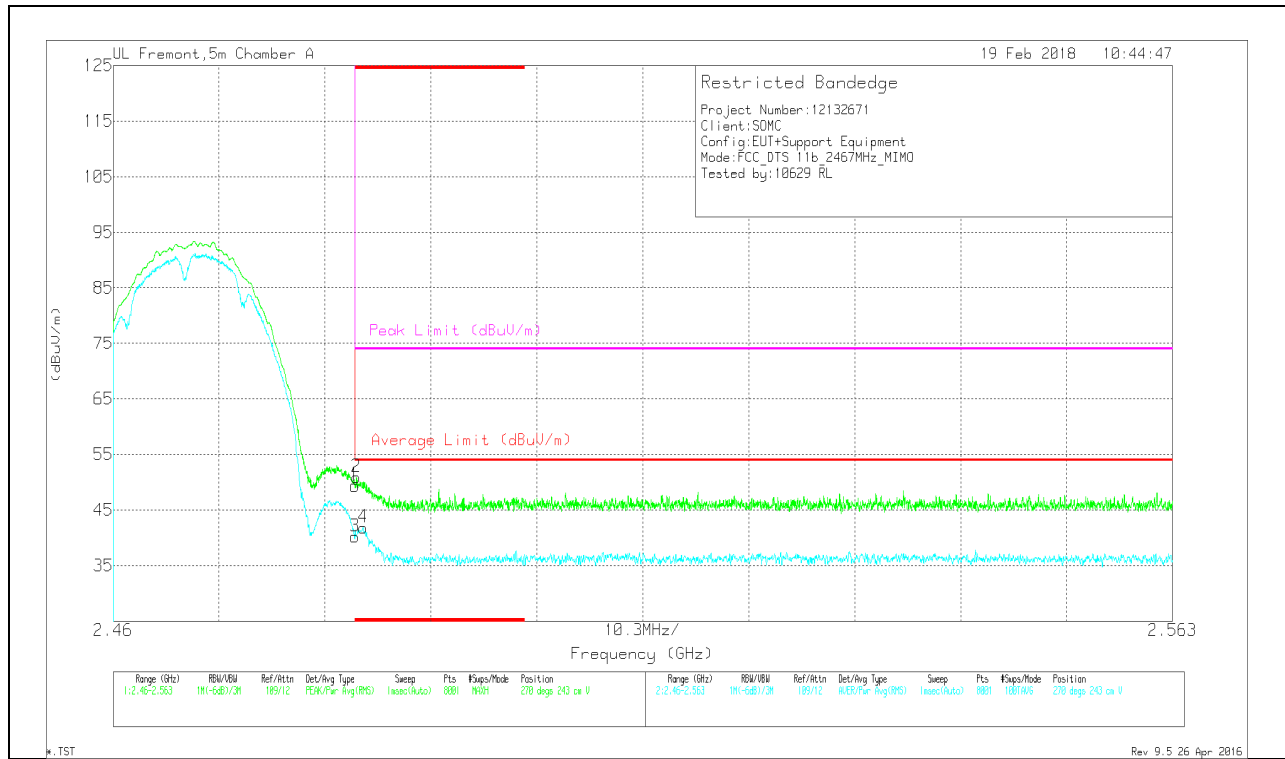

Marker	Frequency (GHz)	Meter Reading (dBuV)	Det	AF T862 (dB/m)	Amp/Cb/Fitr/P ad (dB)	DC Corr (dB)	Corrected Reading (dBuV/m)	Average Limit (dBuV/m)	Margin (dB)	Peak Limit (dBuV/m)	PK Margin (dB)	Azimuth (Degs)	Height (cm)	Polarity
1	* 2.484	40.27	Pk	32.3	-23.2	0	49.37	-	-	74	-24.63	270	243	V
2	* 2.484	41.82	Pk	32.3	-23.2	0	50.92	-	-	74	-23.08	270	243	V
3	* 2.484	31.12	RMS	32.3	-23.2	0	40.22	54	-13.78	-	-	270	243	V
4	* 2.484	32.73	RMS	32.3	-23.2	0	41.83	54	-12.17	-	-	270	243	V

* - indicates frequency in CFR47 Pt 15 - Restricted Band

Pk - Peak detector

RMS - RMS detection

BANDEGE (HIGH CHANNEL, CH 13)

HORIZONTAL RESULT

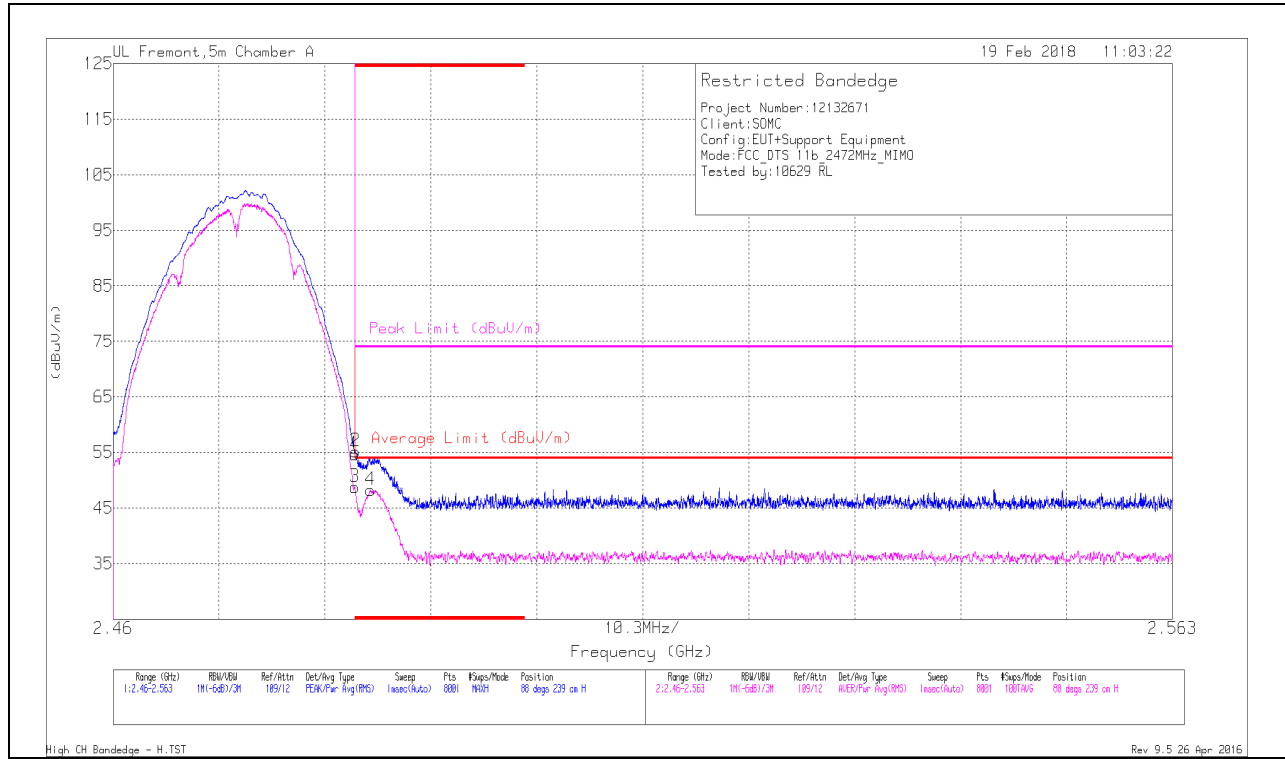

Marker	Frequency (GHz)	Meter Reading (dBuV)	Det	AF T862 (dB/m)	Amp/Cbl/Fitr/Pad (dB)	DC Corr (dB)	Corrected Reading (dBuV/m)	Average Limit (dBuV/m)	Margin (dB)	Peak Limit (dBuV/m)	PK Margin (dB)	Azimuth (Degs)	Height (cm)	Polarity
1	* 2.484	45.6	Pk	32.3	-23.2	0	54.7	-	-	74	-19.3	88	239	H
2	* 2.484	46.09	Pk	32.3	-23.2	0	55.19	-	-	74	-18.81	88	239	H
3	* 2.484	39.7	RMS	32.3	-23.2	0	48.8	54	-5.2	-	-	88	239	H
4	* 2.485	39.16	RMS	32.3	-23.2	0	48.26	54	-5.74	-	-	88	239	H

* - indicates frequency in CFR47 Pt 15 - Restricted Band
 Pk - Peak detector
 RMS - RMS detection

VERTICAL RESULT

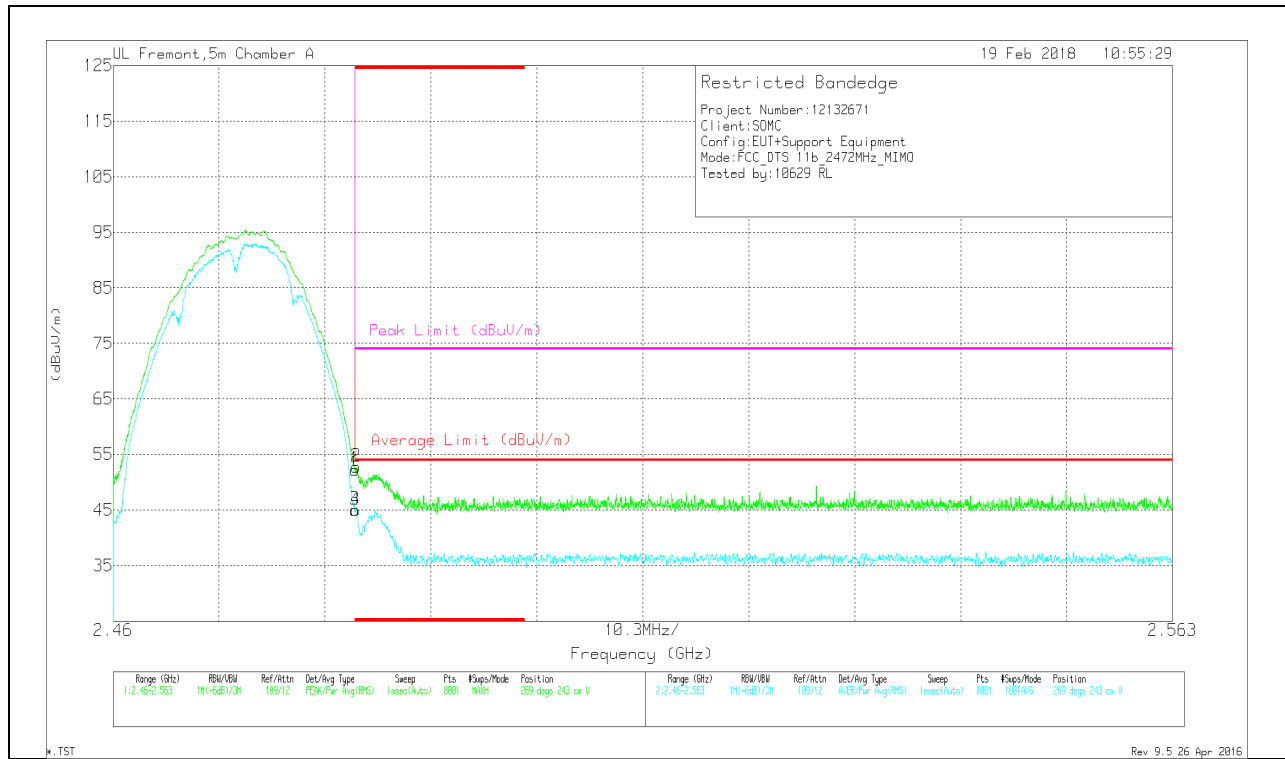

Marker	Frequency (GHz)	Meter Reading (dBuV)	Det	AF T862 (dB/m)	Amp/Cbl/Filtr/Pad (dB)	DC Corr (dB)	Corrected Reading (dBuV/m)	Average Limit (dBuV/m)	Margin (dB)	Peak Limit (dBuV/m)	PK Margin (dB)	Azimuth (Degs)	Height (cm)	Polarity
1	* 2.484	43.18	Pk	32.3	-23.2	0	52.28	-	-	74	-21.72	269	243	V
2	* 2.484	43.71	Pk	32.3	-23.2	0	52.81	-	-	74	-21.19	269	243	V
3	* 2.484	35.95	RMS	32.3	-23.2	0	45.05	54	-8.95	-	-	269	243	V
4	* 2.484	35.92	RMS	32.3	-23.2	0	45.02	54	-8.98	-	-	269	243	V

* - indicates frequency in CFR47 Pt 15 - Restricted Band

Pk - Peak detector

RMS - RMS detection

HARMONICS AND SPURIOUS EMISSIONS

LOW CHANNEL, CH 1 RESULTS

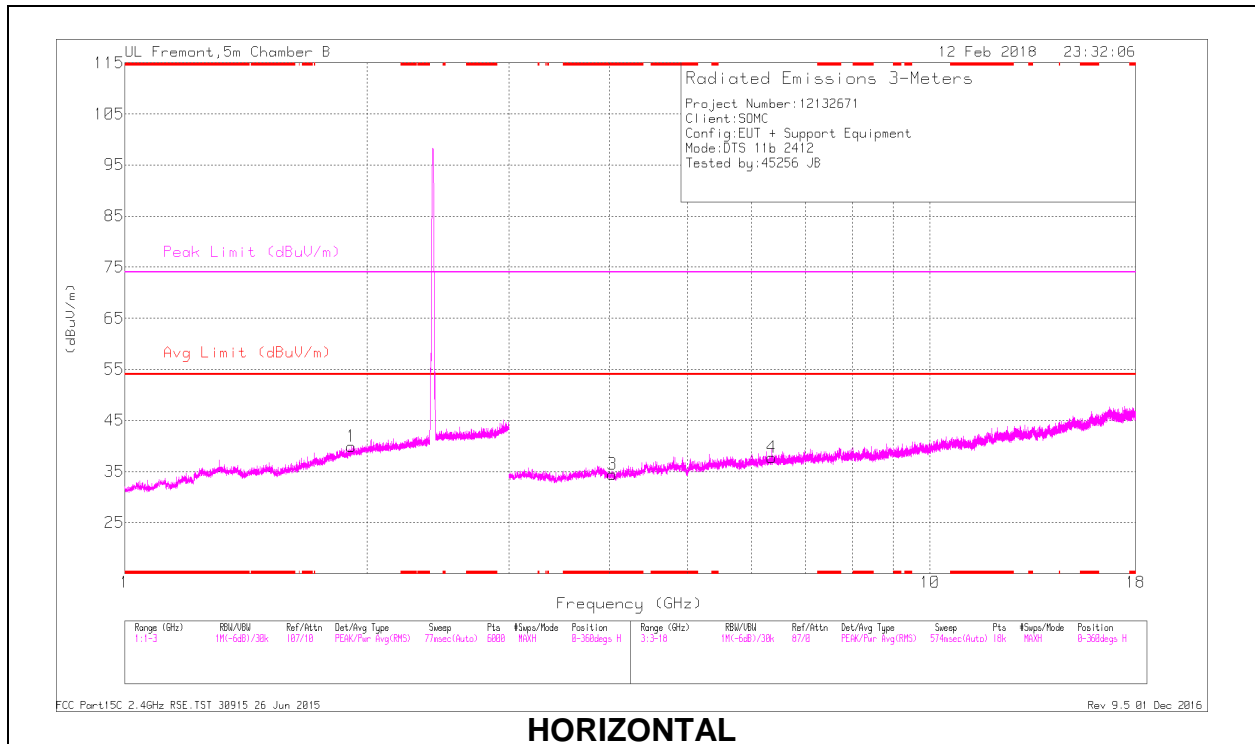

HORIZONTAL

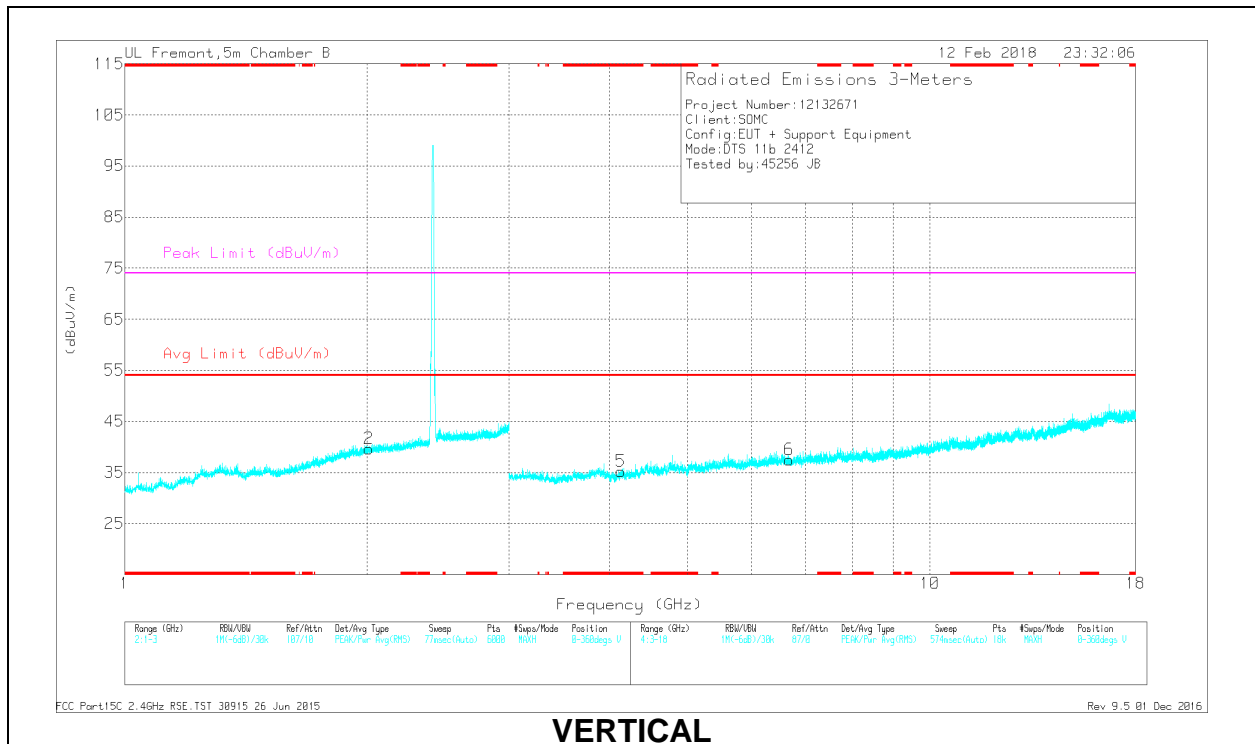

VERTICAL

RADIATED EMISSIONS

Trace Markers

Marker	Frequency (GHz)	Meter Reading (dBuV)	Det	AF T863 (dB/m)	Amp/Cbl/Fitr/Pad (dB)	DC Corr (dB)	Corrected Reading (dBuV/m)	Avg Limit (dBuV/m)	Margin (dB)	Peak Limit (dBuV/m)	PK Margin (dB)	Azimuth (Degs)	Height (cm)	Polarity
3	* 4.035	32.66	Pk	33.4	-31.6	0	34.46	-	-	74	-39.54	0-360	199	H
5	* 4.133	32.54	Pk	33.4	-30.7	0	35.24	-	-	74	-38.76	0-360	102	V
1	1.911	29.9	Pk	31	-21	0	39.9	-	-	-	-	0-360	199	H
2	2.011	29.56	Pk	31.3	-21.2	0	39.66	-	-	-	-	0-360	200	V
4	6.359	32.06	Pk	35.7	-30	0	37.76	-	-	-	-	0-360	199	H
6	6.686	31.55	Pk	35.7	-29.8	0	37.45	-	-	-	-	0-360	200	V

* - indicates frequency in CFR47 Pt 15 - Restricted Band
 Pk - Peak detector

Radiated Emissions

Marker	Frequency (GHz)	Meter Reading (dBuV)	Det	AF T863 (dB/m)	Amp/Cbl/Fitr/Pad (dB)	DC Corr (dB)	Corrected Reading (dBuV/m)	Avg Limit (dBuV/m)	Margin (dB)	Peak Limit (dBuV/m)	PK Margin (dB)	Azimuth (Degs)	Height (cm)	Polarity
3	* 4.035	37.63	PK2	33.4	-31.6	0	39.43	-	-	74	-34.57	321	180	H
	* 4.035	25.69	MAv1	33.4	-31.6	0	27.49	54	-26.51	-	-	321	180	H
5	* 4.135	37.11	PK2	33.4	-30.7	0	39.81	-	-	74	-34.19	277	350	V
	* 4.135	25.61	MAv1	33.4	-30.7	0	28.31	54	-25.69	-	-	277	350	V

* - indicates frequency in CFR47 Pt 15 - Restricted Band
 PK2 - KDB558074 Method: Maximum Peak
 MAv1 - KDB558074 Option 1 Maximum RMS Average

MID CHANNEL, CH 6 RESULTS

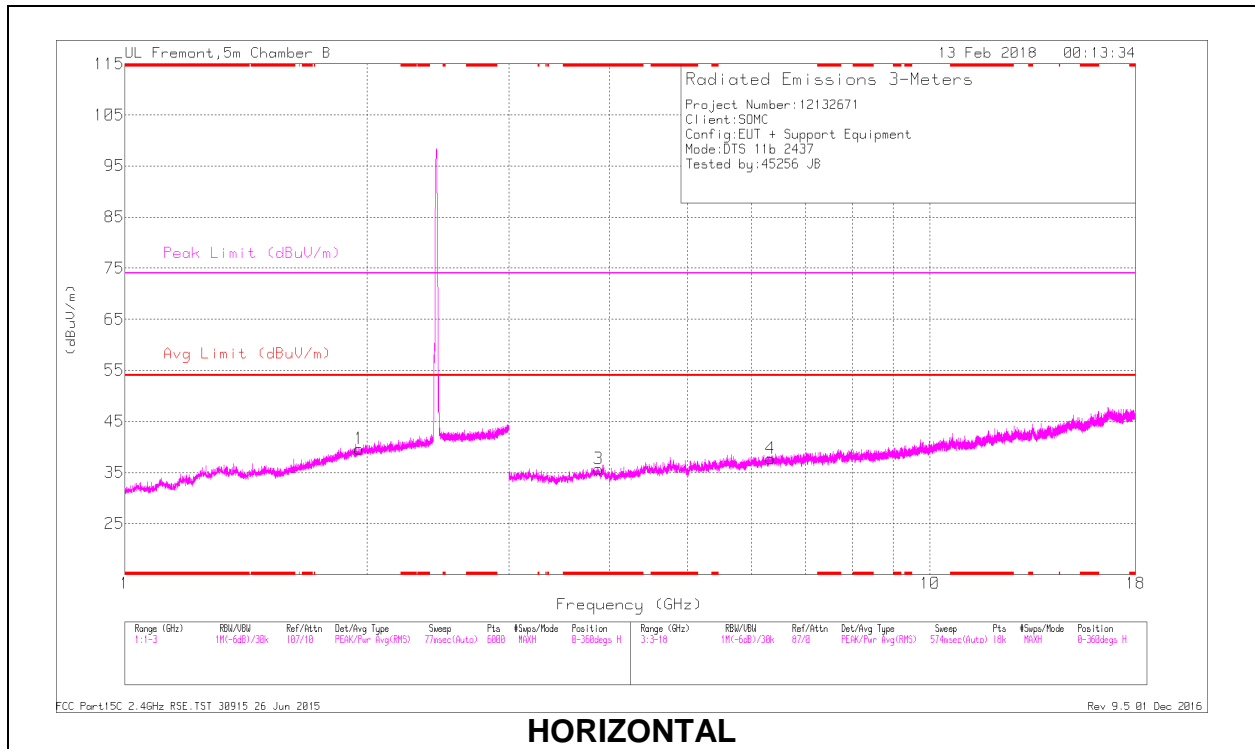

HORIZONTAL

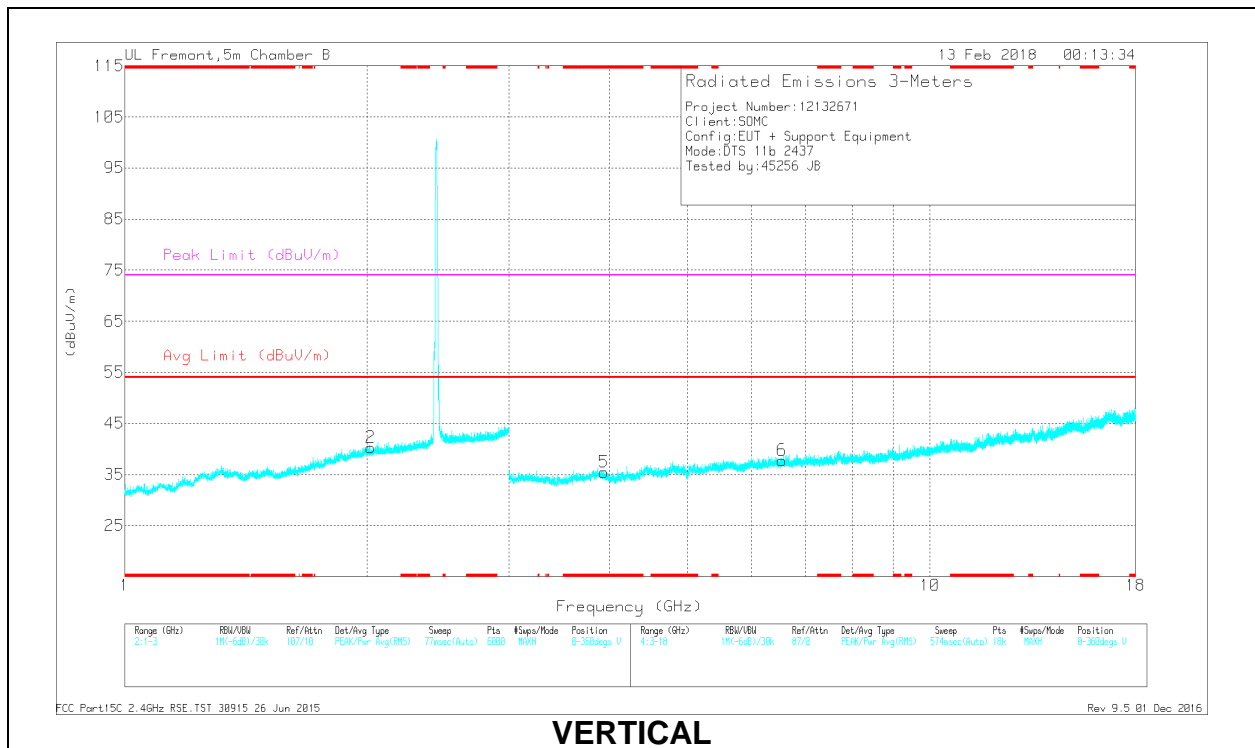

VERTICAL

RADIATED EMISSIONS

Trace Markers

Marker	Frequency (GHz)	Meter Reading (dBuV)	Det	AF T863 (dB/m)	Amp/Cbl/Fitr/Pad (dB)	DC Corr (dB)	Corrected Reading (dBuV/m)	Avg Limit (dBuV/m)	Margin (dB)	Peak Limit (dBuV/m)	PK Margin (dB)	Azimuth (Degs)	Height (cm)	Polarity
3	* 3.873	32.62	Pk	33.5	-30.4	0	35.72	-	-	74	-38.28	0-360	102	H
5	* 3.938	32.66	Pk	33.5	-30.7	0	35.46	-	-	74	-38.54	0-360	102	V
1	1.953	29.58	Pk	31.1	-21.1	0	39.58	-	-	-	-	0-360	199	H
2	2.019	30.09	Pk	31.3	-21.1	0	40.29	-	-	-	-	0-360	199	V
4	6.341	31.88	Pk	35.7	-29.9	0	37.68	-	-	-	-	0-360	199	H
6	6.548	31.09	Pk	35.7	-29.1	0	37.69	-	-	-	-	0-360	102	V

* - indicates frequency in CFR47 Pt 15 - Restricted Band
 Pk - Peak detector

Radiated Emissions

Marker	Frequency (GHz)	Meter Reading (dBuV)	Det	AF T863 (dB/m)	Amp/Cbl/Fitr/Pad (dB)	DC Corr (dB)	Corrected Reading (dBuV/m)	Avg Limit (dBuV/m)	Margin (dB)	Peak Limit (dBuV/m)	PK Margin (dB)	Azimuth (Degs)	Height (cm)	Polarity
3	* 3.872	37.64	PK2	33.5	-30.4	0	40.74	-	-	74	-33.26	268	102	H
	* 3.872	25.92	MAv1	33.5	-30.4	0	29.02	54	-24.98	-	-	268	102	H
5	* 3.936	37.67	PK2	33.5	-30.7	0	40.47	-	-	74	-33.53	63	244	V
	* 3.936	25.62	MAv1	33.5	-30.7	0	28.42	54	-25.58	-	-	63	244	V

* - indicates frequency in CFR47 Pt 15 - Restricted Band
 PK2 - KDB558074 Method: Maximum Peak
 MAv1 - KDB558074 Option 1 Maximum RMS Average

HIGH CHANNEL, CH 11 RESULTS

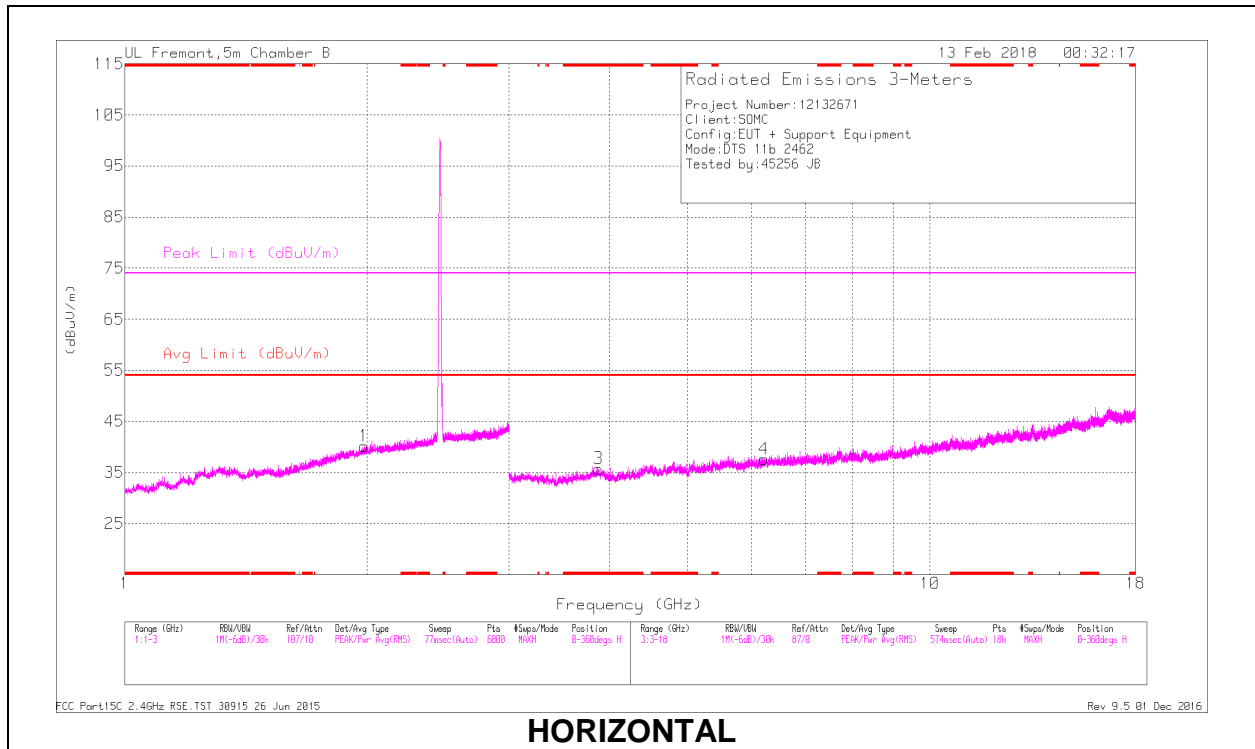

HORIZONTAL

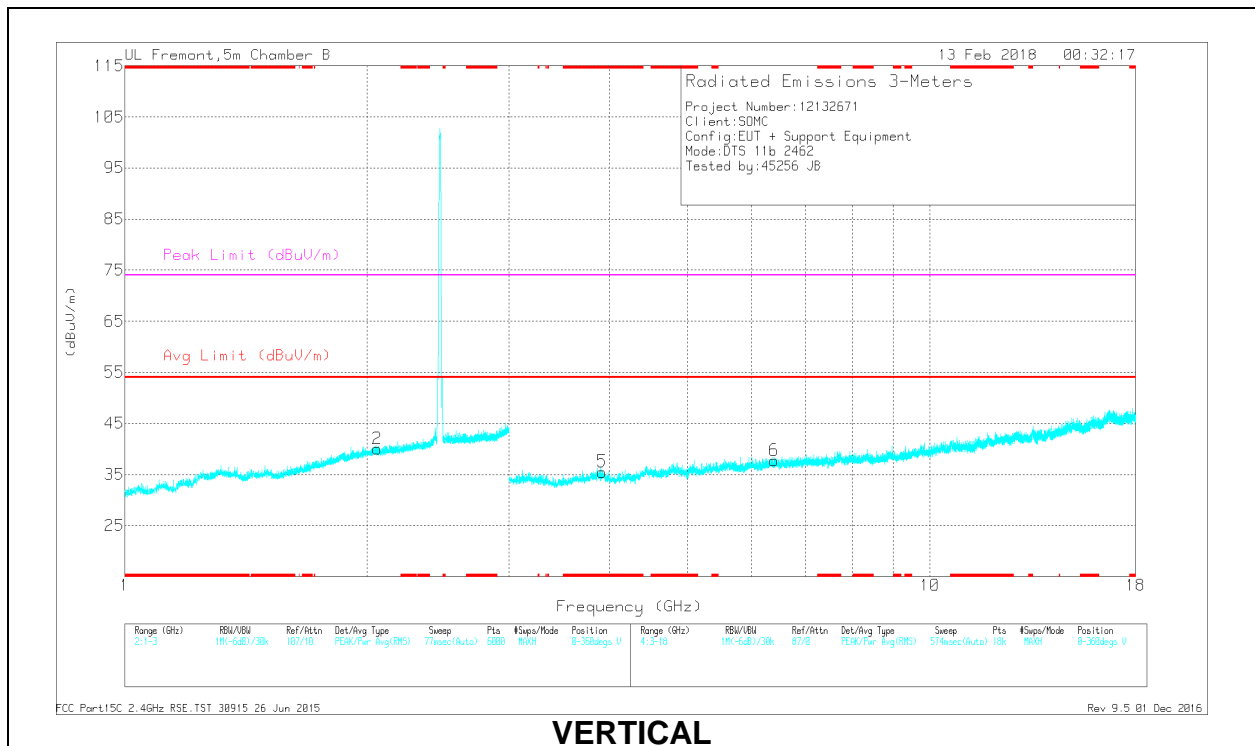

VERTICAL

RADIATED EMISSIONS

Trace Markers

Marker	Frequency (GHz)	Meter Reading (dBuV)	Det	AF T863 (dB/m)	Amp/Cbl/Fitr/Pad (dB)	DC Corr (dB)	Corrected Reading (dBuV/m)	Avg Limit (dBuV/m)	Margin (dB)	Peak Limit (dBuV/m)	PK Margin (dB)	Azimuth (Degs)	Height (cm)	Polarity
3	* 3.878	32.66	Pk	33.5	-30.4	0	35.76	-	-	74	-38.24	0-360	102	H
5	* 3.918	32.41	Pk	33.5	-30.4	0	35.51	-	-	74	-38.49	0-360	199	V
1	1.983	30.09	Pk	31.2	-21.1	0	40.19	-	-	-	-	0-360	199	H
2	2.059	29.85	Pk	31.4	-21.2	0	40.05	-	-	-	-	0-360	102	V
4	6.218	31.71	Pk	35.6	-29.7	0	37.61	-	-	-	-	0-360	102	H
6	6.399	32.08	Pk	35.7	-30	0	37.78	-	-	-	-	0-360	199	V

* - indicates frequency in CFR47 Pt 15 - Restricted Band
 Pk - Peak detector

Radiated Emissions

Marker	Frequency (GHz)	Meter Reading (dBuV)	Det	AF T863 (dB/m)	Amp/Cbl/Fitr/Pad (dB)	DC Corr (dB)	Corrected Reading (dBuV/m)	Avg Limit (dBuV/m)	Margin (dB)	Peak Limit (dBuV/m)	PK Margin (dB)	Azimuth (Degs)	Height (cm)	Polarity
3	* 3.879	37.58	PK2	33.5	-30.4	0	40.68	-	-	74	-33.32	113	278	H
	* 3.88	25.82	MAv1	33.5	-30.4	0	28.92	54	-25.08	-	-	113	278	H
5	* 3.919	37.81	PK2	33.5	-30.5	0	40.81	-	-	74	-33.19	248	197	V
	* 3.917	26.24	MAv1	33.5	-30.4	0	29.34	54	-24.66	-	-	248	197	V

* - indicates frequency in CFR47 Pt 15 - Restricted Band
 PK2 - KDB558074 Method: Maximum Peak
 MAv1 - KDB558074 Option 1 Maximum RMS Average

9.1.2. TX ABOVE 1 GHz 802.11g MODE IN THE 2.4 GHz BAND

BANDEDGE (LOW CHANNEL, CH 1)

HORIZONTAL RESULT

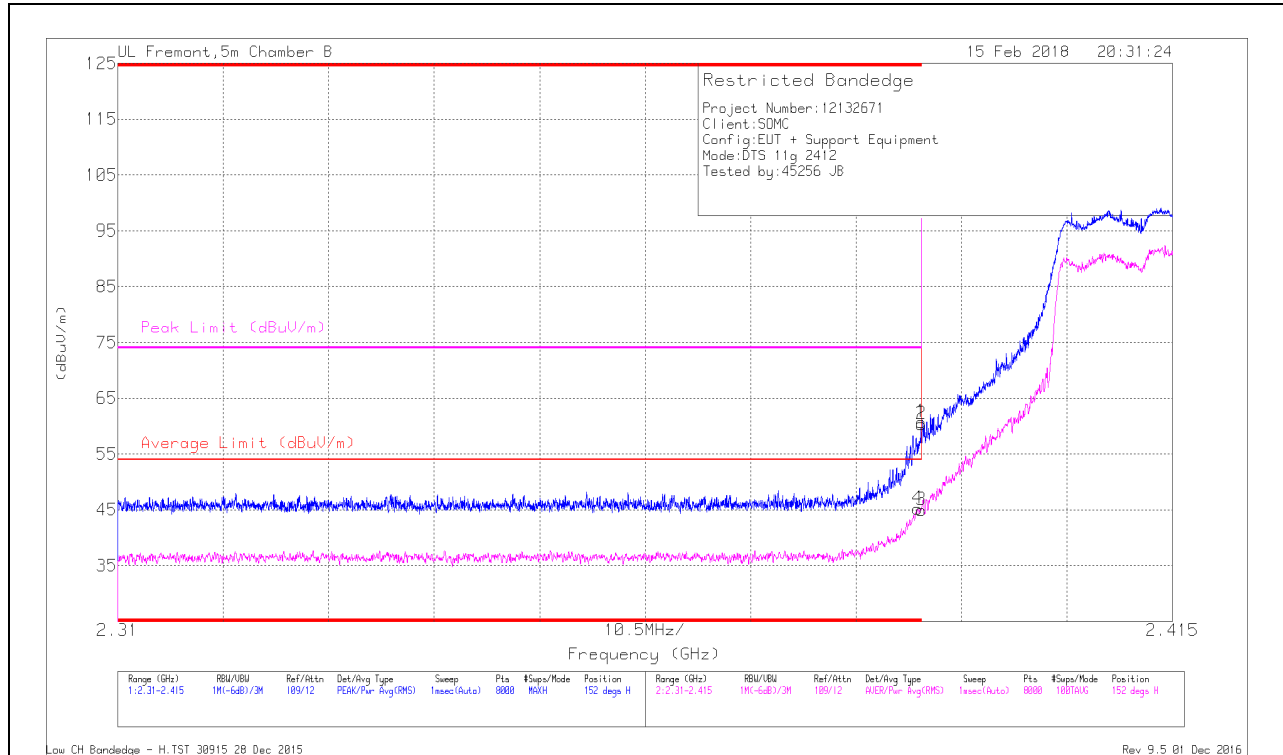

Marker	Frequency (GHz)	Meter Reading (dBuV)	Det	AF T863 (dBm)	Amp/Ch/Filt/Pad (dB)	DC Corr (dB)	Corrected Reading (dBuV/m)	Average Limit (dBuV/m)	Margin (dB)	Peak Limit (dBuV/m)	PK Margin (dB)	Azimuth (Degs)	Height (cm)	Polarity
1	* 2.39	50.03	Pk	32	-21.3	0	60.73	-	-	74	-13.27	152	122	H
2	* 2.39	49.67	Pk	32	-21.3	0	60.37	-	-	74	-13.63	152	122	H
3	* 2.39	34.26	RMS	32	-21.3	0	44.96	54	-9.04	-	-	152	122	H
4	* 2.39	34.48	RMS	32	-21.3	0	45.18	54	-8.82	-	-	152	122	H

* - indicates frequency in CFR47 Pt 15 - Restricted Band

Pk - Peak detector

RMS - RMS detection

VERTICAL RESULT

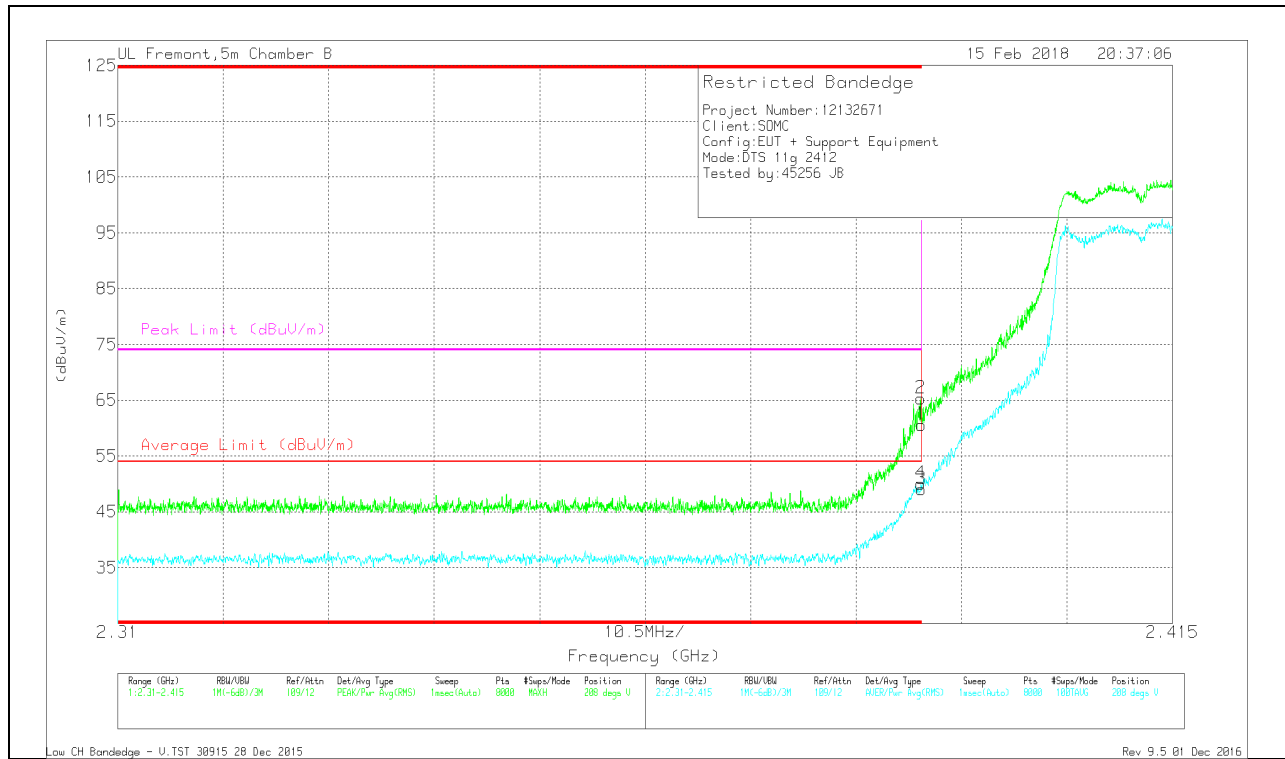

Marker	Frequency (GHz)	Meter Reading (dBuV)	Det	AF T863 (dBm)	Amp/CB/Filt/Pad (dB)	DC Corr (dB)	Corrected Reading (dBuV/m)	Average Limit (dBuV/m)	Margin (dB)	Peak Limit (dBuV/m)	PK Margin (dB)	Azimuth (Degs)	Height (cm)	Polarity
1	* 2.39	49.91	Pk	32	-21.3	0	60.61	-	-	74	-13.39	208	245	V
2	* 2.39	54.56	Pk	32	-21.3	0	65.26	-	-	74	-8.74	208	245	V
3	* 2.39	38.35	RMS	32	-21.3	0	49.05	54	-4.95	-	-	208	245	V
4	* 2.39	39.32	RMS	32	-21.3	0	50.02	54	-3.98	-	-	208	245	V

* - indicates frequency in CFR47 Pt 15 - Restricted Band
 Pk - Peak detector
 RMS - RMS detection

BANDEGE (HIGH CHANNEL, CH 11)

HORIZONTAL RESULT

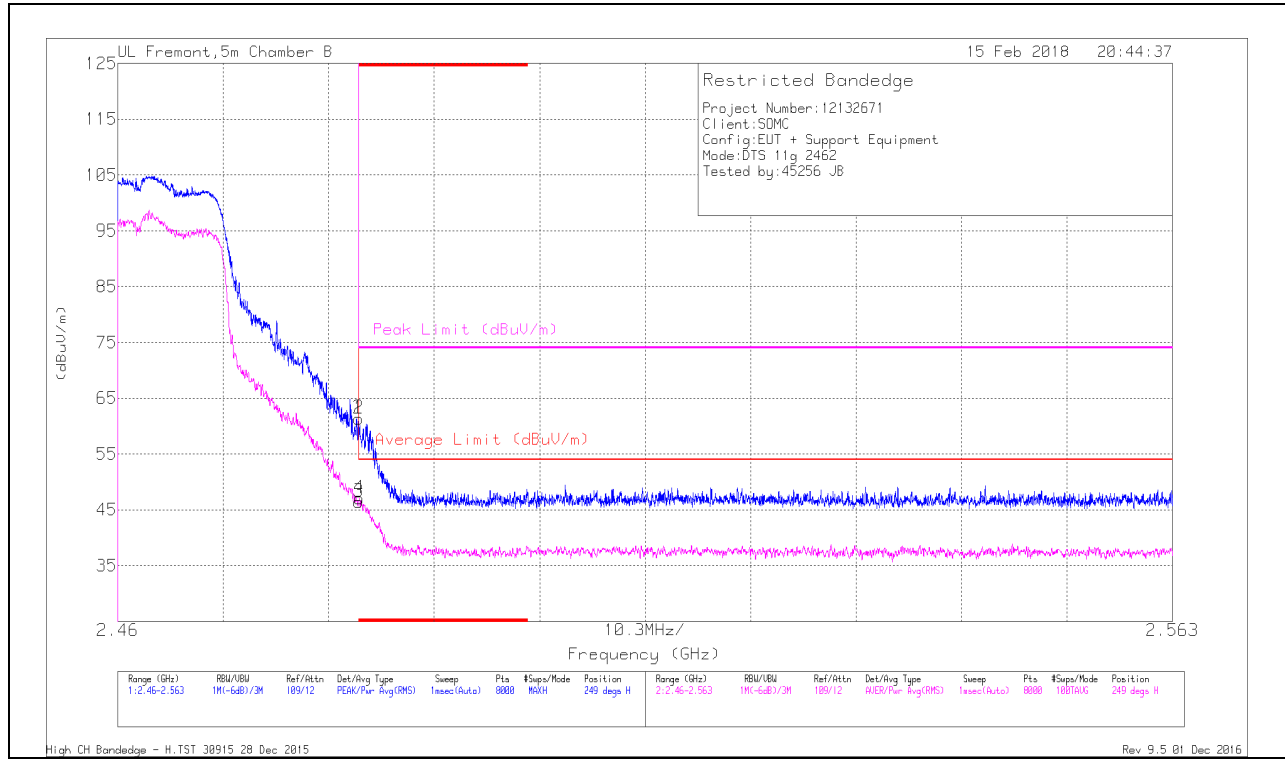

Marker	Frequency (GHz)	Meter Reading (dBuV)	Det	AF T863 (dBm)	Amp/Cb/Fltr/Pad (dB)	DC Corr (dB)	Corrected Reading (dBuV/m)	Average Limit (dBuV/m)	Margin (dB)	Peak Limit (dBuV/m)	PK Margin (dB)	Azimuth (Degs)	Height (cm)	Polarity
1	* 2.484	50.12	Pk	32.5	-21.3	0	61.32	-	-	74	-12.68	249	120	H
2	* 2.484	50.2	Pk	32.5	-21.3	0	61.4	-	-	74	-12.6	249	120	H
3	* 2.484	35.28	RMS	32.5	-21.3	0	46.48	54	-7.52	-	-	249	120	H
4	* 2.484	35.84	RMS	32.5	-21.3	0	47.04	54	-6.96	-	-	249	120	H

* - indicates frequency in CFR47 Pt 15 - Restricted Band
 Pk - Peak detector
 RMS - RMS detection

VERTICAL RESULT

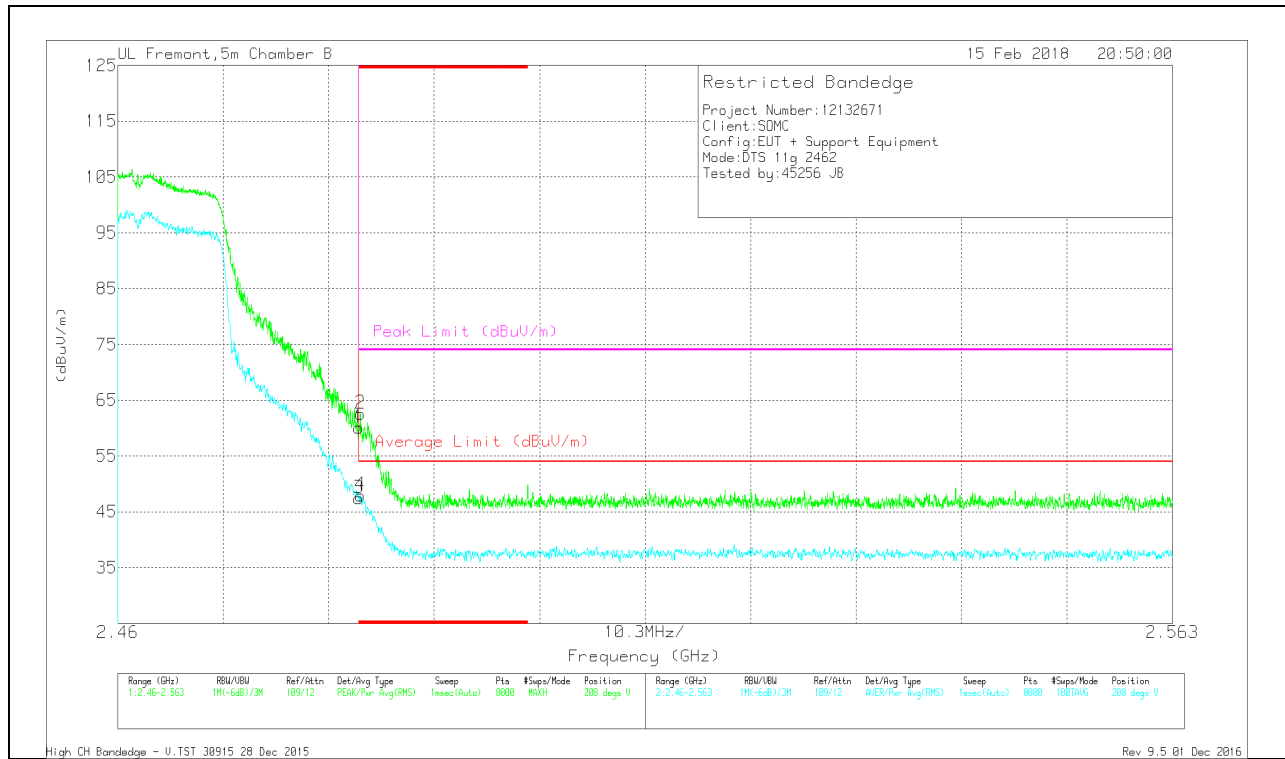

Marker	Frequency (GHz)	Meter Reading (dBuV)	Det	AF T863 (dB/m)	Amp/CbW/Ftr/Pad (dB)	DC Cor (dB)	Corrected Reading (dBuV/m)	Average Limit (dBuV/m)	Margin (dB)	Peak Limit (dBuV/m)	PK Margin (dB)	Azimuth (Degs)	Height (cm)	Polarity
1	* 2.484	48.86	Pk	32.5	-21.3	0	60.06	-	-	74	-13.94	208	186	V
2	* 2.484	51.44	PK	32.5	-21.3	0	62.64	-	-	74	-11.36	208	186	V
3	* 2.484	36.19	RMS	32.5	-21.3	0	47.39	54	-6.61	-	-	208	186	V
4	* 2.484	36.79	RMS	32.5	-21.3	0	47.99	54	-6.01	-	-	208	186	V

* - indicates frequency in CFR47 Pt 15 - Restricted Band
 Pk - Peak detector
 RMS - RMS detection

BANDEGE (HIGH CHANNEL, CH 12)

HORIZONTAL RESULT

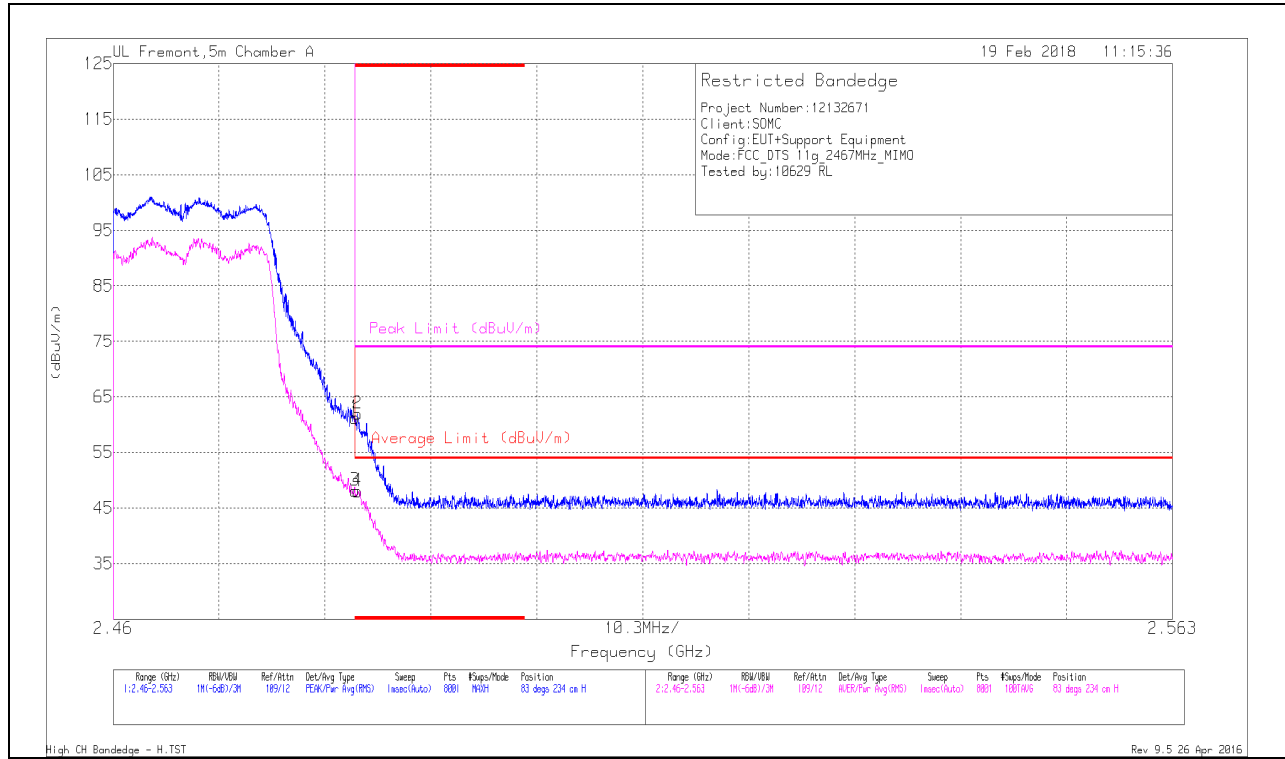

Marker	Frequency (GHz)	Meter Reading (dBuV)	Det	AF T862 (dB/m)	Amp/Cbl/Fitr/P ad (dB)	DC Corr (dB)	Corrected Reading (dBuV/m)	Average Limit (dBuV/m)	Margin (dB)	Peak Limit (dBuV/m)	PK Margin (dB)	Azimuth (Degs)	Height (cm)	Polarity
1	* 2.484	52.16	Pk	32.3	-23.2	0	61.26	-	-	74	-12.74	83	234	H
2	* 2.484	52.87	Pk	32.3	-23.2	0	61.97	-	-	74	-12.03	83	234	H
3	* 2.484	39.06	RMS	32.3	-23.2	0	48.16	54	-5.84	-	-	83	234	H
4	* 2.484	38.94	RMS	32.3	-23.2	0	48.04	54	-5.96	-	-	83	234	H

* - indicates frequency in CFR47 Pt 15 - Restricted Band
 Pk - Peak detector
 RMS - RMS detection

VERTICAL RESULT

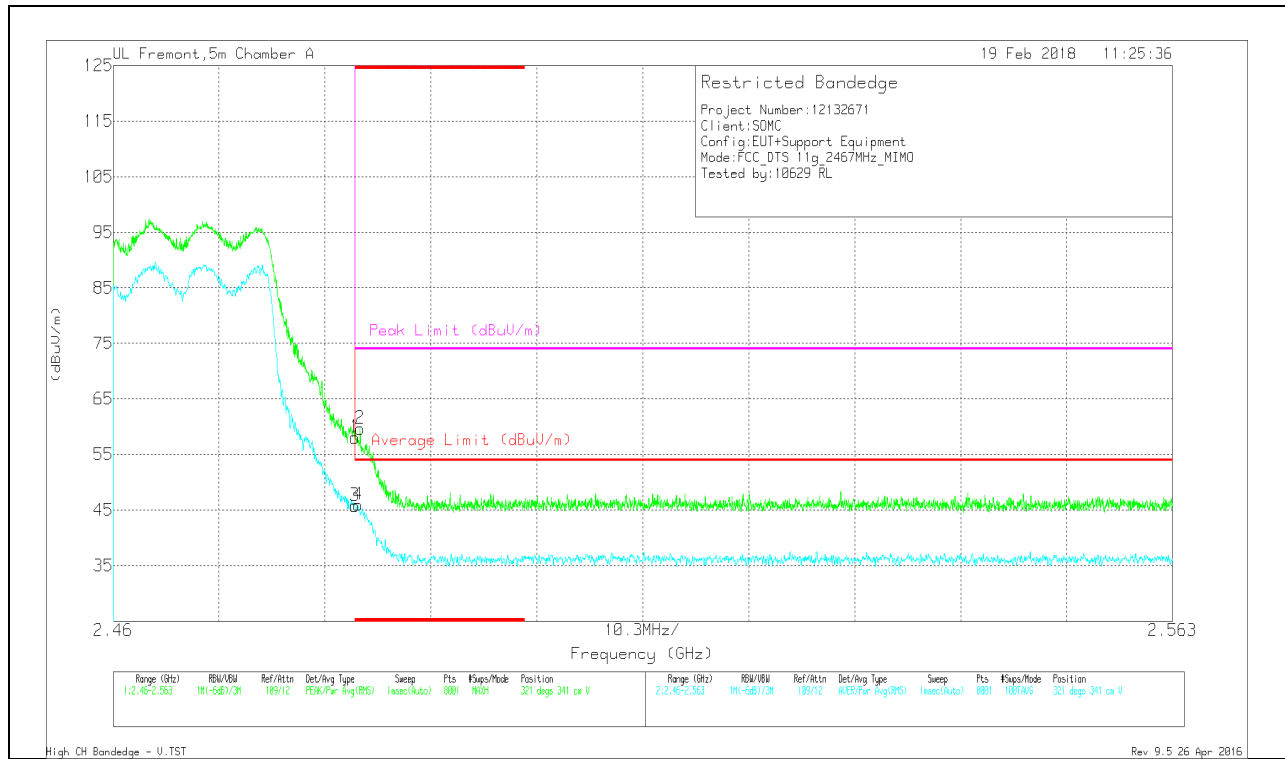

Marker	Frequency (GHz)	Meter Reading (dBuV)	Det	AF T862 (dB/m)	Amp/Cbl/Filtr/Parad (dB)	DC Corr (dB)	Corrected Reading (dBuV/m)	Average Limit (dBuV/m)	Margin (dB)	Peak Limit (dBuV/m)	PK Margin (dB)	Azimuth (Degs)	Height (cm)	Polarity
1	* 2.484	48.99	Pk	32.3	-23.2	0	58.09	-	-	74	-15.91	321	341	V
2	* 2.484	50.59	Pk	32.3	-23.2	0	59.69	-	-	74	-14.31	321	341	V
3	* 2.484	36.69	RMS	32.3	-23.2	0	45.79	54	-8.21	-	-	321	341	V
4	* 2.484	36.85	RMS	32.3	-23.2	0	45.95	54	-8.05	-	-	321	341	V

* - indicates frequency in CFR47 Pt 15 - Restricted Band
 Pk - Peak detector
 RMS - RMS detection

BANDEDGE (HIGH CHANNEL, CH 13)

HORIZONTAL RESULT

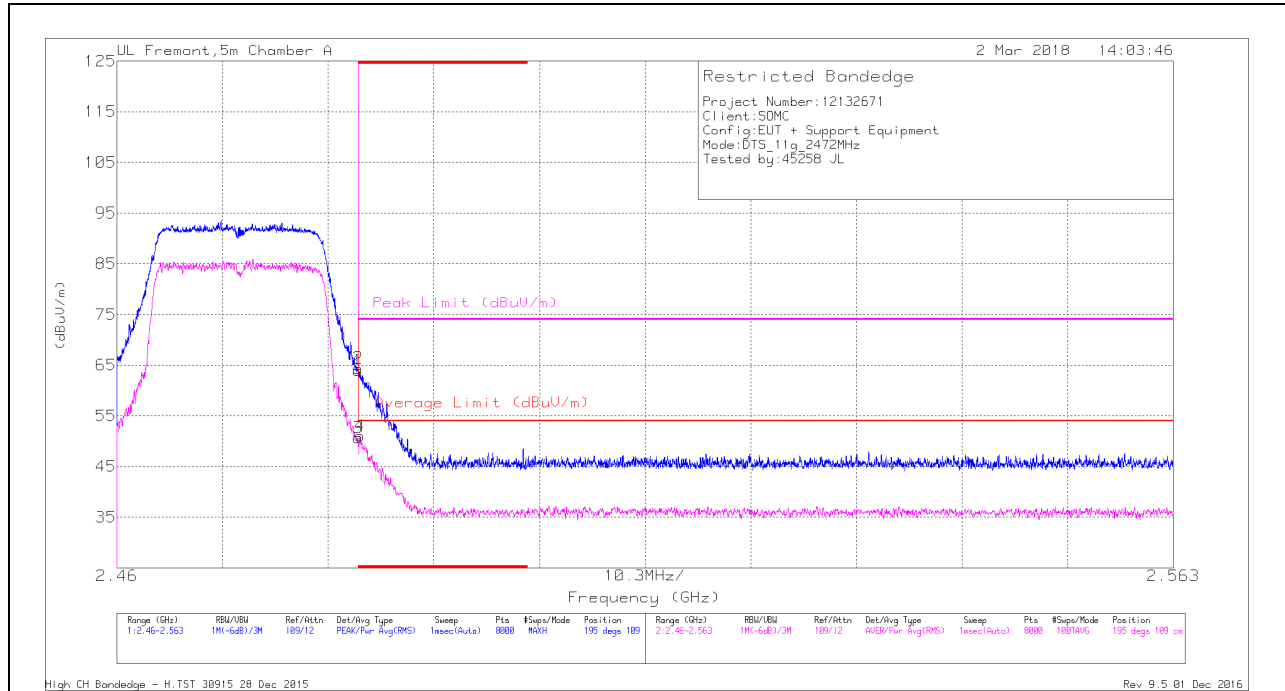

Marker	Frequency (GHz)	Meter Reading (dBuV)	Det	AF T862 (dBm)	Amp/Cbl/Fitr/Pad (dB)	DC Corr (dB)	Corrected Reading (dBuV/m)	Average Limit (dBuV/m)	Margin (dB)	Peak Limit (dBuV/m)	PK Margin (dB)	Azimuth (Degs)	Height (cm)	Polarity
1	* 2.484	55.02	Pk	32.3	-23.4	0	63.92	-	-	74	-10.08	195	109	H
2	* 2.484	55.48	Pk	32.3	-23.4	0	64.38	-	-	74	-9.62	195	109	H
3	* 2.484	41.74	RMS	32.3	-23.4	0	50.64	54	-3.36	-	-	195	109	H
4	* 2.484	42.09	RMS	32.3	-23.4	0	50.99	54	-3.01	-	-	195	109	H

* - indicates frequency in CFR47 Pt 15 - Restricted Band
 Pk - Peak detector
 RMS - RMS detection

VERTICAL RESULT

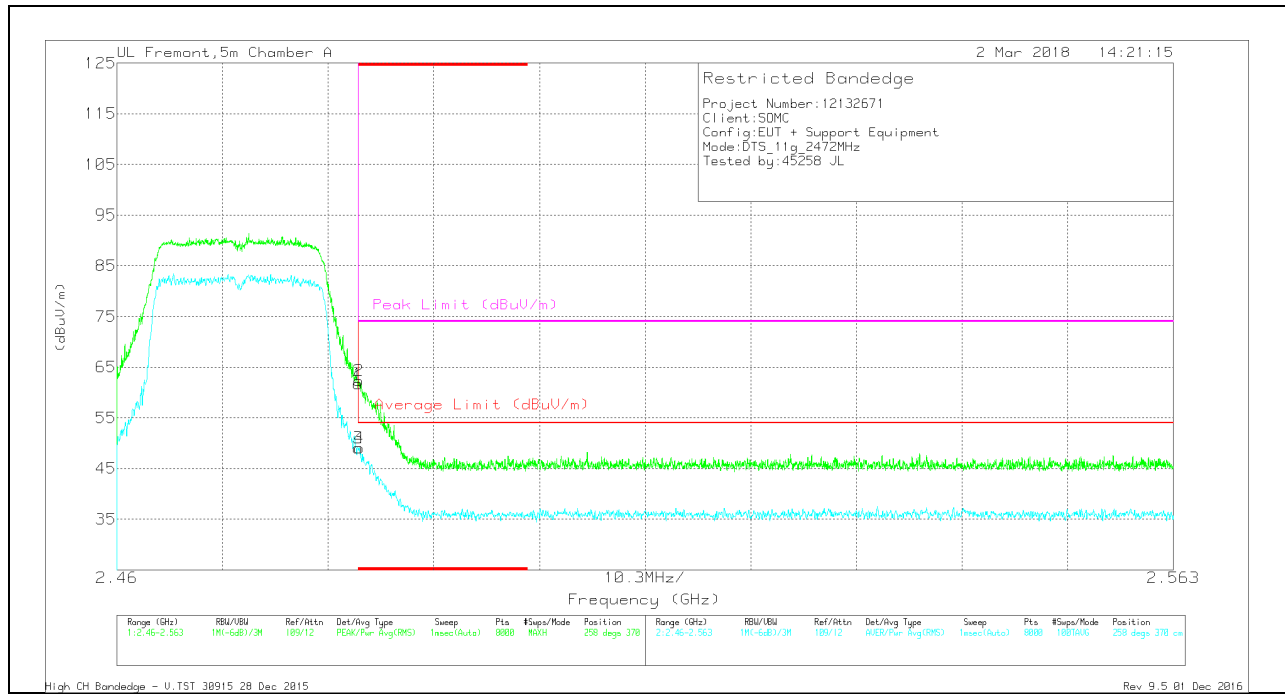

Marker	Frequency (GHz)	Meter Reading (dBuV)	Det	AF T862 (dB/m)	Amp/Cbl/Filtr/P ad (dB)	DC Corr (dB)	Corrected Reading (dBuV/m)	Average Limit (dBuV/m)	Margin (dB)	Peak Limit (dBuV/m)	PK Margin (dB)	Azimuth (Degs)	Height (cm)	Polarity
1	* 2.484	52.8	Pk	32.3	-23.4	0	61.7	-	-	74	-12.3	258	370	V
2	* 2.484	53.48	Pk	32.3	-23.4	0	62.38	-	-	74	-11.62	258	370	V
3	* 2.484	40.15	RMS	32.3	-23.4	0	49.05	54	-4.95	-	-	258	370	V
4	* 2.484	40.11	RMS	32.3	-23.4	0	49.01	54	-4.99	-	-	258	370	V

* - indicates frequency in CFR47 Pt 15 - Restricted Band
 Pk - Peak detector
 RMS - RMS detection

HARMONICS AND SPURIOUS EMISSIONS

LOW CHANNEL, CH 1 RESULTS

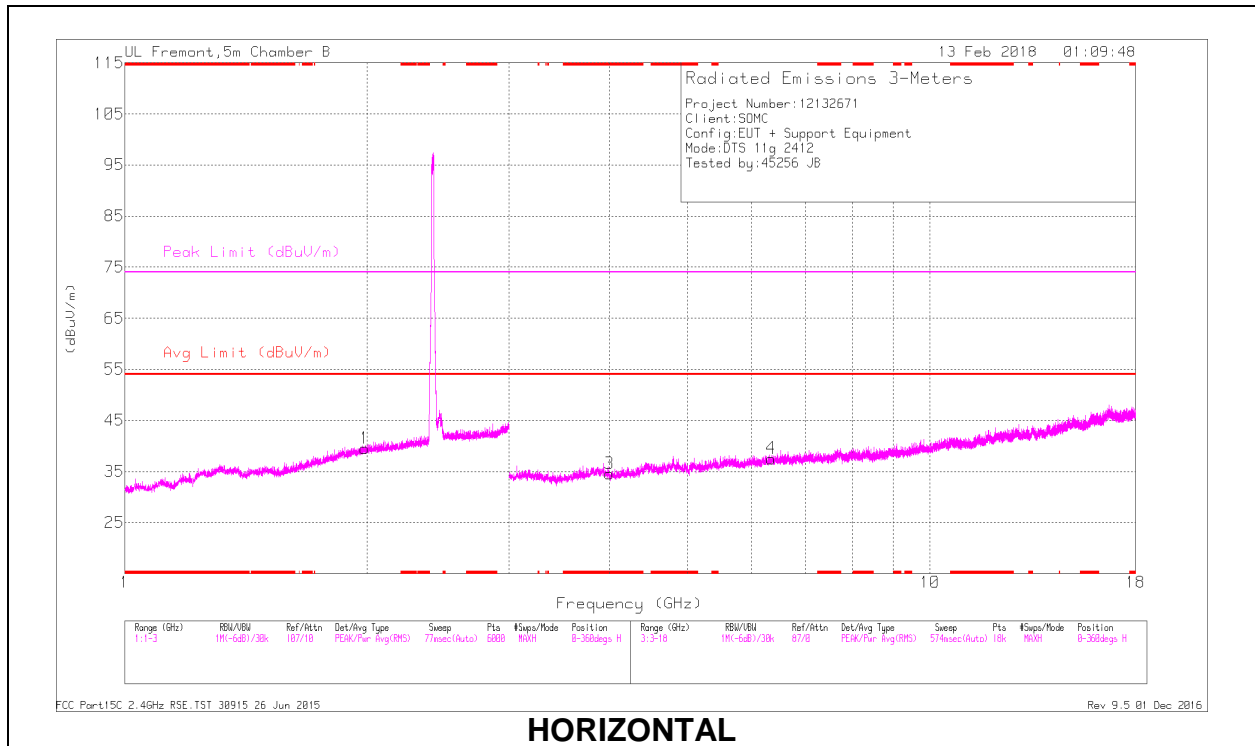

HORIZONTAL

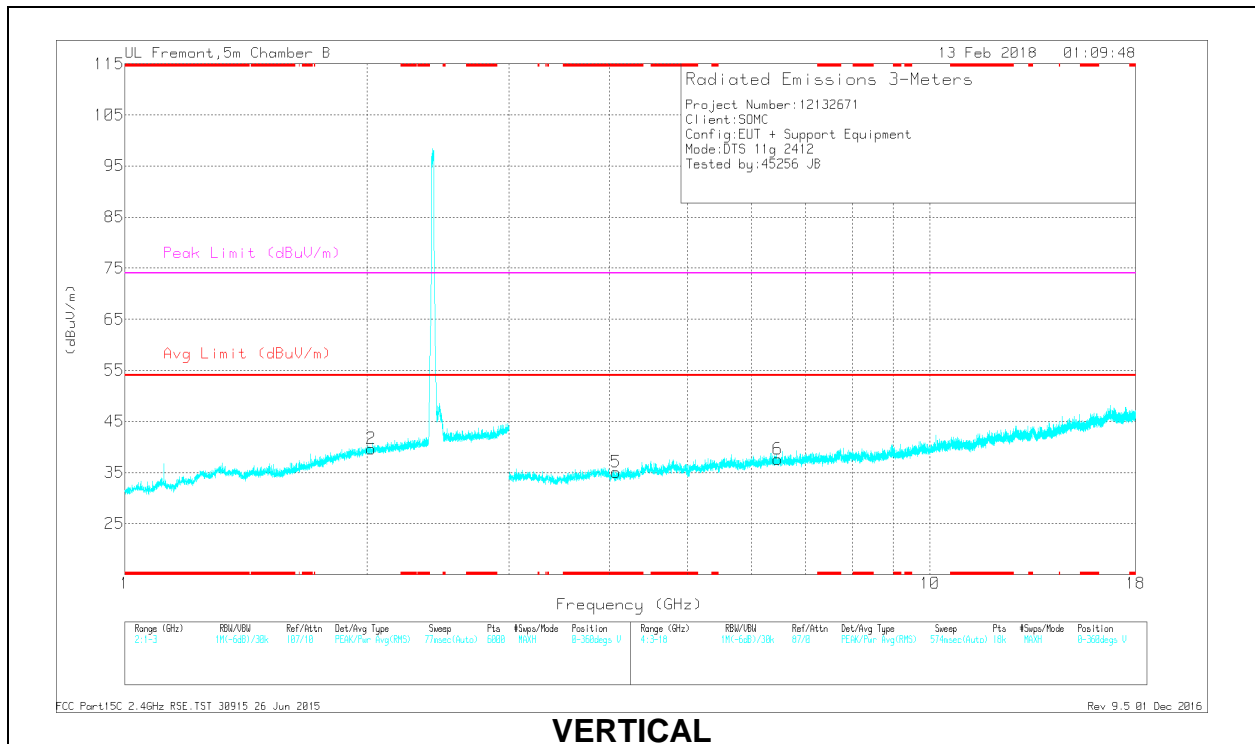

VERTICAL

RADIATED EMISSIONS

Trace Markers

Marker	Frequency (GHz)	Meter Reading (dBuV)	Det	AF T863 (dB/m)	Amp/Cbl/Fitr/Pad (dB)	DC Corr (dB)	Corrected Reading (dBuV/m)	Avg Limit (dBuV/m)	Margin (dB)	Peak Limit (dBuV/m)	PK Margin (dB)	Azimuth (Degs)	Height (cm)	Polarity
3	* 3.999	32.52	Pk	33.5	-31.5	0	34.52	-	-	74	-39.48	0-360	102	H
5	* 4.073	33.04	Pk	33.5	-31.5	0	35.04	-	-	74	-38.96	0-360	102	V
1	1.985	29.39	Pk	31.2	-21.1	0	39.49	-	-	-	-	0-360	199	H
2	2.025	29.44	Pk	31.4	-21.2	0	39.64	-	-	-	-	0-360	200	V
4	6.345	31.74	Pk	35.7	-29.9	0	37.54	-	-	-	-	0-360	102	H
6	6.473	31.2	Pk	35.7	-29.3	0	37.6	-	-	-	-	0-360	200	V

* - indicates frequency in CFR47 Pt 15 - Restricted Band
 Pk - Peak detector

Radiated Emissions

Frequency (GHz)	Meter Reading (dBuV)	Det	AF T863 (dB/m)	Amp/Cbl/Fitr/Pad (dB)	DC Corr (dB)	Corrected Reading (dBuV/m)	Avg Limit (dBuV/m)	Margin (dB)	Peak Limit (dBuV/m)	PK Margin (dB)	Azimuth (Degs)	Height (cm)	Polarity
* 4	36.84	PK2	33.5	-31.6	0	38.74	-	-	74	-35.26	0	265	H
* 3.999	25.81	MAV1	33.5	-31.5	0	27.81	54	-26.19	-	-	0	265	H
* 4.075	36.28	PK2	33.5	-31.5	0	38.28	-	-	74	-35.72	151	199	V
* 4.075	25.23	MAV1	33.5	-31.5	0	27.23	54	-26.77	-	-	151	199	V

* - indicates frequency in CFR47 Pt 15 - Restricted Band
 PK2 - KDB558074 Method: Maximum Peak
 MAV1 - KDB558074 Option 1 Maximum RMS Average

MID CHANNEL, CH 6 RESULTS

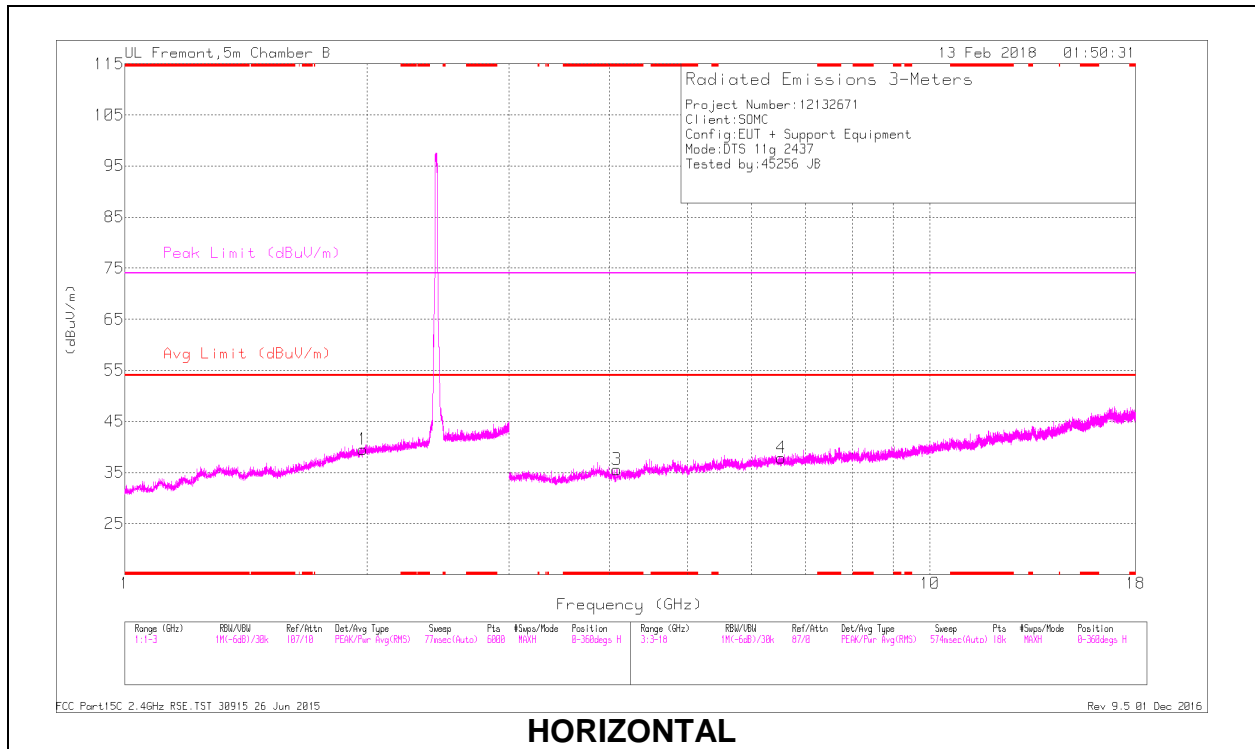

HORIZONTAL

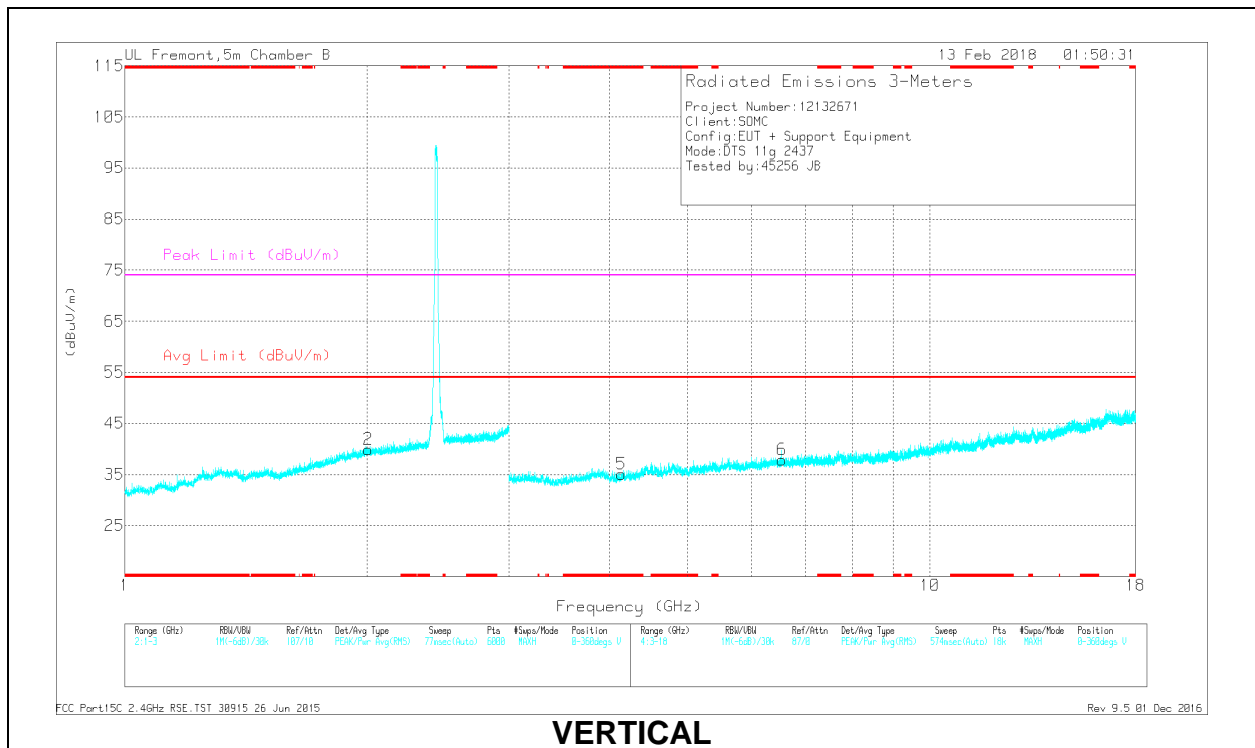

VERTICAL

RADIATED EMISSIONS

Trace Markers

Marker	Frequency (GHz)	Meter Reading (dBuV)	Det	AF T863 (dB/m)	Amp/Cbl/Fitr/Pad (dB)	DC Corr (dB)	Corrected Reading (dBuV/m)	Avg Limit (dBuV/m)	Margin (dB)	Peak Limit (dBuV/m)	PK Margin (dB)	Azimuth (Degs)	Height (cm)	Polarity
3	* 4.084	33.46	Pk	33.5	-31.4	0	35.56	-	-	74	-38.44	0-360	199	H
5	* 4.134	32.36	Pk	33.4	-30.7	0	35.06	-	-	74	-38.94	0-360	200	V
1	1.975	29.25	Pk	31.2	-21	0	39.45	-	-	-	-	0-360	199	H
2	2.005	29.8	Pk	31.3	-21.2	0	39.9	-	-	-	-	0-360	99	V
4	6.538	31.33	Pk	35.7	-29.2	0	37.83	-	-	-	-	0-360	199	H
6	6.546	31.27	Pk	35.7	-29.1	0	37.87	-	-	-	-	0-360	200	V

* - indicates frequency in CFR47 Pt 15 / IC RSS-Restricted Band
 Pk - Peak detector

Radiated Emissions

Market	Frequency (GHz)	Meter Reading (dBuV)	Det	AF T863 (dB/m)	Amp/Cbl/Fitr/Pad (dB)	DC Corr (dB)	Corrected Reading (dBuV/m)	Avg Limit (dBuV/m)	Margin (dB)	Peak Limit (dBuV/m)	PK Margin (dB)	Azimuth (Degs)	Height (cm)	Polarity
3	* 4.083	37.57	PK2	33.5	-31.4	0	39.67	-	-	74	-34.33	172	184	H
	* 4.086	25.59	MAv1	33.5	-31.4	0	27.69	54	-26.31	-	-	172	184	H
5	* 4.135	36.66	PK2	33.4	-30.7	0	39.36	-	-	74	-34.64	92	123	V
	* 4.136	24.84	MAv1	33.4	-30.7	0	27.54	54	-26.46	-	-	92	123	V

* - indicates frequency in CFR47 Pt 15 - Restricted Band
 PK2 - KDB558074 Method: Maximum Peak
 MAv1 - KDB558074 Option 1 Maximum RMS Average

HIGH CHANNEL, CH 11 RESULTS

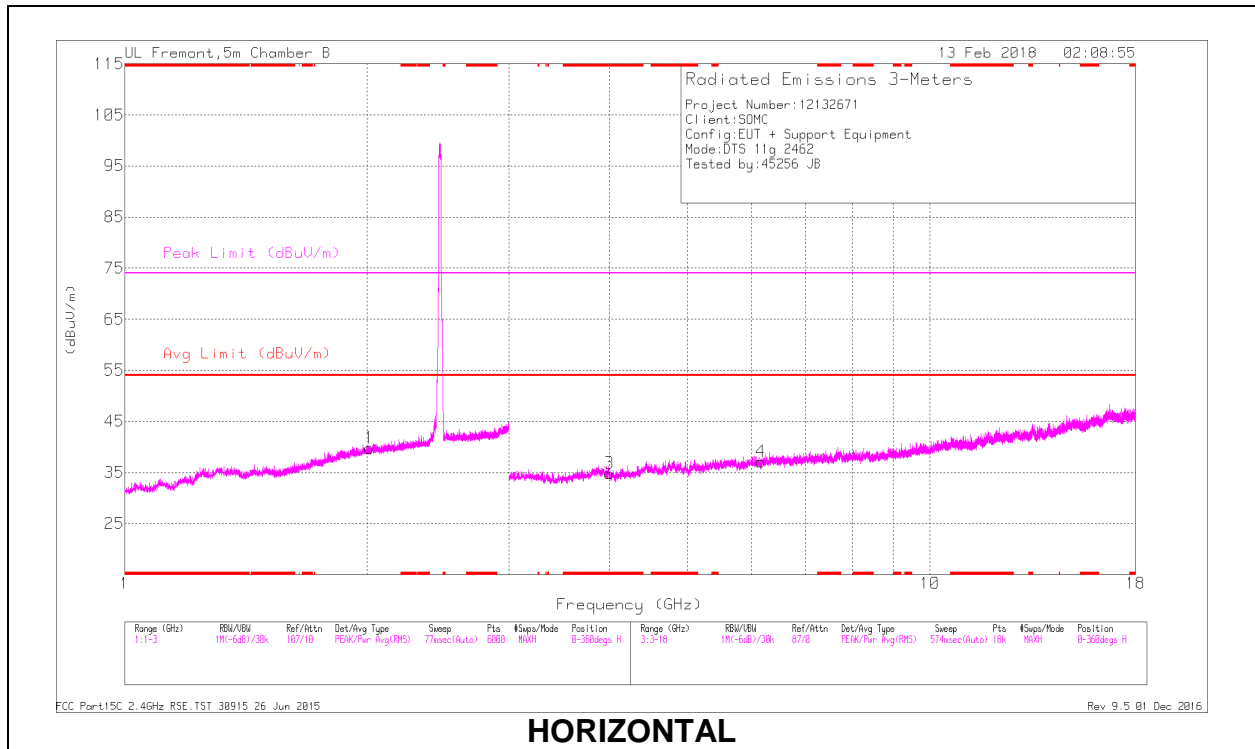

HORIZONTAL

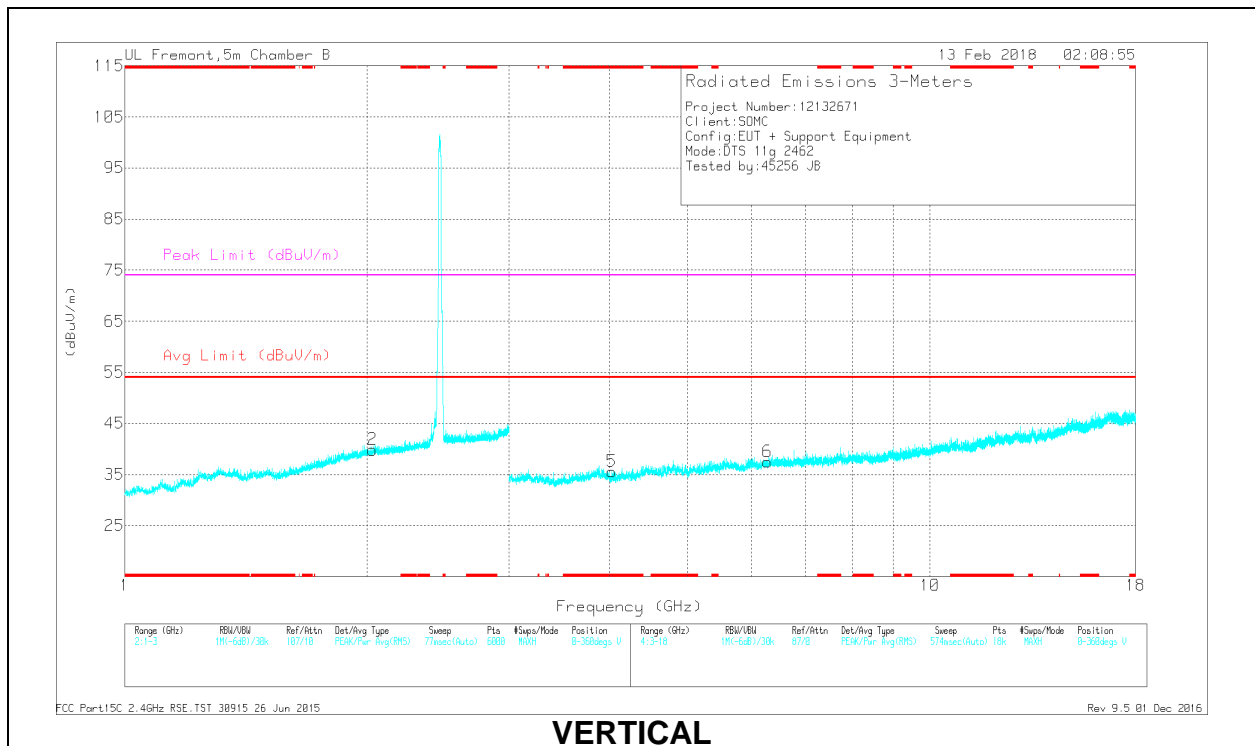

VERTICAL

RADIATED EMISSIONS

Trace Markers

Marker	Frequency (GHz)	Meter Reading (dBuV)	Det	AF T863 (dB/m)	Amp/Cbl/Fitr/Pad (dB)	DC Corr (dB)	Corrected Reading (dBuV/m)	Avg Limit (dBuV/m)	Margin (dB)	Peak Limit (dBuV/m)	PK Margin (dB)	Azimuth (Degs)	Height (cm)	Polarity
3	* 3.999	32.85	Pk	33.5	-31.5	0	34.85	-	-	74	-39.15	0-360	102	H
5	* 4.027	33.56	Pk	33.5	-31.5	0	35.56	-	-	74	-38.44	0-360	102	V
1	2.014	29.53	Pk	31.3	-21.1	0	39.73	-	-	-	-	0-360	102	H
2	2.03	29.63	Pk	31.4	-21.2	0	39.83	-	-	-	-	0-360	199	V
4	6.167	31.55	Pk	35.6	-30.1	0	37.05	-	-	-	-	0-360	102	H
6	6.284	31.42	Pk	35.7	-29.7	0	37.42	-	-	-	-	0-360	200	V

* - indicates frequency in CFR47 Pt 15 / IC RSS-Restricted Band
 Pk - Peak detector

Radiated Emissions

Marker	Frequency (GHz)	Meter Reading (dBuV)	Det	AF T863 (dB/m)	Amp/Cbl/Fitr/Pad (dB)	DC Corr (dB)	Corrected Reading (dBuV/m)	Avg Limit (dBuV/m)	Margin (dB)	Peak Limit (dBuV/m)	PK Margin (dB)	Azimuth (Degs)	Height (cm)	Polarity
3	* 3.999	37.17	PK2	33.5	-31.5	0	39.17	-	-	74	-34.83	131	117	H
	* 4.001	25.38	MAv1	33.5	-31.6	0	27.28	54	-26.72	-	-	131	117	H
5	* 4.027	36.88	PK2	33.5	-31.5	0	38.88	-	-	74	-35.12	167	251	V
	* 4.026	25.58	MAv1	33.5	-31.5	0	27.58	54	-26.42	-	-	167	251	V

* - indicates frequency in CFR47 Pt 15 - Restricted Band
 PK2 - KDB558074 Method: Maximum Peak
 MAv1 - KDB558074 Option 1 Maximum RMS Average

9.1.3. TX ABOVE 1 GHz 802.11n HT20 MODE IN THE 2.4 GHz BAND

BANDEDGE (LOW CHANNEL, CH 1)

HORIZONTAL RESULT

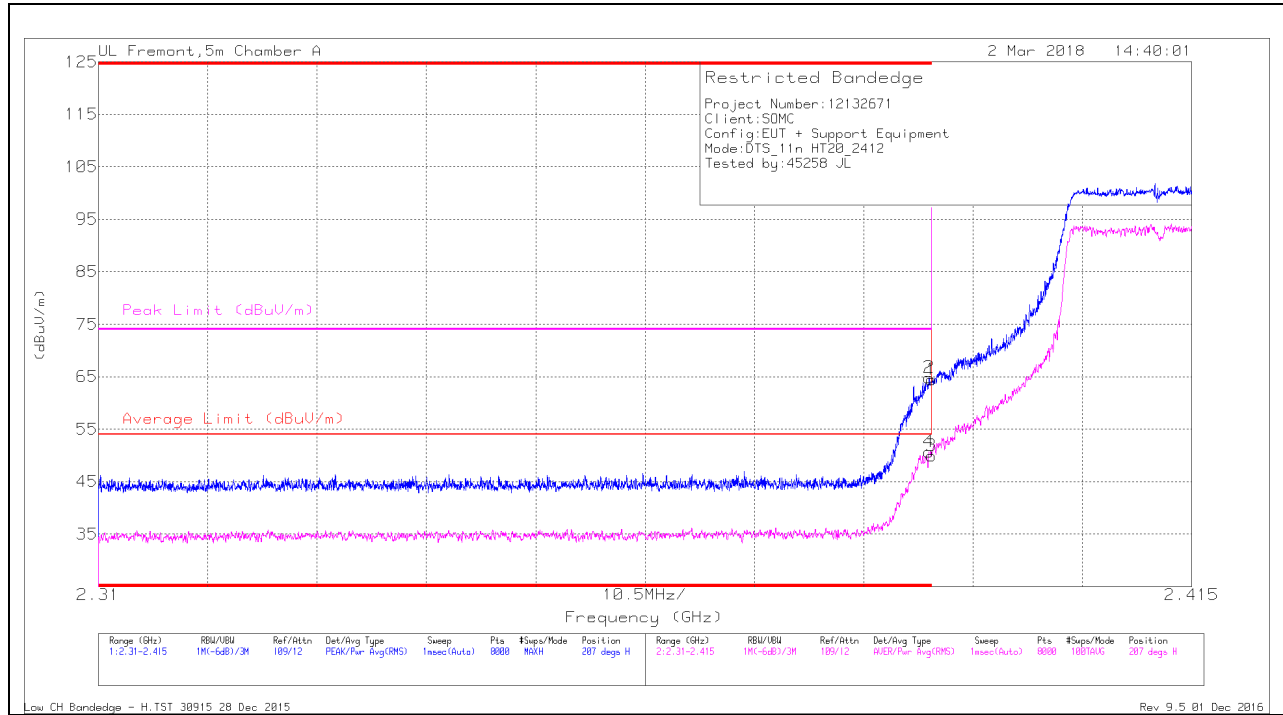

Marker	Frequency (GHz)	Meter Reading (dBuV)	Det	AF T862 (dBm)	Amp/Cb/Filt/Pad (dB)	DC Corr (dB)	Corrected Reading (dBuV/m)	Average Limit (dBuV/m)	Margin (dB)	Peak Limit (dBuV/m)	PK Margin (dB)	Azimuth (Degs)	Height (cm)	Polarity
1	* 2.39	56.1	Pk	31.8	-23.5	0	64.4	-	-	74	-9.6	207	315	H
2	* 2.39	56.54	Pk	31.8	-23.5	0	64.84	-	-	74	-9.16	207	315	H
3	* 2.39	41.47	RMS	31.8	-23.5	.1	49.87	54	-4.13	-	-	207	315	H
4	* 2.39	42.29	RMS	31.8	-23.5	.1	50.69	54	-3.31	-	-	207	315	H

* - indicates frequency in CFR47 Pt 15 - Restricted Band
 Pk - Peak detector
 RMS - RMS detection

VERTICAL RESULT

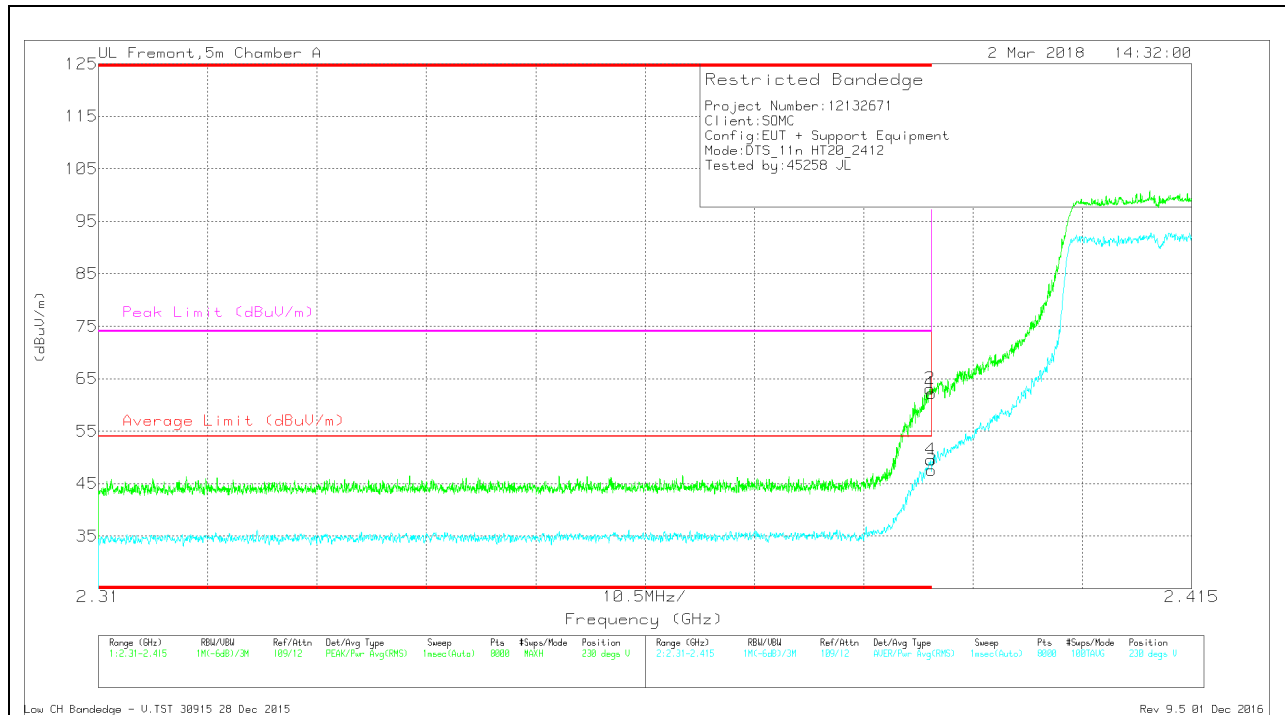

Marker	Frequency (GHz)	Meter Reading (dBuV)	Det	AF T862 (dBm)	Amp/Cb/Filtr/Pad (dB)	DC Corr (dB)	Corrected Reading (dBuV/m)	Average Limit (dBuV/m)	Margin (dB)	Peak Limit (dBuV/m)	PK Margin (dB)	Azimuth (Degs)	Height (cm)	Polarity
1	* 2.39	53.86	Pk	31.8	-23.5	0	62.16	-	-	74	-11.84	230	313	V
2	* 2.39	54.76	Pk	31.8	-23.5	0	63.06	-	-	74	-10.94	230	313	V
3	* 2.39	39.18	RMS	31.8	-23.5	.1	47.58	54	-6.42	-	-	230	313	V
4	* 2.39	41.2	RMS	31.8	-23.5	.1	49.6	54	-4.4	-	-	230	313	V

* - indicates frequency in CFR47 Pt 15 - Restricted Band
 Pk - Peak detector
 RMS - RMS detection

BANDEDGE (HIGH CHANNEL, CH 11)

HORIZONTAL RESULT

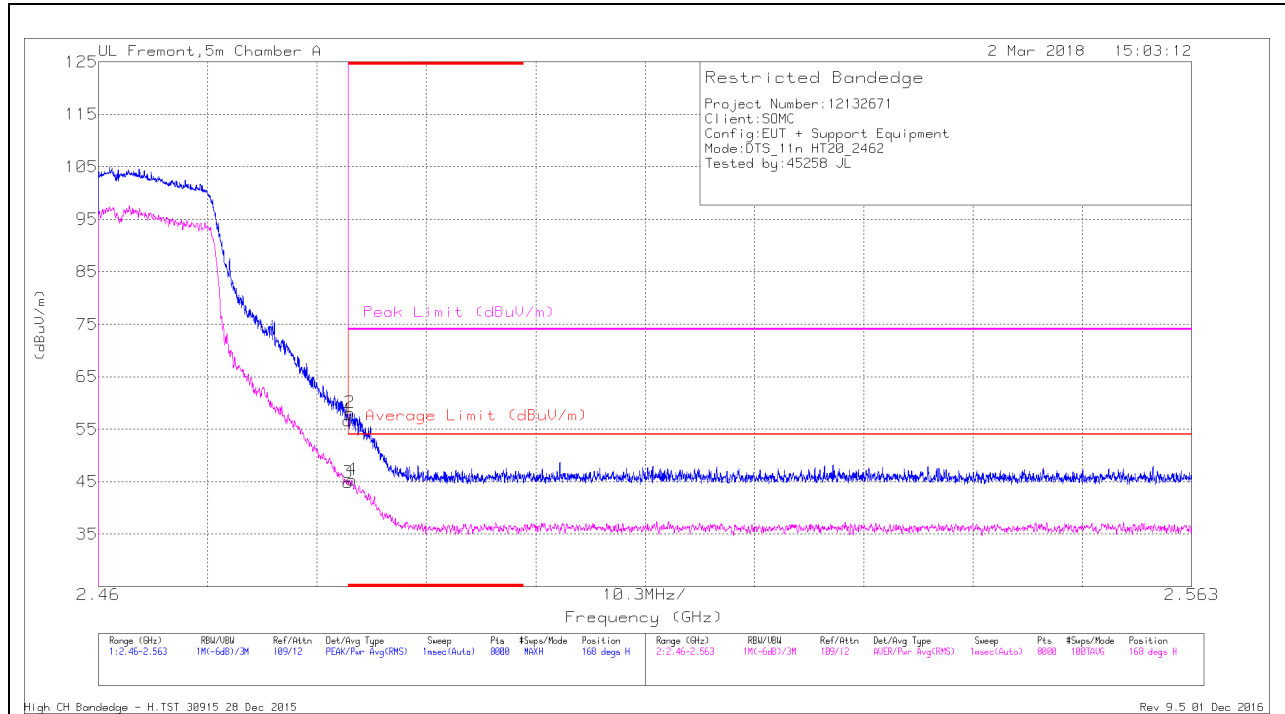

Marker	Frequency (GHz)	Meter Reading (dBuV)	Det	AF T862 (dBm)	Amp/Cb/Filtr/Pad (dB)	DC Corr (dB)	Corrected Reading (dBuV/m)	Average Limit (dBuV/m)	Margin (dB)	Peak Limit (dBuV/m)	PK Margin (dB)	Azimuth (Degs)	Height (cm)	Polarity
1	* 2.484	47.66	Pk	32.3	-23.4	0	56.56	-	-	74	-17.42	168	128	H
2	* 2.484	49.23	Pk	32.3	-23.4	0	58.13	-	-	74	-15.67	168	128	H
3	* 2.484	35.8	RMS	32.3	-23.4	-1	44.8	54	-9.2	-	-	168	128	H
4	* 2.484	36.28	RMS	32.3	-23.4	-1	45.28	54	-8.72	-	-	168	128	H

* - indicates frequency in CFR47 Pt 15 - Restricted Band

Pk - Peak detector

RMS - RMS detection

VERTICAL RESULT

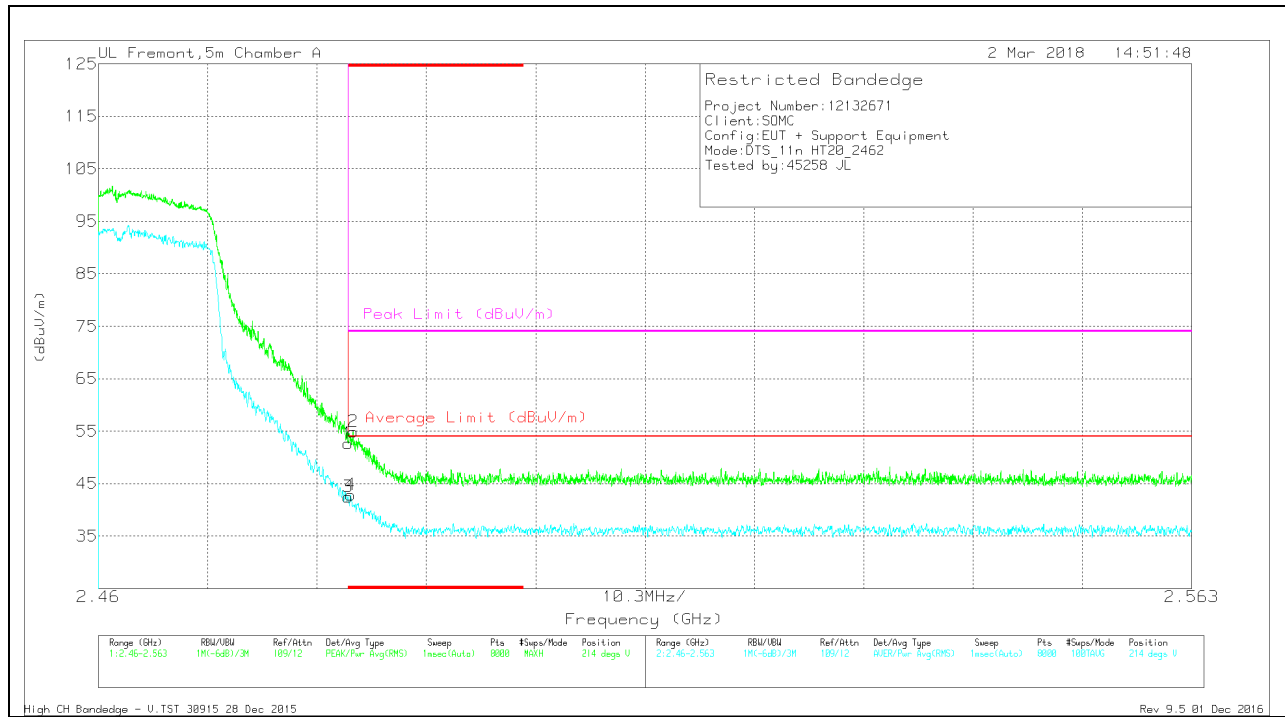

Marker	Frequency (GHz)	Meter Reading (dBuV)	Det	AF T862 (dBm)	Amp/Cb/Filtr/Pad (dB)	DC Corr (dB)	Corrected Reading (dBuV/m)	Average Limit (dBuV/m)	Margin (dB)	Peak Limit (dBuV/m)	PK Margin (dB)	Azimuth (Degs)	Height (cm)	Polarity
1	* 2.484	43.75	Pk	32.3	-23.4	0	52.65	-	-	74	-21.35	214	377	V
2	* 2.484	45.98	Pk	32.3	-23.4	0	54.88	-	-	74	-19.12	214	377	V
3	* 2.484	33.5	RMS	32.3	-23.4	.1	42.5	54	-11.5	-	-	214	377	V
4	* 2.484	33.79	RMS	32.3	-23.4	.1	42.79	54	-11.21	-	-	214	377	V

* - indicates frequency in CFR47 Pt 15 - Restricted Band
 Pk - Peak detector
 RMS - RMS detection

BANDEGE (HIGH CHANNEL, CH 12)

HORIZONTAL RESULT

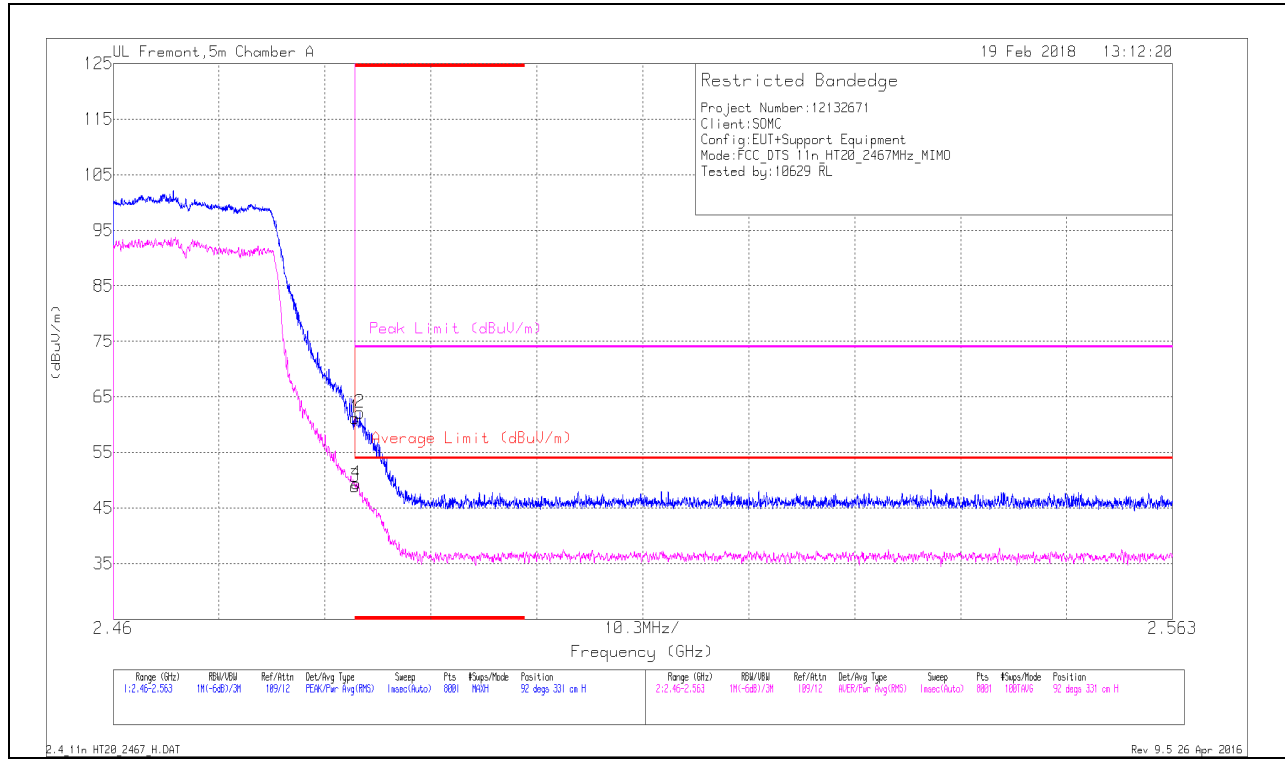

Marker	Frequency (GHz)	Meter Reading (dBuV)	Det	AF T862 (dB/m)	Amp/Cb/Filt/Pad (dB)	DC Corr (dB)	Corrected Reading (dBuV/m)	Average Limit (dBuV/m)	Margin (dB)	Peak Limit (dBuV/m)	PK Margin (dB)	Azimuth (Degs)	Height (cm)	Polarity
1	* 2.484	52.1	Pk	32.3	-23.2	0	61.2	-	-	74	-12.8	92	331	H
2	* 2.484	53.09	Pk	32.3	-23.2	0	62.19	-	-	74	-11.81	92	331	H
3	* 2.484	39.65	RMS	32.3	-23.2	.1	48.85	54	-5.15	-	-	92	331	H
4	* 2.484	40.2	RMS	32.3	-23.2	.1	49.4	54	-4.6	-	-	92	331	H

* - indicates frequency in CFR47 Pt 15 - Restricted Band
 Pk - Peak detector
 RMS - RMS detection

VERTICAL RESULT

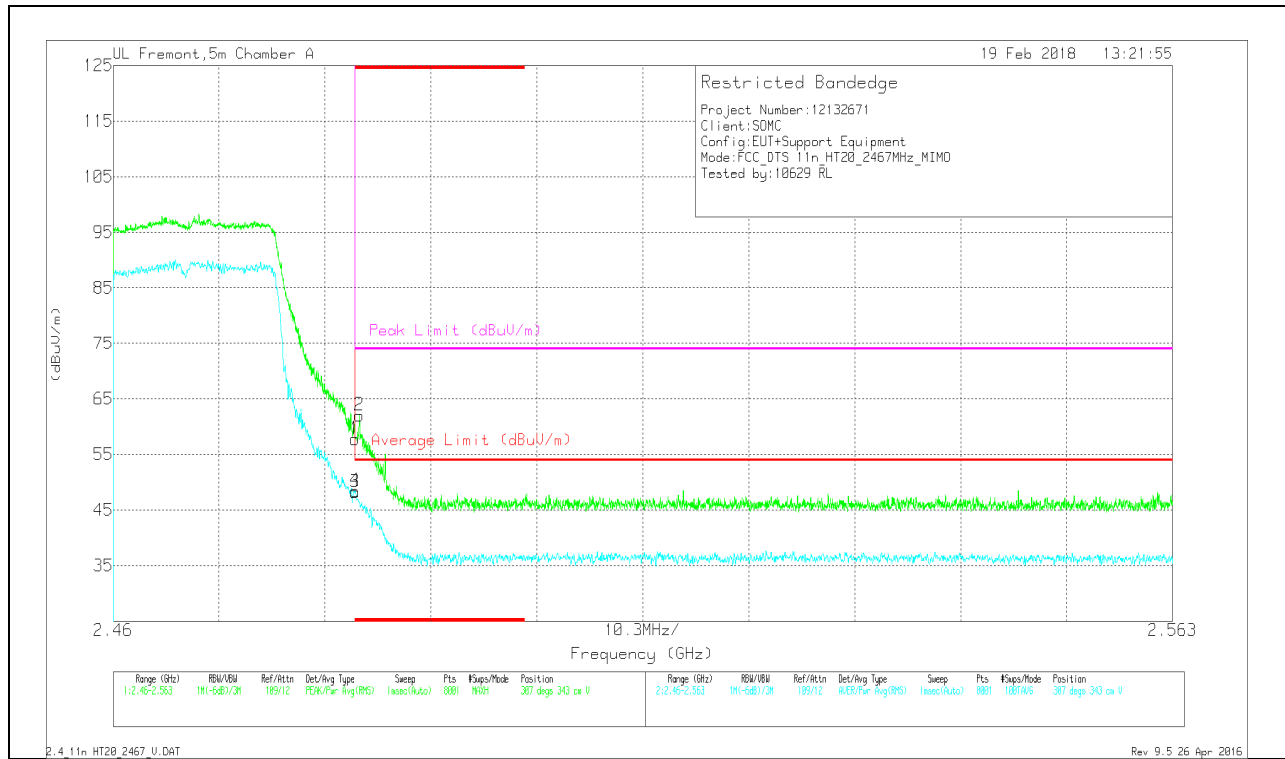

Marker	Frequency (GHz)	Meter Reading (dBuV)	Det	AF T652 (dB/m)	Amp/Cb/Filt/Pad (dB)	DC Corr (dB)	Corrected Reading (dBuV/m)	Average Limit (dBuV/m)	Margin (dB)	Peak Limit (dBuV/m)	PK Margin (dB)	Azimuth (Dege)	Height (cm)	Polarity
1	* 2.484	48.69	Pk	32.3	-23.2	0	57.79	-	-	74	-16.21	307	343	V
2	* 2.484	52.94	Pk	32.3	-23.2	0	62.04	-	-	74	-11.96	307	343	V
3	* 2.484	38.99	RMS	32.3	-23.2	.1	48.19	54	-5.81	-	-	307	343	V
4	* 2.484	39.21	RMS	32.3	-23.2	.1	48.41	54	-5.59	-	-	307	343	V

* - indicates frequency in CFR47 Pt 15 - Restricted Band
 Pk - Peak detector
 RMS - RMS detection

BANDEGE (HIGH CHANNEL, CH 13)

HORIZONTAL RESULT

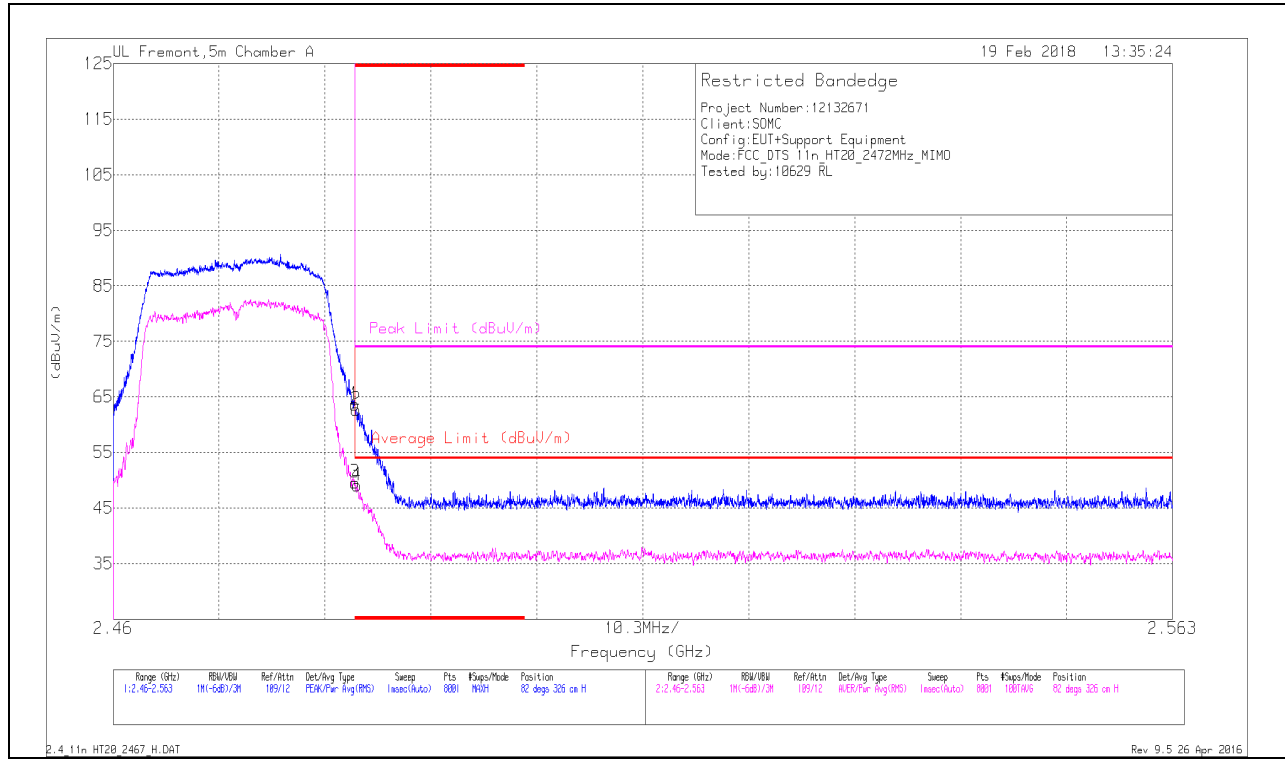

Marker	Frequency (GHz)	Meter Reading (dBu)	Det	AF T862 (dBm)	Amp/Cbi/Fitr/Pad (dB)	DC Corr (dB)	Corrected Reading (dBu/m)	Average Limit (dBu/m)	Margin (dB)	Peak Limit (dBu/m)	PK Margin (dB)	Azimuth (Degs)	Height (cm)	Polarity
1	* 2.484	54.57	Pk	32.3	-23.2	0	63.67	-	-	74	-10.33	82	326	H
2	* 2.484	53.62	Pk	32.3	-23.2	0	62.72	-	-	74	-11.28	82	326	H
3	* 2.484	40.43	RMS	32.3	-23.2	.1	49.63	54	-4.37	-	-	82	326	H
4	* 2.484	39.9	RMS	32.3	-23.2	.1	49.1	54	-4.9	-	-	82	326	H

* - indicates frequency in CFR47 Pt 15 - Restricted Band
 Pk - Peak detector
 RMS - RMS detection

VERTICAL RESULT

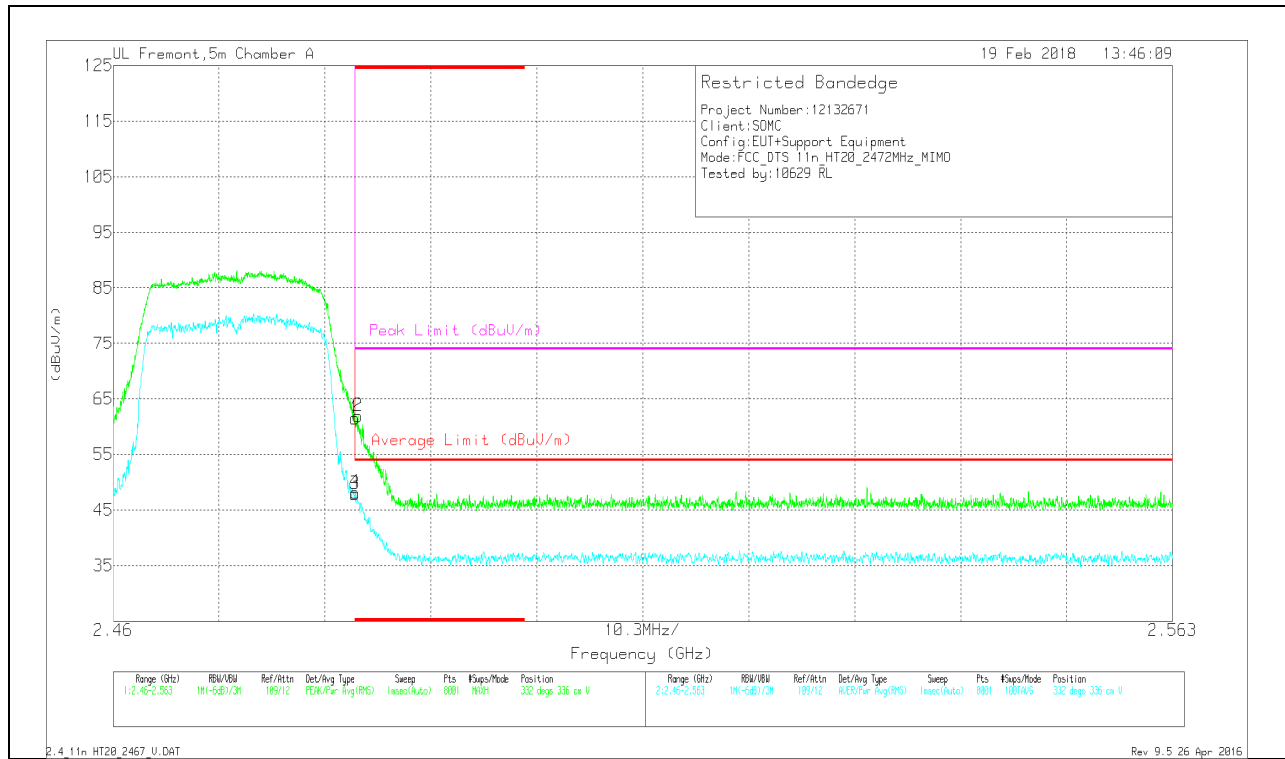

Marker	Frequency (GHz)	Meter Reading (dBuV)	Det	AF T862 (dBm)	Amp/Chl/Filt/Pad (dB)	DC Corr (dB)	Corrected Reading (dBuV/m)	Average Limit (dBuV/m)	Margin (dB)	Peak Limit (dBuV/m)	PK Margin (dB)	Azimuth (Dege)	Height (cm)	Polarity
1	* 2.484	52.43	Pk	32.3	-23.2	0	61.53	-	-	74	-12.47	332	336	V
2	* 2.484	52.83	Pk	32.3	-23.2	0	61.93	-	-	74	-12.07	332	336	V
3	* 2.484	38.71	RMS	32.3	-23.2	.1	47.91	54	-6.09	-	-	332	336	V
4	* 2.484	39	RMS	32.3	-23.2	.1	48.2	54	-5.8	-	-	332	336	V

* - indicates frequency in CFR47 Pt 15 - Restricted Band
 Pk - Peak detector
 RMS - RMS detection

HARMONICS AND SPURIOUS EMISSIONS

LOW CHANNEL, CH 1 RESULTS

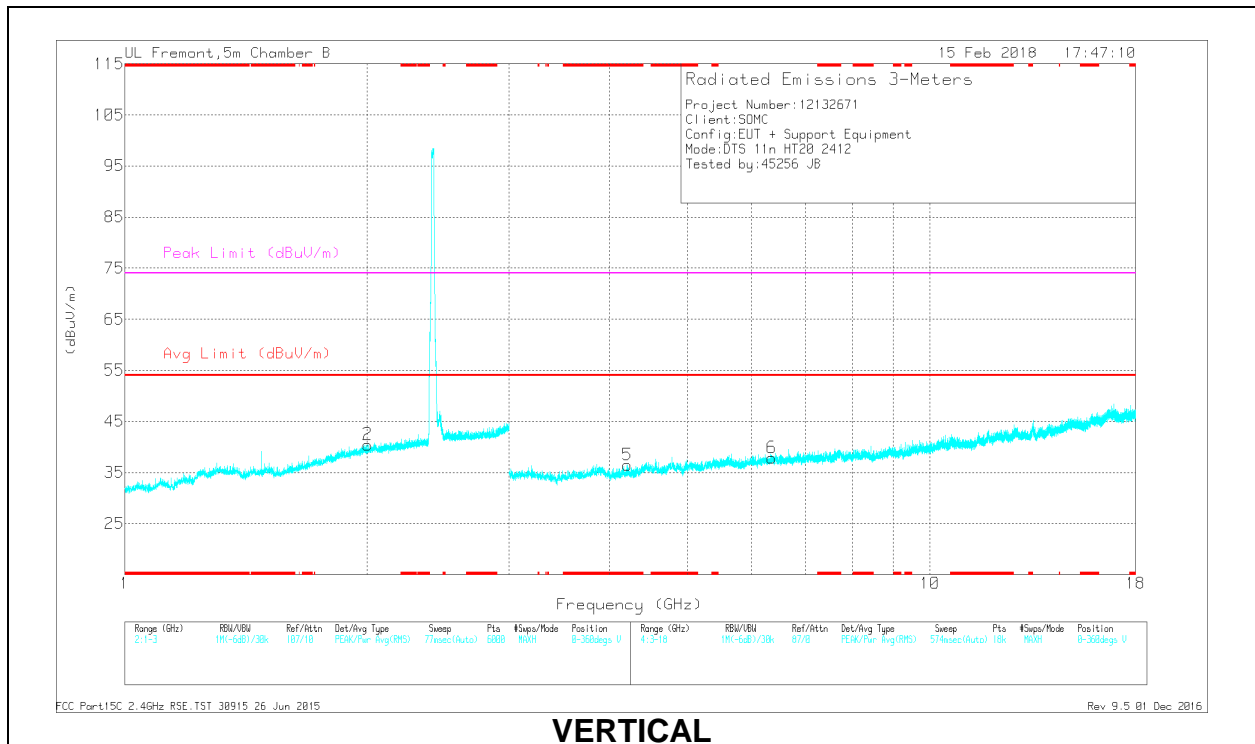
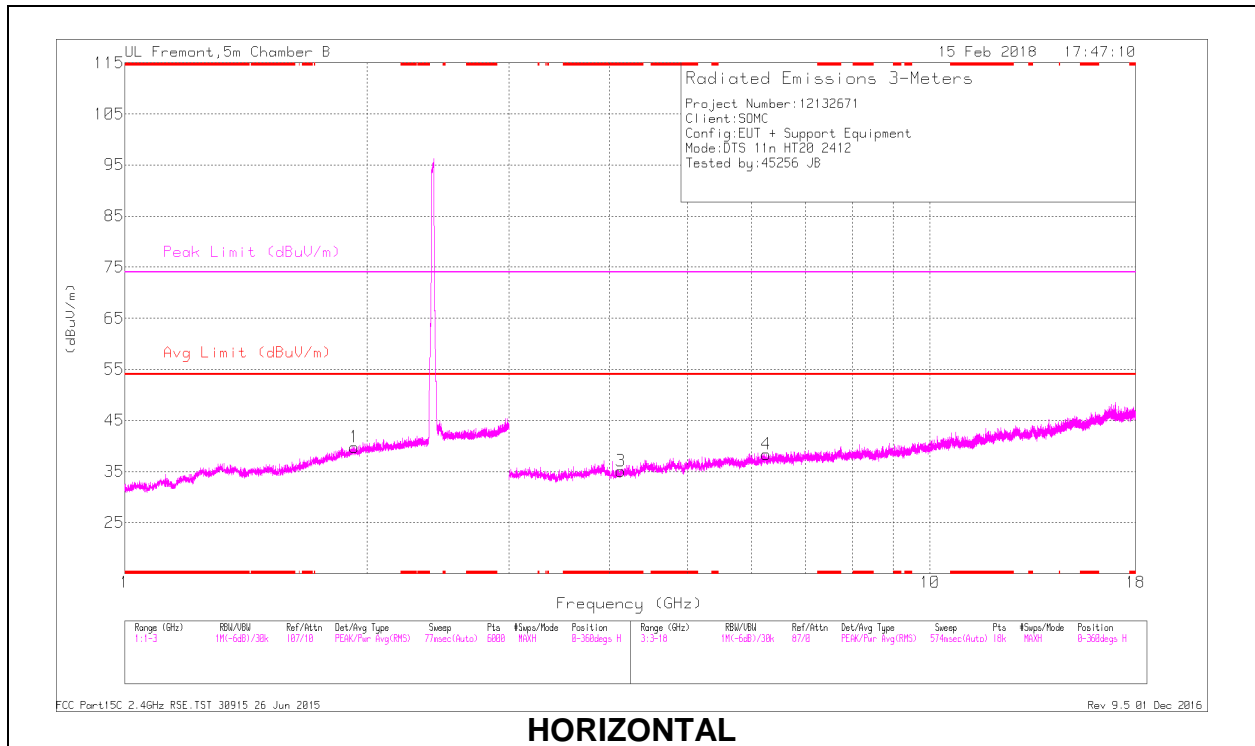

RADIATED EMISSIONS

Trace Markers

Marker	Frequency (GHz)	Meter Reading (dBuV)	Det	AF T863 (dB/m)	Amp/Cbl/Filtr/Pad (dB)	DC Corr (dB)	Corrected Reading (dBuV/m)	Avg Limit (dBuV/m)	Margin (dB)	Peak Limit (dBuV/m)	PK Margin (dB)	Azimuth (Degs)	Height (cm)	Polarity
3	* 4.133	32.52	Pk	33.4	-30.8	0	35.12	-	-	74	-38.88	0-360	199	H
5	* 4.208	33.68	Pk	33.4	-30.6	0	36.48	-	-	74	-37.52	0-360	200	V
1	1.927	29.81	Pk	31	-21.1	0	39.71	-	-	-	-	0-360	199	H
2	2.003	30.26	Pk	31.3	-21.1	0	40.46	-	-	-	-	0-360	102	V
4	6.262	32.51	Pk	35.6	-29.7	0	38.41	-	-	-	-	0-360	102	H
6	6.363	32.29	Pk	35.7	-30.1	0	37.89	-	-	-	-	0-360	200	V

* - indicates frequency in CFR47 Pt 15 - Restricted Band
 Pk - Peak detector

Radiated Emissions

Marker	Frequency (GHz)	Meter Reading (dBuV)	Det	AF T863 (dB/m)	Amp/Cbl/Filtr/Pad (dB)	DC Corr (dB)	Corrected Reading (dBuV/m)	Avg Limit (dBuV/m)	Margin (dB)	Peak Limit (dBuV/m)	PK Margin (dB)	Azimuth (Degs)	Height (cm)	Polarity
3	* 4.132	39.47	PK2	33.4	-30.8	0	42.07	-	-	74	-31.93	296	156	H
	* 4.134	27.59	MAv1	33.4	-30.7	.1	30.39	54	-23.61	-	-	296	156	H
5	* 4.21	39.49	PK2	33.4	-30.6	0	42.29	-	-	74	-31.71	76	350	V
	* 4.21	27.71	MAv1	33.4	-30.6	.1	30.61	54	-23.39	-	-	76	350	V

* - indicates frequency in CFR47 Pt 15 - Restricted Band
 PK2 - KDB558074 Method: Maximum Peak
 MAv1 - KDB558074 Option 1 Maximum RMS Average

MID CHANNEL, CH 6 RESULTS

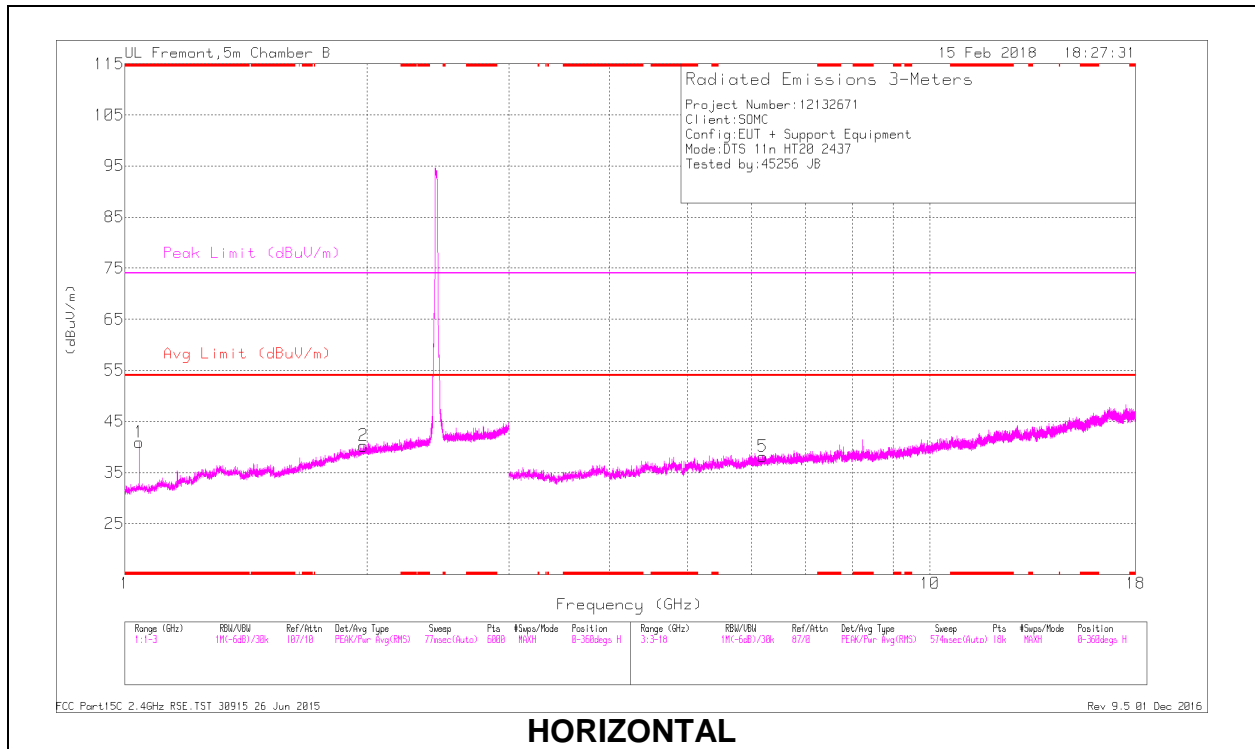

HORIZONTAL

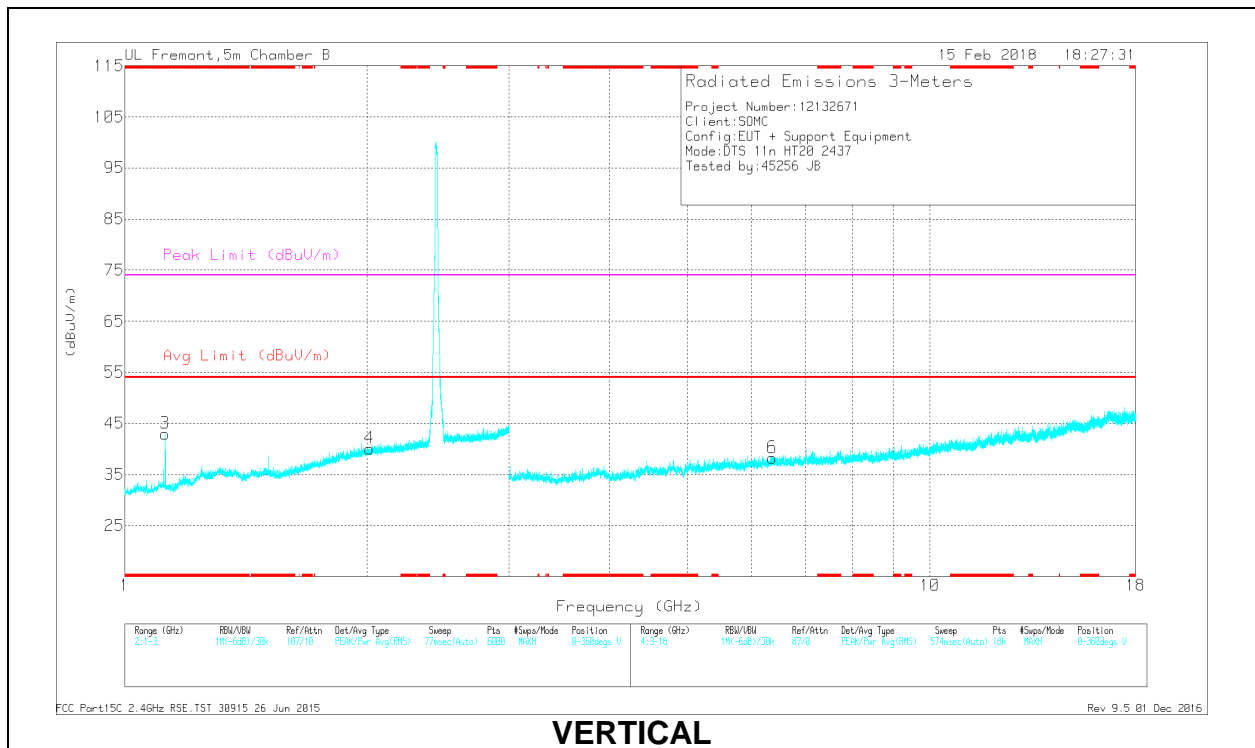

VERTICAL

RADIATED EMISSIONS

Trace Markers

Marker	Frequency (GHz)	Meter Reading (dBuV)	Det	AF T863 (dBm)	Amp/Cbl/Filtr/Pad (dB)	DC Corr (dB)	Corrected Reading (dBuV/m)	Avg Limit (dBuV/m)	Margin (dB)	Peak Limit (dBuV/m)	PK Margin (dB)	Azimuth (Degs)	Height (cm)	Polarity
1	* 1.042	37.16	Pk	27.1	-23.4	0	40.86	-	-	74	-33.14	0-360	199	H
3	* 1.123	38.4	Pk	27.6	-23	0	43	-	-	74	-31	0-360	200	V
2	1.979	30.01	Pk	31.2	-21	0	40.21	-	-	-	-	0-360	199	H
4	2.013	29.88	Pk	31.3	-21.1	0	40.08	-	-	-	-	0-360	200	V
5	6.196	32.17	Pk	35.7	-29.7	0	38.17	-	-	-	-	0-360	102	H
6	6.369	32.7	Pk	35.7	-30.1	0	38.3	-	-	-	-	0-360	199	V

* - indicates frequency in CFR47 Pt 15 - Restricted Band
 Pk - Peak detector

Radiated Emissions

Marker	Frequency (GHz)	Meter Reading (dBuV)	Det	AF T863 (dB/m)	Amp/Cbl/Filtr/Pad (dB)	DC Corr (dB)	Corrected Reading (dBuV/m)	Avg Limit (dBuV/m)	Margin (dB)	Peak Limit (dBuV/m)	PK Margin (dB)	Azimuth (Degs)	Height (cm)	Polarity
1	* 1.042	35.51	PK2	27.1	-23.4	0	39.21	-	-	74	-34.79	0	357	H
	* 1.04	23.58	MAv1	27.1	-23.3	.1	27.48	54	-26.52	-	-	0	357	H
3	* 1.125	35.07	PK2	27.6	-22.8	0	39.87	-	-	74	-34.13	164	351	V
	* 1.122	23.26	MAv1	27.6	-23	.1	27.96	54	-26.04	-	-	164	351	V

* - indicates frequency in CFR47 Pt 15 - Restricted Band
 PK2 - KDB558074 Method: Maximum Peak
 MAv1 - KDB558074 Option 1 Maximum RMS Average

HIGH CHANNEL, CH 11 RESULTS

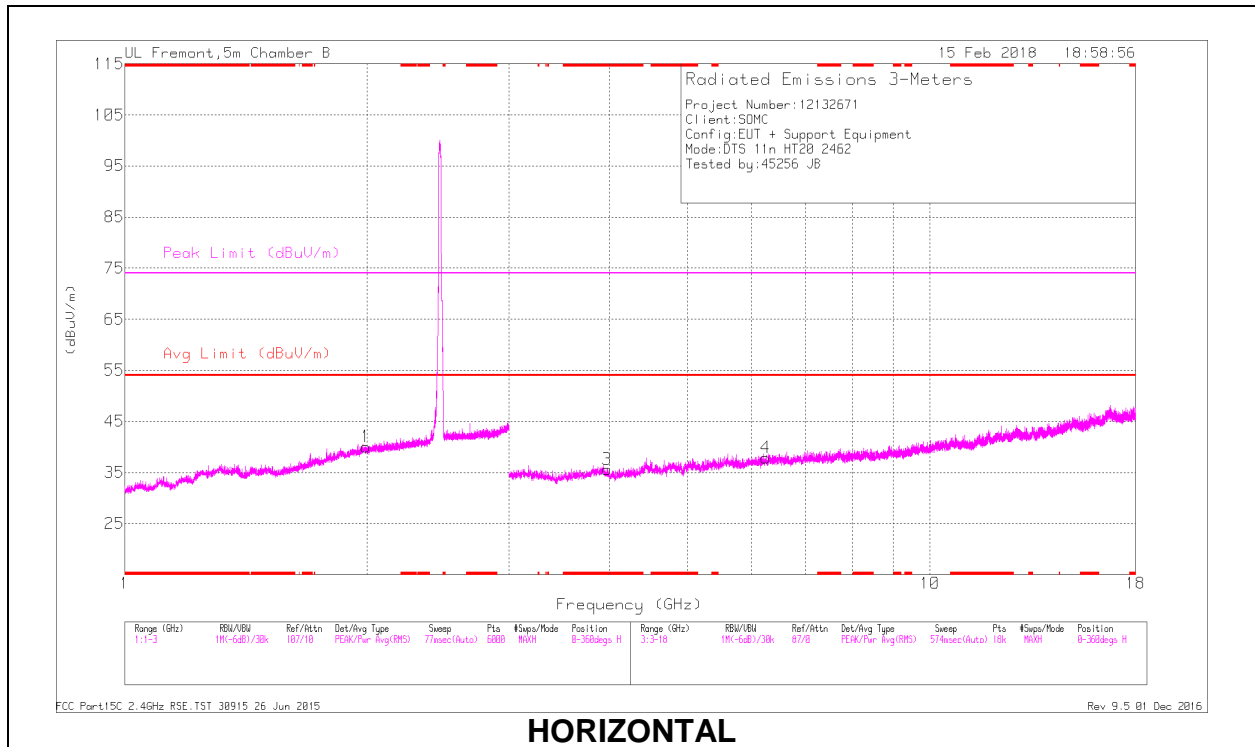

HORIZONTAL

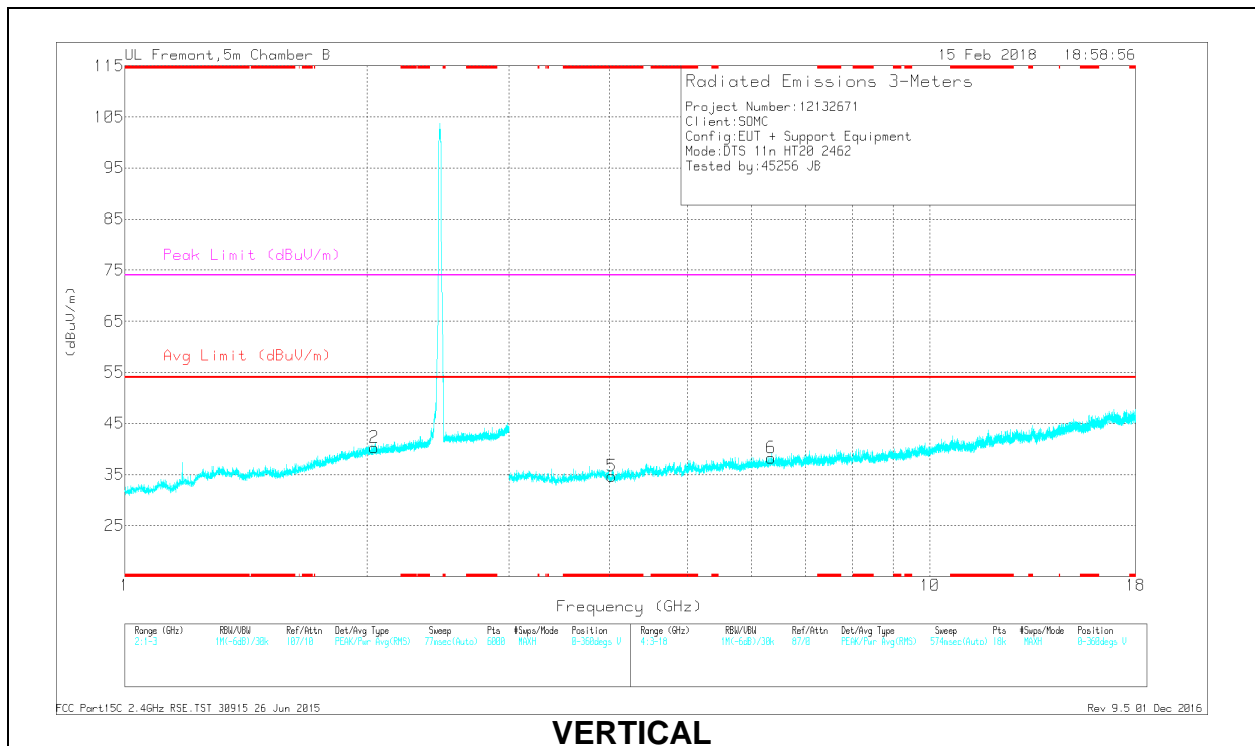

VERTICAL

RADIATED EMISSIONS

Trace Markers

Marker	Frequency (GHz)	Meter Reading (dBuV)	Det	AF T863 (dBm)	Amp/Cbl/Fitr/Pad (dB)	DC Corr (dB)	Corrected Reading (dBuV/m)	Avg Limit (dBuV/m)	Margin (dB)	Peak Limit (dBuV/m)	PK Margin (dB)	Azimuth (Degs)	Height (cm)	Polarity
3	* 3.972	33.32	Pk	33.5	-31.3	0	35.52	-	-	74	-38.48	0-360	199	H
5	* 4.023	32.72	Pk	33.5	-31.5	0	34.72	-	-	74	-39.28	0-360	102	V
1	1.991	29.83	Pk	31.3	-21.1	0	40.03	-	-	-	-	0-360	102	H
2	2.041	30.02	Pk	31.4	-21.2	0	40.22	-	-	-	-	0-360	102	V
4	6.254	31.95	Pk	35.6	-29.7	0	37.85	-	-	-	-	0-360	199	H
6	6.344	32.41	Pk	35.7	-29.9	0	38.21	-	-	-	-	0-360	200	V

* - indicates frequency in CFR47 Pt 15 - Restricted Band
 Pk - Peak detector

Radiated Emissions

Marker	Frequency (GHz)	Meter Reading (dBuV)	Det	AF T863 (dB/m)	Amp/Cbl/Fitr/Pad (dB)	DC Corr (dB)	Corrected Reading (dBuV/m)	Avg Limit (dBuV/m)	Margin (dB)	Peak Limit (dBuV/m)	PK Margin (dB)	Azimuth (Degs)	Height (cm)	Polarity
3	* 3.97	39.87	PK2	33.5	-31.2	0	42.17	-	-	74	-31.83	186	266	H
	* 3.973	28.28	MAv1	33.5	-31.3	.1	30.58	54	-23.42	-	-	186	266	H
5	* 4.024	40.15	PK2	33.5	-31.5	0	42.15	-	-	74	-31.85	344	283	V
	* 4.025	28.23	MAv1	33.5	-31.5	.1	30.33	54	-23.67	-	-	344	283	V

* - indicates frequency in CFR47 Pt 15 - Restricted Band
 PK2 - KDB558074 Method: Maximum Peak
 MAv1 - KDB558074 Option 1 Maximum RMS Average

9.2. WORST-CASE BELOW 30 MHz

SPURIOUS EMISSIONS BELOW 30 MHz (WORST-CASE CONFIGURATION)

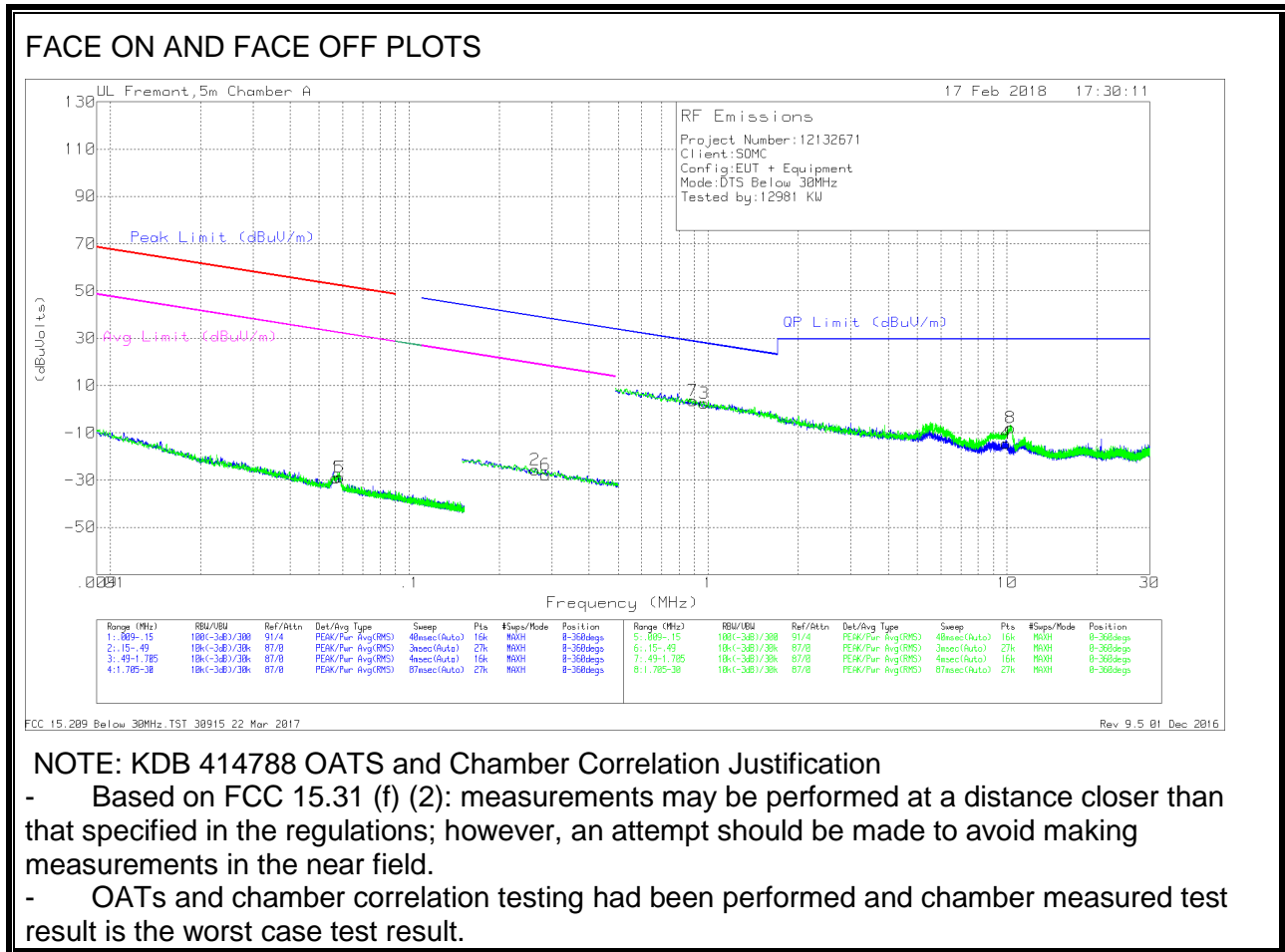

Trace Markers

Marker	Frequency (MHz)	Meter Reading (dBuV)	Det	Loop Antenna (dB/m)	Cbl (dB)	Dist Corr 300m	Corrected Reading (dBuVolts)	Peak Limit (dBuV/m)	Margin (dB)	Avg Limit (dBuV/m)	Margin (dB)	Azimuth (Degs)
1	.05679	39.05	Pk	11.8	.1	-80	-29.05	52.5	-81.55	32.5	-61.55	0-360
5	.05847	39.17	Pk	11.8	.1	-80	-28.93	52.25	-81.18	32.25	-61.18	0-360
2	.2637	43.36	Pk	10.9	.1	-80	-25.64	39.19	-64.83	19.19	-44.83	0-360
6	.28611	41.1	Pk	10.9	.1	-80	-27.9	38.48	-66.38	18.48	-46.38	0-360

Pk - Peak detector

Marker	Frequency (MHz)	Meter Reading (dBuV)	Det	Loop Antenna (dB/m)	Cbl (dB)	Dist Corr 30m	Corrected Reading (dBuVolts)	QP Limit (dBuV/m)	Margin (dB)	Azimuth (Degs)
7	.88972	32.31	Pk	11.1	.2	-40	3.61	28.63	-25.02	0-360
3	.96975	31.13	Pk	11.2	.1	-40	2.43	27.89	-25.46	0-360
4	9.92342	14.03	Pk	11.1	.4	-40	-14.47	29.5	-43.97	0-360
8	10.2745	20.43	Pk	11.1	.5	-40	-7.97	29.5	-37.47	0-360

Pk - Peak detector

9.3. Worst Case Below 1 GHz

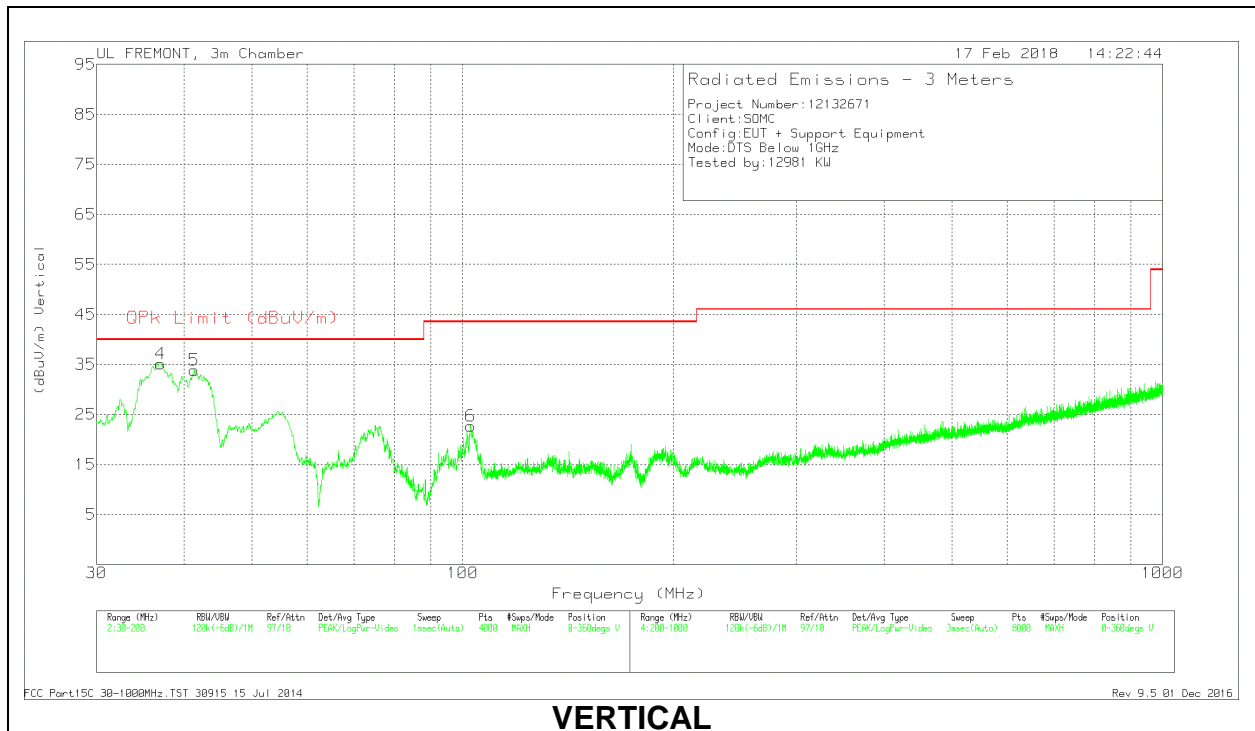
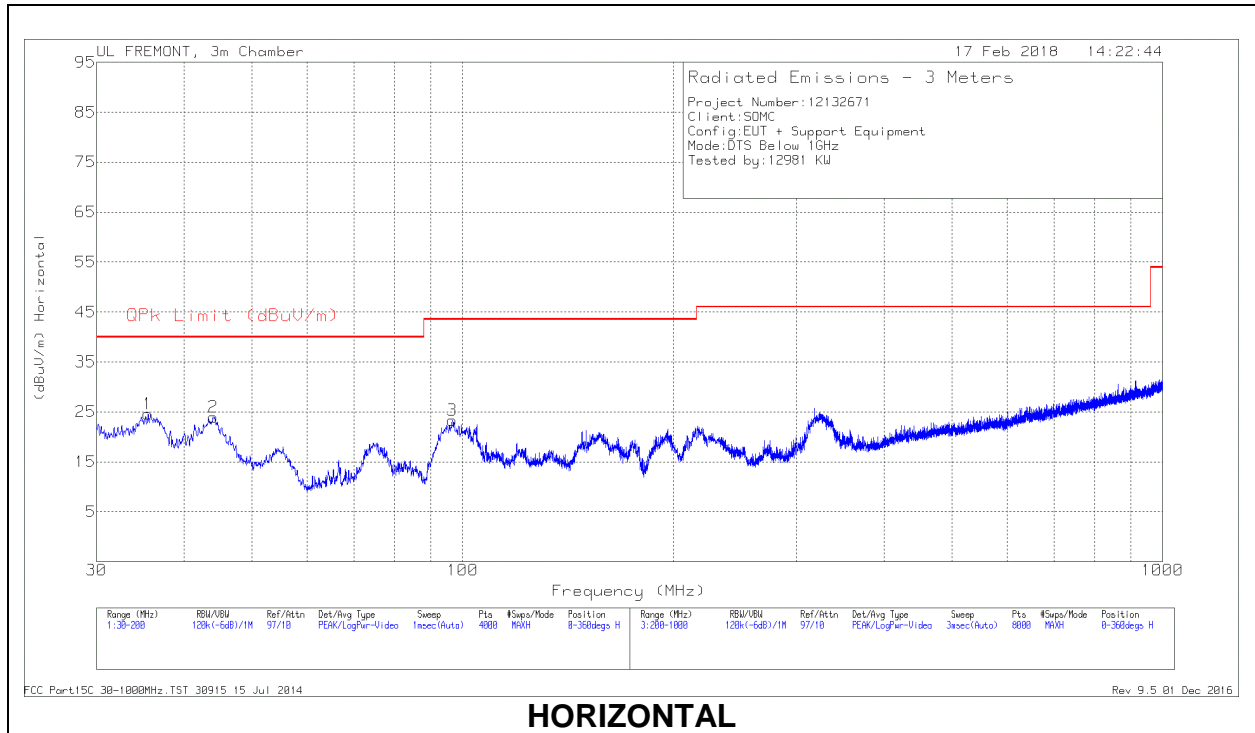

Below 1GHz DATA

Trace Markers

Marker	Frequency (MHz)	Meter Reading (dBuV)	Det	AF T243 (dB/m)	Amp/Cbl (dB/m)	Corrected Reading (dBuV/m)	QPk Limit (dBuV/m)	Margin (dB)	Azimuth (Degs)	Height (cm)	Polarity
1	35.5264	34.43	Pk	21.1	-31	24.53	40	-15.47	0-360	400	H
4	37.0143	46.04	Pk	20.1	-31	35.14	40	-4.86	0-360	100	V
	37.0753	42.55	Qp	20	-31	31.55	40	-8.45	343	101	V
5	41.3929	47.9	Pk	16.9	-30.9	33.9	40	-6.1	0-360	100	V
2	43.9861	39.8	Pk	15.1	-30.9	24	40	-16	0-360	400	H
3	96.6572	40.33	Pk	13.3	-30.3	23.33	43.52	-20.19	0-360	200	H
6	102.7363	37.91	Pk	15.1	-30.3	22.71	43.52	-20.81	0-360	100	V

Pk - Peak detector

Qp - Quasi-Peak detector

9.4. Worst Case 18-26 GHz

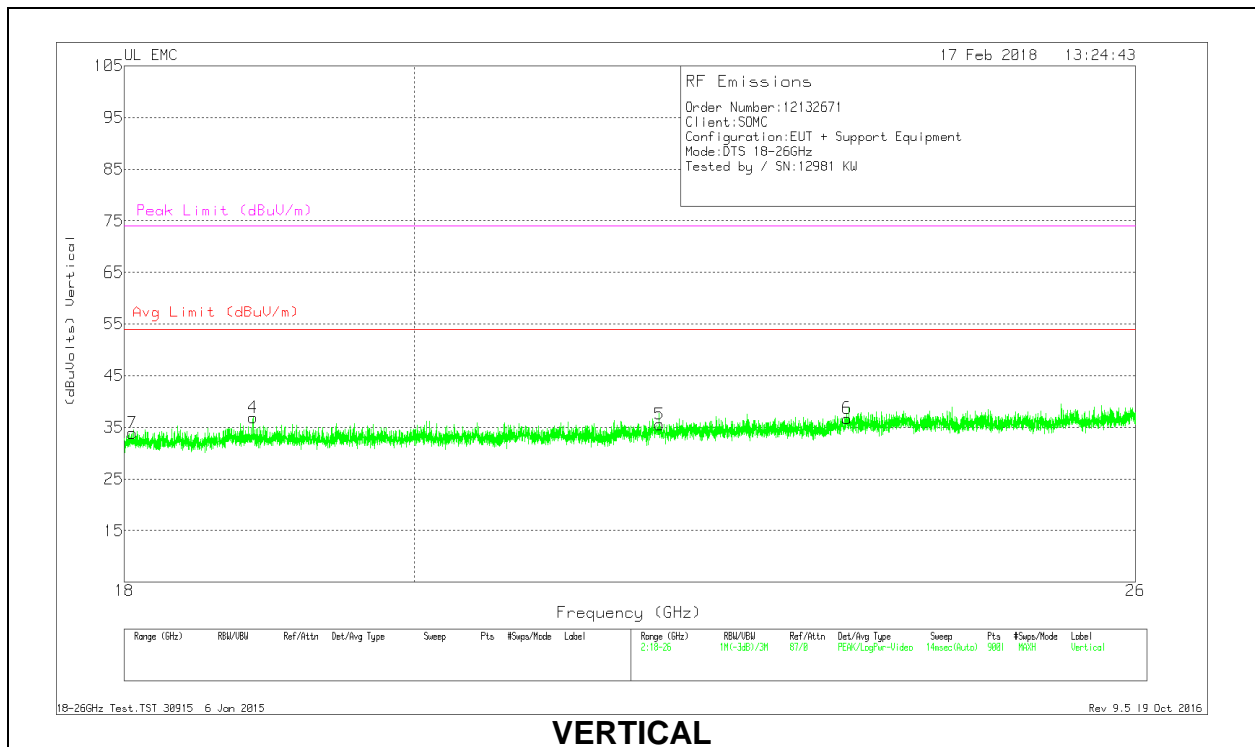
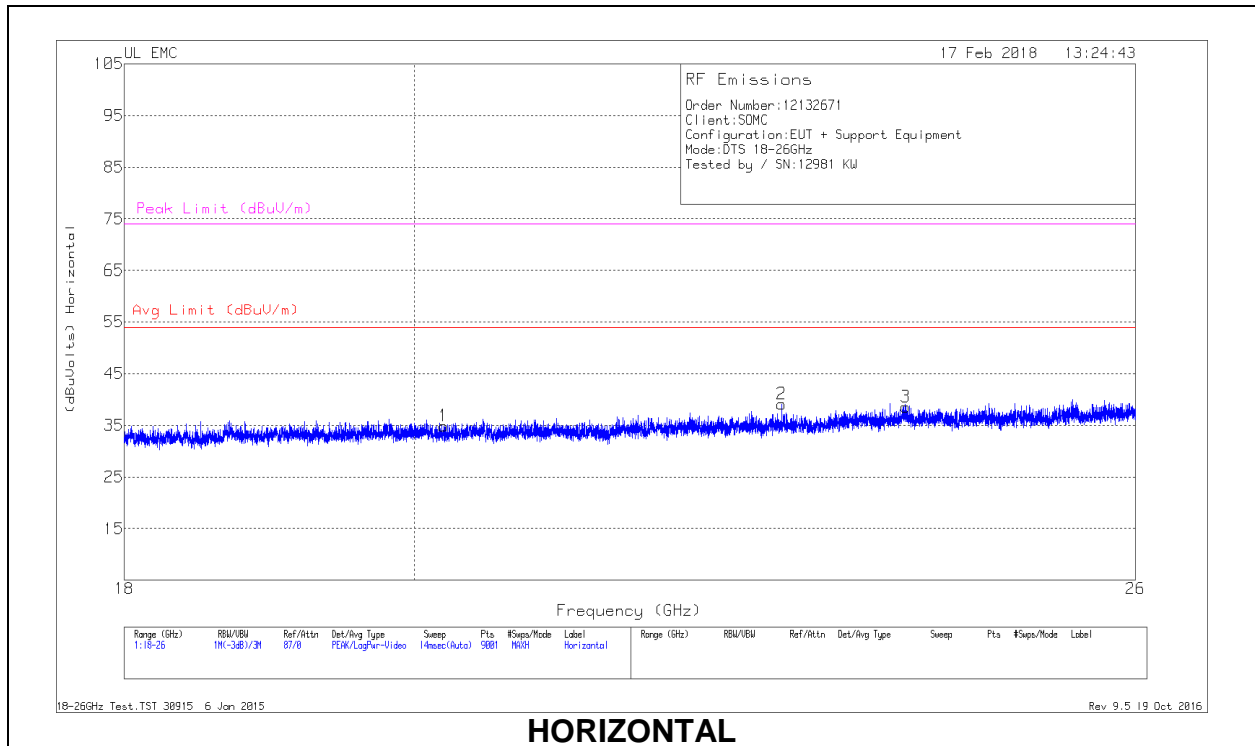

18 – 26GHz DATA

Marker	Frequency (GHz)	Meter Reading (dBuV)	Det	T449 AF (dB/m)	Amp/Cbl (dB)	Dist Corr (dB)	Corrected Reading (dBuVolts)	Avg Limit (dBuV/m)	Margin (dB)	Peak Limit (dBuV/m)	PK Margin (dB)
1	20.216	36.83	Pk	32.8	-25.3	-9.5	34.83	54	-19.17	74	-39.17
2	22.86	40.03	Pk	33.5	-24.9	-9.5	39.13	54	-14.87	74	-34.87
3	23.914	38.08	Pk	33.9	-23.9	-9.5	38.58	54	-15.42	74	-35.42
4	18.862	39.17	Pk	32.4	-25.2	-9.5	36.87	54	-17.13	74	-37.13
5	21.868	36.35	Pk	33.3	-24.6	-9.5	35.55	54	-18.45	74	-38.45
6	23.412	36.67	Pk	33.9	-24.4	-9.5	36.67	54	-17.33	74	-37.33
7	18.052	36.28	Pk	32.4	-25.3	-9.5	33.88	54	-20.12	74	-40.12

10. AC POWER LINE CONDUCTED EMISSIONS

LIMITS

FCC §15.207 (a)

Frequency of Emission (MHz)	Conducted Limit (dBuV)	
	Quasi-peak	Average
0.15-0.5	66 to 56*	56 to 46*
0.5-5	56	46
5-30	60	50

*Decreases with the logarithm of the frequency.

TEST PROCEDURE

The EUT is placed on a non-conducting table 40 cm from the vertical ground plane and 80 cm above the horizontal ground plane. The EUT is configured in accordance with ANSI C63.10.

The receiver is set to a resolution bandwidth of 9 kHz. Peak detection is used unless otherwise noted as quasi-peak or average.

Line conducted data is recorded for both NEUTRAL and HOT lines.

RESULTS

10.1.1. AC Power Line Norm

LINE 1 RESULTS

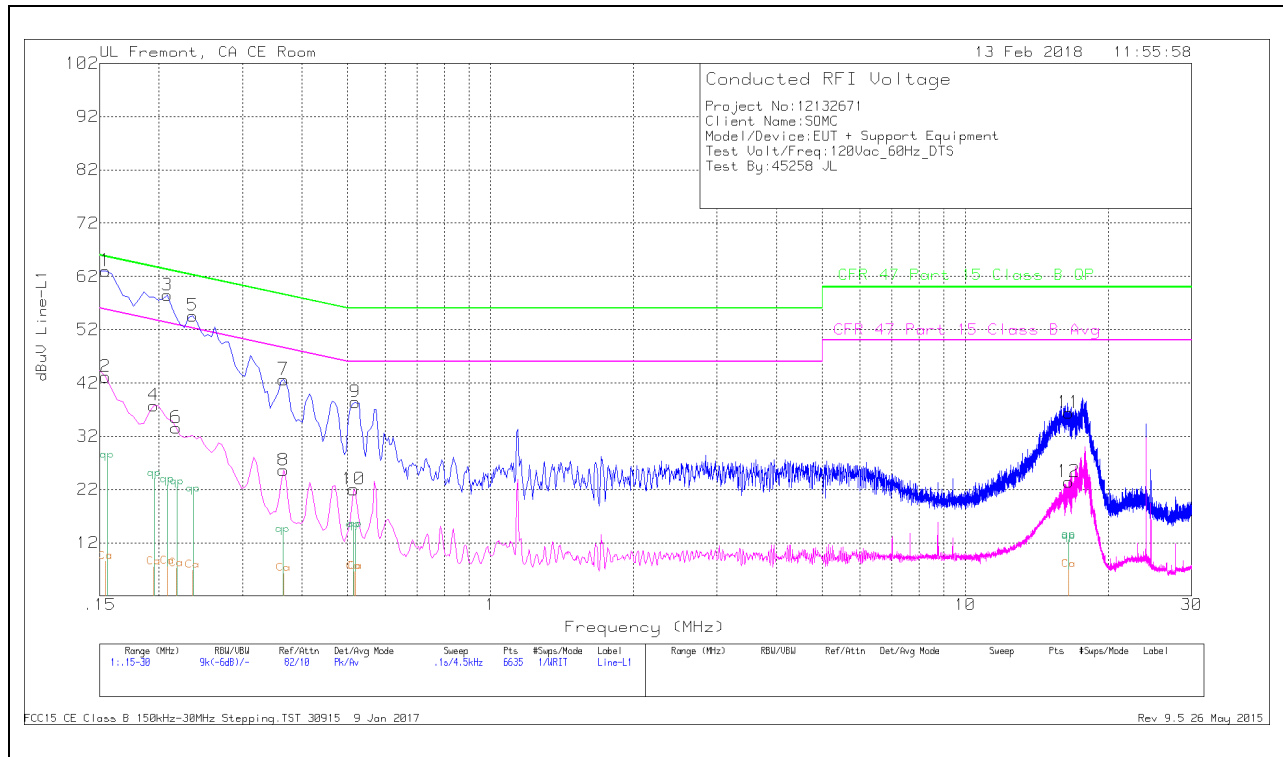

Range 1: Line-L1 .15 - 30MHz											
Marker	Frequency (MHz)	Meter Reading (dBuV)	Det	LISN L1	LC Cables C1&C3	Limiter (dB)	Corrected Reading dBuV	CFR 47 Part 15 Class B QP	QP Margin (dB)	CFR 47 Part 15 Class B Avg	Margin (dB)
1	.1545	52.83	Pk	.1	0	10.1	63.03	-	-	-	-
2	.1545	32.96	Av	.1	0	10.1	43.16	-	-	55.75	-12.59
3	.2085	48.36	Pk	0	0	10.1	58.46	-	-	-	-
4	.195	27.67	Av	0	0	10.1	37.77	-	-	53.82	-16.05
5	.2355	44.53	Pk	0	0	10.1	54.63	-	-	-	-
6	.2175	23.5	Av	0	0	10.1	33.6	-	-	52.91	-19.31
7	.366	32.52	Pk	0	0	10.1	42.62	-	-	-	-
8	.366	15.5	Av	0	0	10.1	25.6	-	-	48.59	-22.99
9	.519	28.29	Pk	0	0	10.1	38.39	-	-	-	-
10	.5145	11.93	Av	0	0	10.1	22.03	-	-	46	-23.97
11	16.521	25.8	Pk	0	.3	10.3	36.4	-	-	-	-
12	16.53	12.86	Av	0	.3	10.3	23.46	-	-	50	-26.54

LINE 2 RESULTS

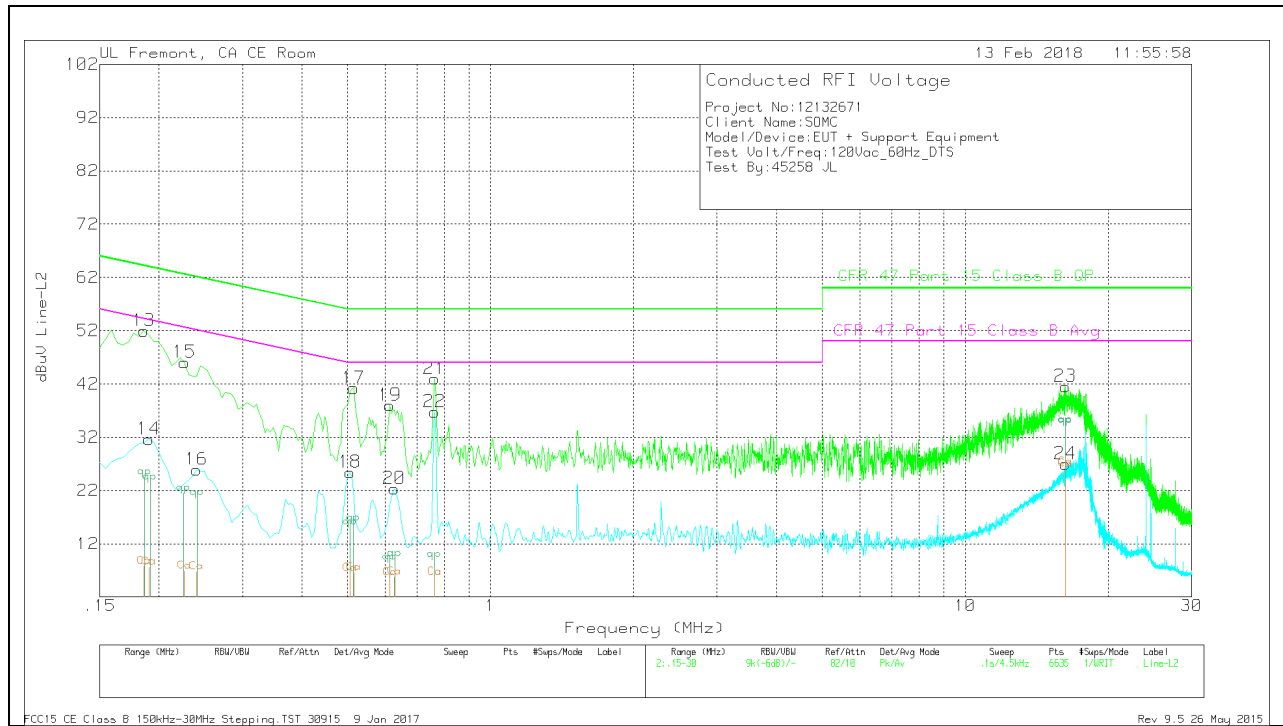

Range 2: Line-L2 .15 - 30MHz											
Marker	Frequency (MHz)	Meter Reading (dBuV)	Det	LISN L2	LC Cables C2&C3	Limiter (dB)	Corrected Reading dBuV	CFR 47 Part 15 Class B QP	QP Margin (dB)	CFR 47 Part 15 Class B Avg	Margin (dB)
13	.186	41.87	Pk	0	0	10.1	51.97	-	-	-	-
14	.1905	21.53	Av	0	0	10.1	31.63	-	-	54.01	-22.38
15	.2265	35.95	Pk	0	0	10.1	46.05	-	-	-	-
16	.24	15.82	Av	0	0	10.1	25.92	-	-	52.1	-26.18
17	.5145	31.11	Pk	0	0	10.1	41.21	-	-	-	-
18	.5055	15.31	Av	0	0	10.1	25.41	-	-	46	-20.59
19	.6135	27.87	Pk	0	0	10.1	37.97	-	-	-	-
20	.627	12.26	Av	0	0	10.1	22.36	-	-	46	-23.64
21	.762	32.83	Pk	0	0	10.1	42.93	-	-	-	-
22	.762	26.68	Av	0	0	10.1	36.78	-	-	46	-9.22
23	16.2555	30.95	Pk	0	.3	10.3	41.55	-	-	-	-
24	16.251	16.39	Av	0	.3	10.3	26.99	-	-	50	-23.01