



# **CERTIFICATION TEST REPORT**

**Report Number. :** 12132671-E2V3

**Applicant :** SONY MOBILE COMMUNICATIONS, INC.  
4-12-3 HIGASHI-SHINAGAWA,  
SHINAGAWA -KU, TOKYO, 140-0002, JAPAN

**FCC ID :** PY7-11821Y

**EUT Description :** GSM/WCDMA/LTE Phone with BT, DTS/UNII a/b/g/n/ac & NFC

**Test Standard(s) :** FCC 47 CFR PART 15 SUBPART C

**Date Of Issue:**

March 13, 2018

**Prepared by:**

UL Verification Services Inc.  
47173 Benicia Street  
Fremont, CA 94538, U.S.A.  
TEL: (510) 771-1000  
FAX: (510) 661-0888



---

## REPORT REVISION HISTORY

Rev.	Issue Date	Revisions	Revised By
V1	03/06/18	Initial Issue	
V2	03/08/18	Updated Section 5.5, 5.6, 8.3, 8.6.1, 8.6.2 and 9	Kiya Kedida
V3	03/13/18	Updated Section 8.6	Kiya Kedida

## TABLE OF CONTENTS

<b>1. ATTESTATION OF TEST RESULTS .....</b>	<b>5</b>
<b>2. TEST METHODOLOGY .....</b>	<b>6</b>
<b>3. FACILITIES AND ACCREDITATION .....</b>	<b>6</b>
<b>4. CALIBRATION AND UNCERTAINTY .....</b>	<b>7</b>
4.1. <i>MEASURING INSTRUMENT CALIBRATION .....</i>	<i>7</i>
4.2. <i>SAMPLE CALCULATION .....</i>	<i>7</i>
4.3. <i>MEASUREMENT UNCERTAINTY.....</i>	<i>7</i>
<b>5. EQUIPMENT UNDER TEST .....</b>	<b>8</b>
5.1. <i>EUT DESCRIPTION .....</i>	<i>8</i>
5.2. <i>MAXIMUM OUTPUT POWER.....</i>	<i>8</i>
5.3. <i>DESCRIPTION OF AVAILABLE ANTENNAS .....</i>	<i>8</i>
5.4. <i>SOFTWARE AND FIRMWARE.....</i>	<i>8</i>
5.5. <i>WORST-CASE CONFIGURATION AND MODE.....</i>	<i>9</i>
5.6. <i>DESCRIPTION OF TEST SETUP.....</i>	<i>10</i>
<b>6. TEST AND MEASUREMENT EQUIPMENT .....</b>	<b>13</b>
<b>7. MEASUREMENT METHODS .....</b>	<b>14</b>
<b>8. ANTENNA PORT TEST RESULTS .....</b>	<b>15</b>
8.1. <i>ON TIME AND DUTY CYCLE.....</i>	<i>15</i>
8.2. <i>20 dB AND 99% BANDWIDTH .....</i>	<i>16</i>
8.2.1. <i>BLUETOOTH BASIC DATA RATE GFSK MODULATION .....</i>	<i>17</i>
8.2.2. <i>BLUETOOTH ENCHANCED DATA RATE 8PSK MODULATION .....</i>	<i>18</i>
8.3. <i>HOPPING FREQUENCY SEPARATION .....</i>	<i>19</i>
8.3.1. <i>BLUETOOTH BASIC DATA RATE GFSK MODULATION .....</i>	<i>20</i>
8.3.2. <i>BLUETOOTH ENCHANCED DATA RATE 8PSK MODULATION .....</i>	<i>21</i>
8.4. <i>NUMBER OF HOPPING CHANNELS.....</i>	<i>22</i>
8.4.1. <i>BLUETOOTH BASIC DATA RATE GFSK MODULATION .....</i>	<i>23</i>
8.4.2. <i>BLUETOOTH ENCHANCED DATA RATE 8PSK MODULATION .....</i>	<i>25</i>
8.5. <i>AVERAGE TIME OF OCCUPANCY.....</i>	<i>27</i>
8.5.1. <i>BLUETOOTH BASIC DATA RATE GFSK MODULATION .....</i>	<i>28</i>
8.5.2. <i>BLUETOOTH ENCHANCED DATA RATE 8PSK MODULATION .....</i>	<i>30</i>
8.6. <i>OUTPUT POWER.....</i>	<i>32</i>
8.6.1. <i>BLUETOOTH BASIC DATA RATE GFSK MODULATION .....</i>	<i>33</i>
8.6.2. <i>BLUETOOTH ENCHANCED DATA RATE 8PSK MODULATION .....</i>	<i>34</i>
8.7. <i>AVERAGE POWER.....</i>	<i>35</i>
8.7.1. <i>BLUETOOTH BASIC DATA RATE GFSK MODULATION .....</i>	<i>36</i>
8.7.2. <i>BLUETOOTH ENCHANCED DATA RATE 8PSK MODULATION .....</i>	<i>37</i>

---

8.8.	<i>CONDUCTED SPURIOUS EMISSIONS</i> .....	38
8.8.1.	BLUETOOTH BASIC DATA RATE GFSK MODULATION .....	39
8.8.2.	BLUETOOTH ENCHANCED DATA RATE 8PSK MODULATION .....	41
<b>9.</b>	<b>RADIATED TEST RESULTS</b> .....	<b>43</b>
9.1.	<i>TRANSMITTER ABOVE 1 GHz</i> .....	44
9.1.1.	BLUETOOTH BASIC DATA RATE GFSK MODULATION .....	44
9.1.2.	BLUETOOTH ENCHANCED DATA RATE 8PSK MODULATION .....	54
9.2.	<i>WORST-CASE BELOW 30 MHz</i> .....	64
9.3.	<i>Worst Case Below 1 GHz</i> .....	65
9.4.	<i>Worst Case 18-26 GHz</i> .....	67
<b>10.</b>	<b>AC POWER LINE CONDUCTED EMISSIONS</b> .....	<b>69</b>
10.1.1.	AC Power Line Norm.....	70
<b>11.</b>	<b>SETUP PHOTOS</b> .....	<b>72</b>

# 1. ATTESTATION OF TEST RESULTS

**COMPANY NAME:** SONY MOBILE COMMUNICATIONS, INC.  
4-12-3 HIGASHI-SHINAGAWA,  
SHINAGAWA -KU, TOKYO, 140-0002, JAPAN

**EUT DESCRIPTION:** GSM/WCDMA/LTE Phone with BT, DTS/UNII a/b/g/n/ac &  
NFC

**SERIAL NUMBER:** BH90005YBB (RADIATED)  
BH90009EBB (CONDUCTED)

**DATE TESTED:** FEBRUARY 12-17, 2018

APPLICABLE STANDARDS	
STANDARD	TEST RESULTS
CFR 47 Part 15 Subpart C	Complies

UL Verification Services Inc. tested the above equipment in accordance with the requirements set forth in the above standards. All indications of Pass/Fail in this report are opinions expressed by UL Verification Services Inc. based on interpretations and/or observations of test results. Measurement Uncertainties were not taken into account and are published for informational purposes only. The test results show that the equipment tested is capable of demonstrating compliance with the requirements as documented in this report.

**Note:** The results documented in this report apply only to the tested sample, under the conditions and modes of operation as described herein. This document may not be altered or revised in any way unless done so by UL Verification Services Inc. and all revisions are duly noted in the revisions section. Any alteration of this document not carried out by UL Verification Services Inc. will constitute fraud and shall nullify the document. This report must not be used by the client to claim product certification, approval, or endorsement by NVLAP, NIST, any agency of the Federal Government, or any agency of the U.S. government.

Approved & Released For  
UL Verification Services Inc. By:

Prepared By:



Kiya Kedida / Dan Coronia  
CONSUMER TECHNOLOGY DIVISION  
Project Engineer/Operations Leader  
UL Verification Services Inc.

Jason Qian  
CONSUMER TECHNOLOGY DIVISION  
Test Engineer  
UL Verification Services Inc.

## 2. TEST METHODOLOGY

The tests documented in this report were performed in accordance with FCC CFR 47 Part 2, FCC CFR 47 Part 15, ANSI C63.10-2013

## 3. FACILITIES AND ACCREDITATION

The test sites and measurement facilities used to collect data are located at 47173 and 47266 Benicia Street, Fremont, California, USA. Line conducted emissions are measured only at the 47173 address. The following table identifies which facilities were utilized for radiated emission measurements documented in this report. Specific facilities are also identified in the test results sections.

47173 Benicia Street	47266 Benicia Street
<input checked="" type="checkbox"/> Chamber A (ISED:2324B-1)	<input type="checkbox"/> Chamber D (ISED:22541-1)
<input checked="" type="checkbox"/> Chamber B (ISED:2324B-2)	<input type="checkbox"/> Chamber E (ISED:22541-2)
<input type="checkbox"/> Chamber C (ISED:2324B-3)	<input type="checkbox"/> Chamber F (ISED:22541-3)
	<input type="checkbox"/> Chamber G (ISED:22541-4)
	<input type="checkbox"/> Chamber H (ISED:22541-5)

The above test sites and facilities are covered under FCC Test Firm Registration # 208313. Chambers A through C are covered under ISED company address code 2324B with site numbers 2324B -1 through 2324B-3, respectively. Chambers D through H are covered under ISED Canada company address code 22541 with site numbers 22541 -1 through 22541-5, respectively.

UL Verification Services Inc. is accredited by NVLAP, Laboratory Code 200065-0. The full scope of accreditation can be viewed at <http://ts.nist.gov/standards/scopes/2000650.htm>.

## 4. CALIBRATION AND UNCERTAINTY

### 4.1. MEASURING INSTRUMENT CALIBRATION

The measuring equipment utilized to perform the tests documented in this report has been calibrated in accordance with the manufacturer's recommendations, and is traceable to recognized national standards.

### 4.2. SAMPLE CALCULATION

Where relevant, the following sample calculation is provided:

$$\begin{aligned} \text{Field Strength (dBuV/m)} &= \text{Measured Voltage (dBuV)} + \text{Antenna Factor (dB/m)} + \\ &\text{Cable Loss (dB)} - \text{Preamp Gain (dB)} \\ 36.5 \text{ dBuV} + 18.7 \text{ dB/m} + 0.6 \text{ dB} - 26.9 \text{ dB} &= 28.9 \text{ dBuV/m} \end{aligned}$$

### 4.3. MEASUREMENT UNCERTAINTY

Where relevant, the following measurement uncertainty levels have been estimated for tests performed on the apparatus:

PARAMETER	UNCERTAINTY
Worst Case Conducted Disturbance, 9KHz to 0.15 MHz	3.84 dB
Worst Case Conducted Disturbance, 0.15 to 30 MHz	3.65 dB
Worst Case Radiated Disturbance, 9KHz to 30 MHz	3.15 dB
Worst Case Radiated Disturbance, 30 to 1000 MHz	5.36 dB
Worst Case Radiated Disturbance, 1000 to 18000 MHz	4.32 dB
Worst Case Radiated Disturbance, 18000 to 26000 MHz	4.45 dB
Worst Case Radiated Disturbance, 26000 to 40000 MHz	5.24 dB

Uncertainty figures are valid to a confidence level of 95%.

## 5. EQUIPMENT UNDER TEST

### 5.1. EUT DESCRIPTION

The EUT is a GSM/WCDMA/LTE Phone with BT, DTS/UNII a/b/g/n/ac & NFC.

### 5.2. MAXIMUM OUTPUT POWER

The transmitter has a maximum peak conducted output power as follows:

Frequency Range (MHz)	Mode	Output Power (dBm)	Output Power (mW)
2402 - 2480	Basic GFSK	10.10	10.23
2402 - 2480	Enhanced 8PSK	8.45	7.00

Note: GFSK, DQPSK, 8PSK average Power are all investigated, The GFSK & 8PSK Power are the worst case. Testing is based on these modes to showing compliance. For average power data please refer to section 8.7.

### 5.3. DESCRIPTION OF AVAILABLE ANTENNAS

The radio utilizes Loop Type antenna, with the following maximum gain:

Frequency Band (GHz)	Antenna Gain (dBi)
2402-2480	-0.60

### 5.4. SOFTWARE AND FIRMWARE

The firmware installed in the EUT during testing was s\_atp\_XXX\_0\_00333\_A\_11.  
The test utility software used during testing was Tera Term Ver 4.79.



---

## 5.5. WORST-CASE CONFIGURATION AND MODE

Radiated emissions below 30MHz, below 1GHz and above 18GHz, and AC power line conducted emission were performed with the EUT set to transmit at the channel with highest output power as worst-case scenario.

Band edge and radiated emissions between 1GHz and 18GHz were performed with the EUT set to transmit at the highest power on low, middle and high channels.

The fundamental of the EUT was investigated in three orthogonal orientations X, Y, & Z, and it was determined that X-Axis with AC/DC Adapter was worst-case orientation; therefore, all final radiated testing was performed with the EUT in X-Axis with AC/DC Adapter orientation.

Worst-case data rates as provided by the client were:

GFSK mode: DH5  
8PSK mode: 3-DH5

## 5.6. DESCRIPTION OF TEST SETUP

### SUPPORT EQUIPMENT

Support Equipment List				
Description	Manufacturer	Model	Serial Number	FCC ID
Laptop	Lenovo	20B7S0A200	PC015REW	NA
AC Adapter	SONY	UCH12	4016W40310044	NA
DC Power Supply	Ametek	XT 15-4	T463	N/A

### I/O CABLES (CONDUCTED TEST)

I/O Cable List						
Cable No	Port	# of identical ports	Connector Type	Cable Type	Cable Length (m)	Remarks
1	Antenna	1	RF	Shielded	0.2	To spectrum Analyzer
2	USB	1	USB	Shielded	1	N/A
3	DC	1	DC	Shielded	0.3	N/A

### I/O CABLES (RADIATED AND CONDUCTED EMISSIONS)

I/O Cable List						
Cable No	Port	# of identical ports	Connector Type	Cable Type	Cable Length (m)	Remarks
1	USB	1	USB	Shielded	3	N/A

**TEST SETUP**

**CONDCUTED TEST SETUP DIAGRAM**

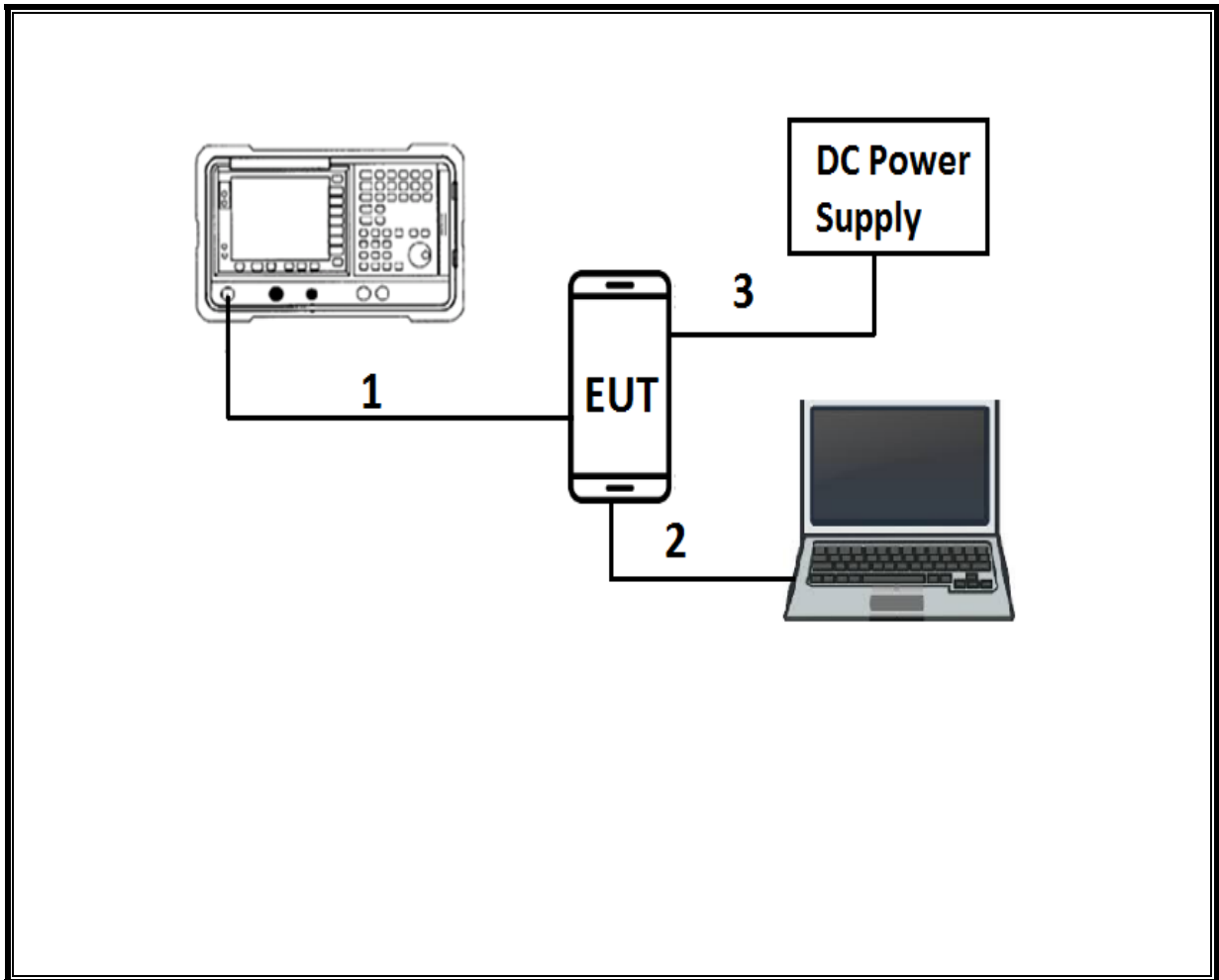

**TEST SETUP**

**RADIATED AND AC LINE CONDUCTED EMISSIONS SETUP DIAGRAM**

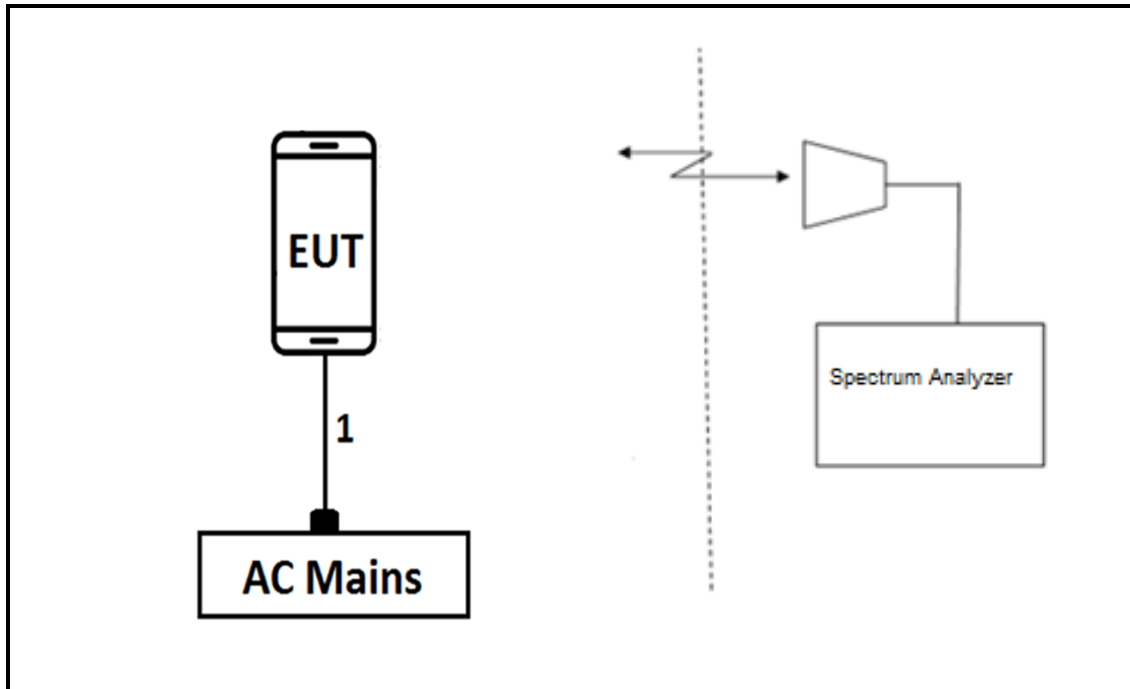

## 6. TEST AND MEASUREMENT EQUIPMENT

The following test and measurement equipment was utilized for the tests documented in this report:

TEST EQUIPMENT LIST					
Description	Manufacturer	Model	ID Num	Cal Due	Last Cal
Amplifier, 10KHz to 1GHz, 32dB	Agilent (Keysight) Technologies	8447D	T10	02/14/2019	02/14/2018
RF Preamplifier, 1 - 26GHz	Agilent	8449B	T404	07/23/2018	07/23/2017
Antenna, Broadband Hybrid, 30MHz to 2000MHz	Sunol Sciences Corp.	JB3	T243	06/15/2018	06/15/2017
Antenna, Horn 1-18GHz	ETS-Lindgren	3117	T863	06/09/2018	06/09/2017
Power Meter, P-series single channel	Agilent (Keysight) Technologies	N1911A	T1269	03/29/2018	03/29/2017
Power Sensor, P - series, 50MHz to 18GHz, Wideband	Agilent (Keysight) Technologies	N1921A	T1224	03/29/2018	03/29/2017
Amplifier, 1 - 18GHz	MITEQ	AFS42-00101800-25-S-42	T931	09/20/2018	09/20/2017
Amplifier, 1-8GHz	MITEQ	AMF-4D-01000800-30-29P	T1156	06/24/2018	06/24/2017
Spectrum Analyzer, PXA, 3Hz to 44GHz	Agilent (Keysight) Technologies	N9030A	T1466	04/11/2018	04/11/2017
Spectrum Analyzer, PXA, 3Hz to 44GHz	Agilent (Keysight) Technologies	N9030A	T1454	01/08/2019	01/08/2018
Spectrum Analyzer, PXA, 3Hz to 44GHz	Agilent (Keysight) Technologies	N9030A	T1113	12/21/2018	12/21/2017
Spectrum Analyzer, PXA, 3Hz to 44GHz	Agilent (Keysight) Technologies	N9030A	T1450	02/05/2019	02/05/2018
Antenna, Horn 18-26.5GHz	ARA	MWH-1826	T449	01/04/2019	01/04/2018
Antenna, Active Loop 9kHz-30MHz	Com-Power Corp.	AL-130R	T1866	10/10/2018	10/10/2017
Test Receiver, EMI, 10Hz-7GHz	Rhode&Schwarz	ESR	T1436	01/06/2019	01/06/2018
LISN	FISCHER	FCC-LISN-50/250-25-2-01	T1310	01/17/2019	01/17/2018

Test Software List			
Description	Manufacturer	Model	Version
Radiated Software	UL	UL EMC	Ver 9.5, December 1, 2016
Antenna Port Software	UL	UL RF	Ver 9.1, January 25, 2018

---

## 7. MEASUREMENT METHODS

On Time and Duty Cycle: ANSI C63.10-2013 Section 11.6

Occupied BW (20dB): ANSI C63.10-2013 Section 6.9.2

Occupied BW (99%): ANSI C63.10-2013 Section 6.9.3

Carrier Frequency Separation: ANSI C63.10-2013 Section 7.8.2

Number of Hopping Frequencies: ANSI C63.10-2013 Section 7.8.3

Time of Occupancy (Dwell Time): ANSI C63.10-2013 Section 7.8.4

Peak Output Power: ANSI C63.10-2013 Section 7.8.5

Conducted Spurious Emissions: ANSI C63.10-2013 Section 7.8.8

Conducted Band-Edge: ANSI C63.10-2013 Section 6.10.4

Radiated Spurious Emissions 30-1000MHz: ANSI C63.10-2013 Section 6.3 and 6.5

Radiated Spurious Emissions above 1GHz: ANSI C63.10-2013 Section 6.3 and 6.6

Radiated Band-edge: ANSI C63.10-2013 Section 6.10.5

AC Power-line conducted emissions: ANSI C63.10-2013, Section 6.2.

## 8. ANTENNA PORT TEST RESULTS

### 8.1. ON TIME AND DUTY CYCLE

#### LIMITS

None; for reporting purposes only.

#### ON TIME AND DUTY CYCLE RESULTS

Mode	ON Time B (msec)	Period (msec)	Duty Cycle x (linear)	Duty Cycle (%)	Duty Cycle Correction Factor (dB)	1/T Minimum VBW (kHz)
GFSK	2.88	3.75	0.769	76.9%	1.14	0.347
8PSK	2.89	3.74	0.772	77.2%	1.12	0.346

#### DUTY CYCLE PLOTS

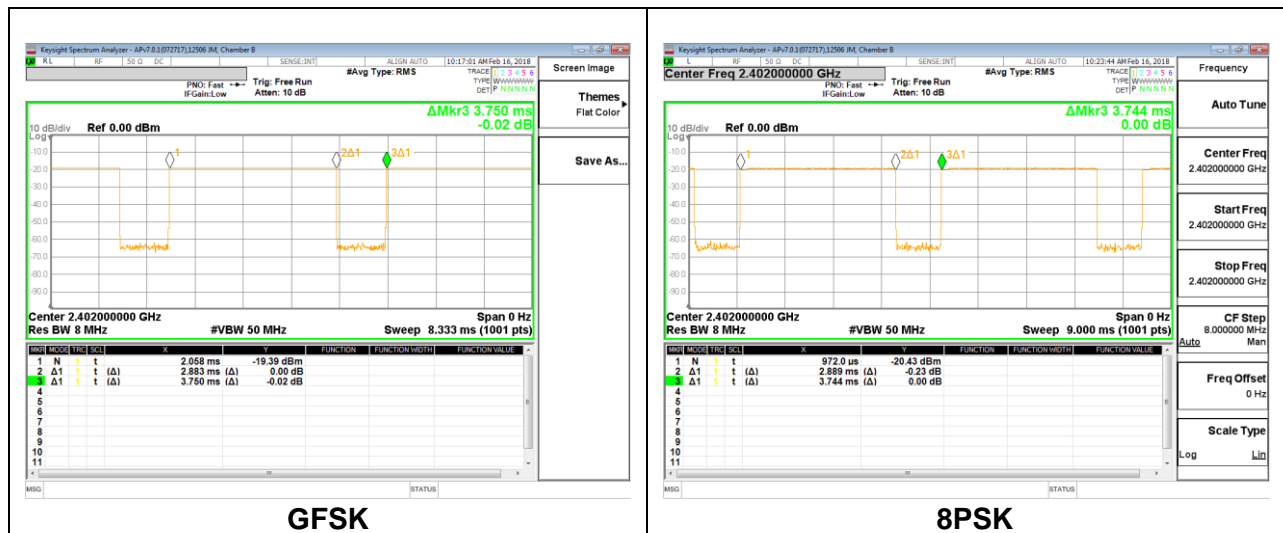

## **8.2. 20 dB AND 99% BANDWIDTH**

### **LIMITS**

None; for reporting purposes only.

### **TEST PROCEDURE**

The transmitter output is connected to a spectrum analyzer. The RBW is set to  $\geq 1\%$  of the 20 dB bandwidth. The VBW is set to  $\geq$  RBW. The sweep time is coupled.

### **RESULTS**



### 8.2.1. BLUETOOTH BASIC DATA RATE GFSK MODULATION

Channel	Frequency (MHz)	20dB Bandwidth (MHz)	99% Bandwidth (MHz)
Low	2402	0.94	0.86
Mid	2441	0.93	0.85
High	2480	0.93	0.85

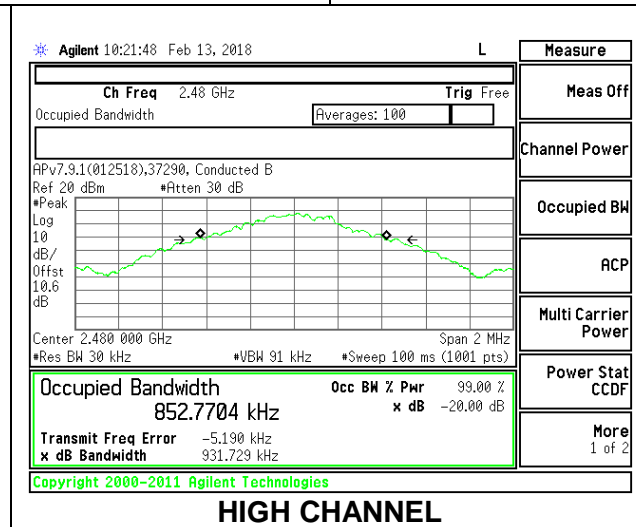
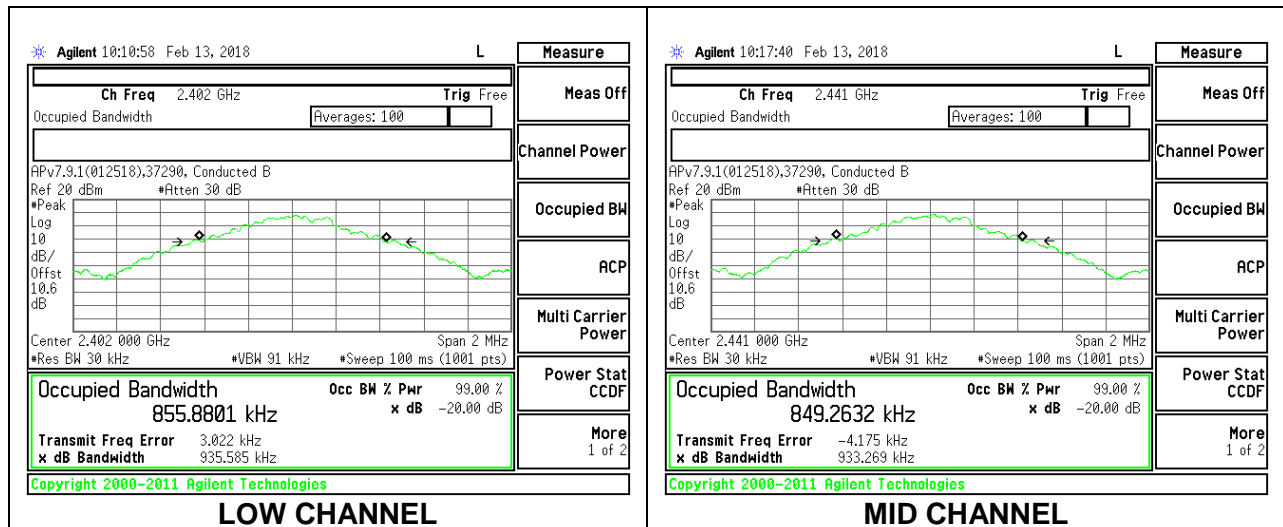

## 8.2.2. BLUETOOTH ENHANCED DATA RATE 8PSK MODULATION

Channel	Frequency (MHz)	20dB Bandwidth (MHz)	99% Bandwidth (MHz)
Low	2402	1.29	1.19
Mid	2441	1.29	1.20
High	2480	1.29	1.20

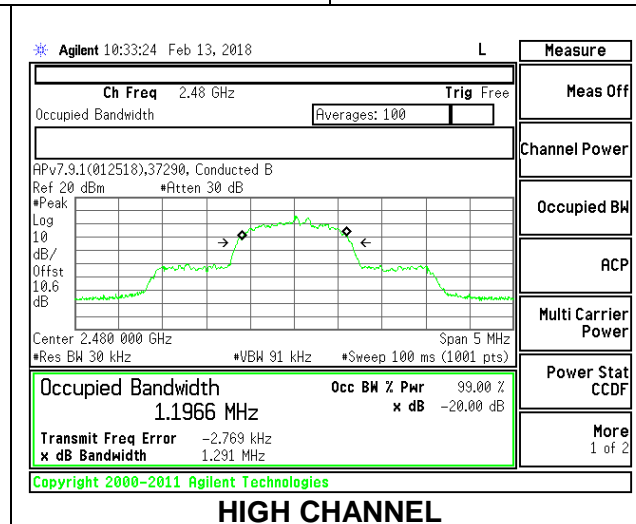
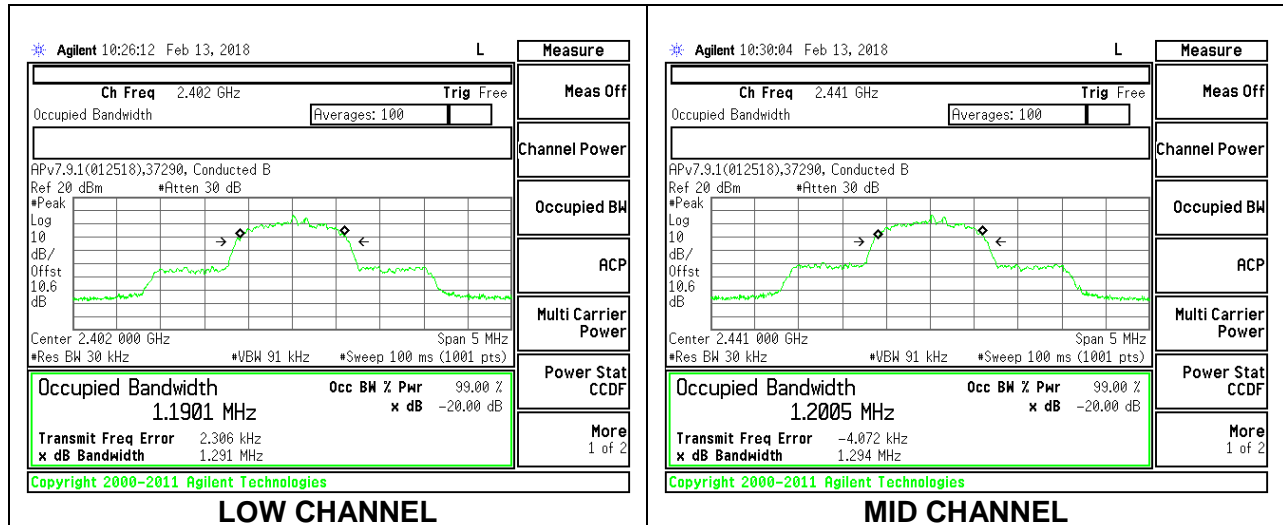

---

### **8.3. HOPPING FREQUENCY SEPARATION**

#### **LIMITS**

FCC §15.247 (a) (1)

Frequency hopping systems shall have hopping channel carrier frequencies separated by a minimum of 25 kHz or the 20 dB bandwidth of the hopping channel, whichever is greater.

Alternatively, frequency hopping systems operating in the 2400-2483.5 MHz band may have hopping channel carrier frequencies that are separated by 25 kHz or two-thirds of the 20 dB bandwidth of the hopping channel, whichever is greater, provided the systems operate with an output power no greater than 125 mW.

#### **TEST PROCEDURE**

The transmitter output is connected to a spectrum analyzer. The RBW is set to 300 kHz and the VBW is set to 910 kHz. The sweep time is coupled.

#### **RESULTS**

### 8.3.1. BLUETOOTH BASIC DATA RATE GFSK MODULATION

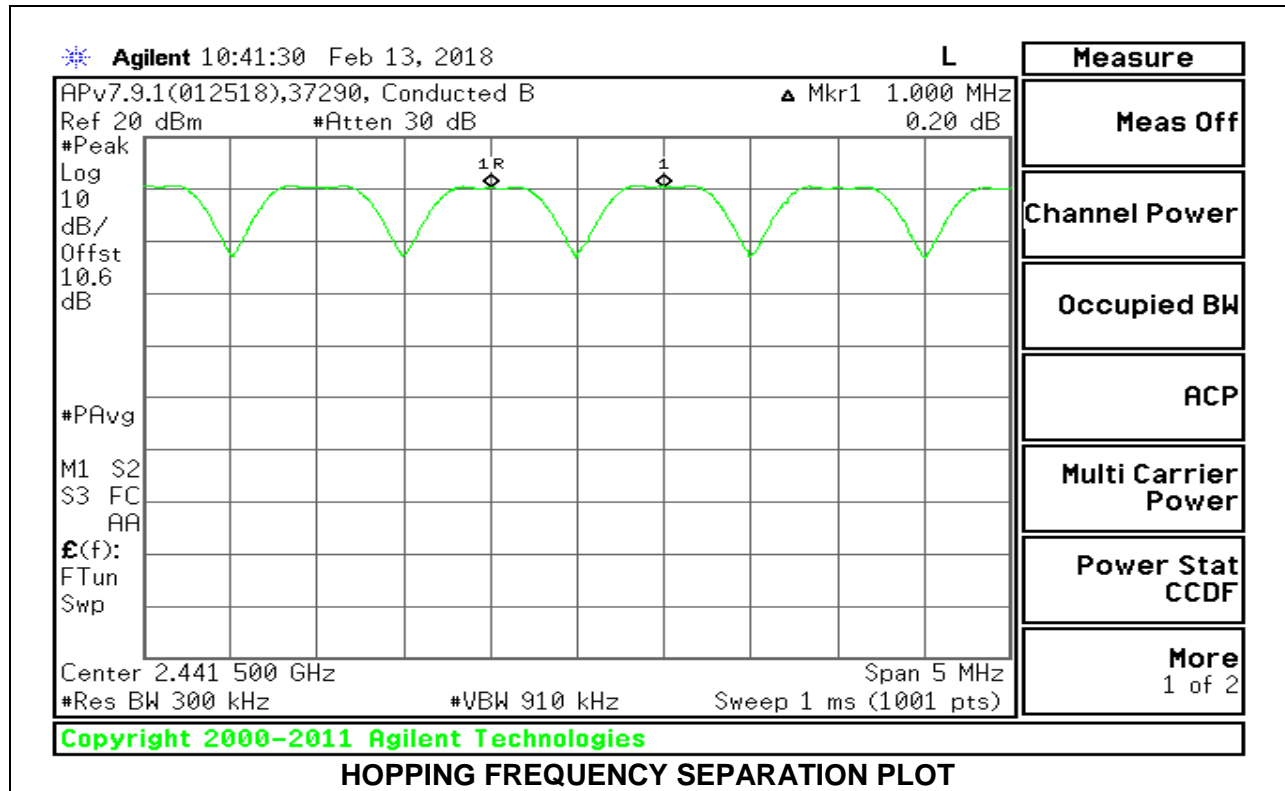

### 8.3.2. BLUETOOTH ENCHANCED DATA RATE 8PSK MODULATION

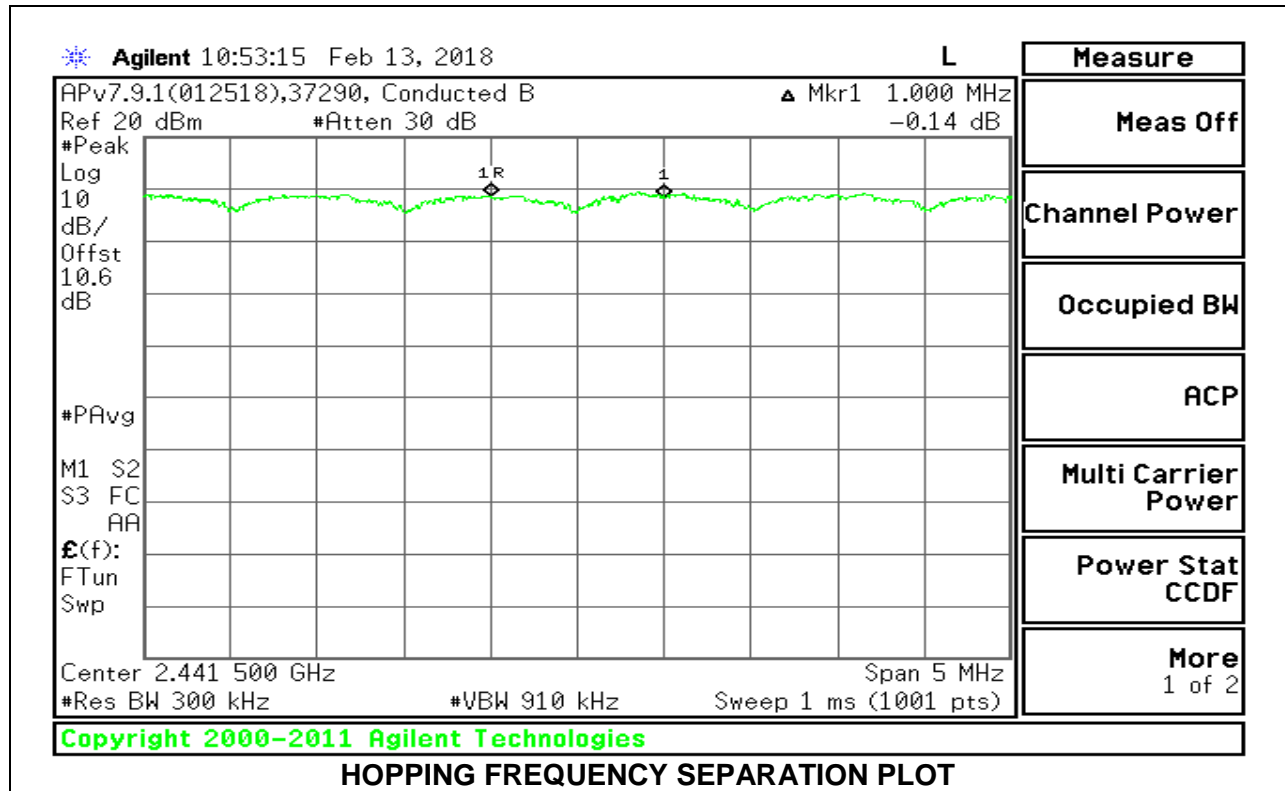

## **8.4. NUMBER OF HOPPING CHANNELS**

### **LIMITS**

FCC §15.247 (a) (1) (iii)

Frequency hopping systems in the 2400 – 2483.5 MHz band shall use at least 15 non-overlapping channels.

### **TEST PROCEDURE**

The transmitter output is connected to a spectrum analyzer. The span is set to cover the entire authorized band, in either a single sweep or in multiple contiguous sweeps. The RBW is set to a maximum of 1 % of the span. The analyzer is set to Max Hold.

### **RESULTS**

### 8.4.1. BLUETOOTH BASIC DATA RATE GFSK MODULATION

Normal Mode: 79 Channels observed.

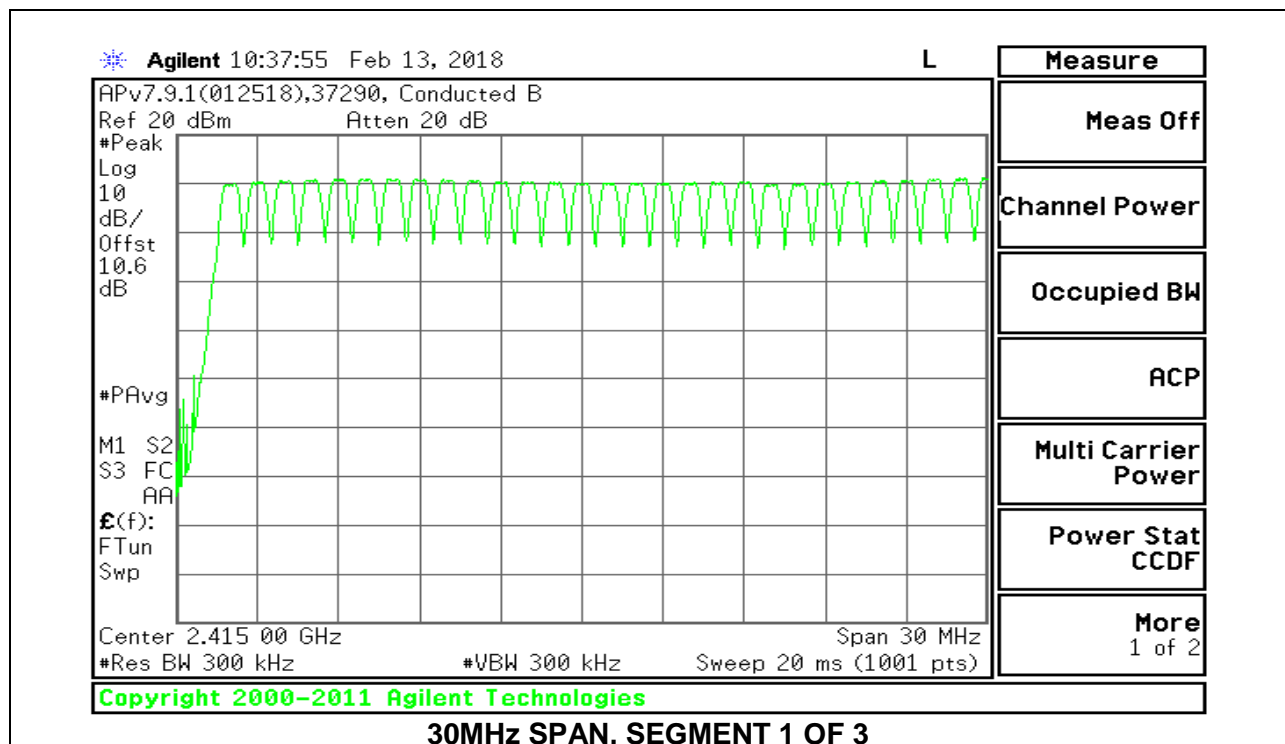
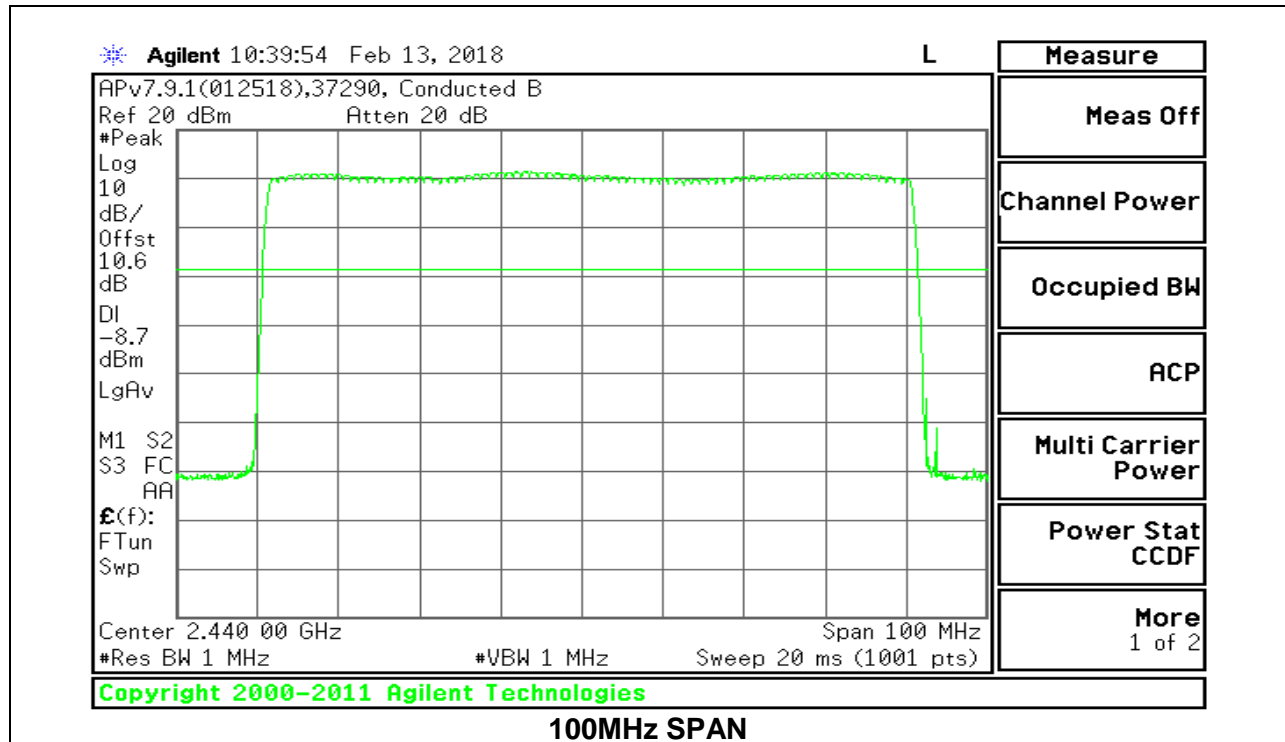

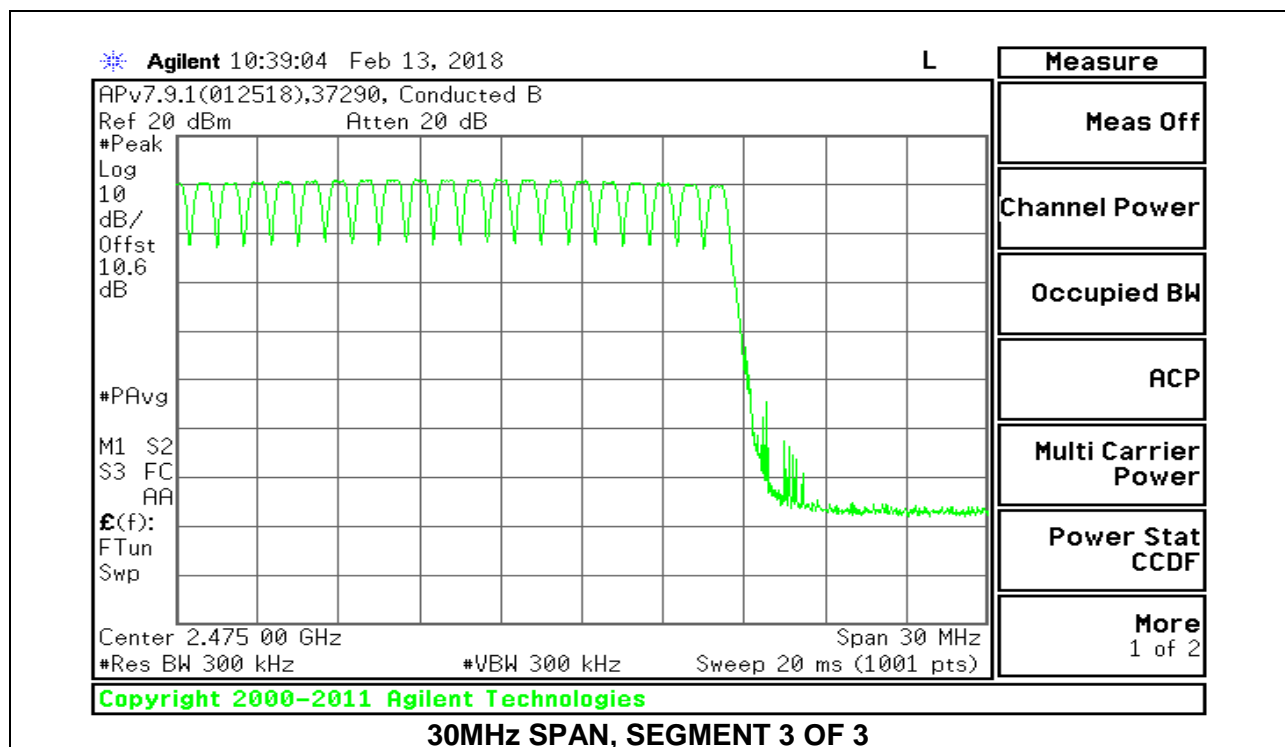
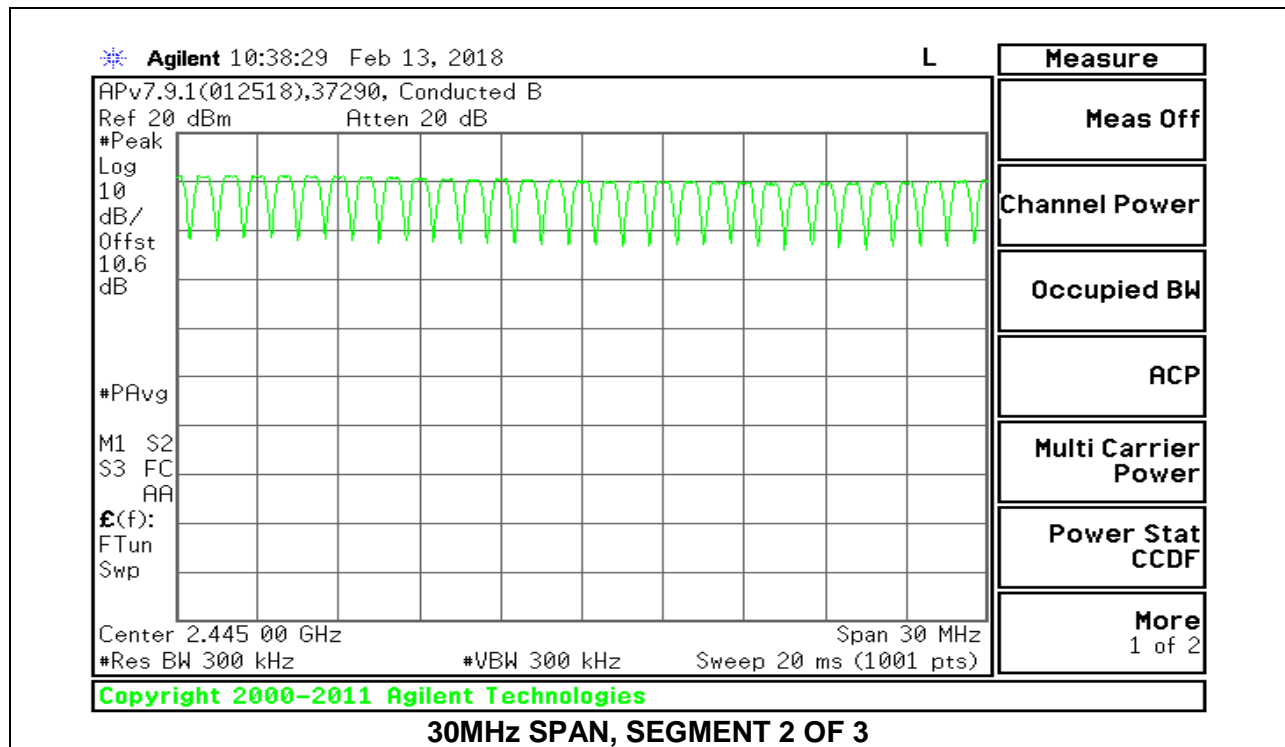



### 8.4.2. BLUETOOTH ENCHANCED DATA RATE 8PSK MODULATION

Normal Mode: 79 Channels observed.

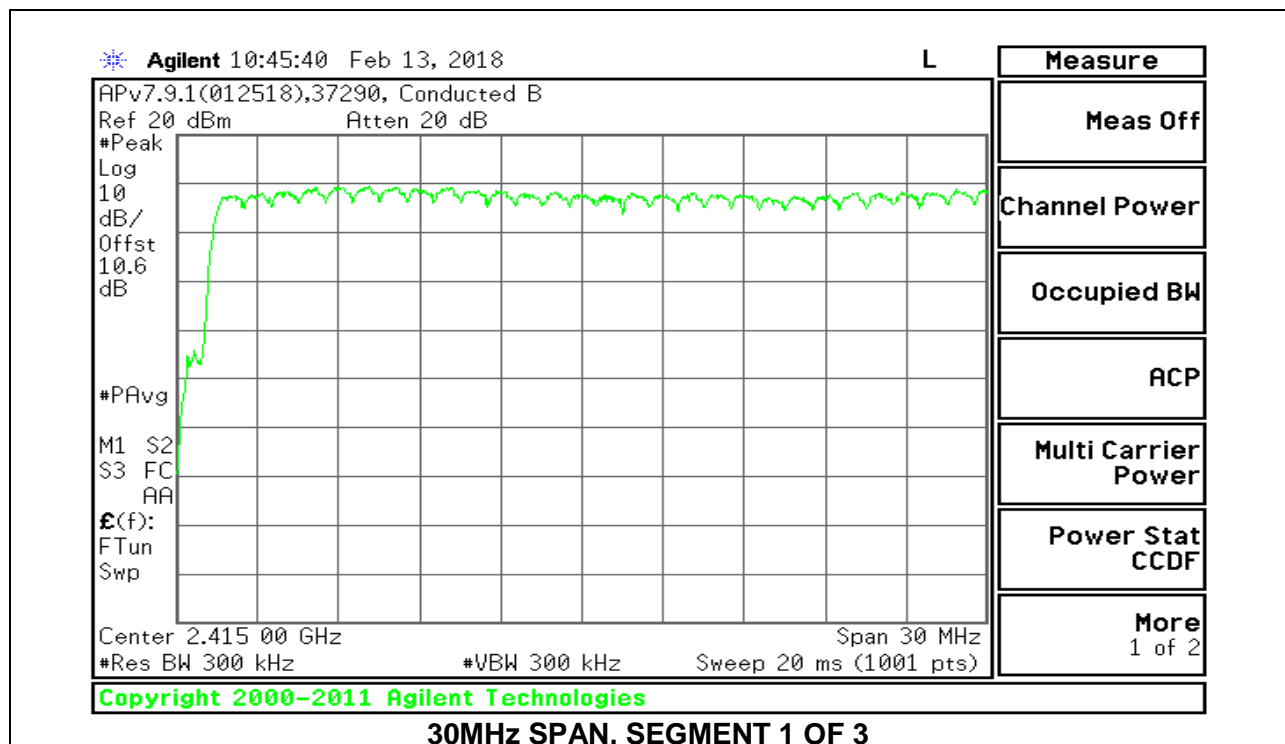
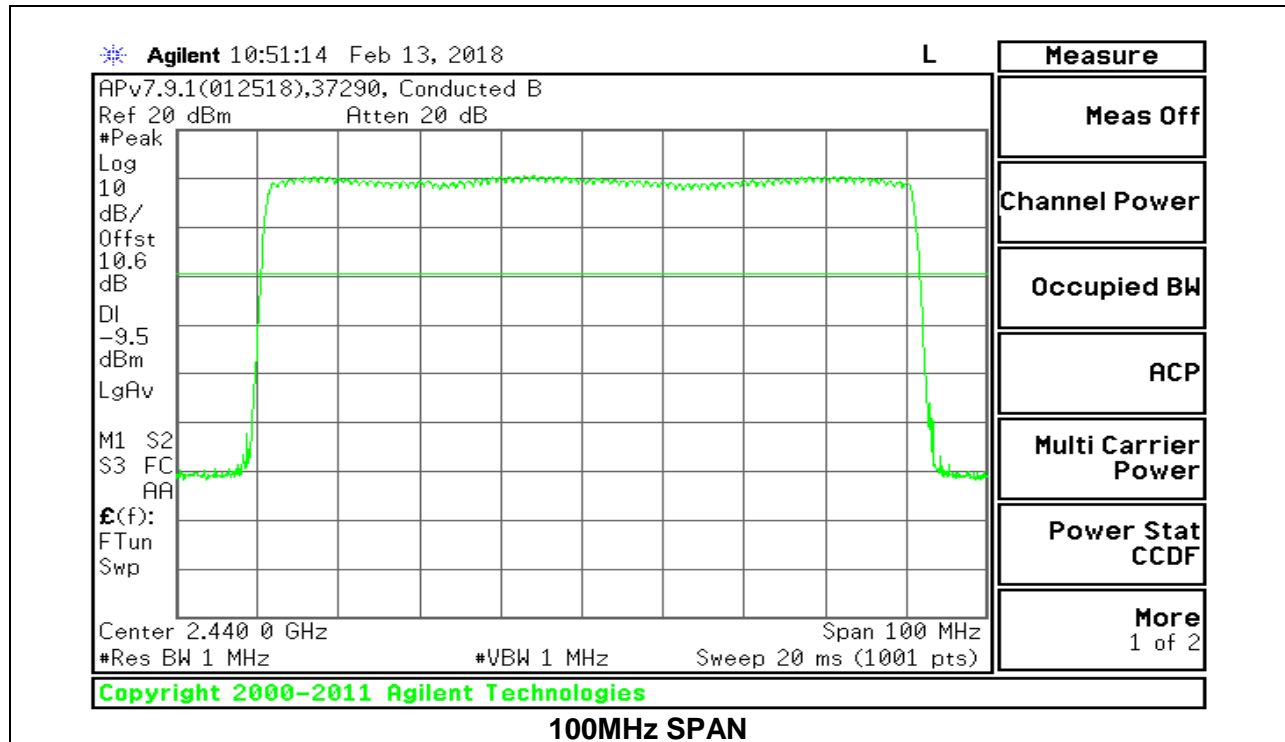

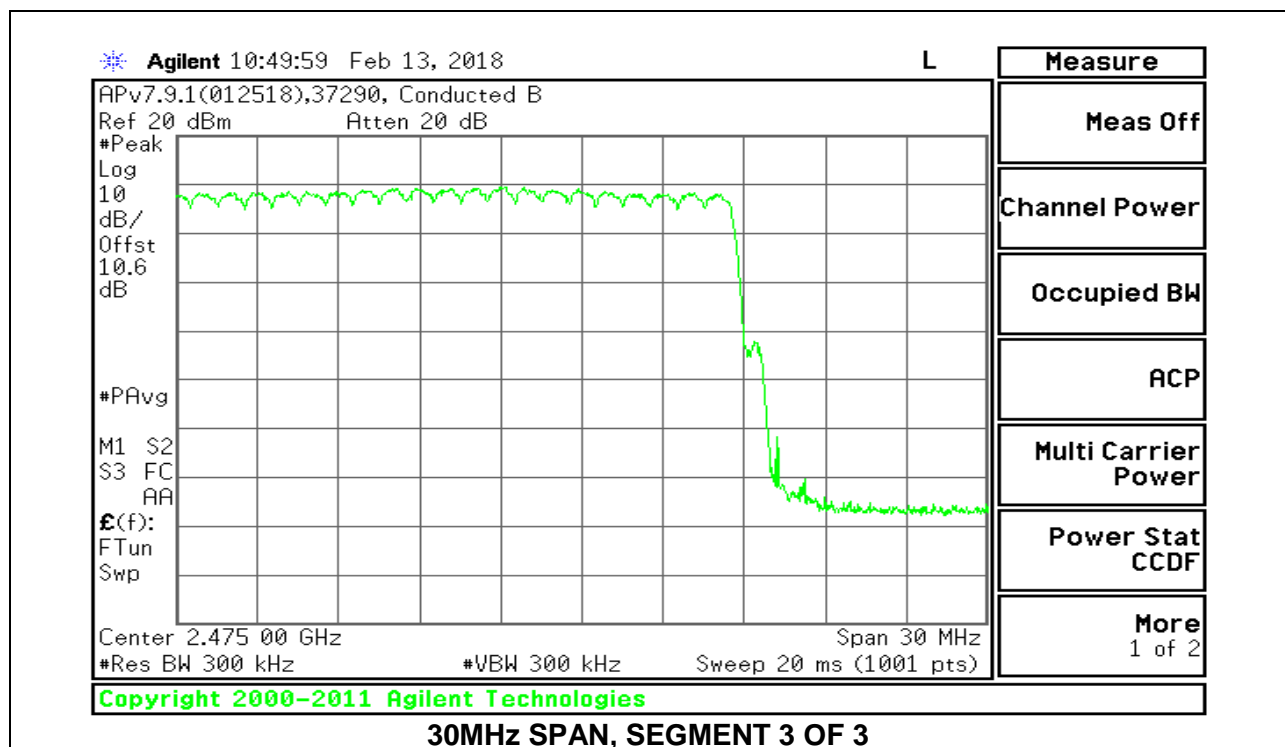
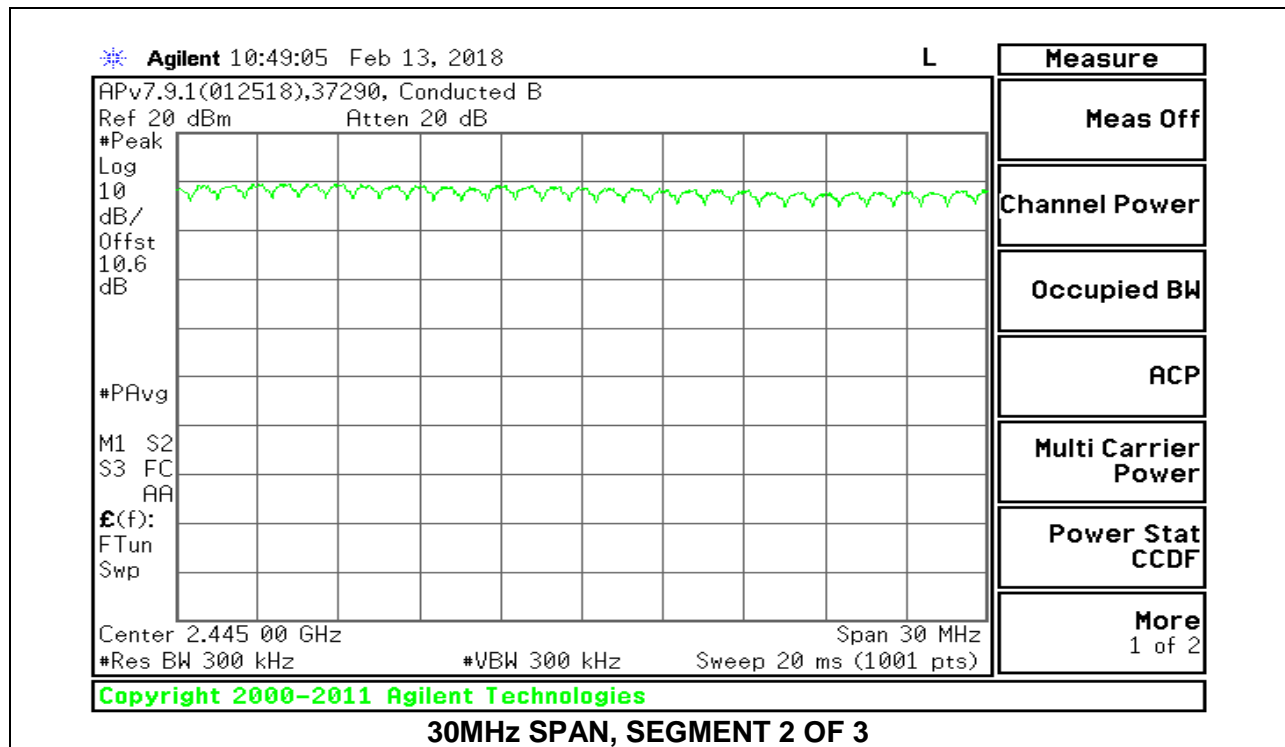

---

## 8.5. AVERAGE TIME OF OCCUPANCY

### LIMITS

FCC §15.247 (a) (1) (iii)

The average time of occupancy on any channel shall not be greater than 0.4 seconds within a period of 0.4 seconds multiplied by the number of hopping channels employed.

### TEST PROCEDURE

The transmitter output is connected to a spectrum analyzer. The span is set to 0 Hz, centered on a single, selected hopping channel. The width of a single pulse is measured in a fast scan. The number of pulses is measured in a 3.16 second scan, to enable resolution of each occurrence.

The average time of occupancy in the specified 3.16 second period (79 channels \* 0.4 s) is equal to  $10 * (\# \text{ of pulses in } 3.16 \text{ s}) * \text{ pulse width}$ .

For AFH mode, the average time of occupancy in the specified 8 second period (20 channels \* 0.4 seconds) is equal to  $10 * (\# \text{ of pulses in } 0.8 \text{ s}) * \text{ pulse width}$ .

### RESULTS

### 8.5.1. BLUETOOTH BASIC DATA RATE GFSK MODULATION

DH Packet	Pulse Width (msec)	Number of Pulses in 3.16 seconds	Average Time of Occupancy (sec)	Limit (sec)	Margin (sec)
<b>GFSK Normal Mode</b>					
DH1	0.383	32	0.1226	0.4	-0.2774
DH3	1.639	16	0.2622	0.4	-0.1378
DH5	2.887	10	0.2887	0.4	-0.1113
<b>GFSK AFH Mode</b>					
DH Packet	Pulse Width (sec)	Number of Pulses in 0.8 seconds	Average Time of Occupancy (sec)	Limit (sec)	Margin (sec)
<b>GFSK AFH Mode</b>					
DH1	0.383	8	0.03064	0.4	-0.3694
DH3	1.639	4	0.06556	0.4	-0.3344
DH5	2.887	2.5	0.07218	0.4	-0.3278

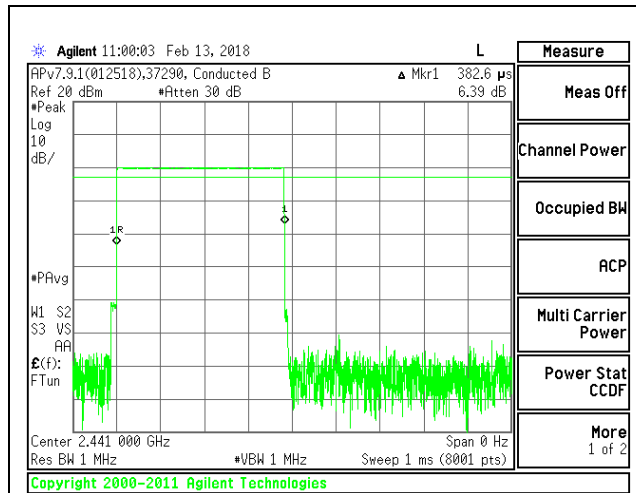

**PULSE WIDTH - DH1**

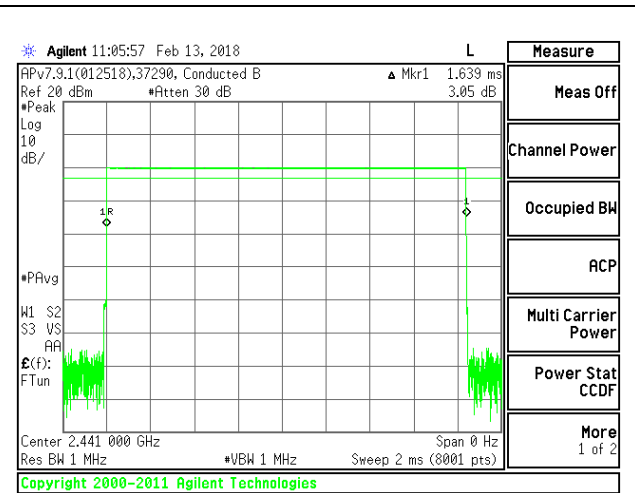

**PULSE WIDTH - DH3**

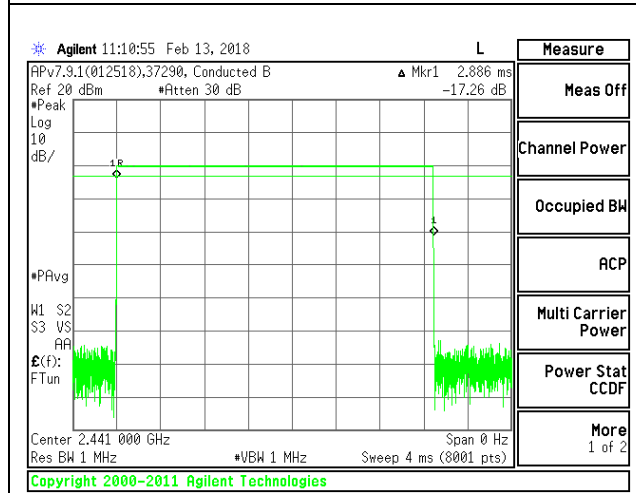

**PULSE WIDTH - DH5**

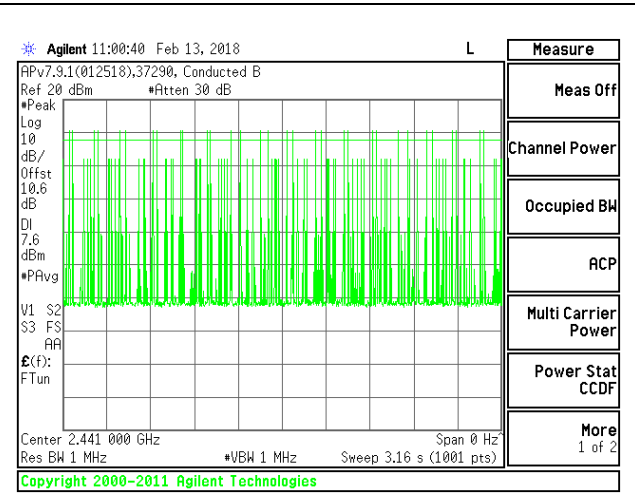

**NUMBER OF PULSES IN 3.16 SECOND OBSERVATION PERIOD - DH1**

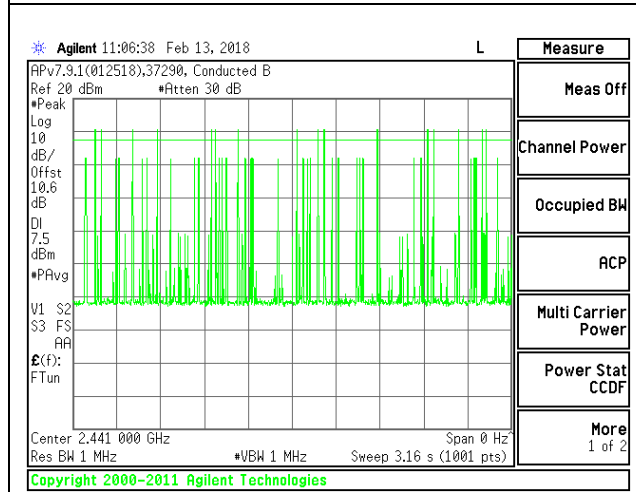

**NUMBER OF PULSES IN 3.16 SECOND OBSERVATION PERIOD - DH3**

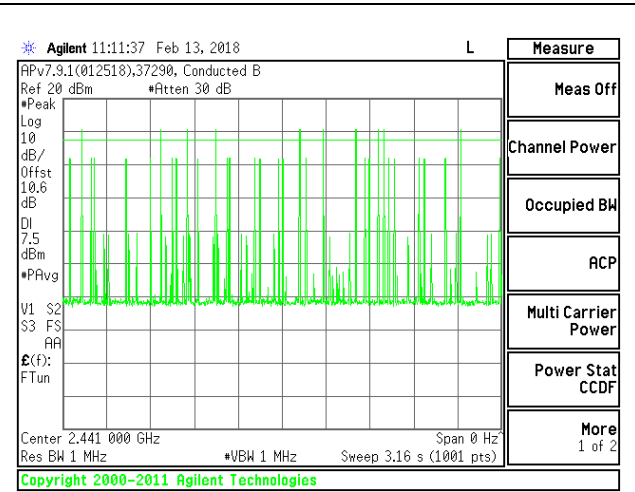

**NUMBER OF PULSES IN 3.16 SECOND OBSERVATION PERIOD - DH5**

## 8.5.2. BLUETOOTH ENCHANCED DATA RATE 8PSK MODULATION

DH Packet	Pulse Width (msec)	Number of Pulses in 3.16 seconds	Average Time of Occupancy (sec)	Limit (sec)	Margin (sec)
8PSK Normal Mode					
DH1	0.388	31	0.12028	0.4	-0.27972
DH3	1.639	14	0.22946	0.4	-0.17054
DH5	2.89	14	0.4046	0.4	0.0046

Note: for AFH (8PSK) mode, please refer to the results of AFH (GFSK) mode; the channel selection and hopping rate are the same for both EDR and Basic Rate operation, data for Basic Rate in section 4.5.1 demonstrates compliance with channel occupancy when AFH is employed.

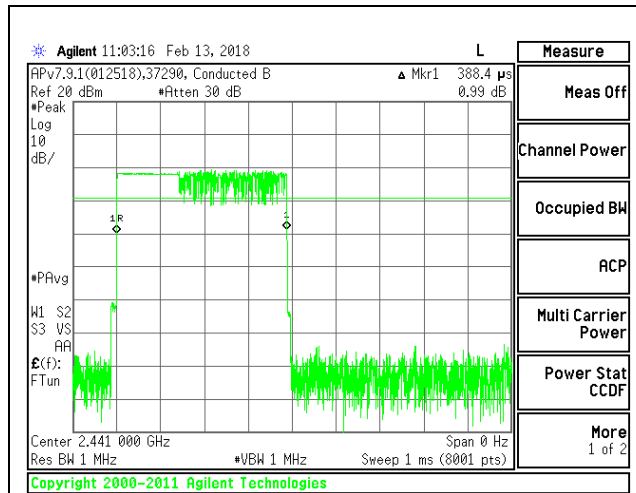

**PULSE WIDTH - DH1**

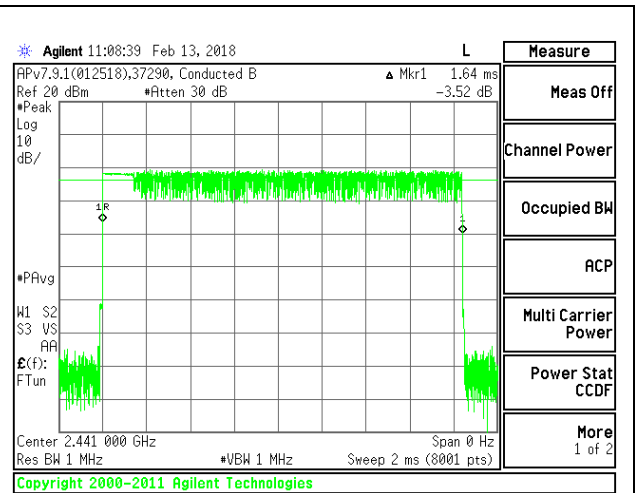

**PULSE WIDTH - DH3**

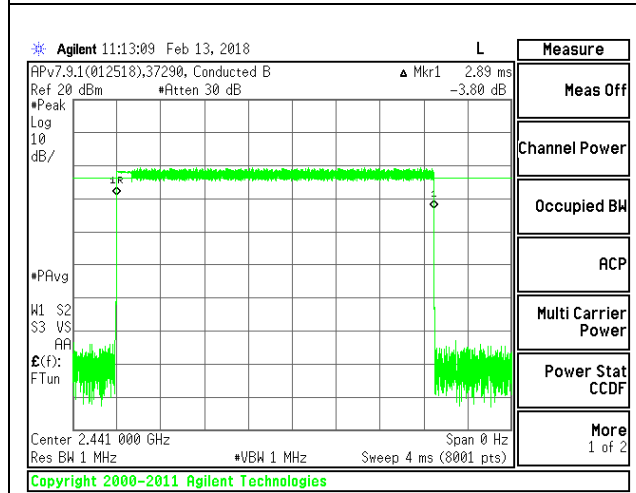

**PULSE WIDTH - DH5**

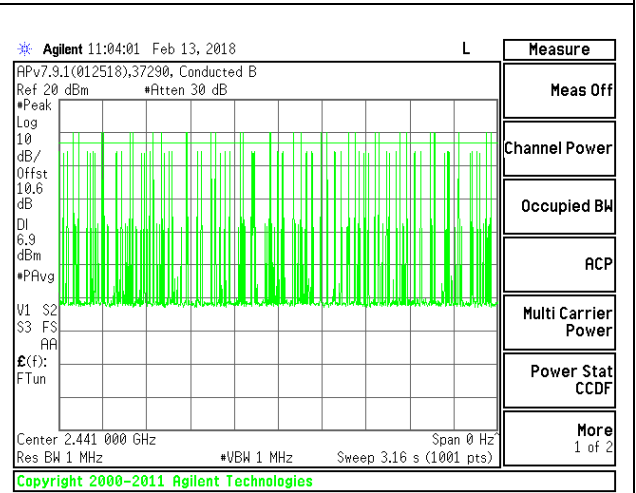

**NUMBER OF PULSES IN 3.16 SECOND OBSERVATION PERIOD - DH1**

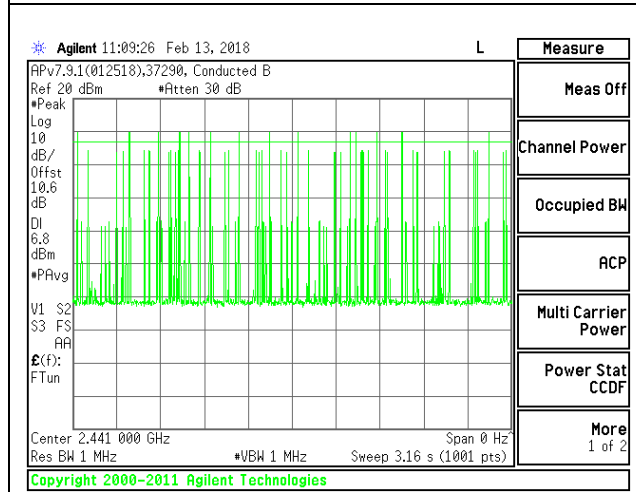

**NUMBER OF PULSES IN 3.16 SECOND OBSERVATION PERIOD - DH3**

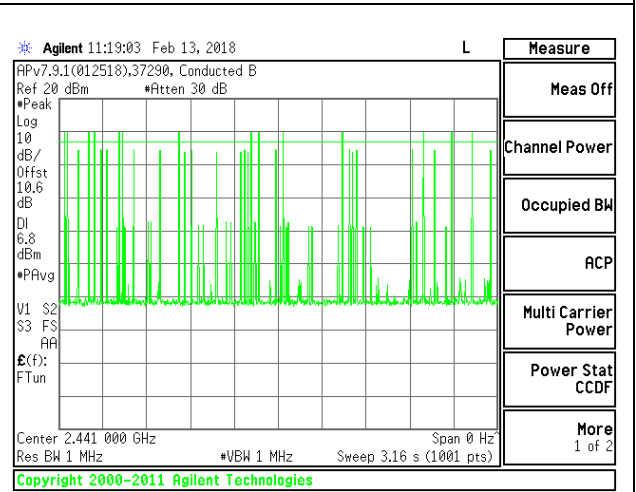

**NUMBER OF PULSES IN 3.16 SECOND OBSERVATION PERIOD - DH5**

## **8.6. OUTPUT POWER**

### **LIMITS**

§15.247 (b) (1)

For frequency hopping systems operating in the 2400-2483.5 MHz band employing at least 75 non-overlapping hopping channels the limit shall not be greater than 30dBm. For all other frequency hopping systems in the 2400-2483.5 MHz band the limit shall not be greater than 21dBm.

### **TEST PROCEDURE**

The transmitter output is connected to a power meter. The power meter is gated to measure average power during the ON time of the transmitter.

### **RESULTS**



### 8.6.1. BLUETOOTH BASIC DATA RATE GFSK MODULATION

Tested By:	43578 GE
Date:	2/12/2018

Channel	Frequency (MHz)	Output Power (dBm)	Limit (dBm)	Margin (dB)
Low	2402	9.40	30	-20.60
Middle	2441	<b>10.10</b>	30	-19.90
High	2480	9.42	30	-20.58

## 8.6.2. BLUETOOTH ENCHANCED DATA RATE 8PSK MODULATION

Tested By:	GE 43578
Date:	2/23/2018

Channel	Frequency (MHz)	Output Power (dBm)	Limit (dBm)	Margin (dB)
Low	2402	7.52	21	-13.48
Middle	2441	<b>8.45</b>	21	-12.55
High	2480	6.60	21	-14.40

## **8.7. AVERAGE POWER**

### **LIMITS**

None; for reporting purposes only

### **TEST PROCEDURE**

The transmitter output is connected to a power meter. The power meter is gated to measure average power during the ON time of the transmitter.

### **RESULTS**

### 8.7.1. BLUETOOTH BASIC DATA RATE GFSK MODULATION

Tested By:	GE43578
Date	2/12/2018

Channel	Frequency (MHz)	Average Power (dBm)
Low	2402	9.25
Middle	2441	<b>9.97</b>
High	2480	9.29

## 8.7.2. BLUETOOTH ENCHANCED DATA RATE 8PSK MODULATION

Tested By:	GE43578
Date	2/12/2018

Channel	Frequency (MHz)	Average Power (dBm)
Low	2402	7.25
Middle	2441	<b>8.28</b>
High	2480	6.41

---

## **8.8. CONDUCTED SPURIOUS EMISSIONS**

### **LIMITS**

FCC §15.247 (d)

Limit = -20 dBc

### **TEST PROCEDURE**

The transmitter output is connected to a spectrum analyzer. The resolution bandwidth is set to 100 kHz. The video bandwidth is set to 300 kHz.

The spectrum from 30 MHz to 26 GHz is investigated with the transmitter set to the lowest, middle, and highest channels.

The bandedges at 2.4 and 2.4835 GHz are investigated with the transmitter set to the normal hopping mode.

### **RESULTS**

## 8.8.1. BLUETOOTH BASIC DATA RATE GFSK MODULATION

### SPURIOUS EMISSIONS, NON-HOPPING

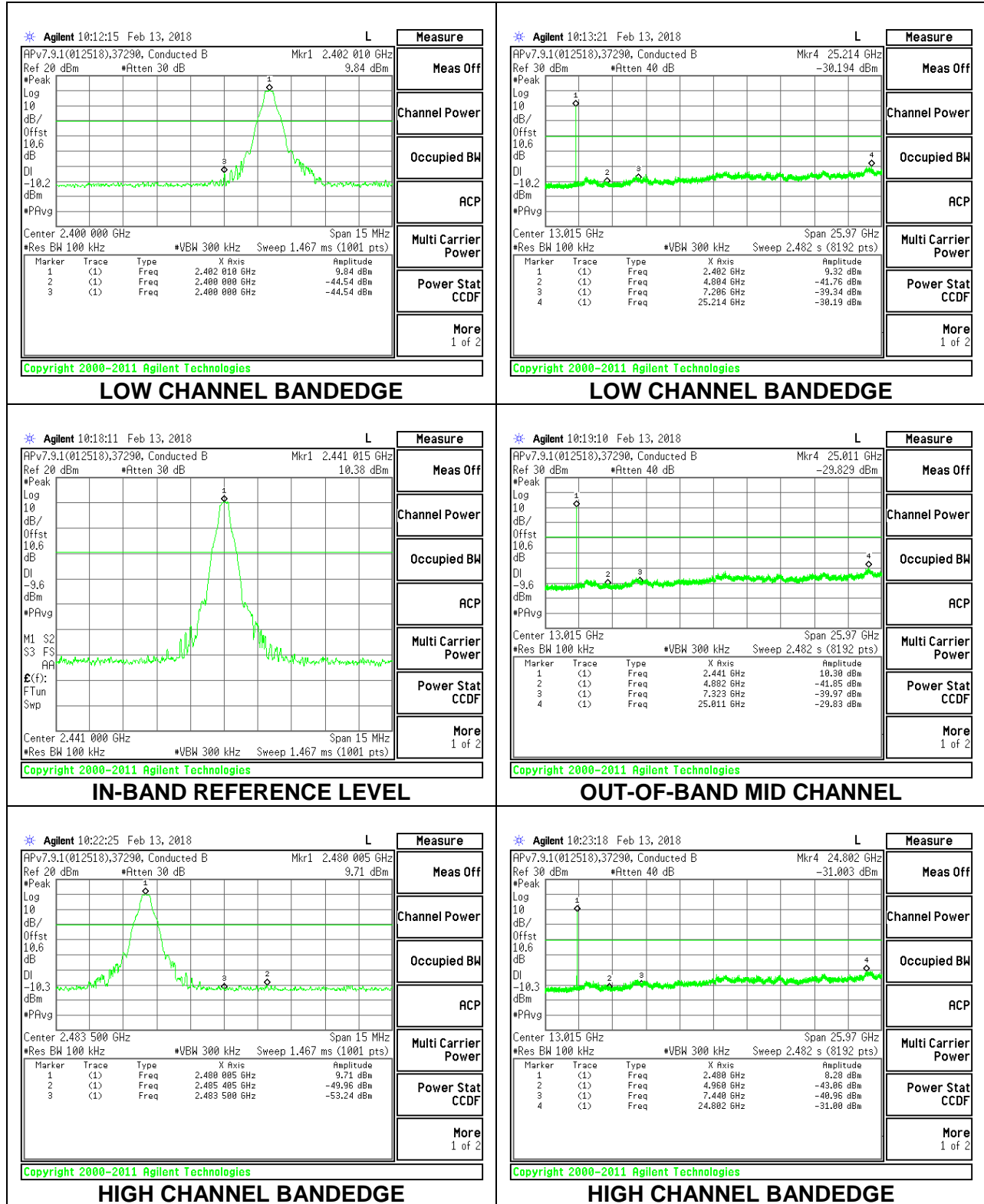

**SPURIOUS BANDEGE EMISSIONS WITH HOPPING ON**

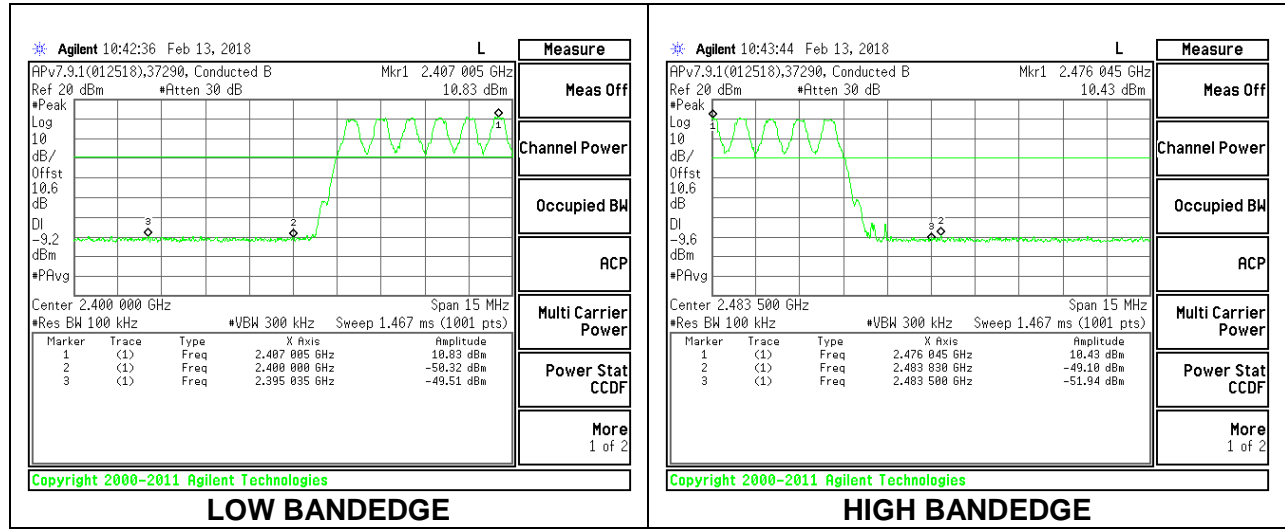



## 8.8.2. BLUETOOTH ENHANCED DATA RATE 8PSK MODULATION

### SPURIOUS EMISSIONS, NON-HOPPING

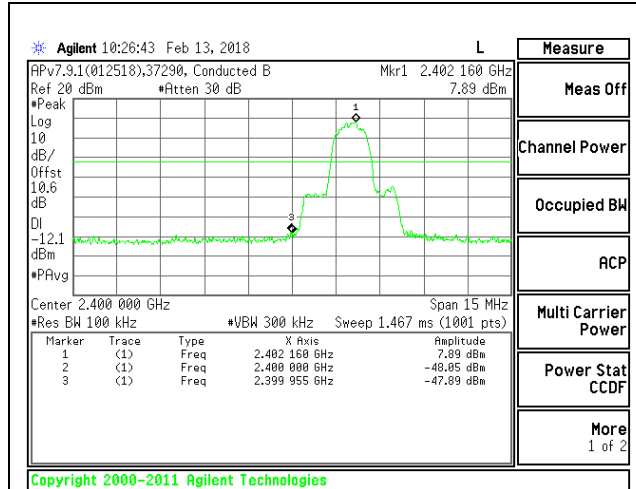

**LOW CHANNEL BANDEGE**

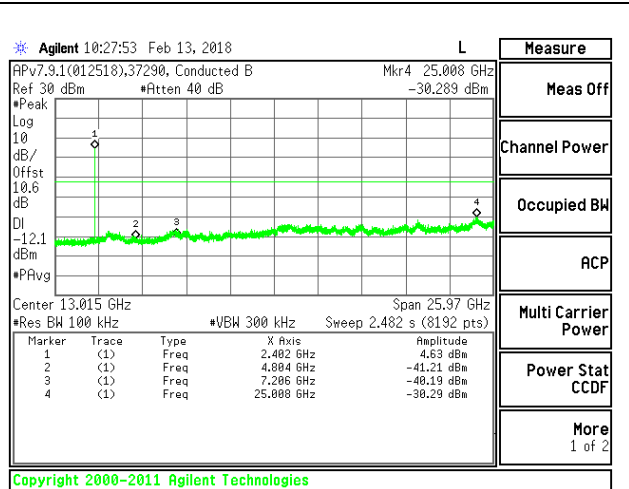

**LOW CHANNEL BANDEGE**

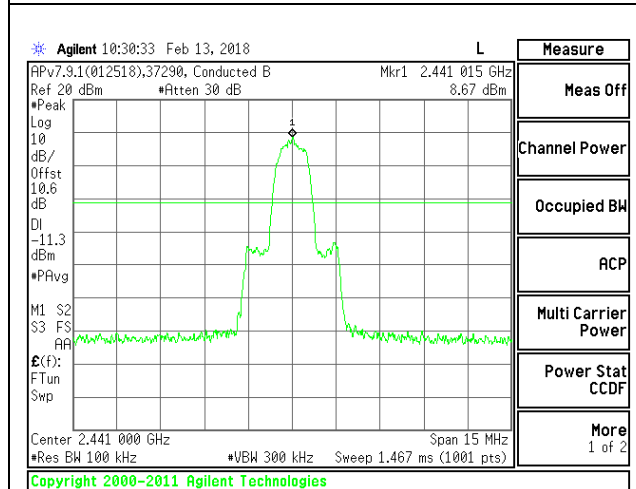

**IN-BAND REFERENCE LEVEL**

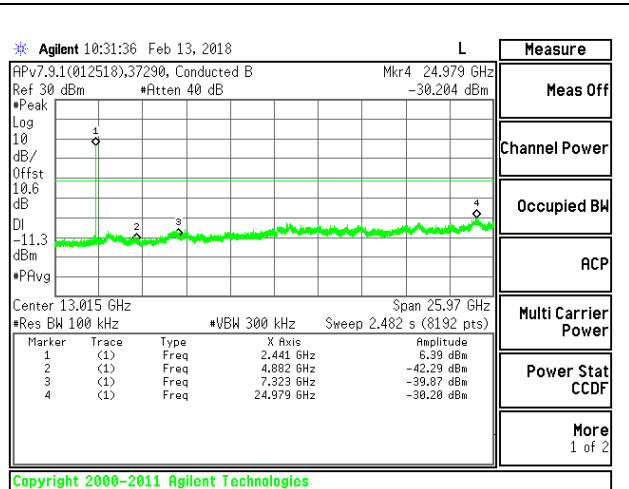

**OUT-OF-BAND MID CHANNEL**

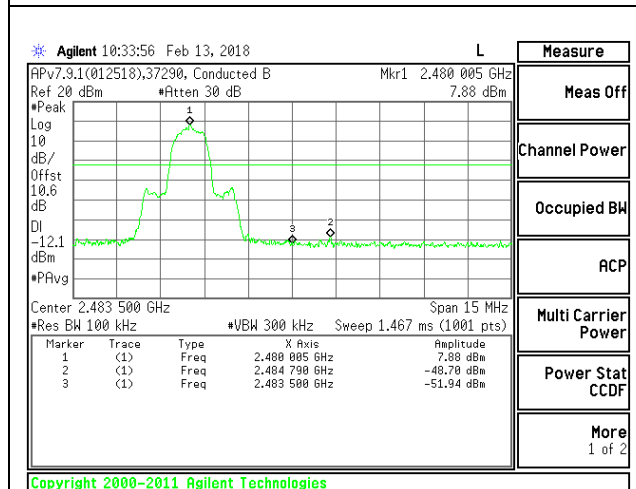

**HIGH CHANNEL BANDEGE**

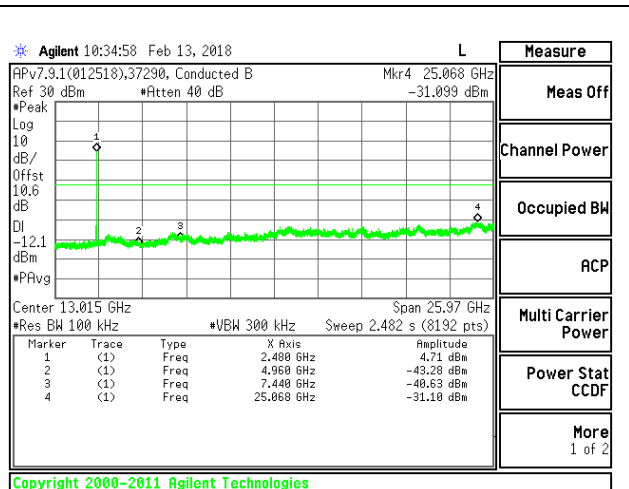

**HIGH CHANNEL BANDEGE**

**SPURIOUS BANDEGE EMISSIONS WITH HOPPING ON**

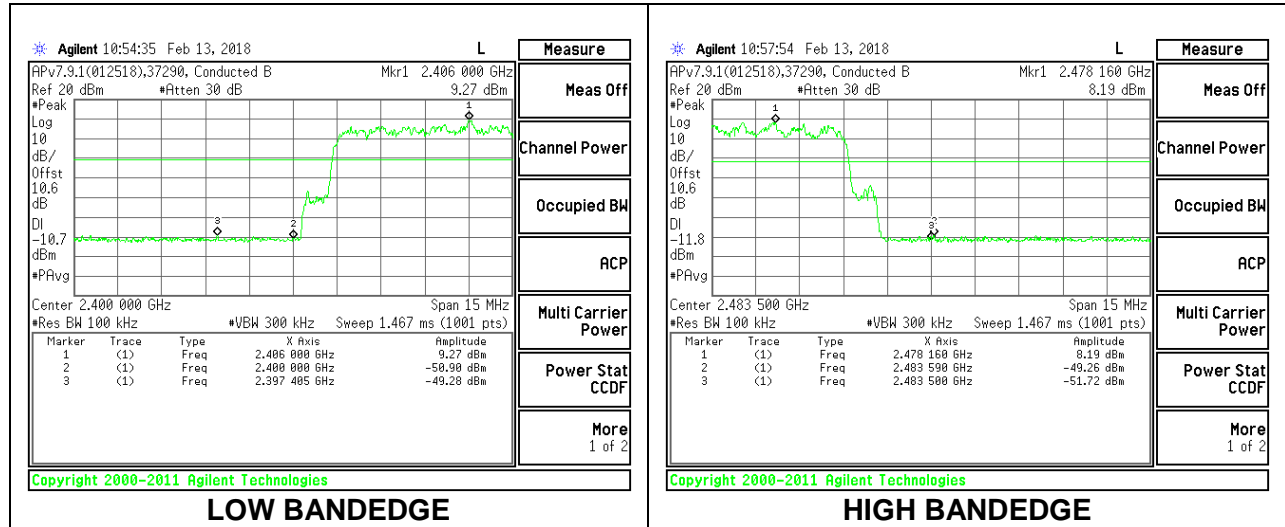

## 9. RADIATED TEST RESULTS

### LIMITS

FCC §15.205 and §15.209

Frequency Range (MHz)	Field Strength Limit (uV/m) at 3 m	Field Strength Limit (dBuV/m) at 3 m
0.009-0.490	2400/F(kHz) @ 300 m	-
0.490-1.705	24000/F(kHz) @ 30 m	-
1.705 - 30	30 @ 30m	-
30 - 88	100	40
88 - 216	150	43.5
216 - 960	200	46
Above 960	500	54

### TEST PROCEDURE

The EUT is placed on a non-conducting table 80 cm above the ground plane for measurement below 1GHz; 1.5 m above the ground plane for measurement above 1GHz. The antenna to EUT distance is 3 meters. The EUT is configured in accordance with ANSI C63.10. The EUT is set to transmit in a continuous mode.

For measurements below 1 GHz the resolution bandwidth is set to 100 kHz for peak detection measurements or 120 kHz for quasi-peak detection measurements. Peak detection is used unless otherwise noted as quasi-peak.

For pre-scans above 1 GHz the resolution bandwidth is set to 1 MHz; the video bandwidth is set to 30 KHz for peak measurements.

For final measurements above 1 GHz the resolution bandwidth is set to 1 MHz; the video bandwidth is set to 3 MHz for peak measurements and as applicable for average measurements.

The spectrum from 1 GHz to 18 GHz is investigated with the transmitter set to the lowest, middle, and highest channels in each applicable band. Below 30MHz, below 1GHz and above 18GHz emissions, the channel with the highest output power was tested.

The frequency range of interest is monitored at a fixed antenna height and EUT azimuth. The EUT is rotated through 360 degrees to maximize emissions received. The antenna is scanned from 1 to 4 meters above the ground plane to further maximize the emission. Measurements are made with the antenna polarized in both the vertical and the horizontal positions.

## 9.1. TRANSMITTER ABOVE 1 GHz

### 9.1.1. BLUETOOTH BASIC DATA RATE GFSK MODULATION

#### BANDEDGE (LOW CHANNEL)

#### HORIZONTAL RESULT

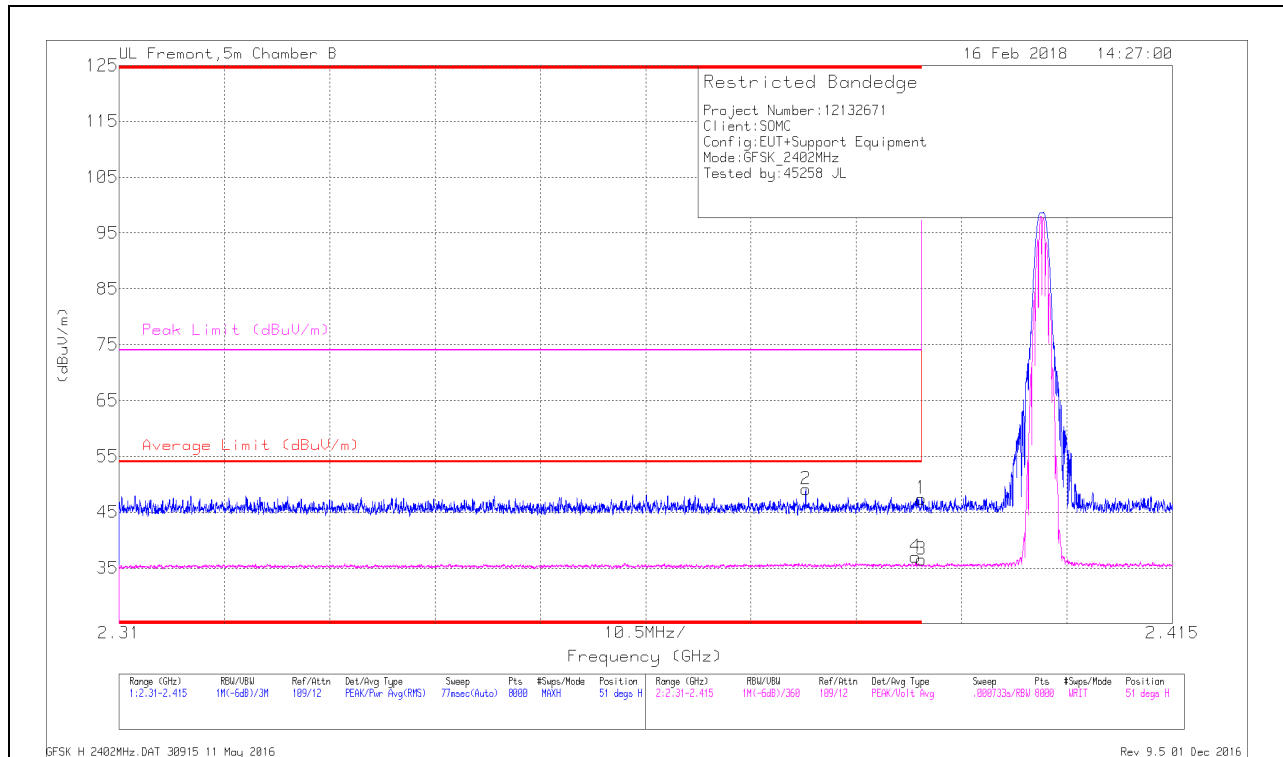

Marker	Frequency (GHz)	Meter Reading (dBuV)	Det	AF T863 (dB/m)	Amp/Cb/Fitr/P ad (dB)	Corrected Reading (dBuV/m)	Average Limit (dBuV/m)	Margin (dB)	Peak Limit (dBuV/m)	PK Margin (dB)	Azimuth (Degs)	Height (cm)	Polarity
1	* 2.39	36.72	Pk	32	-21.3	47.42	-	-	74	-26.58	51	201	H
2	* 2.378	38.49	Pk	31.9	-21.3	49.09	-	-	74	-24.91	51	201	H
3	* 2.39	24.66	VA1T	32	-21.3	35.36	54	-18.64	-	-	51	201	H
4	* 2.389	25.18	VA1T	32	-21.3	35.88	54	-18.12	-	-	51	201	H

\* - indicates frequency in CFR47 Pt 15 - Restricted Band

Pk - Peak detector

VA1T - FHSS: Linear Voltage Average  $V_B=1/T_{on}$  where:  $T_{on}$  is transmit duration

### VERTICAL RESULT



Marker	Frequency (GHz)	Meter Reading (dBuV)	Det	AF T863 (dB/m)	Amp/Cbl/Filtr/P ad (dB)	Corrected Reading (dBuV/m)	Average Limit (dBuV/m)	Margin (dB)	Peak Limit (dBuV/m)	PK Margin (dB)	Azimuth (Degs)	Height (cm)	Polarity
1	* 2.39	34.8	Pk	32	-21.3	45.5	-	-	74	-28.5	300	267	V
2	* 2.382	37.83	Pk	32	-21.3	48.53	-	-	74	-25.47	300	267	V
3	* 2.39	24.49	VA1T	32	-21.3	35.19	54	-18.81	-	-	300	267	V
4	* 2.39	25.12	VA1T	32	-21.3	35.82	54	-18.18	-	-	300	267	V

\* - indicates frequency in CFR47 Pt 15 - Restricted Band

Pk - Peak detector

VA1T - FHSS: Linear Voltage Average  $V_B=1/T_{on}$  where:  $T_{on}$  is transmit duration

**BANDEDGE (HIGH CHANNEL)**

**HORIZONTAL RESULT**

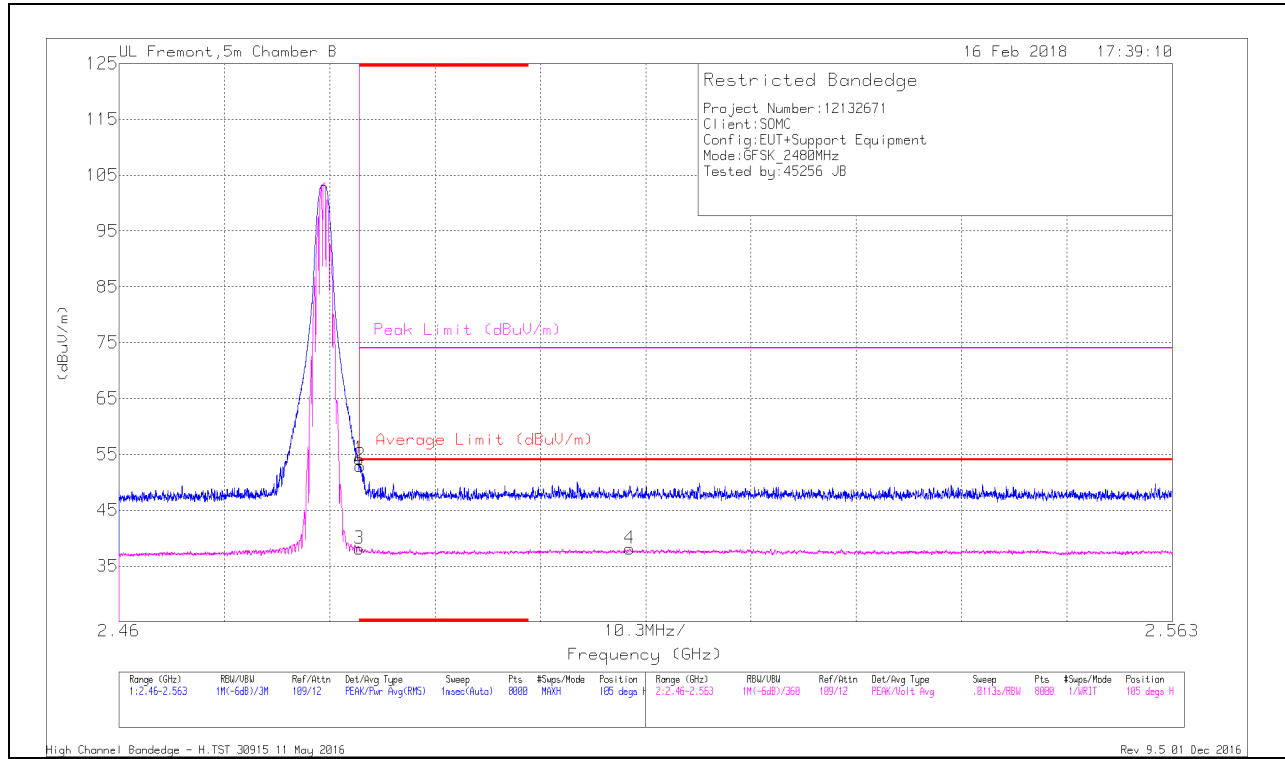

Marker	Frequency (GHz)	Meter Reading (dBuV)	Det	AF T863 (dB/m)	Amp/Cb/Filt/ Pad (dB)	Corrected Reading (dBuV/m)	Average Limit (dBuV/m)	Margin (dB)	Peak Limit (dBuV/m)	PK Margin (dB)	Azimuth (Degs)	Height (cm)	Polarity
1	* 2.484	43.01	Pk	32.5	-21.3	54.21	-	-	74	-19.79	105	219	H
2	* 2.484	41.73	Pk	32.5	-21.3	52.93	-	-	74	-21.07	105	219	H
3	* 2.484	25.78	VA1T	32.5	-21.3	36.98	54	-17.02	-	-	105	219	H
4	2.51	25.37	VA1T	32.6	-21	36.97	54	-17.03	-	-	105	219	H

\* - indicates frequency in CFR47 Pt 15 - Restricted Band

Pk - Peak detector

VA1T - FHSS: Linear Voltage Average VB=1/Ton where: Ton is transmit duration

### VERTICAL RESULT

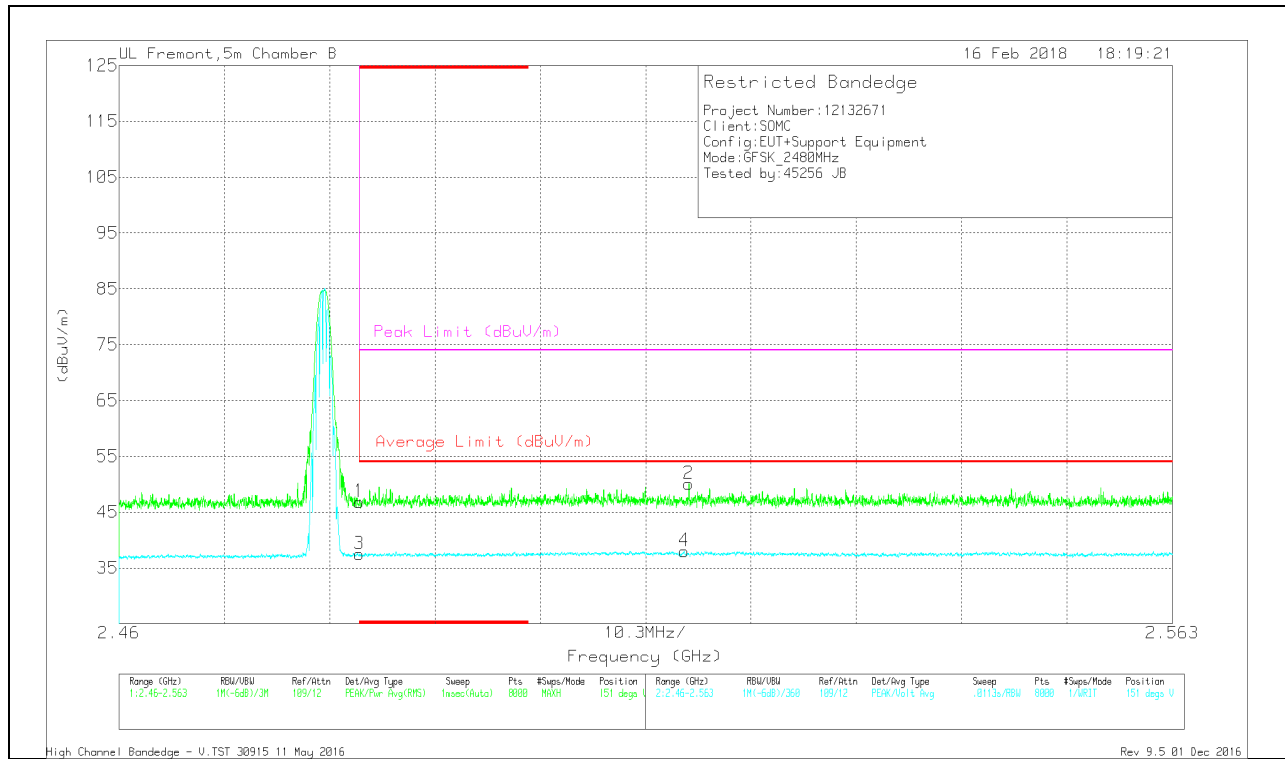

Marker	Frequency (GHz)	Meter Reading (dBuV)	Det	AF T863 (dB/m)	Amp/Cbl/Fitr/Pad (dB)	Corrected Reading (dBuV/m)	Average Limit (dBuV/m)	Margin (dB)	Peak Limit (dBuV/m)	PK Margin (dB)	Azimuth (Degs)	Height (cm)	Polarity
1	* 2.484	35.63	Pk	32.5	-21.3	46.83	-	-	74	-27.17	151	257	V
3	* 2.484	25.16	VA1T	32.5	-21.3	36.36	54	-17.64	-	-	151	257	V
4	2.515	25.38	VA1T	32.6	-21.1	36.88	54	-17.12	-	-	151	257	V
2	2.516	38.58	Pk	32.6	-21.1	50.08	-	-	74	-23.92	151	257	V

\* - indicates frequency in CFR47 Pt 15 - Restricted Band

Pk - Peak detector

VA1T - FHSS: Linear Voltage Average  $V_B=1/T_{on}$  where:  $T_{on}$  is transmit duration

## HARMONICS AND SPURIOUS EMISSIONS

### LOW CHANNEL RESULTS

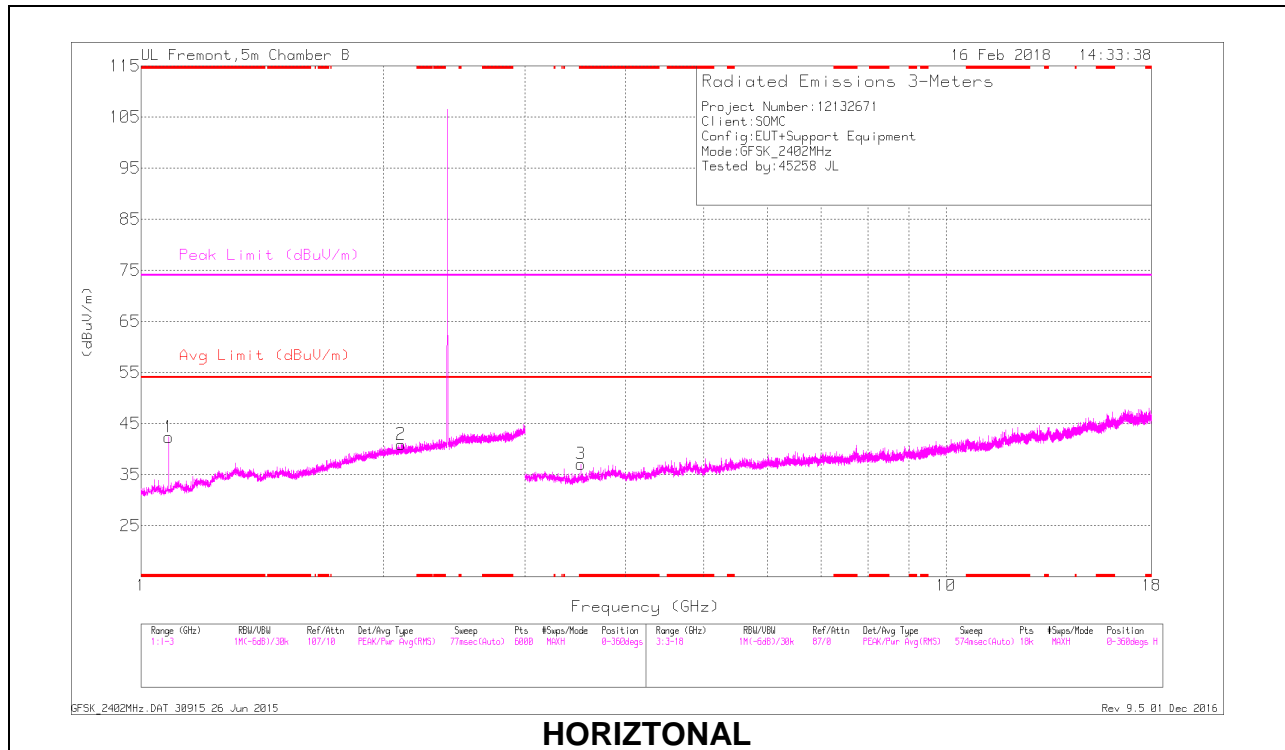

**HORIZONTAL**

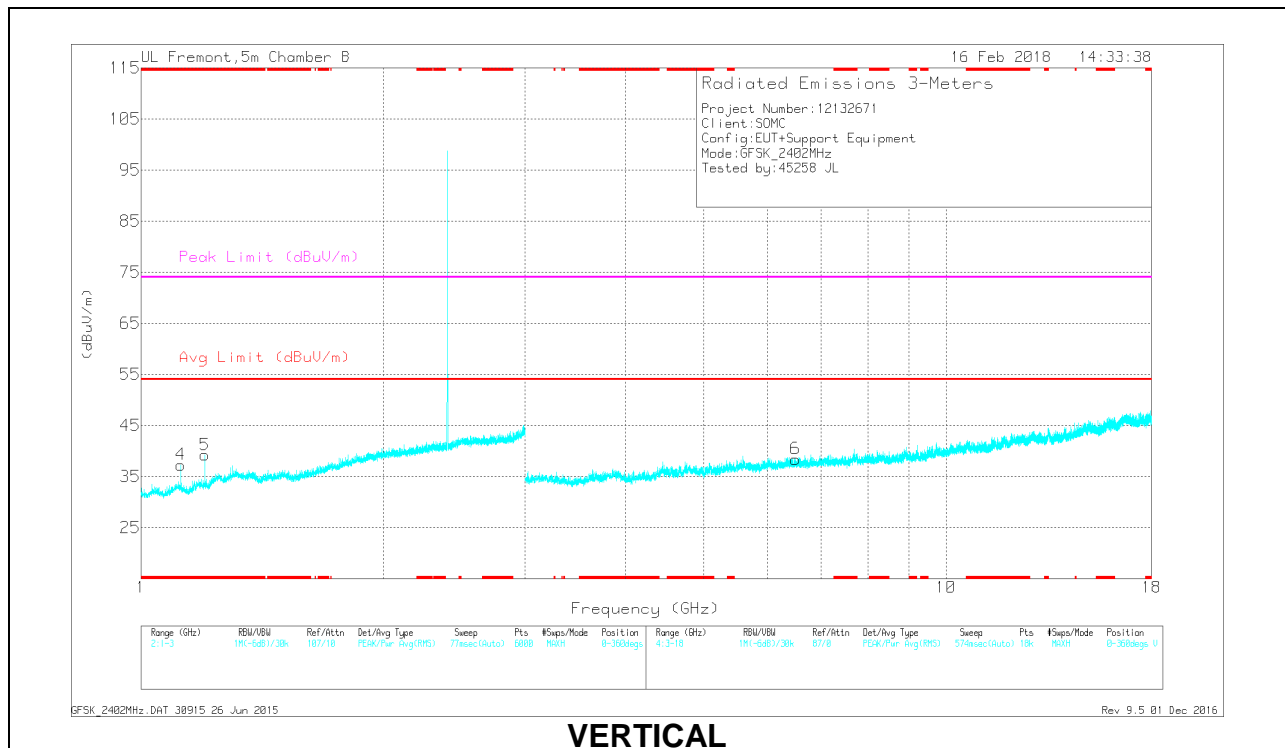

**VERTICAL**



**RADIATED EMISSIONS**

Markers	Frequency (GHz)	Meter Reading (dBuV)	Det	AF T863 (dB/m)	Amp/Cbl/Fitr/P ad (dB)	Corrected Reading (dBuV/m)	Avg Limit (dBuV/m)	Margin (dB)	Peak Limit (dBuV/m)	PK Margin (dB)	Azimuth (Degs)	Height (cm)	Polarity
1	* 1.082	32.65	PKFH	27.4	-23.2	36.85	-	-	74	-37.15	48	164	H
1	* 1.082	21.9	VA1T	27.4	-23.2	26.1	54	-27.9	-	-	48	164	H
4	* 1.121	33.72	PKFH	27.6	-22.9	38.42	-	-	74	-35.58	215	220	V
4	* 1.121	22.39	VA1T	27.6	-22.9	27.09	54	-26.91	-	-	215	220	V
5	* 1.202	33.07	PKFH	28	-22.5	38.57	-	-	74	-35.43	202	242	V
5	* 1.199	21.76	VA1T	28	-22.6	27.16	54	-26.84	-	-	202	242	V
3	* 3.518	38.17	PKFH	32.9	-31.6	39.47	-	-	74	-34.53	136	174	H
3	* 3.52	27.54	VA1T	32.9	-31.5	28.94	54	-25.06	-	-	136	174	H
2	2.103	33.47	PKFH	31.4	-21.2	43.67	-	-	-	-	136	174	H
2	2.104	22.96	VA1T	31.4	-21.2	33.16	-	-	-	-	136	174	H
6	6.5	35.84	PKFH	35.7	-29	42.54	-	-	-	-	136	174	V
6	6.5	25.41	VA1T	35.7	-29	32.11	-	-	-	-	136	174	V

\* - indicates frequency in CFR47 Pt 15 - Restricted Band

PKFH - FHSS: RB=100k/1MHz VB=3 x RB, Peak

VA1T - FHSS: Linear Voltage Average VB=1/Ton where: Ton is transmit duration

### MID CHANNEL RESULTS

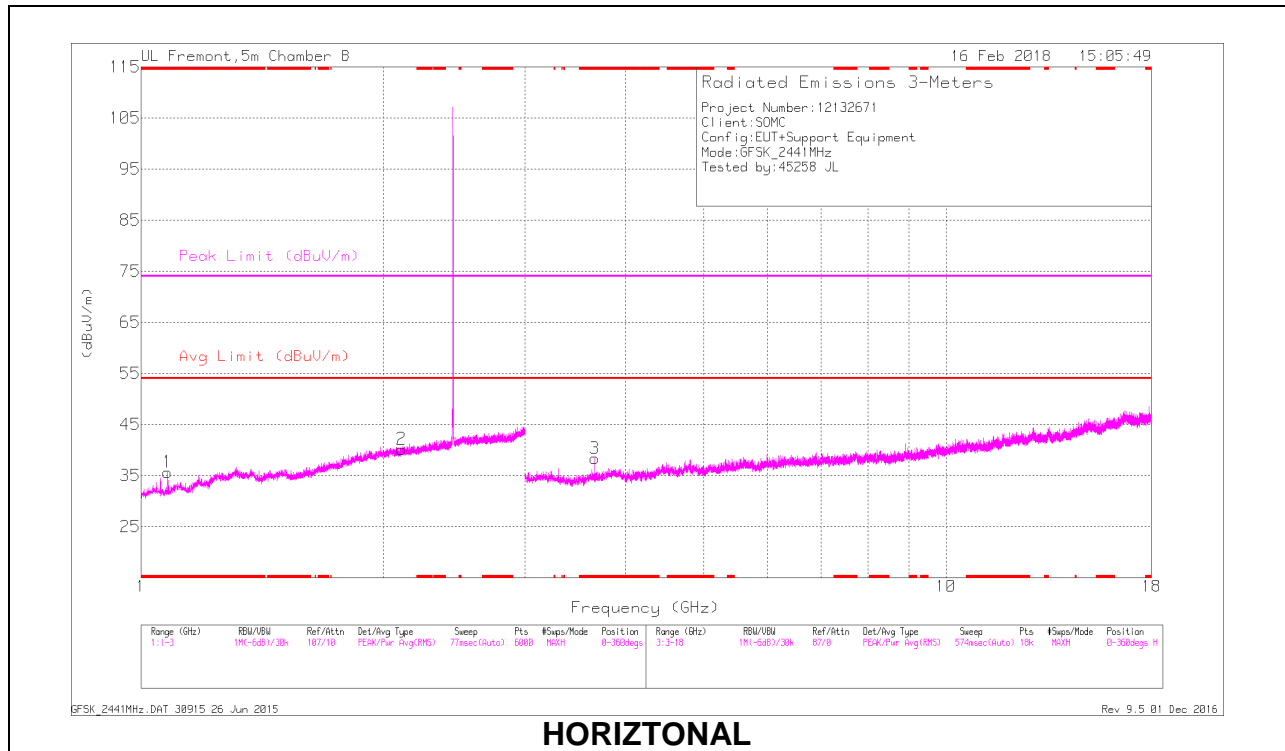

**HORIZONTAL**

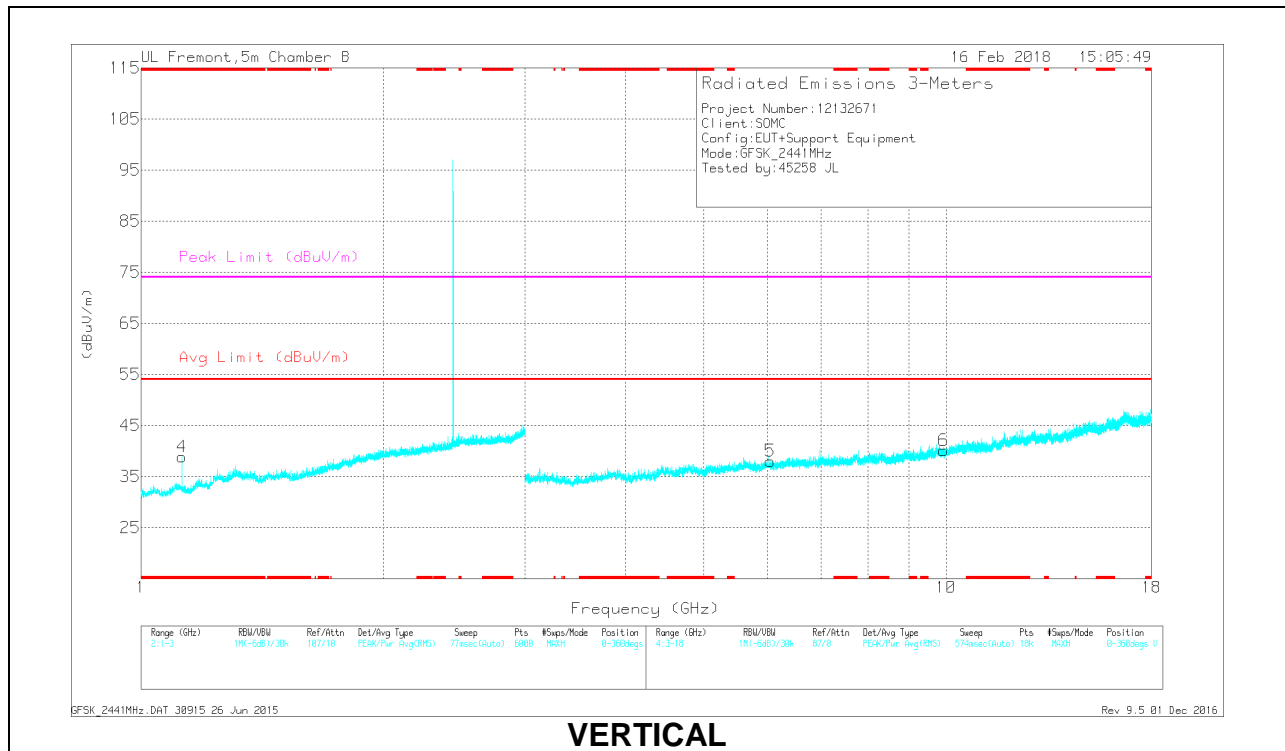

**VERTICAL**

**RADIATED EMISSIONS**

Markers	Frequency (GHz)	Meter Reading (dBuV)	Det	AF T863 (dB/m)	Amp/Cbl/Fitr/P ad (dB)	Corrected Reading (dBuV/m)	Avg Limit (dBuV/m)	Margin (dB)	Peak Limit (dBuV/m)	PK Margin (dB)	Azimuth (Degs)	Height (cm)	Polarity
1	* 1.08	32.56	PKFH	27.4	-23.1	36.86	-	-	74	-37.14	77	156	H
1	* 1.08	21.89	VA1T	27.4	-23	26.29	54	-27.71	-	-	77	156	H
4	* 1.125	33.55	PKFH	27.6	-22.8	38.35	-	-	74	-35.65	107	187	V
4	* 1.123	22.24	VA1T	27.6	-23	26.84	54	-27.16	-	-	107	187	V
3	* 3.664	38.27	PKFH	33.2	-31.2	40.27	-	-	74	-33.73	180	232	H
3	* 3.664	27.51	VA1T	33.2	-31.2	29.51	54	-24.49	-	-	180	232	H
2	2.107	34.27	PKFH	31.4	-21.2	44.47	-	-	-	-	180	232	H
2	2.108	22.84	VA1T	31.4	-21.2	33.04	-	-	-	-	180	232	H
5	6.05	26.56	VA1T	35.4	-30.2	31.76	-	-	-	-	180	232	V
5	6.051	37.06	PKFH	35.4	-30.3	42.16	-	-	-	-	180	232	V
6	9.928	22.7	VA1T	37	-25.5	34.2	-	-	-	-	180	232	V
6	9.931	33.08	PKFH	37	-25.5	44.58	-	-	-	-	180	232	V

\* - indicates frequency in CFR47 Pt 15 - Restricted Band

PKFH - FHSS: RB=100k/1MHz VB=3 x RB, Peak

VA1T - FHSS: Linear Voltage Average VB=1/Ton where: Ton is transmit duration

### HIGH CHANNEL RESULTS

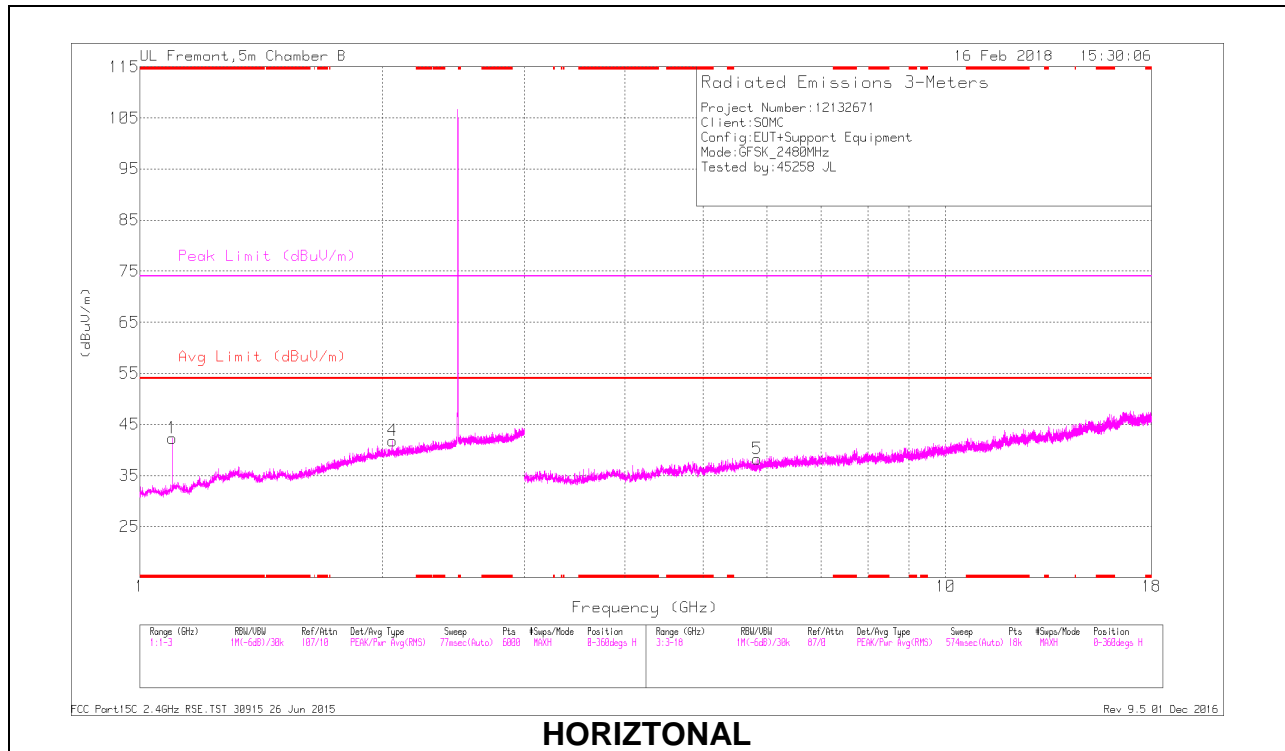

**HORIZONTAL**

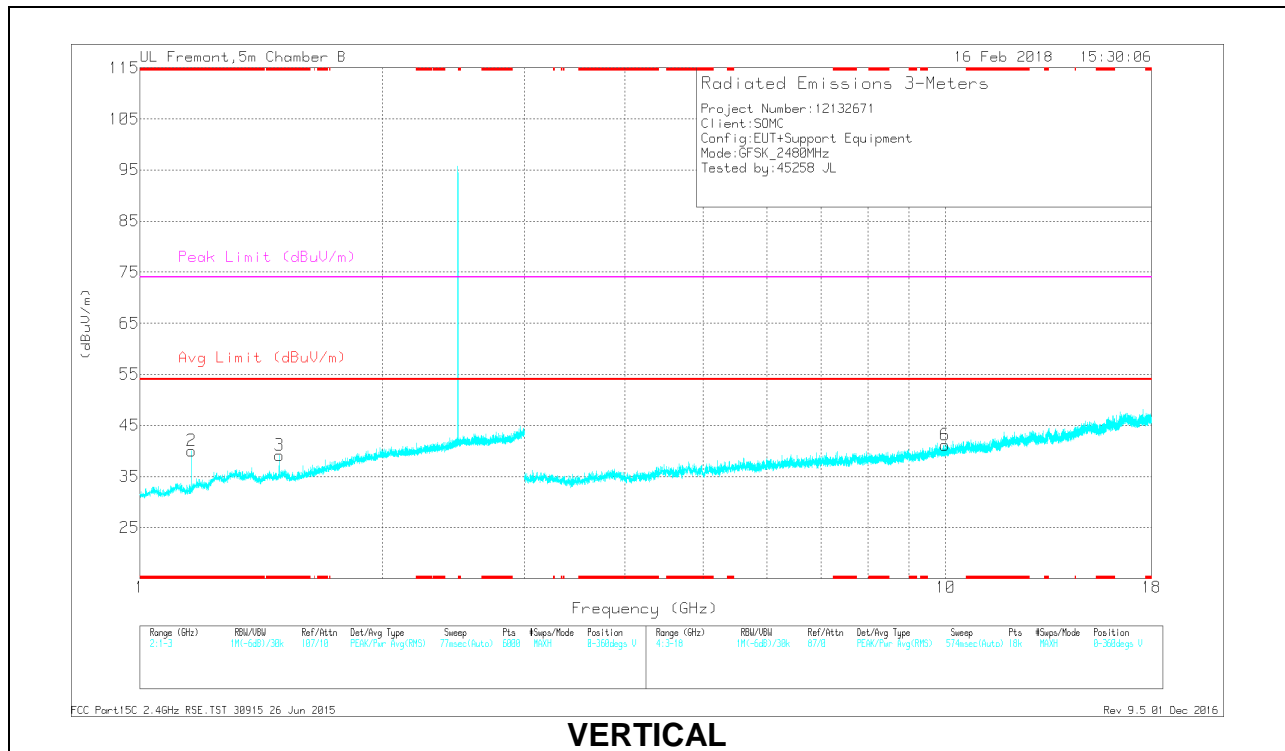

**VERTICAL**

**RADIATED EMISSIONS**

Markers	Frequency (GHz)	Meter Reading (dBuV)	Det	AF T863 (dB/m)	Amp/Cbl/Fitr/P ad (dB)	Corrected Reading (dBuV/m)	Avg Limit (dBuV/m)	Margin (dB)	Peak Limit (dBuV/m)	PK Margin (dB)	Azimuth (Degs)	Height (cm)	Polarity
1	* 1.098	33	PKFH	27.6	-23	37.6	-	-	74	-36.4	37	166	H
1	* 1.098	22.22	VA1T	27.6	-23	26.82	54	-27.18	-	-	37	166	H
2	* 1.159	33.41	PKFH	27.6	-22.7	38.31	-	-	74	-35.69	97	213	V
2	* 1.159	21.7	VA1T	27.6	-22.8	26.5	54	-27.5	-	-	97	213	V
3	* 1.49	34.57	PKFH	28.2	-21.2	41.57	-	-	74	-32.43	250	186	V
3	* 1.49	22.31	VA1T	28.2	-21.2	29.31	54	-24.69	-	-	250	186	V
4	2.058	33.16	PKFH	31.4	-21.2	43.36	-	-	-	-	250	186	H
4	2.059	22.75	VA1T	31.4	-21.2	32.95	-	-	-	-	250	186	H
5	5.833	26.51	VA1T	35.1	-30.3	31.31	-	-	-	-	250	186	H
5	5.835	37.46	PKFH	35.1	-30.2	42.36	-	-	-	-	250	186	H
6	9.977	33.9	PKFH	37.1	-25.5	45.5	-	-	-	-	250	186	V
6	9.979	22.69	VA1T	37.1	-25.5	34.29	-	-	-	-	250	186	V

\* - indicates frequency in CFR47 Pt 15 - Restricted Band

PKFH - FHSS: RB=100k/1MHz VB=3 x RB, Peak

VA1T - FHSS: Linear Voltage Average VB=1/Ton where: Ton is transmit duration

## 9.1.2. BLUETOOTH ENHANCED DATA RATE 8PSK MODULATION

### BANDEDGE (LOW CHANNEL)

### HORIZONTAL RESULT

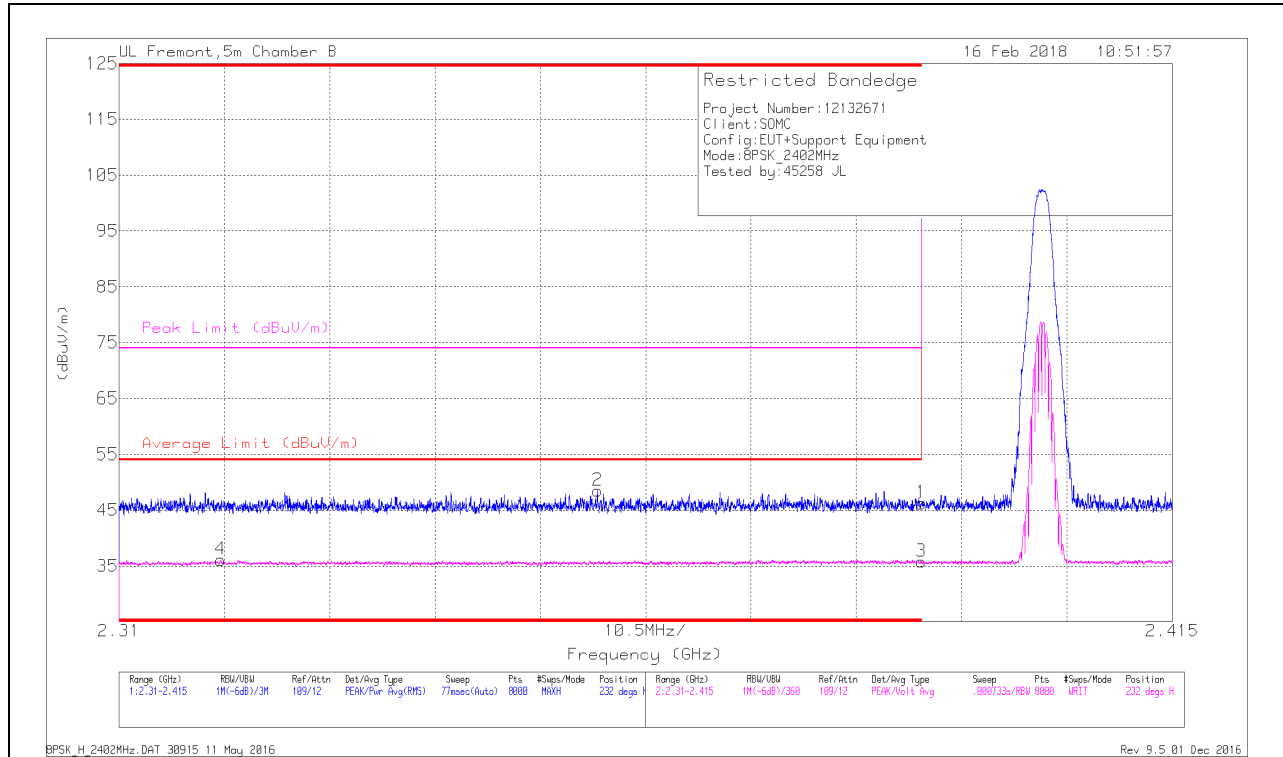

Marker	Frequency (GHz)	Meter Reading (dBuV)	Det	AF T863 (dB/m)	Amp/Cb/Fitr/P ad (dB)	Corrected Reading (dBuV/m)	Average Limit (dBuV/m)	Margin (dB)	Peak Limit (dBuV/m)	PK Margin (dB)	Azimuth (Degs)	Height (cm)	Polarity
1	* 2.39	35.54	Pk	32	-21.3	46.24	-	-	74	-27.76	232	368	H
2	* 2.358	37.88	Pk	31.9	-21.3	48.48	-	-	74	-25.52	232	368	H
3	* 2.39	25.09	VA1T	32	-21.3	35.79	54	-18.21	-	-	232	368	H
4	* 2.32	25.4	VA1T	31.9	-21.2	36.1	54	-17.9	-	-	232	368	H

\* - indicates frequency in CFR47 Pt 15 - Restricted Band

Pk - Peak detector

VA1T - FHSS: Linear Voltage Average  $V_B=1/T_{on}$  where:  $T_{on}$  is transmit duration

### VERTICAL RESULT

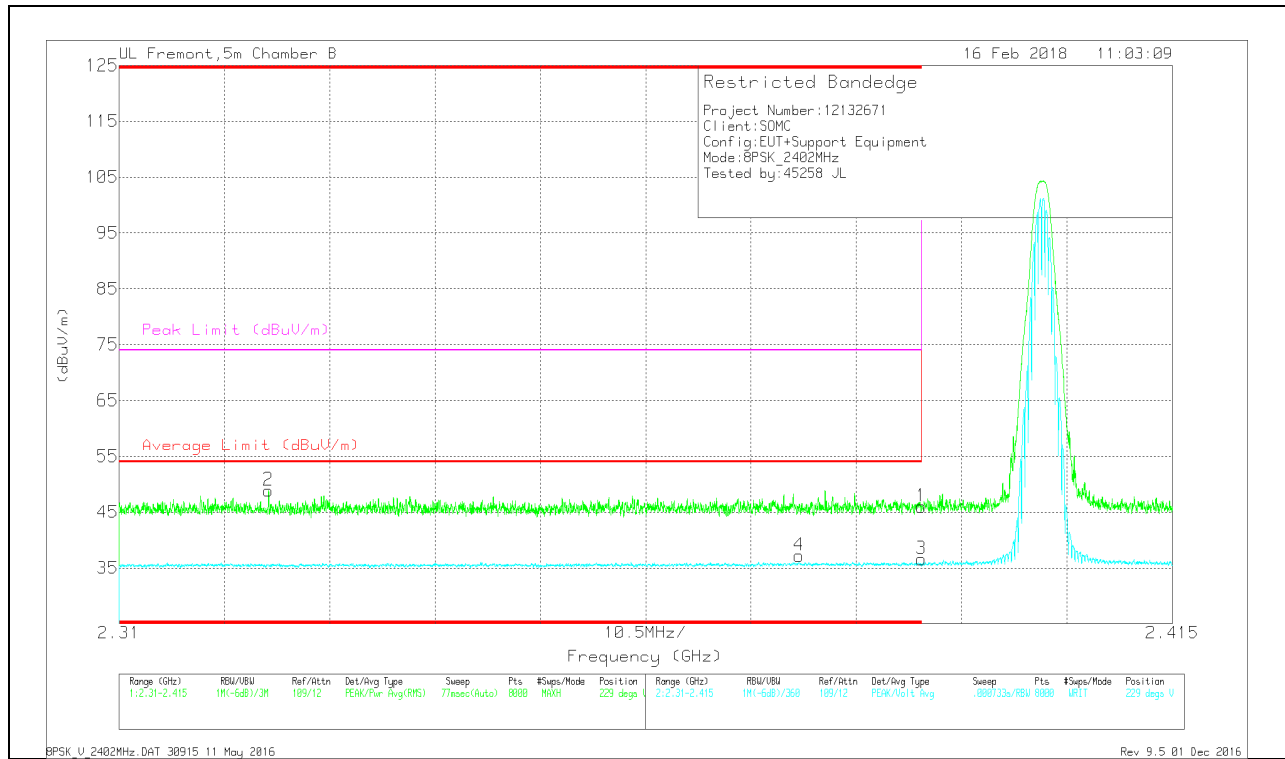

Marker	Frequency (GHz)	Meter Reading (dBuV)	Det	AF T863 (dB/m)	Amp/Cbl/Filtr/P ad (dB)	Corrected Reading (dBuV/m)	Average Limit (dBuV/m)	Margin (dB)	Peak Limit (dBuV/m)	PK Margin (dB)	Azimuth (Degs)	Height (cm)	Polarity
1	* 2.39	35.3	Pk	32	-21.3	46	-	-	74	-28	229	324	V
2	* 2.325	38.28	PK	31.9	-21.3	48.88	-	-	74	-25.12	229	324	V
3	* 2.39	24.77	VA1T	32	-21.3	35.47	54	-18.53	-	-	229	324	V
4	* 2.378	25.48	VA1T	31.9	-21.3	36.08	54	-17.92	-	-	229	324	V

\* - indicates frequency in CFR47 Pt 15 - Restricted Band

Pk - Peak detector

VA1T - FHSS: Linear Voltage Average  $VB=1/Ton$  where: Ton is transmit duration

## BANDEDGE (HIGH CHANNEL)

### HORIZONTAL RESULT

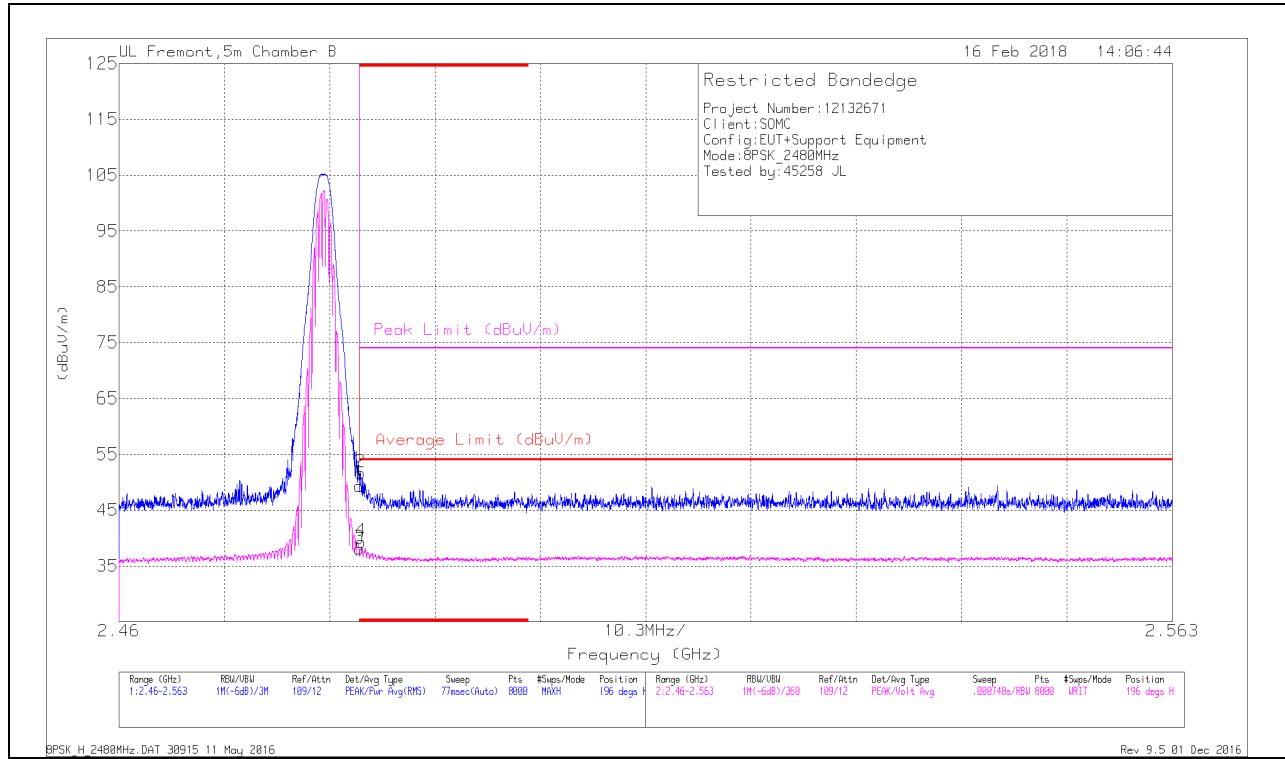

Marker	Frequency (GHz)	Meter Reading (dBuV)	Det	AF T863 (dB/m)	Amp/Cb/Fitr/P ad (dB)	Corrected Reading (dBuV/m)	Average Limit (dBuV/m)	Margin (dB)	Peak Limit (dBuV/m)	PK Margin (dB)	Azimuth (Degs)	Height (cm)	Polarity
1	* 2.484	38.12	Pk	32.5	-21.3	49.32	-	-	74	-24.68	196	296	H
2	* 2.484	40.53	Pk	32.5	-21.3	51.73	-	-	74	-22.27	196	296	H
3	* 2.484	25.81	VA1T	32.5	-21.3	37.01	54	-16.99	-	-	196	296	H
4	* 2.484	27.04	VA1T	32.5	-21.3	38.24	54	-15.76	-	-	196	296	H

\* - indicates frequency in CFR47 Pt 15 / IC RSS-Restricted Band  
 Pk - Peak detector  
 VA1T - FHSS: Linear Voltage Average VB=1/Ton where: Ton is transmit duration



### VERTICAL RESULT

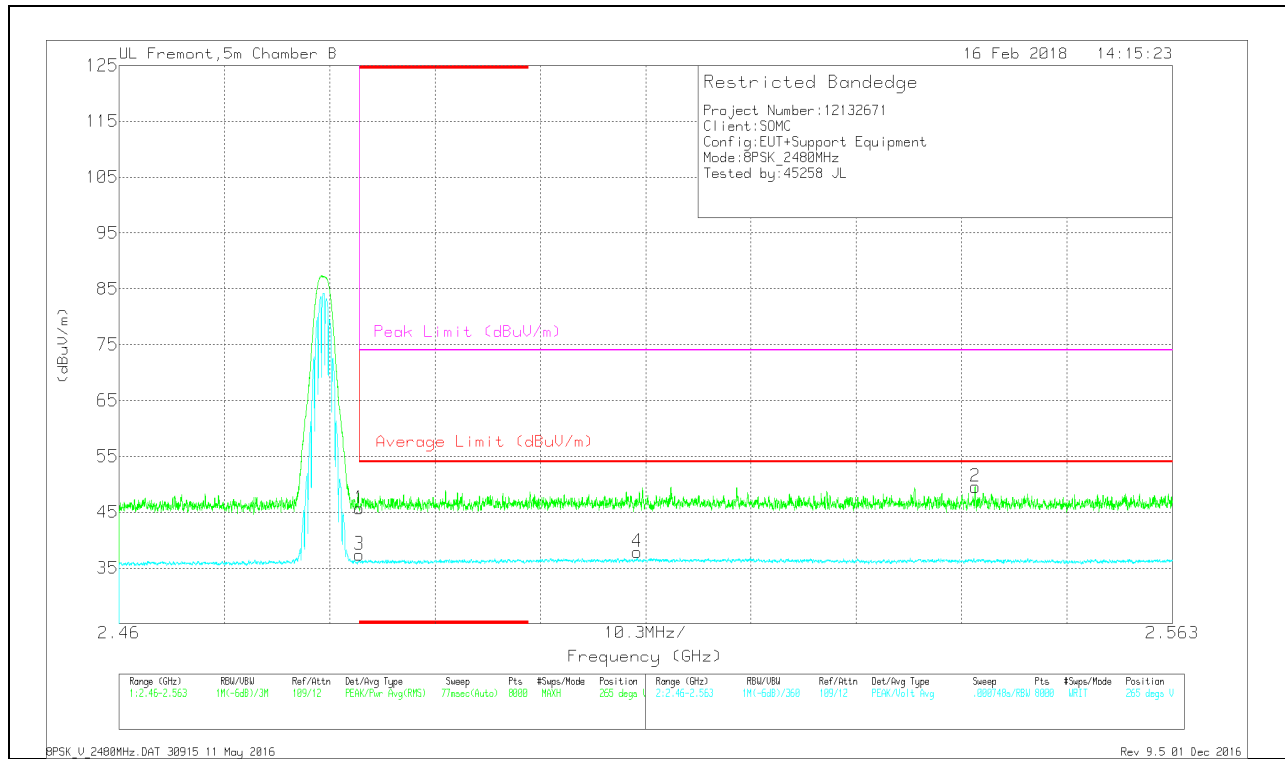

Marker	Frequency (GHz)	Meter Reading (dBuV)	Det	AF T863 (dB/m)	Amp/Cbl/Filtr/P ad (dB)	Corrected Reading (dBuV/m)	Average Limit (dBuV/m)	Margin (dB)	Peak Limit (dBuV/m)	PK Margin (dB)	Azimuth (Degs)	Height (cm)	Polarity
1	* 2.484	34.49	Pk	32.5	-21.3	45.69	-	-	74	-28.31	265	115	V
3	* 2.484	25.07	VA1T	32.5	-21.3	36.27	54	-17.73	-	-	265	115	V
4	2.511	25.15	VA1T	32.6	-21	36.75	54	-17.25	-	-	265	115	V
2	2.544	38.15	Pk	32.5	-21.1	49.55	-	-	74	-24.45	265	115	V

\* - indicates frequency in CFR47 Pt 15 - Restricted Band

Pk - Peak detector

VA1T - FHSS: Linear Voltage Average  $V_B=1/T_{on}$  where:  $T_{on}$  is transmit duration

## HARMONICS AND SPURIOUS EMISSIONS

### LOW CHANNEL RESULTS

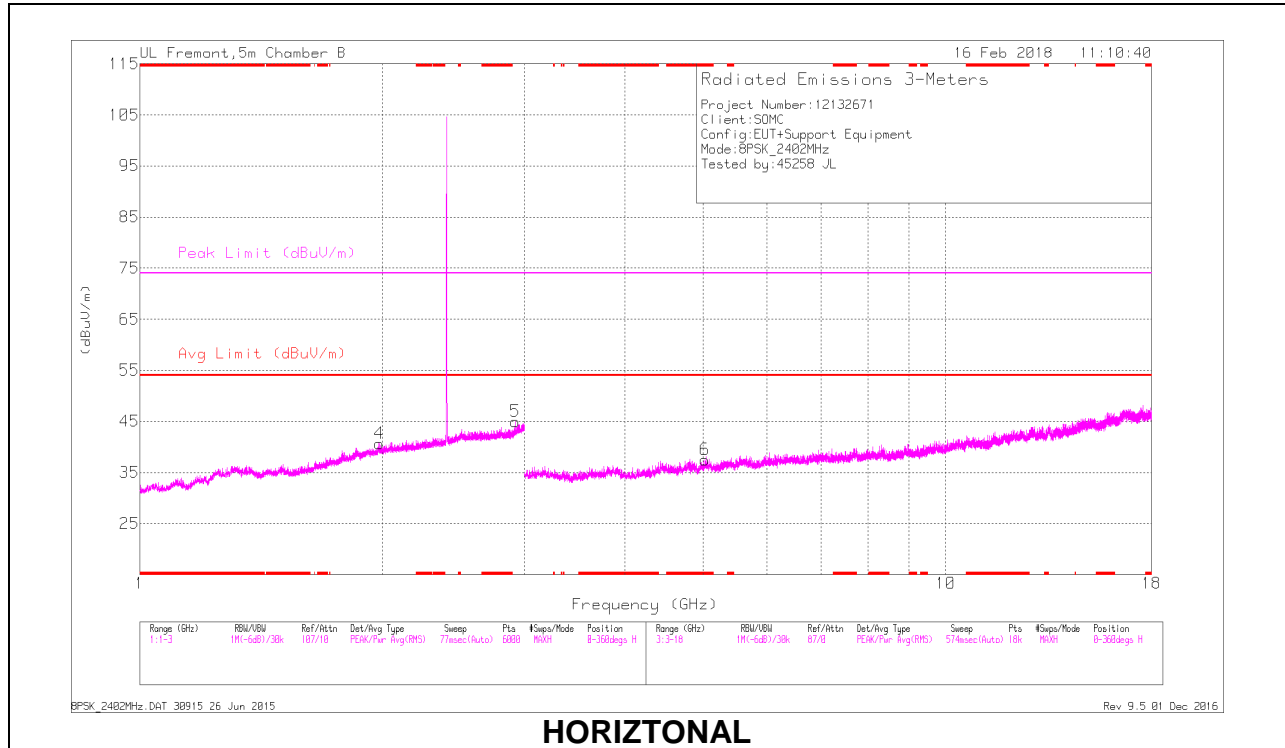

**HORIZONTAL**

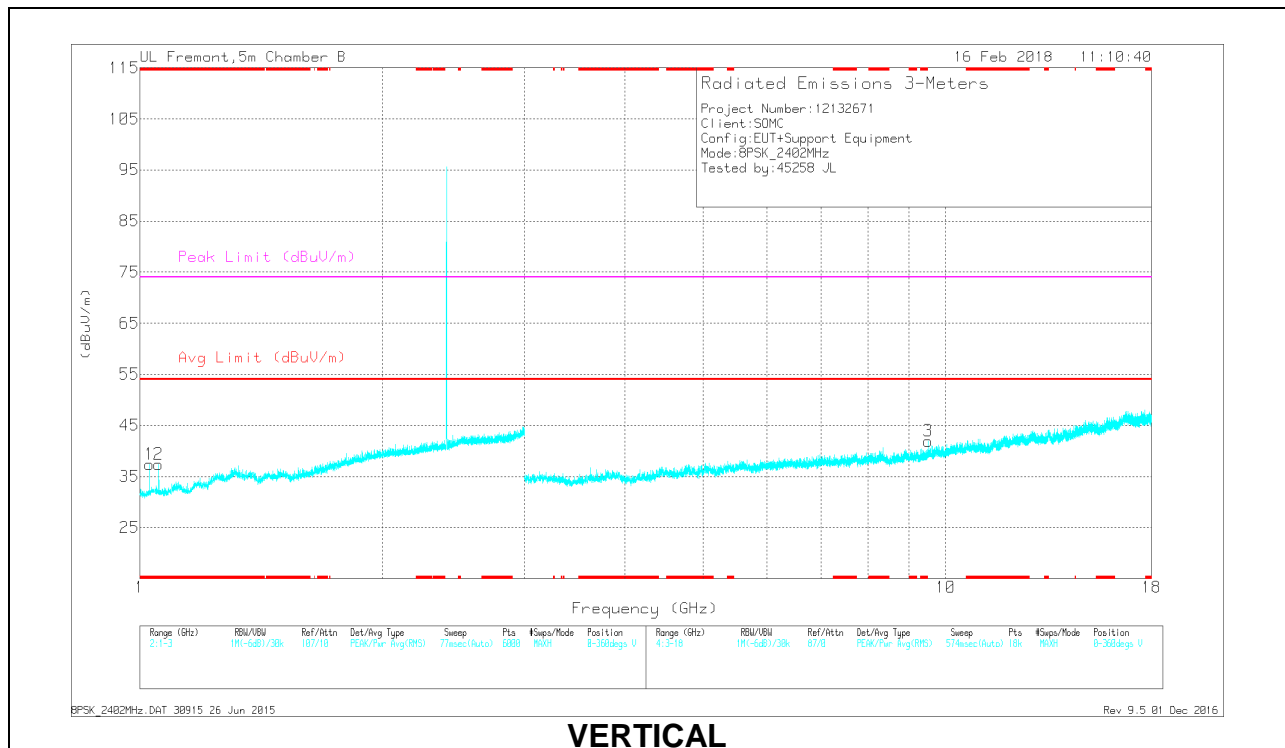

**VERTICAL**

**RADIATED EMISSIONS**

Markers	Frequency (GHz)	Meter Reading (dBuV)	Det	AF T863 (dB/m)	Amp/Cbl/Fitr/P ad (dB)	Corrected Reading (dBuV/m)	Avg Limit (dBuV/m)	Margin (dB)	Peak Limit (dBuV/m)	PK Margin (dB)	Azimuth (Degs)	Height (cm)	Polarity
1	* 1.028	32.9	PKFH	27.2	-23.4	36.7	-	-	74	-37.3	250	173	V
1	* 1.028	22.37	VA1T	27.2	-23.4	26.17	54	-27.83	-	-	250	173	V
2	* 1.026	33.5	PKFH	27.2	-23.4	37.3	-	-	74	-36.7	249	189	V
2	* 1.028	22.34	VA1T	27.2	-23.4	26.14	54	-27.86	-	-	249	189	V
6	* 5.027	36.78	PKFH	34.4	-29.3	41.88	-	-	74	-32.12	175	216	H
6	* 5.028	25.67	VA1T	34.4	-29.3	30.77	54	-23.23	-	-	175	216	H
4	1.981	22.72	VA1T	31.2	-21	32.92	-	-	-	-	308	100	H
4	1.982	33.74	PKFH	31.2	-21.1	43.84	-	-	-	-	308	100	H
5	2.922	35.28	PKFH	32.6	-20	47.88	-	-	-	-	277	148	H
5	2.924	23.66	VA1T	32.6	-20	36.26	-	-	-	-	277	148	H
3	9.505	23.01	VA1T	36.7	-25.6	34.11	-	-	-	-	115	195	V
3	9.507	33.89	PKFH	36.7	-25.6	44.99	-	-	-	-	115	195	V

\* - indicates frequency in CFR47 Pt 15 - Restricted Band

PKFH - FHSS: RB=100k/1MHz VB=3 x RB, Peak

VA1T - FHSS: Linear Voltage Average VB=1/Ton where: Ton is transmit duration

### MID CHANNEL RESULTS

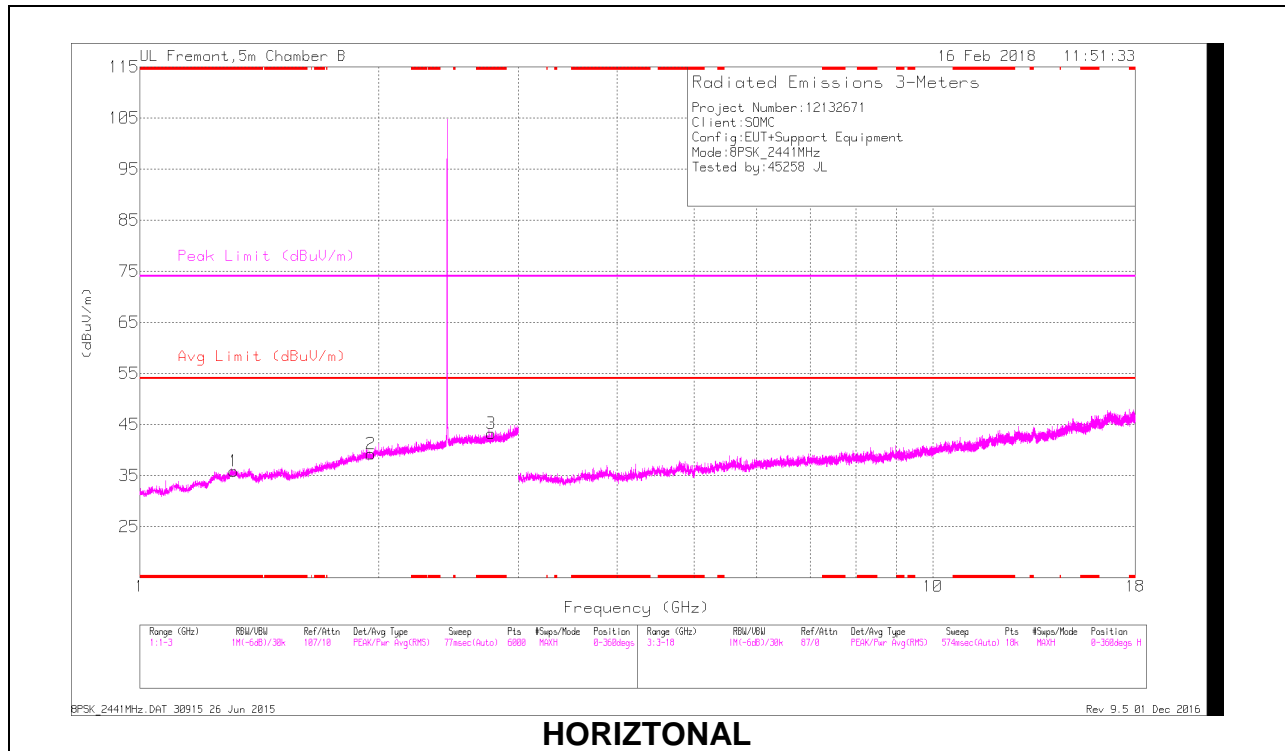

**HORIZONTAL**

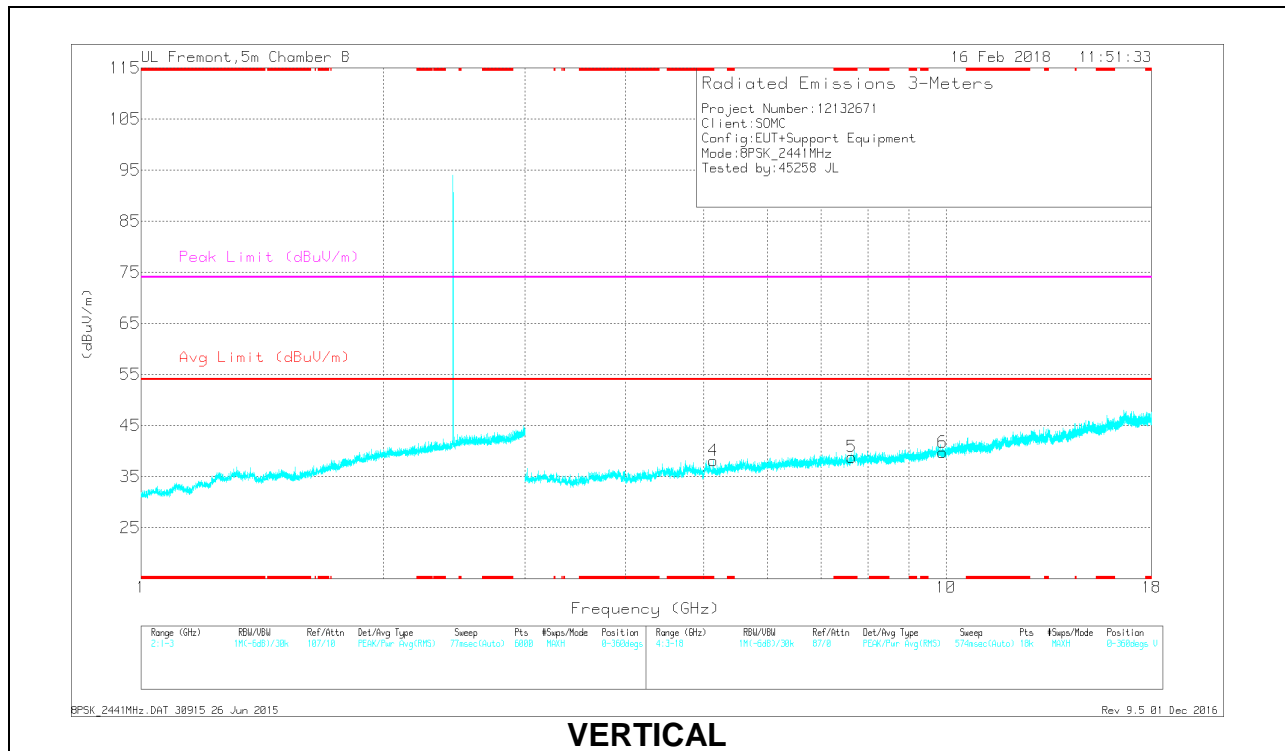

**VERTICAL**

**RADIATED EMISSIONS**

Markers	Frequency (GHz)	Meter Reading (dBuV)	Det	AF T863 (dB/m)	Amp/Cbl/Fitr/P ad (dB)	Corrected Reading (dBuV/m)	Avg Limit (dBuV/m)	Margin (dB)	Peak Limit (dBuV/m)	PK Margin (dB)	Azimuth (Degs)	Height (cm)	Polarity
1	* 1.313	34.71	PKFH	28.9	-21.9	41.71	-	-	74	-32.29	35	145	H
1	* 1.312	22.5	VA1T	28.9	-21.9	29.5	54	-24.5	-	-	35	145	H
3	* 2.774	34.72	PKFH	32.3	-20.6	46.42	-	-	74	-27.58	86	191	H
3	* 2.776	23.63	VA1T	32.3	-20.7	35.23	54	-18.77	-	-	86	191	H
4	* 5.141	37.92	PKFH	34.4	-30.6	41.72	-	-	74	-32.28	130	217	V
4	* 5.14	27.05	VA1T	34.4	-30.6	30.85	54	-23.15	-	-	130	217	V
5	* 7.642	36.29	PKFH	36	-28.2	44.09	-	-	74	-29.91	221	179	V
5	* 7.641	24.95	VA1T	36	-28.2	32.75	54	-21.25	-	-	221	179	V
2	1.954	32.87	PKFH	31.1	-21.1	42.87	-	-	-	-	221	179	H
2	1.955	22.5	VA1T	31.1	-21.1	32.5	-	-	-	-	221	179	H
6	9.901	34.26	PKFH	37	-25.6	45.66	-	-	-	-	221	179	V
6	9.901	22.7	VA1T	37	-25.6	34.1	-	-	-	-	221	179	V

\* - indicates frequency in CFR47 Pt 15 - Restricted Band

PKFH - FHSS: RB=100k/1MHz VB=3 x RB, Peak

VA1T - FHSS: Linear Voltage Average VB=1/Ton where: Ton is transmit duration

### HIGH CHANNEL RESULTS

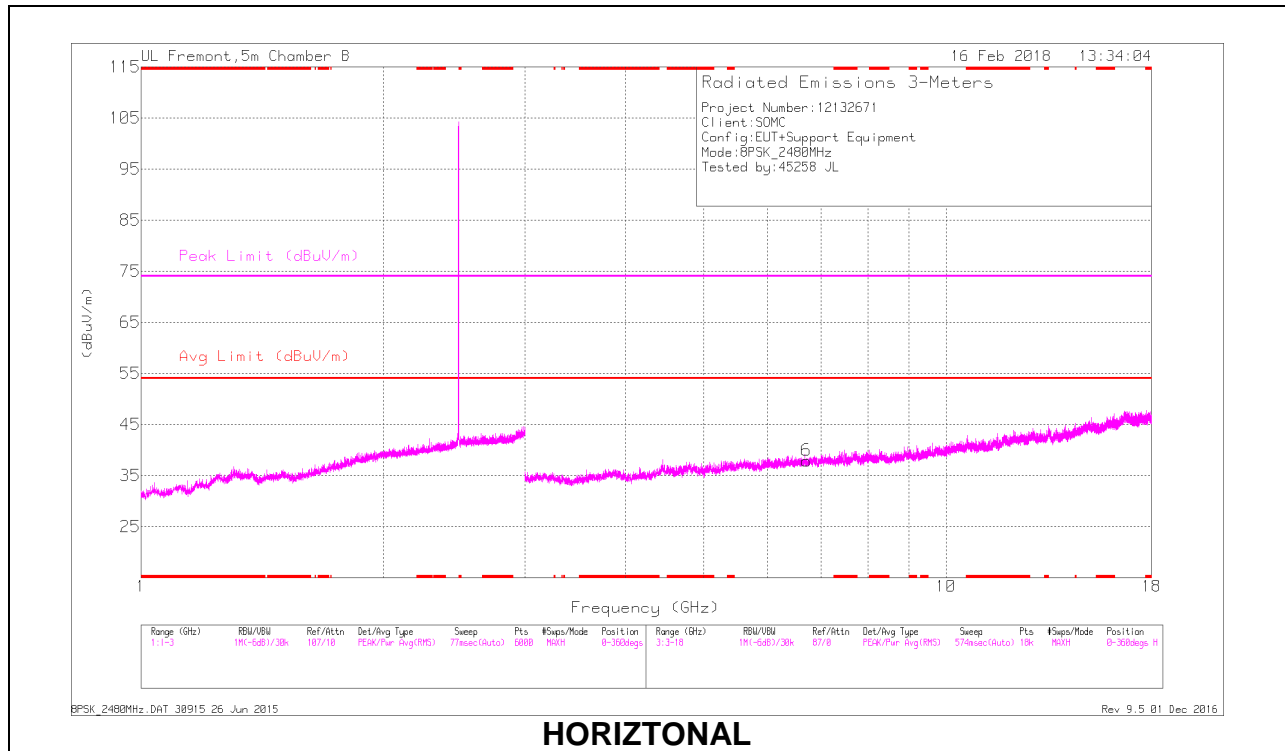

**HORIZONTAL**

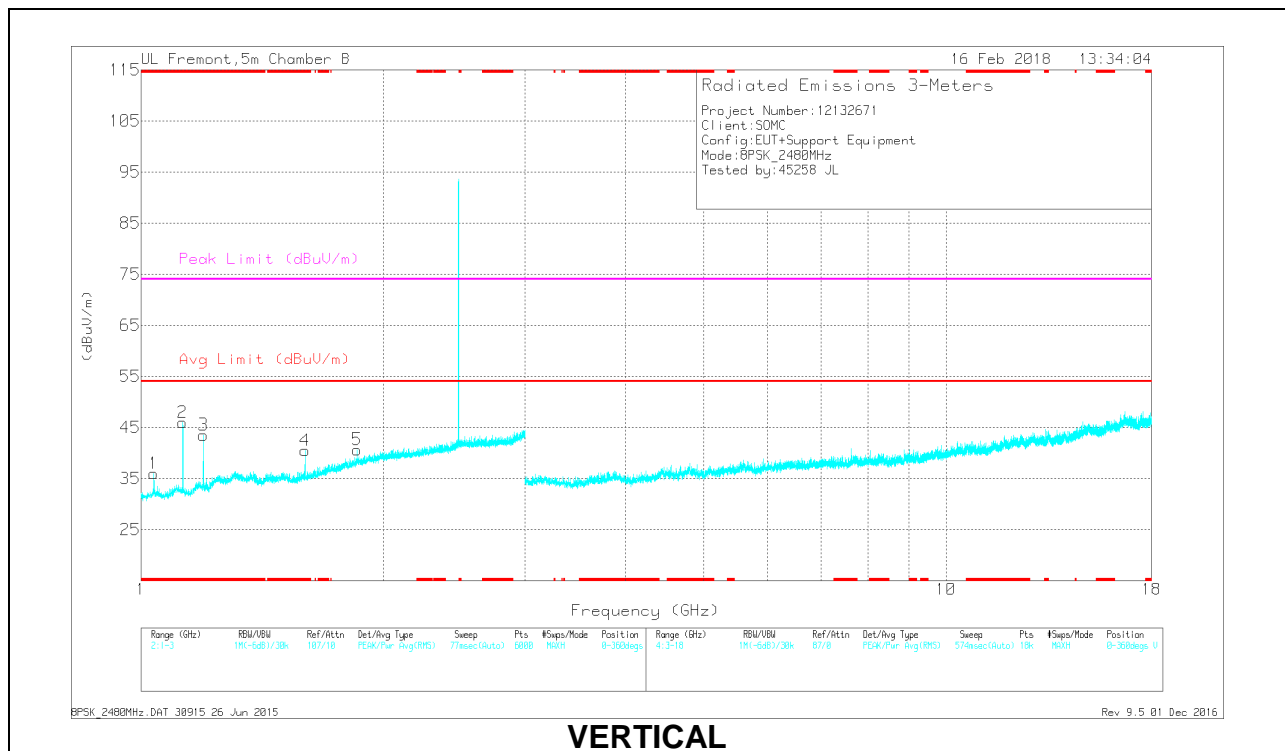

**VERTICAL**

**RADIATED EMISSIONS**

Markers	Frequency (GHz)	Meter Reading (dBuV)	Det	AF T863 (dB/m)	Amp/Cbl/Fitr/P ad (dB)	Corrected Reading (dBuV/m)	Avg Limit (dBuV/m)	Margin (dB)	Peak Limit (dBuV/m)	PK Margin (dB)	Azimuth (Degs)	Height (cm)	Polarity
1	* 1.036	34.18	PKFH	27.1	-23.4	37.88	-	-	74	-36.12	288	180	V
1	* 1.036	22.65	VA1T	27.1	-23.3	26.45	54	-27.55	-	-	288	180	V
2	* 1.126	33.89	PKFH	27.6	-22.8	38.69	-	-	74	-35.31	229	389	V
2	* 1.125	22.2	VA1T	27.6	-22.8	27	54	-27	-	-	229	389	V
3	* 1.196	32.85	PKFH	27.9	-22.6	38.15	-	-	74	-35.85	186	255	V
3	* 1.194	21.95	VA1T	27.9	-22.5	27.35	54	-26.65	-	-	186	255	V
4	* 1.598	33.05	PKFH	28.3	-21.5	39.85	-	-	74	-34.15	255	206	V
4	* 1.6	22.45	VA1T	28.3	-21.5	29.25	54	-24.75	-	-	255	206	V
5	1.855	22.39	VA1T	30.8	-21.1	32.09	-	-	-	-	255	206	V
5	1.856	33.98	PKFH	30.8	-21.1	43.68	-	-	-	-	255	206	V
6	6.709	26.15	VA1T	35.7	-29.8	32.05	-	-	-	-	255	206	H
6	6.71	37.34	PKFH	35.7	-29.8	43.24	-	-	-	-	255	206	H

\* - indicates frequency in CFR47 Pt 15 - Restricted Band

PKFH - FHSS: RB=100k/1MHz VB=3 x RB, Peak

VA1T - FHSS: Linear Voltage Average VB=1/Ton where: Ton is transmit duration

## 9.2. WORST-CASE BELOW 30 MHz

### SPURIOUS EMISSIONS BELOW 30 MHz (WORST-CASE CONFIGURATION)

#### FACE ON AND FACE OFF PLOTS

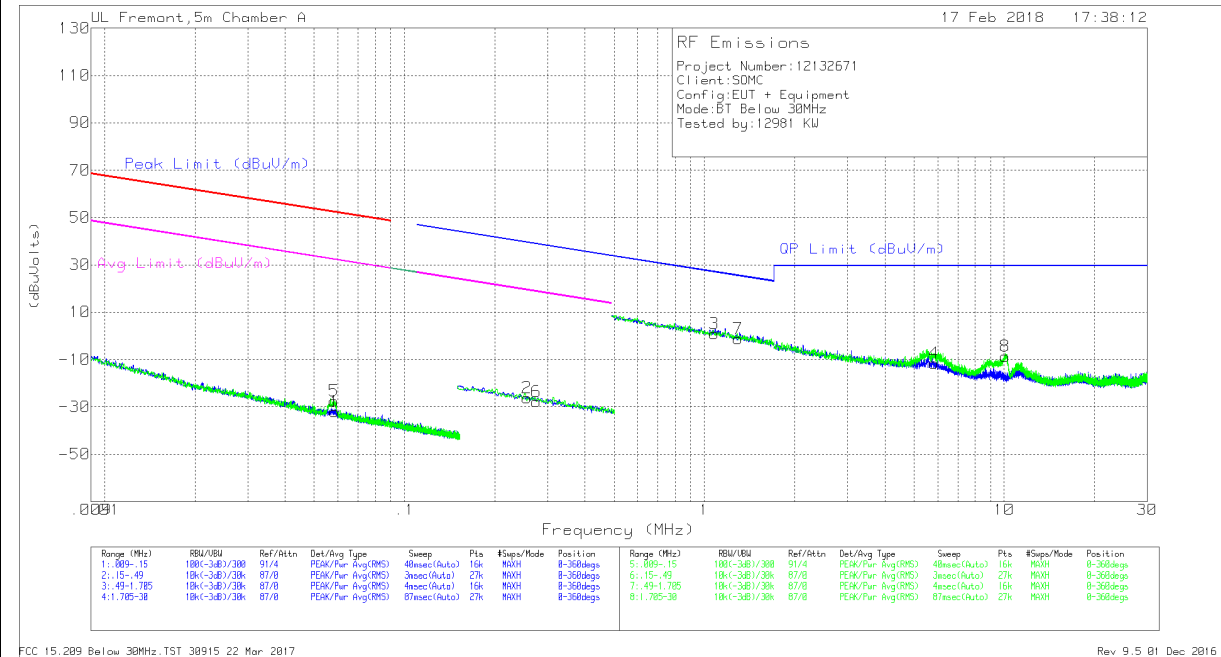

NOTE: KDB 414788 OATS and Chamber Correlation Justification

- Based on FCC 15.31 (f) (2): measurements may be performed at a distance closer than that specified in the regulations; however, an attempt should be made to avoid making measurements in the near field.
- OATs and chamber correlation testing had been performed and chamber measured test result is the worst case test result.

#### Trace Markers

Marker	Frequency (MHz)	Meter Reading (dBuV)	Det	Loop Antenna (dB/m)	Cbl (dB)	Dist Corr 300m	Corrected Reading (dBuVolts)	Peak Limit (dBuV/m)	Margin (dB)	Avg Limit (dBuV/m)	Margin (dB)	Azimuth (Degs)
5	05825	40.63	Pk	11.8	.1	-80	-27.47	52.28	-79.75	32.28	-59.75	0-360
1	05848	36.08	Pk	11.8	.1	-80	-32.02	52.24	-84.26	32.24	-64.26	0-360
2	25603	42.9	Pk	10.9	.1	-80	-26.1	39.45	-65.55	19.45	-45.55	0-360
6	27539	41.17	Pk	10.9	.1	-80	-27.83	38.81	-66.64	18.81	-46.64	0-360

#### Pk - Peak detector

Marker	Frequency (MHz)	Meter Reading (dBuV)	Det	Loop Antenna (dB/m)	Cbl (dB)	Dist Corr 30m	Corrected Reading (dBuVolts)	QP Limit (dBuV/m)	Margin (dB)	Azimuth (Degs)
3	1.07908	29.33	Pk	11.3	.2	-40	83	26.96	-26.13	0-360
7	1.29621	27.22	Pk	11.3	.2	-40	-1.28	25.37	-26.65	0-360
4	5.84355	17.02	Pk	11.1	.4	-40	-11.48	29.5	-40.98	0-360
8	10.07852	19.83	Pk	11.1	.4	-40	-8.67	29.5	-38.17	0-360

#### Pk - Peak detector



### 9.3. Worst Case Below 1 GHz

#### SPURIOUS EMISSIONS 30 TO 1000 MHz (WORST-CASE CONFIGURATION)

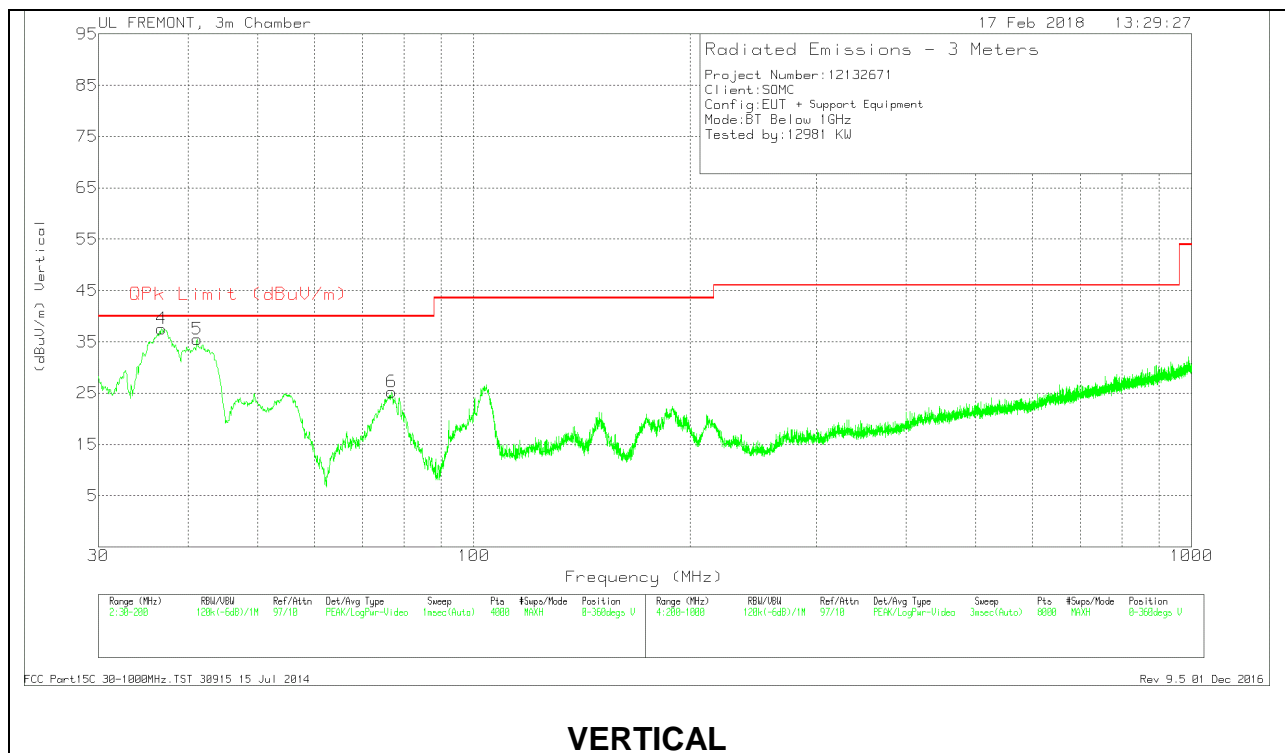
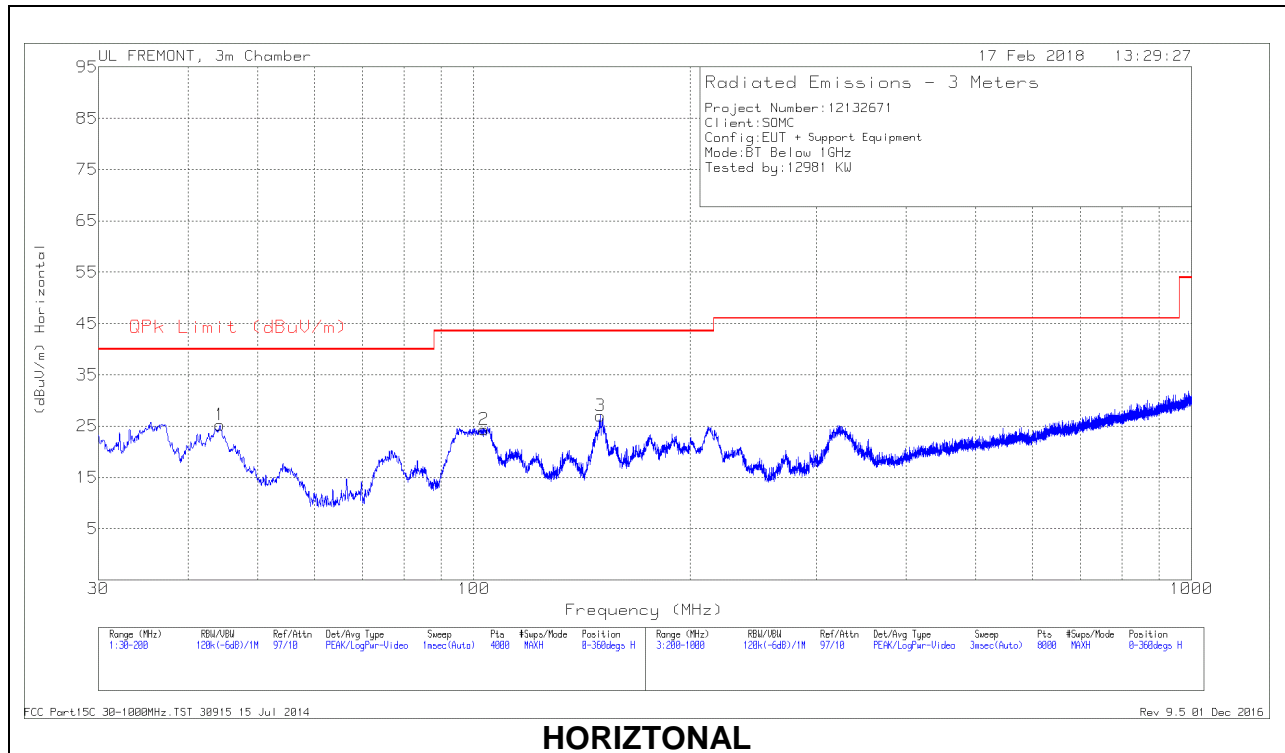

**Below 1GHz Data**

Marker	Frequency (MHz)	Meter Reading (dBuV)	Det	AF T243 (dB/m)	Amp/Cbl (dB/m)	Corrected Reading (dBuV/m)	QPk Limit (dBuV/m)	Margin (dB)	Azimuth (Degs)	Height (cm)	Polarity
4	36.7167	48.19	Pk	20.3	-31	37.49	40	-2.51	0-360	100	V
	36.9351	46.1	Qp	20.1	-31	35.2	40	-4.8	333	100	V
5	41.1804	49.29	Pk	17.1	-30.9	35.49	40	-4.51	0-360	100	V
	41.322	45.53	Qp	17	-30.9	31.63	40	-8.37	311	105	V
1	44.2837	41.2	Pk	14.9	-30.9	25.2	40	-14.8	0-360	400	H
6	76.8046	43.94	Pk	11.8	-30.5	25.24	40	-14.76	0-360	100	V
2	103.3527	39.38	Pk	15.3	-30.3	24.38	43.52	-19.14	0-360	300	H
3	150.0086	40.3	Pk	16.5	-29.8	27	43.52	-16.52	0-360	200	H

Pk - Peak detector

Qp - Quasi-Peak detector

### 9.4. Worst Case 18-26 GHz

#### SPURIOUS EMISSIONS 18-26 GHz (WORST-CASE CONFIGURATION)

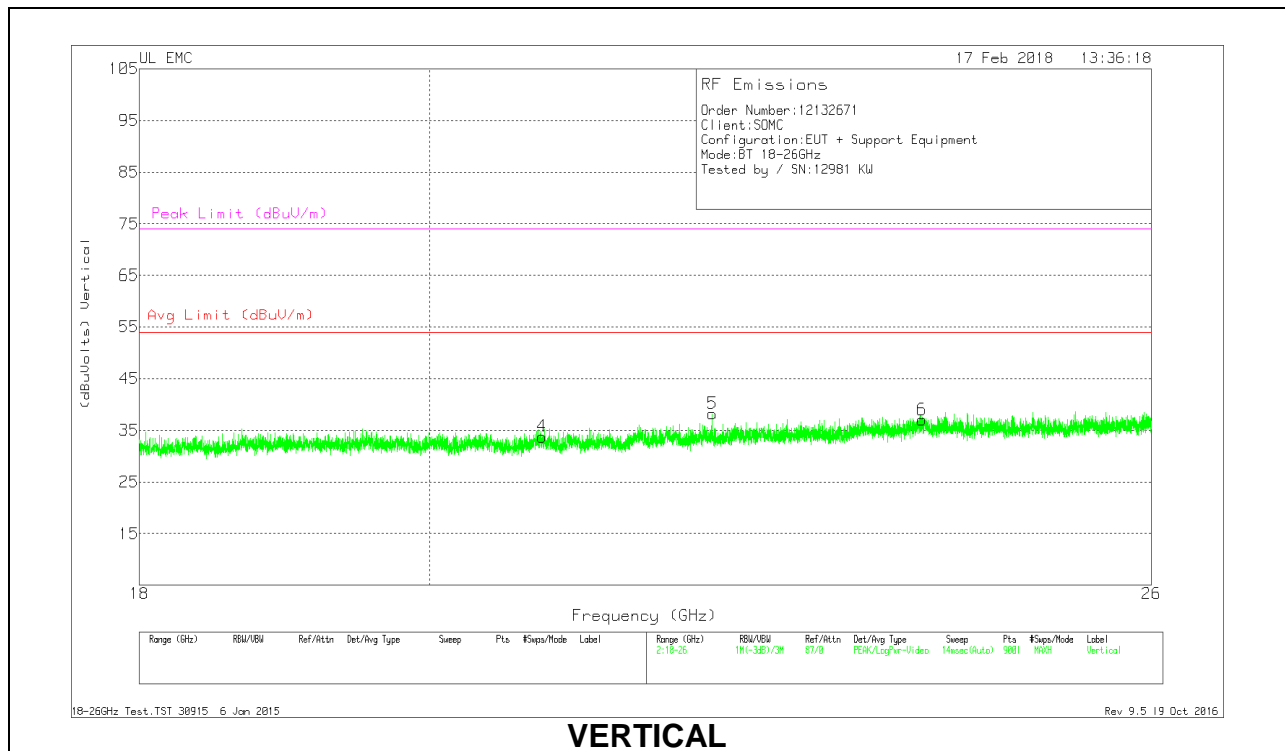
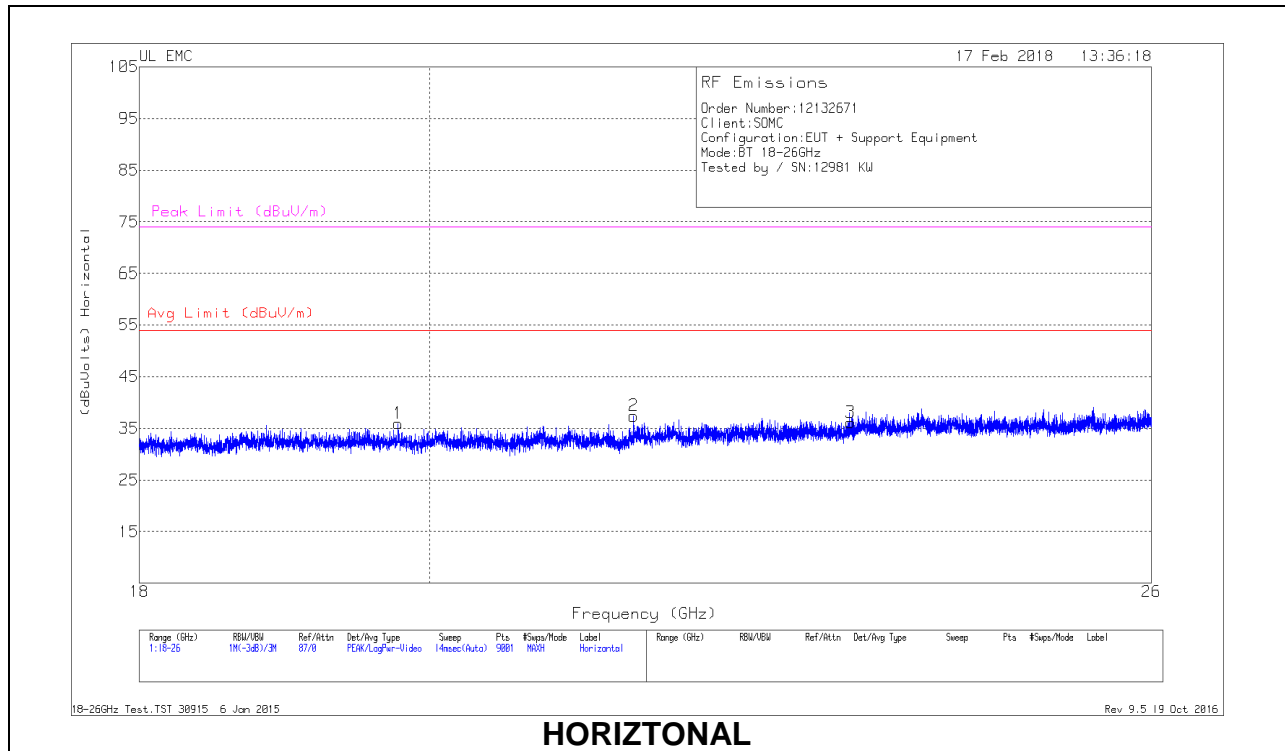

**18 – 26GHz DATA**

Marker	Frequency (GHz)	Meter Reading (dBuV)	Det	T449 AF (dB/m)	Amp/Cbl (dB)	Dist Corr (dB)	Corrected Reading (dBuVolts)	Avg Limit (dBuV/m)	Margin (dB)	Peak Limit (dBuV/m)	PK Margin (dB)
1	19.773	37.4	Pk	32.7	-24.7	-9.5	35.9	54	-18.1	74	-38.1
2	21.54	38.89	Pk	33.2	-25.2	-9.5	37.39	54	-16.61	74	-36.61
3	23.304	36.54	Pk	33.7	-24.6	-9.5	36.14	54	-17.86	74	-37.86
4	20.836	35.44	Pk	33.1	-25.3	-9.5	33.74	54	-20.26	74	-40.26
5	22.164	38.99	Pk	33.4	-24.7	-9.5	38.19	54	-15.81	74	-35.81
6	23.917	36.53	Pk	33.9	-23.9	-9.5	37.03	54	-16.97	74	-36.97

Pk - Peak detector

## 10. AC POWER LINE CONDUCTED EMISSIONS

### LIMITS

FCC §15.207 (a)

Frequency of Emission (MHz)	Conducted Limit (dBuV)	
	Quasi-peak	Average
0.15-0.5	66 to 56*	56 to 46*
0.5-5	56	46
5-30	60	50

\*Decreases with the logarithm of the frequency.

### TEST PROCEDURE

The EUT is placed on a non-conducting table 40 cm from the vertical ground plane and 80 cm above the horizontal ground plane. The EUT is configured in accordance with ANSI C63.4.

The receiver is set to a resolution bandwidth of 9 kHz. Peak detection is used unless otherwise noted as quasi-peak or average.

Line conducted data is recorded for both NEUTRAL and HOT lines.

### RESULTS

### 10.1.1. AC Power Line Norm

### LINE 1 RESULTS

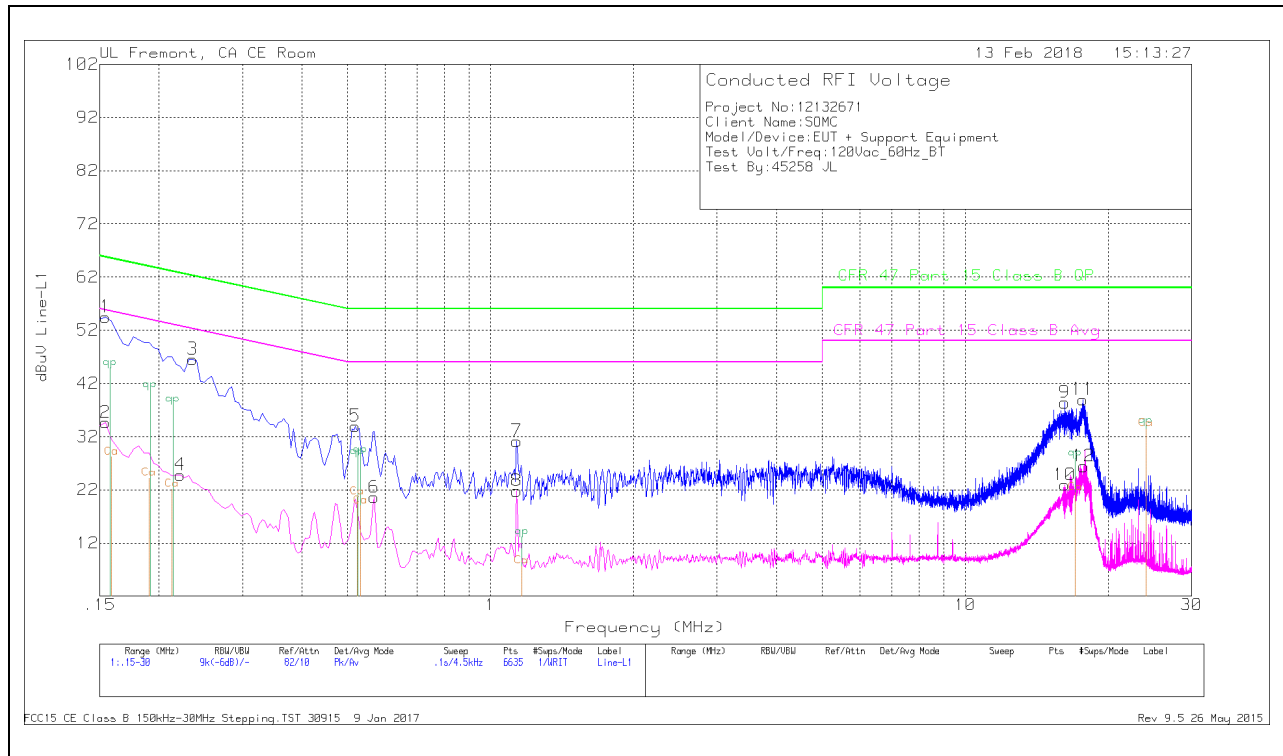

#### Trace Markers

Range 1: Line-L1 .15 - 30MHz											
Marker	Frequency (MHz)	Meter Reading (dBuV)	Det	LISN L1	LC Cables C1&C3	Limiter (dB)	Corrected Reading dBuV	CFR 47 Part 15 Class B QP	Margin (dB)	CFR 47 Part 15 Class B Avg	Margin (dB)
1	.1545	44.28	Pk	.1	0	10.1	54.48	65.75	-11.27	-	-
2	.1545	24.43	Av	.1	0	10.1	34.63	-	-	55.75	-21.12
3	.2355	36.43	Pk	0	0	10.1	46.53	62.25	-15.72	-	-
4	.222	14.71	Av	0	0	10.1	24.81	-	-	52.74	-27.93
5	.519	23.85	Pk	0	0	10.1	33.95	56	-22.05	-	-
6	.5685	10.5	Av	0	0	10.1	20.6	-	-	46	-25.4
7	1.1355	20.93	Pk	0	.1	10.1	31.13	56	-24.87	-	-
8	1.1355	11.59	Av	0	.1	10.1	21.79	-	-	46	-24.21
9	16.2285	27.8	Pk	0	.3	10.3	38.4	60	-21.6	-	-
10	16.2195	12.33	Av	0	.3	10.3	22.93	-	-	50	-27.07
11	17.6955	28.36	Pk	0	.3	10.3	38.96	60	-21.04	-	-
12	17.754	15.82	Av	0	.3	10.3	26.42	-	-	50	-23.58

Pk - Peak detector  
 Av - Average detection

### LINE 2 RESULTS

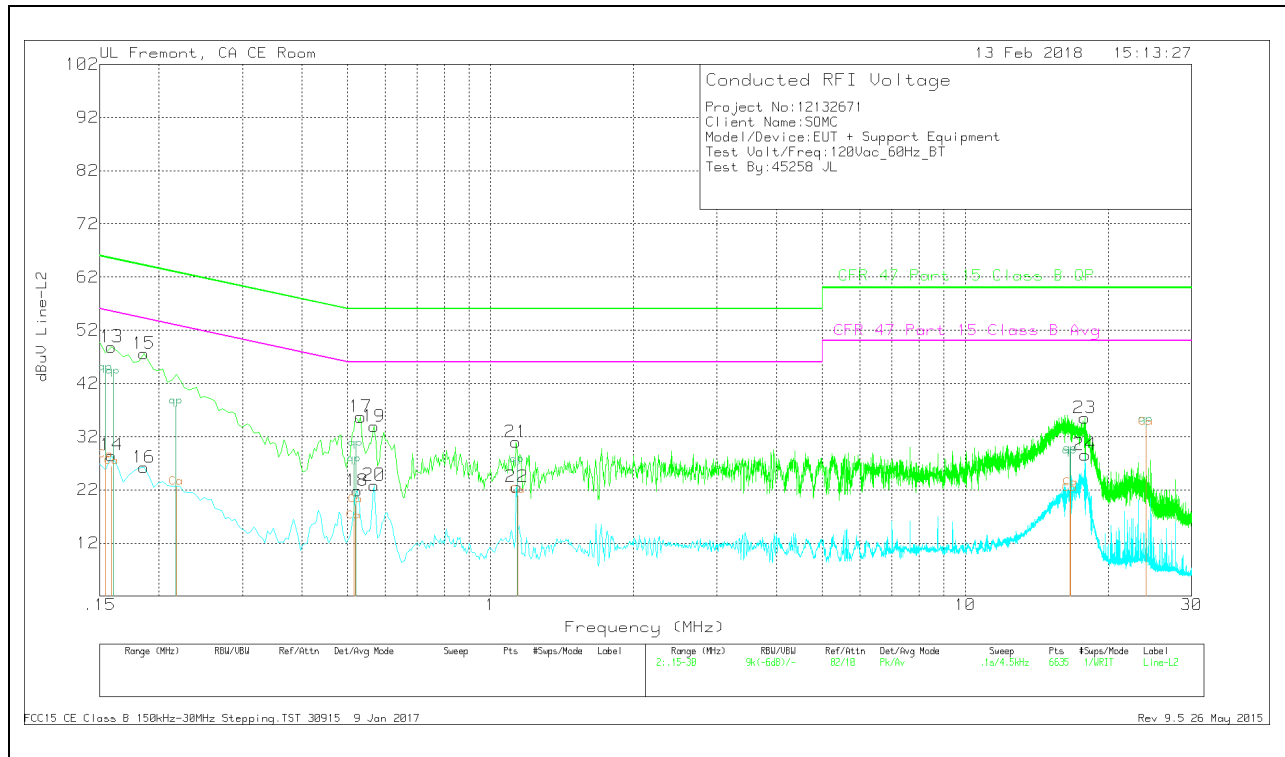

Range 2: Line-L2 .15 - 30MHz											
Marker	Frequency (MHz)	Meter Reading (dBuV)	Det	LISN L2	LC Cables C2&C3	Limiter (dB)	Corrected Reading dBuV	CFR 47 Part 15 Class B QP	Margin (dB)	CFR 47 Part 15 Class B Avg	Margin (dB)
13	.159	38.75	Pk	0	0	10.1	48.85	65.52	-16.67	-	-
14	.159	18.38	Av	0	0	10.1	28.48	-	-	55.52	-27.04
15	.186	37.5	Pk	0	0	10.1	47.6	64.21	-16.61	-	-
16	.186	16.11	Av	0	0	10.1	26.21	-	-	54.21	-28
17	.5325	25.61	Pk	0	0	10.1	35.71	56	-20.29	-	-
18	.5235	11.73	Av	0	0	10.1	21.83	-	-	46	-24.17
19	.5685	23.8	Pk	0	0	10.1	33.9	56	-22.1	-	-
20	.5685	12.73	Av	0	0	10.1	22.83	-	-	46	-23.17
21	1.131	20.79	Pk	0	.1	10.1	30.99	56	-25.01	-	-
22	1.1355	12.36	Av	0	.1	10.1	22.56	-	-	46	-23.44
23	17.853	24.89	Pk	0	.3	10.3	35.49	60	-24.51	-	-
24	17.898	18	Av	0	.3	10.3	28.6	-	-	50	-21.4

Pk - Peak detector

Av - Average detection