



FCC RF Test Report

APPLICANT : Sony Mobile Communications Inc.
EQUIPMENT : GSM/WCDMA/LTE Phone+Bluetooth, DTS/UNII
a/b/g/n and NFC
BRAND NAME : Sony
FCC ID : PY7-33143E
STANDARD : FCC Part 15 Subpart E §15.407
CLASSIFICATION : (NII) Unlicensed National Information Infrastructure

This is a variant report which is only valid together with the original test report. The product was received on Nov. 22, 2016 and testing was completed on Jan. 19, 2017. We, SPORTON INTERNATIONAL INC., would like to declare that the tested sample has been evaluated in accordance with the test procedures and has been in compliance with the applicable technical standards.

The test results in this report apply exclusively to the tested model / sample. Without written approval of SPORTON INTERNATIONAL INC., the test report shall not be reproduced except in full.

Reviewed by: Joseph Lin / Supervisor

Approved by: Jones Tsai / Manager



SPORTON INTERNATIONAL INC.

No. 52, Hwa Ya 1st Rd., Hwa Ya Technology Park, Kwei-Shan District, Tao Yuan City, Taiwan, R.O.C.

SPORTON INTERNATIONAL INC.

TEL : 886-3-327-3456

FAX : 886-3-328-4978

FCC ID : PY7-33143E

Page Number : 1 of 21

Report Issued Date : Mar. 10, 2017

Report Version : Rev. 01

Report Template No.: BU5-FR15EWL Version 1.4



TABLE OF CONTENTS

REVISION HISTORY.....3

SUMMARY OF TEST RESULT4

1 GENERAL DESCRIPTION5

 1.1 Applicant5

 1.2 Manufacturer.....5

 1.3 Product Feature of Equipment Under Test.....5

 1.4 Modification of EUT6

 1.5 Testing Location7

 1.6 Applicable Standards.....7

2 TEST CONFIGURATION OF EQUIPMENT UNDER TEST8

 2.1 Carrier Frequency Channel8

 2.2 Test Mode.....9

 2.3 Connection Diagram of Test System.....9

 2.4 EUT Operation Test Setup9

3 TEST RESULT.....10

 3.1 Maximum Conducted Output Power Measurement10

 3.2 Unwanted Radiated Emission Measurement12

 3.3 Automatically Discontinue Transmission18

 3.4 Antenna Requirements19

4 LIST OF MEASURING EQUIPMENT20

5 UNCERTAINTY OF EVALUATION.....21

APPENDIX A. CONDUCTED TEST RESULTS

APPENDIX B. RADIATED SPURIOUS EMISSION

APPENDIX C. RADIATED SPURIOUS EMISSION PLOTS

APPENDIX D. DUTY CYCLE PLOTS

APPENDIX E. ORIGINAL REPORT



REVISION HISTORY

REPORT NO.	VERSION	DESCRIPTION	ISSUED DATE
FR6N2205-01E	Rev. 01	Initial issue of report	Mar. 10, 2017



SUMMARY OF TEST RESULT

Report Section	FCC Rule	Description	Limit	Result	Remark
3.1	15.407(a)	Maximum Conducted Output Power	FCC ≤ 24 dBm (depend on band)	Pass	-
3.2	15.407(b)	Unwanted Emissions	≤ -17, -27 dBm (depend on band)&15.209(a)	Pass	Under limit 3.47 dB at 5150.000 MHz
3.3	15.407(c)	Automatically Discontinue Transmission	Discontinue Transmission	Pass	-
3.4	15.203 & 15.407(a)	Antenna Requirement	N/A	Pass	-



1 General Description

1.1 Applicant

Sony Mobile Communications Inc.

4-12-3 Higashi-Shinagawa, Shinagawa-ku, Tokyo, 140-0002, Japan

1.2 Manufacturer

Sony Mobile Communications Inc.

4-12-3 Higashi-Shinagawa, Shinagawa-ku, Tokyo, 140-0002, Japan

1.3 Product Feature of Equipment Under Test

GSM/WCDMA/LTE, Bluetooth, DTS/UNII, a/b/g/n, GPS, and NFC

Standards-related Product Specification	
Antenna Type	PIFA Antenna
Antenna Gain	<5150 MHz ~ 5250 MHz> -0.70 dBi
	<5250 MHz ~ 5350 MHz> -0.20 dBi
	<5470 MHz ~ 5725 MHz> -0.30 dBi

Remark: This is a variant report. All the test cases were performed on original report which can be referred to Sporton Report Number FR6N2202-01E.

EUT Information List			
HW Version	SW Version	S/N	Performed Test Item
A	0.79	RQ3003E7H4	RF conducted measurement Radiated Spurious Emission



Accessory List	
AC Adapter 1	Model No. : UCH20
	S/N : 1215W486600059
Earphone 1	Model No. : MH410C
	S/N : 1632A86100002DB
USB Cable	Model No. : UCB20
	S/N : 1625A91B0003352

Note:

1. Above EUT list and accessory list used are electrically identical per declared by manufacturer.
2. Above the accessories list are used to exercise the EUT during test.
3. For other wireless features of this EUT, test report will be issued separately.

1.4 Modification of EUT

No modifications are made to the EUT during all test items.



1.5 Testing Location

Sporton Lab is accredited to ISO 17025 by Taiwan Accreditation Foundation (TAF code : 1190) and the FCC designation No. TW0007 under the FCC 2.948(e) by Mutual Recognition Agreement (MRA) in FCC Test.

Test Site	SPORTON INTERNATIONAL INC.
Test Site Location	No. 52, Hwa Ya 1 st Rd., Hwa Ya Technology Park, Kwei-Shan District, Tao Yuan City, Taiwan, R.O.C. TEL: +886-3-327-3456 FAX: +886-3-328-4978
Test Site No.	Sporton Site No.
	TH05-HY

Note: The test site complies with ANSI C63.4 2014 requirement.

Test Site	SPORTON INTERNATIONAL INC.
Test Site Location	No.58, Aly. 75, Ln. 564, Wenhua 3rd Rd. Guishan Dist, Taoyuan City, Taiwan (R.O.C.) TEL: +886-3-327-0868 FAX: +886-3-327-0855
Test Site No.	Sporton Site No.
	03CH11-HY

Note: The test site complies with ANSI C63.4 2014 requirement.

1.6 Applicable Standards

According to the specifications of the manufacturer, the EUT must comply with the requirements of the following standards:

- ♦ FCC Part 15 Subpart E
- ♦ FCC KDB 789033 D02 General UNII Test Procedures New Rules v01r03
- ♦ ANSI C63.10-2013

Remark:

1. All test items were verified and recorded according to the standards and without any deviation during the test.
2. This EUT has also been tested and complied with the requirements of FCC Part 15, Subpart B, recorded in a separate test report.



2 Test Configuration of Equipment Under Test

The EUT has been associated with peripherals and configuration operated in a manner tended to maximize its emission characteristics in a typical application. Frequency range investigated: radiated emission (9 kHz to the 10th harmonic of the highest fundamental frequency or to 40 GHz, whichever is lower). For radiated measurement, pre-scanned in three orthogonal panels, X, Y, Z. The worst cases (Y plane) were recorded in this report.

2.1 Carrier Frequency Channel

Frequency Band	Channel	Freq. (MHz)	Channel	Freq. (MHz)
5150-5250 MHz Band 1 (U-NII-1)	36	5180	44	5220
	38*	5190	46*	5230
	40	5200	48	5240
	-	-		

Frequency Band	Channel	Freq. (MHz)	Channel	Freq. (MHz)
5250-5350 MHz Band 2 (U-NII-2A)	52	5260	60	5300
	54*	5270	62*	5310
	56	5280	64	5320
	-	-		

Frequency Band	Channel	Freq. (MHz)	Channel	Freq. (MHz)
5470-5725 MHz Band 3 (U-NII-2C)	100	5500	112	5560
	102*	5510	116	5580
	104	5520	132	5660
	-	-	134*	5670
	108	5540	136	5680
	110*	5550	140	5700

Frequency Band	Channel	Freq. (MHz)	Channel	Freq. (MHz)
Straddle Channel	-	-	144	5720
	142*	5710		

Note: The above Frequency and Channel in "*" were 802.11n HT40

2.2 Test Mode

Final test mode of conducted test items and radiated spurious emissions are considering the modulation and worse data rates as below table.

Modulation	Data Rate
802.11a	MCS0
802.11n HT40	MCS0

Ch. #		Band I : 5150-5250 MHz	Band II : 5250-5350 MHz	Band III : 5470-5725MHz
		802.11n HT40	802.11n HT40	802.11a
L	Low	38	-	100
M	Middle	-	-	-
H	High	-	62	-

2.3 Connection Diagram of Test System

<WLAN Tx Mode>

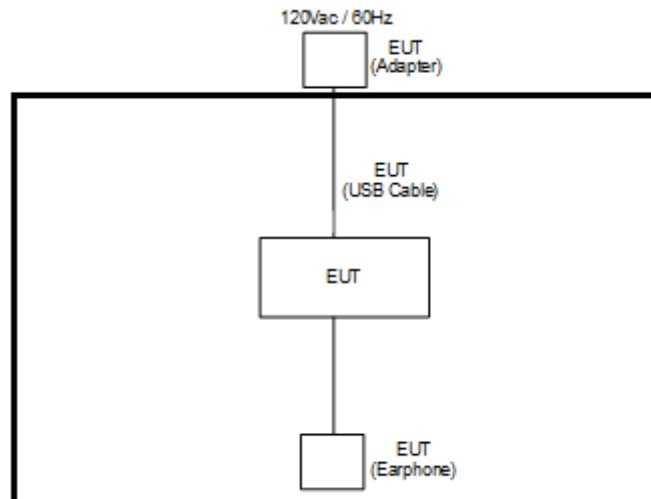

2.4 EUT Operation Test Setup

For RF test items, an engineering test program was provided and enabled to make EUT transmitting signals.



3 Test Result

3.1 Maximum Conducted Output Power Measurement

3.1.1 Limit of Maximum Conducted Output Power

<FCC 14-30 CFR 15.407>

For mobile and portable client devices in the 5.15–5.25 GHz band, the maximum conducted output power over the frequency band of operation shall not exceed 250 mW.

For the 5.25–5.725 GHz bands, the maximum conducted output power over the frequency bands of operation shall not exceed the lesser of 250 mW or 11 dBm 10 log B, where B is the 26 dB emission bandwidth in megahertz.

For Straddle Channel, U-NII procedures and limits were applied for operations in the frequency band in accordance with FCC KDB 644545 D03.

If transmitting antennas of directional gain greater than 6 dBi are used, the peak output power shall be reduced by the amount in dB that the directional gain of the antenna exceeds 6 dBi.

Note that U-NII-2 band, devices with a maximum e.i.r.p. greater than 500 mW shall implement TPC in order to have the capability to operate at least 6 dB below the maximum permitted e.i.r.p. of 1 W.

3.1.2 Measuring Instruments

The measuring equipment is listed in the section 4 of this test report.

3.1.3 Test Procedures

The testing follows Method PM of FCC KDB 789033 D02 General UNII Test Procedures New Rules v01r03.

Method PM (Measurement using an RF average power meter):

1. Measurement is performed using a wideband RF power meter.
2. The EUT is configured to transmit continuously with a consistent duty cycle at its maximum power control level.
3. Measure the average power of the transmitter, and the average power is corrected with duty factor, $10 \log(1/x)$, where x is the duty cycle.

For straddle channel, the testing follows Method SA-3 (RMS detection with max hold) of FCC KDB 789033 D02 General UNII Test Procedures New Rules v01r03.

Compute power by integrating the spectrum across the 99% occupied bandwidth of the signal using the instrument's band power measurement function.

3.1.4 Test Setup

For normal channel:

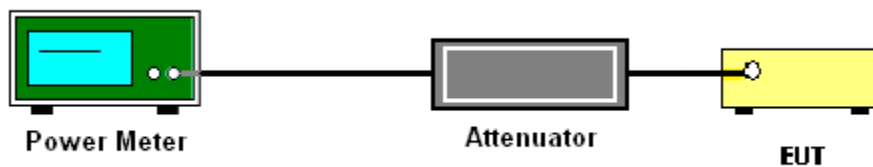

For straddle channel:

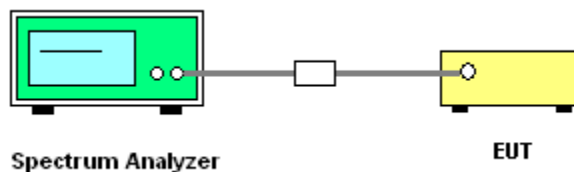

3.1.5 Test Result of Maximum Conducted Output Power

Please refer to Appendix A.



3.2 Unwanted Radiated Emission Measurement

This section as specified in FCC Part 15.407(b) is to measure unwanted emissions through radiated measurement for band edge spurious emissions and out of band emissions measurement. The unwanted emissions shall comply with 15.407(b)(1) to (6), and restricted bands per FCC Part15.205.

3.2.1 Limit of Unwanted Emissions

- (1) For transmitters operating in the 5150-5250 MHz band: all emissions outside of the 5150-5350 MHz band shall not exceed an EIRP of -27dBm/MHz.

For transmitters operating in the 5250-5350 MHz band: all emissions outside of the 5150-5350 MHz band shall not exceed an EIRP of -27 dBm/MHz. Devices operating in the 5250-5350 MHz band that generate emissions in the 5150-5250 MHz band must meet all applicable technical requirements for operation in the 5150-5250 MHz band (including indoor use) or alternatively meet an out-of-band emission EIRP limit of -27 dBm/MHz in the 5150-5250 MHz band.

For transmitters operating in the 5470-5725MHz band: all emissions outside of the 5470-5725MHz band shall not exceed an EIRP of -27 dBm/MHz.

- (2) Unwanted spurious emissions fallen in restricted bands per FCC Part15.205 shall comply with the general field strength limits set forth in § 15.209 as below table,

Frequency (MHz)	Field Strength (microvolts/meter)	Measurement Distance (meters)
0.009 – 0.490	2400/F(kHz)	300
0.490 – 1.705	24000/F(kHz)	30
1.705 – 30.0	30	30
30 – 88	100	3
88 – 216	150	3
216 - 960	200	3
Above 960	500	3

Note: The following formula is used to convert the EIRP to field strength.

$$E = \frac{1000000\sqrt{30P}}{3} \mu\text{V/m, where P is the eirp (Watts)}$$



EIRP (dBm)	Field Strength at 3m (dBμV/m)
-17	78.3
- 27	68.3

(3) KDB789033 D01 v01r03 G)2)c)

- (i) Section 15.407(b)(1-3) specifies the unwanted emissions limit for the U-NII-1 and 2 bands. As specified, emissions above 1000 MHz that are outside of the restricted bands are subject to a peak emission limit of -27 dBm/MHz. However, an out-of-band emission that complies with both the average and peak limits of Section 15.209 is not required to satisfy the -27 dBm/MHz dBm/MHz peak emission limit.
- (ii) Section 15.407(b)(4) specifies the unwanted emissions limit for the U-NII-3 band. A band emissions mask is specified in Section 15.407(b)(4)(i). An alternative to the band emissions mask is specified in Section 15.407(b)(4)(ii). The alternative limits are based on the highest antenna gain specified in the filing. There are also marketing and importation restrictions for the alternative limit

3.2.2 Measuring Instruments

The measuring equipment is listed in the section 4 of this test report.



3.2.3 Test Procedures

1. The testing follows FCC KDB 789033 D02 General UNII Test Procedures New Rules v01r03.
Section G) Unwanted emissions measurement.

(1) Procedure for Unwanted Emissions Measurements Below 1000MHz

- RBW = 120 kHz
- VBW = 300 kHz
- Detector = Peak
- Trace mode = max hold

(2) Procedure for Peak Unwanted Emissions Measurements Above 1000 MHz

- RBW = 1 MHz
- VBW \geq 3 MHz
- Detector = Peak
- Sweep time = auto
- Trace mode = max hold

(3) Procedures for Average Unwanted Emissions Measurements Above 1000MHz

- RBW = 1 MHz
- VBW = 10 Hz, when duty cycle is no less than 98 percent.
- VBW \geq 1/T, when duty cycle is less than 98 percent where T is the minimum transmission duration over which the transmitter is on and is transmitting at its maximum power control level for the tested mode of operation.

2. The EUT was placed on a turntable with 0.8 meter for frequency below 1GHz and 1.5 meter for frequency above 1GHz respectively above ground.
3. The EUT was set 3 meters from the interference receiving antenna which was mounted on the top of a variable height antenna tower.
4. The antenna is a broadband antenna and its height is adjusted between one meter and four meters above ground to find the maximum value of the field strength for both horizontal polarization and vertical polarization of the antenna.
5. For each suspected emission, the EUT was arranged to its worst case and then adjust the antenna tower (from 1 m to 4 m) and turntable (from 0 degree to 360 degrees) to find the maximum reading.
6. For testing below 1GHz, if the emission level of the EUT in peak mode was 3 dB lower than the limit specified, then peak values of EUT will be reported, otherwise, the emissions will be repeated one by one using the CISPR quasi-peak method and reported.
7. For testing above 1GHz, the emission level of the EUT in peak mode was 20dB lower than average limit (that means the emission level in average mode also complies with the limit in average mode), then peak values of EUT will be reported, otherwise, the emissions will be measured in average mode again and reported.

3.2.4 Test Setup

For radiated emissions below 30MHz

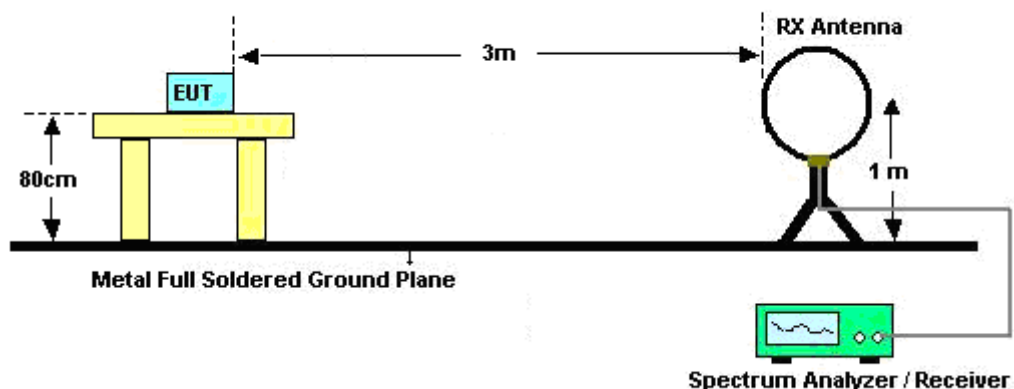

For radiated emissions from 30MHz to 1GHz

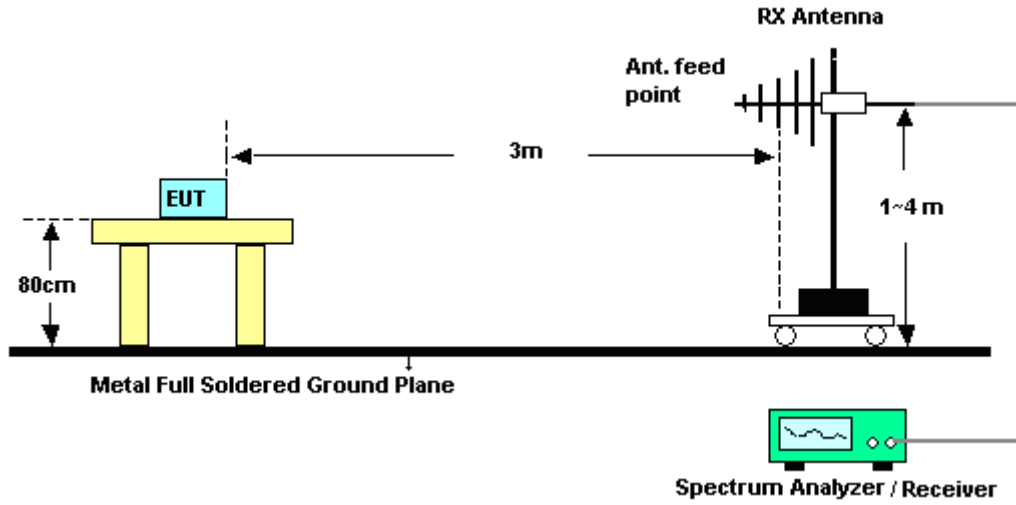

For radiated emissions above 1GHz

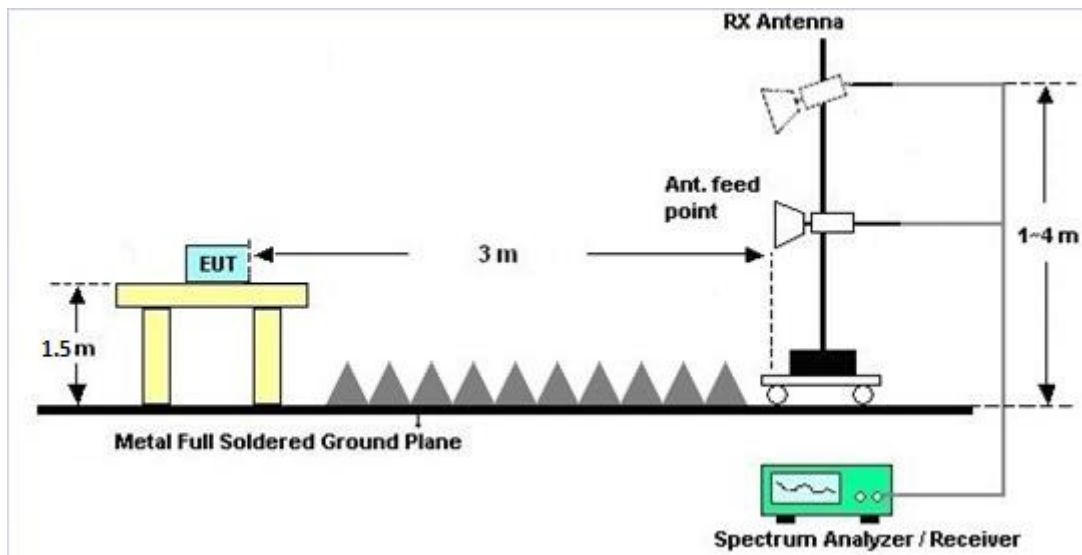



3.2.5 Test Results of Radiated Spurious Emissions (9 kHz ~ 30 MHz)

The low frequency, which started from 9 kHz to 30MHz, was pre-scanned and the result which was 20dB lower than the limit line per 15.31(o) was not reported.

3.2.6 Test Result of Radiated Spurious at Band Edges

Please refer to Appendix B and C.

3.2.7 Duty Cycle

Please refer to Appendix D.

3.2.8 Test Result of Radiated Spurious Emissions (30MHz ~ 10th Harmonic)

Please refer to Appendix B and C.



3.3 Automatically Discontinue Transmission

3.3.1 Limit of Automatically Discontinue Transmission

The device shall automatically discontinue transmission in case of either absence of information to transmit or operational failure. These provisions are not intended to preclude the transmission of control or signaling information or the use of repetitive codes used by certain digital technologies to complete frame or burst intervals. Applicants shall include in their application for equipment authorization to describe how this requirement is met.

3.3.2 Measuring Instruments

The measuring equipment is listed in the section 4 of this test report.

3.3.3 Test Result of Automatically Discontinue Transmission

While the EUT is not transmitting any information, the EUT can automatically discontinue transmission and become standby mode for power saving. The EUT can detect the controlling signal of ACK message transmitting from remote device and verify whether it shall resend or discontinue transmission.



3.4 Antenna Requirements

3.4.1 Standard Applicable

According to FCC 47 CFR Section 15.407(a)(1)(2) ,if transmitting antenna directional gain is greater than 6 dBi, both the peak transmit power and the peak power spectral density shall be reduced by the amount in dB that the directional gain of the antenna exceeds 6 dBi.

3.4.2 Antenna Anti-Replacement Construction

An embedded-in antenna design is used.

3.4.3 Antenna Gain

The antenna gain is less than 6 dBi. Therefore, it is not necessary to reduce maximum peak output power limit.



4 List of Measuring Equipment

Instrument	Manufacturer	Model No.	Serial No.	Characteristics	Calibration Date	Test Date	Due Date	Remark
Power Meter	Agilent	E4416A	GB41292344	300MHz~40GHz	Jan. 08, 2016	Dec. 07, 2016~ Dec. 27, 2016	Jan. 07, 2017	Conducted (TH05-HY)
Power Sensor	Agilent	E9327A	US40441548	300MHz~40GHz	Jan. 07, 2016	Dec. 07, 2016~ Dec. 27, 2016	Jan. 06, 2017	Conducted (TH05-HY)
Hygrometer	Testo	608-H2	41410069	N/A	Aug. 28, 2016	Dec. 07, 2016~ Dec. 27, 2016	Aug. 27, 2017	Conducted (TH05-HY)
RF Cable	HUBER + SUHNER	SUCOFLEX 104	MY84209521	1GHz~26GHz	Dec. 02, 2016	Dec. 07, 2016~ Dec. 27, 2016	Dec. 01, 2017	Conducted (TH05-HY)
Loop Antenna	Rohde & Schwarz	HFH2-Z2	100315	9 kHz~30 MHz	Sep. 02, 2015	Jan. 05, 2016~ Jan. 19, 2017	Sep. 01, 2017	Radiation (03CH11-HY)
Bilog Antenna	TESEQ	CBL 6111D	35414	30MHz~1GHz	Oct. 15, 2016	Jan. 05, 2017~ Jan. 19, 2017	Oct. 14, 2017	Radiation (03CH11-HY)
Horn Antenna	SCHWARZBE CK	BBHA 9120 D	9120D-1522	1GHz ~ 18GHz	Mar. 30, 2016	Jan. 05, 2017~ Jan. 19, 2017	Mar. 31, 2017	Radiation (03CH11-HY)
SHF-EHF Horn Antenna	SCHWARZBE CK	BBHA 9170	BBHA917058 4	18GHz- 40GHz	Nov. 08, 2016	Jan. 05, 2017~ Jan. 19, 2017	Nov. 07, 2017	Radiation (03CH11-HY)
Spectrum Analyzer	Keysight	N9010A	MY52350276	10Hz ~ 44GHZ	Mar. 21, 2016	Jan. 05, 2017~ Jan. 19, 2017	Mar. 20, 2017	Radiation (03CH11-HY)
Amplifier	SONOMA	310N	187312	9kHz~1GHz	Nov. 10, 2016	Jan. 05, 2016~ Jan. 19, 2017	Nov. 09, 2017	Radiation (03CH11-HY)
Preamplifier	Keysight	83017A	MY53270080	1GHz~26.5GHz	Nov. 10, 2016	Jan. 05, 2017~ Jan. 19, 2017	Nov. 09, 2017	Radiation (03CH11-HY)
Preamplifier	MITEQ	TTA0204	1872107	2GHz~40GHz	Feb. 15, 2016	Jan. 05, 2017~ Jan. 19, 2017	Feb. 14, 2017	Radiation (03CH11-HY)
Hygrometer	TECPEL	DTN-303B	TP140325	N/A	Nov. 11, 2016	Jan. 05, 2017~ Jan. 19, 2017	Nov. 13, 2017	Radiation (03CH11-HY)
RF Cable	HUBER + SUHNER	SUCOFLEX 104	MY9837/4 MY28419/4M Y28654/4	9KHz~40GHz	Sep. 12, 2016	Jan. 05, 2017~ Jan. 19, 2017	Sep. 11, 2017	Radiation (03CH11-HY)
Controller	EMEC	EM 1000	N/A	Control Turn table & Ant Mast	N/A	Jan. 05, 2017~ Jan. 19, 2017	N/A	Radiation (03CH11-HY)
Antenna Mast	EMEC	AM-BS-4500-B	N/A	1~4m	N/A	Jan. 05, 2017~ Jan. 19, 2017	N/A	Radiation (03CH11-HY)
Turn Table	EMEC	TT 2000	N/A	0~360 Degree	N/A	Jan. 05, 2017~ Jan. 19, 2017	N/A	Radiation (03CH11-HY)
Test Software	Audix	E3	6.2009-8-24	N/A	N/A	Jan. 05, 2017~ Jan. 19, 2017	N/A	Radiation (03CH11-HY)
Filter	Wainwright	WLKX12-2700 -3000-18000-6 0SS	SN3	2.7G High Pass	Sep. 19, 2016	Jan. 05, 2017~ Jan. 19, 2017	Sep. 18, 2017	Radiation (03CH11-HY)
Filter	Wainwright	WLK10-4630-5 093-11000-40 SS	SN1	4.5G High Pass	Sep. 19, 2016	Jan. 05, 2017~ Jan. 19, 2017	Sep. 18, 2017	Radiation (03CH11-HY)



5 Uncertainty of Evaluation

Uncertainty of Radiated Emission Measurement (30 MHz ~ 1000 MHz)

Measuring Uncertainty for a Level of Confidence of 95% ($U = 2Uc(y)$)	5.20
---	------

Uncertainty of Radiated Emission Measurement (1000 MHz ~ 18000 MHz)

Measuring Uncertainty for a Level of Confidence of 95% ($U = 2Uc(y)$)	5.50
---	------

Uncertainty of Radiated Emission Measurement (18000 MHz ~ 40000 MHz)

Measuring Uncertainty for a Level of Confidence of 95% ($U = 2Uc(y)$)	5.20
---	------

Appendix A. Test Result of Conducted Test Items

Test Engineer:	Tommy Lee / Derek Hsu	Temperature:	21~25	°C
Test Date:	2016/12/7~2016/12/27	Relative Humidity:	51~54	%

TEST RESULTS DATA
Average Power Table

FCC Band I										
Mod.	Data Rate	NTX	CH.	Freq. (MHz)	Duty Factor (dB)	Average Conducted Power (dBm)	FCC Conducted Power Limit (dBm)	DG (dBi)		Pass/Fail
11a	6Mbps	1	36	5180	0.12	14.91	24.00	-7.30		Pass
11a	6Mbps	1	44	5220	0.12	14.80	24.00	-7.30		Pass
11a	6Mbps	1	48	5240	0.12	14.87	24.00	-7.30		Pass
HT20	MCS0	1	36	5180	0.13	14.89	24.00	-7.30		Pass
HT20	MCS0	1	44	5220	0.13	14.73	24.00	-7.30		Pass
HT20	MCS0	1	48	5240	0.13	14.81	24.00	-7.30		Pass
HT40	MCS0	1	38	5190	0.26	10.74	24.00	-7.30		Pass
HT40	MCS0	1	46	5230	0.26	10.61	24.00	-7.30		Pass

TEST RESULTS DATA
Average Power Table

FCC Band II										
Mod.	Data Rate	NTX	CH.	Freq. (MHz)	Duty Factor (dB)	Average Conducted Power (dBm)	FCC Conducted Power Limit (dBm)	DG (dBi)	EIRP Power Limit (dBm)	Pass/Fail
11a	6M bps	1	52	5260	0.12	14.52	23.98	-6.50	26.99	Pass
11a	6M bps	1	60	5300	0.12	14.80	23.98	-6.50	26.99	Pass
11a	6M bps	1	64	5320	0.12	14.90	23.98	-6.50	26.99	Pass
HT20	MCS 0	1	52	5260	0.13	14.71	23.98	-6.50	26.99	Pass
HT20	MCS 0	1	60	5300	0.13	14.74	23.98	-6.50	26.99	Pass
HT20	MCS 0	1	64	5320	0.13	14.88	23.98	-6.50	26.99	Pass
HT40	MCS 0	1	54	5270	0.26	10.51	23.98	-6.50	26.99	Pass
HT40	MCS 0	1	62	5310	0.26	10.72	23.98	-6.50	26.99	Pass

TEST RESULTS DATA
Average Power Table

FCC Band III										
Mod.	Data Rate	NTX	CH.	Freq. (MHz)	Duty Factor (dB)	Average Conducted Power (dBm)	FCC Conducted Power Limit (dBm)	DG (dBi)	EIRP Power Limit (dBm)	Pass/Fail
11a	6M bps	1	100	5500	0.12	14.74	23.98	-6.50	26.99	Pass
11a	6M bps	1	116	5580	0.12	14.65	23.98	-6.50	26.99	Pass
11a	6M bps	1	140	5700	0.12	14.50	23.98	-6.50	26.99	Pass
HT20	MCS 0	1	100	5500	0.13	14.57	23.98	-6.50	26.99	Pass
HT20	MCS 0	1	116	5580	0.13	14.64	23.98	-6.50	26.99	Pass
HT20	MCS 0	1	140	5700	0.13	14.84	23.98	-6.50	26.99	Pass
HT40	MCS 0	1	102	5510	0.26	10.77	23.98	-6.50	26.99	Pass
HT40	MCS 0	1	110	5550	0.26	10.76	23.98	-6.50	26.99	Pass
HT40	MCS 0	1	134	5670	0.26	10.76	23.98	-6.50	26.99	Pass

TEST RESULTS DATA
Average Power Table

FCC Straddle Channel										
Mod.	Data Rate	NTX	CH.	Freq. (MHz)	Duty Factor (dB)	Average Conducted Power (dBm)	FCC Conducted Power Limit (dBm)	DG (dBi)		Pass/Fail
11a	6Mbps	1	144	5720	0.12	14.53	-	-6.50		Pass
HT20	MCS0	1	144	5720	0.13	14.80	-	-6.50		Pass
HT40	MCS0	1	142	5710	0.26	10.72	-	-6.50		Pass



Appendix B. Radiated Spurious Emission

Test Engineer :	JC Liao, Jacky Hung, Ken Wu	Temperature :	20~24°C
		Relative Humidity :	50~58%

Band 1 - 5150~5250MHz

WIFI 802.11n HT40 (Band Edge @ 3m)

WIFI Ant. 1	Note	Frequency (MHz)	Level (dBμV/m)	Over Limit (dB)	Limit Line (dBμV/m)	Read Level (dBμV)	Antenna Factor (dB/m)	Cable Loss (dB)	Preamp Factor (dB)	Ant Pos (cm)	Table Pos (deg)	Peak Avg. (P/A)	Pol. (H/V)
802.11n HT40 CH 38 5190MHz		5147.16	57.21	-16.79	74	46.85	32.21	11.18	33.03	242	353	P	H
		5150	50.53	-3.47	54	40.17	32.21	11.18	33.03	242	353	A	H
	*	5190	100.31	-	-	89.91	32.26	11.17	33.03	242	353	P	H
	*	5190	92.28	-	-	81.88	32.26	11.17	33.03	242	353	A	H
		5360.64	50.03	-23.97	74	39.27	32.51	11.28	33.03	242	353	P	H
		5456.64	42.28	-11.72	54	31.33	32.63	11.34	33.02	242	353	A	H
		5147.16	51.88	-22.12	74	41.52	32.21	11.18	33.03	101	356	P	V
		5150	44.4	-9.6	54	34.04	32.21	11.18	33.03	101	356	A	V
	*	5190	91.38	-	-	80.98	32.26	11.17	33.03	101	356	P	V
	*	5190	83.47	-	-	73.07	32.26	11.17	33.03	101	356	A	V
		5420.88	50.69	-23.31	74	39.79	32.58	11.34	33.02	101	356	P	V
		5432.4	42.13	-11.87	54	31.2	32.61	11.34	33.02	101	356	A	V

Remark	1. No other spurious found.
	2. All results are PASS against Peak and Average limit line.



Band 1 5150~5250MHz
WIFI 802.11n HT40 (Harmonic @ 3m)

Table with 14 columns: WIFI Ant. 1, Note, Frequency (MHz), Level (dBµV/m), Over Limit (dB), Limit Line (dBµV/m), Read Level (dBµV), Antenna Factor (dB/m), Cable Loss (dB), Preamp Factor (dB), Ant Pos (cm), Table Pos (deg), Peak Avg. (P/A), Pol. (H/V). Rows include data for 802.11n HT40 CH 38 at 5190MHz and a Remark section.



Band 2 - 5250~5350MHz

WIFI 802.11n HT40 (Band Edge @ 3m)

WIFI	Note	Frequency	Level	Over	Limit	Read	Antenna	Cable	Preamp	Ant	Table	Peak	Pol.
Ant.				Limit	Line	Level	Factor	Loss	Factor	Pos	Pos	Avg.	
1		(MHz)	(dBμV/m)	(dB)	(dBμV/m)	(dBμV)	(dB/m)	(dB)	(dB)	(cm)	(deg)	(P/A)	(H/V)
802.11n HT40 CH 62 5310MHz		5070.46	50.62	-23.38	74	40.36	32.09	11.21	33.04	200	332	P	H
		5094.64	43.29	-10.71	54	32.98	32.14	11.21	33.04	200	332	A	H
	*	5310	100.19	-	-	89.53	32.44	11.25	33.03	200	332	P	H
	*	5310	91.78	-	-	81.12	32.44	11.25	33.03	200	332	A	H
		5351.76	56.95	-17.05	74	46.21	32.49	11.28	33.03	200	332	P	H
		5350.08	49.79	-4.21	54	39.05	32.49	11.28	33.03	200	332	A	H
		5149.24	51.18	-22.82	74	40.82	32.21	11.18	33.03	123	4	P	V
		5119.86	43.09	-10.91	54	32.77	32.16	11.19	33.03	123	4	A	V
	*	5310	93.04	-	-	82.38	32.44	11.25	33.03	123	4	P	V
	*	5310	84.17	-	-	73.51	32.44	11.25	33.03	123	4	A	V
		5420.88	49.97	-24.03	74	39.07	32.58	11.34	33.02	123	4	P	V
		5350.56	43.22	-10.78	54	32.48	32.49	11.28	33.03	123	4	A	V
Remark	1. No other spurious found. 2. All results are PASS against Peak and Average limit line.												



Band 2 5250~5350MHz
WIFI 802.11n HT40 (Harmonic @ 3m)

WIFI Ant. 1	Note	Frequency (MHz)	Level (dBμV/m)	Over Limit (dB)	Limit Line (dBμV/m)	Read Level (dBμV)	Antenna Factor (dB/m)	Cable Loss (dB)	Preamp Factor (dB)	Ant Pos (cm)	Table Pos (deg)	Peak Avg. (P/A)	Pol. (H/V)
802.11n HT40 CH 62		10620	38.92	-35.08	74	35.02	39.9	15.19	51.19	100	0	P	H
		15930	40.55	-33.45	74	35.66	38.29	18.4	51.8	100	0	P	H
													H
													H
5310MHz		10620	38.96	-35.04	74	35.06	39.9	15.19	51.19	100	0	P	V
		15930	43.86	-30.14	74	38.97	38.29	18.4	51.8	100	0	P	V
													V
													V
Remark	1. No other spurious found. 2. All results are PASS against Peak and Average limit line.												



Band 3 - 5470~5725MHz
WIFI 802.11a (Band Edge @ 3m)

WIFI	Note	Frequency	Level	Over	Limit	Read	Antenna	Cable	Preamp	Ant	Table	Peak	Pol.	
Ant.				Limit	Line	Level	Factor	Loss	Factor	Pos	Pos	Avg.		
1		(MHz)	(dBμV/m)	(dB)	(dBμV/m)	(dBμV)	(dB/m)	(dB)	(dB)	(cm)	(deg)	(P/A)	(H/V)	
802.11a CH 100 5500MHz		5469.84	54.58	-19.42	74	43.57	32.65	11.38	33.02	200	337	P	H	
		5468.88	47.12	-6.88	54	36.11	32.65	11.38	33.02	200	337	A	H	
	*	5500	107.7	-	-	96.64	32.7	11.38	33.02	200	337	P	H	
	*	5500	99.3	-	-	88.24	32.7	11.38	33.02	200	337	A	H	
													H	
													H	
			5451.28	51.09	-22.91	74	40.14	32.63	11.34	33.02	300	91	P	V
			5470	43.67	-10.33	54	32.66	32.65	11.38	33.02	300	91	A	V
	*		5500	100.71	-	-	89.65	32.7	11.38	33.02	300	91	P	V
	*		5500	92.46	-	-	81.4	32.7	11.38	33.02	300	91	A	V
													V	
													V	
Remark	1. No other spurious found. 2. All results are PASS against Peak and Average limit line.													



Band 3 - 5470~5725MHz
WIFI 802.11a (Harmonic @ 3m)

Table with 14 columns: WIFI Ant. 1, Note, Frequency (MHz), Level (dBµV/m), Over Limit (dB), Limit Line (dBµV/m), Read Level (dBµV), Antenna Factor (dB/m), Cable Loss (dB), Preamp Factor (dB), Ant Pos (cm), Table Pos (deg), Peak Avg. (P/A), Pol. (H/V). Rows include data for 802.11a CH 100 5500MHz and a Remark section.



Emission below 1GHz
WIFI 802.11n HT40 (LF @ 3m)

WIFI Ant.	Note	Frequency	Level	Over Limit	Limit Line	Read Level	Antenna Factor	Cable Loss	Preamp Factor	Ant Pos	Table Pos	Peak Avg.	Pol.	
1		(MHz)	(dBμV/m)	(dB)	(dBμV/m)	(dBμV)	(dB/m)	(dB)	(dB)	(cm)	(deg)	(P/A)	(H/V)	
802.11n HT40 LF		31.35	24.45	-15.55	40	30.47	25.18	1.29	32.49			P	H	
		73.74	26.67	-13.33	40	44.78	12.87	1.51	32.49			P	H	
		163.38	23.9	-19.6	43.5	38.14	16.5	2	32.74			P	H	
		460.3	24.8	-21.2	46	30.41	23.47	3.28	32.36			P	H	
		745.9	29.39	-16.61	46	30.02	27.62	4.09	32.34			P	H	
		945.4	33.86	-12.14	46	29.93	30.49	4.69	31.25	100	0	P	H	
														H
														H
														H
														H
														H
			40.8	29.26	-10.74	40	40.72	19.74	1.29	32.49			P	V
			53.49	29.69	-10.31	40	46.89	14	1.29	32.49			P	V
			60.51	30.05	-9.95	40	49.13	11.9	1.51	32.49	100	183	P	V
			419	24.32	-21.68	46	31	22.75	2.91	32.34			P	V
			746.6	35.08	-10.92	46	35.68	27.64	4.09	32.33			P	V
			953.8	33.58	-12.42	46	29.46	30.59	4.69	31.16			P	V
														V
													V	
													V	
													V	
													V	
													V	
Remark	1. No other spurious found. 2. All results are PASS against limit line.													



Note symbol

*	Fundamental Frequency which can be ignored. However, the level of any unwanted emissions shall not exceed the level of the fundamental frequency.
!	Test result is over limit line.
P/A	Peak or Average
H/V	Horizontal or Vertical



A calculation example for radiated spurious emission is shown as below:

WIFI	Note	Frequency	Level	Over	Limit	Read	Antenna	Cable	Preamp	Ant	Table	Peak	Pol.
Ant.				Limit	Line	Level	Factor	Loss	Factor	Pos	Pos	Avg.	
1		(MHz)	(dBμV/m)	(dB)	(dBμV/m)	(dBμV)	(dB/m)	(dB)	(dB)	(cm)	(deg)	(P/A)	(H/V)
802.11b		2390	55.45	-18.55	74	54.51	32.22	4.58	35.86	103	308	P	H
CH 01													
2412MHz		2390	43.54	-10.46	54	42.6	32.22	4.58	35.86	103	308	A	H

- Level(dBμV/m) =
Antenna Factor(dB/m) + Cable Loss(dB) + Read Level(dBμV) - Preamp Factor(dB)
- Over Limit(dB) = Level(dBμV/m) – Limit Line(dBμV/m)

For Peak Limit @ 2390MHz:

- Level(dBμV/m)
= Antenna Factor(dB/m) + Cable Loss(dB) + Read Level(dBμV) - Preamp Factor(dB)
= 32.22(dB/m) + 4.58(dB) + 54.51(dBμV) – 35.86 (dB)
= 55.45 (dBμV/m)
- Over Limit(dB)
= Level(dBμV/m) – Limit Line(dBμV/m)
= 55.45(dBμV/m) – 74(dBμV/m)
= -18.55(dB)

For Average Limit @ 2390MHz:

- Level(dBμV/m)
= Antenna Factor(dB/m) + Cable Loss(dB) + Read Level(dBμV) - Preamp Factor(dB)
= 32.22(dB/m) + 4.58(dB) + 42.6(dBμV) – 35.86 (dB)
= 43.54 (dBμV/m)
- Over Limit(dB)
= Level(dBμV/m) – Limit Line(dBμV/m)
= 43.54(dBμV/m) – 54(dBμV/m)
= -10.46(dB)

Both peak and average measured complies with the limit line, so test result is “PASS”.



Appendix C. Radiated Spurious Emission

Test Engineer :	JC Liao, Jacky Hung, Ken Wu	Temperature :	20~24°C
		Relative Humidity :	50~58%

Note symbol

-L	Low channel location
-R	High channel location



Band 1 - 5150~5250MHz
WIFI 802.11n HT40 (Band Edge @ 3m)

WIFI	Band 1 5150~5250MHz Band Edge @ 3m	
ANT	802.11n HT40 CH38 5190MHz - L	
1	Horizontal	Fundamental
Peak	<p>Site : 03CH11-HY Condition : PEAK_BE_74 3m HORN 9120D-HF HORIZONTAL</p>	<p>Site : 03CH11-HY Condition : PEAK_74 3m HORN 9120D-HF HORIZONTAL</p>
Avg.	<p>Site : 03CH11-HY Condition : AV6_BE_54 3m HORN 9120D-HF HORIZONTAL</p>	Left blank

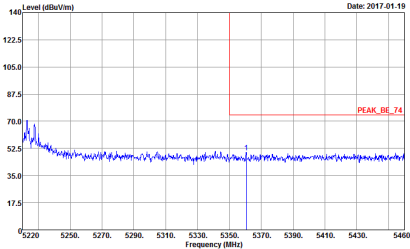
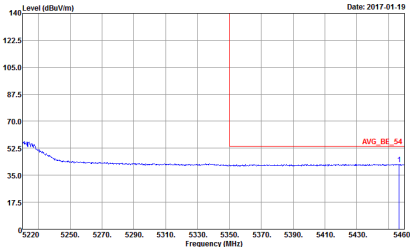

WIFI	Band 1 5150~5250MHz Band Edge @ 3m	
ANT	802.11n HT40 CH38 5190MHz - R	
1	Horizontal	Fundamental
<p>Peak</p>	 <p>Date: 2017.01.19</p> <p>Site : 03CHI1-HY Condition : PEAK_BE_74 3m HORN 9120D-HF HORIZONTAL</p>	<p>Left blank</p>
<p>Avg.</p>	 <p>Date: 2017.01.19</p> <p>Site : 03CHI1-HY Condition : AVG_BE_54 3m HORN 9120D-HF HORIZONTAL</p>	<p>Left blank</p>

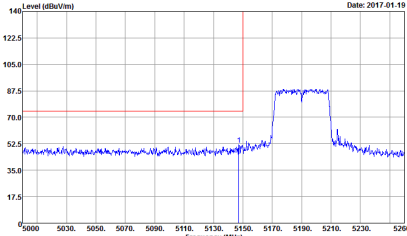
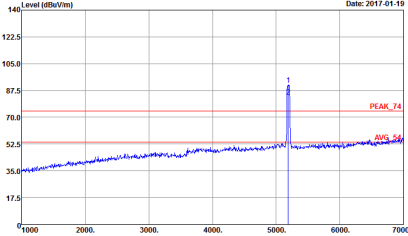
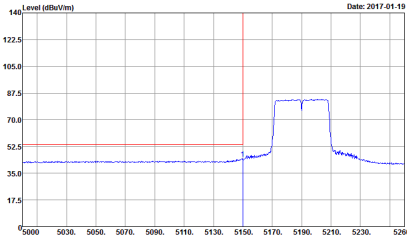

WIFI	Band 1 5150~5250MHz Band Edge @ 3m	
ANT	802.11n HT40 CH38 5190MHz - L	
1	Vertical	Fundamental
Peak	 <p>Date: 2017-01-19</p> <p>Site : 03CH11-HY Condition : PEAK_BE_74 3m HORN 9120D-HF VERTICAL</p>	 <p>Date: 2017-01-19</p> <p>Site : 03CH11-HY Condition : PEAK_74 3m HORN 9120D-HF VERTICAL</p>
Avg.	 <p>Date: 2017-01-19</p> <p>Site : 03CH11-HY Condition : AVG_BE_54 3m HORN 9120D-HF VERTICAL</p>	Left blank



WIFI	Band 1 5150~5250MHz Band Edge @ 3m	
ANT	802.11n HT40 CH38 5190MHz - R	
1	Vertical	Fundamental
Peak	<p>Site : 03CH11-HY Condition : PEAK_BE_74 3m HORN 9120D-HF VERTICAL</p>	Left blank
Avg.	<p>Site : 03CH11-HY Condition : AVG_BE_54 3m HORN 9120D-HF VERTICAL</p>	Left blank



Band 1 - 5150~5250MHz
WIFI 802.11n HT40 (Harmonic @ 3m)

Table with 3 columns: WIFI, ANT, and measurement results for Horizontal and Vertical orientations. Includes two graphs showing Level (dBuV/m) vs Frequency (MHz) with peak and average values.



Band 2 - 5250~5350MHz
WIFI 802.11n HT40 (Band Edge @ 3m)

WIFI	Band 2 5250~5350MHz Band Edge @ 3m	
ANT	802.11n HT40 CH62 5310 - L	
1	Horizontal	Fundamental
Peak	<p>Site : 03CH11-HY Condition : PEAK_BE_74 3m HORN 9120D-HF HORIZONTAL</p>	<p>Site : 03CH11-HY Condition : PEAK_74 3m HORN 9120D-HF HORIZONTAL</p>
Avg.	<p>Site : 03CH11-HY Condition : AV6_BE_54 3m HORN 9120D-HF HORIZONTAL</p>	Left blank



WIFI	Band 2 5250~5350MHz Band Edge @ 3m	
ANT	802.11n HT40 CH62 5310 - R	
1	Horizontal	Fundamental
Peak	<p>Site : 03CH11-HY Condition : PEAK_BE_74 3m HORN 9120D-HF HORIZONTAL</p>	Left blank
Avg.	<p>Site : 03CH11-HY Condition : AVG_BE_54 3m HORN 9120D-HF HORIZONTAL</p>	Left blank



WIFI	Band 2 5250~5350MHz Band Edge @ 3m	
ANT	802.11n HT40 CH62 5310 - L	
1	Vertical	Fundamental
Peak	<p>Date: 2017.01.13</p> <p>Site : 03CH11-HY Condition : PEAK_BE_74 3m HORN 91200-HF VERTICAL</p>	<p>Date: 2017.01.13</p> <p>Site : 03CH11-HY Condition : PEAK_74 3m HORN 91200-HF VERTICAL</p>
Avg.	<p>Date: 2017.01.13</p> <p>Site : 03CH11-HY Condition : AVG_BE_54 3m HORN 91200-HF VERTICAL</p>	Left blank



WIFI	Band 2 5250~5350MHz Band Edge @ 3m	
ANT	802.11n HT40 CH62 5310 - R	
1	Vertical	Fundamental
Peak	<p>Site : 03CH11-HY Condition : PEAK_BE_74 3m HORN 9120D-HF VERTICAL</p>	Left blank
Avg.	<p>Site : 03CH11-HY Condition : AVG_BE_54 3m HORN 9120D-HF VERTICAL</p>	Left blank



Band 2 - 5250~5350MHz
WIFI 802.11n HT40 (Harmonic @ 3m)

WIFI	Band 2 5250~5350MHz Harmonic @ 3m	
ANT	802.11n HT40 CH62 5310	
1	Horizontal	Vertical
Peak Avg.	<p>Site : 03CH11-HY Condition : PEAK_74 3m 9170 SHF HORM_150809 HORIZONTAL</p>	<p>Site : 03CH11-HY Condition : PEAK_74 3m 9170 SHF HORM_150809 VERTICAL</p>



Band 3 - 5470~5725MHz
WIFI 802.11a (Band Edge @ 3m)

WIFI	Band 3 5470~5725MHz Band Edge @ 3m	
ANT	802.11a CH100 5500MHz	
1	Horizontal	Fundamental
Peak	<p>Site : 03CH11-HY Condition : PEAK_BE_74 3m HORN 9120D-HF HORIZONTAL</p>	<p>Site : 03CH11-HY Condition : PEAK_74 3m HORN 9120D-HF HORIZONTAL</p>
Avg.	<p>Site : 03CH11-HY Condition : AVG_BE_54 3m HORN 9120D-HF HORIZONTAL</p>	Left blank

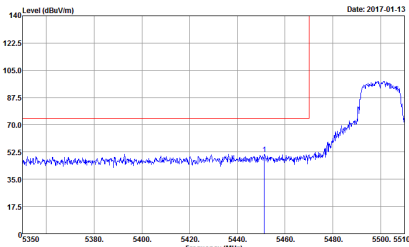
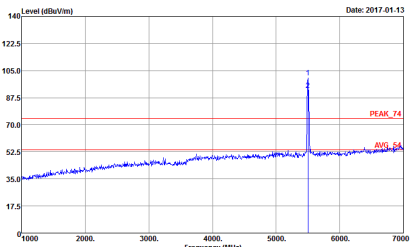
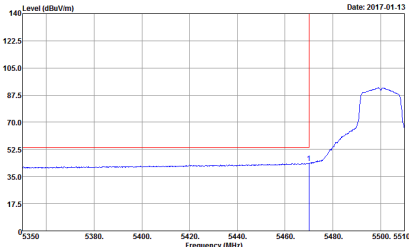

WIFI	Band 3 5470~5725MHz Band Edge @ 3m	
ANT	802.11a CH100 5500MHz	
1	Vertical	Fundamental
Peak	 <p>Date: 2017-01-13</p> <p>Site : 03CH11-HY Condition : PEAK_BE_74 3m HORN 91200-HF VERTICAL</p>	 <p>Date: 2017-01-13</p> <p>Site : 03CH11-HY Condition : PEAK_74 3m HORN 91200-HF VERTICAL</p>
Avg.	 <p>Date: 2017-01-13</p> <p>Site : 03CH11-HY Condition : AVG_BE_54 3m HORN 91200-HF VERTICAL</p>	Left blank



Band 3 - 5470~5725MHz
WIFI 802.11a (Harmonic @ 3m)

Table with 3 columns: WIFI, ANT, and 1. It contains two graphs: 'Horizontal' and 'Vertical'. Each graph plots Level (dBuV/m) vs Frequency (MHz) with peaks labeled 1, 2, and 3. Includes site and condition details for each graph.



Emission below 1GHz
5GHz WIFI 802.11n HT40 (LF)

WIFI	5GHz WIFI	
ANT	802.11n HT40 LF	
1	Horizontal	Vertical
QP / Peak	<p>Site : 03CH11-HY Condition : QP 3m BE-LOG 6111D-LF_ETC HORIZONTAL</p>	<p>Site : 03CH11-HY Condition : QP 3m BE-LOG 6111D-LF_ETC VERTICAL</p>

Appendix D Duty Cycle Plots

Band	Duty Cycle(%)	T(us)	1/T(kHz)	VBW Setting
802.11a	97.22	1400	0.714	1kHz
5GHz 802.11n HT40	94.2	650	1.54	3kHz

802.11a

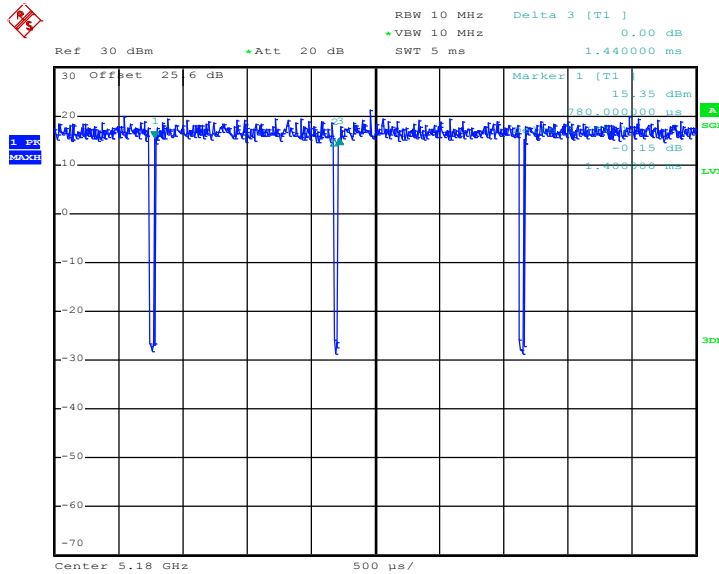

Date: 7.DEC.2016 17:21:44



5GHz 802.11n HT40

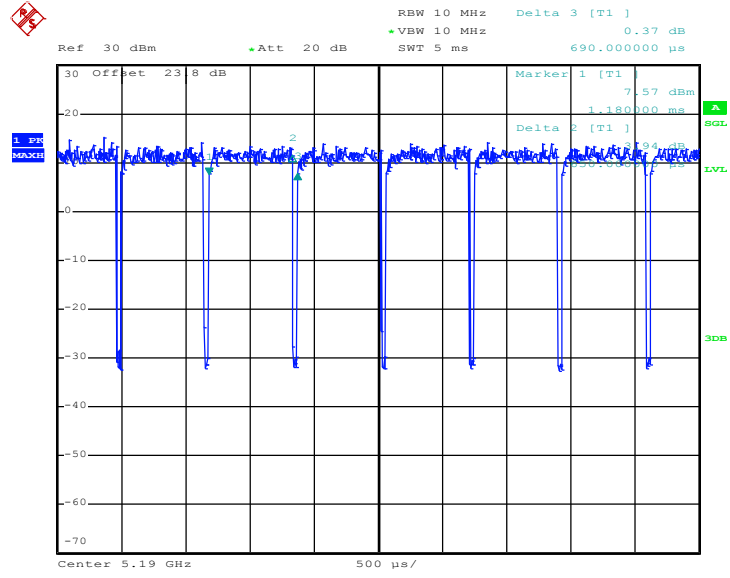

Date: 7.DEC.2016 20:13:05



Appendix E. Original Report

Please refer to Sporton report number FR6N2202-01E