



FCC RF Test Report

APPLICANT : Sony Mobile Communications Inc.
EQUIPMENT : GSM/WCDMA/LTE Phone+Bluetooth, DTS/UNII
a/b/g/n and NFC
BRAND NAME : Sony
FCC ID : PY7-19719M
STANDARD : FCC Part 15 Subpart E §15.407
CLASSIFICATION : (NII) Unlicensed National Information Infrastructure

The product was received on Nov. 22, 2016 and testing was completed on Jan. 25, 2017. We, SPORTON INTERNATIONAL INC., would like to declare that the tested sample has been evaluated in accordance with the test procedures and has been in compliance with the applicable technical standards.

The test results in this report apply exclusively to the tested model / sample. Without written approval of SPORTON INTERNATIONAL INC., the test report shall not be reproduced except in full.

Reviewed by: Joseph Lin / Supervisor

Approved by: Jones Tsai / Manager



SPORTON INTERNATIONAL INC.

No. 52, Hwa Ya 1st Rd., Hwa Ya Technology Park, Kwei-Shan District, Tao Yuan City, Taiwan, R.O.C.

SPORTON INTERNATIONAL INC.

TEL : 886-3-327-3456

FAX : 886-3-328-4978

FCC ID : PY7-19719M

Page Number : 1 of 35

Report Issued Date : Mar. 10, 2017

Report Version : Rev. 03

Report Template No.: BU5-FR15EWLB4 AC MA Version 1.4



TABLE OF CONTENTS

REVISION HISTORY 3

SUMMARY OF TEST RESULT 4

1 GENERAL DESCRIPTION 5

 1.1 Applicant 5

 1.2 Manufacturer 5

 1.3 Product Feature of Equipment Under Test 5

 1.4 Modification of EUT 6

 1.5 Testing Location 7

 1.6 Applicable Standards 8

2 TEST CONFIGURATION OF EQUIPMENT UNDER TEST 9

 2.1 Carrier Frequency and Channel 9

 2.2 Test Mode 10

 2.3 Connection Diagram of Test System 11

 2.4 Support Unit used in test configuration and system 12

 2.5 EUT Operation Test Setup 12

 2.6 Measurement Results Explanation Example 12

3 TEST RESULT 13

 3.1 6dB and 26dB and 99% Occupied Bandwidth Measurement 13

 3.2 Maximum Conducted Output Power Measurement 16

 3.3 Power Spectral Density Measurement 17

 3.4 Unwanted Emissions Measurement 20

 3.5 AC Conducted Emission Measurement 26

 3.6 Frequency Stability Measurement 30

 3.7 Automatically Discontinue Transmission 31

 3.8 Antenna Requirements 32

4 LIST OF MEASURING EQUIPMENT 33

5 UNCERTAINTY OF EVALUATION 35

APPENDIX A. CONDUCTED TEST RESULTS

APPENDIX B. RADIATED SPURIOUS EMISSION

APPENDIX C. RADIATED SPURIOUS EMISSION PLOTS

APPENDIX D. DUTY CYCLE PLOTS



REVISION HISTORY

REPORT NO.	VERSION	DESCRIPTION	ISSUED DATE
FR6N2202-01F	Rev. 01	Initial issue of report	Feb. 21, 2017
FR6N2202-01F	Rev. 02	Revising test mode information in section2.1.	Mar. 01, 2017
FR6N2202-01F	Rev. 03	Revising the description of limit of unwanted emissions in report section 3.4.1.	Mar. 10, 2017



SUMMARY OF TEST RESULT

Report Section	FCC Rule	Description	Limit	Result	Remark
3.1	15.403(i)	6dB, 26dB and 99% Occupied Bandwidth	> 500kHz	Pass	-
3.2	15.407(a)	Maximum Conducted Output Power	≤ 30 dBm	Pass	-
3.3	15.407(a)	Power Spectral Density	≤ 30 dBm/500kHz	Pass	-
3.4	15.407(b)	Unwanted Emissions	15.407(b)(4)(i) & 15.209(a)	Pass	Under limit 5.83 dB at 37.830 MHz
3.5	15.207	AC Conducted Emission	15.207(a)	Pass	Under limit 16.50 dB at 0.150 MHz
3.6	15.407(g)	Frequency Stability	Within Operation Band	Pass	-
3.7	15.407(c)	Automatically Discontinue Transmission	Discontinue Transmission	Pass	-
3.8	15.203 & 15.407(a)	Antenna Requirement	N/A	Pass	-



1 General Description

1.1 Applicant

Sony Mobile Communications Inc.

4-12-3 Higashi-Shinagawa, Shinagawa-ku, Tokyo, 140-0002, Japan

1.2 Manufacturer

Sony Mobile Communications Inc.

4-12-3 Higashi-Shinagawa, Shinagawa-ku, Tokyo, 140-0002, Japan

1.3 Product Feature of Equipment Under Test

GSM/WCDMA/LTE, Bluetooth, DTS/UNII, a/b/g/n, GPS, and NFC

Standards-related Product Specification	
Antenna Type / Gain	PIFA Antenna with gain -0.40 dBi

EUT Information List			
HW Version	SW Version	S/N	Performed Test Item
A	0.79	RQ3003BXX4	RF conducted measurement
		RQ3003BXJY	Radiated Spurious Emission
		RQ3003BXX6	Conducted Emission



Accessory List	
AC Adapter 1	Model No. : UCH20
	S/N :
	1215W486600059 (for radiated spurious emission) 5816W13300005 (for conducted emission)
Earphone 1	Model No. : MH410c
	S/N:
	1632A86100002DB (for radiated spurious emission) 1632A864000088 (for conducted emission)
USB Cable	Model No. : UCB20
	S/N :
	1625A91B0003352 (for radiated spurious emission) 1625A91900007E2 (for conducted emission)

Note:

1. Above EUT list and accessory list used are electrically identical per declared by manufacturer.
2. Above the accessories list are used to exercise the EUT during test.
3. For other wireless features of this EUT, test report will be issued separately.

1.4 Modification of EUT

No modifications are made to the EUT during all test items.



1.5 Testing Location

Sporton Lab is accredited to ISO 17025 by Taiwan Accreditation Foundation (TAF code : 1190) and the FCC designation No. TW0007 under the FCC 2.948(e) by Mutual Recognition Agreement (MRA) in FCC Test.

Test Site	SPORTON INTERNATIONAL INC.	
Test Site Location	No. 52, Hwa Ya 1 st Rd., Hwa Ya Technology Park, Kwei-Shan District, Tao Yuan City, Taiwan, R.O.C. TEL: +886-3-327-3456 FAX: +886-3-328-4978	
Test Site No.	Sporton Site No.	
	TH05-HY	CO05-HY

Note: The test site complies with ANSI C63.4 2014 requirement.

Test Site	SPORTON INTERNATIONAL INC.	
Test Site Location	No.58, Aly. 75, Ln. 564, Wenhua 3rd Rd. Guishan Dist, Taoyuan City, Taiwan (R.O.C.) TEL: +886-3-327-0868 FAX: +886-3-327-0855	
Test Site No.	Sporton Site No.	
	03CH11-HY	

Note: The test site complies with ANSI C63.4 2014 requirement.



1.6 Applicable Standards

According to the specifications of the manufacturer, the EUT must comply with the requirements of the following standards:

- ♦ FCC Part 15 Subpart E
- ♦ FCC KDB 789033 D02 General UNII Test Procedures New Rules v01r03
- ♦ ANSI C63.10-2013

Remark:

1. All test items were verified and recorded according to the standards and without any deviation during the test.
2. This EUT has also been tested and complied with the requirements of FCC Part 15, Subpart B, recorded in a separate test report.



2 Test Configuration of Equipment Under Test

The EUT has been associated with peripherals and configuration operated in a manner tended to maximize its emission characteristics in a typical application. Frequency range investigated: conducted emission (150 kHz to 30 MHz) and radiated emission (9 kHz to the 10th harmonic of the highest fundamental frequency or to 40 GHz, whichever is lower). For radiated measurement, pre-scanned in three orthogonal panels, X, Y, Z. The worst cases (Y plane) were recorded in this report.

2.1 Carrier Frequency and Channel

Frequency Band	Channel	Freq. (MHz)	Channel	Freq. (MHz)
5725-5850 MHz Band 4 (U-NII-3)	149	5745	157	5785
	151*	5755	159*	5795
	153	5765	161	5805
	-	-	165	5825

Note: The above Frequency and Channel in "*" were 802.11n HT40.



2.2 Test Mode

Final test mode of conducted test items and radiated spurious emissions are considering the modulation and worse data rates as below table.

Modulation	Data Rate
802.11a	6 Mbps
802.11n HT20	MCS0
802.11n HT40	MCS0

AC Conducted Emission	Mode 1 : GSM1900 Idle + Bluetooth Link + WLAN (5GHz) Link + Camera (Rear) + Earphone 1 + Battery + USB Cable (Charging from Adapter 3)
------------------------------	--

Ch. #		Band IV : 5725-5850 MHz		
		802.11a	802.11n HT20	802.11n HT40
L	Low	149	149	151
M	Middle	157	157	-
H	High	165	165	159

2.3 Connection Diagram of Test System

<WLAN Tx Mode>

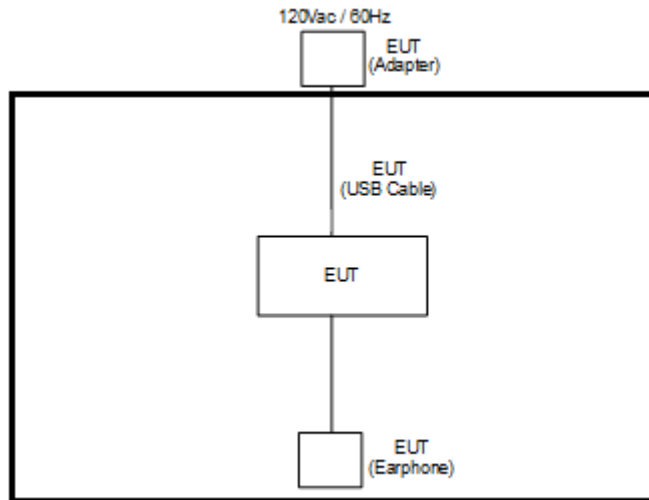

<AC Conducted Emission Mode>

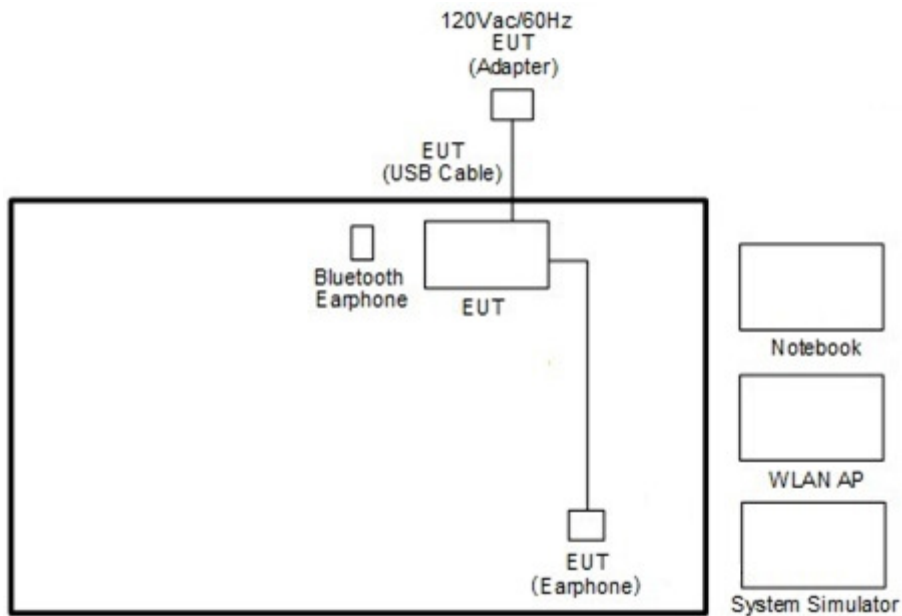



2.4 Support Unit used in test configuration and system

Item	Equipment	Trade Name	Model Name	FCC ID	Data Cable	Power Cord
1.	System Simulator	Anritsu	MT8820C	N/A	N/A	Unshielded, 1.8 m
2.	WLAN AP	D-Link	DIR-865L	KA2IR865LA1	N/A	Unshielded, 1.8m
3.	Notebook	DELL	Latitude E6320	FCC DoC/ Contains FCC ID: QDS-BRCM1054	N/A	AC I/P: Unshielded, 1.2 m DC O/P: Shielded, 1.8 m
4.	Bluetooth Earphone	Sony	SBH20	PY7-RD0010	N/A	N/A
5.	SD Card	SanDisk	MicroSD HC	FCC DoC	N/A	N/A

2.5 EUT Operation Test Setup

For RF test items, an engineering test program was provided and enabled to make EUT transmitting signals.

2.6 Measurement Results Explanation Example

For all conducted test items:

The offset level is set in the spectrum analyzer to compensate the RF cable loss and attenuator factor between EUT conducted output port and spectrum analyzer. With the offset compensation, the spectrum analyzer reading level is exactly the EUT RF output level.

Example :

The spectrum analyzer offset is derived from RF cable loss and attenuator factor.

Offset = RF cable loss + attenuator factor.

Following shows an offset computation example with cable loss 4.2 dB and 10dB attenuator.

$$\begin{aligned}
 \text{Offset(dB)} &= \text{RF cable loss(dB)} + \text{attenuator factor(dB)}. \\
 &= 4.2 + 10 = 14.2 \text{ (dB)}
 \end{aligned}$$

3 Test Result

3.1 6dB and 26dB and 99% Occupied Bandwidth Measurement

3.1.1 Description of 6dB and 26dB and 99% Occupied Bandwidth

The minimum 6 dB bandwidth shall be at least 500 kHz.

26dB and 99% Occupied bandwidth are reporting only.

3.1.2 Measuring Instruments

The measuring equipment is listed in the section 4 of this test report.

3.1.3 Test Procedures

1. The testing follows FCC KDB 789033 D02 General UNII Test Procedures New Rules v01r03.
Section C) Emission bandwidth for the band 5.725-5.85GHz
2. Set RBW = 100kHz.
3. Set the VBW $\geq 3 \times$ RBW.
4. Detector = Peak.
5. Trace mode = max hold
6. Measure the maximum width of the emission that is 6 dB down from the peak of the emission.
7. Measure and record the results in the test report.

3.1.4 Test Setup





3.1.5 Test Result of 6dB Bandwidth

Please refer to Appendix A.

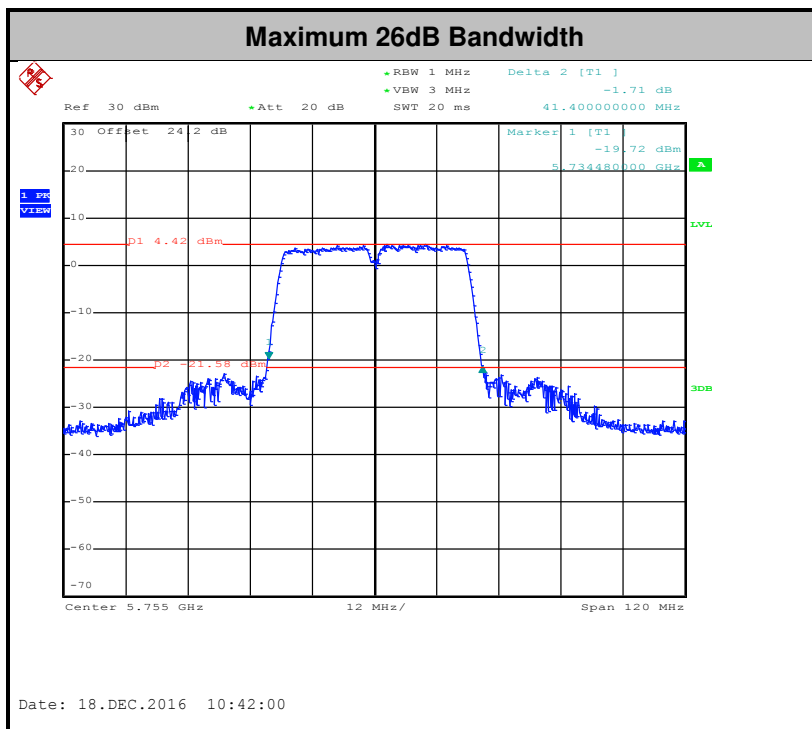
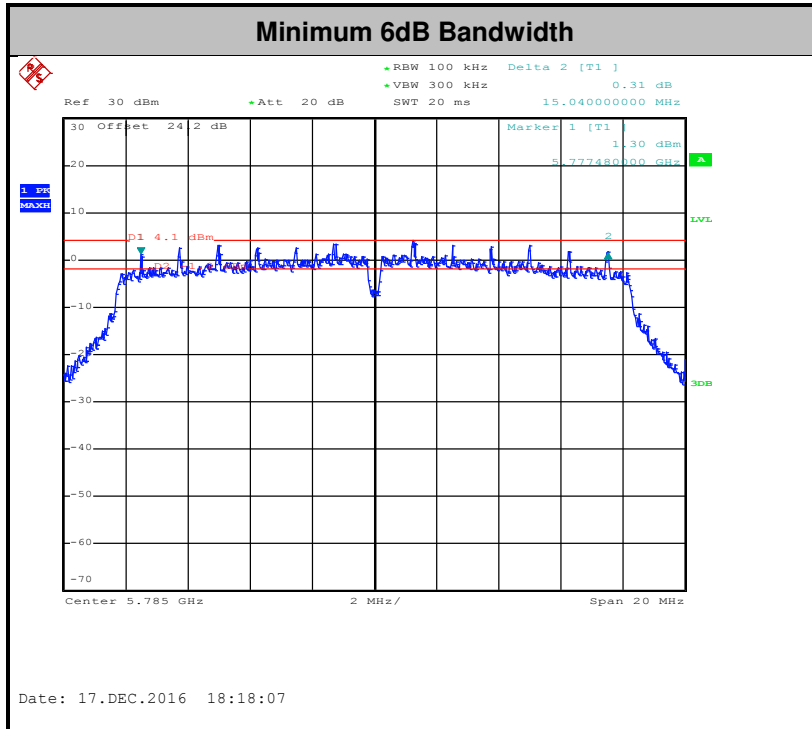

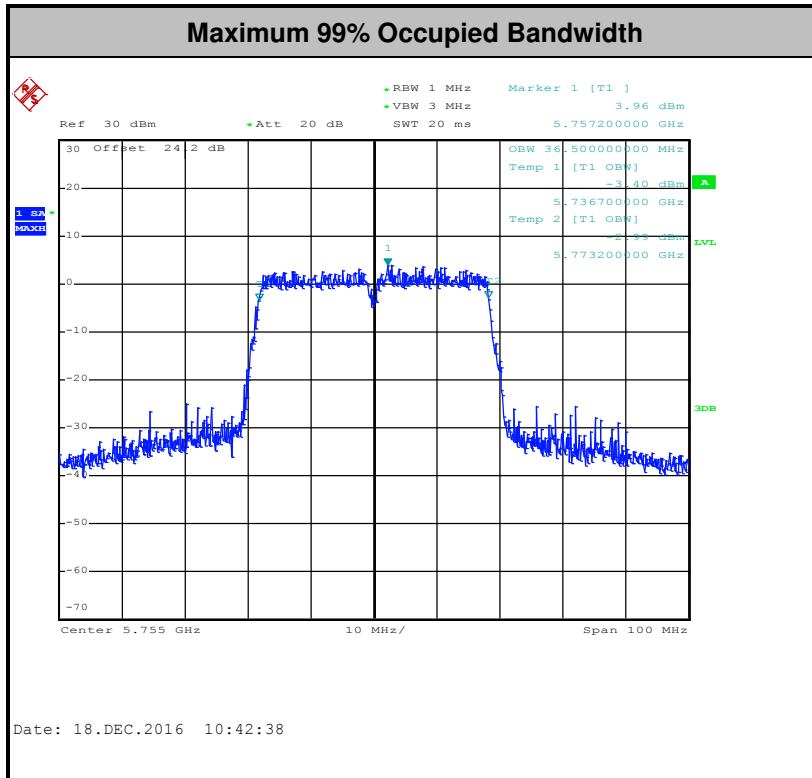

Note: The occupied channel bandwidth is maintained within the band of operation for all of the modulations.

3.2 Maximum Conducted Output Power Measurement

3.2.1 Limit of Maximum Conducted Output Power

For the band 5.725–5.85 GHz, the maximum conducted output power over the frequency band of operation shall not exceed 1 W.

If transmitting antennas of directional gain greater than 6 dBi are used, the peak output power shall be reduced by the amount in dB that the directional gain of the antenna exceeds 6 dBi.

3.2.2 Measuring Instruments

The measuring equipment is listed in the section 4 of this test report.

3.2.3 Test Procedures

The testing follows Method PM of FCC KDB 789033 D02 General UNII Test Procedures New Rules v01r03.

Method PM (Measurement using an RF average power meter):

1. Measurement is performed using a wideband RF power meter.
2. The EUT is configured to transmit continuously with a consistent duty cycle at its maximum power control level.
3. Measure the average power of the transmitter, and the average power is corrected with duty factor, $10 \log(1/x)$, where x is the duty cycle.

3.2.4 Test Setup

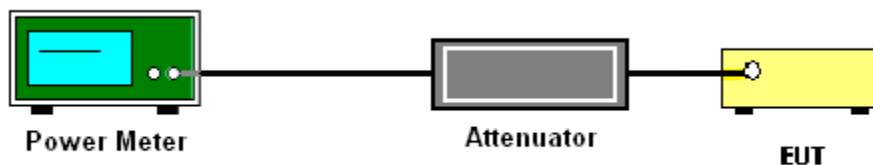

3.2.5 Test Result of Maximum Conducted Output Power

Please refer to Appendix A.



3.3 Power Spectral Density Measurement

3.3.1 Limit of Power Spectral Density

For the band 5.725–5.85 GHz, the maximum power spectral density shall not exceed 30 dBm in any 500-kHz band.

If transmitting antennas of directional gain greater than 6 dBi are used, the peak output power shall be reduced by the amount in dB that the directional gain of the antenna exceeds 6 dBi.

3.3.2 Measuring Instruments

The measuring equipment is listed in the section 4 of this test report.

3.3.3 Test Procedures

The testing follows FCC KDB 789033 D02 General UNII Test Procedures New Rules v01r03. Section F) Maximum power spectral density.

Method SA-2

(trace averaging across on and off times of the EUT transmissions, followed by duty cycle correction).

1. The testing follows Method SA-2 of FCC KDB 789033 D02 General UNII Test Procedures New Rules v01r02.
 - Measure the duty cycle.
 - Set span to encompass the entire emission bandwidth (EBW) of the signal.
 - Set RBW = 300 kHz.
 - Set VBW \geq 1 MHz.
 - Number of points in sweep \geq 2 Span / RBW.
 - Sweep time = auto.
 - Detector = RMS
 - Trace average at least 100 traces in power averaging mode.
 - Add $10 \log(500\text{kHz}/\text{RBW})$ to the test result.
 - Add $10 \log(1/x)$, where x is the duty cycle, to the measured power in order to compute the average power during the actual transmission times. For example, add $10 \log(1/0.25) = 6$ dB if the duty cycle is 25 percent.

2. The RF output of EUT was connected to the spectrum analyzer by a low loss cable.
3. Each plot has already offset with cable loss, and attenuator loss. Measure the PPSD and record it.
4. For MIMO mode, calculation method follows FCC KDB 662911 D01 Multiple Transmitter Output v02r01.

Method (c): Measure and add $10 \log(N_{\text{ANT}})$ dB.

With this technique, spectrum measurements are performed at each output of the device, but rather than summing the spectra or the spectral peaks across the outputs, the quantity $10 \log(N_{\text{ANT}})$ dB is added to each spectrum value before comparing to the emission limit. The addition of $10 \log(N_{\text{ANT}})$ dB serves to apportion the emission limit among the N_{ANT} outputs so that each output is permitted to contribute no more than $1/N_{\text{ANT}}^{\text{th}}$ of the PSD limit.

3.3.4 Test Setup

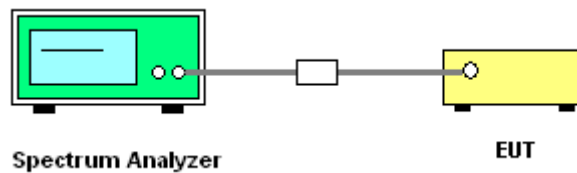



3.3.5 Test Result of Power Spectral Density

Please refer to Appendix A.

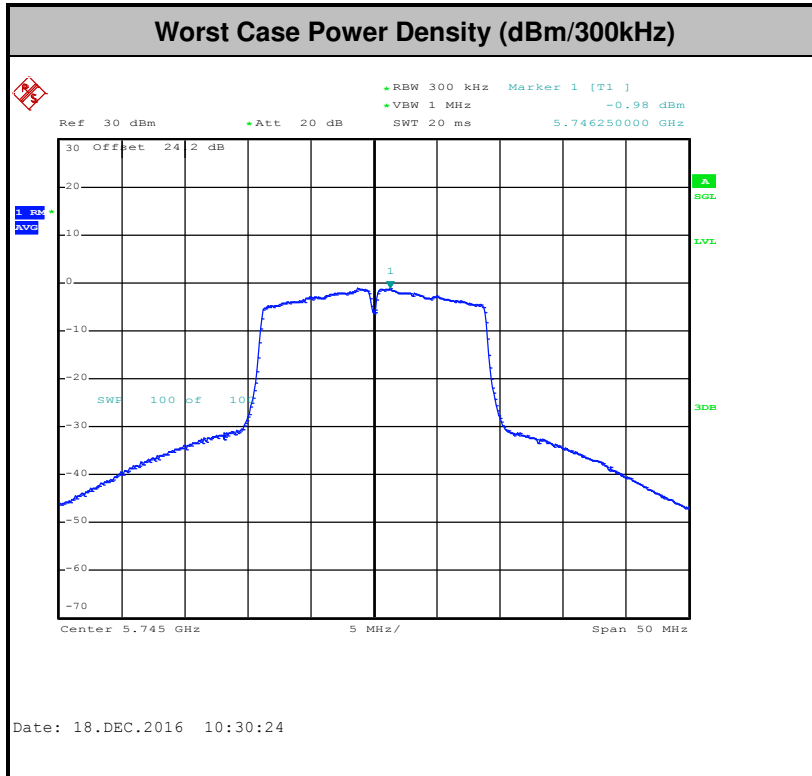



3.4 Unwanted Emissions Measurement

This section as specified in FCC Part 15.407(b) is to measure unwanted emissions through radiated measurement for band edge spurious emissions and out of band emissions measurement. The unwanted emissions shall comply with 15.407(b)(1) to (6), and restricted bands per FCC Part15.205.

3.4.1 Limit of Unwanted Emissions

- (1) For transmitters operating in the 5.725-5.85 GHz band:
 15.407(b)(4)(i) All emissions shall be limited to a level of -27 dBm/MHz at 75 MHz or more above or below the band edge increasing linearly to 10 dBm/MHz at 25 MHz above or below the band edge, and from 25 MHz above or below the band edge increasing linearly to a level of 15.6 dBm/MHz at 5 MHz above or below the band edge, and from 5 MHz above or below the band edge increasing linearly to a level of 27 dBm/MHz at the band edge.
- (2) Unwanted spurious emissions fallen in restricted bands per FCC Part15.205 shall comply with the general field strength limits set forth in § 15.209 as below table,

Frequency (MHz)	Field Strength (microvolts/meter)	Measurement Distance (meters)
0.009 – 0.490	2400/F(kHz)	300
0.490 – 1.705	24000/F(kHz)	30
1.705 – 30.0	30	30
30 – 88	100	3
88 – 216	150	3
216 - 960	200	3
Above 960	500	3

Note: The following formula is used to convert the EIRP to field strength.

$$E = \frac{1000000\sqrt{30P}}{3} \mu\text{V/m, where P is the eirp (Watts)}$$



EIRP (dBm)	Field Strength at 3m (dBµV/m)
-17	78.3
- 27	68.3

(3) KDB789033 D01 v01r03 G)2)c)

- (i) Section 15.407(b)(1-3) specifies the unwanted emissions limit for the U-NII-1 and 2 bands. As specified, emissions above 1000 MHz that are outside of the restricted bands are subject to a peak emission limit of -27 dBm/MHz. However, an out-of-band emission that complies with both the average and peak limits of Section 15.209 is not required to satisfy the -27 dBm/MHz dBm/MHz peak emission limit.
- (ii) Section 15.407(b)(4) specifies the unwanted emissions limit for the U-NII-3 band. A band emissions mask is specified in Section 15.407(b)(4)(i). An alternative to the band emissions mask is specified in Section 15.407(b)(4)(ii). The alternative limits are based on the highest antenna gain specified in the filing. There are also marketing and importation restrictions for the alternative limit

3.4.2 Measuring Instruments

The measuring equipment is listed in the section 4 of this test report.



3.4.3 Test Procedures

1. The testing follows FCC KDB 789033 D02 General UNII Test Procedures New Rules v01r03.
Section G) Unwanted emissions measurement.

(1) Procedure for Unwanted Emissions Measurements Below 1000MHz

- RBW = 120 kHz
- VBW = 300 kHz
- Detector = Peak
- Trace mode = max hold

(2) Procedure for Peak Unwanted Emissions Measurements Above 1000 MHz

- RBW = 1 MHz
- VBW \geq 3 MHz
- Detector = Peak
- Sweep time = auto
- Trace mode = max hold

(3) Procedures for Average Unwanted Emissions Measurements Above 1000MHz

- RBW = 1 MHz
- VBW = 10 Hz, when duty cycle is no less than 98 percent.
- VBW \geq 1/T, when duty cycle is less than 98 percent where T is the minimum transmission duration over which the transmitter is on and is transmitting at its maximum power control level for the tested mode of operation.

2. The EUT was placed on a turntable with 0.8 meter for frequency below 1GHz and 1.5 meter for frequency above 1GHz respectively above ground.
3. The EUT was set 3 meters from the interference receiving antenna which was mounted on the top of a variable height antenna tower.
4. The antenna is a broadband antenna and its height is adjusted between one meter and four meters above ground to find the maximum value of the field strength for both horizontal polarization and vertical polarization of the antenna.
5. For each suspected emission, the EUT was arranged to its worst case and then adjust the antenna tower (from 1 m to 4 m) and turntable (from 0 degree to 360 degrees) to find the maximum reading.
6. For testing below 1GHz, if the emission level of the EUT in peak mode was 3 dB lower than the limit specified, then peak values of EUT will be reported, otherwise, the emissions will be repeated one by one using the CISPR quasi-peak method and reported.
7. For testing above 1GHz, the emission level of the EUT in peak mode was 20dB lower than average limit (that means the emission level in average mode also complies with the limit in average mode), then peak values of EUT will be reported, otherwise, the emissions will be measured in average mode again and reported.

3.4.4 Test Setup

For radiated emissions below 30MHz

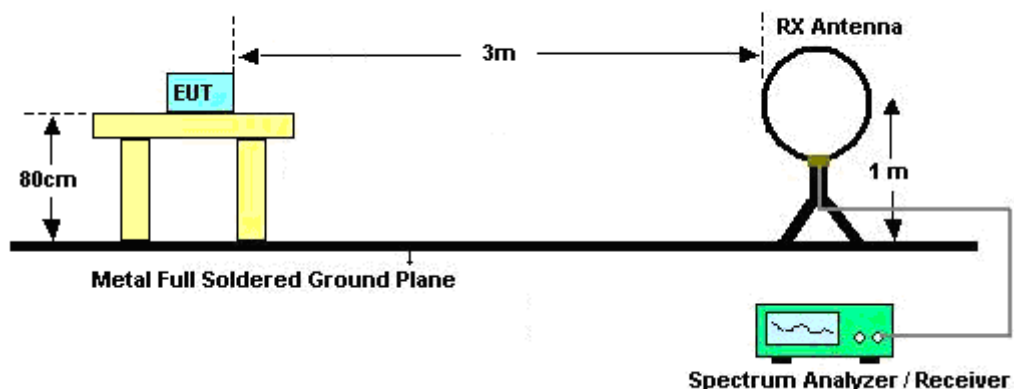

For radiated emissions from 30MHz to 1GHz

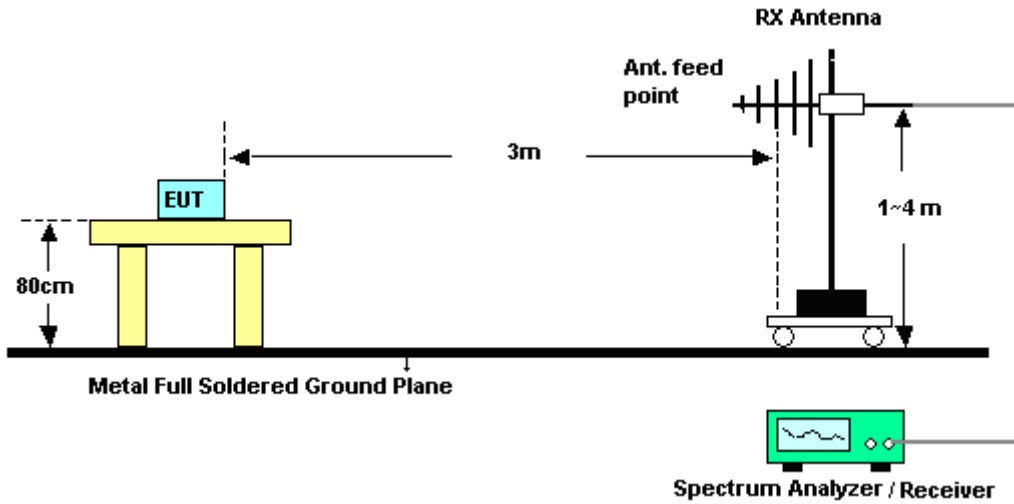

For radiated emissions above 1GHz

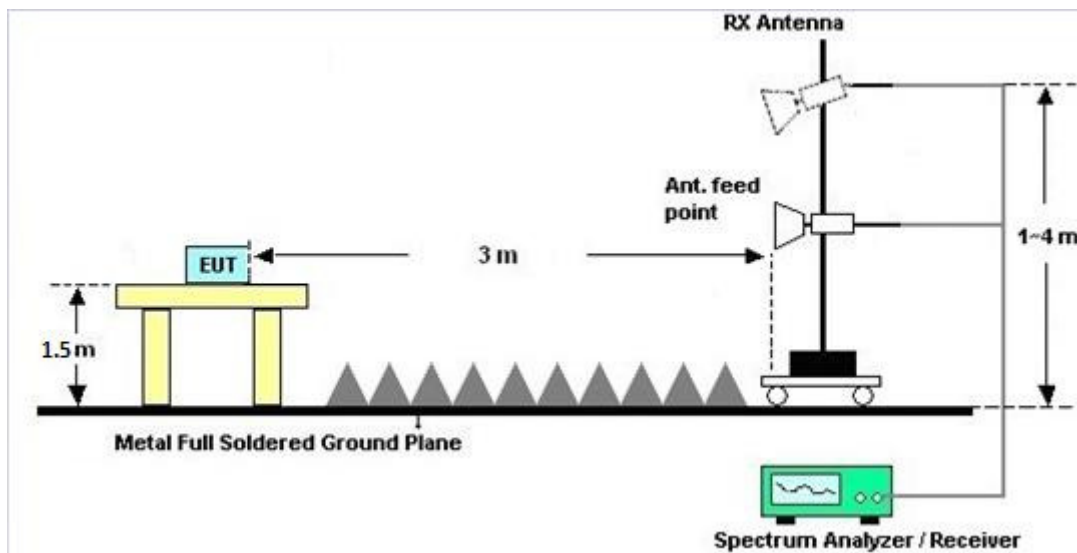



3.4.5 Test Results of Radiated Spurious Emissions (9 kHz ~ 30 MHz)

The low frequency, which started from 9 kHz to 30MHz, was pre-scanned and the result which was 20dB lower than the limit line per 15.31(o) was not reported.

3.4.6 Test Result of Radiated Spurious at Band Edges

Please refer to Appendix B and C.

3.4.7 Duty Cycle

Please refer to Appendix D.

3.4.8 Test Result of Radiated Spurious Emissions (30MHz ~ 10th Harmonic)

Please refer to Appendix B and C.



3.5 AC Conducted Emission Measurement

3.5.1 Limit of AC Conducted Emission

For equipment that is designed to be connected to the public utility (AC) power line, the radio frequency voltage that is conducted back onto the AC power line on any frequency or frequencies within the band 150 kHz to 30 MHz shall not exceed the limits in the following table.

Frequency of emission (MHz)	Conducted limit (dB μ V)	
	Quasi-peak	Average
0.15-0.5	66 to 56*	56 to 46*
0.5-5	56	46
5-30	60	50

*Decreases with the logarithm of the frequency.

3.5.2 Measuring Instruments

The measuring equipment is listed in the section 4 of this test report.

3.5.3 Test Procedures

1. The EUT was placed 0.4 meter from the conducting wall of the shielding room was kept at least 80 centimeters from any other grounded conducting surface.
2. Connect EUT to the power mains through a line impedance stabilization network (LISN).
3. All the support units are connecting to the other LISN.
4. The LISN provides 50 ohm coupling impedance for the measuring instrument.
5. The FCC states that a 50 ohm, 50 microhenry LISN should be used.
6. Both sides of AC line were checked for maximum conducted interference.
7. The frequency range from 150 kHz to 30 MHz was searched.
8. Set the test-receiver system to Peak Detect Function and specified bandwidth with Maximum Hold Mode.

3.5.4 Test Setup

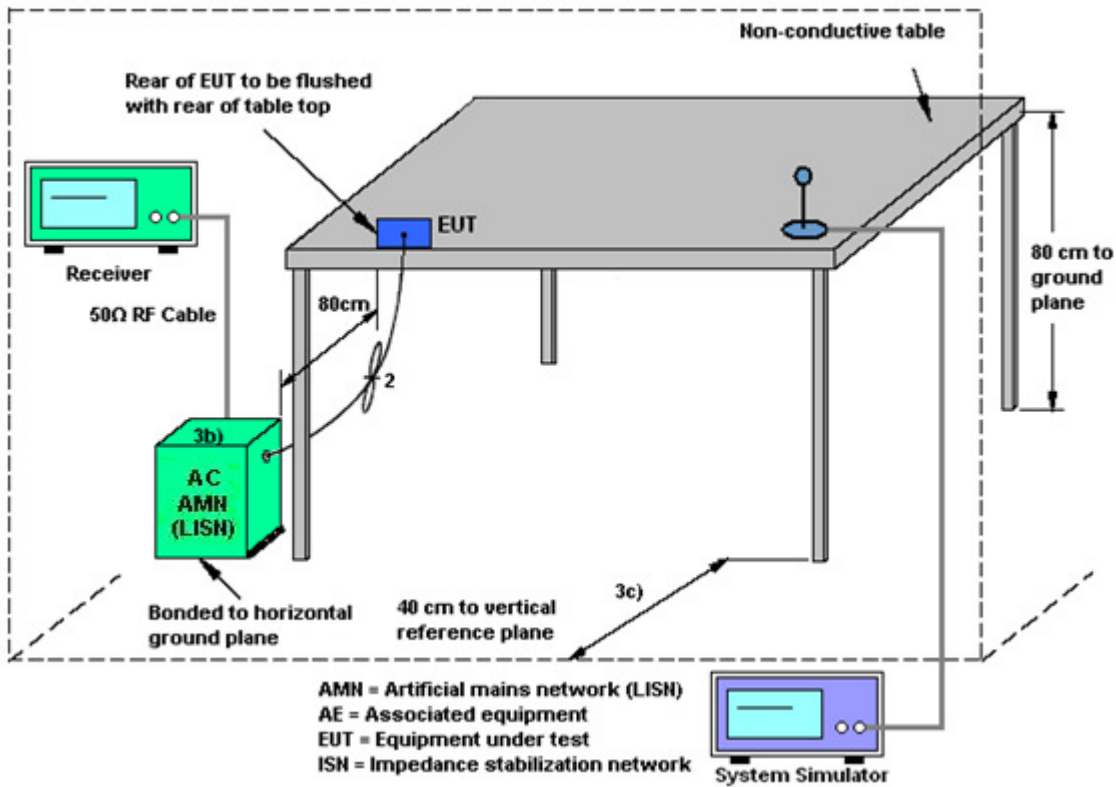



3.5.5 Test Result of AC Conducted Emission

Test Mode :	Mode 1	Temperature :	21~23°C
Test Engineer :	Arthur Hsieh	Relative Humidity :	50~52%
Test Voltage :	120Vac / 60Hz	Phase :	Line
Function Type :	GSM1900 Idle + Bluetooth Link + WLAN (5GHz) Link + Camera (Rear) + Earphone 1 + Battery + USB Cable (Charging from Adapter 3)		

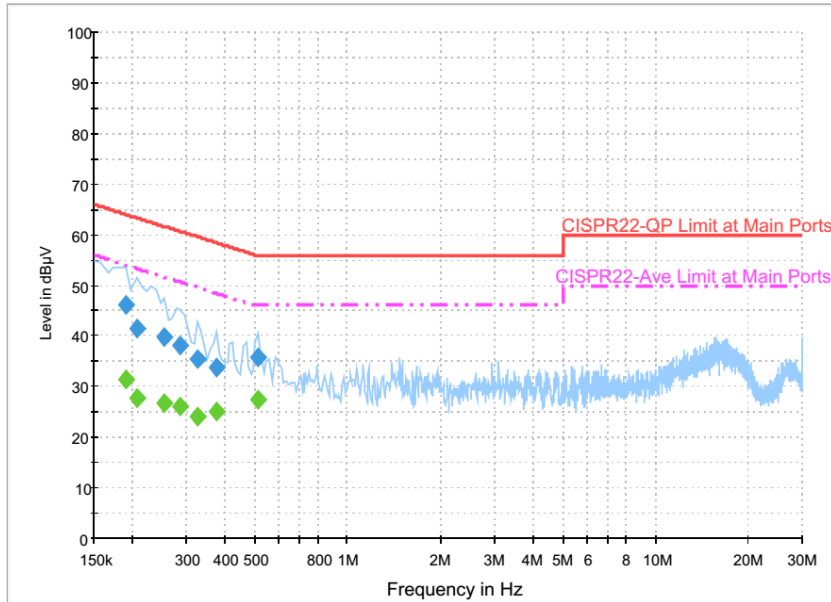

Final Result : QuasiPeak

Frequency (MHz)	QuasiPeak (dBµV)	Filter	Line	Corr. (dB)	Margin (dB)	Limit (dBµV)
0.190000	46.3	Off	L1	19.6	17.7	64.0
0.206000	41.4	Off	L1	19.6	22.0	63.4
0.254000	39.9	Off	L1	19.6	21.7	61.6
0.286000	38.2	Off	L1	19.6	22.4	60.6
0.326000	35.4	Off	L1	19.6	24.2	59.6
0.374000	33.7	Off	L1	19.6	24.7	58.4
0.510000	35.7	Off	L1	19.6	20.3	56.0

Final Result : Average

Frequency (MHz)	Average (dBµV)	Filter	Line	Corr. (dB)	Margin (dB)	Limit (dBµV)
0.190000	31.5	Off	L1	19.6	22.5	54.0
0.206000	27.6	Off	L1	19.6	25.8	53.4
0.254000	26.6	Off	L1	19.6	25.0	51.6
0.286000	25.9	Off	L1	19.6	24.7	50.6
0.326000	24.0	Off	L1	19.6	25.6	49.6
0.374000	25.2	Off	L1	19.6	23.2	48.4
0.510000	27.4	Off	L1	19.6	18.6	46.0



Test Mode :	Mode 1	Temperature :	21~23°C
Test Engineer :	Arthur Hsieh	Relative Humidity :	50~52%
Test Voltage :	120Vac / 60Hz	Phase :	Neutral
Function Type :	GSM1900 Idle + Bluetooth Link + WLAN (5GHz) Link + Camera (Rear) + Earphone 1 + Battery + USB Cable (Charging from Adapter 3)		

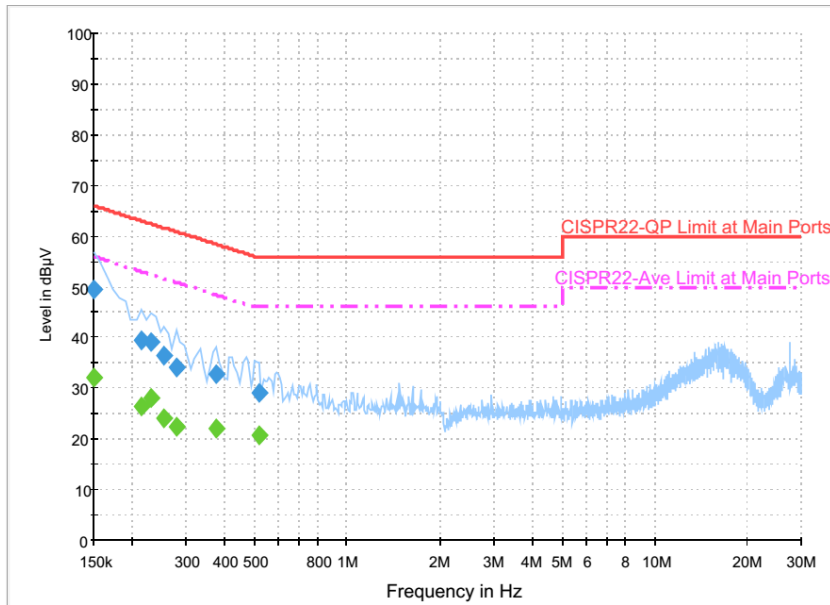

Final Result : QuasiPeak

Frequency (MHz)	QuasiPeak (dBµV)	Filter	Line	Corr. (dB)	Margin (dB)	Limit (dBµV)
0.150000	49.5	Off	N	19.6	16.5	66.0
0.214000	39.6	Off	N	19.6	23.4	63.0
0.230000	39.1	Off	N	19.6	23.3	62.4
0.254000	36.4	Off	N	19.6	25.2	61.6
0.278000	34.0	Off	N	19.6	26.9	60.9
0.374000	32.9	Off	N	19.6	25.5	58.4
0.518000	28.9	Off	N	19.6	27.1	56.0

Final Result : Average

Frequency (MHz)	Average (dBµV)	Filter	Line	Corr. (dB)	Margin (dB)	Limit (dBµV)
0.150000	32.0	Off	N	19.6	24.0	56.0
0.214000	26.5	Off	N	19.6	26.5	53.0
0.230000	28.2	Off	N	19.6	24.2	52.4
0.254000	24.0	Off	N	19.6	27.6	51.6
0.278000	22.4	Off	N	19.6	28.5	50.9
0.374000	22.2	Off	N	19.6	26.2	48.4
0.518000	20.7	Off	N	19.6	25.3	46.0

3.6 Frequency Stability Measurement

3.6.1 Limit of Frequency Stability

Manufacturers of U-NII devices are responsible for ensuring frequency stability such that an emission is maintained within the band of operation under all conditions of normal operation as specified in the user's manual.

3.6.2 Measuring Instruments

The measuring equipment is listed in the section 4 of this test report.

3.6.3 Test Procedures

1. To ensure emission at the band edge is maintained within the authorized band, those values shall be measured by radiation emissions at upper and lower frequency points, and finally compensated by frequency deviation as procedures below.
2. The EUT was operated at the maximum output power, and connected to the spectrum analyzer, which is set to maximum hold function and peak detector. The peak value of the power envelope was measured and noted. The upper and lower frequency points were respectively measured relatively 10dB lower than the measured peak value.
3. The frequency deviation was calculated by adding the upper frequency point and the lower frequency point divided by two. Those detailed values of frequency deviation are provided in table below.

3.6.4 Test Setup



3.6.5 Test Result of Frequency Stability

Please refer to Appendix A.



3.7 Automatically Discontinue Transmission

3.7.1 Limit of Automatically Discontinue Transmission

The device shall automatically discontinue transmission in case of either absence of information to transmit or operational failure. These provisions are not intended to preclude the transmission of control or signaling information or the use of repetitive codes used by certain digital technologies to complete frame or burst intervals. Applicants shall include in their application for equipment authorization to describe how this requirement is met.

3.7.2 Measuring Instruments

The measuring equipment is listed in the section 4 of this test report.

3.7.3 Test Result of Automatically Discontinue Transmission

While the EUT is not transmitting any information, the EUT can automatically discontinue transmission and become standby mode for power saving. The EUT can detect the controlling signal of ACK message transmitting from remote device and verify whether it shall resend or discontinue transmission.



3.8 Antenna Requirements

3.8.1 Standard Applicable

According to FCC 47 CFR Section 15.407(a)(1)(2), if transmitting antenna directional gain is greater than 6 dBi, both the peak transmit power and the peak power spectral density shall be reduced by the amount in dB that the directional gain of the antenna exceeds 6 dBi.

3.8.2 Antenna Anti-Replacement Construction

An embedded-in antenna design is used.

3.8.3 Antenna Gain

The antenna gain is less than 6 dBi. Therefore, it is not necessary to reduce maximum peak output power limit.



4 List of Measuring Equipment

Instrument	Manufacturer	Model No.	Serial No.	Characteristics	Calibration Date	Test Date	Due Date	Remark
Spectrum Analyzer	Rohde & Schwarz	FSP40	100055	9kHz-40GHz	Jul. 17, 2016	Dec. 02, 2016 ~ Dec. 27, 2016	Jul. 16, 2017	Conducted (TH05-HY)
Power Meter	Anritsu	ML2495A	0932001	300MHz~40GHz	Sep. 29, 2016	Dec. 02, 2016 ~ Dec. 27, 2016	Sep. 28, 2017	Conducted (TH05-HY)
Power Sensor	Anritsu	MA2411B	0846202	300MHz~40GHz	Sep. 29, 2016	Dec. 02, 2016 ~ Dec. 27, 2016	Sep. 28, 2017	Conducted (TH05-HY)
Hygrometer	Testo	608-H2	41410069	N/A	Aug. 28, 2016	Dec. 02, 2016 ~ Dec. 27, 2016	Aug. 27, 2017	Conducted (TH05-HY)
RF Cable	HUBER + SUHNER	SUCOFLEX 104	MY84209521	1GHz~26GHz	Dec. 03, 2015	Dec. 02, 2016 ~ Dec. 27, 2016	Dec. 02, 2016	Conducted (TH05-HY)
Temperature Chamber	ESPEC	SH-641	92013720	-40℃ ~90℃	Sep. 01, 2016	Dec. 02, 2016 ~ Dec. 27, 2016	Aug. 31, 2017	Conducted (TH05-HY)
AC Power Source	ChainTek	APC-1000W	N/A	N/A	N/A	Dec. 06, 2016	N/A	Conduction (CO05-HY)
EMI Test Receiver	Rohde & Schwarz	ESCI 7	100724	9kHz~7GHz	Aug. 30, 2016	Dec. 06, 2016	Aug. 29, 2017	Conduction (CO05-HY)
Hygrometer	Testo	608-H1	34913912	N/A	Apr. 19, 2016	Dec. 06, 2016	Apr. 18, 2017	Conduction (CO05-HY)
LISN	Rohde & Schwarz	ENV216	100080	9kHz~30MHz	Nov. 28, 2016	Dec. 06, 2016	Nov. 27, 2017	Conduction (CO05-HY)
LF Cable	HUBER + SUHNER	RG-214/U	LF01	N/A	Jan. 06, 2016	Dec. 06, 2016	Jan. 05, 2017	Conduction (CO05-HY)
Test Software	N/A	EMC32	8.40.0	N/A	N/A	Dec. 06, 2016	N/A	Conduction (CO05-HY)
Loop Antenna	Rohde & Schwarz	HFH2-Z2	100315	9 kHz~30 MHz	Sep. 02, 2015	Dec. 13, 2016 ~ Jan. 25, 2017	Sep. 01, 2017	Radiation (03CH11-HY)
Bilog Antenna	TESEQ	CBL 6111D	35414	30MHz~1GHz	Oct. 15, 2016	Dec. 13, 2016 ~ Jan. 25, 2017	Oct. 14, 2017	Radiation (03CH11-HY)
Horn Antenna	SCHWARZBECK	BBHA 9120 D	9120D-1522	1GHz ~ 18GHz	Mar. 30, 2016	Dec. 13, 2016 ~ Jan. 25, 2017	Mar. 31, 2017	Radiation (03CH11-HY)
SHF-EHF Horn Antenna	SCHWARZBECK	BBHA 9170	BBHA9170584	18GHz- 40GHz	Nov. 08, 2016	Dec. 13, 2016 ~ Jan. 25, 2017	Nov. 07, 2017	Radiation (03CH11-HY)
Spectrum Analyzer	Keysight	N9010A	MY52350276	10Hz ~ 44GHZ	Mar. 21, 2016	Dec. 13, 2016 ~ Jan. 25, 2017	Mar. 20, 2017	Radiation (03CH11-HY)
Amplifier	SONOMA	310N	187312	9kHz~1GHz	Nov. 10, 2016	Dec. 13, 2016 ~ Jan. 25, 2017	Nov. 09, 2017	Radiation (03CH11-HY)
Preamplifier	Keysight	83017A	MY53270080	1GHz~26.5GHz	Nov. 10, 2016	Dec. 13, 2016 ~ Jan. 25, 2017	Nov. 09, 2017	Radiation (03CH11-HY)
Preamplifier	MITEQ	TTA0204	1872107	2GHz~40GHz	Feb. 15, 2016	Dec. 13, 2016 ~ Jan. 25, 2017	Feb. 14, 2017	Radiation (03CH11-HY)



Instrument	Manufacturer	Model No.	Serial No.	Characteristics	Calibration Date	Test Date	Due Date	Remark
Hygrometer	TECPEL	DTN-303B	TP140325	N/A	Nov. 11, 2016	Dec. 13, 2016 ~ Jan. 25, 2017	Nov. 13, 2017	Radiation (03CH11-HY)
RF Cable	HUBER + SUHNER	SUCOFLEX 104	MY9837/4 MY28419/4M Y28654/4	9KHz~40GHz	Sep. 12, 2016	Dec. 13, 2016 ~ Jan. 25, 2017	Sep. 11, 2017	Radiation (03CH11-HY)
Controller	EMEC	EM 1000	N/A	Control Turn table & Ant Mast	N/A	Dec. 13, 2016 ~ Jan. 25, 2017	N/A	Radiation (03CH11-HY)
Antenna Mast	EMEC	AM-BS-4500-B	N/A	1~4m	N/A	Dec. 13, 2016 ~ Jan. 25, 2017	N/A	Radiation (03CH11-HY)
Turn Table	EMEC	TT 2000	N/A	0~360 Degree	N/A	Dec. 13, 2016 ~ Jan. 25, 2017	N/A	Radiation (03CH11-HY)
Test Software	Audix	E3	6.2009-8-24	N/A	N/A	Dec. 13, 2016 ~ Jan. 25, 2017	N/A	Radiation (03CH11-HY)
Filter	Wainwright	WLKX12-2700 -3000-18000-6 0SS	SN3	2.7G High Pass	Sep. 19, 2016	Dec. 13, 2016 ~ Jan. 25, 2017	Sep. 18, 2017	Radiation (03CH11-HY)
Filter	Wainwright	WLK10-4630-5 093-11000-40 SS	SN1	4.5G High Pass	Sep. 19, 2016	Dec. 13, 2016 ~ Jan. 25, 2017	Sep. 18, 2017	Radiation (03CH11-HY)



5 Uncertainty of Evaluation

Uncertainty of Conducted Emission Measurement (150kHz ~ 30MHz)

Measuring Uncertainty for a Level of Confidence of 95% ($U = 2Uc(y)$)	2.70
---	------

Uncertainty of Radiated Emission Measurement (30 MHz ~ 1000 MHz)

Measuring Uncertainty for a Level of Confidence of 95% ($U = 2Uc(y)$)	5.20
---	------

Uncertainty of Radiated Emission Measurement (1000 MHz ~ 18000 MHz)

Measuring Uncertainty for a Level of Confidence of 95% ($U = 2Uc(y)$)	5.50
---	------

Uncertainty of Radiated Emission Measurement (18000 MHz ~ 40000 MHz)

Measuring Uncertainty for a Level of Confidence of 95% ($U = 2Uc(y)$)	5.20
---	------

Appendix A. Conducted Test Results

Test Engineer:	Derek Hsu	Temperature:	21~25	°C
Test Date:	2016/12/2~2016/12/27	Relative Humidity:	51~54	%

TEST RESULTS DATA
6dB and 26dB EBW and 99% OBW

Band IV									
Mod.	Data Rate	NTX	CH.	Freq. (MHz)	99% Bandwidth (MHz)	26 dB Bandwidth (MHz)	6 dB Bandwidth (MHz)	6dB Bandwidth min. Limit (MHz)	Pass/Fail
11a	6M bps	1	149	5745	17.3	27.165	15.32	0.5	Pass
11a	6Mbps	1	157	5785	17.45	26.04	15.04	0.5	Pass
11a	6Mbps	1	165	5825	17.3	27.03	15.54	0.5	Pass
HT20	MCS 0	1	149	5745	18.3	33.74	15.32	0.5	Pass
HT20	MCS 0	1	157	5785	18.2	30.71	15.06	0.5	Pass
HT20	MCS 0	1	165	5825	18.25	30.135	15.12	0.5	Pass
HT40	MCS 0	1	151	5755	36.5	41.4	36.04	0.5	Pass
HT40	MCS 0	1	159	5795	36.5	40.89	36.08	0.5	Pass

TEST RESULTS DATA
Average Power Table

Band IV										
Mod.	Data Rate	NTX	CH.	Freq. (MHz)	Duty Factor (dB)	Average Conducted Power (dBm)	FCC Conducted Power Limit (dBm)	DG (dBi)		Pass/Fail
11a	6M bps	1	149	5745	0.10	14.97	30.00	-0.40		Pass
11a	6Mbps	1	157	5785	0.10	14.95	30.00	-0.40		Pass
11a	6Mbps	1	165	5825	0.10	14.93	30.00	-0.40		Pass
HT20	MCS 0	1	149	5745	0.13	14.98	30.00	-0.40		Pass
HT20	MCS 0	1	157	5785	0.13	14.95	30.00	-0.40		Pass
HT20	MCS 0	1	165	5825	0.13	14.48	30.00	-0.40		Pass
HT40	MCS 0	1	151	5755	0.25	10.91	30.00	-0.40		Pass
HT40	MCS 0	1	159	5795	0.25	10.90	30.00	-0.40		Pass

TEST RESULTS DATA
Power Spectral Density

Band IV										
Mod.	Data Rate	NTX	CH.	Freq. (MHz)	Duty Factor (dB)	10log (500kHz /RBW) Factor (dB)	Average Power Density (dBm/500kHz)	Average PSD Limit (dBm/500kHz)	DG (dBi)	Pass/Fail
11a	6M bps	1	149	5745	0.10	2.22	1.05	30.00	-0.40	Pass
11a	6Mbps	1	157	5785	0.10	2.22	1.28	30.00	-0.40	Pass
11a	6Mbps	1	165	5825	0.10	2.22	1.02	30.00	-0.40	Pass
HT20	MCS 0	1	149	5745	0.13	2.22	1.37	30.00	-0.40	Pass
HT20	MCS 0	1	157	5785	0.13	2.22	0.98	30.00	-0.40	Pass
HT20	MCS 0	1	165	5825	0.13	2.22	0.19	30.00	-0.40	Pass
HT40	MCS 0	1	151	5755	0.25	2.22	-6.84	30.00	-0.40	Pass
HT40	MCS 0	1	159	5795	0.25	2.22	-7.02	30.00	-0.40	Pass

TEST RESULTS DATA
Frequency Stability

Band IV										
Mod.	Data Rate	NTX	CH.	Freq. (MHz)	Center Frequency (MHz)	Frequency Deviation (MHz)	Frequency Stability (ppm)	Temperature (°C)	Voltage (V)	Note
11a	6M bps	1	149	5745	5745.050	0.050	8.70	50	3.8	
11a	6M bps	1	149	5745	5745.000	0.000	0.00	-30	3.8	
11a	6M bps	1	149	5745	5745.000	0.000	0.00	20	4.35	
11a	6M bps	1	149	5745	5745.000	0.000	0.00	20	3.4	
11a	6M bps	1	149	5745	5745.000	0.000	0.00	20	3.8	



Appendix B. Radiated Spurious Emission

Test Engineer :	J.C. Liang, Nick Yu, and Ken Wu	Temperature :	20~23°C
		Relative Humidity :	58~63%

Band 4 - 5725~5850MHz

WIFI 802.11a (Band Edge @ 3m)

WIFI Ant. 1	Note	Frequency (MHz)	Level (dBμV/m)	Over Limit (dB)	Limit Line (dBμV/m)	Read Level (dBμV)	Antenna Factor (dB/m)	Cable Loss (dB)	Preamp Factor (dB)	Ant Pos (cm)	Table Pos (deg)	Peak Avg. (P/A)	Pol. (H/V)	
802.11a CH 149 5745MHz		5623.8	51.45	-16.75	68.2	40.19	32.87	11.47	33.08	272	337	P	H	
		5684	53.7	-39.7	93.4	42.38	32.97	11.47	33.12	272	337	P	H	
		5719.4	54.69	-55.94	110.63	43.35	33.01	11.46	33.13	272	337	P	H	
		5725	67.59	-54.61	122.2	56.25	33.01	11.46	33.13	272	337	P	H	
	*	5745	106.99	-	-	95.64	33.04	11.46	33.15	272	337	P	H	
	*	5745	99	-	-	87.65	33.04	11.46	33.15	272	337	A	H	
														H
														H
			5610.4	50.54	-17.66	68.2	39.3	32.84	11.48	33.08	162	171	P	V
			5684.8	52.38	-41.61	93.99	41.06	32.97	11.47	33.12	162	171	P	V
			5719.8	54.33	-56.41	110.74	42.99	33.01	11.46	33.13	162	171	P	V
			5725	67.05	-55.15	122.2	55.71	33.01	11.46	33.13	162	171	P	V
	*		5745	104.12	-	-	92.77	33.04	11.46	33.15	162	171	P	V
	*		5745	96.16	-	-	84.81	33.04	11.46	33.15	162	171	A	V
														V
													V	



WIFI Ant. 1	Note	Frequency (MHz)	Level (dBμV/m)	Over Limit (dB)	Limit Line (dBμV/m)	Read Level (dBμV)	Antenna Factor (dB/m)	Cable Loss (dB)	Preamp Factor (dB)	Ant Pos (cm)	Table Pos (deg)	Peak Avg. (P/A)	Pol. (H/V)
		5641.4	51.82	-16.38	68.2	40.56	32.89	11.47	33.1	282	330	P	H
		5694	51.06	-49.72	100.78	39.74	32.97	11.47	33.12	282	330	P	H
		5713.2	51.79	-57.11	108.9	40.47	32.99	11.46	33.13	282	330	P	H
		5723.4	51.63	-66.92	118.55	40.29	33.01	11.46	33.13	282	330	P	H
	*	5785	106.47	-	-	95.1	33.09	11.45	33.17	282	330	P	H
	*	5785	98.64	-	-	87.27	33.09	11.45	33.17	282	330	A	H
		5852.2	52.56	-64.62	117.18	41.04	33.18	11.53	33.19	282	330	P	H
		5868	53.44	-53.72	107.16	41.84	33.21	11.6	33.21	282	330	P	H
		5880.8	52.32	-48.57	100.89	40.7	33.23	11.6	33.21	282	330	P	H
		5929.8	51.38	-16.82	68.2	39.64	33.3	11.67	33.23	282	330	P	H
													H
													H
802.11a													
CH 157													
5785MHz		5645	50.66	-17.54	68.2	39.4	32.89	11.47	33.1	167	168	P	V
		5690.2	51.27	-46.7	97.97	39.95	32.97	11.47	33.12	167	168	P	V
		5705.4	51.8	-54.91	106.71	40.48	32.99	11.46	33.13	167	168	P	V
		5724.8	50.72	-71.02	121.74	39.38	33.01	11.46	33.13	167	168	P	V
	*	5785	102.77	-	-	91.4	33.09	11.45	33.17	167	168	P	V
	*	5785	95.85	-	-	84.48	33.09	11.45	33.17	167	168	A	V
		5850.4	52.45	-68.84	121.29	40.93	33.18	11.53	33.19	167	168	P	V
		5865.4	52.44	-55.45	107.89	40.84	33.21	11.6	33.21	167	168	P	V
		5907.6	51.6	-29.44	81.04	39.87	33.28	11.67	33.22	167	168	P	V
		5942.6	50.52	-17.68	68.2	38.69	33.33	11.74	33.24	167	168	P	V
													V
													V



WiFi Ant. 1	Note	Frequency (MHz)	Level (dBμV/m)	Over Limit (dB)	Limit Line (dBμV/m)	Read Level (dBμV)	Antenna Factor (dB/m)	Cable Loss (dB)	Preamp Factor (dB)	Ant Pos (cm)	Table Pos (deg)	Peak Avg. (P/A)	Pol. (H/V)	
802.11a CH 165 5825MHz	*	5825	107.6	-	-	96.09	33.16	11.53	33.18	276	336	P	H	
	*	5825	100.44	-	-	88.93	33.16	11.53	33.18	276	336	A	H	
		5851.2	54.94	-64.52	119.46	43.42	33.18	11.53	33.19	276	336	P	H	
		5868	54.2	-52.96	107.16	42.6	33.21	11.6	33.21	276	336	P	H	
		5876.8	53.48	-50.38	103.86	41.86	33.23	11.6	33.21	276	336	P	H	
		5935.2	52.04	-16.16	68.2	40.31	33.3	11.67	33.24	276	336	P	H	
														H
														H
	*	5825	105.43	-	-	93.92	33.16	11.53	33.18	176	163	P	V	
	*	5825	98.49	-	-	86.98	33.16	11.53	33.18	176	163	A	V	
		5854.8	53.31	-57.95	111.26	41.76	33.21	11.53	33.19	176	163	P	V	
		5859.4	53.32	-56.25	109.57	41.79	33.21	11.53	33.21	176	163	P	V	
		5894.8	52.43	-38.08	90.51	40.79	33.26	11.6	33.22	176	163	P	V	
		5935.6	51.64	-16.56	68.2	39.91	33.3	11.67	33.24	176	163	P	V	
														V
														V
														V
	Remark	1. No other spurious found. 2. All results are PASS against Peak and Average limit line.												



Band 4 5725~5850MHz

WIFI 802.11a (Harmonic @ 3m)

WIFI Ant. 1	Note	Frequency (MHz)	Level (dBμV/m)	Over Limit (dB)	Limit Line (dBμV/m)	Read Level (dBμV)	Antenna Factor (dB/m)	Cable Loss (dB)	Preamp Factor (dB)	Ant Pos (cm)	Table Pos (deg)	Peak Avg. (P/A)	Pol. (H/V)	
802.11a CH 149 5745MHz		11490	40.58	-33.42	74	36.85	39.12	15.85	51.24	100	0	P	H	
		17235	49.88	-18.32	68.2	38.46	42.84	20.57	51.99	100	0	P	H	
													H	
													H	
			11490	40.22	-33.78	74	36.49	39.12	15.85	51.24	100	0	P	V
			17235	50.56	-17.64	68.2	39.14	42.84	20.57	51.99	100	0	P	V
														V
802.11a CH 157 5785MHz		11570	41.79	-32.21	74	38.07	39.07	15.91	51.26	100	0	P	H	
		17355	50.6	-17.6	68.2	38.57	43.26	20.78	52.01	100	0	P	H	
													H	
													H	
			11570	39.87	-34.13	74	36.15	39.07	15.91	51.26	100	0	P	V
			17355	50.33	-17.87	68.2	38.3	43.26	20.78	52.01	100	0	P	V
														V
802.11a CH 165 5825MHz		11650	40.35	-33.65	74	36.63	39.04	15.97	51.29	100	0	P	H	
		17475	50.32	-17.88	68.2	37.67	43.68	20.99	52.02	100	0	P	H	
													H	
													H	
			11650	39.66	-34.34	74	35.94	39.04	15.97	51.29	100	0	P	V
			17475	50.63	-17.57	68.2	37.98	43.68	20.99	52.02	100	0	P	V
														V
Remark	1. No other spurious found.													
	2. All results are PASS against Peak and Average limit line.													



Band 4 5725~5850MHz

WIFI 802.11n HT20 (Band Edge @ 3m)

WIFI Ant. 1	Note	Frequency (MHz)	Level (dBμV/m)	Over Limit (dB)	Limit Line (dBμV/m)	Read Level (dBμV)	Antenna Factor (dB/m)	Cable Loss (dB)	Preamp Factor (dB)	Ant Pos (cm)	Table Pos (deg)	Peak Avg. (P/A)	Pol. (H/V)	
802.11n HT20 CH 149 5745MHz		5648.2	51.43	-16.77	68.2	40.17	32.89	11.47	33.1	271	336	P	H	
		5691	53.29	-45.27	98.56	41.97	32.97	11.47	33.12	271	336	P	H	
		5719.8	58.59	-52.15	110.74	47.25	33.01	11.46	33.13	271	336	P	H	
		5724.2	71.7	-48.68	120.38	60.36	33.01	11.46	33.13	271	336	P	H	
	*	5745	106.61	-	-	95.26	33.04	11.46	33.15	271	336	P	H	
	*	5745	98.83	-	-	87.48	33.04	11.46	33.15	271	336	A	H	
														H
														H
			5642	50.6	-17.6	68.2	39.34	32.89	11.47	33.1	160	169	P	V
			5654	52.07	-19.1	71.17	40.79	32.92	11.47	33.11	160	169	P	V
			5719.4	57.58	-53.05	110.63	46.24	33.01	11.46	33.13	160	169	P	V
			5722.2	65.07	-50.75	115.82	53.73	33.01	11.46	33.13	160	169	P	V
		*	5745	104.3	-	-	92.95	33.04	11.46	33.15	160	169	P	V
		*	5745	95.86	-	-	84.51	33.04	11.46	33.15	160	169	A	V
													V	
													V	



WIFI Ant. 1	Note	Frequency (MHz)	Level (dBμV/m)	Over Limit (dB)	Limit Line (dBμV/m)	Read Level (dBμV)	Antenna Factor (dB/m)	Cable Loss (dB)	Preamp Factor (dB)	Ant Pos (cm)	Table Pos (deg)	Peak Avg. (P/A)	Pol. (H/V)
		5613.4	50.67	-17.53	68.2	39.43	32.84	11.48	33.08	281	330	P	H
		5690	51.76	-46.07	97.83	40.44	32.97	11.47	33.12	281	330	P	H
		5704.6	51.93	-54.56	106.49	40.6	32.99	11.46	33.12	281	330	P	H
		5722	50.95	-64.41	115.36	39.61	33.01	11.46	33.13	281	330	P	H
	*	5785	106.91	-	-	95.54	33.09	11.45	33.17	281	330	P	H
	*	5785	98.9	-	-	87.53	33.09	11.45	33.17	281	330	A	H
		5852.4	53.99	-62.74	116.73	42.47	33.18	11.53	33.19	281	330	P	H
		5865	53.1	-54.9	108	41.5	33.21	11.6	33.21	281	330	P	H
		5917.6	52.42	-21.24	73.66	40.7	33.28	11.67	33.23	281	330	P	H
		5937	50.93	-17.27	68.2	39.2	33.3	11.67	33.24	281	330	P	H
													H
													H
802.11n													
HT20													
CH 157		5642.4	50.1	-18.1	68.2	38.84	32.89	11.47	33.1	155	169	P	V
5785MHz		5655.8	51.08	-21.43	72.51	39.8	32.92	11.47	33.11	155	169	P	V
		5711	50.91	-57.37	108.28	39.59	32.99	11.46	33.13	155	169	P	V
		5720.2	50.72	-60.54	111.26	39.38	33.01	11.46	33.13	155	169	P	V
	*	5785	103.82	-	-	92.45	33.09	11.45	33.17	155	169	P	V
	*	5785	96.03	-	-	84.66	33.09	11.45	33.17	155	169	A	V
		5851.8	53.31	-64.79	118.1	41.79	33.18	11.53	33.19	155	169	P	V
		5860	51.68	-57.72	109.4	40.15	33.21	11.53	33.21	155	169	P	V
		5876.6	51.57	-52.44	104.01	39.95	33.23	11.6	33.21	155	169	P	V
		5934.2	51.93	-16.27	68.2	40.19	33.3	11.67	33.23	155	169	P	V
													V
													V



WiFi Ant. 1	Note	Frequency (MHz)	Level (dBμV/m)	Over Limit (dB)	Limit Line (dBμV/m)	Read Level (dBμV)	Antenna Factor (dB/m)	Cable Loss (dB)	Preamp Factor (dB)	Ant Pos (cm)	Table Pos (deg)	Peak Avg. (P/A)	Pol. (H/V)	
802.11n HT20 CH 165 5825MHz	*	5825	106.26	-	-	94.75	33.16	11.53	33.18	276	336	P	H	
	*	5825	98.43	-	-	86.92	33.16	11.53	33.18	276	336	A	H	
		5852	55.84	-61.8	117.64	44.32	33.18	11.53	33.19	276	336	P	H	
		5867.8	55.75	-51.46	107.21	44.15	33.21	11.6	33.21	276	336	P	H	
		5887.4	53.41	-42.58	95.99	41.8	33.23	11.6	33.22	276	336	P	H	
		5928.8	50.91	-17.29	68.2	39.17	33.3	11.67	33.23	276	336	P	H	
														H
														H
	*	5825	104.74	-	-	93.23	33.16	11.53	33.18	162	167	P	V	
	*	5825	96.4	-	-	84.89	33.16	11.53	33.18	162	167	A	V	
		5850.8	52.81	-67.57	120.38	41.29	33.18	11.53	33.19	162	167	P	V	
		5870.6	53.57	-52.86	106.43	41.95	33.23	11.6	33.21	162	167	P	V	
		5880	52.83	-48.66	101.49	41.21	33.23	11.6	33.21	162	167	P	V	
		5937	51.54	-16.66	68.2	39.81	33.3	11.67	33.24	162	167	P	V	
														V
													V	
Remark	1. No other spurious found. 2. All results are PASS against Peak and Average limit line.													



Band 4 5725~5850MHz

WIFI 802.11n HT20 (Harmonic @ 3m)

WIFI Ant. 1	Note	Frequency (MHz)	Level (dBμV/m)	Over Limit (dB)	Limit Line (dBμV/m)	Read Level (dBμV)	Antenna Factor (dB/m)	Cable Loss (dB)	Preamp Factor (dB)	Ant Pos (cm)	Table Pos (deg)	Peak Avg. (P/A)	Pol. (H/V)	
802.11n HT20 CH 149 5745MHz		11490	41.14	-32.86	74	37.41	39.12	15.85	51.24	100	0	P	H	
		17235	50.28	-17.92	68.2	38.86	42.84	20.57	51.99	100	0	P	H	
													H	
													H	
			11490	40.31	-33.69	74	36.58	39.12	15.85	51.24	100	0	P	V
			17235	50.5	-17.7	68.2	39.08	42.84	20.57	51.99	100	0	P	V
														V
802.11n HT20 CH 157 5785MHz		11570	40.33	-33.67	74	36.61	39.07	15.91	51.26	100	0	P	H	
		17355	49.53	-18.67	68.2	37.5	43.26	20.78	52.01	100	0	P	H	
													H	
													H	
			11570	40.06	-33.94	74	36.34	39.07	15.91	51.26	100	0	P	V
			17355	50.5	-17.7	68.2	38.47	43.26	20.78	52.01	100	0	P	V
														V
802.11n HT20 CH 165 5825MHz		11650	40.23	-33.77	74	36.51	39.04	15.97	51.29	100	0	P	H	
		17475	49.66	-18.54	68.2	37.01	43.68	20.99	52.02	100	0	P	H	
													H	
													H	
			11650	39.75	-34.25	74	36.03	39.04	15.97	51.29	100	0	P	V
			17475	50.36	-17.84	68.2	37.71	43.68	20.99	52.02	100	0	P	V
														V
Remark	1. No other spurious found.													
	2. All results are PASS against Peak and Average limit line.													



Band 4 5725~5850MHz

WIFI 802.11n HT40 (Band Edge @ 3m)

WIFI Ant. 1	Note	Frequency (MHz)	Level (dBμV/m)	Over Limit (dB)	Limit Line (dBμV/m)	Read Level (dBμV)	Antenna Factor (dB/m)	Cable Loss (dB)	Preamp Factor (dB)	Ant Pos (cm)	Table Pos (deg)	Peak Avg. (P/A)	Pol. (H/V)
		5612.6	50.61	-17.59	68.2	39.37	32.84	11.48	33.08	206	341	P	H
		5690.2	51.8	-46.17	97.97	40.48	32.97	11.47	33.12	206	341	P	H
		5719	63.2	-47.32	110.52	51.86	33.01	11.46	33.13	206	341	P	H
		5723	63.95	-53.69	117.64	52.61	33.01	11.46	33.13	206	341	P	H
	*	5755	100	-	-	88.63	33.06	11.46	33.15	206	341	P	H
	*	5755	91.56	-	-	80.19	33.06	11.46	33.15	206	341	A	H
		5853.8	49.69	-63.85	113.54	38.14	33.21	11.53	33.19	206	341	P	H
		5866	52.05	-55.67	107.72	40.45	33.21	11.6	33.21	206	341	P	H
		5910.8	51.68	-27	78.68	39.96	33.28	11.67	33.23	206	341	P	H
		5934.4	51.56	-16.64	68.2	39.83	33.3	11.67	33.24	206	341	P	H
													H
													H
802.11n HT40 CH 151 5755MHz		5647.6	51.25	-16.95	68.2	39.99	32.89	11.47	33.1	154	167	P	V
		5699	51.82	-52.64	104.46	40.5	32.97	11.47	33.12	154	167	P	V
		5712.8	60.68	-48.11	108.79	49.36	32.99	11.46	33.13	154	167	P	V
		5720.8	65.5	-47.12	112.62	54.16	33.01	11.46	33.13	154	167	P	V
	*	5755	97.2	-	-	85.83	33.06	11.46	33.15	154	167	P	V
	*	5755	89.38	-	-	78.01	33.06	11.46	33.15	154	167	A	V
		5852.4	49.57	-67.16	116.73	38.05	33.18	11.53	33.19	154	167	P	V
		5873.6	51.95	-53.64	105.59	40.33	33.23	11.6	33.21	154	167	P	V
		5883	51.34	-47.92	99.26	39.72	33.23	11.6	33.21	154	167	P	V
		5934.8	51.95	-16.25	68.2	40.22	33.3	11.67	33.24	154	167	P	V
													V
													V



WIFI Ant. 1	Note	Frequency (MHz)	Level (dBμV/m)	Over Limit (dB)	Limit Line (dBμV/m)	Read Level (dBμV)	Antenna Factor (dB/m)	Cable Loss (dB)	Preamp Factor (dB)	Ant Pos (cm)	Table Pos (deg)	Peak Avg. (P/A)	Pol. (H/V)
		5619.4	50.14	-18.06	68.2	38.87	32.87	11.48	33.08	267	328	P	H
		5651.4	51.24	-18	69.24	39.95	32.92	11.47	33.1	267	328	P	H
		5711.4	50.28	-58.11	108.39	38.96	32.99	11.46	33.13	267	328	P	H
		5723	49.28	-68.36	117.64	37.94	33.01	11.46	33.13	267	328	P	H
	*	5795	98.9	-	-	87.51	33.11	11.45	33.17	267	328	P	H
	*	5795	90.62	-	-	79.23	33.11	11.45	33.17	267	328	A	H
		5852.2	52.13	-65.05	117.18	40.61	33.18	11.53	33.19	267	328	P	H
		5855.8	51.57	-59.01	110.58	40.02	33.21	11.53	33.19	267	328	P	H
		5909.8	52.29	-27.13	79.42	40.57	33.28	11.67	33.23	267	328	P	H
		5939.8	50.89	-17.31	68.2	39.13	33.33	11.67	33.24	267	328	P	H
802.11n													H
HT40													H
CH 159		5629	50.17	-18.03	68.2	38.93	32.87	11.47	33.1	157	167	P	V
5795MHz		5695.2	50.11	-51.55	101.66	38.79	32.97	11.47	33.12	157	167	P	V
		5700.8	49.61	-55.81	105.42	38.28	32.99	11.46	33.12	157	167	P	V
		5722.4	49.98	-66.29	116.27	38.64	33.01	11.46	33.13	157	167	P	V
	*	5795	97.85	-	-	86.46	33.11	11.45	33.17	157	167	P	V
	*	5795	89.36	-	-	77.97	33.11	11.45	33.17	157	167	A	V
		5852.2	49.75	-67.43	117.18	38.23	33.18	11.53	33.19	157	167	P	V
		5861.8	51.76	-57.13	108.89	40.16	33.21	11.6	33.21	157	167	P	V
		5878.6	51.13	-51.4	102.53	39.51	33.23	11.6	33.21	157	167	P	V
		5926	51.13	-17.07	68.2	39.39	33.3	11.67	33.23	157	167	P	V
													V
													V
Remark	1. No other spurious found. 2. All results are PASS against Peak and Average limit line.												



Band 4 5725~5850MHz

WIFI 802.11n HT40 (Harmonic @ 3m)

WIFI Ant. 1	Note	Frequency (MHz)	Level (dBμV/m)	Over Limit (dB)	Limit Line (dBμV/m)	Read Level (dBμV)	Antenna Factor (dB/m)	Cable Loss (dB)	Preamp Factor (dB)	Ant Pos (cm)	Table Pos (deg)	Peak Avg. (P/A)	Pol. (H/V)	
802.11n HT40 CH 151 5755MHz		11510	39.48	-34.52	74	35.74	39.1	15.88	51.24	100	0	P	H	
		17265	46.61	-21.59	68.2	35.01	42.96	20.64	52	100	0	P	H	
													H	
													H	
			11510	40.23	-33.77	74	36.49	39.1	15.88	51.24	100	0	P	V
			17265	50.16	-18.04	68.2	38.56	42.96	20.64	52	100	0	P	V
														V
802.11n HT40 CH 159 5795MHz		11590	39.85	-34.15	74	36.1	39.07	15.94	51.26	100	0	P	H	
		17385	46.66	-21.54	68.2	34.44	43.38	20.85	52.01	100	0	P	H	
													H	
													H	
			11590	40.12	-33.88	74	36.37	39.07	15.94	51.26	100	0	P	V
			17385	47.11	-21.09	68.2	34.89	43.38	20.85	52.01	100	0	P	V
														V
Remark	1. No other spurious found.													
	2. All results are PASS against Peak and Average limit line.													



Band 4 5725~5850MHz

Emission below 1GHz

5GHz WIFI 802.11a (LF @ 3m)

WIFI Ant.	Note	Frequency	Level	Over Limit	Limit Line	Read Level	Antenna Factor	Cable Loss	Preamp Factor	Ant Pos	Table Pos	Peak Avg.	Pol.
1		(MHz)	(dBµV/m)	(dB)	(dBµV/m)	(dBµV)	(dB/m)	(dB)	(dB)	(cm)	(deg)	(P/A)	(H/V)
		48.9	28.01	-11.99	40	43.44	15.77	1.29	32.49	100	12	P	H
		98.31	25.92	-17.58	43.5	41.03	15.86	1.51	32.48	-	-	P	H
		193.62	23.29	-20.21	43.5	38.48	15.58	2.1	32.87	-	-	P	H
		586.3	26.81	-19.19	46	30.13	25.46	3.67	32.45	-	-	P	H
		744.5	30.13	-15.87	46	30.78	27.6	4.09	32.34	-	-	P	H
		941.2	32.99	-13.01	46	29.23	30.35	4.69	31.28	-	-	P	H
													H
													H
													H
													H
													H
													H
5GHz													H
802.11a													H
LF		32.7	33	-7	40	40.06	24.14	1.29	32.49	-	-	P	V
		37.83	34.17	-5.83	40	43.95	21.42	1.29	32.49	100	270	P	V
		46.2	31.51	-8.49	40	46.08	16.63	1.29	32.49	-	-	P	V
		664.7	27.31	-18.69	46	29.5	26.34	3.94	32.47	-	-	P	V
		829.9	31.37	-14.63	46	30.34	28.66	4.39	32.02	-	-	P	V
		946.1	33.6	-12.4	46	29.66	30.49	4.69	31.24	-	-	P	V
													V
													V
													V
													V
													V
													V
													V
													V
													V
													V
Remark	1. No other spurious found. 2. All results are PASS against limit line.												



Emission below 1GHz

5GHz WIFI 802.11n HT20 (LF @ 3m)

WIFI	Note	Frequency	Level	Over	Limit	Read	Antenna	Cable	Preamp	Ant	Table	Peak	Pol.	
Ant.				Limit	Line	Level	Factor	Loss	Factor	Pos	Pos	Avg.		
1		(MHz)	(dBμV/m)	(dB)	(dBμV/m)	(dBμV)	(dB/m)	(dB)	(dB)	(cm)	(deg)	(P/A)	(H/V)	
5GHz 802.11n HT20 LF		31.08	24.05	-15.95	40	30.07	25.18	1.29	32.49	-	-	P	H	
		98.31	25.83	-17.67	43.5	40.94	15.86	1.51	32.48	-	-	P	H	
		198.48	23.72	-19.78	43.5	38.57	15.93	2.1	32.88	-	-	P	H	
		779.5	30.33	-15.67	46	30.42	28.06	4.09	32.24	-	-	P	H	
		888	32.85	-13.15	46	30.87	29.13	4.57	31.72	-	-	P	H	
		945.4	32.96	-13.04	46	29.03	30.49	4.69	31.25	100	10	P	H	
														H
														H
														H
														H
														H
														H
														H
														H
			32.7	32.78	-7.22	40	39.84	24.14	1.29	32.49	-	-	P	V
			37.83	32.87	-7.13	40	42.65	21.42	1.29	32.49	100	358	P	V
			46.2	31.83	-8.17	40	46.4	16.63	1.29	32.49	-	-	P	V
			731.9	28.62	-17.38	46	29.63	27.35	4.02	32.38	-	-	P	V
			834.8	31.65	-14.35	46	30.54	28.72	4.39	32	-	-	P	V
			955.9	33.68	-12.32	46	29.54	30.59	4.69	31.14	-	-	P	V
													V	
													V	
													V	
													V	
													V	
													V	
Remark	1. No other spurious found. 2. All results are PASS against limit line.													



Emission below 1GHz

5GHz WIFI 802.11n HT40 (LF @ 3m)

WIFI	Note	Frequency	Level	Over	Limit	Read	Antenna	Cable	Preamp	Ant	Table	Peak	Pol.	
Ant.				Limit	Line	Level	Factor	Loss	Factor	Pos	Pos	Avg.		
1		(MHz)	(dBμV/m)	(dB)	(dBμV/m)	(dBμV)	(dB/m)	(dB)	(dB)	(cm)	(deg)	(P/A)	(H/V)	
5GHz 802.11n HT40 LF		31.62	23.86	-16.14	40	30.4	24.66	1.29	32.49	-	-	P	H	
		98.31	25.09	-18.41	43.5	40.2	15.86	1.51	32.48	-	-	P	H	
		198.48	22.92	-20.58	43.5	37.77	15.93	2.1	32.88	-	-	P	H	
		798.4	30.58	-15.42	46	30.23	28.28	4.26	32.19	-	-	P	H	
		859.3	32.2	-13.8	46	30.72	28.96	4.39	31.87	-	-	P	H	
		950.3	33.15	-12.85	46	29.06	30.6	4.69	31.2	100	0	P	H	
														H
														H
														H
														H
														H
														H
														H
														H
														H
			32.43	32.87	-7.13	40	39.93	24.14	1.29	32.49	100	58	P	V
			38.37	32.85	-7.15	40	43.19	20.86	1.29	32.49	-	-	P	V
			43.23	31.4	-8.6	40	44.54	18.06	1.29	32.49	-	-	P	V
		728.4	29.32	-16.68	46	30.42	27.27	4.02	32.39	-	-	P	V	
		841.1	32.07	-13.93	46	30.86	28.79	4.39	31.97	-	-	P	V	
		953.8	33.65	-12.35	46	29.53	30.59	4.69	31.16	-	-	P	V	
													V	
													V	
													V	
													V	
													V	
													V	
													V	
Remark	1. No other spurious found. 2. All results are PASS against limit line.													



Note symbol

*	Fundamental Frequency which can be ignored. However, the level of any unwanted emissions shall not exceed the level of the fundamental frequency.
!	Test result is over limit line.
P/A	Peak or Average
H/V	Horizontal or Vertical



A calculation example for radiated spurious emission is shown as below:

WIFI	Note	Frequency	Level	Over	Limit	Read	Antenna	Cable	Preamp	Ant	Table	Peak	Pol.
Ant.				Limit	Line	Level	Factor	Loss	Factor	Pos	Pos	Avg.	
1		(MHz)	(dBμV/m)	(dB)	(dBμV/m)	(dBμV)	(dB/m)	(dB)	(dB)	(cm)	(deg)	(P/A)	(H/V)
802.11b		2390	55.45	-18.55	74	54.51	32.22	4.58	35.86	103	308	P	H
CH 01													
2412MHz		2390	43.54	-10.46	54	42.6	32.22	4.58	35.86	103	308	A	H

- Level(dBμV/m) =
Antenna Factor(dB/m) + Cable Loss(dB) + Read Level(dBμV) - Preamp Factor(dB)
- Over Limit(dB) = Level(dBμV/m) – Limit Line(dBμV/m)

For Peak Limit @ 2390MHz:

- Level(dBμV/m)
= Antenna Factor(dB/m) + Cable Loss(dB) + Read Level(dBμV) - Preamp Factor(dB)
= 32.22(dB/m) + 4.58(dB) + 54.51(dBμV) – 35.86 (dB)
= 55.45 (dBμV/m)
- Over Limit(dB)
= Level(dBμV/m) – Limit Line(dBμV/m)
= 55.45(dBμV/m) – 74(dBμV/m)
= -18.55(dB)

For Average Limit @ 2390MHz:

- Level(dBμV/m)
= Antenna Factor(dB/m) + Cable Loss(dB) + Read Level(dBμV) - Preamp Factor(dB)
= 32.22(dB/m) + 4.58(dB) + 42.6(dBμV) – 35.86 (dB)
= 43.54 (dBμV/m)
- Over Limit(dB)
= Level(dBμV/m) – Limit Line(dBμV/m)
= 43.54(dBμV/m) – 54(dBμV/m)
= -10.46(dB)

Both peak and average measured complies with the limit line, so test result is “PASS”.



Appendix C. Radiated Spurious Emission Plots

Test Engineer :	J.C. Liang, Nick Yu, and Ken Wu	Temperature :	20~23°C
		Relative Humidity :	58~63%

Note symbol

-L	Low channel location
-R	High channel location



Band 4 - 5725~5850MHz
WIFI 802.11a (Band Edge @ 3m)

WIFI	Band 4 5725~5850MHz Band Edge @ 3m	
ANT	802.11a CH149 5745MHz	
1	Horizontal	Fundamental
Peak	<p>Site : :03CH11-HY Condition : :PEAK_RE(94)_1E-24 3m HORN 9120D-HF HORIZONTAL</p>	<p>Site : :03CH11-HY Condition : :PEAK(UN)I 3m HORN 9120D-HF HORIZONTAL</p>



WIFI	Band 4 5725~5850MHz Band Edge @ 3m	
ANT	802.11a CH149 5745MHz	
1	Vertical	Fundamental
Peak	<p>Site : 03CH11-HY Condition : PEAK_BE(B4)_16-24 3m HORN 9120D-HF VERTICAL Date: 2017-01-21 PEAK_BE(B4)_16-24</p>	<p>Site : 03CH11-HY Condition : PEAK(FUND) 3m HORN 9120D-HF VERTICAL Date: 2017-01-21 PEAK(FUND) AVG_24</p>



WIFI	Band 4 5725~5850MHz Band Edge @ 3m	
ANT	802.11a CH157 5785MHz	
1	Horizontal	Fundamental
<p>Peak</p>		
<p>Peak</p>		<p>Left blank</p>



WIFI	Band 4 5725~5850MHz Band Edge @ 3m	
ANT	802.11a CH157 5785MHz	
1	Vertical	Fundamental
Peak		
Peak		Left blank



WIFI	Band 4 5725~5850MHz Band Edge @ 3m	
ANT	802.11a CH165 5825MHz	
1	Horizontal	Fundamental
<p>Peak</p>		



WIFI	Band 4 5725~5850MHz Band Edge @ 3m	
ANT	802.11a CH165 5825MHz	
1	Vertical	Fundamental
Peak		



**Band 4 5725~5850MHz
WIFI 802.11n HT20 (Band Edge @ 3m)**

WIFI	Band 4 5725~5850MHz Band Edge @ 3m	
ANT	802.11n HT20 CH149 5745MHz	
1	Horizontal	Fundamental
Peak	<p>Site : 03CH11-HY Condition : PEAK_BE(B4)_16-24 3m HORN 9120D-HF HORIZONTAL</p>	<p>Site : 03CH11-HY Condition : PEAK(UWB) 3m HORN 9120D-HF HORIZONTAL</p>



WIFI	Band 4 5725~5850MHz Band Edge @ 3m	
ANT	802.11n HT20 CH149 5745MHz	
1	Vertical	Fundamental
Peak	<p>Site : 03CH11-14F Condition : PEAK_BE(B4)_16-24 3m HORN 9120D-HF VERTICAL Date: 2017-01-21 PEAK_BE(B4)_16-24</p>	<p>Site : 03CH11-14F Condition : PEAK(UNII) 3m HORN 9120D-HF VERTICAL Date: 2017-01-21 PEAK(UNII)</p>



WIFI	Band 4 5725~5850MHz Band Edge @ 3m	
ANT	802.11n HT20 CH157 5785MHz	
1	Horizontal	Fundamental
Peak		
Peak		Left blank



WIFI	Band 4 5725~5850MHz Band Edge @ 3m	
ANT	802.11n HT20 CH157 5785MHz	
1	Vertical	Fundamental
Peak		
Peak		Left blank



WIFI	Band 4 5725~5850MHz Band Edge @ 3m	
ANT	802.11n HT20 CH165 5825MHz	
1	Horizontal	Fundamental
Peak	<p>Site : 03CH11-14Y Condition : PEAK_BE(B4)_16-24 3m HORN 9120D-HF HORIZONTAL</p>	<p>Site : 03CH11-14Y Condition : PEAK(UNII) 3m HORN 9120D-HF HORIZONTAL</p>



WIFI	Band 4 5725~5850MHz Band Edge @ 3m	
ANT	802.11n HT20 CH165 5825MHz	
1	Vertical	Fundamental
Peak	<p>Site : 03CH11-14Y Condition : PEAK_BE(B4)_16-24 3m HORN 9120D-HF VERTICAL</p>	<p>Site : 03CH11-14Y Condition : PEAK(UNII) 3m HORN 9120D-HF VERTICAL</p>



**Band 4 5725~5850MHz
WIFI 802.11n HT40 (Band Edge @ 3m)**

WIFI	Band 4 5725~5850MHz Band Edge @ 3m	
ANT	802.11n HT40 CH151 5755MHz	
1	Horizontal	Fundamental
Peak	<p>Site Condition : 03CH11-HY : PEAK_BE(B4)_16-24 3m HORN 9120D-HF HORIZONTAL</p>	<p>Site Condition : 03CH11-HY : PEAK(UWB) 3m HORN 9120D-HF HORIZONTAL</p>
Peak	<p>Site Condition : 03CH11-HY : PEAK_BE(B4)_16-24 3m HORN 9120D-HF HORIZONTAL</p>	Left blank



WIFI	Band 4 5725~5850MHz Band Edge @ 3m	
ANT	802.11n HT40 CH151 5755MHz	
1	Vertical	Fundamental
<p>Peak</p>	<p>Site : 03CHI1-HY Condition : PEAK_BE(84)_16-24 3m HORN 9120D-HF VERTICAL</p>	<p>Site : 03CHI1-HY Condition : PEAK(UNIB) 3m HORN 9120D-HF VERTICAL</p>
<p>Peak</p>	<p>Site : 03CHI1-HY Condition : PEAK_BE(84)_16-24 3m HORN 9120D-HF VERTICAL</p>	<p>Left blank</p>



WIFI	Band 4 5725~5850MHz Band Edge @ 3m	
ANT	802.11n HT40 CH159 5795MHz	
1	Horizontal	Fundamental
Peak	<p>Site : 03CH11-HY Condition : PEAK_BE(B4)_16-24 3m HORN 9120D-HF HORIZONTAL</p>	<p>Site : 03CH11-HY Condition : PEAK(LINB) 3m HORN 9120D-HF HORIZONTAL</p>
Peak	<p>Site : 03CH11-HY Condition : PEAK_BE(B4)_16-24 3m HORN 9120D-HF HORIZONTAL</p>	Left blank



WIFI	Band 4 5725~5850MHz Band Edge @ 3m	
ANT	802.11n HT40 CH159 5795MHz	
1	Vertical	Fundamental
Peak	<p>Site : 03CHI1-HY Condition : PEAK_BE(B4)_16-24 3m HORN 9120D-HF VERTICAL</p>	<p>Site : 03CHI1-HY Condition : PEAK(UNI1) 3m HORN 9120D-HF VERTICAL</p>
Peak	<p>Site : 03CHI1-HY Condition : PEAK_BE(B4)_16-24 3m HORN 9120D-HF VERTICAL</p>	Left blank



Band 4 - 5725~5850MHz
WIFI 802.11a (Harmonic @ 3m)

WIFI	Band 4 5725~5850MHz Harmonic @ 3m	
ANT	802.11a CH149 5745MHz	
1	Horizontal	Vertical
Peak Avg.	<p>Site : 03CH11-HY Condition : PEAK(LINE1) 3m 9170 SHF HORM_150809 HORIZONTAL</p>	<p>Site : 03CH11-HY Condition : PEAK(LINE1) 3m 9170 SHF HORM_150809 VERTICAL</p>

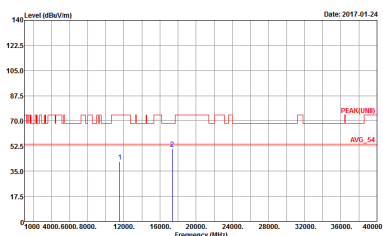
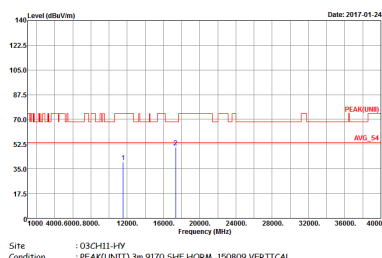

WIFI	Band 4 5725~5850MHz Harmonic @ 3m	
ANT	802.11a CH157 5785MHz	
1	Horizontal	Vertical
Peak Avg.	 <p>Site : 03CH11-1F Condition : PEAK(UNII) 3m 9170 SHF HORM_150809 HORIZONTAL</p>	 <p>Site : 03CH11-1F Condition : PEAK(UNII) 3m 9170 SHF HORM_150809 VERTICAL</p>

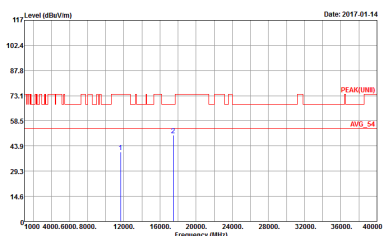
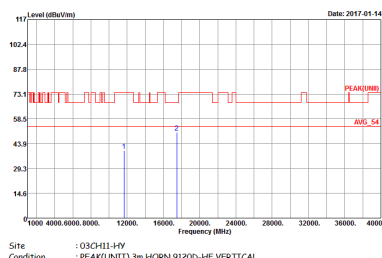

WIFI	Band 4 5725~5850MHz Harmonic @ 3m	
ANT	802.11a CH165 5825MHz	
1	Horizontal	Vertical
Peak Avg.	 <p>Site : 03CH11-HY Condition : PEAK(UNII) 3m HORN 9120D-HF HORIZONTAL</p>	 <p>Site : 03CH11-HY Condition : PEAK(UNII) 3m HORN 9120D-HF VERTICAL</p>



Band 4 5725~5850MHz
WIFI 802.11n HT20 (Harmonic @ 3m)

WIFI	Band 4 5725~5850MHz Harmonic @ 3m	
ANT	802.11n HT20 CH149 5745MHz	
1	Horizontal	Vertical
Peak Avg.	<p>Site : 03CH11-HY Condition : PEAK(LNII) 3m 9170 SHF HORM_150809 HORIZONTAL</p>	<p>Site : 03CH11-HY Condition : PEAK(LNII) 3m 9170 SHF HORM_150809 VERTICAL</p>



WIFI	Band 4 5725~5850MHz Harmonic @ 3m	
ANT	802.11n HT20 CH157 5785MHz	
1	Horizontal	Vertical
Peak Avg.	<p>Site : 03CH11-HY Condition : PEAK(LINE) 3m 9170 SHF HORM_150809 HORIZONTAL</p>	<p>Site : 03CH11-HY Condition : PEAK(LINE) 3m 9170 SHF HORM_150809 VERTICAL</p>



WIFI	Band 4 5725~5850MHz Harmonic @ 3m	
ANT	802.11n HT20 CH165 5825MHz	
1	Horizontal	Vertical
Peak Avg.	<p>Site : 03CH1-HY Condition : PEAK(UNIT) 3m 9170 SHF HORM_150809 HORIZONTAL</p>	<p>Site : 03CH1-HY Condition : PEAK(UNIT) 3m 9170 SHF HORM_150809 VERTICAL</p>



**Band 4 5725~5850MHz
WIFI 802.11n HT40 (Harmonic @ 3m)**

WIFI	Band 4 5725~5850MHz Harmonic @ 3m	
ANT	802.11n HT40 CH151 5755MHz	
1	Horizontal	Vertical
Peak Avg.	<p>Site : 03CH11-HY Condition : PEAK(UNII) 3m 9170 SHF HORM_150809 HORIZONTAL</p>	<p>Site : 03CH11-HY Condition : PEAK(UNII) 3m 9170 SHF HORM_150809 VERTICAL</p>



WIFI	Band 4 5725~5850MHz Harmonic @ 3m	
ANT	802.11n HT40 CH159 5795MHz	
1	Horizontal	Vertical
Peak Avg.	<p>Site : 03CH11-HY Condition : -PEAK(UNII) 3m 9170 SHF HORM_150809 HORIZONTAL</p>	<p>Site : 03CH11-HY Condition : -PEAK(UNII) 3m 9170 SHF HORM_150809 VERTICAL</p>



Band 4 5725~5850MHz
Emission below 1GHz
5GHz WIFI 802.11a (LF)

WIFI	5GHz 5725~5850MHz	
ANT	802.11a LF	
1	Horizontal	Vertical
QP / Peak	<p>Site : 03CH11-HY Condition : QP 3m BE-LOG 6111D-LF_ETC HORIZONTAL</p>	<p>Site : 03CH11-HY Condition : QP 3m BE-LOG 6111D-LF_ETC VERTICAL</p>

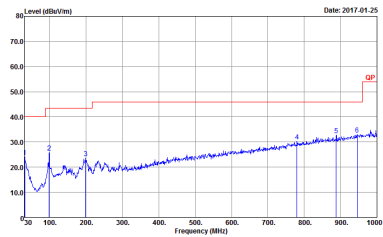
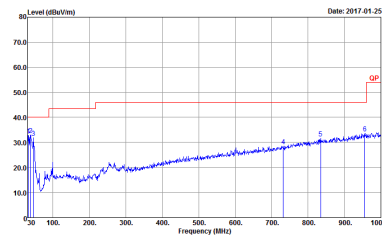

Emission below 1GHz
5GHz WIFI 802.11n HT20 (LF)

WIFI	5GHz 5725~5850MHz	
ANT	802.11n HT20 LF	
1	Horizontal	Vertical
QP / Peak	 <p>Site : 03CH11-HY Condition : QP-3m 8L-L06-6111D-LF_ETC HORIZONTAL</p>	 <p>Site : 03CH11-HY Condition : QP-3m 8L-L06-6111D-LF_ETC VERTICAL</p>



Emission below 1GHz
5GHz WIFI 802.11n HT40 (LF)

WIFI	5GHz 5725~5850MHz	
ANT	802.11n HT40 LF	
1	Horizontal	Vertical
QP / Peak	<p>Site : 03CH11-HY Condition : QP-3m 8L-L06-6111D-LF_ETC HORIZONTAL</p>	<p>Site : 03CH11-HY Condition : QP-3m 8L-L06-6111D-LF_ETC VERTICAL</p>

Appendix D Duty Cycle Plots

Band	Duty Cycle(%)	T(us)	1/T(kHz)	VBW Setting
802.11a	97.77	1434	0.70	1kHz
5GHz 802.11n HT20	97.02	1364	0.73	1kHz
5GHz 802.11n HT40	94.37	682	1.47	3kHz

802.11a

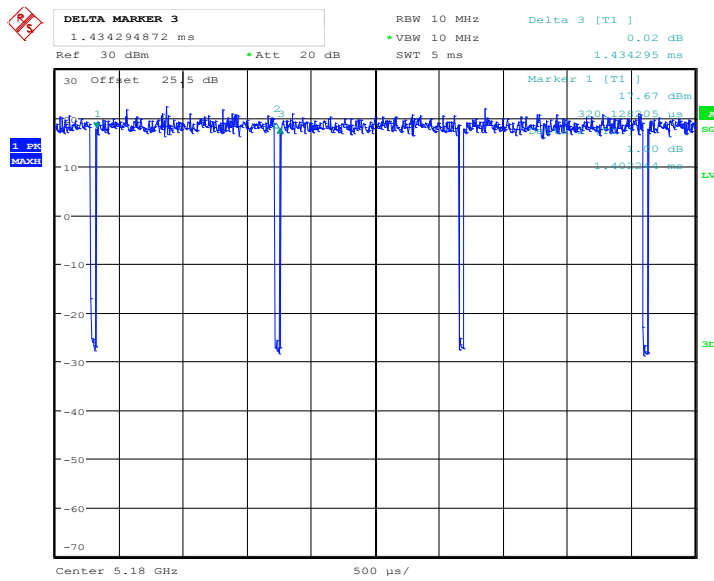

Date: 3.DEC.2016 01:08:41



5GHz 802.11n HT20

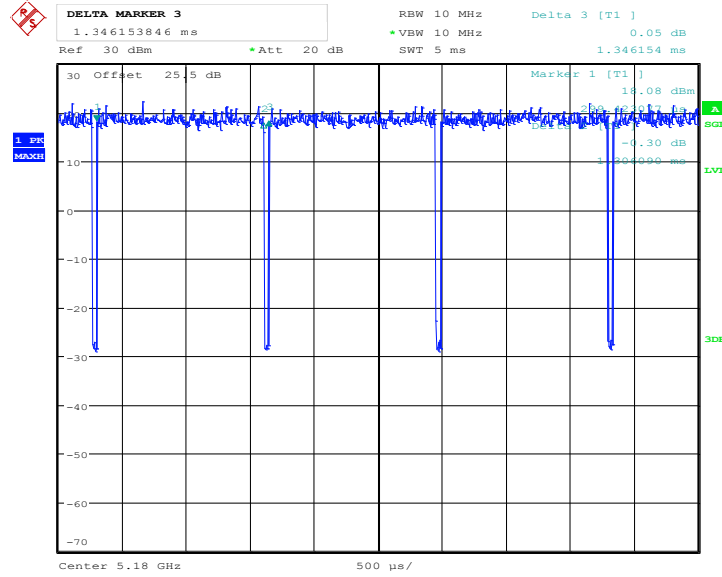

Date: 3.DEC.2016 01:10:00

5GHz 802.11n HT40

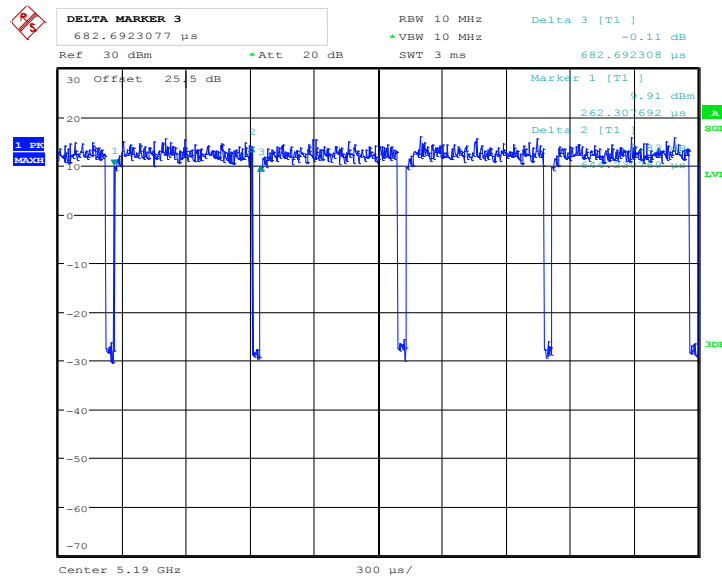

Date: 3.DEC.2016 01:12:25