



FCC RF Test Report

APPLICANT : Sony Mobile Communications Inc.
EQUIPMENT : GSM/WCDMA/LTE Phone+Bluetooth, DTS/UNII
a/b/g/n and NFC
BRAND NAME : Sony
FCC ID : PY7-19719M
STANDARD : FCC Part 15 Subpart E §15.407
CLASSIFICATION : (NII) Unlicensed National Information Infrastructure

The product was received on Nov. 22, 2016 and testing was completed on Jan. 25, 2017. We, SPORTON INTERNATIONAL INC., would like to declare that the tested sample has been evaluated in accordance with the test procedures and has been in compliance with the applicable technical standards.

The test results in this report apply exclusively to the tested model / sample. Without written approval of SPORTON INTERNATIONAL INC., the test report shall not be reproduced except in full.

Reviewed by: Joseph Lin / Supervisor

Approved by: Jones Tsai / Manager



SPORTON INTERNATIONAL INC.

No. 52, Hwa Ya 1st Rd., Hwa Ya Technology Park, Kwei-Shan District, Tao Yuan City, Taiwan, R.O.C.

SPORTON INTERNATIONAL INC.

TEL : 886-3-327-3456

FAX : 886-3-328-4978

FCC ID : PY7-19719M

Page Number : 1 of 36

Report Issued Date : Mar. 10, 2017

Report Version : Rev. 02

Report Template No.: BU5-FR15EWL Version 1.4



TABLE OF CONTENTS

SUMMARY OF TEST RESULT 4

1 GENERAL DESCRIPTION 5

1.1 Applicant 5

1.2 Manufacturer 5

1.3 Product Feature of Equipment Under Test 5

1.4 Modification of EUT 6

1.5 Testing Location 7

1.6 Applicable Standards 8

2 TEST CONFIGURATION OF EQUIPMENT UNDER TEST 9

2.1 Carrier Frequency Channel 9

2.2 Test Mode 10

2.3 Connection Diagram of Test System 11

2.4 Support Unit used in test configuration and system 12

2.5 EUT Operation Test Setup 12

2.6 Measurement Results Explanation Example 12

3 TEST RESULT 13

3.1 26dB & 99% Occupied Bandwidth Measurement 13

3.2 Maximum Conducted Output Power Measurement 15

3.3 Power Spectral Density Measurement 18

3.4 Unwanted Radiated Emission Measurement 21

3.5 AC Conducted Emission Measurement 27

3.6 Frequency Stability Measurement 31

3.7 Automatically Discontinue Transmission 32

3.8 Antenna Requirements 33

4 LIST OF MEASURING EQUIPMENTS 34

5 UNCERTAINTY OF EVALUATION 36

APPENDIX A. CONDUCTED TEST RESULTS

APPENDIX B. RADIATED SPURIOUS EMISSION

APPENDIX C. RADIATED SPURIOUS EMISSION PLOTS

APPENDIX D. DUTY CYCLE PLOTS



REVISION HISTORY

REPORT NO.	VERSION	DESCRIPTION	ISSUED DATE
FR6N2202-01E	Rev. 01	Initial issue of report	Feb. 21, 2017
FR6N2202-01E	Rev. 02	Revising the description of limit of unwanted emissions in report section 3.4.1.	Mar. 10, 2017



SUMMARY OF TEST RESULT

Report Section	FCC Rule	Description	Limit	Result	Remark
3.1	2.1049 15.403(i)	26dB & 99% Bandwidth	-	Pass	-
3.2	15.407(a)	Maximum Conducted Output Power	FCC ≤ 24 dBm (depend on band)	Pass	-
3.3	15.407(a)	Power Spectral Density	FCC ≤ 11 dBm (depend on band)	Pass	-
3.4	15.407(b)	Unwanted Emissions	≤ -17, -27 dBm (depend on band)&15.209(a)	Pass	Under limit 3.14 dB at 5148.720 MHz
3.5	15.207	AC Conducted Emission	15.207(a)	Pass	Under limit 16.50 dB at 0.150 MHz
3.6	15.407(g)	Frequency Stability	Within Operation Band	Pass	-
3.7	15.407(c)	Automatically Discontinue Transmission	Discontinue Transmission	Pass	-
3.8	15.203 & 15.407(a)	Antenna Requirement	N/A	Pass	-



1 General Description

1.1 Applicant

Sony Mobile Communications Inc.

4-12-3 Higashi-Shinagawa, Shinagawa-ku, Tokyo, 140-0002, Japan

1.2 Manufacturer

Sony Mobile Communications Inc.

4-12-3 Higashi-Shinagawa, Shinagawa-ku, Tokyo, 140-0002, Japan

1.3 Product Feature of Equipment Under Test

GSM/WCDMA/LTE, Bluetooth, DTS/UNII, a/b/g/n, GPS, and NFC

Standards-related Product Specification	
Antenna Type	PIFA Antenna
Antenna Gain	<5150 MHz ~ 5250 MHz> -0.70 dBi
	<5250 MHz ~ 5350 MHz> -0.20 dBi
	<5470 MHz ~ 5725 MHz> -0.30 dBi

EUT Information List			
HW Version	SW Version	S/N	Performed Test Item
A	0.79	RQ3003BXX4	RF conducted measurement
		RQ3003BXJY	Radiated Spurious Emission
		RQ3003BXX6	Conducted Emission



Accessory List	
AC Adapter 1	Model No. : UCH20
	S/N : 1215W486600059 (for radiated spurious emission) 5816W13300005 (for conducted emission)
	Model No. : MH410c
Earphone 1	S/N: 1632A86100002DB (for radiated spurious emission) 1632A864000088 (for conducted emission)
	Model No. : UCB20
	S/N : 1625A91B0003352 (for radiated spurious emission) 1625A91900007E2 (for conducted emission)

Note:

1. Above EUT list and accessory list used are electrically identical per declared by manufacturer.
2. Above the accessories list are used to exercise the EUT during test.
3. For other wireless features of this EUT, test report will be issued separately.

1.4 Modification of EUT

No modifications are made to the EUT during all test items.



1.5 Testing Location

Sporton Lab is accredited to ISO 17025 by Taiwan Accreditation Foundation (TAF code : 1190) and the FCC designation No. TW0007 under the FCC 2.948(e) by Mutual Recognition Agreement (MRA) in FCC Test.

Test Site	SPORTON INTERNATIONAL INC.	
Test Site Location	No. 52, Hwa Ya 1 st Rd., Hwa Ya Technology Park, Kwei-Shan District, Tao Yuan City, Taiwan, R.O.C. TEL: +886-3-327-3456 FAX: +886-3-328-4978	
Test Site No.	Sporton Site No.	
	TH05-HY	CO05-HY

Note: The test site complies with ANSI C63.4 2014 requirement.

Test Site	SPORTON INTERNATIONAL INC.	
Test Site Location	No.58, Aly. 75, Ln. 564, Wenhua 3rd Rd. Guishan Dist, Taoyuan City, Taiwan (R.O.C.) TEL: +886-3-327-0868 FAX: +886-3-327-0855	
Test Site No.	Sporton Site No.	
	03CH11-HY	

Note: The test site complies with ANSI C63.4 2014 requirement.



1.6 Applicable Standards

According to the specifications of the manufacturer, the EUT must comply with the requirements of the following standards:

- ♦ FCC Part 15 Subpart E
- ♦ FCC KDB 789033 D02 General UNII Test Procedures New Rules v01r03
- ♦ ANSI C63.10-2013

Remark:

1. All test items were verified and recorded according to the standards and without any deviation during the test.
2. This EUT has also been tested and complied with the requirements of FCC Part 15, Subpart B, recorded in a separate test report.



2 Test Configuration of Equipment Under Test

The EUT has been associated with peripherals and configuration operated in a manner tended to maximize its emission characteristics in a typical application. Frequency range investigated: conducted emission (150 kHz to 30 MHz) and radiated emission (9 kHz to the 10th harmonic of the highest fundamental frequency or to 40 GHz, whichever is lower). For radiated measurement, pre-scanned in three orthogonal panels, X, Y, Z. The worst cases (Z plane) were recorded in this report.

2.1 Carrier Frequency Channel

Frequency Band	Channel	Freq. (MHz)	Channel	Freq. (MHz)
5150-5250 MHz Band 1 (U-NII-1)	36	5180	44	5220
	38*	5190	46*	5230
	40	5200	48	5240
	-	-		

Frequency Band	Channel	Freq. (MHz)	Channel	Freq. (MHz)
5250-5350 MHz Band 2 (U-NII-2A)	52	5260	60	5300
	54*	5270	62*	5310
	56	5280	64	5320
	-	-		

Frequency Band	Channel	Freq. (MHz)	Channel	Freq. (MHz)
5470-5725 MHz Band 3 (U-NII-2C)	100	5500	112	5560
	102*	5510	116	5580
	104	5520	132	5660
	-	-	134*	5670
	108	5540	136	5680
	110*	5550	140	5700

Frequency Band	Channel	Freq. (MHz)	Channel	Freq. (MHz)
Straddle Channel	-	-	144	5720
	142*	5710		

Note: The above Frequency and Channel in "*" were 802.11n HT40



2.2 Test Mode

Final test mode of conducted test items and radiated spurious emissions are considering the modulation and worse data rates as below table.

Modulation	Data Rate
802.11a	6 Mbps
802.11n HT20	MCS0
802.11n HT40	MCS0

AC Conducted Emission	Mode 1 : GSM1900 Idle + Bluetooth Link + WLAN (5GHz) Link + Camera (Rear) + Earphone 1 + Battery + USB Cable (Charging from Adapter 3)
------------------------------	---

Ch. #		Band I : 5150-5250 MHz	Band II : 5250-5350 MHz	Band III : 5470-5725MHz
		802.11a	802.11a	802.11a
L	Low	36	52	100
M	Middle	44	60	116
H	High	48	64	140
Straddle		-	-	144

Ch. #		Band I : 5150-5250 MHz	Band II : 5250-5350 MHz	Band III : 5470-5725MHz
		802.11n HT20	802.11n HT20	802.11n HT20
L	Low	36	52	100
M	Middle	44	60	116
H	High	48	64	140
Straddle		-	-	144

Ch. #		Band I : 5150-5250 MHz	Band II : 5250-5350 MHz	Band III : 5470-5725MHz
		802.11n HT40	802.11n HT40	802.11n HT40
L	Low	38	54	102
M	Middle	-	-	110
H	High	46	62	134
Straddle		-	-	142

2.3 Connection Diagram of Test System

<WLAN Tx Mode>

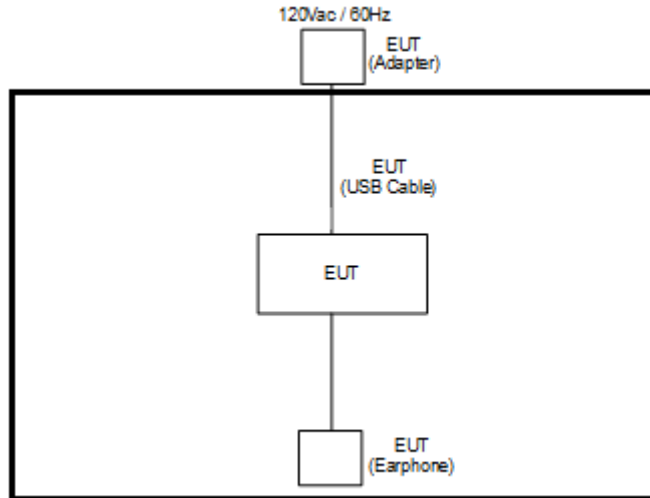

<AC Conducted Emission Mode>

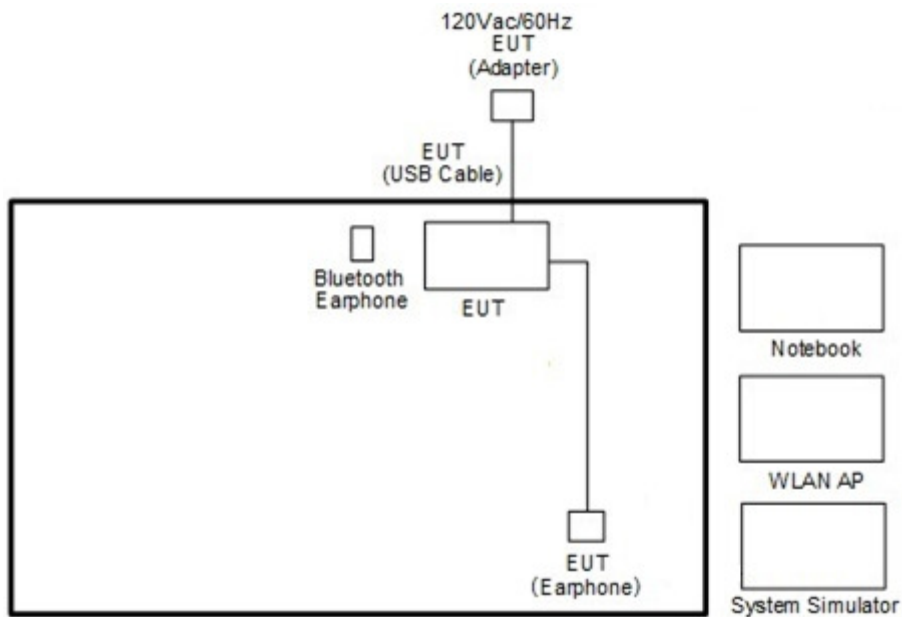



2.4 Support Unit used in test configuration and system

Item	Equipment	Trade Name	Model Name	FCC ID	Data Cable	Power Cord
1.	System Simulator	Anritsu	MT8820C	N/A	N/A	Unshielded, 1.8 m
2.	WLAN AP	D-Link	DIR-865L	KA2IR865LA1	N/A	Unshielded, 1.8m
3.	Notebook	DELL	Latitude E6320	FCC DoC/ Contains FCC ID: QDS-BRCM1054	N/A	AC I/P: Unshielded, 1.2 m DC O/P: Shielded, 1.8 m
4.	Bluetooth Earphone	Sony	SBH20	PY7-RD0010	N/A	N/A
5.	SD Card	SanDisk	MicroSD HC	FCC DoC	N/A	N/A

2.5 EUT Operation Test Setup

For RF test items, an engineering test program was provided and enabled to make EUT transmitting signals.

2.6 Measurement Results Explanation Example

For all conducted test items:

The offset level is set in the spectrum analyzer to compensate the RF cable loss and attenuator factor between EUT conducted output port and spectrum analyzer. With the offset compensation, the spectrum analyzer reading level is exactly the EUT RF output level.

Example :

The spectrum analyzer offset is derived from RF cable loss and attenuator factor.

Offset = RF cable loss + attenuator factor.

Following shows an offset computation example with cable loss 4.2 dB and 10dB attenuator.

$$\begin{aligned}
 \text{Offset(dB)} &= \text{RF cable loss(dB)} + \text{attenuator factor(dB)}. \\
 &= 4.2 + 10 = 14.2 \text{ (dB)}
 \end{aligned}$$

3 Test Result

3.1 26dB & 99% Occupied Bandwidth Measurement

3.1.1 Description of 26dB & 99% Occupied Bandwidth

This section is for reporting purpose only.

There is no restriction limits for bandwidth.

For Straddle Channel, U-NII procedures and limits were applied for operations in the frequency band in accordance with FCC KDB 644545 D03.

3.1.2 Measuring Instruments

The measuring equipment is listed in the section 4 of this test report.

3.1.3 Test Procedures

1. The testing follows FCC KDB 789033 D02 General UNII Test Procedures New Rules v01r03. Section C) Emission bandwidth
2. Set RBW = approximately 1% of the emission bandwidth.
3. Set the VBW > RBW.
4. Detector = Peak.
5. Trace mode = max hold
6. Measure the maximum width of the emission that is 26 dB down from the peak of the emission. Compare this with the RBW setting of the analyzer. Readjust RBW and repeat measurement as needed until the RBW/EBW ratio is approximately 1%.
7. For 99% Bandwidth Measurement, the spectrum analyzer's resolution bandwidth (RBW) is set 1MHz and set the Video bandwidth (VBW) $\geq 3 * RBW$.
8. Measure and record the results in the test report.

3.1.4 Test Setup

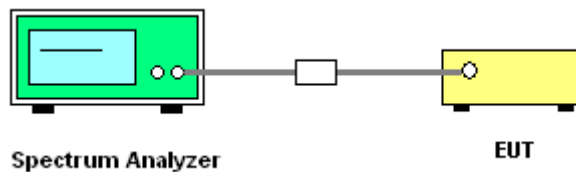



3.1.5 Test Result of 26dB & 99% Occupied Bandwidth Plots

Please refer to Appendix A.

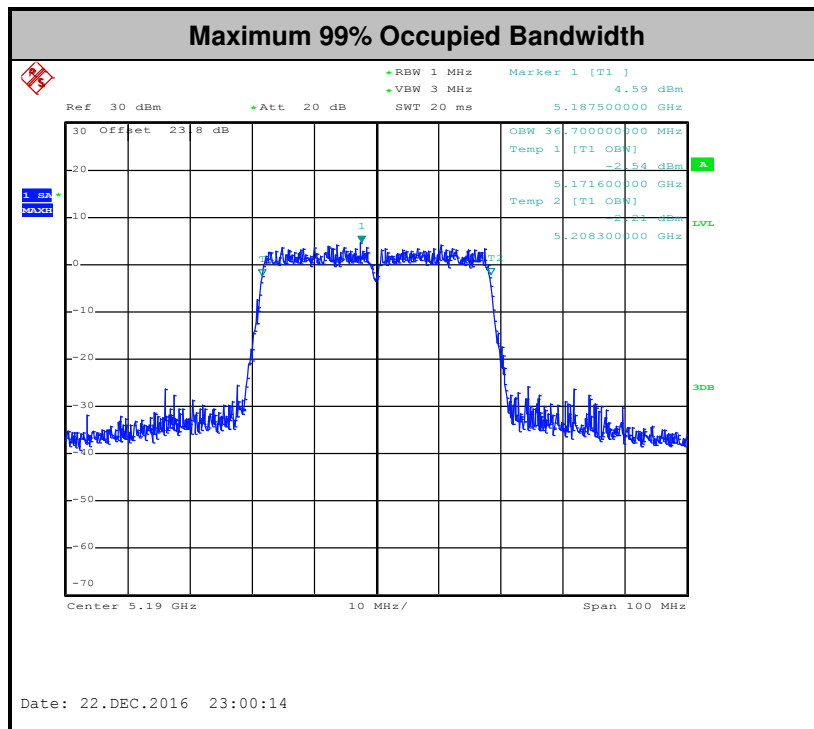
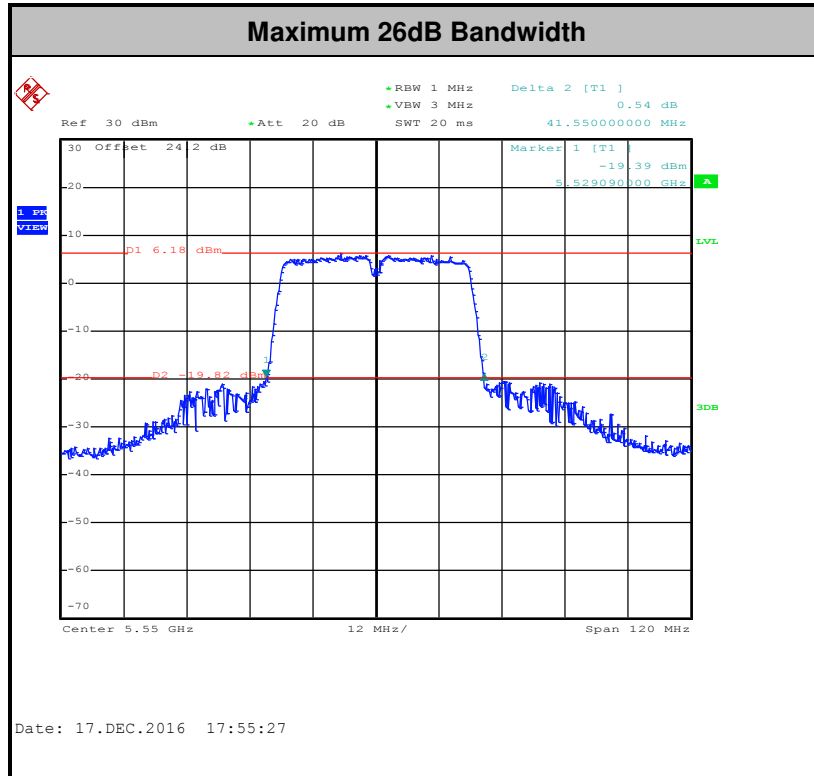



3.2 Maximum Conducted Output Power Measurement

3.2.1 Limit of Maximum Conducted Output Power

<FCC 14-30 CFR 15.407>

For mobile and portable client devices in the 5.15–5.25 GHz band, the maximum conducted output power over the frequency band of operation shall not exceed 250 mW.

For the 5.25–5.725 GHz bands, the maximum conducted output power over the frequency bands of operation shall not exceed the lesser of 250 mW or $11 \text{ dBm} + 10 \log B$, where B is the 26 dB emission bandwidth in megahertz.

For Straddle Channel, U-NII procedures and limits were applied for operations in the frequency band in accordance with FCC KDB 644545 D03.

If transmitting antennas of directional gain greater than 6 dBi are used, the peak output power shall be reduced by the amount in dB that the directional gain of the antenna exceeds 6 dBi.

Note that U-NII-2 band, devices with a maximum e.i.r.p. greater than 500 mW shall implement TPC in order to have the capability to operate at least 6 dB below the maximum permitted e.i.r.p. of 1 W.

3.2.2 Measuring Instruments

The measuring equipment is listed in the section 4 of this test report.

3.2.3 Test Procedures

The testing follows Method PM of FCC KDB 789033 D02 General UNII Test Procedures New Rules v01r03.

Method PM (Measurement using an RF average power meter):

1. Measurement is performed using a wideband RF power meter.
2. The EUT is configured to transmit continuously with a consistent duty cycle at its maximum power control level.
3. Measure the average power of the transmitter, and the average power is corrected with duty factor, $10 \log(1/x)$, where x is the duty cycle.

For straddle channel, the testing follows Method SA-3 (RMS detection with max hold) of FCC KDB 789033 D02 General UNII Test Procedures New Rules v01r03.

Compute power by integrating the spectrum across the 99% occupied bandwidth of the signal using the instrument's band power measurement function.

3.2.4 Test Setup

For normal channel:

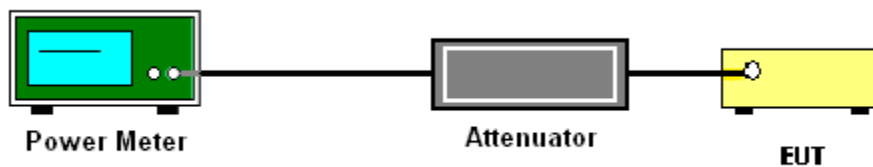

For straddle channel:

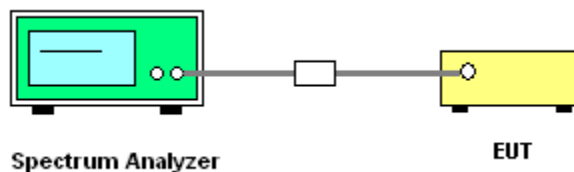



3.2.5 Test Result of Maximum Conducted Output Power

Please refer to Appendix A.

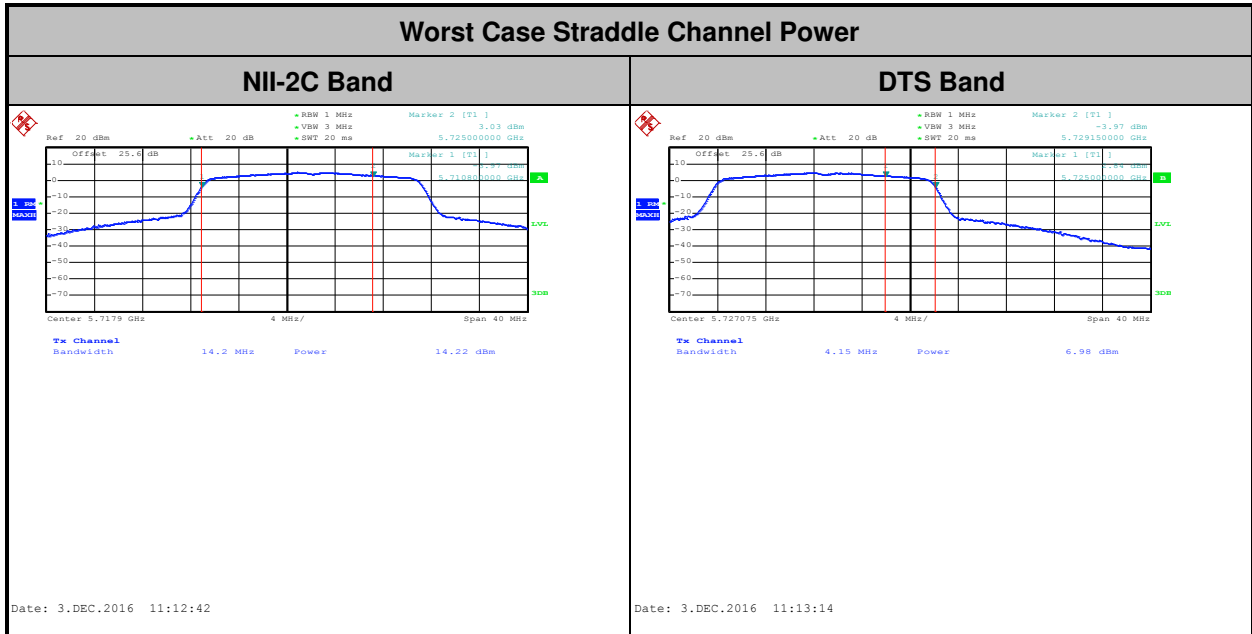



3.3 Power Spectral Density Measurement

3.3.1 Limit of Power Spectral Density

<FCC 14-30 CFR 15.407>

For mobile and portable client devices in the 5.15–5.25 GHz band, the maximum power spectral density shall not exceed 11dBm in any 1 megahertz band.

For the 5.25–5.725 GHz bands, the maximum power spectral density shall not exceed 11 dBm in any 1 megahertz band.

For Straddle Channel, U-NII procedures and limits were applied for operations in the frequency band in accordance with FCC KDB 644545 D03.

If transmitting antennas of directional gain greater than 6 dBi are used, the peak output power shall be reduced by the amount in dB that the directional gain of the antenna exceeds 6 dBi.

3.3.2 Measuring Instruments

The measuring equipment is listed in the section 4 of this test report.

3.3.3 Test Procedures

The testing follows FCC KDB 789033 D02 General UNII Test Procedures New Rules v01r03.
Section F) Maximum power spectral density.

Method SA-2

(trace averaging across on and off times of the EUT transmissions, followed by duty cycle correction).

1. The testing follows Method SA-2 of FCC KDB 789033 D02 General UNII Test Procedures New Rules v01r03.
 - Measure the duty cycle.
 - Set span to encompass the entire emission bandwidth (EBW) of the signal.
 - Set RBW = 1 MHz.
 - Set VBW \geq 3 MHz.
 - Number of points in sweep \geq 2 Span / RBW.
 - Sweep time = auto.
 - Detector = RMS
 - Trace average at least 100 traces in power averaging mode.
 - Add $10 \log(1/x)$, where x is the duty cycle, to the measured power in order to compute the average power during the actual transmission times. For example, add $10 \log(1/0.25) = 6$ dB if the duty cycle is 25 percent.
2. The RF output of EUT was connected to the spectrum analyzer by a low loss cable.
3. Each plot has already offset with cable loss, and attenuator loss. Measure the PPSD and record it.

3.3.4 Test Setup

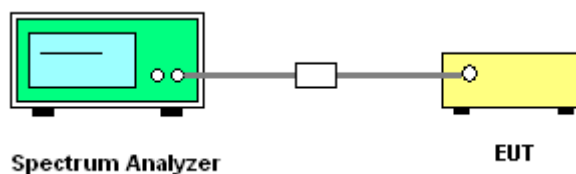



3.3.5 Test Result of Power Spectral Density

Please refer to Appendix A.

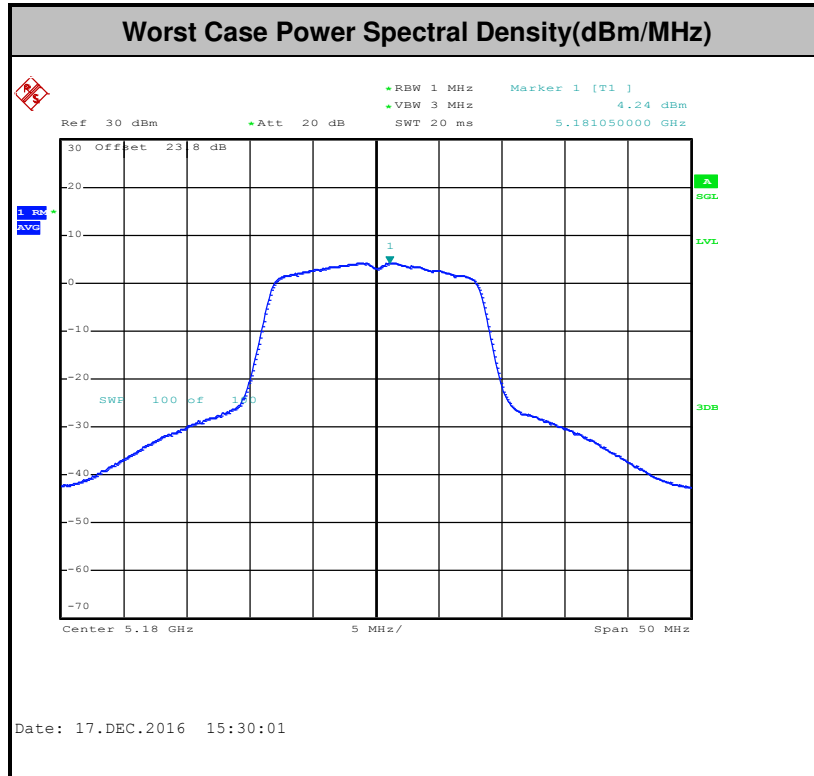

Note: Average Power Density (dB) = Measured value+ Duty Factor



3.4 Unwanted Radiated Emission Measurement

This section as specified in FCC Part 15.407(b) is to measure unwanted emissions through radiated measurement for band edge spurious emissions and out of band emissions measurement. The unwanted emissions shall comply with 15.407(b)(1) to (6), and restricted bands per FCC Part15.205.

3.4.1 Limit of Unwanted Emissions

- (1) For transmitters operating in the 5150-5250 MHz band: all emissions outside of the 5150-5350 MHz band shall not exceed an EIRP of -27dBm/MHz.

For transmitters operating in the 5250-5350 MHz band: all emissions outside of the 5150-5350 MHz band shall not exceed an EIRP of -27 dBm/MHz. Devices operating in the 5250-5350 MHz band that generate emissions in the 5150-5250 MHz band must meet all applicable technical requirements for operation in the 5150-5250 MHz band (including indoor use) or alternatively meet an out-of-band emission EIRP limit of -27 dBm/MHz in the 5150-5250 MHz band.

For transmitters operating in the 5470-5725MHz band: all emissions outside of the 5470-5725MHz band shall not exceed an EIRP of -27 dBm/MHz.

- (2) Unwanted spurious emissions fallen in restricted bands per FCC Part15.205 shall comply with the general field strength limits set forth in § 15.209 as below table,

Frequency (MHz)	Field Strength (microvolts/meter)	Measurement Distance (meters)
0.009 – 0.490	2400/F(kHz)	300
0.490 – 1.705	24000/F(kHz)	30
1.705 – 30.0	30	30
30 – 88	100	3
88 – 216	150	3
216 - 960	200	3
Above 960	500	3

Note: The following formula is used to convert the EIRP to field strength.

$$E = \frac{1000000\sqrt{30P}}{3} \mu V/m, \text{ where } P \text{ is the eirp (Watts)}$$



EIRP (dBm)	Field Strength at 3m (dBµV/m)
-17	78.3
- 27	68.3

(3) KDB789033 D01 v01r03 G)2)c)

- (i) Section 15.407(b)(1-3) specifies the unwanted emissions limit for the U-NII-1 and 2 bands. As specified, emissions above 1000 MHz that are outside of the restricted bands are subject to a peak emission limit of -27 dBm/MHz. However, an out-of-band emission that complies with both the average and peak limits of Section 15.209 is not required to satisfy the -27 dBm/MHz dBm/MHz peak emission limit.
- (ii) Section 15.407(b)(4) specifies the unwanted emissions limit for the U-NII-3 band. A band emissions mask is specified in Section 15.407(b)(4)(i). An alternative to the band emissions mask is specified in Section 15.407(b)(4)(ii). The alternative limits are based on the highest antenna gain specified in the filing. There are also marketing and importation restrictions for the alternative limit

3.4.2 Measuring Instruments

The measuring equipment is listed in the section 4 of this test report.

3.4.3 Test Procedures

1. The testing follows FCC KDB 789033 D02 General UNII Test Procedures New Rules v01r03. Section G) Unwanted emissions measurement.
 - (1) Procedure for Unwanted Emissions Measurements Below 1000MHz
 - RBW = 120 kHz
 - VBW = 300 kHz
 - Detector = Peak
 - Trace mode = max hold
 - (2) Procedure for Peak Unwanted Emissions Measurements Above 1000 MHz
 - RBW = 1 MHz
 - VBW ≥ 3 MHz
 - Detector = Peak
 - Sweep time = auto
 - Trace mode = max hold
 - (3) Procedures for Average Unwanted Emissions Measurements Above 1000MHz
 - RBW = 1 MHz



- VBW = 10 Hz, when duty cycle is no less than 98 percent.
- $VBW \geq 1/T$, when duty cycle is less than 98 percent where T is the minimum transmission duration over which the transmitter is on and is transmitting at its maximum power control level for the tested mode of operation.

2. The EUT was placed on a turntable with 0.8 meter for frequency below 1GHz and 1.5 meter for frequency above 1GHz respectively above ground.
3. The EUT was set 3 meters from the interference receiving antenna which was mounted on the top of a variable height antenna tower.
4. The antenna is a broadband antenna and its height is adjusted between one meter and four meters above ground to find the maximum value of the field strength for both horizontal polarization and vertical polarization of the antenna.
5. For each suspected emission, the EUT was arranged to its worst case and then adjust the antenna tower (from 1 m to 4 m) and turntable (from 0 degree to 360 degrees) to find the maximum reading.
6. For testing below 1GHz, if the emission level of the EUT in peak mode was 3 dB lower than the limit specified, then peak values of EUT will be reported, otherwise, the emissions will be repeated one by one using the CISPR quasi-peak method and reported.
7. For testing above 1GHz, the emission level of the EUT in peak mode was 20dB lower than average limit (that means the emission level in average mode also complies with the limit in average mode), then peak values of EUT will be reported, otherwise, the emissions will be measured in average mode again and reported.

3.4.4 Test Setup

For radiated emissions below 30MHz

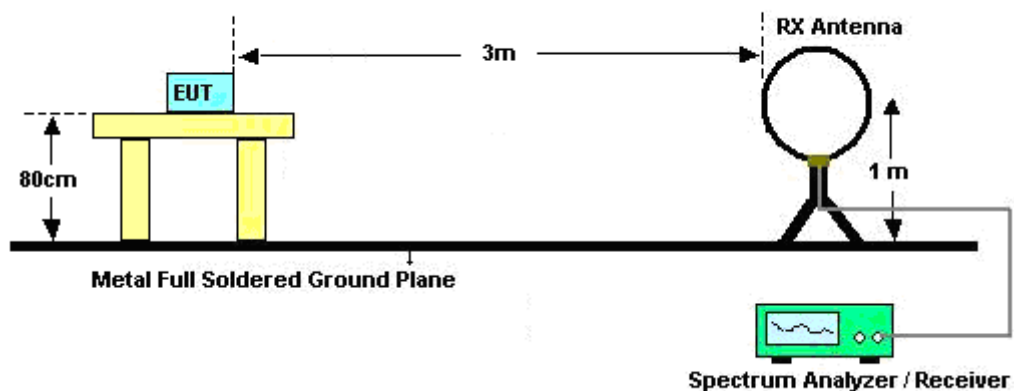

For radiated emissions from 30MHz to 1GHz

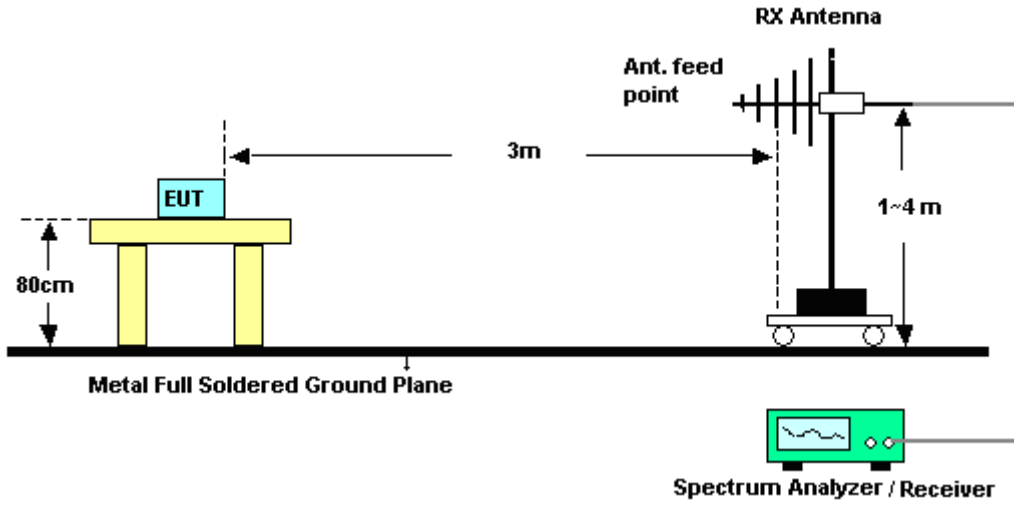

For radiated emissions above 1GHz

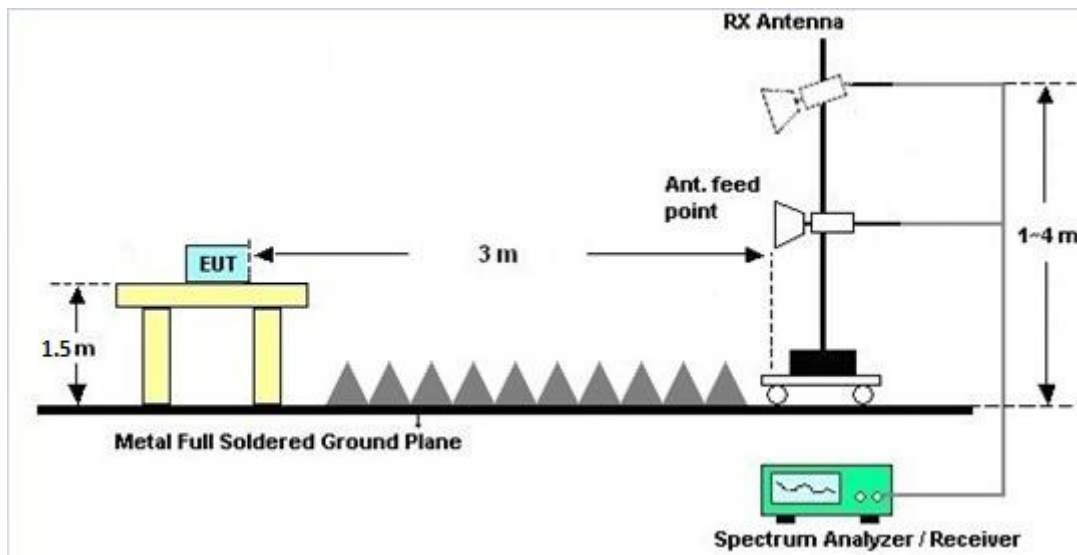



3.4.5 Test Results of Radiated Spurious Emissions (9 kHz ~ 30 MHz)

The low frequency, which started from 9 kHz to 30MHz, was pre-scanned and the result which was 20dB lower than the limit line per 15.31(o) was not reported.

3.4.6 Test Result of Radiated Spurious at Band Edges

Please refer to Appendix B and C.

3.4.7 Duty Cycle

Please refer to Appendix D.

3.4.8 Test Result of Radiated Spurious Emissions (30MHz ~ 10th Harmonic)

Please refer to Appendix B and C.



3.5 AC Conducted Emission Measurement

3.5.1 Limit of AC Conducted Emission

For equipment that is designed to be connected to the public utility (AC) power line, the radio frequency voltage that is conducted back onto the AC power line on any frequency or frequencies within the band 150 kHz to 30 MHz shall not exceed the limits in the following table.

Frequency of emission (MHz)	Conducted limit (dBµV)	
	Quasi-peak	Average
0.15-0.5	66 to 56*	56 to 46*
0.5-5	56	46
5-30	60	50

*Decreases with the logarithm of the frequency.

3.5.2 Measuring Instruments

The measuring equipment is listed in the section 4 of this test report.

3.5.3 Test Procedures

1. The EUT was placed 0.4 meter from the conducting wall of the shielding room was kept at least 80 centimeters from any other grounded conducting surface.
2. Connect EUT to the power mains through a line impedance stabilization network (LISN).
3. All the support units are connecting to the other LISN.
4. The LISN provides 50 ohm coupling impedance for the measuring instrument.
5. The FCC states that a 50 ohm, 50 microhenry LISN should be used.
6. Both sides of AC line were checked for maximum conducted interference.
7. The frequency range from 150 kHz to 30 MHz was searched.
8. Set the test-receiver system to Peak Detect Function and specified bandwidth with Maximum Hold Mode.

3.5.4 Test Setup

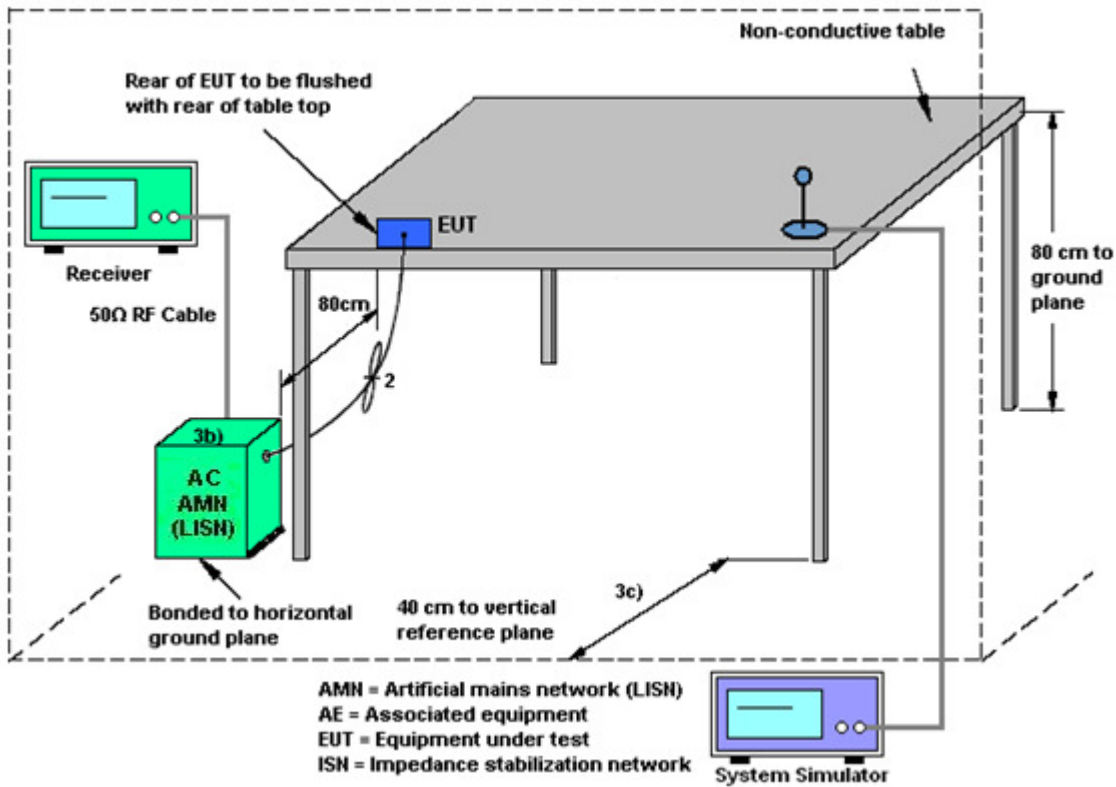



3.5.5 Test Result of AC Conducted Emission

Test Mode :	Mode 1	Temperature :	21~23°C
Test Engineer :	Arthur Hsieh	Relative Humidity :	50~52%
Test Voltage :	120Vac / 60Hz	Phase :	Line
Function Type :	GSM1900 Idle + Bluetooth Link + WLAN (5GHz) Link + Camera (Rear) + Earphone 1 + Battery + USB Cable (Charging from Adapter 3)		

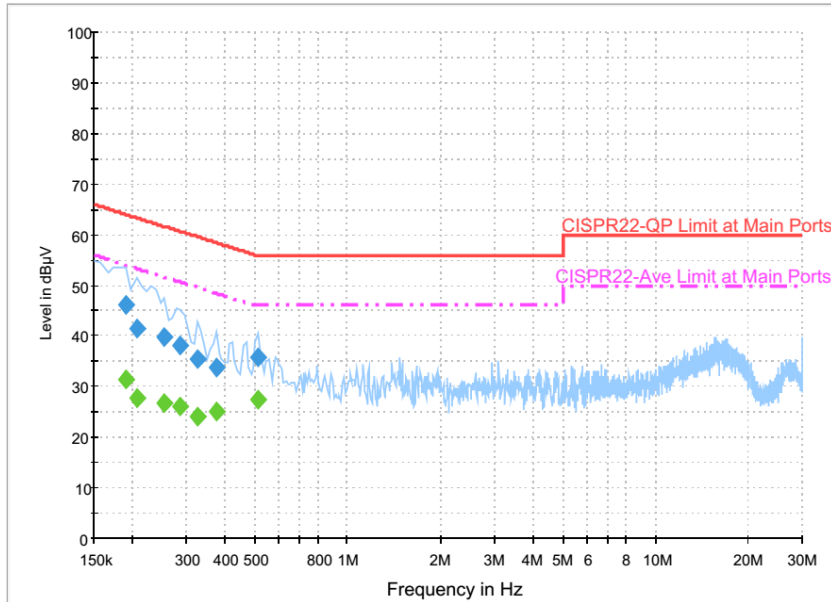

Final Result : QuasiPeak

Frequency (MHz)	QuasiPeak (dBµV)	Filter	Line	Corr. (dB)	Margin (dB)	Limit (dBµV)
0.190000	46.3	Off	L1	19.6	17.7	64.0
0.206000	41.4	Off	L1	19.6	22.0	63.4
0.254000	39.9	Off	L1	19.6	21.7	61.6
0.286000	38.2	Off	L1	19.6	22.4	60.6
0.326000	35.4	Off	L1	19.6	24.2	59.6
0.374000	33.7	Off	L1	19.6	24.7	58.4
0.510000	35.7	Off	L1	19.6	20.3	56.0

Final Result : Average

Frequency (MHz)	Average (dBµV)	Filter	Line	Corr. (dB)	Margin (dB)	Limit (dBµV)
0.190000	31.5	Off	L1	19.6	22.5	54.0
0.206000	27.6	Off	L1	19.6	25.8	53.4
0.254000	26.6	Off	L1	19.6	25.0	51.6
0.286000	25.9	Off	L1	19.6	24.7	50.6
0.326000	24.0	Off	L1	19.6	25.6	49.6
0.374000	25.2	Off	L1	19.6	23.2	48.4
0.510000	27.4	Off	L1	19.6	18.6	46.0



Test Mode :	Mode 1	Temperature :	21~23°C
Test Engineer :	Arthur Hsieh	Relative Humidity :	50~52%
Test Voltage :	120Vac / 60Hz	Phase :	Neutral
Function Type :	GSM1900 Idle + Bluetooth Link + WLAN (5GHz) Link + Camera (Rear) + Earphone 1 + Battery + USB Cable (Charging from Adapter 3)		

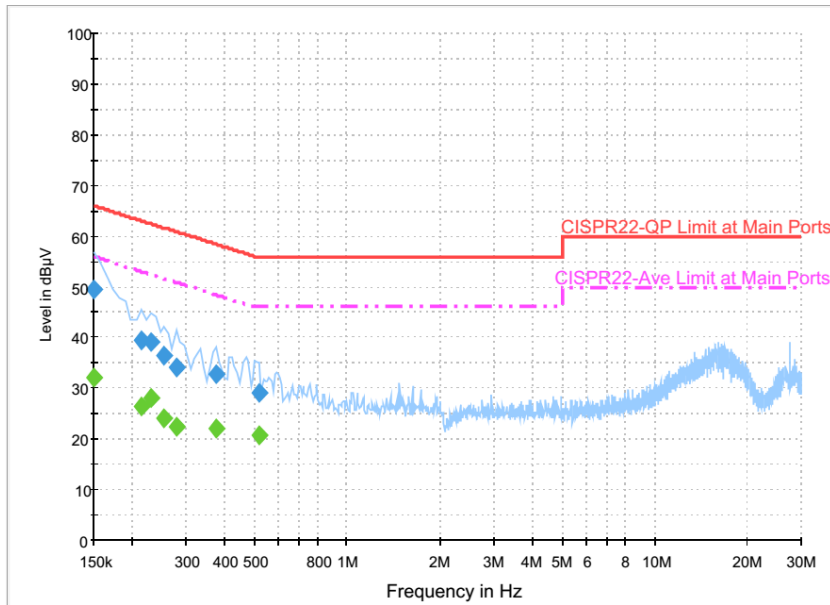

Final Result : QuasiPeak

Frequency (MHz)	QuasiPeak (dBµV)	Filter	Line	Corr. (dB)	Margin (dB)	Limit (dBµV)
0.150000	49.5	Off	N	19.6	16.5	66.0
0.214000	39.6	Off	N	19.6	23.4	63.0
0.230000	39.1	Off	N	19.6	23.3	62.4
0.254000	36.4	Off	N	19.6	25.2	61.6
0.278000	34.0	Off	N	19.6	26.9	60.9
0.374000	32.9	Off	N	19.6	25.5	58.4
0.518000	28.9	Off	N	19.6	27.1	56.0

Final Result : Average

Frequency (MHz)	Average (dBµV)	Filter	Line	Corr. (dB)	Margin (dB)	Limit (dBµV)
0.150000	32.0	Off	N	19.6	24.0	56.0
0.214000	26.5	Off	N	19.6	26.5	53.0
0.230000	28.2	Off	N	19.6	24.2	52.4
0.254000	24.0	Off	N	19.6	27.6	51.6
0.278000	22.4	Off	N	19.6	28.5	50.9
0.374000	22.2	Off	N	19.6	26.2	48.4
0.518000	20.7	Off	N	19.6	25.3	46.0

3.6 Frequency Stability Measurement

3.6.1 Limit of Frequency Stability

Manufacturers of U-NII devices are responsible for ensuring frequency stability such that an emission is maintained within the band of operation under all conditions of normal operation as specified in the user's manual.

3.6.2 Measuring Instruments

The measuring equipment is listed in the section 4 of this test report.

3.6.3 Test Procedures

1. To ensure emission at the band edge is maintained within the authorized band, those values shall be measured by radiation emissions at upper and lower frequency points, and finally compensated by frequency deviation as procedures below.
2. The EUT was operated at the maximum output power, and connected to the spectrum analyzer, which is set to maximum hold function and peak detector. The peak value of the power envelope was measured and noted. The upper and lower frequency points were respectively measured relatively 10dB lower than the measured peak value.
3. The frequency deviation was calculated by adding the upper frequency point and the lower frequency point divided by two. Those detailed values of frequency deviation are provided in table below.

3.6.4 Test Setup



3.6.5 Test Result of Frequency Stability

Please refer to Appendix A.



3.7 Automatically Discontinue Transmission

3.7.1 Limit of Automatically Discontinue Transmission

The device shall automatically discontinue transmission in case of either absence of information to transmit or operational failure. These provisions are not intended to preclude the transmission of control or signaling information or the use of repetitive codes used by certain digital technologies to complete frame or burst intervals. Applicants shall include in their application for equipment authorization to describe how this requirement is met.

3.7.2 Measuring Instruments

The measuring equipment is listed in the section 4 of this test report.

3.7.3 Test Result of Automatically Discontinue Transmission

While the EUT is not transmitting any information, the EUT can automatically discontinue transmission and become standby mode for power saving. The EUT can detect the controlling signal of ACK message transmitting from remote device and verify whether it shall resend or discontinue transmission.



3.8 Antenna Requirements

3.8.1 Standard Applicable

According to FCC 47 CFR Section 15.407(a)(1)(2) ,if transmitting antenna directional gain is greater than 6 dBi, both the peak transmit power and the peak power spectral density shall be reduced by the amount in dB that the directional gain of the antenna exceeds 6 dBi.

3.8.2 Antenna Anti-Replacement Construction

An embedded-in antenna design is used.

3.8.3 Antenna Gain

The antenna gain is less than 6 dBi. Therefore, it is not necessary to reduce maximum peak output power limit.



4 List of Measuring Equipments

Instrument	Manufacturer	Model No.	Serial No.	Characteristics	Calibration Date	Test Date	Due Date	Remark
Spectrum Analyzer	Rohde & Schwarz	FSP40	100055	9kHz-40GHz	Jul. 17, 2016	Dec. 02, 2016 ~ Dec. 27, 2016	Jul. 16, 2017	Conducted (TH05-HY)
Power Meter	Anritsu	ML2495A	0932001	300MHz~40GHz	Sep. 29, 2016	Dec. 02, 2016 ~ Dec. 27, 2016	Sep. 28, 2017	Conducted (TH05-HY)
Power Sensor	Anritsu	MA2411B	0846202	300MHz~40GHz	Sep. 29, 2016	Dec. 02, 2016 ~ Dec. 27, 2016	Sep. 28, 2017	Conducted (TH05-HY)
Hygrometer	Testo	608-H2	41410069	N/A	Aug. 28, 2016	Dec. 02, 2016 ~ Dec. 27, 2016	Aug. 27, 2017	Conducted (TH05-HY)
RF Cable	HUBER + SUHNER	SUCOFLEX 104	MY84209521	1GHz~26GHz	Dec. 02, 2016	Dec. 02, 2016 ~ Dec. 27, 2016	Dec. 01, 2017	Conducted (TH05-HY)
Temperature Chamber	ESPEC	SH-641	92013720	-40℃ ~90℃	Sep. 01, 2016	Dec. 02, 2016 ~ Dec. 27, 2016	Aug. 31, 2017	Conducted (TH05-HY)
AC Power Source	ChainTek	APC-1000W	N/A	N/A	N/A	Dec. 06, 2016	N/A	Conduction (CO05-HY)
EMI Test Receiver	Rohde & Schwarz	ESCI 7	100724	9kHz~7GHz	Aug. 30, 2016	Dec. 06, 2016	Aug. 29, 2017	Conduction (CO05-HY)
Hygrometer	Testo	608-H1	34913912	N/A	Apr. 19, 2016	Dec. 06, 2016	Apr. 18, 2017	Conduction (CO05-HY)
LISN	Rohde & Schwarz	ENV216	100080	9kHz~30MHz	Nov. 28, 2016	Dec. 06, 2016	Nov. 27, 2017	Conduction (CO05-HY)
LF Cable	HUBER + SUHNER	RG-214/U	LF01	N/A	Jan. 06, 2016	Dec. 06, 2016	Jan. 05, 2017	Conduction (CO05-HY)
Test Software	N/A	EMC32	8.40.0	N/A	N/A	Dec. 06, 2016	N/A	Conduction (CO05-HY)
Loop Antenna	Rohde & Schwarz	HFH2-Z2	100315	9 kHz~30 MHz	Sep. 02, 2015	Dec. 13, 2016 ~ Jan. 25, 2017	Sep. 01, 2017	Radiation (03CH11-HY)
Bilog Antenna	TESEQ	CBL 6111D	35414	30MHz~1GHz	Oct. 15, 2016	Dec. 13, 2016 ~ Jan. 25, 2017	Oct. 14, 2017	Radiation (03CH11-HY)
Horn Antenna	SCHWARZBECK	BBHA 9120 D	9120D-1522	1GHz ~ 18GHz	Mar. 30, 2016	Dec. 13, 2016 ~ Jan. 25, 2017	Mar. 31, 2017	Radiation (03CH11-HY)
SHF-EHF Horn Antenna	SCHWARZBECK	BBHA 9170	BBHA9170584	18GHz- 40GHz	Nov. 08, 2016	Dec. 13, 2016 ~ Jan. 25, 2017	Nov. 07, 2017	Radiation (03CH11-HY)
Spectrum Analyzer	Keysight	N9010A	MY52350276	10Hz ~ 44GHZ	Mar. 21, 2016	Dec. 13, 2016 ~ Jan. 25, 2017	Mar. 20, 2017	Radiation (03CH11-HY)
Amplifier	SONOMA	310N	187312	9kHz~1GHz	Nov. 10, 2016	Dec. 13, 2016 ~ Jan. 25, 2017	Nov. 09, 2017	Radiation (03CH11-HY)
Preamplifier	Keysight	83017A	MY53270080	1GHz~26.5GHz	Nov. 10, 2016	Dec. 13, 2016 ~ Jan. 25, 2017	Nov. 09, 2017	Radiation (03CH11-HY)
Preamplifier	MITEQ	TTA0204	1872107	2GHz~40GHz	Feb. 15, 2016	Dec. 13, 2016 ~ Jan. 25, 2017	Feb. 14, 2017	Radiation (03CH11-HY)



Instrument	Manufacturer	Model No.	Serial No.	Characteristics	Calibration Date	Test Date	Due Date	Remark
Hygrometer	TECPEL	DTN-303B	TP140325	N/A	Nov. 11, 2016	Dec. 13, 2016 ~ Jan. 25, 2017	Nov. 13, 2017	Radiation (03CH11-HY)
RF Cable	HUBER + SUHNER	SUCOFLEX 104	MY9837/4 MY28419/4M Y28654/4	9KHz~40GHz	Sep. 12, 2016	Dec. 13, 2016 ~ Jan. 25, 2017	Sep. 11, 2017	Radiation (03CH11-HY)
Controller	EMEC	EM 1000	N/A	Control Turn table & Ant Mast	N/A	Dec. 13, 2016 ~ Jan. 25, 2017	N/A	Radiation (03CH11-HY)
Antenna Mast	EMEC	AM-BS-4500-B	N/A	1~4m	N/A	Dec. 13, 2016 ~ Jan. 25, 2017	N/A	Radiation (03CH11-HY)
Turn Table	EMEC	TT 2000	N/A	0~360 Degree	N/A	Dec. 13, 2016 ~ Jan. 25, 2017	N/A	Radiation (03CH11-HY)
Test Software	Audix	E3	6.2009-8-24	N/A	N/A	Dec. 13, 2016 ~ Jan. 25, 2017	N/A	Radiation (03CH11-HY)
Filter	Wainwright	WLKX12-2700 -3000-18000-6 0SS	SN3	2.7G High Pass	Sep. 19, 2016	Dec. 13, 2016 ~ Jan. 25, 2017	Sep. 18, 2017	Radiation (03CH11-HY)
Filter	Wainwright	WLK10-4630-5 093-11000-40 SS	SN1	4.5G High Pass	Sep. 19, 2016	Dec. 13, 2016 ~ Jan. 25, 2017	Sep. 18, 2017	Radiation (03CH11-HY)



5 Uncertainty of Evaluation

Uncertainty of Conducted Emission Measurement (150kHz ~ 30MHz)

Measuring Uncertainty for a Level of Confidence of 95% ($U = 2Uc(y)$)	2.70
---	------

Uncertainty of Radiated Emission Measurement (30 MHz ~ 1000 MHz)

Measuring Uncertainty for a Level of Confidence of 95% ($U = 2Uc(y)$)	5.20
---	------

Uncertainty of Radiated Emission Measurement (1000 MHz ~ 18000 MHz)

Measuring Uncertainty for a Level of Confidence of 95% ($U = 2Uc(y)$)	5.50
---	------

Uncertainty of Radiated Emission Measurement (18000 MHz ~ 40000 MHz)

Measuring Uncertainty for a Level of Confidence of 95% ($U = 2Uc(y)$)	5.20
---	------

Appendix A. Conducted Test Results

Test Engineer:	Kai Liao / Derek Hsu	Temperature:	21~25	°C
Test Date:	2016/12/2 ~ 2016/12/22	Relative Humidity:	51~54	%

TEST RESULTS DATA
26dB and 99% OBW

Band I										
Mod.	Data Rate	NTX	CH.	Freq. (MHz)	99% Bandwidth (MHz)	26 dB Bandwidth (MHz)	IC 99% Bandwidth Power Limit (dBm)	IC 99% Bandwidth EIRP Limit (dBm)		
11a	6Mbps	1	36	5180	17.40	27.51	-	22.41		
11a	6Mbps	1	44	5220	17.40	27.51	-	22.41		
11a	6Mbps	1	48	5240	17.80	27.82	-	22.50		
HT20	MCS0	1	36	5180	18.35	32.24	-	22.64		
HT20	MCS0	1	44	5220	18.35	30.81	-	22.64		
HT20	MCS0	1	48	5240	18.25	31.34	-	22.61		
HT40	MCS0	1	38	5190	36.70	41.34	-	23.01		
HT40	MCS0	1	46	5230	36.60	41.04	-	23.01		

TEST RESULTS DATA
Average Power Table

FCC Band I										
Mod.	Data Rate	NTX	CH.	Freq. (MHz)	Duty Factor (dB)	Average Conducted Power (dBm)	FCC Conducted Power Limit (dBm)	DG (dBi)		Pass/Fail
11a	6Mbps	1	36	5180	0.10	14.98	24.00	-0.70		Pass
11a	6Mbps	1	44	5220	0.10	14.70	24.00	-0.70		Pass
11a	6Mbps	1	48	5240	0.10	14.63	24.00	-0.70		Pass
HT20	MCS0	1	36	5180	0.13	14.90	24.00	-0.70		Pass
HT20	MCS0	1	44	5220	0.13	14.81	24.00	-0.70		Pass
HT20	MCS0	1	48	5240	0.13	14.74	24.00	-0.70		Pass
HT40	MCS0	1	38	5190	0.25	10.69	24.00	-0.70		Pass
HT40	MCS0	1	46	5230	0.25	10.53	24.00	-0.70		Pass

TEST RESULTS DATA
Power Spectral Density

FCC Band I										
Mod.	Data Rate	NTX	CH.	Freq. (MHz)	Duty Factor (dB)	Average Power Density (dBm/MHz)	Average PSD Limit (dBm/MHz)	DG (dBi)	-	Pass/Fail
11a	6Mbps	1	36	5180	0.10	4.34	11.00	-0.70		Pass
11a	6Mbps	1	44	5220	0.10	3.48	11.00	-0.70		Pass
11a	6Mbps	1	48	5240	0.10	3.49	11.00	-0.70		Pass
HT20	MCS0	1	36	5180	0.13	3.88	11.00	-0.70		Pass
HT20	MCS0	1	44	5220	0.13	3.54	11.00	-0.70		Pass
HT20	MCS0	1	48	5240	0.13	3.56	11.00	-0.70		Pass
HT40	MCS0	1	38	5190	0.25	-3.90	11.00	-0.70		Pass
HT40	MCS0	1	46	5230	0.25	-2.96	11.00	-0.70		Pass

TEST RESULTS DATA
26dB and 99% OBW

Band II										
Mod.	Data Rate	NTX	CH.	Freq. (MHz)	99% Bandwidth (MHz)	26 dB Bandwidth (MHz)	IC 99% Bandwidth Power Limit (dBm)	IC 99% Bandwidth EIRP Limit (dBm)	FCC 26dB Bandwidth Power Limit (dBm)	Note
11a	6M bps	1	52	5260	17.30	27.66	23.38	29.38	23.98	
11a	6M bps	1	60	5300	17.35	27.83	23.39	29.39	23.98	
11a	6M bps	1	64	5320	17.50	25.42	23.43	29.43	23.98	
HT20	MCS 0	1	52	5260	18.25	28.32	23.61	29.61	23.98	
HT20	MCS 0	1	60	5300	18.15	30.03	23.59	29.59	23.98	
HT20	MCS 0	1	64	5320	18.25	31.25	23.61	29.61	23.98	
HT40	MCS 0	1	54	5270	36.60	41.13	23.98	30.00	23.98	
HT40	MCS 0	1	62	5310	36.60	41.28	23.98	30.00	23.98	

TEST RESULTS DATA
Average Power Table

FCC Band II										
Mod.	Data Rate	NTX	CH.	Freq. (MHz)	Duty Factor (dB)	Average Conducted Power (dBm)	FCC Conducted Power Limit (dBm)	DG (dBi)	EIRP Power Limit (dBm)	Pass/Fail
11a	6M bps	1	52	5260	0.10	14.96	23.98	-0.20	26.99	Pass
11a	6M bps	1	60	5300	0.10	14.94	23.98	-0.20	26.99	Pass
11a	6M bps	1	64	5320	0.10	14.90	23.98	-0.20	26.99	Pass
HT20	MCS 0	1	52	5260	0.13	14.83	23.98	-0.20	26.99	Pass
HT20	MCS 0	1	60	5300	0.13	14.81	23.98	-0.20	26.99	Pass
HT20	MCS 0	1	64	5320	0.13	14.86	23.98	-0.20	26.99	Pass
HT40	MCS 0	1	54	5270	0.25	10.56	23.98	-0.20	26.99	Pass
HT40	MCS 0	1	62	5310	0.25	10.80	23.98	-0.20	26.99	Pass

TEST RESULTS DATA
Power Spectral Density

Band II										
Mod.	Data Rate	NTX	CH.	Freq. (MHz)	Duty Factor (dB)	Average Power Density (dBm/MHz)	Average PSD Limit (dBm/MHz)	DG (dBi)		Pass/Fail
11a	6M bps	1	52	5260	0.10	2.94	11.00	-0.20		Pass
11a	6M bps	1	60	5300	0.10	3.06	11.00	-0.20		Pass
11a	6M bps	1	64	5320	0.10	2.96	11.00	-0.20		Pass
HT20	MCS 0	1	52	5260	0.13	3.15	11.00	-0.20		Pass
HT20	MCS 0	1	60	5300	0.13	3.00	11.00	-0.20		Pass
HT20	MCS 0	1	64	5320	0.13	2.90	11.00	-0.20		Pass
HT40	MCS 0	1	54	5270	0.25	-3.78	11.00	-0.20		Pass
HT40	MCS 0	1	62	5310	0.25	-4.59	11.00	-0.20		Pass

TEST RESULTS DATA
26dB and 99% OBW

Band III										
Mod.	Data Rate	NTX	CH.	Freq. (MHz)	99% Bandwidth (MHz)	26 dB Bandwidth (MHz)	IC 99% Bandwidth Power Limit (dBm)	IC 99% Bandwidth EIRP Limit (dBm)	FCC 26dB Bandwidth Power Limit (dBm)	Note
11a	6M bps	1	100	5500	17.40	30.23	23.41	29.41	23.98	
11a	6M bps	1	116	5580	17.45	29.64	23.42	29.42	23.98	
11a	6M bps	1	140	5700	17.50	28.11	23.43	29.43	23.98	
HT20	MCS 0	1	100	5500	18.30	31.47	23.62	29.62	23.98	
HT20	MCS 0	1	116	5580	18.30	30.05	23.62	29.62	23.98	
HT20	MCS 0	1	140	5700	18.25	30.33	23.61	29.61	23.98	
HT40	MCS 0	1	102	5510	36.60	41.40	23.98	30.00	23.98	
HT40	MCS 0	1	110	5550	36.50	41.55	23.98	30.00	23.98	
HT40	MCS 0	1	134	5670	36.60	41.19	23.98	30.00	23.98	

TEST RESULTS DATA
Average Power Table

FCC Band III										
Mod.	Data Rate	NTX	CH.	Freq. (MHz)	Duty Factor (dB)	Average Conducted Power (dBm)	FCC Conducted Power Limit (dBm)	DG (dBi)	EIRP Power Limit (dBm)	Pass/Fail
11a	6M bps	1	100	5500	0.10	14.90	23.98	-0.30	26.99	Pass
11a	6M bps	1	116	5580	0.10	14.76	23.98	-0.30	26.99	Pass
11a	6M bps	1	140	5700	0.10	14.81	23.98	-0.30	26.99	Pass
HT20	MCS 0	1	100	5500	0.13	14.98	23.98	-0.30	26.99	Pass
HT20	MCS 0	1	116	5580	0.13	14.65	23.98	-0.30	26.99	Pass
HT20	MCS 0	1	140	5700	0.13	14.85	23.98	-0.30	26.99	Pass
HT40	MCS 0	1	102	5510	0.25	10.66	23.98	-0.30	26.99	Pass
HT40	MCS 0	1	110	5550	0.25	10.65	23.98	-0.30	26.99	Pass
HT40	MCS 0	1	134	5670	0.25	10.51	23.98	-0.30	26.99	Pass

TEST RESULTS DATA
Power Spectral Density

Band III										
Mod.	Data Rate	NTX	CH.	Freq. (MHz)	Duty Factor (dB)	Average Power Density (dBm/MHz)	Average PSD Limit (dBm/MHz)	DG (dBi)		Pass/Fail
11a	6M bps	1	100	5500	0.10	3.58	11.00	-0.30		Pass
11a	6M bps	1	116	5580	0.10	4.23	11.00	-0.30		Pass
11a	6M bps	1	140	5700	0.10	2.83	11.00	-0.30		Pass
HT20	MCS 0	1	100	5500	0.13	3.49	11.00	-0.30		Pass
HT20	MCS 0	1	116	5580	0.13	3.72	11.00	-0.30		Pass
HT20	MCS 0	1	140	5700	0.13	2.62	11.00	-0.30		Pass
HT40	MCS 0	1	102	5510	0.25	-3.06	11.00	-0.30		Pass
HT40	MCS 0	1	110	5550	0.25	-2.64	11.00	-0.30		Pass
HT40	MCS 0	1	134	5670	0.25	-3.47	11.00	-0.30		Pass

TEST RESULTS DATA
26dB and 99% OBW

Straddle Channel										
Mod.	Data Rate	NTX	CH.	Freq. (MHz)	99% Bandwidth (MHz)	26dB Emission Bandwidth (MHz)	IC 99% Bandwidth Power Limit (dBm)	IC 99% Bandwidth EIRP Limit (dBm)	FCC 26dB Bandwidth Power Limit (dBm)	6dB Emission Bandwidth (MHz)
11a	6Mbps	1	144	5720	17.35	32.01	-	-	-	15.42
				NII-2C	13.7	21.305	22.37	28.37	23.98	12.86
				NII-3	3.65	10.7	30.00	36.02	-	2.56
HT20	MCS0	1	144	5720	18.35	34.78	-	-	-	15.06
				NII-2C	14.2	23.405	22.52	28.52	23.98	12.54
				NII-3	4.15	11.38	30.00	36.02	-	2.52
HT40	MCS0	1	142	5710	36.20	41.19	-	-	-	36.04
				NII-2C	33.2	35.58	23.98	30.00	23.98	33.12
				NII-3	3	5.61	30.00	36.02	-	2.92

TEST RESULTS DATA
Average Power Table

FCC Straddle Channel										
Mod.	Data Rate	NTX	CH.	Freq. (MHz)	Duty Factor (dB)	Average Conducted Power (dBm)	FCC Conducted Power Limit (dBm)	DG (dBi)		Pass/Fail
11a	6Mbps	1	144	5720	0.10	14.95	-	-0.30		Pass
				NII-2C	0.10	14.27	23.98	-0.30	Pass	
				NII-3	0.10	6.58	30.00	-0.30	Pass	
HT20	MCS0	1	144	5720	0.13	14.97	-	-0.30		Pass
				NII-2C	0.13	14.22	23.98	-0.30	Pass	
				NII-3	0.13	6.98	30.00	-0.30	Pass	
HT40	MCS0	1	142	5710	0.25	10.51	-	-0.30		Pass
				NII-2C	0.25	10.19	23.98	-0.30	Pass	
				NII-3	0.25	-1.03	30.00	-0.30	Pass	

TEST RESULTS DATA
Power Spectral Density

Straddle Channel										
Mod.	Data Rate	NTX	CH.	Freq. (MHz)	Duty Factor (dB)	Average Power Density (dBm/MHz)	Average PSD Limit (dBm/MHz)	DG (dBi)		Pass/Fail
11a	6Mbps	1	144	NII-2C	0.10	3.81	11.00	-0.30		Pass
				NII-3	0.10	3.81	30.00	-0.30		Pass
HT20	MCS0	1	144	NII-2C	0.13	3.80	11.00	-0.30		Pass
				NII-3	0.13	3.80	30.00	-0.30		Pass
HT40	MCS0	1	142	NII-2C	0.25	-3.38	11.00	-0.30		Pass
				NII-3	0.25	-3.38	30.00	-0.30		Pass

TEST RESULTS DATA
Frequency Stability

Band I										
Mod.	Data Rate	NTX	CH.	Freq. (MHz)	Center Frequency (MHz)	Frequency Deviation (MHz)	Frequency Stability (ppm)	Temperature (°C)	Voltage (V)	Note
11a	6Mbps	1	36	5180	5180.000	0.000	0.00	50	3.8	
11a	6Mbps	1	36	5180	5179.950	-0.050	-9.65	-30	3.8	
11a	6Mbps	1	36	5180	5180.025	0.025	4.83	20	4.35	
11a	6Mbps	1	36	5180	5180.025	0.025	4.83	20	3.4	
11a	6Mbps	1	36	5180	5180.000	0.000	0.00	20	3.8	

Band II										
Mod.	Data Rate	NTX	CH.	Freq. (MHz)	Center Frequency (MHz)	Frequency Deviation (MHz)	Frequency Stability (ppm)	Temperature (°C)	Voltage (V)	Note
11a	6Mbps	1	64	5320	5320.000	0.000	0.00	50	3.8	
11a	6Mbps	1	64	5320	5320.000	0.000	0.00	-30	3.8	
11a	6Mbps	1	64	5320	5320.000	0.000	0.00	20	4.35	
11a	6Mbps	1	64	5320	5320.000	0.000	0.00	20	3.4	
11a	6Mbps	1	64	5320	5320.050	0.050	9.40	20	3.8	

Band III										
Mod.	Data Rate	NTX	CH.	Freq. (MHz)	Center Frequency (MHz)	Frequency Deviation (MHz)	Frequency Stability (ppm)	Temperature (°C)	Voltage (V)	Note
11a	6Mbps	1	100	5500	5500.000	0.000	0.00	50	3.8	
11a	6Mbps	1	100	5500	5500.000	0.000	0.00	-30	3.8	
11a	6Mbps	1	100	5500	5500.000	0.000	0.00	20	4.35	
11a	6Mbps	1	100	5500	5500.000	0.000	0.00	20	3.4	
11a	6Mbps	1	100	5500	5500.000	0.000	0.00	20	3.8	



Appendix B. Radiated Spurious Emission

Test Engineer :	J.C. Liang, Nick Yu, and Ken Wu	Temperature :	20~23°C
		Relative Humidity :	58~63%

Band 1 - 5150~5250MHz

WIFI 802.11a (Band Edge @ 3m)

WIFI Ant. 1	Note	Frequency (MHz)	Level (dBμV/m)	Over Limit (dB)	Limit Line (dBμV/m)	Read Level (dBμV)	Antenna Factor (dB/m)	Cable Loss (dB)	Preamp Factor (dB)	Ant Pos (cm)	Table Pos (deg)	Peak Avg. (P/A)	Pol. (H/V)	
802.11a CH 36 5180MHz		5117	51.34	-22.66	74	41.03	32.16	11.19	33.04	239	63	P	H	
		5147.42	43.6	-10.4	54	33.24	32.21	11.18	33.03	239	63	A	H	
	*	5180	102.36	-	-	91.95	32.26	11.18	33.03	239	63	P	H	
	*	5180	94.32	-	-	83.91	32.26	11.18	33.03	239	63	A	H	
													H	
													H	
			5150	53.5	-20.5	74	43.14	32.21	11.18	33.03	100	301	P	V
			5147.42	46.5	-7.5	54	36.14	32.21	11.18	33.03	100	301	A	V
	*		5180	106.52	-	-	96.11	32.26	11.18	33.03	100	301	P	V
	*		5180	98.52	-	-	88.11	32.26	11.18	33.03	100	301	A	V
													V	
													V	
802.11a CH 44 5220MHz		5089.18	51.44	-22.56	74	41.13	32.14	11.21	33.04	235	62	P	H	
		5147.42	42.62	-11.38	54	32.26	32.21	11.18	33.03	235	62	A	H	
	*	5220	100.39	-	-	89.95	32.3	11.17	33.03	235	62	P	H	
	*	5220	93.29	-	-	82.85	32.3	11.17	33.03	235	62	A	H	
			5389.92	50.46	-23.54	74	39.63	32.54	11.31	33.02	235	62	P	H
			5454.24	41.73	-12.27	54	30.78	32.63	11.34	33.02	235	62	A	H
			5136.76	52	-22	74	41.65	32.19	11.19	33.03	100	298	P	V
			5140.14	44.79	-9.21	54	34.43	32.21	11.18	33.03	100	298	A	V
	*		5220	105.58	-	-	95.14	32.3	11.17	33.03	100	298	P	V
	*		5220	97.45	-	-	87.01	32.3	11.17	33.03	100	298	A	V
			5375.76	50.03	-23.97	74	39.26	32.51	11.28	33.02	100	298	P	V
			5372.88	41.73	-12.27	54	30.97	32.51	11.28	33.03	100	298	A	V



802.11a CH 48 5240MHz		5014.04	50.74	-23.26	74	40.52	32.02	11.24	33.04	239	68	P	H
		5082.94	42.7	-11.3	54	32.41	32.12	11.21	33.04	239	68	A	H
	*	5240	101.36	-	-	90.87	32.33	11.19	33.03	239	68	P	H
	*	5240	93.49	-	-	83	32.33	11.19	33.03	239	68	A	H
		5366.16	50.9	-23.1	74	40.14	32.51	11.28	33.03	239	68	P	H
		5454.24	41.85	-12.15	54	30.9	32.63	11.34	33.02	239	68	A	H
		5127.92	52.19	-21.81	74	41.84	32.19	11.19	33.03	100	301	P	V
		5142.22	43.81	-10.19	54	33.45	32.21	11.18	33.03	100	301	A	V
	*	5240	105.26	-	-	94.77	32.33	11.19	33.03	100	301	P	V
	*	5240	97.89	-	-	87.4	32.33	11.19	33.03	100	301	A	V
		5450.4	50.3	-23.7	74	39.35	32.63	11.34	33.02	100	301	P	V
		5361.6	41.9	-12.1	54	31.14	32.51	11.28	33.03	100	301	A	V
Remark	1. No other spurious found. 2. All results are PASS against Peak and Average limit line.												



Band 1 5150~5250MHz

WIFI 802.11a (Harmonic @ 3m)

WIFI Ant. 1	Note	Frequency (MHz)	Level (dBμV/m)	Over Limit (dB)	Limit Line (dBμV/m)	Read Level (dBμV)	Antenna Factor (dB/m)	Cable Loss (dB)	Preamp Factor (dB)	Ant Pos (cm)	Table Pos (deg)	Peak Avg. (P/A)	Pol. (H/V)
802.11a CH 36 5180MHz		10360	41.91	-32.09	74	38.13	39.84	15.02	51.08	100	0	P	H
		15540	41.24	-32.76	74	36.67	38.21	18.16	51.8	100	0	P	H
													H
													H
		10360	42.01	-31.99	74	38.23	39.84	15.02	51.08	100	0	P	V
		15540	44.75	-29.25	74	40.18	38.21	18.16	51.8	100	0	P	V
													V
													V
802.11a CH 44 5220MHz		10440	40.63	-33.37	74	36.79	39.92	15.08	51.16	100	0	P	H
		15660	45.82	-28.18	74	41.16	38.23	18.23	51.8	100	0	P	H
													H
													H
		10440	40.93	-33.07	74	37.09	39.92	15.08	51.16	100	0	P	V
		15660	48.33	-25.67	74	43.67	38.23	18.23	51.8	100	0	P	V
													V
													V
802.11a CH 48 5240MHz		10480	40.62	-33.38	74	36.73	39.98	15.11	51.2	100	0	P	H
		15720	46.61	-27.39	74	41.89	38.24	18.28	51.8	100	0	P	H
													H
													H
		10480	41.89	-32.11	74	38	39.98	15.11	51.2	100	0	P	V
		15720	48.3	-25.7	74	43.58	38.24	18.28	51.8	100	0	P	V
													V
													V
Remark	1. No other spurious found. 2. All results are PASS against Peak and Average limit line.												



Band 1 5150~5250MHz
WIFI 802.11n HT20 (Band Edge @ 3m)

WIFI Ant. 1	Note	Frequency (MHz)	Level (dBμV/m)	Over Limit (dB)	Limit Line (dBμV/m)	Read Level (dBμV)	Antenna Factor (dB/m)	Cable Loss (dB)	Preamp Factor (dB)	Ant Pos (cm)	Table Pos (deg)	Peak Avg. (P/A)	Pol. (H/V)	
802.11n HT20 CH 36 5180MHz		5148.72	51.75	-22.25	74	41.39	32.21	11.18	33.03	239	65	P	H	
		5150	44.28	-9.72	54	33.92	32.21	11.18	33.03	239	65	A	H	
	*	5180	103.1	-	-	92.69	32.26	11.18	33.03	239	65	P	H	
	*	5180	95.84	-	-	85.43	32.26	11.18	33.03	239	65	A	H	
													H	
														H
			5118.3	52.37	-21.63	74	42.05	32.16	11.19	33.03	105	239	P	V
			5150	45.46	-8.54	54	35.1	32.21	11.18	33.03	105	239	A	V
		*	5180	104.97	-	-	94.56	32.26	11.18	33.03	105	239	P	V
		*	5180	97.63	-	-	87.22	32.26	11.18	33.03	105	239	A	V
													V	
													V	
802.11n HT20 CH 44 5220MHz		5128.96	51.53	-22.47	74	41.18	32.19	11.19	33.03	236	64	P	H	
		5139.88	43.39	-10.61	54	33.02	32.21	11.19	33.03	236	64	A	H	
	*	5220	103.28	-	-	92.84	32.3	11.17	33.03	236	64	P	H	
	*	5220	96.17	-	-	85.73	32.3	11.17	33.03	236	64	A	H	
			5362.8	50.96	-23.04	74	40.2	32.51	11.28	33.03	236	64	P	H
			5459.52	42	-12	54	31.05	32.63	11.34	33.02	236	64	A	H
			5105.56	52.12	-21.88	74	41.81	32.16	11.19	33.04	120	242	P	V
			5139.88	44.65	-9.35	54	34.28	32.21	11.19	33.03	120	242	A	V
		*	5220	105.4	-	-	94.96	32.3	11.17	33.03	120	242	P	V
		*	5220	98.26	-	-	87.82	32.3	11.17	33.03	120	242	A	V
		5398.32	50.39	-23.61	74	39.54	32.56	11.31	33.02	120	242	P	V	
		5395.2	41.93	-12.07	54	31.08	32.56	11.31	33.02	120	242	A	V	



802.11n HT20 CH 48 5240MHz		5105.56	52.57	-21.43	74	42.26	32.16	11.19	33.04	251	62	P	H
		5098.8	42.77	-11.23	54	32.46	32.14	11.21	33.04	251	62	A	H
	*	5240	103.03	-	-	92.54	32.33	11.19	33.03	251	62	P	H
	*	5240	95.65	-	-	85.16	32.33	11.19	33.03	251	62	A	H
		5394.72	50.79	-23.21	74	39.94	32.56	11.31	33.02	251	62	P	H
		5438.64	41.89	-12.11	54	30.96	32.61	11.34	33.02	251	62	A	H
		5048.88	51.55	-22.45	74	41.3	32.07	11.22	33.04	107	302	P	V
		5085.8	43.22	-10.78	54	32.93	32.12	11.21	33.04	107	302	A	V
	*	5240	106.03	-	-	95.54	32.33	11.19	33.03	107	302	P	V
	*	5240	98.05	-	-	87.56	32.33	11.19	33.03	107	302	A	V
		5353.92	50.63	-23.37	74	39.89	32.49	11.28	33.03	107	302	P	V
		5452.8	41.93	-12.07	54	30.98	32.63	11.34	33.02	107	302	A	V
Remark	<p>1. No other spurious found.</p> <p>2. All results are PASS against Peak and Average limit line.</p>												



Band 1 5150~5250MHz

WIFI 802.11n HT20 (Harmonic @ 3m)

WIFI Ant. 1	Note	Frequency (MHz)	Level (dBμV/m)	Over Limit (dB)	Limit Line (dBμV/m)	Read Level (dBμV)	Antenna Factor (dB/m)	Cable Loss (dB)	Preamp Factor (dB)	Ant Pos (cm)	Table Pos (deg)	Peak Avg. (P/A)	Pol. (H/V)	
802.11n HT20 CH 36 5180MHz		10360	41.57	-32.43	74	37.79	39.84	15.02	51.08	100	0	P	H	
		15540	40.95	-33.05	74	36.38	38.21	18.16	51.8	100	0	P	H	
													H	
													H	
			10360	40.74	-33.26	74	36.96	39.84	15.02	51.08	100	0	P	V
			15540	44.6	-29.4	74	40.03	38.21	18.16	51.8	100	0	P	V
														V
802.11n HT20 CH 44 5220MHz		10440	40.64	-33.36	74	36.8	39.92	15.08	51.16	100	0	P	H	
		15660	44.03	-29.97	74	39.37	38.23	18.23	51.8	100	0	P	H	
													H	
													H	
			10440	42.08	-31.92	74	38.24	39.92	15.08	51.16	100	0	P	V
			15660	46.52	-27.48	74	41.86	38.23	18.23	51.8	100	0	P	V
														V
802.11n HT20 CH 48 5240MHz		10480	40.13	-33.87	74	36.24	39.98	15.11	51.2	100	0	P	H	
		15720	45.08	-28.92	74	40.36	38.24	18.28	51.8	100	0	P	H	
													H	
													H	
			10480	41.72	-32.28	74	37.83	39.98	15.11	51.2	100	0	P	V
			15720	47.72	-26.28	74	43	38.24	18.28	51.8	100	0	P	V
														V
Remark	1. No other spurious found.													
	2. All results are PASS against Peak and Average limit line.													



Band 1 5150~5250MHz

WIFI 802.11n HT40 (Band Edge @ 3m)

WIFI Ant. 1	Note	Frequency (MHz)	Level (dBμV/m)	Over Limit (dB)	Limit Line (dBμV/m)	Read Level (dBμV)	Antenna Factor (dB/m)	Cable Loss (dB)	Preamp Factor (dB)	Ant Pos (cm)	Table Pos (deg)	Peak Avg. (P/A)	Pol. (H/V)	
802.11n HT40 CH 38 5190MHz		5145.08	55.97	-18.03	74	45.61	32.21	11.18	33.03	238	65	P	H	
		5149.76	49.54	-4.46	54	39.18	32.21	11.18	33.03	238	65	A	H	
	*	5190	97.33	-	-	86.93	32.26	11.17	33.03	238	65	P	H	
	*	5190	90.2	-	-	79.8	32.26	11.17	33.03	238	65	A	H	
		5356.32	49.77	-24.23	74	39.03	32.49	11.28	33.03	238	65	P	H	
		5458.8	42.36	-11.64	54	31.41	32.63	11.34	33.02	238	65	A	H	
		5146.12	57.39	-16.61	74	47.03	32.21	11.18	33.03	132	253	P	V	
		5148.72	50.86	-3.14	54	40.5	32.21	11.18	33.03	132	253	A	V	
	*	5190	98.78	-	-	88.38	32.26	11.17	33.03	132	253	P	V	
	*	5190	92.14	-	-	81.74	32.26	11.17	33.03	132	253	A	V	
		5384.88	50.32	-23.68	74	39.49	32.54	11.31	33.02	132	253	P	V	
		5457.6	42.71	-11.29	54	31.76	32.63	11.34	33.02	132	253	A	V	
	802.11n HT40 CH 46 5230MHz		5089.18	50.91	-23.09	74	40.6	32.14	11.21	33.04	100	75	P	H
			5062.4	43.06	-10.94	54	32.8	32.09	11.21	33.04	100	75	A	H
*		5230	93.65	-	-	83.16	32.33	11.19	33.03	100	75	P	H	
*		5230	85.43	-	-	74.94	32.33	11.19	33.03	100	75	A	H	
		5383.2	50.46	-23.54	74	39.63	32.54	11.31	33.02	100	75	P	H	
		5445.12	42.01	-11.99	54	31.08	32.61	11.34	33.02	100	75	A	H	
		5025.74	50.53	-23.47	74	40.3	32.05	11.22	33.04	100	135	P	V	
		5078.78	43.51	-10.49	54	33.22	32.12	11.21	33.04	100	135	A	V	
*		5230	97.11	-	-	86.62	32.33	11.19	33.03	100	135	P	V	
*		5230	88.66	-	-	78.17	32.33	11.19	33.03	100	135	A	V	
	5422.56	50.43	-23.57	74	39.53	32.58	11.34	33.02	100	135	P	V		
	5459.76	42.32	-11.68	54	31.37	32.63	11.34	33.02	100	135	A	V		
Remark	1. No other spurious found. 2. All results are PASS against Peak and Average limit line.													



Band 1 5150~5250MHz

WIFI 802.11n HT40 (Harmonic @ 3m)

WIFI Ant. 1	Note	Frequency (MHz)	Level (dBμV/m)	Over Limit (dB)	Limit Line (dBμV/m)	Read Level (dBμV)	Antenna Factor (dB/m)	Cable Loss (dB)	Preamp Factor (dB)	Ant Pos (cm)	Table Pos (deg)	Peak Avg. (P/A)	Pol. (H/V)
802.11n HT40 CH 38 5190MHz		10380	41.55	-32.45	74	37.79	39.86	15.02	51.12	100	0	P	H
		15570	40.95	-33.05	74	36.35	38.21	18.19	51.8	100	0	P	H
													H
													H
		10380	41.55	-32.45	74	37.79	39.86	15.02	51.12	100	0	P	V
		15570	41.86	-32.14	74	37.26	38.21	18.19	51.8	100	0	P	V
													V
													V
802.11n HT40 CH 46 5230MHz		10460	39.17	-34.83	74	35.35	39.94	15.08	51.2	100	0	P	H
		15690	40.74	-33.26	74	36.04	38.24	18.26	51.8	100	0	P	H
													H
													H
		10460	40.39	-33.61	74	36.57	39.94	15.08	51.2	100	0	P	V
		15690	39.24	-34.76	74	34.54	38.24	18.26	51.8	100	0	P	V
													V
													V
Remark	1. No other spurious found. 2. All results are PASS against Peak and Average limit line.												



Band 2 - 5250~5350MHz

WIFI 802.11a (Band Edge @ 3m)

WIFI	Note	Frequency	Level	Over	Limit	Read	Antenna	Cable	Preamp	Ant	Table	Peak	Pol.
Ant.				Limit	Line	Level	Factor	Loss	Factor	Pos	Pos	Avg.	
1		(MHz)	(dBμV/m)	(dB)	(dBμV/m)	(dBμV)	(dB/m)	(dB)	(dB)	(cm)	(deg)	(P/A)	(H/V)
802.11a CH 52 5260MHz		5104.52	50.95	-23.05	74	40.66	32.14	11.19	33.04	227	64	P	H
		5067.86	42.72	-11.28	54	32.46	32.09	11.21	33.04	227	64	A	H
	*	5260	103.07	-	-	92.54	32.37	11.19	33.03	227	64	P	H
	*	5260	95.48	-	-	84.95	32.37	11.19	33.03	227	64	A	H
		5420.64	51.67	-22.33	74	40.77	32.58	11.34	33.02	227	64	P	H
		5412.48	42.1	-11.9	54	31.23	32.58	11.31	33.02	227	64	A	H
		5001.82	51.47	-22.53	74	41.27	32	11.24	33.04	100	300	P	V
		5106.86	43.05	-10.95	54	32.74	32.16	11.19	33.04	100	300	A	V
	*	5260	104.18	-	-	93.65	32.37	11.19	33.03	100	300	P	V
	*	5260	97.05	-	-	86.52	32.37	11.19	33.03	100	300	A	V
		5376	50.34	-23.66	74	39.57	32.51	11.28	33.02	100	300	P	V
		5352.24	42.31	-11.69	54	31.57	32.49	11.28	33.03	100	300	A	V
802.11a CH 60 5300MHz		5043.42	51.47	-22.53	74	41.22	32.07	11.22	33.04	225	65	P	H
		5080.08	42.6	-11.4	54	32.31	32.12	11.21	33.04	225	65	A	H
	*	5300	104.8	-	-	94.19	32.42	11.22	33.03	225	65	P	H
	*	5300	96.43	-	-	85.82	32.42	11.22	33.03	225	65	A	H
		5355.36	51.43	-22.57	74	40.69	32.49	11.28	33.03	225	65	P	H
		5379.84	43.08	-10.92	54	32.28	32.54	11.28	33.02	225	65	A	H
		5119.34	51.12	-22.88	74	40.8	32.16	11.19	33.03	100	299	P	V
		5099.32	42.49	-11.51	54	32.18	32.14	11.21	33.04	100	299	A	V
	*	5300	104.55	-	-	93.94	32.42	11.22	33.03	100	299	P	V
	*	5300	97.73	-	-	87.12	32.42	11.22	33.03	100	299	A	V
		5387.04	51.97	-22.03	74	41.14	32.54	11.31	33.02	100	299	P	V
		5354.08	43.42	-10.58	54	32.68	32.49	11.28	33.03	100	299	A	V



802.11a CH 64 5320MHz	*	5320	104.31	-	-	93.65	32.44	11.25	33.03	317	70	P	H
	*	5320	97.27	-	-	86.61	32.44	11.25	33.03	317	70	A	H
		5350.08	53.81	-20.19	74	43.07	32.49	11.28	33.03	317	70	P	H
		5350.88	44.64	-9.36	54	33.9	32.49	11.28	33.03	317	70	A	H
													H
													H
	*	5320	105.46	-	-	94.8	32.44	11.25	33.03	100	282	P	V
	*	5320	98.5	-	-	87.84	32.44	11.25	33.03	100	282	A	V
		5353.6	52.61	-21.39	74	41.87	32.49	11.28	33.03	100	282	P	V
		5350.56	45.32	-8.68	54	34.58	32.49	11.28	33.03	100	282	A	V
													V
													V
Remark	1. No other spurious found. 2. All results are PASS against Peak and Average limit line.												



Band 2 5250~5350MHz

WIFI 802.11a (Harmonic @ 3m)

WIFI Ant. 1	Note	Frequency (MHz)	Level (dBμV/m)	Over Limit (dB)	Limit Line (dBμV/m)	Read Level (dBμV)	Antenna Factor (dB/m)	Cable Loss (dB)	Preamp Factor (dB)	Ant Pos (cm)	Table Pos (deg)	Peak Avg. (P/A)	Pol. (H/V)
802.11a CH 52 5260MHz		10520	39.69	-34.31	74	35.81	39.99	15.13	51.24	100	0	P	H
		15780	51.02	-22.98	74	46.26	38.26	18.3	51.8	213	172	P	H
		15780	41.14	-12.86	54	36.38	38.26	18.3	51.8	213	172	A	H
													H
		10520	39.86	-34.14	74	35.98	39.99	15.13	51.24	100	0	P	V
		15780	52.48	-21.52	74	47.72	38.26	18.3	51.8	200	339	P	V
		15780	42.54	-11.46	54	37.78	38.26	18.3	51.8	200	339	A	V
802.11a CH 60 5300MHz		10600	39.03	-34.97	74	35.13	39.92	15.19	51.21	100	0	P	H
		15900	54.14	-19.86	74	49.29	38.28	18.37	51.8	208	193	P	H
		15900	42.83	-11.17	54	37.98	38.28	18.37	51.8	208	193	A	H
													H
		10600	39.83	-34.17	74	35.93	39.92	15.19	51.21	100	0	P	V
		15900	55.53	-18.47	74	50.68	38.28	18.37	51.8	200	341	P	V
		15900	44.7	-9.3	54	39.85	38.28	18.37	51.8	200	341	A	V
802.11a CH 64 5320MHz		10640	42.05	-31.95	74	38.13	39.89	15.22	51.19	100	0	P	H
		15960	55.88	-18.12	74	50.97	38.29	18.42	51.8	197	171	P	H
		15960	45.8	-8.2	54	40.89	38.29	18.42	51.8	197	171	A	H
													H
		10640	45.21	-28.79	74	41.29	39.89	15.22	51.19	100	0	P	V
		15960	55.59	-18.41	74	50.68	38.29	18.42	51.8	200	340	P	V
		15960	45.36	-8.64	54	40.45	38.29	18.42	51.8	200	340	A	V
Remark	1. No other spurious found. 2. All results are PASS against Peak and Average limit line.												



Band 2 5250~5350MHz

WIFI 802.11n HT20 (Band Edge @ 3m)

WIFI Ant. 1	Note	Frequency (MHz)	Level (dBμV/m)	Over Limit (dB)	Limit Line (dBμV/m)	Read Level (dBμV)	Antenna Factor (dB/m)	Cable Loss (dB)	Preamp Factor (dB)	Ant Pos (cm)	Table Pos (deg)	Peak Avg. (P/A)	Pol. (H/V)
802.11n HT20 CH 52 5260MHz		5083.46	51.51	-22.49	74	41.22	32.12	11.21	33.04	228	66	P	H
		5099.06	42.69	-11.31	54	32.38	32.14	11.21	33.04	228	66	A	H
	*	5260	105.65	-	-	95.12	32.37	11.19	33.03	228	66	P	H
	*	5260	97.92	-	-	87.39	32.37	11.19	33.03	228	66	A	H
		5387.76	50.09	-23.91	74	39.26	32.54	11.31	33.02	228	66	P	H
		5355.6	42.32	-11.68	54	31.58	32.49	11.28	33.03	228	66	A	H
		5119.08	51.16	-22.84	74	40.84	32.16	11.19	33.03	100	298	P	V
		5106.86	43.18	-10.82	54	32.87	32.16	11.19	33.04	100	298	A	V
	*	5260	106.37	-	-	95.84	32.37	11.19	33.03	100	298	P	V
	*	5260	99.41	-	-	88.88	32.37	11.19	33.03	100	298	A	V
		5445.6	50.18	-23.82	74	39.23	32.63	11.34	33.02	100	298	P	V
		5351.04	42.52	-11.48	54	31.78	32.49	11.28	33.03	100	298	A	V
802.11n HT20 CH 60 5300MHz		5033.54	50.94	-23.06	74	40.71	32.05	11.22	33.04	227	64	P	H
		5081.12	42.62	-11.38	54	32.33	32.12	11.21	33.04	227	64	A	H
	*	5300	105.22	-	-	94.61	32.42	11.22	33.03	227	64	P	H
	*	5300	98.1	-	-	87.49	32.42	11.22	33.03	227	64	A	H
		5357.04	51.14	-22.86	74	40.4	32.49	11.28	33.03	227	64	P	H
		5351.76	43.56	-10.44	54	32.82	32.49	11.28	33.03	227	64	A	H
		5007.02	51.17	-22.83	74	40.95	32.02	11.24	33.04	100	300	P	V
		5148.46	43.05	-10.95	54	32.69	32.21	11.18	33.03	100	300	A	V
	*	5300	106.36	-	-	95.75	32.42	11.22	33.03	100	300	P	V
	*	5300	99.52	-	-	88.91	32.42	11.22	33.03	100	300	A	V
	5361.84	51.37	-22.63	74	40.61	32.51	11.28	33.03	100	300	P	V	
	5350.08	44.27	-9.73	54	33.53	32.49	11.28	33.03	100	300	A	V	



802.11n HT20 CH 64 5320MHz	*	5320	105.52	-	-	94.86	32.44	11.25	33.03	239	64	P	H
	*	5320	98.19	-	-	87.53	32.44	11.25	33.03	239	64	A	H
		5350.24	54.01	-19.99	74	43.27	32.49	11.28	33.03	239	64	P	H
		5350.08	45.76	-8.24	54	35.02	32.49	11.28	33.03	239	64	A	H
													H
													H
	*	5320	106.03	-	-	95.37	32.44	11.25	33.03	100	301	P	V
	*	5320	98.95	-	-	88.29	32.44	11.25	33.03	100	301	A	V
		5350.24	54.72	-19.28	74	43.98	32.49	11.28	33.03	100	301	P	V
		5350.08	46.35	-7.65	54	35.61	32.49	11.28	33.03	100	301	A	V
													V
													V
Remark	1. No other spurious found. 2. All results are PASS against Peak and Average limit line.												



Band 2 5250~5350MHz

WIFI 802.11n HT20 (Harmonic @ 3m)

WIFI Ant. 1	Note	Frequency (MHz)	Level (dBμV/m)	Over Limit (dB)	Limit Line (dBμV/m)	Read Level (dBμV)	Antenna Factor (dB/m)	Cable Loss (dB)	Preamp Factor (dB)	Ant Pos (cm)	Table Pos (deg)	Peak Avg. (P/A)	Pol. (H/V)	
802.11n HT20 CH 52 5260MHz		10520	40.69	-33.31	74	36.81	39.99	15.13	51.24	100	0	P	H	
		15780	49.27	-24.73	74	44.51	38.26	18.3	51.8	100	0	P	H	
													H	
													H	
			10520	40.66	-33.34	74	36.78	39.99	15.13	51.24	100	0	P	V
			15780	54.06	-19.94	74	49.3	38.26	18.3	51.8	200	339	P	V
			15780	43.67	-10.33	54	38.91	38.26	18.3	51.8	200	339	A	V
													V	
802.11n HT20 CH 60 5300MHz		10600	41.61	-32.39	74	37.71	39.92	15.19	51.21	100	0	P	H	
		15900	50.68	-23.32	74	45.83	38.28	18.37	51.8	100	0	P	H	
													H	
													H	
			10600	40.32	-33.68	74	36.42	39.92	15.19	51.21	100	0	P	V
			15900	55.77	-18.23	74	50.92	38.28	18.37	51.8	200	340	P	V
			15900	45.36	-8.64	54	40.51	38.28	18.37	51.8	200	340	A	V
													V	
802.11n HT20 CH 64 5320MHz		10640	39.75	-34.25	74	35.83	39.89	15.22	51.19	100	0	P	H	
		15960	50.79	-23.21	74	45.88	38.29	18.42	51.8	100	0	P	H	
													H	
													H	
			10640	40.9	-33.1	74	36.98	39.89	15.22	51.19	100	0	P	V
			15960	56.48	-17.52	74	51.57	38.29	18.42	51.8	201	339	P	V
			15960	44.56	-9.44	54	39.65	38.29	18.42	51.8	201	339	A	V
													V	
Remark	1. No other spurious found. 2. All results are PASS against Peak and Average limit line.													



Band 2 5250~5350MHz

WIFI 802.11n HT40 (Band Edge @ 3m)

WIFI Ant. 1	Note	Frequency (MHz)	Level (dBμV/m)	Over Limit (dB)	Limit Line (dBμV/m)	Read Level (dBμV)	Antenna Factor (dB/m)	Cable Loss (dB)	Preamp Factor (dB)	Ant Pos (cm)	Table Pos (deg)	Peak Avg. (P/A)	Pol. (H/V)
802.11n HT40 CH 54 5270MHz		5073.84	51.17	-22.83	74	40.88	32.12	11.21	33.04	230	64	P	H
		5095.94	43.36	-10.64	54	33.05	32.14	11.21	33.04	230	64	A	H
	*	5270	95.08	-	-	84.52	32.37	11.22	33.03	230	64	P	H
	*	5270	87.13	-	-	76.57	32.37	11.22	33.03	230	64	A	H
		5386.8	50.62	-23.38	74	39.79	32.54	11.31	33.02	230	64	P	H
		5447.04	42.24	-11.76	54	31.29	32.63	11.34	33.02	230	64	A	H
		5036.66	50.64	-23.36	74	40.41	32.05	11.22	33.04	100	307	P	V
		5028.86	43.13	-10.87	54	32.9	32.05	11.22	33.04	100	307	A	V
	*	5270	96.96	-	-	86.4	32.37	11.22	33.03	100	307	P	V
	*	5270	88.67	-	-	78.11	32.37	11.22	33.03	100	307	A	V
		5393.04	50.2	-23.8	74	39.37	32.54	11.31	33.02	100	307	P	V
		5441.28	42.18	-11.82	54	31.25	32.61	11.34	33.02	100	307	A	V
802.11n HT40 CH 62 5310MHz		5015.6	51.13	-22.87	74	40.91	32.02	11.24	33.04	239	64	P	H
		5104.52	43.35	-10.65	54	33.06	32.14	11.19	33.04	239	64	A	H
	*	5310	97.69	-	-	87.03	32.44	11.25	33.03	239	64	P	H
	*	5310	90.35	-	-	79.69	32.44	11.25	33.03	239	64	A	H
		5350.08	58.48	-15.52	74	47.74	32.49	11.28	33.03	239	64	P	H
		5350.08	49.15	-4.85	54	38.41	32.49	11.28	33.03	239	64	A	H
		5095.42	50.62	-23.38	74	40.31	32.14	11.21	33.04	108	245	P	V
		5089.18	43.38	-10.62	54	33.07	32.14	11.21	33.04	108	245	A	V
	*	5310	98.87	-	-	88.21	32.44	11.25	33.03	108	245	P	V
	*	5310	91.73	-	-	81.07	32.44	11.25	33.03	108	245	A	V
	5350.8	56.18	-17.82	74	45.44	32.49	11.28	33.03	108	245	P	V	
	5350.8	50.26	-3.74	54	39.52	32.49	11.28	33.03	108	245	P	V	
Remark	1. No other spurious found. 2. All results are PASS against Peak and Average limit line.												



Band 2 5250~5350MHz

WIFI 802.11n HT40 (Harmonic @ 3m)

WIFI Ant. 1	Note	Frequency (MHz)	Level (dBμV/m)	Over Limit (dB)	Limit Line (dBμV/m)	Read Level (dBμV)	Antenna Factor (dB/m)	Cable Loss (dB)	Preamp Factor (dB)	Ant Pos (cm)	Table Pos (deg)	Peak Avg. (P/A)	Pol. (H/V)	
802.11n HT40 CH 54 5270MHz		10540	39.53	-34.47	74	35.65	39.97	15.13	51.22	100	0	P	H	
		15810	40.78	-33.22	74	35.99	38.26	18.33	51.8	100	0	P	H	
													H	
													H	
			10540	39.11	-34.89	74	35.23	39.97	15.13	51.22	100	0	P	V
			15810	39.99	-34.01	74	35.2	38.26	18.33	51.8	100	0	P	V
														V
802.11n HT40 CH 62 5310MHz		10620	40.58	-33.42	74	36.68	39.9	15.19	51.19	100	0	P	H	
		15930	45.48	-28.52	74	40.59	38.29	18.4	51.8	100	0	P	H	
													H	
													H	
			10620	39.59	-34.41	74	35.69	39.9	15.19	51.19	100	0	P	V
			15930	45.99	-28.01	74	41.1	38.29	18.4	51.8	100	0	P	V
														V
Remark	1. No other spurious found.													
	2. All results are PASS against Peak and Average limit line.													



Band 3 - 5470~5725MHz

WIFI 802.11a (Band Edge @ 3m)

WIFI	Note	Frequency	Level	Over	Limit	Read	Antenna	Cable	Preamp	Ant	Table	Peak	Pol.	
Ant.				Limit	Line	Level	Factor	Loss	Factor	Pos	Pos	Avg.		
1		(MHz)	(dBμV/m)	(dB)	(dBμV/m)	(dBμV)	(dB/m)	(dB)	(dB)	(cm)	(deg)	(P/A)	(H/V)	
802.11a CH 100 5500MHz		5461.2	54.12	-19.88	74	43.13	32.63	11.38	33.02	227	68	P	H	
		5469.52	46.68	-7.32	54	35.67	32.65	11.38	33.02	227	68	A	H	
	*	5500	105.34	-	-	94.28	32.7	11.38	33.02	227	68	P	H	
	*	5500	98.17	-	-	87.11	32.7	11.38	33.02	227	68	A	H	
													H	
														H
			5451.44	53.57	-20.43	74	42.62	32.63	11.34	33.02	100	243	P	V
			5469.2	45.42	-8.58	54	34.41	32.65	11.38	33.02	100	243	A	V
	*		5500	105.26	-	-	94.2	32.7	11.38	33.02	100	243	P	V
	*		5500	97.24	-	-	86.18	32.7	11.38	33.02	100	243	A	V
														V
														V
802.11a CH 116 5580MHz		5350	51	-23	74	40.26	32.49	11.28	33.03	221	69	P	H	
		5464.96	42.59	-11.41	54	31.58	32.65	11.38	33.02	221	69	A	H	
	*	5580	104.96	-	-	93.79	32.8	11.44	33.07	221	69	P	H	
	*	5580	96.53	-	-	85.36	32.8	11.44	33.07	221	69	A	H	
			5736.125	50.97	-23.03	74	39.62	33.04	11.46	33.15	221	69	P	H
			5733.325	42.8	-11.2	54	31.48	33.01	11.46	33.15	221	69	A	H
			5425.6	50.59	-23.41	74	39.69	32.58	11.34	33.02	100	247	P	V
			5467.6	42.48	-11.52	54	31.47	32.65	11.38	33.02	100	247	A	V
	*		5580	104.88	-	-	93.71	32.8	11.44	33.07	100	247	P	V
	*		5580	97.1	-	-	85.93	32.8	11.44	33.07	100	247	A	V
			5738.05	50.87	-23.13	74	39.52	33.04	11.46	33.15	100	247	P	V
			5732.275	42.78	-11.22	54	31.46	33.01	11.46	33.15	100	247	A	V



802.11a CH 140 5700MHz	*	5700	106.06	-	-	94.74	32.97	11.47	33.12	268	189	P	H
	*	5700	98.25	-	-	86.93	32.97	11.47	33.12	268	189	A	H
		5725.88	56.12	-17.88	74	44.78	33.01	11.46	33.13	268	189	P	H
		5725	46.72	-7.28	54	35.38	33.01	11.46	33.13	268	189	A	H
													H
													H
	*	5700	103.78	-	-	92.46	32.97	11.47	33.12	117	201	P	V
	*	5700	96.47	-	-	85.15	32.97	11.47	33.12	117	201	A	V
		5757.24	54.3	-19.7	74	42.94	33.06	11.46	33.16	117	201	P	V
		5725.08	45.41	-8.59	54	34.07	33.01	11.46	33.13	117	201	A	V
													V
													V
Remark	1. No other spurious found. 2. All results are PASS against Peak and Average limit line.												



Band 3 - 5470~5725MHz
WIFI 802.11a (Harmonic @ 3m)

WIFI Ant. 1	Note	Frequency (MHz)	Level (dBμV/m)	Over Limit (dB)	Limit Line (dBμV/m)	Read Level (dBμV)	Antenna Factor (dB/m)	Cable Loss (dB)	Preamp Factor (dB)	Ant Pos (cm)	Table Pos (deg)	Peak Avg. (P/A)	Pol. (H/V)	
802.11a CH 100 5500MHz		11000	43.82	-30.18	74	39.76	39.6	15.49	51.03	100	0	P	H	
		16500	60.32	-13.68	74	53.72	39.2	19.27	51.87	200	172	P	H	
		16500	50.45	-3.55	54	43.85	39.2	19.27	51.87	200	172	A	H	
													H	
			11000	44	-30	74	39.94	39.6	15.49	51.03	100	0	P	V
			16500	56.81	-17.19	74	50.21	39.2	19.27	51.87	209	358	P	V
			16500	46.52	-7.48	54	39.92	39.2	19.27	51.87	209	358	A	V
802.11a CH 116 5580MHz		11160	45.64	-28.36	74	41.69	39.43	15.61	51.09	100	0	P	H	
		16740	59.63	-14.37	74	51.31	40.55	19.68	51.91	199	175	P	H	
		16740	49.39	-4.61	54	41.07	40.55	19.68	51.91	199	175	A	H	
													H	
			11160	47.28	-26.72	74	43.33	39.43	15.61	51.09	100	0	P	V
			16740	54.22	-19.78	74	45.9	40.55	19.68	51.91	203	358	P	V
			16740	43.39	-10.61	54	35.07	40.55	19.68	51.91	203	358	A	V
802.11a CH 140 5700MHz		11400	46.1	-27.9	74	42.3	39.2	15.79	51.19	100	0	P	H	
		17100	60.03	-13.97	74	49.34	42.36	20.3	51.97	200	179	P	H	
		17100	49.57	-4.43	54	38.88	42.36	20.3	51.97	200	179	A	H	
													H	
			11400	47.78	-26.22	74	43.98	39.2	15.79	51.19	100	0	P	V
			17100	57.37	-16.63	74	46.68	42.36	20.3	51.97	184	349	P	V
			17100	46.28	-7.72	54	35.59	42.36	20.3	51.97	184	349	A	V
													V	
Remark	1. No other spurious found. 2. All results are PASS against Peak and Average limit line.													



Band 3 - 5470~5725MHz
WIFI 802.11n HT20 (Band Edge @ 3m)

WIFI Ant. 1	Note	Frequency (MHz)	Level (dBμV/m)	Over Limit (dB)	Limit Line (dBμV/m)	Read Level (dBμV)	Antenna Factor (dB/m)	Cable Loss (dB)	Preamp Factor (dB)	Ant Pos (cm)	Table Pos (deg)	Peak Avg. (P/A)	Pol. (H/V)	
802.11n HT20 CH 100 5500MHz		5468.56	54.13	-19.87	74	43.12	32.65	11.38	33.02	228	68	P	H	
		5469.84	46.49	-7.51	54	35.48	32.65	11.38	33.02	228	68	A	H	
	*	5500	104.89	-	-	93.83	32.7	11.38	33.02	228	68	P	H	
	*	5500	97.78	-	-	86.72	32.7	11.38	33.02	228	68	A	H	
													H	
														H
			5459.6	55.26	-18.74	74	44.31	32.63	11.34	33.02	100	244	P	V
			5470	45.79	-8.21	54	34.78	32.65	11.38	33.02	100	244	A	V
		*	5500	105.31	-	-	94.25	32.7	11.38	33.02	100	244	P	V
		*	5500	97.69	-	-	86.63	32.7	11.38	33.02	100	244	A	V
													V	
													V	
802.11n HT20 CH 116 5580MHz		5439.52	51.31	-22.69	74	40.38	32.61	11.34	33.02	219	70	P	H	
		5467.84	42.47	-11.53	54	31.46	32.65	11.38	33.02	219	70	A	H	
		* 5580	105.22	-	-	94.05	32.8	11.44	33.07	219	70	P	H	
		* 5580	98.18	-	-	87.01	32.8	11.44	33.07	219	70	A	H	
			5748.2	50.31	-23.69	74	38.96	33.04	11.46	33.15	219	70	P	H
			5731.925	42.79	-11.21	54	31.47	33.01	11.46	33.15	219	70	A	H
			5401.36	50.4	-23.6	74	39.55	32.56	11.31	33.02	100	251	P	V
			5468.56	42.61	-11.39	54	31.6	32.65	11.38	33.02	100	251	A	V
		*	5580	106.05	-	-	94.88	32.8	11.44	33.07	100	251	P	V
		*	5580	98.92	-	-	87.75	32.8	11.44	33.07	100	251	A	V
		5728.25	50.76	-23.24	74	39.42	33.01	11.46	33.13	100	251	P	V	
		5734.2	42.62	-11.38	54	31.3	33.01	11.46	33.15	100	251	A	V	



802.11n HT20 CH 140 5700MHz	*	5700	105.74	-	-	94.42	32.97	11.47	33.12	221	68	P	H
	*	5700	98.39	-	-	87.07	32.97	11.47	33.12	221	68	A	H
		5725.32	57.53	-16.47	74	46.19	33.01	11.46	33.13	221	68	P	H
		5725	47.67	-6.33	54	36.33	33.01	11.46	33.13	221	68	A	H
													H
													H
	*	5700	105.73	-	-	94.41	32.97	11.47	33.12	100	247	P	V
	*	5700	97.92	-	-	86.6	32.97	11.47	33.12	100	247	A	V
		5725.72	57.53	-16.47	74	46.19	33.01	11.46	33.13	100	247	P	V
		5725.56	47.19	-6.81	54	35.85	33.01	11.46	33.13	100	247	A	V
												V	
												V	
Remark	1. No other spurious found. 2. All results are PASS against Peak and Average limit line.												



Band 3 - 5470~5725MHz
WIFI 802.11n HT20 (Harmonic @ 3m)

WIFI Ant. 1	Note	Frequency (MHz)	Level (dBμV/m)	Over Limit (dB)	Limit Line (dBμV/m)	Read Level (dBμV)	Antenna Factor (dB/m)	Cable Loss (dB)	Preamp Factor (dB)	Ant Pos (cm)	Table Pos (deg)	Peak Avg. (P/A)	Pol. (H/V)	
802.11n HT20 CH 100 5500MHz		11000	45.17	-28.83	74	41.11	39.6	15.49	51.03	100	0	P	H	
		16500	59.8	-14.2	74	53.2	39.2	19.27	51.87	200	213	P	H	
		16500	49.71	-4.29	54	43.11	39.2	19.27	51.87	200	213	A	H	
													H	
			11000	44.48	-29.52	74	40.42	39.6	15.49	51.03	100	0	P	V
			16500	55.63	-18.37	74	49.03	39.2	19.27	51.87	200	317	P	V
			16500	45.17	-8.83	54	38.57	39.2	19.27	51.87	200	317	A	V
													V	
802.11n HT20 CH 116 5580MHz		11160	46.23	-27.77	74	42.28	39.43	15.61	51.09	100	0	P	H	
		16740	59.7	-14.3	74	51.38	40.55	19.68	51.91	200	173	P	H	
		16740	48.36	-5.64	54	40.04	40.55	19.68	51.91	200	173	A	H	
													H	
			11160	47.5	-26.5	74	43.55	39.43	15.61	51.09	100	0	P	V
			16740	59.7	-14.3	74	51.38	40.55	19.68	51.91	200	319	P	V
			16740	48.72	-5.28	54	40.4	40.55	19.68	51.91	200	319	A	V
													V	
802.11n HT20 CH 140 5700MHz		11400	46.37	-27.63	74	42.57	39.2	15.79	51.19	100	0	P	H	
		17100	58.02	-15.98	74	47.33	42.36	20.3	51.97	201	173	P	H	
		17100	47.95	-6.05	54	37.26	42.36	20.3	51.97	201	173	A	H	
													H	
			11400	49.37	-24.63	74	45.57	39.2	15.79	51.19	100	0	P	V
			17100	55.8	-18.2	74	45.11	42.36	20.3	51.97	197	314	P	V
			17100	45.26	-8.74	54	34.57	42.36	20.3	51.97	197	314	A	V
													V	
Remark	1. No other spurious found. 2. All results are PASS against Peak and Average limit line.													



Band 3 - 5470~5725MHz
WIFI 802.11n HT40 (Band Edge @ 3m)

WIFI Ant. 1	Note	Frequency (MHz)	Level (dBμV/m)	Over Limit (dB)	Limit Line (dBμV/m)	Read Level (dBμV)	Antenna Factor (dB/m)	Cable Loss (dB)	Preamp Factor (dB)	Ant Pos (cm)	Table Pos (deg)	Peak Avg. (P/A)	Pol. (H/V)
802.11n HT40 CH 102 5510MHz		5469.04	58.7	-15.3	74	47.69	32.65	11.38	33.02	227	66	P	H
		5469.52	50.35	-3.65	54	39.34	32.65	11.38	33.02	227	66	A	H
	*	5510	96.13	-	-	85.05	32.7	11.41	33.03	227	66	P	H
	*	5510	88.11	-	-	77.03	32.7	11.41	33.03	227	66	A	H
		5734.025	51.74	-22.26	74	40.42	33.01	11.46	33.15	227	66	P	H
		5739.625	42.87	-11.13	54	31.52	33.04	11.46	33.15	227	66	A	H
		5468.56	56.39	-17.61	74	45.38	32.65	11.38	33.02	100	299	P	V
		5470	49.53	-4.47	54	38.52	32.65	11.38	33.02	100	299	A	V
	*	5510	95.08	-	-	84	32.7	11.41	33.03	100	299	P	V
	*	5510	87.32	-	-	76.24	32.7	11.41	33.03	100	299	A	V
		5755.55	50.8	-23.2	74	39.43	33.06	11.46	33.15	100	299	P	V
		5734.2	42.82	-11.18	54	31.5	33.01	11.46	33.15	100	299	A	V
802.11n HT40 CH 110 5550MHz		5378.56	50.5	-23.5	74	39.7	32.54	11.28	33.02	221	66	P	H
		5464.72	42.89	-11.11	54	31.88	32.65	11.38	33.02	221	66	A	H
	*	5550	96.74	-	-	85.58	32.77	11.44	33.05	221	66	P	H
	*	5550	88.45	-	-	77.29	32.77	11.44	33.05	221	66	A	H
		5760.275	51.11	-22.89	74	39.75	33.06	11.46	33.16	221	66	P	H
		5747.675	42.94	-11.06	54	31.59	33.04	11.46	33.15	221	66	A	H
		5447.44	51.17	-22.83	74	40.22	32.63	11.34	33.02	100	235	P	V
		5467.36	43.3	-10.7	54	32.29	32.65	11.38	33.02	100	235	A	V
	*	5550	95.89	-	-	84.73	32.77	11.44	33.05	100	235	P	V
	*	5550	87.51	-	-	76.35	32.77	11.44	33.05	100	235	A	V
	5729.65	49.99	-24.01	74	38.65	33.01	11.46	33.13	100	235	P	V	
	5753.625	42.9	-11.1	54	31.53	33.06	11.46	33.15	100	235	A	V	



802.11n HT40 CH 134 5670MHz		5462.56	49.95	-24.05	74	38.94	32.65	11.38	33.02	226	68	P	H
		5468.32	42.37	-11.63	54	31.36	32.65	11.38	33.02	226	68	A	H
	*	5670	96.21	-	-	84.91	32.94	11.47	33.11	226	68	P	H
	*	5670	88.42	-	-	77.12	32.94	11.47	33.11	226	68	A	H
		5742.6	51.04	-22.96	74	39.69	33.04	11.46	33.15	226	68	P	H
		5738.925	43.41	-10.59	54	32.06	33.04	11.46	33.15	226	68	A	H
		5469.52	50.57	-23.43	74	39.56	32.65	11.38	33.02	100	235	P	V
		5464.48	42.32	-11.68	54	31.31	32.65	11.38	33.02	100	235	A	V
	*	5670	96.07	-	-	84.77	32.94	11.47	33.11	100	235	P	V
	*	5670	88.07	-	-	76.77	32.94	11.47	33.11	100	235	A	V
		5732.8	50.66	-23.34	74	39.34	33.01	11.46	33.15	100	235	P	V
		5734.375	43.28	-10.72	54	31.96	33.01	11.46	33.15	100	235	A	V
Remark	1. No other spurious found. 2. All results are PASS against Peak and Average limit line.												



Band 3 - 5470~5725MHz
WIFI 802.11n HT40 (Harmonic @ 3m)

WIFI Ant. 1	Note	Frequency (MHz)	Level (dBμV/m)	Over Limit (dB)	Limit Line (dBμV/m)	Read Level (dBμV)	Antenna Factor (dB/m)	Cable Loss (dB)	Preamp Factor (dB)	Ant Pos (cm)	Table Pos (deg)	Peak Avg. (P/A)	Pol. (H/V)	
802.11n HT40 CH 102 5510MHz		11020	39.7	-34.3	74	35.66	39.58	15.49	51.03	100	0	P	H	
		16530	41.43	-32.57	74	34.57	39.39	19.34	51.87	100	0	P	H	
													H	
													H	
			11020	39.57	-34.43	74	35.53	39.58	15.49	51.03	100	0	P	V
			16530	40.66	-33.34	74	33.8	39.39	19.34	51.87	100	0	P	V
														V
802.11n HT40 CH 110 5550MHz		11100	39.57	-34.43	74	35.58	39.5	15.55	51.06	100	0	P	H	
		16650	43.02	-30.98	74	35.31	40.07	19.54	51.9	100	0	P	H	
													H	
													H	
			11100	40.12	-33.88	74	36.13	39.5	15.55	51.06	100	0	P	V
			16650	46.22	-27.78	74	38.51	40.07	19.54	51.9	100	0	P	V
														V
802.11n HT40 CH 134 5670MHz		11340	41.41	-32.59	74	37.59	39.27	15.73	51.18	100	0	P	H	
		17010	45.19	-28.81	74	34.93	42.06	20.16	51.96	100	0	P	H	
													H	
													H	
			11340	40.07	-33.93	74	36.25	39.27	15.73	51.18	100	0	P	V
			17010	45.28	-28.72	74	35.02	42.06	20.16	51.96	100	0	P	V
														V
Remark	1. No other spurious found.													
	2. All results are PASS against Peak and Average limit line.													



Emission below 1GHz

WIFI 802.11a (LF @ 3m)

WIFI Ant.	Note	Frequency (MHz)	Level (dBμV/m)	Over Limit (dB)	Limit Line (dBμV/m)	Read Level (dBμV)	Antenna Factor (dB/m)	Cable Loss (dB)	Preamp Factor (dB)	Ant Pos (cm)	Table Pos (deg)	Peak Avg. (P/A)	Pol. (H/V)	
802.11a LF		30	23.19	-16.81	40	28.7	25.7	1.29	32.5	-	-	P	H	
		169.05	24.49	-19.01	43.5	39.25	16	2	32.76	-	-	P	H	
		231.42	25.67	-20.33	46	39	17.06	2.34	32.73	-	-	P	H	
		467.3	23.73	-22.27	46	29.23	23.58	3.28	32.36	-	-	P	H	
		748.7	29.05	-16.95	46	29.61	27.68	4.09	32.33	-	-	P	H	
		951	33.34	-12.66	46	29.24	30.6	4.69	31.19	100	0	P	H	
														H
														H
														H
														H
														H
														H
			31.62	33.56	-6.44	40	40.1	24.66	1.29	32.49	200	234	P	V
			36.75	30.54	-9.46	40	39.76	21.98	1.29	32.49	-	-	P	V
			62.67	22.82	-17.18	40	41.75	12.05	1.51	32.49	-	-	P	V
			527.5	24.93	-21.07	46	29.47	24.48	3.38	32.4	-	-	P	V
			763.4	29.24	-16.76	46	29.58	27.86	4.09	32.29	-	-	P	V
			950.3	32.8	-13.2	46	28.71	30.6	4.69	31.2	-	-	P	V
														V
														V
													V	
													V	
													V	
													V	
Remark	1. No other spurious found. 2. All results are PASS against limit line.													



Emission below 1GHz

WIFI 802.11n HT20 (LF @ 3m)

WIFI	Note	Frequency	Level	Over	Limit	Read	Antenna	Cable	Preamp	Ant	Table	Peak	Pol.	
Ant.		(MHz)	(dBµV/m)	(dB)	(dBµV/m)	(dBµV)	(dB/m)	(dB)	(dB)	(cm)	(deg)	(P/A)	(H/V)	
1														
802.11n HT20 LF		30.27	25.18	-14.82	40	30.69	25.7	1.29	32.5	-	-	P	H	
		169.05	26.38	-17.12	43.5	41.14	16	2	32.76	-	-	P	H	
		291.09	28.27	-17.73	46	38.59	19.52	2.58	32.42	-	-	P	H	
		519.1	25.47	-20.53	46	30.13	24.36	3.38	32.4	-	-	P	H	
		837.6	30.88	-15.12	46	29.71	28.76	4.39	31.98	-	-	P	H	
		952.4	33.51	-12.49	46	29.41	30.59	4.69	31.18	100	0	P	H	
														H
														H
														H
														H
														H
														H
														H
			31.62	33.56	-6.44	40	40.1	24.66	1.29	32.49	200	263	P	V
			36.75	29.7	-10.3	40	38.92	21.98	1.29	32.49	-	-	P	V
			63.48	24.25	-15.75	40	43.13	12.1	1.51	32.49	-	-	P	V
			446.3	24.41	-21.59	46	30.42	23.23	3.11	32.35	-	-	P	V
			783.7	29.61	-16.39	46	29.48	28.1	4.26	32.23	-	-	P	V
			941.9	33.36	-12.64	46	29.56	30.38	4.69	31.27	-	-	P	V
														V
														V
													V	
													V	
													V	
													V	
Remark	1. No other spurious found. 2. All results are PASS against limit line.													



Emission below 1GHz

WIFI 802.11n HT40 (LF @ 3m)

WIFI	Note	Frequency	Level	Over	Limit	Read	Antenna	Cable	Preamp	Ant	Table	Peak	Pol.	
Ant.				Limit	Line	Level	Factor	Loss	Factor	Pos	Pos	Avg.		
1		(MHz)	(dBμV/m)	(dB)	(dBμV/m)	(dBμV)	(dB/m)	(dB)	(dB)	(cm)	(deg)	(P/A)	(H/V)	
802.11n HT40 LF		30.27	28.71	-11.29	40	34.22	25.7	1.29	32.5	100	0	P	H	
		170.13	29.52	-13.98	43.5	44.39	15.9	2	32.77	-	-	P	H	
		230.07	30.56	-15.44	46	44.05	16.9	2.34	32.73	-	-	P	H	
		512.1	24.23	-21.77	46	28.98	24.26	3.38	32.39	-	-	P	H	
		763.4	30.43	-15.57	46	30.77	27.86	4.09	32.29	-	-	P	H	
		930.7	32.81	-13.19	46	29.47	30.08	4.63	31.37	-	-	P	H	
														H
														H
														H
														H
														H
														H
														H
			30.27	33.16	-6.84	40	38.67	25.7	1.29	32.5	200	175	P	V
			37.02	31.17	-8.83	40	40.39	21.98	1.29	32.49	-	-	P	V
			63.21	25.46	-14.54	40	44.39	12.05	1.51	32.49	-	-	P	V
			546.4	25.26	-20.74	46	29.46	24.75	3.47	32.42	-	-	P	V
			788.6	29.93	-16.07	46	29.72	28.16	4.26	32.21	-	-	P	V
			911.8	33.87	-12.13	46	31.26	29.53	4.63	31.55	-	-	P	V
														V
													V	
													V	
													V	
													V	
													V	
Remark	1. No other spurious found. 2. All results are PASS against limit line.													



Note symbol

*	Fundamental Frequency which can be ignored. However, the level of any unwanted emissions shall not exceed the level of the fundamental frequency.
!	Test result is over limit line.
P/A	Peak or Average
H/V	Horizontal or Vertical



A calculation example for radiated spurious emission is shown as below:

WIFI	Note	Frequency	Level	Over	Limit	Read	Antenna	Cable	Preamp	Ant	Table	Peak	Pol.
Ant.				Limit	Line	Level	Factor	Loss	Factor	Pos	Pos	Avg.	
1		(MHz)	(dBμV/m)	(dB)	(dBμV/m)	(dBμV)	(dB/m)	(dB)	(dB)	(cm)	(deg)	(P/A)	(H/V)
802.11b		2390	55.45	-18.55	74	54.51	32.22	4.58	35.86	103	308	P	H
CH 01													
2412MHz		2390	43.54	-10.46	54	42.6	32.22	4.58	35.86	103	308	A	H

- 1. Level(dBμV/m) =
Antenna Factor(dB/m) + Cable Loss(dB) + Read Level(dBμV) - Preamp Factor(dB)
- 2. Over Limit(dB) = Level(dBμV/m) – Limit Line(dBμV/m)

For Peak Limit @ 2390MHz:

- 1. Level(dBμV/m)
= Antenna Factor(dB/m) + Cable Loss(dB) + Read Level(dBμV) - Preamp Factor(dB)
= 32.22(dB/m) + 4.58(dB) + 54.51(dBμV) – 35.86 (dB)
= 55.45 (dBμV/m)
- 2. Over Limit(dB)
= Level(dBμV/m) – Limit Line(dBμV/m)
= 55.45(dBμV/m) – 74(dBμV/m)
= -18.55(dB)

For Average Limit @ 2390MHz:

- 1. Level(dBμV/m)
= Antenna Factor(dB/m) + Cable Loss(dB) + Read Level(dBμV) - Preamp Factor(dB)
= 32.22(dB/m) + 4.58(dB) + 42.6(dBμV) – 35.86 (dB)
= 43.54 (dBμV/m)
- 2. Over Limit(dB)
= Level(dBμV/m) – Limit Line(dBμV/m)
= 43.54(dBμV/m) – 54(dBμV/m)
= -10.46(dB)

Both peak and average measured complies with the limit line, so test result is “PASS”.



Appendix C. Radiated Spurious Emission

Test Engineer :	J.C. Liang, Nick Yu, and Ken Wu	Temperature :	20~23°C
		Relative Humidity :	58~63%

Note symbol

-L	Low channel location
-R	High channel location



Band 1 - 5150~5250MHz
WIFI 802.11a (Band Edge @ 3m)

WIFI	Band 1 5150~5250MHz Band Edge @ 3m	
ANT	802.11a CH36 5180MHz	
1	Horizontal	Fundamental
Peak		
Avg.		Left blank



WIFI	Band 1 5150~5250MHz Band Edge @ 3m	
ANT	802.11a CH36 5180MHz	
1	Vertical	Vertical
Peak	<p>Site : 03CH11-HY Condition : PEAK_BE_74 3m HORN 91200-HF VERTICAL</p>	<p>Site : 03CH11-HY Condition : PEAK_74 3m HORN 91200-HF VERTICAL</p>
Avg.	<p>Site : 03CH11-HY Condition : AVG_BE_54 3m HORN 91200-HF VERTICAL</p>	Left blank

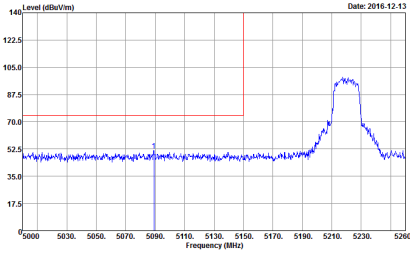
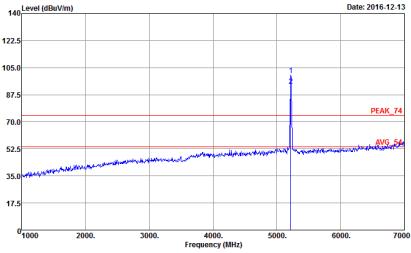
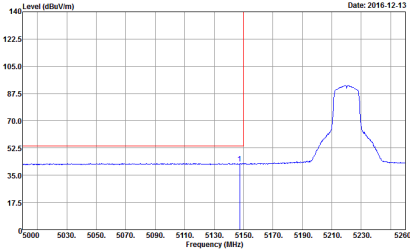

WIFI	Band 1 5150~5250MHz Band Edge @ 3m	
ANT	802.11a CH44 5220MHz - L	
1	Horizontal	Fundamental
Peak	 <p>Date: 2016-12-13</p> <p>Site : 03CH11-HY Condition : PEAK_BE_74 3m HORN 91200-HF HORIZONTAL</p>	 <p>Date: 2016-12-13</p> <p>Site : 03CH11-HY Condition : PEAK_74 3m HORN 91200-HF HORIZONTAL</p>
Avg.	 <p>Date: 2016-12-13</p> <p>Site : 03CH11-HY Condition : AVG_BE_54 3m HORN 91200-HF HORIZONTAL</p>	Left blank



WIFI	Band 1 5150~5250MHz Band Edge @ 3m	
ANT	802.11a CH44 5220MHz - R	
1	Horizontal	Fundamental
Peak	<p>Site : 03CHI1-HY Condition : PEAK_BE_74 3m HORN 9120D-HF HORIZONTAL</p>	Left blank
Avg.	<p>Site : 03CHI1-HY Condition : AVG_BE_54 3m HORN 9120D-HF HORIZONTAL</p>	Left blank



WIFI	Band 1 5150~5250MHz Band Edge @ 3m	
ANT	802.11a CH44 5220MHz - L	
1	Vertical	Fundamental
Peak	<p>Site : 03CH11-HY Condition : PEAK_BE_74 3m HORN 91200-HF VERTICAL</p>	<p>Site : 03CH11-HY Condition : PEAK_74 3m HORN 91200-HF VERTICAL</p>
Avg.	<p>Site : 03CH11-HY Condition : AVG_BE_54 3m HORN 91200-HF VERTICAL</p>	Left blank



WIFI	Band 1 5150~5250MHz Band Edge @ 3m	
ANT	802.11a CH44 5220MHz - R	
1	Vertical	Fundamental
Peak	<p>Site : 03CH11-HY Condition : PEAK_BE_74 3m HORN 9120D-HF VERTICAL</p>	Left blank
Avg.	<p>Site : 03CH11-HY Condition : AVG_BE_54 3m HORN 9120D-HF VERTICAL</p>	Left blank

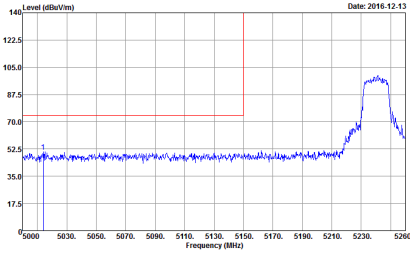
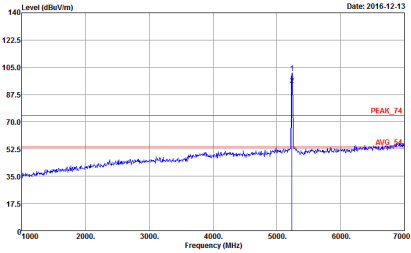
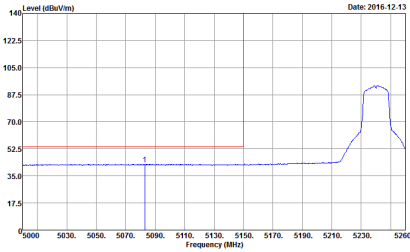

WIFI	Band 1 5150~5250MHz Band Edge @ 3m	
ANT	802.11a CH48 5240MHz - L	
1	Horizontal	Fundamental
Peak	 <p>Date: 2016-12-13</p> <p>Site : 03CH11-HY Condition : PEAK_BE_74 3m HORN 9120D-HF HORIZONTAL</p>	 <p>Date: 2016-12-13</p> <p>Site : 03CH11-HY Condition : PEAK_74 3m HORN 9120D-HF HORIZONTAL</p>
Avg.	 <p>Date: 2016-12-13</p> <p>Site : 03CH11-HY Condition : AVG_BE_54 3m HORN 9120D-HF HORIZONTAL</p>	Left blank



WIFI	Band 1 5150~5250MHz Band Edge @ 3m	
ANT	802.11a CH48 5240MHz - R	
1	Horizontal	Fundamental
Peak	<p>Site : 03CH11-HY Condition : PEAK_BE_74 3m HORN 9120D-HF HORIZONTAL</p>	Left blank
Avg.	<p>Site : 03CH11-HY Condition : AVG_BE_54 3m HORN 9120D-HF HORIZONTAL</p>	Left blank



WIFI	Band 1 5150~5250MHz Band Edge @ 3m	
ANT	802.11a CH48 5240MHz - L	
1	Vertical	Fundamental
Peak	<p>Site : 03CH11-HY Condition : PEAK_BE_74 3m HORN 91200-HF VERTICAL</p>	<p>Site : 03CH11-HY Condition : PEAK_74 3m HORN 91200-HF VERTICAL</p>
Avg.	<p>Site : 03CH11-HY Condition : AVG_BE_54 3m HORN 91200-HF VERTICAL</p>	Left blank



WIFI	Band 1 5150~5250MHz Band Edge @ 3m	
ANT	802.11a CH48 5240MHz - R	
1	Vertical	Fundamental
Peak		Left blank
Avg.		Left blank



Band 1 5150~5250MHz
WIFI 802.11n HT20 (Band Edge @ 3m)

WIFI	Band 1 5150~5250MHz Band Edge @ 3m	
ANT	802.11n HT20 CH36 5180MHz	
1	Horizontal	Fundamental
Peak		
Avg.		Left blank

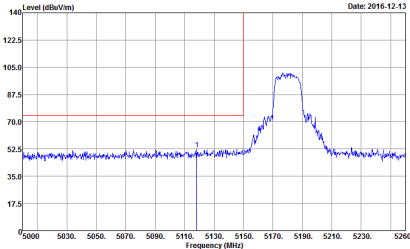
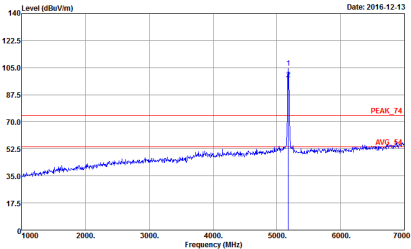
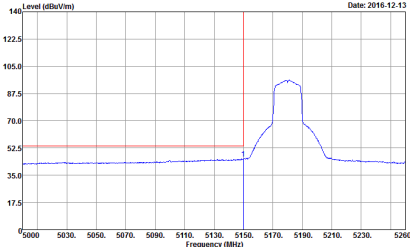

WIFI	Band 1 5150~5250MHz Band Edge @ 3m	
ANT	802.11n HT20 CH36 5180MHz	
1	Vertical	Fundamental
Peak	 <p>Site : 03CH11-HY Condition : PEAK_BE_74 3m HORN 91200-HF VERTICAL</p>	 <p>Site : 03CH11-HY Condition : PEAK_74 3m HORN 91200-HF VERTICAL</p>
Avg.	 <p>Site : 03CH11-HY Condition : AVG_BE_54 3m HORN 91200-HF VERTICAL</p>	Left blank

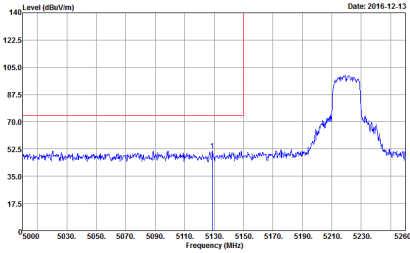
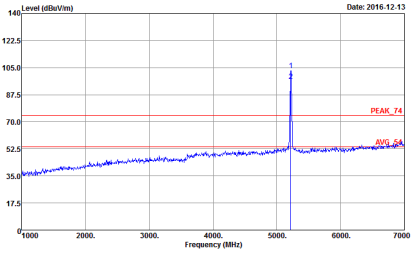
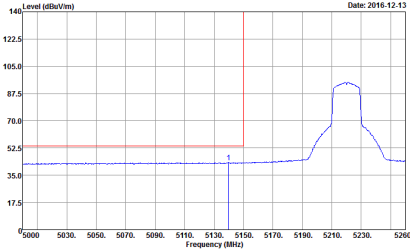

WIFI	Band 1 5150~5250MHz Band Edge @ 3m	
ANT	802.11n HT20 CH44 5220MHz - L	
1	Horizontal	Fundamental
Peak	 <p>Date: 2016-12-13</p> <p>Site : 03CH11-HY Condition : PEAK_BE_74 3m HORN 91200-HF HORIZONTAL</p>	 <p>Date: 2016-12-13</p> <p>Site : 03CH11-HY Condition : PEAK_74 3m HORN 91200-HF HORIZONTAL</p>
Avg.	 <p>Date: 2016-12-13</p> <p>Site : 03CH11-HY Condition : AVG_BE_54 3m HORN 91200-HF HORIZONTAL</p>	Left blank



WIFI	Band 1 5150~5250MHz Band Edge @ 3m	
ANT	802.11n HT20 CH44 5220MHz - R	
1	Horizontal	Fundamental
Peak	<p>Site : 03CH11-HY Condition : PEAK_BE_74 3m HORN 9120D-HF HORIZONTAL</p>	Left blank
Avg.	<p>Site : 03CH11-HY Condition : AVG_BE_54 3m HORN 9120D-HF HORIZONTAL</p>	Left blank



WIFI	Band 1 5150~5250MHz Band Edge @ 3m	
ANT	802.11n HT20 CH44 5220MHz - L	
1	Vertical	Fundamental
Peak	<p>Site : 03CH11-HY Condition : PEAK_BE_74 3m HORN 91200-HF VERTICAL</p>	<p>Site : 03CH11-HY Condition : PEAK_74 3m HORN 91200-HF VERTICAL</p>
Avg.	<p>Site : 03CH11-HY Condition : AVG_BE_54 3m HORN 91200-HF VERTICAL</p>	Left blank



WIFI	Band 1 5150~5250MHz Band Edge @ 3m	
ANT	802.11n HT20 CH44 5220MHz - R	
1	Vertical	Fundamental
Peak	<p>Date: 2016-12-13 Site : 03CH11-HY Condition : PEAK_BE_74 3m HORN 9120D-HF VERTICAL</p>	Left blank
Avg.	<p>Date: 2016-12-13 Site : 03CH11-HY Condition : AVG_BE_54 3m HORN 9120D-HF VERTICAL</p>	Left blank



WIFI	Band 1 5150~5250MHz Band Edge @ 3m	
ANT	802.11n HT20 CH48 5240MHz - L	
1	Horizontal	Fundamental
Peak	<p>Site : 03CH11-HY Condition : PEAK_BE_74 3m HORN 91200-HF HORIZONTAL</p>	<p>Site : 03CH11-HY Condition : PEAK_74 3m HORN 91200-HF HORIZONTAL</p>
Avg.	<p>Site : 03CH11-HY Condition : AVG_BE_54 3m HORN 91200-HF HORIZONTAL</p>	Left blank



WIFI	Band 1 5150~5250MHz Band Edge @ 3m	
ANT	802.11n HT20 CH48 5240MHz - R	
1	Horizontal	Fundamental
Peak	<p>Site : 03CH11-HY Condition : PEAK_BE_74 3m HORN 9120D-HF HORIZONTAL</p>	Left blank
Avg.	<p>Site : 03CH11-HY Condition : AVG_BE_54 3m HORN 9120D-HF HORIZONTAL</p>	Left blank



WIFI	Band 1 5150~5250MHz Band Edge @ 3m	
ANT	802.11n HT20 CH48 5240MHz - L	
1	Vertical	Fundamental
Peak	<p>Site : 03CH11-HY Condition : PEAK_BE_74 3m HORN 91200-HF VERTICAL</p>	<p>Site : 03CH11-HY Condition : PEAK_74 3m HORN 91200-HF VERTICAL</p>
Avg.	<p>Site : 03CH11-HY Condition : AVG_BE_54 3m HORN 91200-HF VERTICAL</p>	Left blank



WIFI	Band 1 5150~5250MHz Band Edge @ 3m	
ANT	802.11n HT20 CH48 5240MHz - R	
1	Vertical	Fundamental
Peak	<p>Date: 2016-12-13</p> <p>Site : 03CHI1-HY Condition : PEAK_BE_74 3m HORN 9120D-HF VERTICAL</p>	Left blank
Avg.	<p>Date: 2016-12-13</p> <p>Site : 03CHI1-HY Condition : AVG_BE_54 3m HORN 9120D-HF VERTICAL</p>	Left blank



**Band 1 5150~5250MHz
WIFI 802.11n HT40 (Band Edge @ 3m)**

WIFI	Band 1 5150~5250MHz Band Edge @ 3m	
ANT	802.11n HT40 CH38 5190MHz - L	
1	Horizontal	Fundamental
Peak	<p>Site : 03CH11-HY Condition : PEAK_BE_74 3m HORN 9120D-HF HORIZONTAL</p>	<p>Site : 03CH11-HY Condition : PEAK_74 3m HORN 9120D-HF HORIZONTAL</p>
Avg.	<p>Site : 03CH11-HY Condition : AVG_BE_54 3m HORN 9120D-HF HORIZONTAL</p>	Left blank



WIFI	Band 1 5150~5250MHz Band Edge @ 3m	
ANT	802.11n HT40 CH38 5190MHz - R	
1	Horizontal	Fundamental
Peak		Left blank
Avg.		Left blank

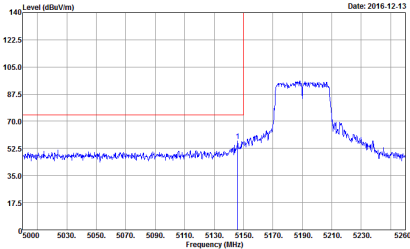
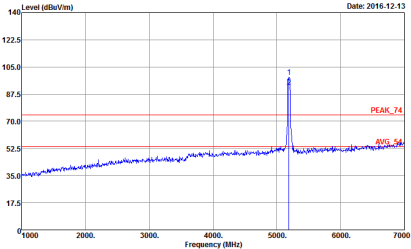
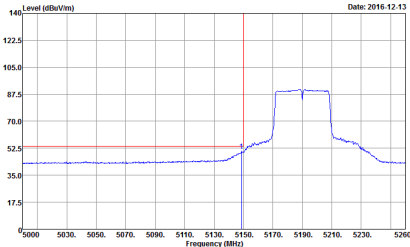

WIFI	Band 1 5150~5250MHz Band Edge @ 3m	
ANT	802.11n HT40 CH38 5190MHz - L	
1	Vertical	Fundamental
Peak	 <p>Site : 03CHI1-HY Condition : PEAK_BE_74 3m HORN 9120D-HF VERTICAL</p>	 <p>Site : 03CHI1-HY Condition : PEAK_74 3m HORN 9120D-HF VERTICAL</p>
Avg.	 <p>Site : 03CHI1-HY Condition : AVG_BE_54 3m HORN 9120D-HF VERTICAL</p>	Left blank



WIFI	Band 1 5150~5250MHz Band Edge @ 3m	
ANT	802.11n HT40 CH38 5190MHz - R	
1	Vertical	Fundamental
Peak	<p>Site : 03CHI1-HY Condition : PEAK_BE_74 3m HORN 9120D-HF VERTICAL</p>	Left blank
Avg.	<p>Site : 03CHI1-HY Condition : AVG_BE_54 3m HORN 9120D-HF VERTICAL</p>	Left blank



WIFI	Band 1 5150~5250MHz Band Edge @ 3m	
ANT	802.11n HT40 CH46 5230MHz - L	
1	Horizontal	Fundamental
Peak	<p>Site : 03CH11-HY Condition : PEAK_BE_74 3m HORN 9120D-HF HORIZONTAL</p>	<p>Site : 03CH11-HY Condition : PEAK_74 3m HORN 9120D-HF HORIZONTAL</p>
Avg.	<p>Site : 03CH11-HY Condition : AVG_BE_54 3m HORN 9120D-HF HORIZONTAL</p>	Left blank



WIFI	Band 1 5150~5250MHz Band Edge @ 3m	
ANT	802.11n HT40 CH46 5230MHz - R	
1	Horizontal	Fundamental
Peak	<p>Site : 03CH11-HY Condition : PEAK_BE_74 3m HORN 9120D-HF HORIZONTAL</p>	Left blank
Avg.	<p>Site : 03CH11-HY Condition : AVG_BE_54 3m HORN 9120D-HF HORIZONTAL</p>	Left blank



WIFI	Band 1 5150~5250MHz Band Edge @ 3m	
ANT	802.11n HT40 CH46 5230MHz - L	
1	Vertical	Fundamental
Peak	<p>Site : 03CH11-HY Condition : PEAK_BE_74 3m HORN 91200-HF VERTICAL</p>	<p>Site : 03CH11-HY Condition : PEAK_74 3m HORN 91200-HF VERTICAL</p>
Avg.	<p>Site : 03CH11-HY Condition : AVG_BE_54 3m HORN 91200-HF VERTICAL</p>	Left blank

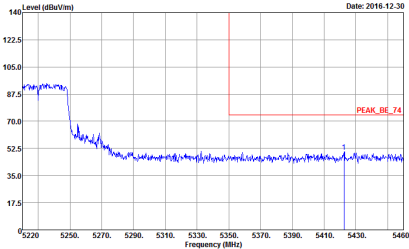
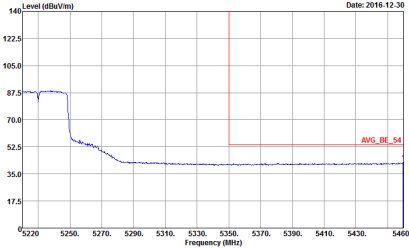

WIFI	Band 1 5150~5250MHz Band Edge @ 3m	
ANT	802.11n HT40 CH46 5230MHz - R	
1	Vertical	Fundamental
Peak	 <p>Date: 2016-12-30</p> <p>Site : 03CHI1-HY Condition : PEAK_BE_74 3m HORN 9120D-HF VERTICAL</p>	Left blank
Avg.	 <p>Date: 2016-12-30</p> <p>Site : 03CHI1-HY Condition : AVG_BE_54 3m HORN 9120D-HF VERTICAL</p>	Left blank



Band 1 - 5150~5250MHz

WIFI 802.11a (Harmonic @ 3m)

WIFI	Band 1 5150~5250MHz Harmonic @ 3m	
ANT	802.11a CH36 5180MHz	
1	Horizontal	Vertical
Peak Avg.	<p>Site : 03CH11-HY Condition : PEAK_74 3m 9170 SHF HORM_150809 HORIZONTAL</p>	<p>Site : 03CH11-HY Condition : PEAK_74 3m 9170 SHF HORM_150809 VERTICAL</p>

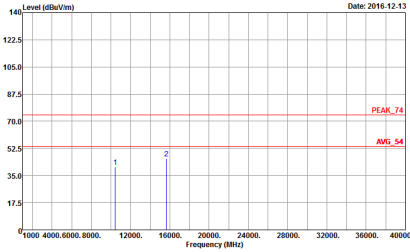
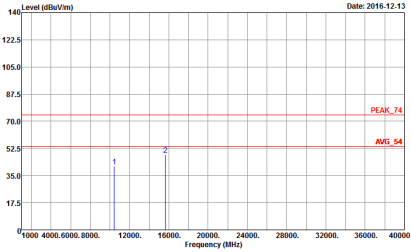

WIFI	Band 1 5150~5250MHz Harmonic @ 3m	
ANT	802.11a CH44 5220MHz	
1	Horizontal	Vertical
Peak Avg.	 <p>Site : 03CH11-HY Condition : PEAK_74 3m 9170 SHF HORM_150809 HORIZONTAL</p>	 <p>Site : 03CH11-HY Condition : PEAK_74 3m 9170 SHF HORM_150809 VERTICAL</p>

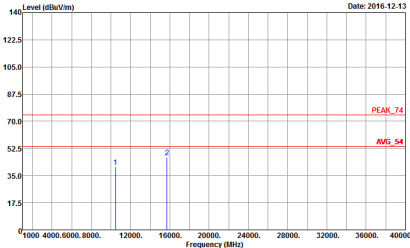
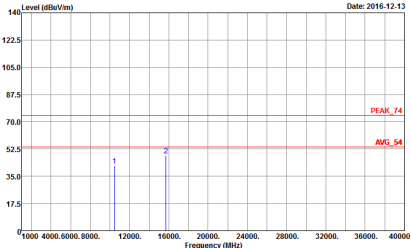

WIFI	Band 1 5150~5250MHz Harmonic @ 3m	
ANT	802.11a CH48 5240MHz	
1	Horizontal	Vertical
Peak Avg.	 <p>Site : 03CH11-HY Condition : PEAK_74 3m 9170 SHF HORM_150809 HORIZONTAL</p>	 <p>Site : 03CH11-HY Condition : PEAK_74 3m 9170 SHF HORM_150809 VERTICAL</p>



Band 1 5150~5250MHz
WIFI 802.11n HT20 (Harmonic @ 3m)

WIFI	Band 1 5150~5250MHz Harmonic @ 3m	
ANT	802.11n HT20 CH36 5180MHz	
1	Horizontal	Vertical
Peak Avg.	<p>Site : 03CH11-HY Condition : PEAK_74 3m 9170 SHF HORM_150809 HORIZONTAL</p>	<p>Site : 03CH11-HY Condition : PEAK_74 3m 9170 SHF HORM_150809 VERTICAL</p>



WIFI	Band 1 5150~5250MHz Harmonic @ 3m	
ANT	802.11n HT20 CH44 5220MHz	
1	Horizontal	Vertical
Peak Avg.	<p>Site : 03CH11-HY Condition : PEAK_74 3m 9170 SHF HORM_150809 HORIZONTAL</p>	<p>Site : 03CH11-HY Condition : PEAK_74 3m 9170 SHF HORM_150809 VERTICAL</p>



WIFI	Band 1 5150~5250MHz Harmonic @ 3m	
ANT	802.11n HT20 CH48 5240MHz	
1	Horizontal	Vertical
Peak Avg.	<p>Site : 03CH11-HY Condition : PEAK_74 3m 9170 SHF HORM_150809 HORIZONTAL</p>	<p>Site : 03CH11-HY Condition : PEAK_74 3m 9170 SHF HORM_150809 VERTICAL</p>



Band 1 5150~5250MHz
WIFI 802.11n HT40 (Harmonic @ 3m)

WIFI	Band 1 5150~5250MHz Harmonic @ 3m	
ANT	802.11n HT40 CH38 5190MHz	
1	Horizontal	Vertical
Peak Avg.	<p>Site : 03CH11-HY Condition : PEAK_74 3m 9170 SHF HORM_150809 HORIZONTAL</p>	<p>Site : 03CH11-HY Condition : PEAK_74 3m 9170 SHF HORM_150809 VERTICAL</p>



WIFI	Band 1 5150~5250MHz Harmonic @ 3m	
ANT	802.11n HT40 CH46 5230MHz	
1	Horizontal	Vertical
Peak Avg.	<p>Site : 03CH11-HY Condition : PEAK_74 3m 9170 SHF HORM_150809 HORIZONTAL</p>	<p>Site : 03CH11-HY Condition : PEAK_74 3m 9170 SHF HORM_150809 VERTICAL</p>



Band 2 - 5250~5350MHz

WIFI 802.11a (Band Edge @ 3m)

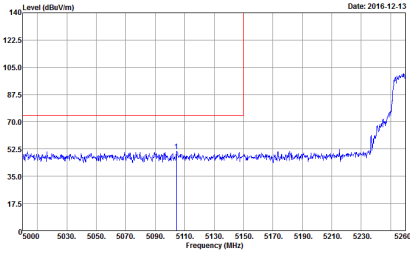
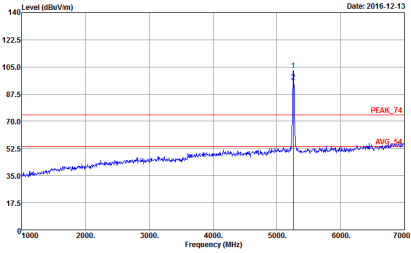
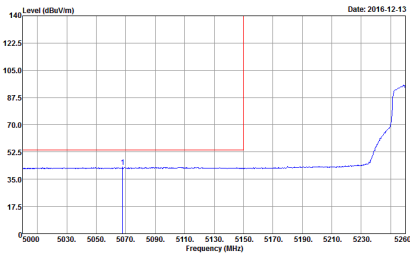
WIFI	Band 2 5250~5350MHz Band Edge @ 3m	
ANT	802.11a CH52 5260MHz - L	
1	Horizontal	Fundamental
Peak	 <p>Site : 03CH11-HY Condition : PEAK_BE_74 3m HORN 9120D-HF HORIZONTAL</p>	 <p>Site : 03CH11-HY Condition : PEAK_74 3m HORN 9120D-HF HORIZONTAL</p>
Avg.	 <p>Site : 03CH11-HY Condition : AV6_BE_54 3m HORN 9120D-HF HORIZONTAL</p>	Left blank

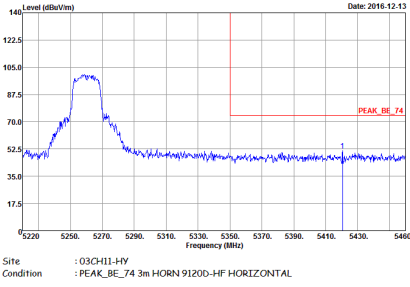
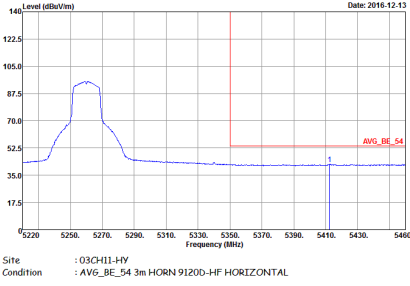

WIFI	Band 2 5250~5350MHz Band Edge @ 3m	
ANT	802.11a CH52 5260MHz - R	
1	Horizontal	Fundamental
Peak	 <p>Site : 03CH11-HY Condition : PEAK_BE_74 3m HORN 9120D-HF HORIZONTAL</p>	Left blank
Avg.	 <p>Site : 03CH11-HY Condition : AVG_BE_54 3m HORN 9120D-HF HORIZONTAL</p>	Left blank



WIFI	Band 2 5250~5350MHz Band Edge @ 3m	
ANT	802.11a CH52 5260MHz - L	
1	Vertical	Fundamental
Peak	<p>Site : 03CH11-HY Condition : PEAK_BE_74 3m HORN 91200-HF VERTICAL</p>	<p>Site : 03CH11-HY Condition : PEAK_74 3m HORN 91200-HF VERTICAL</p>
Avg.	<p>Site : 03CH11-HY Condition : AVG_BE_54 3m HORN 91200-HF VERTICAL</p>	Left blank



WIFI	Band 2 5250~5350MHz Band Edge @ 3m	
ANT	802.11a CH52 5260MHz - R	
1	Vertical	Fundamental
Peak	<p>Site : 03CH11-HY Condition : PEAK_BE_74 3m HORN 9120D-HF VERTICAL</p>	Left blank
Avg.	<p>Site : 03CH11-HY Condition : AVG_BE_54 3m HORN 9120D-HF VERTICAL</p>	Left blank



WIFI	Band 2 5250~5350MHz Band Edge @ 3m	
ANT	802.11a CH60 5300MHz - L	
1	Horizontal	Fundamental
Peak	<p>Site : 03CH11-HY Condition : PEAK_BE_74 3m HORN 91200-HF HORIZONTAL</p>	<p>Site : 03CH11-HY Condition : PEAK_74 3m HORN 91200-HF HORIZONTAL</p>
Avg.	<p>Site : 03CH11-HY Condition : AVG_BE_54 3m HORN 91200-HF HORIZONTAL</p>	Left blank

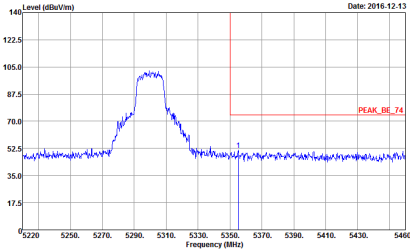
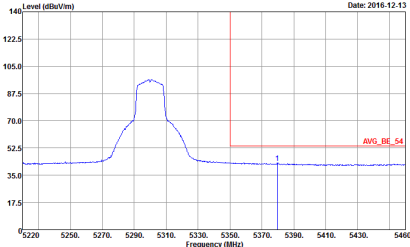

WIFI	Band 2 5250~5350MHz Band Edge @ 3m	
ANT	802.11a CH60 5300MHz - R	
1	Horizontal	Fundamental
Peak	 <p>Date: 2016-12-13</p> <p>Site : 03CHI1-HY Condition : PEAK_BE_74 3m HORN 9120D-HF HORIZONTAL</p>	Left blank
Avg.	 <p>Date: 2016-12-13</p> <p>Site : 03CHI1-HY Condition : AVG_BE_54 3m HORN 9120D-HF HORIZONTAL</p>	Left blank



WIFI	Band 2 5250~5350MHz Band Edge @ 3m	
ANT	802.11a CH60 5300MHz - L	
1	Vertical	Fundamental
Peak	<p>Site : 03CHI1-HY Condition : PEAK_BE_74 3m HORN 9120D-HF VERTICAL</p>	<p>Site : 03CHI1-HY Condition : PEAK_74 3m HORN 9120D-HF VERTICAL</p>
Avg.	<p>Site : 03CHI1-HY Condition : AVG_BE_54 3m HORN 9120D-HF VERTICAL</p>	Left blank

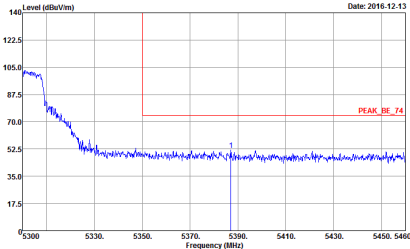
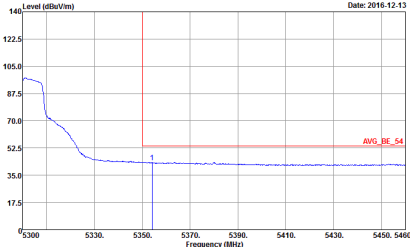

WIFI	Band 2 5250~5350MHz Band Edge @ 3m	
ANT	802.11a CH60 5300MHz - R	
1	Vertical	Fundamental
Peak	 <p>Date: 2016-12-13</p> <p>Site : 03CH11-HY Condition : PEAK_BE_74 3m HORN 9120D-HF VERTICAL</p>	Left blank
Avg.	 <p>Date: 2016-12-13</p> <p>Site : 03CH11-HY Condition : AVG_BE_54 3m HORN 9120D-HF VERTICAL</p>	Left blank

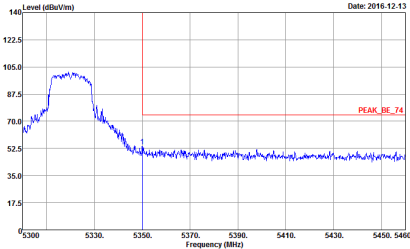
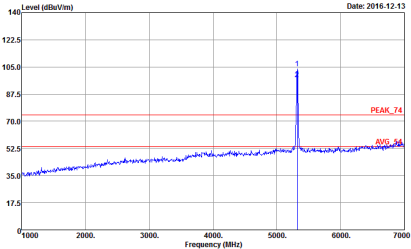
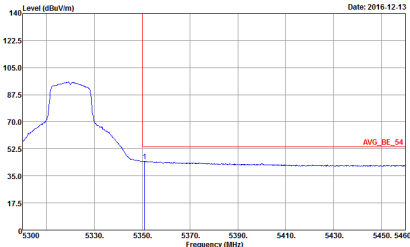

WIFI	Band 2 5250~5350MHz Band Edge @ 3m	
ANT	802.11a CH64 5320MHz	
1	Horizontal	Fundamental
Peak	 <p>Date: 2016-12-13</p> <p>Site : 03CHI1-HY Condition : PEAK_BE_74 3m HORN 9120D-HF HORIZONTAL</p>	 <p>Date: 2016-12-13</p> <p>Site : 03CHI1-HY Condition : PEAK_74 3m HORN 9120D-HF HORIZONTAL</p>
Avg.	 <p>Date: 2016-12-13</p> <p>Site : 03CHI1-HY Condition : AVG_BE_54 3m HORN 9120D-HF HORIZONTAL</p>	Left blank



WIFI	Band 2 5250~5350MHz Band Edge @ 3m	
ANT	802.11a CH64 5320MHz	
1	Vertical	Fundamental
Peak	<p>Site : 03CH11-HY Condition : PEAK_BE_74 3m HORN 9120D-HF VERTICAL</p>	<p>Site : 03CH11-HY Condition : PEAK_74 3m HORN 9120D-HF VERTICAL</p>
Avg.	<p>Site : 03CH11-HY Condition : AVG_BE_54 3m HORN 9120D-HF VERTICAL</p>	Left blank



Band 2 5250~5350MHz
WIFI 802.11n HT20 (Band Edge @ 3m)

WIFI	Band 2 5250~5350MHz Band Edge @ 3m	
ANT	802.11n HT20 CH52 5260MHz - L	
1	Horizontal	Fundamental
Peak	<p>Site : 03CH11-HY Condition : PEAK_BE_74 3m HORN 91200-HF HORIZONTAL</p>	<p>Site : 03CH11-HY Condition : PEAK_74 3m HORN 91200-HF HORIZONTAL</p>
Avg.	<p>Site : 03CH11-HY Condition : AVG_BE_54 3m HORN 91200-HF HORIZONTAL</p>	Left blank

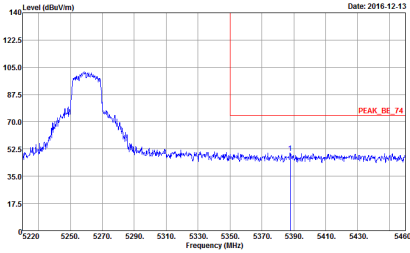
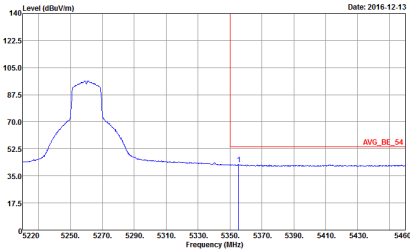

WIFI	Band 2 5250~5350MHz Band Edge @ 3m	
ANT	802.11n HT20 CH52 5260MHz - R	
1	Horizontal	Fundamental
Peak	 <p>Date: 2016-12-13</p> <p>Site : 03CHI1-HY Condition : PEAK_BE_74 3m HORN 9120D-HF HORIZONTAL</p>	Left blank
Avg.	 <p>Date: 2016-12-13</p> <p>Site : 03CHI1-HY Condition : AVG_BE_54 3m HORN 9120D-HF HORIZONTAL</p>	Left blank

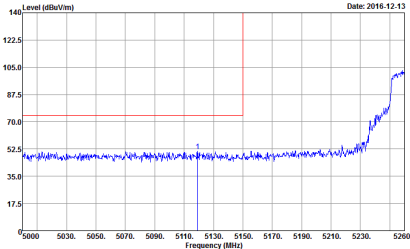
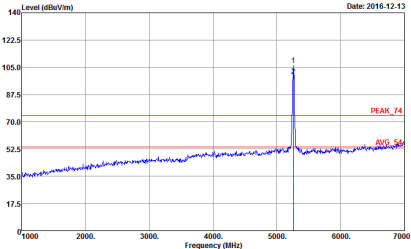
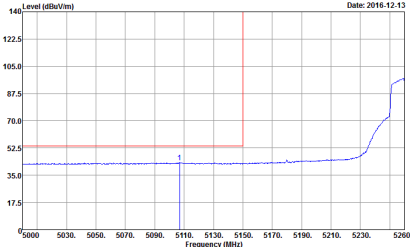

WIFI	Band 2 5250~5350MHz Band Edge @ 3m	
ANT	802.11n HT20 CH52 5260MHz - L	
1	Vertical	Fundamental
Peak	 <p>Date: 2016-12-13</p> <p>Site : 03CH11-HY Condition : PEAK_BE_74 3m HORN 91200-HF VERTICAL</p>	 <p>Date: 2016-12-13</p> <p>Site : 03CH11-HY Condition : PEAK_74 3m HORN 91200-HF VERTICAL</p>
Avg.	 <p>Date: 2016-12-13</p> <p>Site : 03CH11-HY Condition : AVG_BE_54 3m HORN 91200-HF VERTICAL</p>	Left blank

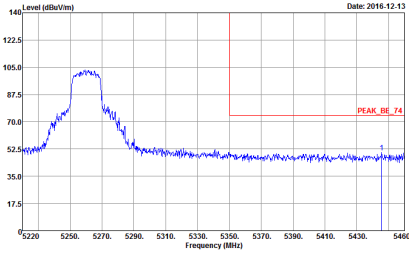
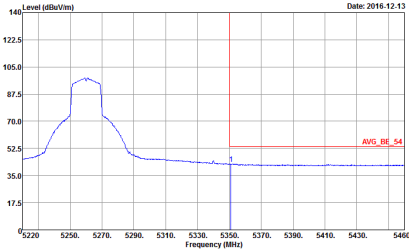

WIFI	Band 2 5250~5350MHz Band Edge @ 3m	
ANT	802.11n HT20 CH52 5260MHz - R	
1	Vertical	Fundamental
Peak	 <p>Date: 2016-12-13</p> <p>Site : 03CH11-HY Condition : PEAK_BE_74 3m HORN 9120D-HF VERTICAL</p>	Left blank
Avg.	 <p>Date: 2016-12-13</p> <p>Site : 03CH11-HY Condition : AVG_BE_54 3m HORN 9120D-HF VERTICAL</p>	Left blank

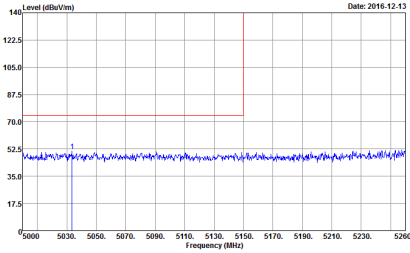
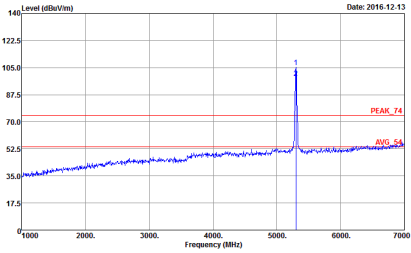
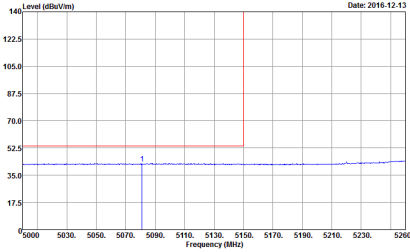

WIFI	Band 2 5250~5350MHz Band Edge @ 3m	
ANT	802.11n HT20 CH60 5300MHz - L	
1	Horizontal	Fundamental
Peak	 <p>Date: 2016-12-13</p> <p>Site : 03CH11-HY Condition : PEAK_BE_74 3m HORN 91200-HF HORIZONTAL</p>	 <p>Date: 2016-12-13</p> <p>Site : 03CH11-HY Condition : PEAK_74 3m HORN 91200-HF HORIZONTAL</p>
Avg.	 <p>Date: 2016-12-13</p> <p>Site : 03CH11-HY Condition : AVG_BE_54 3m HORN 91200-HF HORIZONTAL</p>	Left blank

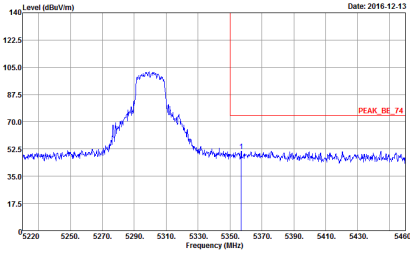
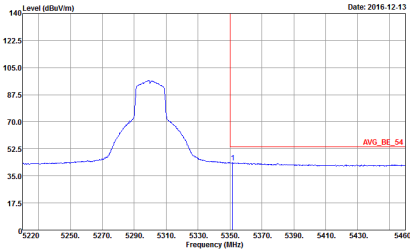

WIFI	Band 2 5250~5350MHz Band Edge @ 3m	
ANT	802.11n HT20 CH60 5300MHz - R	
1	Horizontal	Vertical
Peak	 <p>Date: 2016-12-13</p> <p>Site : 03CHI1-HY Condition : PEAK_BE_74 3m HORN 9120D-HF HORIZONTAL</p>	Left blank
Avg.	 <p>Date: 2016-12-13</p> <p>Site : 03CHI1-HY Condition : AVG_BE_54 3m HORN 9120D-HF HORIZONTAL</p>	Left blank

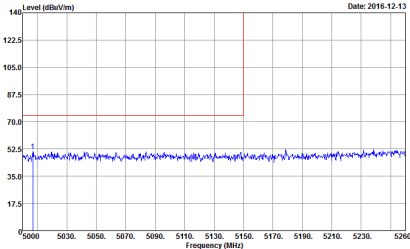
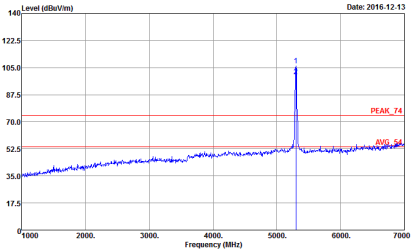
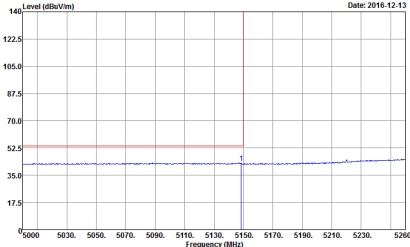

WIFI	Band 2 5250~5350MHz Band Edge @ 3m	
ANT	802.11n HT20 CH60 5300MHz - L	
1	Vertical	Fundamental
Peak	 <p>Site : 03CH11-HY Condition : PEAK_BE_74 3m HORN 91200-HF VERTICAL</p>	 <p>Site : 03CH11-HY Condition : PEAK_74 3m HORN 91200-HF VERTICAL</p>
Avg.	 <p>Site : 03CH11-HY Condition : AVG_BE_54 3m HORN 91200-HF VERTICAL</p>	Left blank



WIFI	Band 2 5250~5350MHz Band Edge @ 3m	
ANT	802.11n HT20 CH60 5300MHz - R	
1	Vertical	Fundamental
Peak	<p>Site : 03CHI1-HY Condition : PEAK_BE_74 3m HORN 9120D-HF VERTICAL</p>	Left blank
Avg.	<p>Site : 03CHI1-HY Condition : AVG_BE_54 3m HORN 9120D-HF VERTICAL</p>	Left blank



WIFI	Band 2 5250~5350MHz Band Edge @ 3m	
ANT	802.11n HT20 CH64 5320MHz	
1	Horizontal	Fundamental
Peak	<p>Site : 03CHI1-HY Condition : PEAK_BE_74 3m HORN 9120D-HF HORIZONTAL</p>	<p>Site : 03CHI1-HY Condition : PEAK_74 3m HORN 9120D-HF HORIZONTAL</p>
Avg.	<p>Site : 03CHI1-HY Condition : AVG_BE_54 3m HORN 9120D-HF HORIZONTAL</p>	Left blank

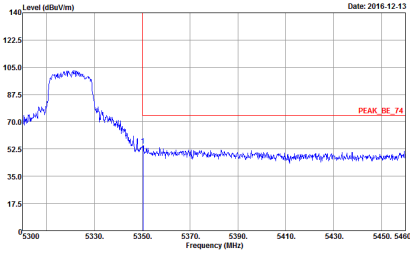
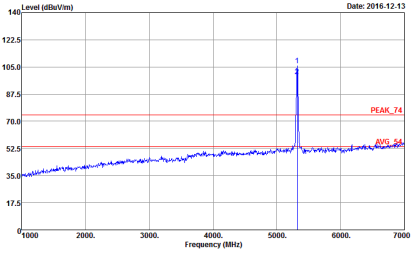
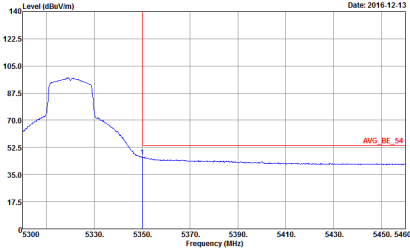

WIFI	Band 2 5250~5350MHz Band Edge @ 3m	
ANT	802.11n HT20 CH64 5320MHz	
1	Vertical	Fundamental
Peak	 <p>Date: 2016-12-13</p> <p>Site : 03CHI1-HY Condition : PEAK_BE_74 3m HORN 9120D-HF VERTICAL</p>	 <p>Date: 2016-12-13</p> <p>Site : 03CHI1-HY Condition : PEAK_74 3m HORN 9120D-HF VERTICAL</p>
Avg.	 <p>Date: 2016-12-13</p> <p>Site : 03CHI1-HY Condition : AVG_BE_54 3m HORN 9120D-HF VERTICAL</p>	Left blank



Band 2 5250~5350MHz
WIFI 802.11n HT40 (Band Edge @ 3m)

Table with 3 columns: WIFI, ANT, and test results. Row 1: Peak, Horizontal, Fundamental. Row 2: Avg., Left blank. Includes spectral plots and site conditions.



WIFI	Band 2 5250~5350MHz Band Edge @ 3m	
ANT	802.11n HT40 CH54 5270 MHz - R	
1	Horizontal	Fundamental
Peak	<p>Site : 03CH11-HY Condition : PEAK_BE_74 3m HORN 9120D-HF HORIZONTAL</p>	Left blank
Avg.	<p>Site : 03CH11-HY Condition : AVG_BE_54 3m HORN 9120D-HF HORIZONTAL</p>	Left blank



WIFI	Band 2 5250~5350MHz Band Edge @ 3m	
ANT	802.11n HT40 CH54 5270 MHz - L	
1	Vertical	Vertical
Peak	<p>Site : 03CH11-HY Condition : PEAK_BE_74 3m HORN 9120D-HF VERTICAL</p>	<p>Site : 03CH11-HY Condition : PEAK_74 3m HORN 9120D-HF VERTICAL</p>
Avg.	<p>Site : 03CH11-HY Condition : AVG_BE_54 3m HORN 9120D-HF VERTICAL</p>	Left blank

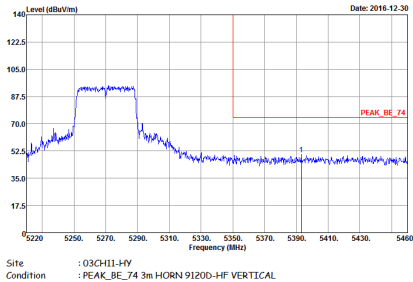
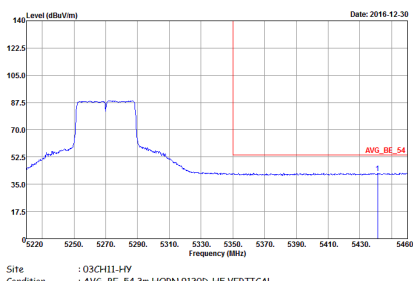

WIFI	Band 2 5250~5350MHz Band Edge @ 3m	
ANT	802.11n HT40 CH54 5270 MHz - R	
1	Vertical	Vertical
Peak		Left blank
Avg.		Left blank



WIFI	Band 2 5250~5350MHz Band Edge @ 3m	
ANT	802.11n HT40 CH62 5310 MHz - L	
1	Horizontal	Fundamental
Peak	<p>Site : 03CH11-HY Condition : PEAK_BE_74 3m HORN 91200-HF HORIZONTAL</p>	<p>Site : 03CH11-HY Condition : PEAK_74 3m HORN 91200-HF HORIZONTAL</p>
Avg.	<p>Site : 03CH11-HY Condition : AVG_BE_54 3m HORN 91200-HF HORIZONTAL</p>	Left blank

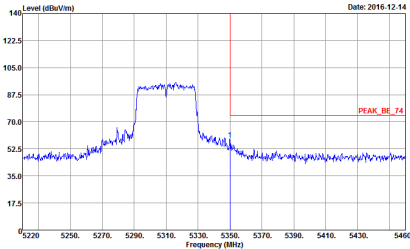
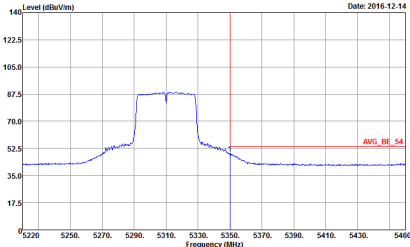

WIFI	Band 2 5250~5350MHz Band Edge @ 3m	
ANT	802.11n HT40 CH62 5310 MHz - R	
1	Horizontal	Fundamental
<p>Peak</p>	 <p>Date: 2016-12-14</p> <p>Site : 03CHI1-HY Condition : PEAK_BE_74 3m HORN 9120D-HF HORIZONTAL</p>	<p>Left blank</p>
<p>Avg.</p>	 <p>Date: 2016-12-14</p> <p>Site : 03CHI1-HY Condition : AVG_BE_54 3m HORN 9120D-HF HORIZONTAL</p>	<p>Left blank</p>

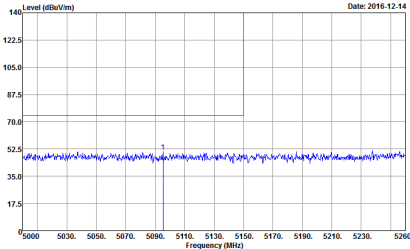
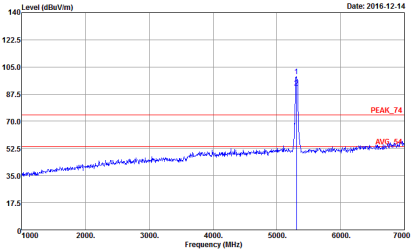
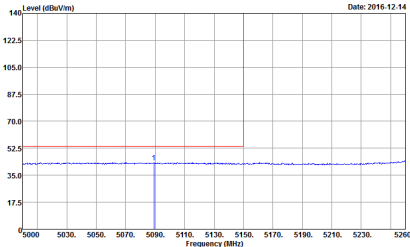

WIFI	Band 2 5250~5350MHz Band Edge @ 3m	
ANT	802.11n HT40 CH62 5310 MHz - L	
1	Vertical	Fundamental
Peak	 <p>Site : 03CHI1-HY Condition : PEAK_BE_74 3m HORN 91200-HF VERTICAL</p>	 <p>Site : 03CHI1-HY Condition : PEAK_74 3m HORN 91200-HF VERTICAL</p>
Avg.	 <p>Site : 03CHI1-HY Condition : AVG_BE_54 3m HORN 91200-HF VERTICAL</p>	Left blank

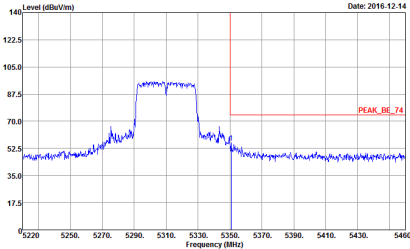
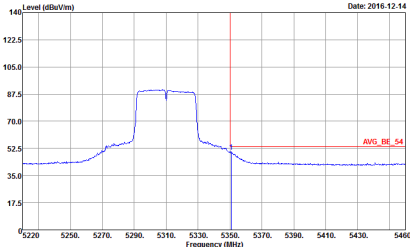

WIFI	Band 2 5250~5350MHz Band Edge @ 3m	
ANT	802.11n HT40 CH62 5310 MHz - R	
1	Vertical	Fundamental
Peak	 <p>Date: 2016-12-14</p> <p>Site : 03CHI1-HY Condition : PEAK_BE_74 3m HORN 9120D-HF VERTICAL</p>	Left blank
Avg.	 <p>Date: 2016-12-14</p> <p>Site : 03CHI1-HY Condition : AVG_BE_54 3m HORN 9120D-HF VERTICAL</p>	Left blank



Band 2 - 5250~5350MHz

WIFI 802.11a (Harmonic @ 3m)

WIFI	Band 2 5250~5350MHz Harmonic @ 3m	
ANT	802.11a CH52 5260MHz	
1	Horizontal	Vertical
<p>Peak Avg.</p>	<p>Site : 03CH11-HY Condition : PEAK_74 3m 9170 SHF HORM_150809 HORIZONTAL</p>	<p>Site : 03CH11-HY Condition : PEAK_74 3m 9170 SHF HORM_150809 VERTICAL</p>

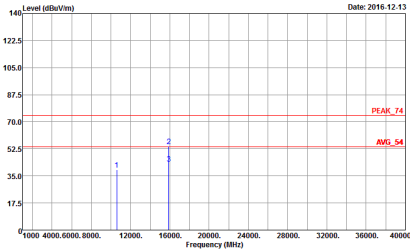
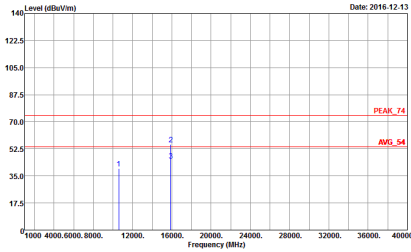

WIFI	Band 2 5250~5350MHz Harmonic @ 3m	
ANT	802.11a CH60 5300MHz	
1	Horizontal	Vertical
<p>Peak Avg.</p>	 <p>Site : 03CH11-HY Condition : PEAK_74 3m 9170 SHF HORM_150809 HORIZONTAL</p>	 <p>Site : 03CH11-HY Condition : PEAK_74 3m 9170 SHF HORM_150809 VERTICAL</p>

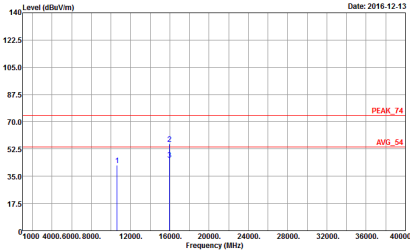
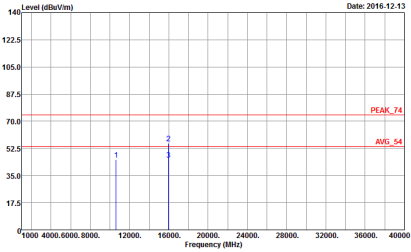

WIFI	Band 2 5250~5350MHz Harmonic @ 3m	
ANT	802.11a CH64 5320MHz	
1	Horizontal	Vertical
Peak Avg.	 <p>Site : 03CH11-HY Condition : PEAK_74 3m 9170 SHF HORM_150809 HORIZONTAL</p>	 <p>Site : 03CH11-HY Condition : PEAK_74 3m 9170 SHF HORM_150809 VERTICAL</p>



Band 2 5250~5350MHz
WIFI 802.11n HT20 (Harmonic @ 3m)

WIFI	Band 2 5250~5350MHz Harmonic @ 3m	
ANT	802.11n HT20 CH52 5260MHz	
1	Horizontal	Vertical
Peak Avg.	<p>Site : 03CH11-HY Condition : PEAK_74 3m 9170 SHF HORM_150809 HORIZONTAL</p>	<p>Site : 03CH11-HY Condition : PEAK_74 3m 9170 SHF HORM_150809 VERTICAL</p>



WIFI	Band 2 5250~5350MHz Harmonic @ 3m	
ANT	802.11n HT20 CH60 5300MHz	
1	Horizontal	Vertical
Peak Avg.	<p>Site : 03CH11-HY Condition : PEAK_74 3m 9170 SHF HORM_150809 HORIZONTAL</p>	<p>Site : 03CH11-HY Condition : PEAK_74 3m 9170 SHF HORM_150809 VERTICAL</p>



WIFI	Band 2 5250~5350MHz Harmonic @ 3m	
ANT	802.11n HT20 CH64 5320MHz	
1	Horizontal	Vertical
Peak Avg.	<p>Site : 03CH11-HY Condition : PEAK_74 3m 9170 SHF HORM_150809 HORIZONTAL</p>	<p>Site : 03CH11-HY Condition : PEAK_74 3m 9170 SHF HORM_150809 VERTICAL</p>



Band 2 5250~5350MHz
WIFI 802.11n HT40 (Harmonic @ 3m)

WIFI	Band 2 5250~5350MHz Harmonic @ 3m	
ANT	802.11n HT40 CH54 5270 MHz	
1	Horizontal	Vertical
Peak Avg.	<p>Site : 03CH11-HY Condition : PEAK_74 3m 9170 SHF HORM_150809 HORIZONTAL</p>	<p>Site : 03CH11-HY Condition : PEAK_74 3m 9170 SHF HORM_150809 VERTICAL</p>



WIFI	Band 2 5250~5350MHz Harmonic @ 3m	
ANT	802.11n HT40 CH62 5310 MHz	
1	Horizontal	Vertical
Peak Avg.	<p>Site : 03CH11-HY Condition : PEAK_74 3m 9170 SHF HORM_150809 HORIZONTAL</p>	<p>Site : 03CH11-HY Condition : PEAK_74 3m 9170 SHF HORM_150809 VERTICAL</p>



Band 3 - 5470~5725MHz

WIFI 802.11a (Band Edge @ 3m)

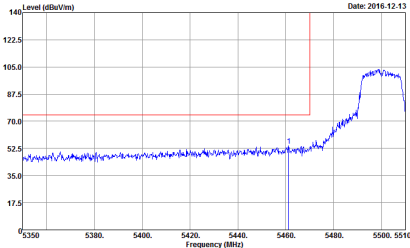
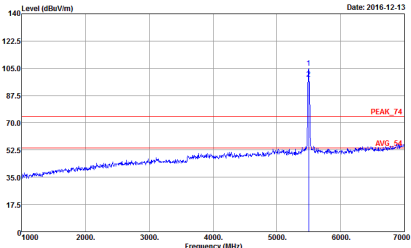
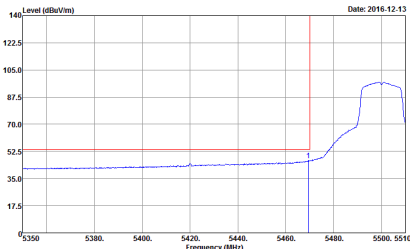
WIFI	Band 3 5470~5725MHz Band Edge @ 3m	
ANT	802.11a CH100 5500MHz	
1	Horizontal	Fundamental
Peak	 <p>Date: 2016-12-13</p> <p>Site : 03CH11-HY Condition : PEAK_BE_74 3m HORN 9120D-HF HORIZONTAL</p>	 <p>Date: 2016-12-13</p> <p>Site : 03CH11-HY Condition : PEAK_74 3m HORN 9120D-HF HORIZONTAL</p>
Avg.	 <p>Date: 2016-12-13</p> <p>Site : 03CH11-HY Condition : AV6_BE_54 3m HORN 9120D-HF HORIZONTAL</p>	Left blank

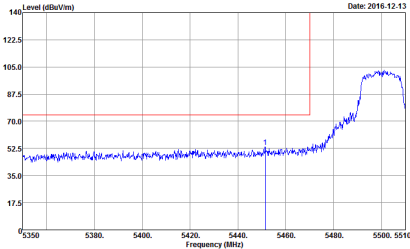
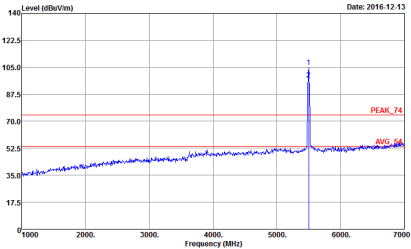
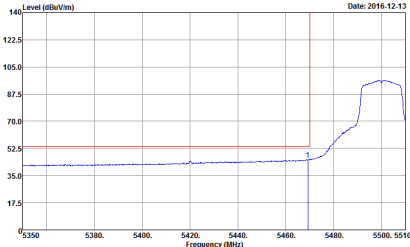

WIFI	Band 3 5470~5725MHz Band Edge @ 3m	
ANT	802.11a CH100 5500MHz	
1	Vertical	Fundamental
Peak	 <p>Date: 2016-12-13</p> <p>Site : 03CH11-HY Condition : PEAK_BE_74 3m HORN 9120D-HF VERTICAL</p>	 <p>Date: 2016-12-13</p> <p>Site : 03CH11-HY Condition : PEAK_74 3m HORN 9120D-HF VERTICAL</p>
Avg.	 <p>Date: 2016-12-13</p> <p>Site : 03CH11-HY Condition : AVG_BE_54 3m HORN 9120D-HF VERTICAL</p>	Left blank



WIFI	Band 3 5470~5725MHz Band Edge @ 3m	
ANT	802.11a CH116 5580MHz - L	
1	Horizontal	Fundamental
Peak	<p>Site : 03CH11-HY Condition : PEAK_BE_74 3m HORN 91200-HF HORIZONTAL</p>	<p>Site : 03CH11-HY Condition : PEAK_74 3m HORN 91200-HF HORIZONTAL</p>
Avg.	<p>Site : 03CH11-HY Condition : AVG_BE_54 3m HORN 91200-HF HORIZONTAL</p>	Left blank

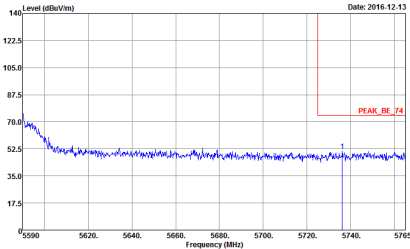
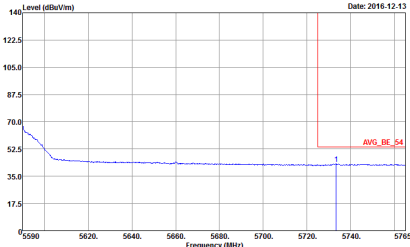

WIFI	Band 3 5470~5725MHz Band Edge @ 3m	
ANT	802.11a CH116 5580MHz - R	
1	Horizontal	Fundamental
Peak	 <p>Date: 2016-12-13</p> <p>Site : 03CH11-HY Condition : PEAK_BE_74 3m HORN 9120D-HF HORIZONTAL</p>	Left blank
Avg.	 <p>Date: 2016-12-13</p> <p>Site : 03CH11-HY Condition : AVG_BE_54 3m HORN 9120D-HF HORIZONTAL</p>	Left blank



WIFI	Band 3 5470~5725MHz Band Edge @ 3m	
ANT	802.11a CH116 5580MHz - L	
1	Vertical	Fundamental
Peak	<p>Site : 03CH11-HY Condition : PEAK_BE_74 3m HORN 9120D-HF VERTICAL</p>	<p>Site : 03CH11-HY Condition : PEAK_74 3m HORN 9120D-HF VERTICAL</p>
Avg.	<p>Site : 03CH11-HY Condition : AVG_BE_54 3m HORN 9120D-HF VERTICAL</p>	Left blank

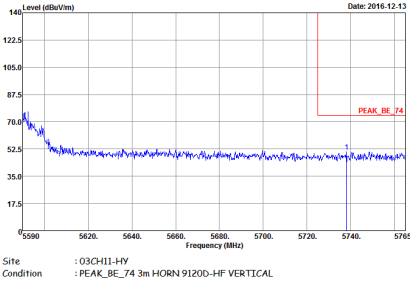
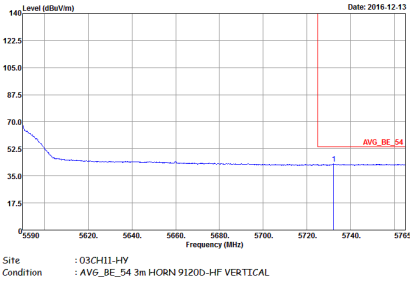

WIFI	Band 3 5470~5725MHz Band Edge @ 3m	
ANT	802.11a CH116 5580MHz - R	
1	Vertical	Fundamental
Peak	 <p>Site : 03CH11-HY Condition : PEAK_BE_74 3m HORN 9120D-HF VERTICAL</p>	Left blank
Avg.	 <p>Site : 03CH11-HY Condition : AVG_BE_54 3m HORN 9120D-HF VERTICAL</p>	Left blank

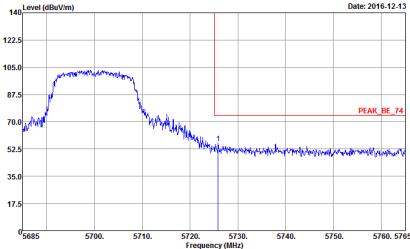
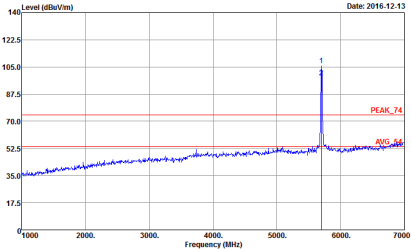
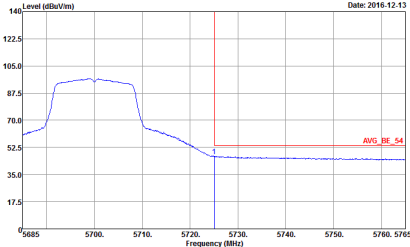

WIFI	Band 3 5470~5725MHz Band Edge @ 3m	
ANT	802.11a CH140 5700MHz	
1	Horizontal	Fundamental
Peak	 <p>Date: 2016-12-13</p> <p>Site : 03CH11-HY Condition : PEAK_BE_74 3m HORN 9120D-HF HORIZONTAL</p>	 <p>Date: 2016-12-13</p> <p>Site : 03CH11-HY Condition : PEAK_74 3m HORN 9120D-HF HORIZONTAL</p>
Avg.	 <p>Date: 2016-12-13</p> <p>Site : 03CH11-HY Condition : AVG_BE_54 3m HORN 9120D-HF HORIZONTAL</p>	Left blank



WIFI	Band 3 5470~5725MHz Band Edge @ 3m	
ANT	802.11a CH140 5700MHz	
1	Vertical	Fundamental
Peak	<p>Site : 03CHI1-HY Condition : PEAK_BE_74 3m HORN 9120D-HF VERTICAL</p>	<p>Site : 03CHI1-HY Condition : PEAK_74 3m HORN 9120D-HF VERTICAL</p>
Avg.	<p>Site : 03CHI1-HY Condition : AVG_BE_54 3m HORN 9120D-HF VERTICAL</p>	Left blank



**Band 3 5470~5725MHz
WIFI 802.11n HT20 (Band Edge @ 3m)**

WIFI	Band 3 5470~5725MHz Band Edge @ 3m	
ANT	802.11n HT20 CH100 5500MHz	
1	Horizontal	Fundamental
Peak	<p>Site : 03CH11-HY Condition : PEAK_BE_74 3m HORN 9120D-HF HORIZONTAL</p>	<p>Site : 03CH11-HY Condition : PEAK_74 3m HORN 9120D-HF HORIZONTAL</p>
Avg.	<p>Site : 03CH11-HY Condition : AVG_BE_54 3m HORN 9120D-HF HORIZONTAL</p>	Left blank



WIFI	Band 3 5470~5725MHz Band Edge @ 3m	
ANT	802.11n HT20 CH100 5500MHz	
1	Vertical	Fundamental
Peak	<p>Site : 03CH11-HY Condition : PEAK_BE_74 3m HORN 9120D-HF VERTICAL</p>	<p>Site : 03CH11-HY Condition : PEAK_74 3m HORN 9120D-HF VERTICAL</p>
Avg.	<p>Site : 03CH11-HY Condition : AVG_BE_54 3m HORN 9120D-HF VERTICAL</p>	Left blank

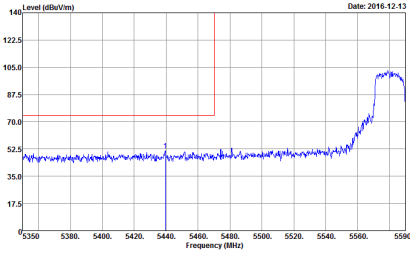
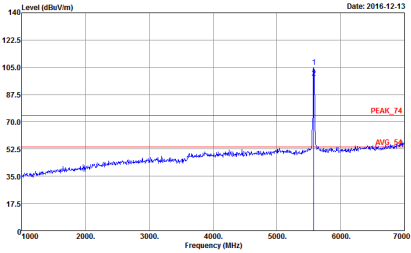
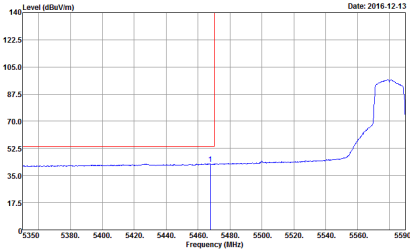

WIFI	Band 3 5470~5725MHz Band Edge @ 3m	
ANT	802.11n HT20 CH116 5580MHz - L	
1	Horizontal	Fundamental
Peak	 <p>Site : 03CH11-HY Condition : PEAK_BE_74 3m HORN 91200-HF HORIZONTAL</p>	 <p>Site : 03CH11-HY Condition : PEAK_74 3m HORN 91200-HF HORIZONTAL</p>
Avg.	 <p>Site : 03CH11-HY Condition : AVG_BE_54 3m HORN 91200-HF HORIZONTAL</p>	Left blank

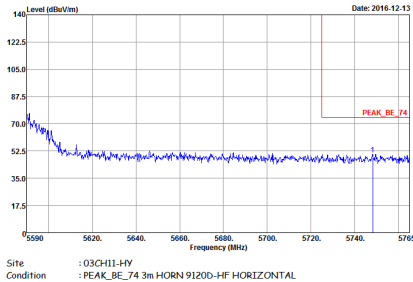
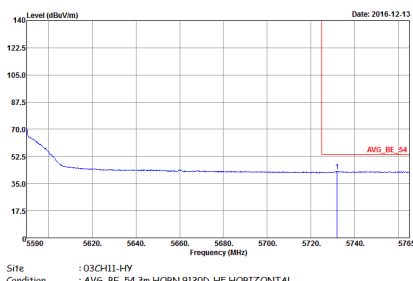

WIFI	Band 3 5470~5725MHz Band Edge @ 3m	
ANT	802.11n HT20 CH116 5580MHz - R	
1	Horizontal	Fundamental
Peak	 <p>Site : 03CH11-HY Condition : PEAK_BE_74 3m HORN 9120D-HF HORIZONTAL</p>	Left blank
Avg.	 <p>Site : 03CH11-HY Condition : AVG_BE_54 3m HORN 9120D-HF HORIZONTAL</p>	Left blank



WIFI	Band 3 5470~5725MHz Band Edge @ 3m	
ANT	802.11n HT20 CH116 5580MHz - L	
1	Vertical	Fundamental
Peak	<p>Date: 2016-12-13</p> <p>Site : 03CH11-HY Condition : PEAK_BE_74 3m HORN 91200-HF VERTICAL</p>	<p>Date: 2016-12-13</p> <p>Site : 03CH11-HY Condition : PEAK_74 3m HORN 91200-HF VERTICAL</p>
Avg.	<p>Date: 2016-12-13</p> <p>Site : 03CH11-HY Condition : AV6_BE_54 3m HORN 91200-HF VERTICAL</p>	Left blank

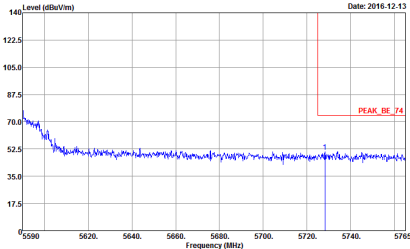
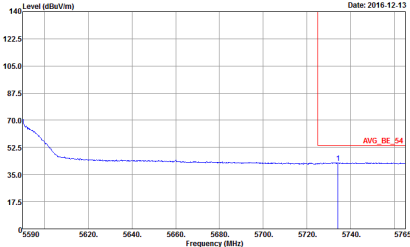

WIFI	Band 3 5470~5725MHz Band Edge @ 3m	
ANT	802.11n HT20 CH116 5580MHz - R	
1	Vertical	Fundamental
Peak	 <p>Date: 2016-12-13</p> <p>Site : 03CH11-HY Condition : PEAK_BE_74 3m HORN 9120D-HF VERTICAL</p>	Left blank
Avg.	 <p>Date: 2016-12-13</p> <p>Site : 03CH11-HY Condition : AVG_BE_54 3m HORN 9120D-HF VERTICAL</p>	Left blank

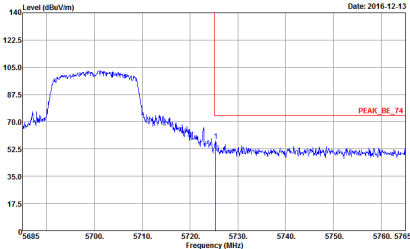
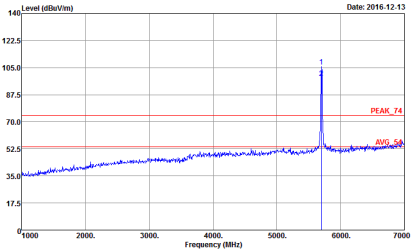
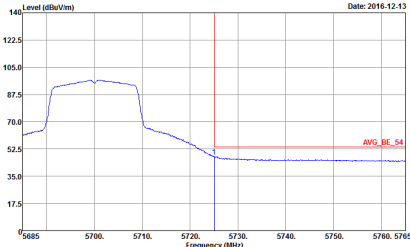

WIFI	Band 3 5470~5725MHz Band Edge @ 3m	
ANT	802.11n HT20 CH140 5700MHz	
1	Horizontal	Fundamental
Peak	 <p>Date: 2016-12-13</p> <p>Site : 03CH11-HY Condition : PEAK_BE_74 3m HORN 91200-HF HORIZONTAL</p>	 <p>Date: 2016-12-13</p> <p>Site : 03CH11-HY Condition : PEAK_74 3m HORN 91200-HF HORIZONTAL</p>
Avg.	 <p>Date: 2016-12-13</p> <p>Site : 03CH11-HY Condition : AVG_BE_54 3m HORN 91200-HF HORIZONTAL</p>	Left blank

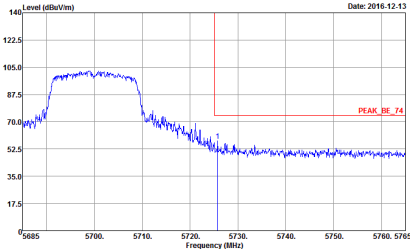
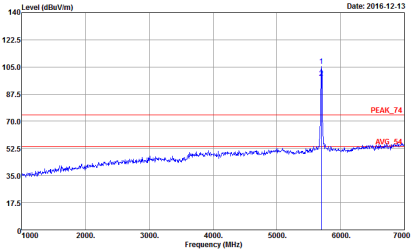
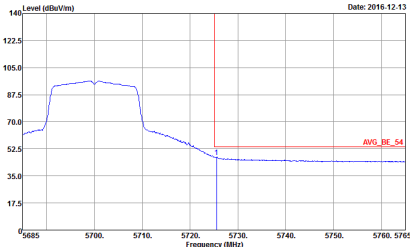

WIFI	Band 3 5470~5725MHz Band Edge @ 3m	
ANT	802.11n HT20 CH140 5700MHz	
1	Vertical	Fundamental
Peak.	 <p>Date: 2016-12-13</p> <p>Site : 03CH11-HY Condition : PEAK_BE_74 3m HORN 9120D-HF VERTICAL</p>	 <p>Date: 2016-12-13</p> <p>Site : 03CH11-HY Condition : PEAK_74 3m HORN 9120D-HF VERTICAL</p>
Avg.	 <p>Date: 2016-12-13</p> <p>Site : 03CH11-HY Condition : AVG_BE_54 3m HORN 9120D-HF VERTICAL</p>	Left blank

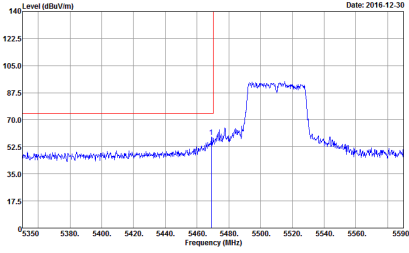
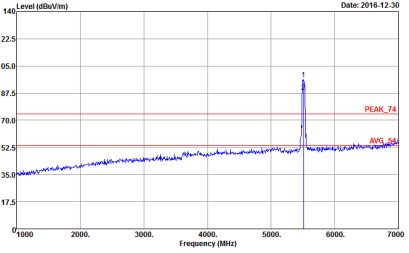
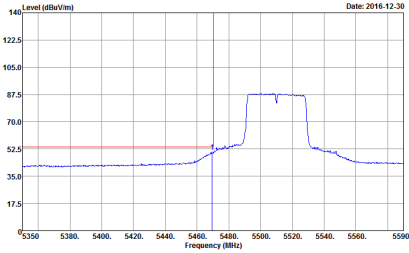

**Band 3 5470~5725MHz
WIFI 802.11n HT40 (Band Edge @ 3m)**

WIFI	Band 3 5470~5725MHz Band Edge @ 3m	
ANT	802.11n HT40 CH102 5510MHz - L	
1	Horizontal	Fundamental
Peak	 <p>Site : 03CH11-HY Condition : PEAK_BE_74 3m HORN 91200-HF HORIZONTAL</p>	 <p>Site : 03CH11-HY Condition : PEAK_74 3m HORN 91200-HF HORIZONTAL</p>
Avg.	 <p>Site : 03CH11-HY Condition : AVG_BE_54 3m HORN 91200-HF HORIZONTAL</p>	Left blank



WIFI	Band 3 5470~5725MHz Band Edge @ 3m	
ANT	802.11n HT40 CH102 5510MHz - R	
1	Horizontal	Fundamental
Peak	<p>Site : 03CH11-HY Condition : PEAK_BE_74 3m HORN 9120D-HF HORIZONTAL</p>	Left blank
Avg.	<p>Site : 03CH11-HY Condition : AVG_BE_54 3m HORN 9120D-HF HORIZONTAL</p>	Left blank



WIFI	Band 3 5470~5725MHz Band Edge @ 3m	
ANT	802.11n HT40 CH102 5510MHz - L	
1	Vertical	Fundamental
Peak	<p>Site : 03CH11-HY Condition : PEAK_BE_74 3m HORN 91200-HF VERTICAL</p>	<p>Site : 03CH11-HY Condition : PEAK_74 3m HORN 91200-HF VERTICAL</p>
Avg.	<p>Site : 03CH11-HY Condition : AVG_BE_54 3m HORN 91200-HF VERTICAL</p>	Left blank



WIFI	Band 3 5470~5725MHz Band Edge @ 3m	
ANT	802.11n HT40 CH102 5510MHz - R	
1	Vertical	Fundamental
Peak	<p>Site : 03CH11-HY Condition : PEAK_BE_74 3m HORN 9120D-HF VERTICAL</p>	Left blank
Avg.	<p>Site : 03CH11-HY Condition : AVG_BE_54 3m HORN 9120D-HF VERTICAL</p>	Left blank

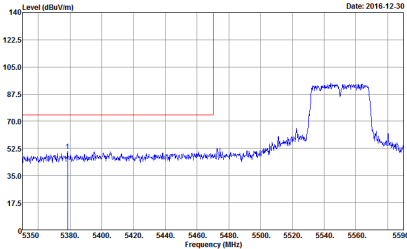
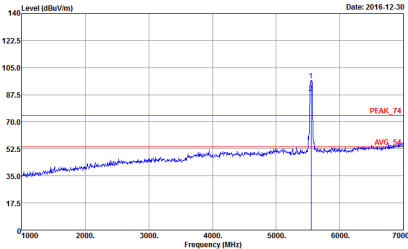
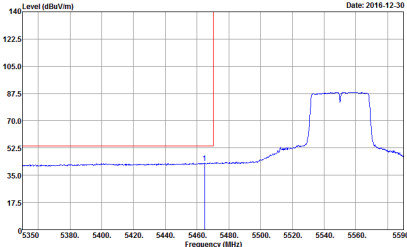

WIFI	Band 3 5470~5725MHz Band Edge @ 3m	
ANT	802.11n HT40 CH110 5550MHz - L	
1	Horizontal	Fundamental
Peak	 <p>Date: 2016-12-30</p> <p>Site : 03CH11-HY Condition : PEAK_BE_74 3m HORN 91200-HF HORIZONTAL</p>	 <p>Date: 2016-12-30</p> <p>Site : 03CH11-HY Condition : PEAK_74 3m HORN 91200-HF HORIZONTAL</p>
Avg.	 <p>Date: 2016-12-30</p> <p>Site : 03CH11-HY Condition : AVG_BE_54 3m HORN 91200-HF HORIZONTAL</p>	Left blank



WIFI	Band 3 5470~5725MHz Band Edge @ 3m	
ANT	802.11n HT40 CH110 5550MHz - R	
1	Horizontal	Fundamental
Peak	<p>Site : 03CH11-HY Condition : PEAK_BE_74 3m HORN 9120D-HF HORIZONTAL</p>	Left blank
Avg.	<p>Site : 03CH11-HY Condition : AVG_BE_54 3m HORN 9120D-HF HORIZONTAL</p>	Left blank



WIFI	Band 3 5470~5725MHz Band Edge @ 3m	
ANT	802.11n HT40 CH110 5550MHz - L	
1	Vertical	Fundamental
Peak	<p>Date: 2016-12-30</p> <p>Site : 03CH11-HY Condition : PEAK_BE_74 3m HORN 9120D-HF VERTICAL</p>	<p>Date: 2016-12-30</p> <p>Site : 03CH11-HY Condition : PEAK_74 3m HORN 9120D-HF VERTICAL</p>
Avg.	<p>Date: 2016-12-30</p> <p>Site : 03CH11-HY Condition : AVG_BE_54 3m HORN 9120D-HF VERTICAL</p>	Left blank



WIFI	Band 3 5470~5725MHz Band Edge @ 3m	
ANT	802.11n HT40 CH110 5550MHz - R	
1	Vertical	Fundamental
Peak	<p>Site : 03CH11-HY Condition : PEAK_BE_74 3m HORN 9120D-HF VERTICAL</p>	Left blank
Avg.	<p>Site : 03CH11-HY Condition : AVG_BE_54 3m HORN 9120D-HF VERTICAL</p>	Left blank

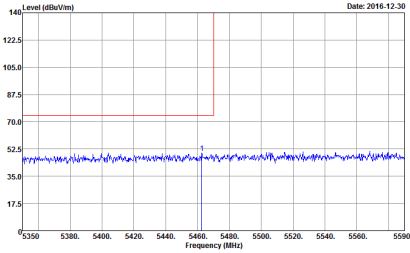
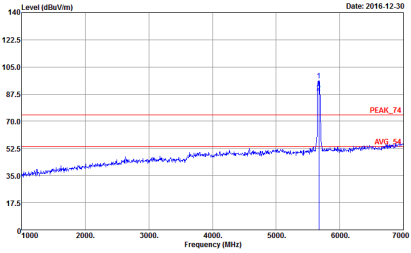
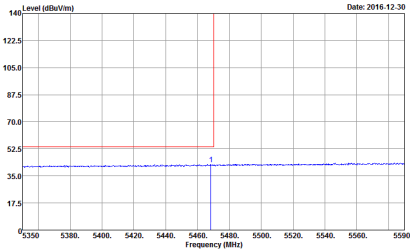

WIFI	Band 3 5470~5725MHz Band Edge @ 3m	
ANT	802.11n HT40 CH134 5670MHz - L	
1	Horizontal	Fundamental
Peak	 <p>Date: 2016.12.30</p> <p>Site : 03CH11-HY Condition : PEAK_BE_74 3m HORN 91200-HF HORIZONTAL</p>	 <p>Date: 2016.12.30</p> <p>Site : 03CH11-HY Condition : PEAK_74 3m HORN 91200-HF HORIZONTAL</p>
Avg.	 <p>Date: 2016.12.30</p> <p>Site : 03CH11-HY Condition : AVG_BE_54 3m HORN 91200-HF HORIZONTAL</p>	Left blank



WIFI	Band 3 5470~5725MHz Band Edge @ 3m	
ANT	802.11n HT40 CH134 5670MHz - R	
1	Horizontal	Fundamental
Peak	<p>Site : 03CH11-HY Condition : PEAK_BE_74 3m HORN 9120D-HF HORIZONTAL</p>	Left blank
Avg.	<p>Site : 03CH11-HY Condition : AVG_BE_54 3m HORN 9120D-HF HORIZONTAL</p>	Left blank



WIFI	Band 3 5470~5725MHz Band Edge @ 3m	
ANT	802.11n HT40 CH134 5670MHz - L	
1	Vertical	Fundamental
Peak	<p>Site : 03CH11-HY Condition : PEAK_BE_74 3m HORN 91200-HF VERTICAL</p>	<p>Site : 03CH11-HY Condition : PEAK_74 3m HORN 91200-HF VERTICAL</p>
Avg.	<p>Site : 03CH11-HY Condition : AVG_BE_54 3m HORN 91200-HF VERTICAL</p>	Left blank



WIFI	Band 3 5470~5725MHz Band Edge @ 3m	
ANT	802.11n HT40 CH134 5670MHz - R	
1	Vertical	Fundamental
Peak	<p>Site : 03CH11-HY Condition : PEAK_BE_74 3m HORN 9120D-HF VERTICAL</p>	Left blank
Avg.	<p>Site : 03CH11-HY Condition : AVG_BE_54 3m HORN 9120D-HF VERTICAL</p>	Left blank



Band 3 - 5470~5725MHz

WIFI 802.11a (Harmonic @ 3m)

WIFI	Band 3 5470~5725MHz Harmonic @ 3m	
ANT	802.11a CH100 5500MHz	
1	Horizontal	Vertical
Peak Avg.	<p>Site : 03CH11-HY Condition : PEAK_74 3m 9170 SHF HORM_150809 HORIZONTAL</p>	<p>Site : 03CH11-HY Condition : PEAK_74 3m 9170 SHF HORM_150809 VERTICAL</p>



WIFI	Band 3 5470~5725MHz Harmonic @ 3m	
ANT	802.11a CH116 5580MHz	
1	Horizontal	Vertical
Peak Avg.	<p>Site : 03CH11-HY Condition : PEAK_74 3m 9170 SHF HORM_150809 HORIZONTAL</p>	<p>Site : 03CH11-HY Condition : PEAK_74 3m 9170 SHF HORM_150809 VERTICAL</p>



WIFI	Band 3 5470~5725MHz Harmonic @ 3m	
ANT	802.11a CH140 5700MHz	
1	Horizontal	Vertical
Peak Avg.	<p>Site : 03CH11-HY Condition : PEAK_74 3m 9170 SHF HORM_150809 HORIZONTAL</p>	<p>Site : 03CH11-HY Condition : PEAK_74 3m 9170 SHF HORM_150809 VERTICAL</p>



Band 3 5470~5725MHz
WIFI 802.11n HT20 (Harmonic @ 3m)

WIFI	Band 3 5470~5725MHz Harmonic @ 3m	
ANT	802.11n HT20 CH100 5500MHz	
1	Horizontal	Vertical
Peak Avg.	<p>Site : 03CH11-HY Condition : PEAK_74 3m 9170 SHF HORM_150809 HORIZONTAL</p>	<p>Site : 03CH11-HY Condition : PEAK_74 3m 9170 SHF HORM_150809 VERTICAL</p>



WIFI	Band 3 5470~5725MHz Harmonic @ 3m	
ANT	802.11n HT20 CH116 5580MHz	
1	Horizontal	Vertical
Peak Avg.	<p>Site : 03CH11-HY Condition : PEAK_74 3m 9170 SHF HORM_150809 HORIZONTAL</p>	<p>Site : 03CH11-HY Condition : PEAK_74 3m 9170 SHF HORM_150809 VERTICAL</p>

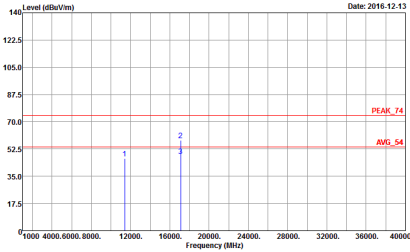
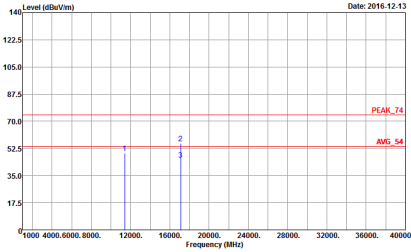

WIFI	Band 3 5470~5725MHz Harmonic @ 3m	
ANT	802.11n HT20 CH140 5700MHz	
1	Horizontal	Vertical
<p>Peak Avg.</p>	 <p>Date: 2016.12.13</p> <p>Site : 03CH11-HY Condition : PEAK_74 3m 9170 SHF HORM_150809 HORIZONTAL</p>	 <p>Date: 2016.12.13</p> <p>Site : 03CH11-HY Condition : PEAK_74 3m 9170 SHF HORM_150809 VERTICAL</p>



Band 3 5470~5725MHz
WIFI 802.11n HT40 (Harmonic @ 3m)

WIFI	Band 3 5470~5725MHz Harmonic @ 3m	
ANT	802.11n HT40 CH102 5510MHz	
1	Horizontal	Vertical
Peak Avg.	<p>Site : 03CH11-HY Condition : PEAK_74 3m 9170 SHF HORM_150809 HORIZONTAL</p>	<p>Site : 03CH11-HY Condition : PEAK_74 3m 9170 SHF HORM_150809 VERTICAL</p>

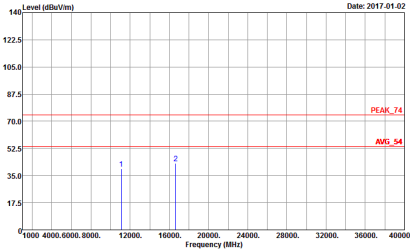
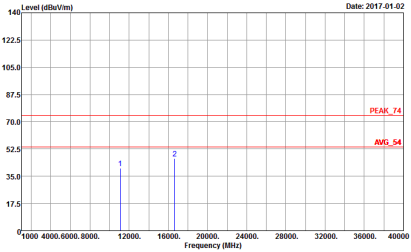

WIFI	Band 3 5470~5725MHz Harmonic @ 3m	
ANT	802.11n HT40 CH110 5550MHz	
1	Horizontal	Vertical
Peak Avg.	 <p>Site : 03CH11-HY Condition : PEAK_74 3m 9170 SHF HORM_150809 HORIZONTAL</p>	 <p>Site : 03CH11-HY Condition : PEAK_74 3m 9170 SHF HORM_150809 VERTICAL</p>



WIFI	Band 3 5470~5725MHz Harmonic @ 3m	
ANT	802.11n HT40 CH134 5670MHz	
1	Horizontal	Vertical
Peak Avg.	<p>Site : 03CH11-HY Condition : PEAK_74 3m 9170 SHF HORM_150809 HORIZONTAL</p>	<p>Site : 03CH11-HY Condition : PEAK_74 3m 9170 SHF HORM_150809 VERTICAL</p>



Emission below 1GHz
5GHz WIFI 802.11a (LF)

WIFI	5GHz WIFI	
ANT	802.11a LF	
1	Horizontal	Vertical
QP / Peak	<p>Site : 03CH11-HY Condition : QP 3m BI-LOG 6111D-LF_ETC HORIZONTAL</p>	<p>Site : 03CH11-HY Condition : QP 3m BI-LOG 6111D-LF_ETC VERTICAL</p>



Emission below 1GHz
5GHz WIFI 802.11n HT20 (LF)

WIFI	5GHz WIFI	
ANT	802.11n HT20 LF	
1	Horizontal	Vertical
QP / Peak	<p>Site : 03CH11-HY Condition : QP 3m BI-LOG 6111D-LF_ETC HORIZONTAL</p>	<p>Site : 03CH11-HY Condition : QP 3m BI-LOG 6111D-LF_ETC VERTICAL</p>



Emission below 1GHz
5GHz WIFI 802.11n HT40 (LF)

WIFI	5GHz WIFI	
ANT	802.11n HT40 LF	
1	Horizontal	Vertical
QP / Peak	<p>Horizontal</p>	<p>Vertical</p>

Appendix D Duty Cycle Plots

Band	Duty Cycle(%)	T(us)	1/T(kHz)	VBW Setting
802.11a	97.77	1434	0.70	1kHz
5GHz 802.11n HT20	97.02	1364	0.73	1kHz
5GHz 802.11n HT40	94.37	682	1.47	3kHz

802.11a

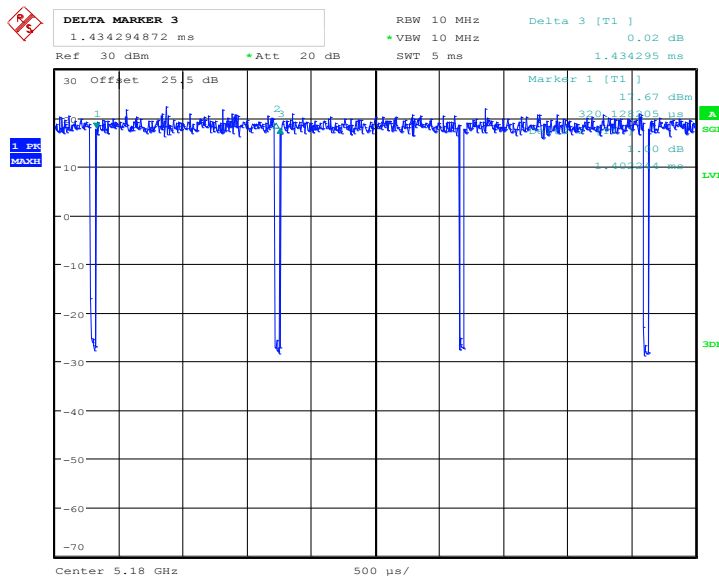

Date: 3.DEC.2016 01:08:41



5GHz 802.11n HT20

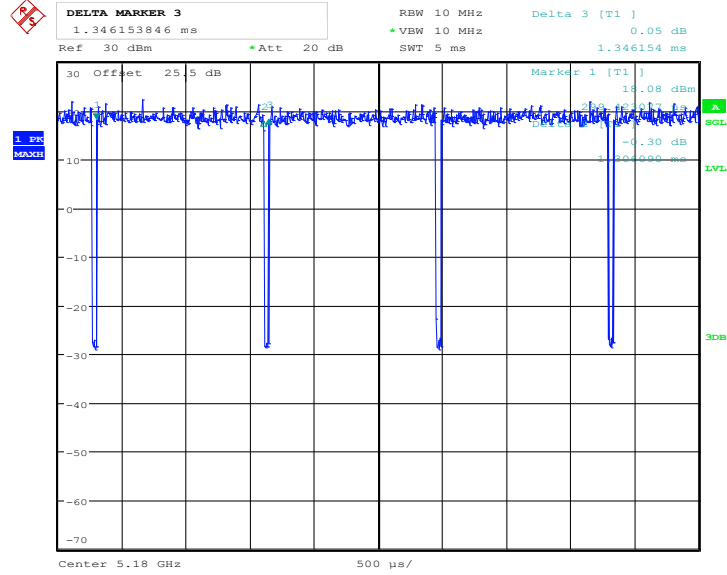

Date: 3.DEC.2016 01:10:00

5GHz 802.11n HT40

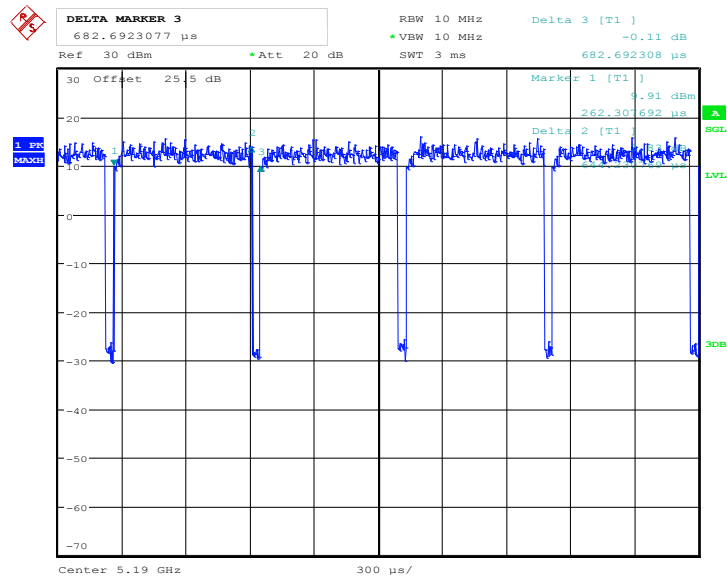

Date: 3.DEC.2016 01:12:25