



FCC RF Test Report

APPLICANT : Sony Mobile Communications Inc.
EQUIPMENT : GSM/WCDMA/LTE Phone+Bluetooth, DTS/UNII a/b/g/n and NFC
BRAND NAME : Sony
FCC ID : PY7-19719M
STANDARD : FCC Part 15 Subpart C §15.225
CLASSIFICATION : (DXX) Low Power Communication Device Transmitter

The testing was completed on Dec. 23, 2016. We, SPORTON INTERNATIONAL INC., would like to declare that the tested sample has been evaluated in accordance with the test procedures and has been in compliance with the applicable technical standards.

The test results in this report apply exclusively to the tested model / sample. Without written approval of SPORTON INTERNATIONAL INC., the test report shall not be reproduced except in full.

Reviewed by: Joseph Lin / Supervisor

Approved by: Jones Tsai / Manager



SPORTON INTERNATIONAL INC.

No. 52, Hwa Ya 1st Rd., Hwa Ya Technology Park, Kwei-Shan District, Tao Yuan City, Taiwan, R.O.C.



TABLE OF CONTENTS

SUMMARY OF THE TEST RESULT4

1. GENERAL INFORMATION.....5

1.1 Applicant..... 5

1.2 Manufacturer 5

1.3 Product Feature of Equipment Under Test 5

1.4 Product Specification of Equipment Under Test 6

1.5 Modification of EUT 6

1.6 Testing Location 7

1.7 Applicable Standards..... 7

2. TEST CONFIGURATION OF EQUIPMENT UNDER TEST8

2.1 Descriptions of Test Mode 8

2.2 Connection Diagram of Test System 8

2.3 Table for Supporting Units 9

2.4 EUT Operation Test Setup 9

3. TEST RESULTS.....10

3.1 AC Power Line Conducted Emissions Measurement 10

3.2 20dB and 99% OBW Spectrum Bandwidth Measurement..... 12

3.3 Frequency Stability Measurement 13

3.4 Field Strength of Fundamental Emissions and Mask Measurement..... 14

3.5 Radiated Emissions Measurement 16

3.6 Antenna Requirements..... 19

4. LIST OF MEASURING EQUIPMENT20

APPENDIX A. TEST RESULTS OF CONDUCTED EMISSION TEST

APPENDIX B. TEST RESULTS OF CONDUCTED TEST ITEMS

B1. Test Result of 20dB Spectrum Bandwidth

B2. Test Result of Frequency Stability

APPENDIX C. TEST RESULTS OF RADIATED TEST ITEMS

C1. Test Result of Field Strength of Fundamental Emissions

C2. Results of Radiated Emissions (9 kHz~30MHz)

C3. Results of Radiated Emissions (30MHz~1GHz)

APPENDIX D. VERIFICATION OF RADIATED SPURIOUS EMISSIONS AT OPEN-AREA TEST SITE

D.1 Results of Radiated Emissions (9 kHz~30MHz)

D.2 LIST OF MEASURING EQUIPMENT



SUMMARY OF THE TEST RESULT

| Applied Standard: 47 CFR FCC Part 15 Subpart C | | | | |
|--|---------------------|---|----------|--------------------------------------|
| Part | FCC Rule | Description of Test | Result | Under Limit |
| 3.1 | 15.207 | AC Power Line Conducted Emissions | Complies | 18.20 dB at 0.150MHz |
| 3.2 | 15.215(c) | 20dB Spectrum Bandwidth | Complies | - |
| | - | 99% OBW Spectrum Bandwidth | Complies | - |
| 3.3 | 15.225(e) | Frequency Stability | Complies | - |
| 3.4 | 15.225(a)(b)(c) | Field Strength of Fundamental Emissions | Complies | 67.16 dB at 13.560 MHz |
| 3.5 | 15.225(d) 15.209 | Radiated Emissions | Complies | 3.18 dB at 40.680 MHz for Quasi-Peak |
| 3.6 | 15.203 | Antenna Requirements | Complies | - |

| Test Items | Uncertainty | Remark |
|------------------------------------|-------------|--------------------------|
| AC Power Line Conducted Emissions | ±2.70dB | Confidence levels of 95% |
| Radiated Emissions (30MHz~1000MHz) | ±5.70dB | Confidence levels of 95% |



1. GENERAL INFORMATION

1.1 Applicant

Sony Mobile Communications Inc.

4-12-3 Higashi-Shinagawa, Shinagawa-ku, Tokyo, 140-0002, Japan

1.2 Manufacturer

Sony Mobile Communications Inc.

4-12-3 Higashi-Shinagawa, Shinagawa-ku, Tokyo, 140-0002, Japan

1.3 Product Feature of Equipment Under Test

GSM/WCDMA/LTE, Bluetooth, DTS/UNII, a/b/g/n, GPS, and NFC

| Standards-related Product Specification | | | |
|---|------------|--------------|--------------------------|
| Antenna Type / Gain | | Loop Antenna | |
| EUT Information List | | | |
| HW Version | SW Version | S/N | Performed Test Item |
| A | 0.79 | RQ3003A29D | RF Conducted Measurement |
| | | RQ3003A299 | Radiated Emission |
| | | RQ3003BXX6 | AC Conducted Emission |



| Accessory List | |
|----------------|---|
| AC Adapter 1 | Model No. : UCH20 |
| | S/N : |
| | 1215W48600039 (for radiated spurious emission) 5816W13300005 (for conducted emission) |
| Earphone 1 | Model No. : MH410c |
| | S/N: |
| | 1632A8620000596 (for radiated spurious emission) 1632A864000088 (for conducted emission) |
| USB Cable | Model No. : UCB20 |
| | S/N : 1625A91900007E2 |

Note:

1. Above EUT list and accessory list used are electrically identical per declared by manufacturer.
2. Above the accessories list are used to exercise the EUT during test.
3. For other wireless features of this EUT, test report will be issued separately.

1.4 Product Specification of Equipment Under Test

| Standards-related Product Specification | |
|---|--------------------|
| Tx/Rx Frequency Range | 13.553 ~ 13.567MHz |
| Channel Number | 1 |
| 20dBW | 2.64 KHz |
| 99%OBW | 2.24 KHz |
| Type of Modulation | ASK |

Remark: The above EUT's information was declared by manufacturer. Please refer to the specifications or user's manual for more detailed description.

1.5 Modification of EUT

No modifications are made to the EUT during all test items.



1.6 Testing Location

Sporton Lab is accredited to ISO 17025 by Taiwan Accreditation Foundation (TAF code : 1190) and the FCC designation No. TW1190 under the FCC 2.948(e) by Mutual Recognition Agreement (MRA) in FCC Test.

| | | | |
|---------------------------|---|--------------|-----------|
| Test Site | SPORTON INTERNATIONAL INC. | | |
| Test Site Location | No. 52, Hwa Ya 1 st Rd., Hwa Ya Technology Park, Kwei-Shan District, Tao Yuan City, Taiwan, R.O.C. TEL: +886-3-3273456 / FAX: +886-3-3284978 | | |
| Test Site No. | Sporton Site No. | | |
| | TH03-HY | CO05-HY | 03CH07-HY |
| Test Engineer | William Liao | Arthur Hsieh | Jess Wang |
| Temperature | 22~24°C | 21~23°C | 21~22°C |
| Relative Humidity | 53~55% | 50~52% | 49~50% |

Note: The test site complies with ANSI C63.4 2014 requirement.

| | | | |
|---------------------------|--|--|--|
| Test Site | SPORTON INTERNATIONAL INC. | | |
| Test Site Location | No. 30-2, Dingfu Tsuen, Linkou District, New Taipei City, Taiwan 244, R.O.C. TEL: +886-2-2603-5367 / +886-2-2601-1640 FAX: +886-2-2601-1695 | | |
| Test Site No. | Sporton Site No. | | |
| | OS03-LK | | |
| Test Engineer | Eric Jeng | | |
| Temperature | 23~25°C | | |
| Relative Humidity | 51~54% | | |

Note: The test site complies with ANSI C63.4 2014 requirement.

1.7 Applicable Standards

According to the specifications of the manufacturer, the EUT must comply with the requirements of the following standards:

- ♦ FCC Part 15 Subpart C §15.225
- ♦ ANSI C63.10-2013

2. TEST CONFIGURATION OF EQUIPMENT UNDER TEST

2.1 Descriptions of Test Mode

Investigation has been done on all the possible configurations.

The following table is a list of the test modes shown in this test report.

| Test Items | |
|-----------------------------------|---|
| AC Power Line Conducted Emissions | Field Strength of Fundamental Emissions |
| 20dB Spectrum Bandwidth | Frequency Stability |
| Radiated Emissions 9kHz~30MHz | Radiated Emissions 30MHz~1GHz |

The worst type (type F) declared by manufacturer was used and recorded in this report.

2.2 Connection Diagram of Test System

<AC Conducted Emissions>

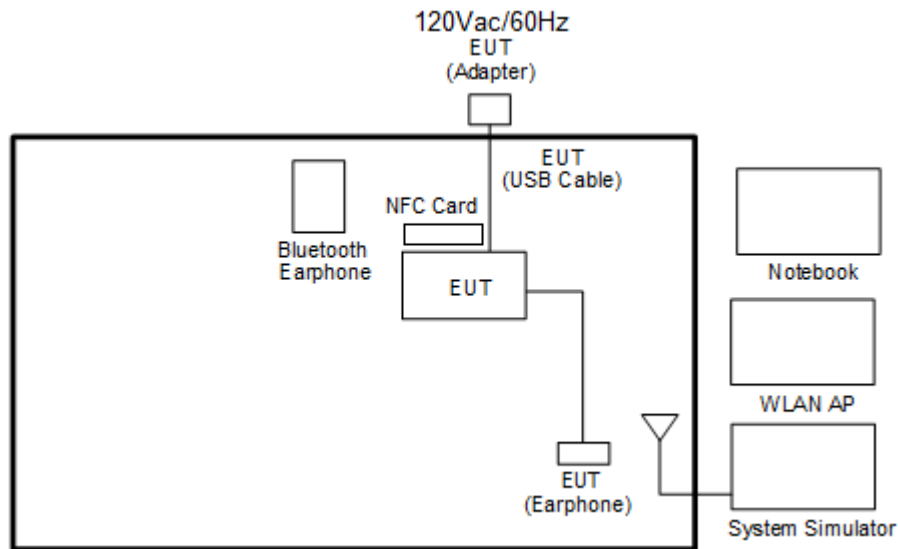

< For Fundamental Emissions and Mask and Radiated Emissions Measurement >

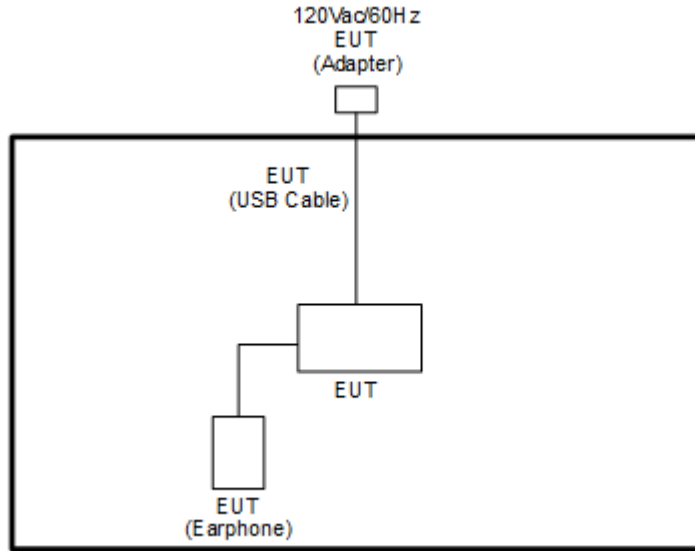

2.3 Table for Supporting Units

| Support Unit | Manufacturer | Model | FCC ID |
|--------------------|--------------|----------------|--|
| System Simulator | Anritsu | MT8820C | N/A |
| Bluetooth Earphone | Sony | SBH20 | PY7-RD0010 |
| WLAN AP | D-Link | DIR-628 | KA2DIR628A2 |
| Notebook | DELL | Latitude E6320 | FCC DoC/ Contains FCC ID: QDS-BRCM1054 |
| SD Card | SanDisk | MicroSD HC | FCC DoC |
| NFC Card | Metro Taipei | Easy Card | N/A |

2.4 EUT Operation Test Setup

The EUT was programmed to be in continuously transmitting mode.

The ancillary equipment, NFC card, is used to make the EUT (NFC) continuously transmit at 13.56MHz and is placed around 2 cm gap to the EUT.



3. TEST RESULTS

3.1 AC Power Line Conducted Emissions Measurement

3.1.1 Limit of AC Conducted Emission

For equipment that is designed to be connected to the public utility (AC) power line, the radio frequency voltage that is conducted back onto the AC power line on any frequency or frequencies within the band 150 kHz to 30 MHz shall not exceed the limits in the following table.

| Frequency of Emission (MHz) | Conducted Limit (dB μ V) | |
|--------------------------------|------------------------------|-----------|
| | Quasi-Peak | Average |
| 0.15-0.5 | 66 to 56* | 56 to 46* |
| 0.5-5 | 56 | 46 |
| 5-30 | 60 | 50 |

*Decreases with the logarithm of the frequency.

For terminal test result, the testing follows FCC KDB 174176.

3.1.2 Measuring Instruments

See list of measuring instruments of this test report.

3.1.3 Test Procedures

1. The EUT was placed 0.4 meter from the conducting wall of the shielding room, and it was kept at least 80 centimeters from any other grounded conducting surface.
2. Connect EUT to the power mains through a line impedance stabilization network (LISN).
3. All the support units are connecting to the other LISN.
4. The LISN provides 50 ohm coupling impedance for the measuring instrument.
5. The FCC states that a 50 ohm, 50 microhenry LISN should be used.
6. Both sides of AC line were checked for maximum conducted interference.
7. The frequency range from 150 kHz to 30 MHz was searched.
8. Set the test-receiver system to Peak Detect Function and specified bandwidth (IF Bandwidth = 9kHz) with Maximum Hold Mode. Then measurement is also conducted by Average Detector and Quasi-Peak Detector Function respectively.

3.1.4 Test setup

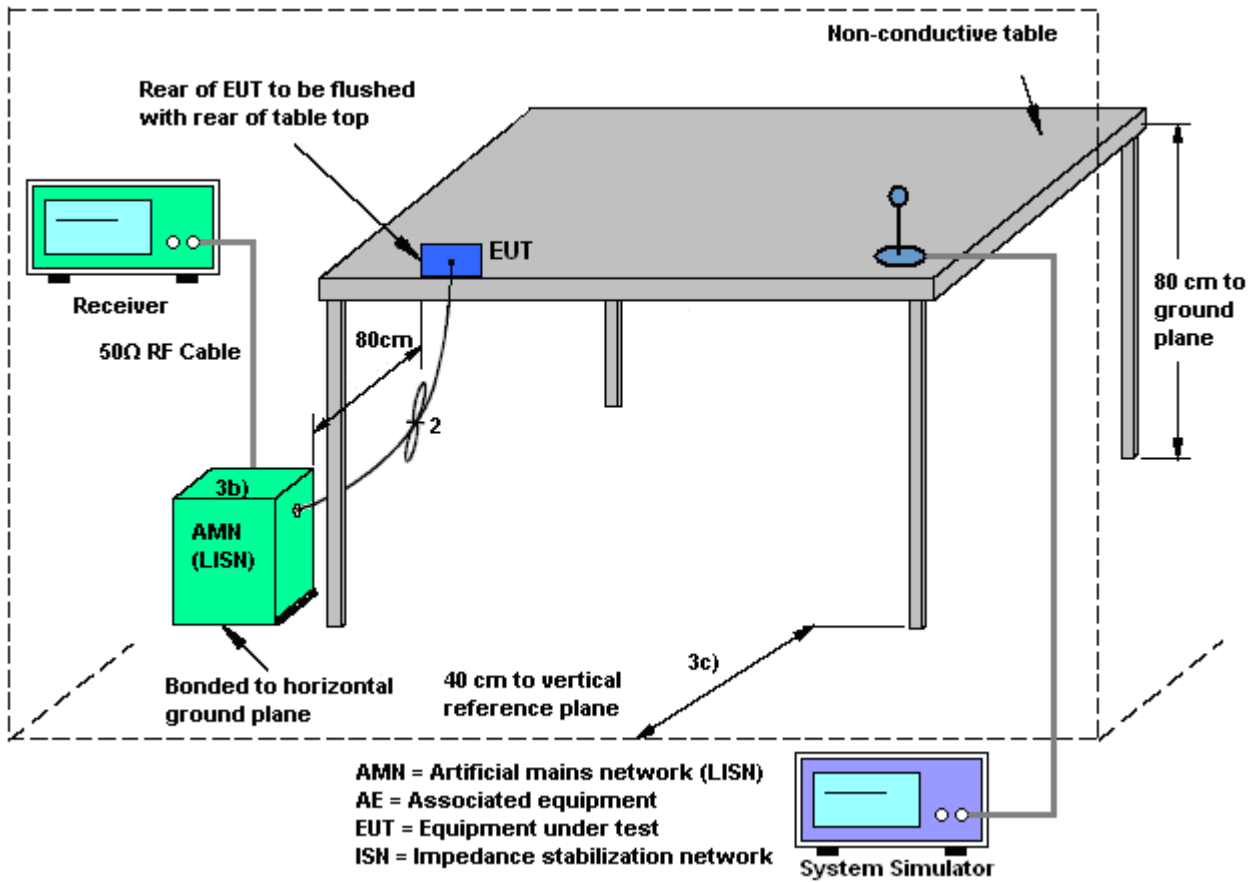

3.1.5 Test Result of AC Conducted Emission

Please refer to Appendix A.

3.2 20dB and 99% OBW Spectrum Bandwidth Measurement

3.2.1 Limit

Intentional radiators must be designed to ensure that the 20dB and 99% emission bandwidth in the specific band 13.553~13.567MHz.

3.2.2 Measuring Instruments

See list of measuring instruments of this test report.

3.2.3 Test Procedures

1. The spectrum analyzer connected via a receive antenna placed near the EUT in peak Max hold mode.
2. The resolution bandwidth of 1 kHz and the video bandwidth of 3 kHz were used.
3. Measured the spectrum width with power higher than 20dB below carrier.
4. Measured the 99% OBW.

3.2.4 Test Setup

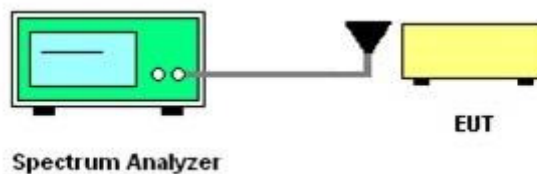

3.2.5 Test Result of Conducted Test Items

Please refer to Appendix B.

3.3 Frequency Stability Measurement

3.3.1 Limit

The frequency tolerance of the carrier signal shall be maintained within +/- 0.01% (100ppm) of the operating frequency over a temperature variation of -20 degrees to +50 degrees C at normal supply voltage, and for a variation in the primary supply voltage from 85% to 115% of the rated supply voltage at a temperature of 20 degrees C. For battery operated equipment, the equipment tests shall be performed using a new battery.

3.3.2 Measuring Instruments

See list of measuring instruments of this test report.

3.3.3 Test Procedures

1. The spectrum analyzer connected via a receive antenna placed near the EUT.
2. EUT have transmitted signal and fixed channelize.
3. Set the spectrum analyzer span to view the entire emissions bandwidth.
4. Set RBW = 1 kHz, VBW = 3 kHz with peak detector and maxhold settings.
5. The f_c is declaring of channel frequency. Then the frequency error formula is $(f_c - f) / f_c \times 10^6$ ppm and the limit is less than ± 100 ppm.
6. Extreme temperature rule is -20°C~50°C.

3.3.4 Test Setup

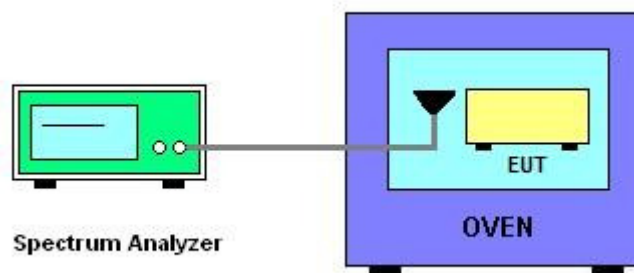

3.3.5 Test Result of Conducted Test Items

Please refer to Appendix C.



3.4 Field Strength of Fundamental Emissions and Mask Measurement

3.4.1 Limit

| Rules and specifications | FCC CFR 47 Part 15 section 15.225 | | | |
|--------------------------|---|--|--|---|
| Description | Compliance with the spectrum mask is tested with RBW set to 9kHz. | | | |
| Freq. of Emission (MHz) | Field Strength ($\mu\text{V/m}$) at 30m | Field Strength ($\text{dB}\mu\text{V/m}$) at 30m | Field Strength ($\text{dB}\mu\text{V/m}$) at 10m | Field Strength ($\text{dB}\mu\text{V/m}$) at 3m |
| 1.705~13.110 | 30 | 29.5 | 48.58 | 69.5 |
| 13.110~13.410 | 106 | 40.5 | 59.58 | 80.5 |
| 13.410~13.553 | 334 | 50.5 | 69.58 | 90.5 |
| 13.553~13.567 | 15848 | 84.0 | 103.08 | 124.0 |
| 13.567~13.710 | 334 | 50.5 | 69.58 | 90.5 |
| 13.710~14.010 | 106 | 40.5 | 59.58 | 80.5 |
| 14.010~30.000 | 30 | 29.5 | 48.58 | 69.5 |

3.4.2 Measuring Instruments

See list of measuring instruments of this test report.

3.4.3 Test Procedures

1. Configure the EUT according to ANSI C63.10. The EUT was placed on the top of the turntable 0.8 meter above ground. The phase center of the loop receiving antenna mounted antenna tower was placed 3 meters far away from the turntable.
2. Power on the EUT and all the supporting units. The turntable was rotated by 360 degrees to determine the position of the highest radiation.
3. The height of the receiving antenna was fixed at one meter above ground to find the maximum emissions field strength.
4. For Fundamental emissions, use the receiver to measure QP reading.
5. When the radiated emissions limits are expressed in terms of the average value of the emissions, and pulsed operation is employed, the measurement field strength shall be determined by averaging over one complete pulse train, including blanking intervals, as long as the pulse train does not exceed 0.1 seconds. As an alternative (provided the transmitter operates for longer than 0.1 seconds) or in cases where the pulse train exceeds 0.1 seconds, the measured field strength shall be determined from the average absolute voltage during a 0.1 second interval during which the field strength is at its maximum value.
6. Compliance with the spectrum mask is tested with RBW set to 9kHz.
Note: Emission level (dB μ V/m) = 20 log Emission level (μ V/m).

3.4.4 Test Setup

For radiated emissions below 30MHz

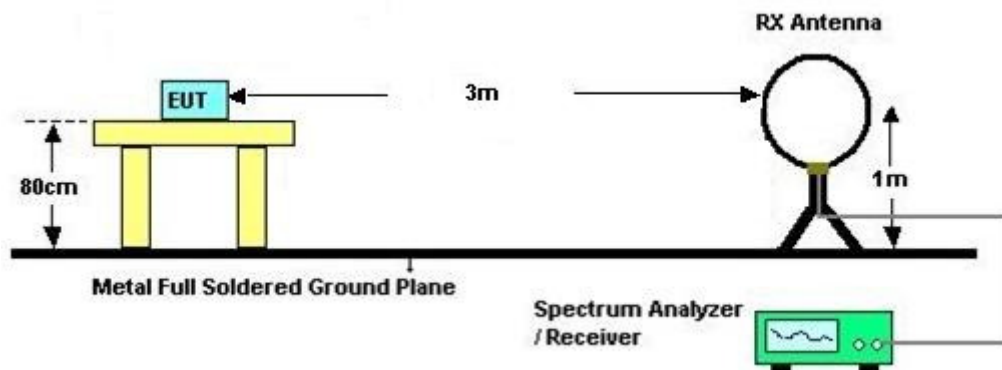

3.4.5 Test Result of Field Strength of Fundamental Emissions and Mask

Please refer to Appendix D.

3.5 Radiated Emissions Measurement

3.5.1 Limit

The field strength of any emissions which appear outside of 13.110 ~14.010MHz band shall not exceed the general radiated emissions limits.

| Frequencies (MHz) | Field Strength ($\mu\text{V/m}$) | Measurement Distance (meters) |
|-------------------|------------------------------------|-------------------------------|
| 0.009~0.490 | 2400/F(kHz) | 300 |
| 0.490~1.705 | 24000/F(kHz) | 30 |
| 1.705~30.0 | 30 | 30 |
| 30~88 | 100 | 3 |
| 88~216 | 150 | 3 |
| 216~960 | 200 | 3 |
| Above 960 | 500 | 3 |

3.5.2 Measuring Instruments

See list of measuring instruments of this test report.

3.5.3 Measuring Instrument Setting

The following table is the setting of receiver.

| Receiver Parameter | Setting |
|--------------------------------|---------------------|
| Attenuation | Auto |
| Frequency Range: 9kHz~150kHz | RBW 200Hz for QP |
| Frequency Range: 150kHz~30MHz | RBW 9kHz for QP |
| Frequency Range: 30MHz~1000MHz | RBW 120kHz for Peak |

Note: The emission limits shown in the above table are based on measurements employing a CISPR quasi-peak detector except for the frequency bands 9-90 kHz, 110-490 kHz. Radiated emission limits in these two bands are based on measurements employing an average detector.



3.5.4 Test Procedures

1. Configure the EUT according to ANSI C63.10. The EUT was placed on the top of the turntable 0.8 meter above ground. The phase center of the receiving antenna mounted on the top of a height-variable antenna tower was placed 3 meters far away from the turntable.
2. Power on the EUT and all the supporting units. The turntable was rotated by 360 degrees to determine the position of the highest radiation.
3. The height of the broadband receiving antenna was varied between one meter and four meters above ground to find the maximum emissions field strength of both horizontal and vertical polarization.
4. For each suspected emissions, the antenna tower was scan (from 1 M to 4 M) and then the turntable was rotated (from 0 degree to 360 degrees) to find the maximum reading.
5. Set the test-receiver system to Peak or CISPR quasi-peak Detect Function with specified bandwidth under Maximum Hold Mode.
6. When the radiated emissions limits are expressed in terms of the average value of the emissions, and pulsed operation is employed, the measurement field strength shall be determined by averaging over one complete pulse train, including blanking intervals, as long as the pulse train does not exceed 0.1 seconds. As an alternative (provided the transmitter operates for longer than 0.1 seconds) or in cases where the pulse train exceeds 0.1 seconds, the measured field strength shall be determined from the average absolute voltage during a 0.1 second interval during which the field strength is at its maximum value.
7. In case the emission is lower than 30MHz, loop antenna has to be used for measurement and the recorded data should be QP measured by receiver. Antenna Requirements

3.5.5 Test Setup

For radiated emissions below 30MHz

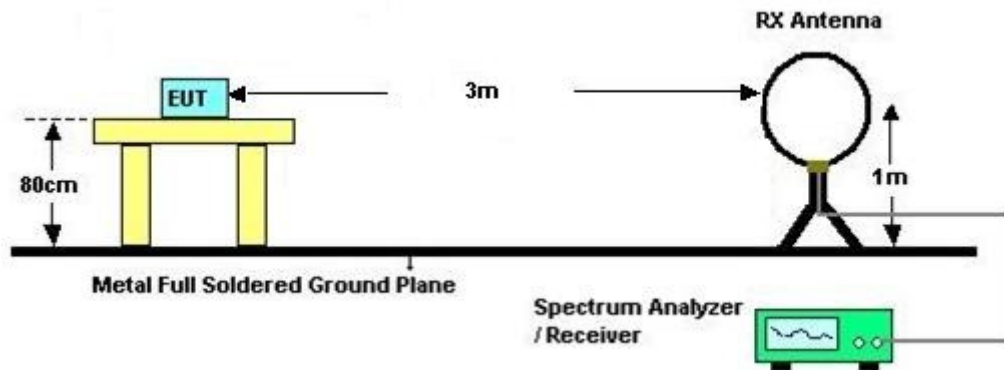

For radiated emissions above 30MHz

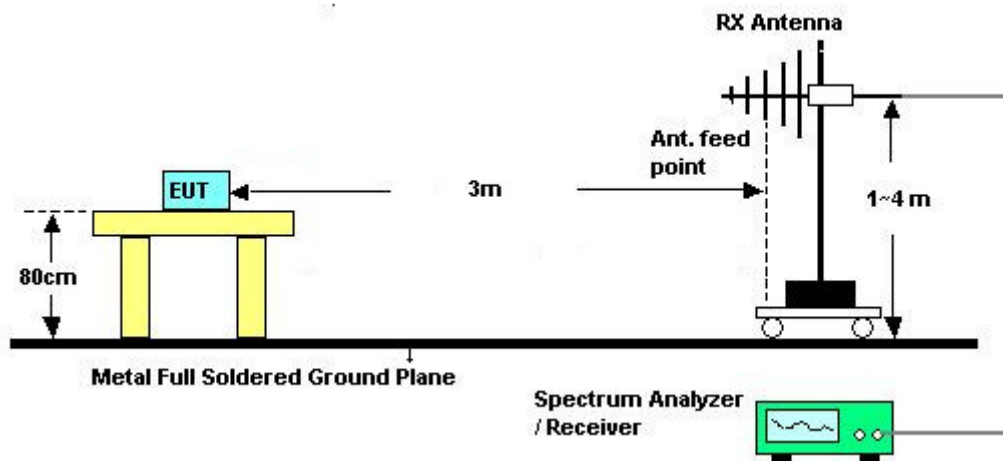

3.5.6 Test Result of Radiated Emissions Measurement

Please refer to Appendix D.



3.6 Antenna Requirements

3.6.1 Standard Applicable

Except for special regulations, the Low-power Radio-frequency Devices must not be equipped with any jacket for installing an antenna with extension cable. An intentional radiator shall be designed to ensure that no antenna other than that furnished by the responsible party shall be used with the device. The use of a permanently attached antenna or of an antenna that uses a unique coupling to the intentional radiator shall be considered sufficient to comply with the provisions of this Section. The manufacturer may design the unit so that the user can replace a broken antenna, but the use of a standard antenna jack or electrical connector is prohibited.

The use of a permanently attached antenna or of an antenna that uses a unique coupling to the intentional radiator shall be considered sufficient to comply with the FCC rule.

3.6.2 Antenna Anti-Replacement Construction

An embedded-in antenna design is used.



4. LIST OF MEASURING EQUIPMENT

| Instrument | Manufacturer | Model No. | Serial No. | Characteristics | Calibration Date | Test Date | Due Date | Remark |
|---------------------|-----------------|---------------------------|-----------------------|--------------------|------------------|-------------------------------|---------------|-----------------------|
| AC Power Source | AC POWER | AFC-500W | F104070011 | 50Hz~60Hz | Dec. 01, 2016 | Dec. 02, 2016 | Nov. 30, 2017 | Conducted (TH03-HY) |
| Hygrometer | Testo | 608-H1 | 34893241 | N/A | May 03, 2016 | Dec. 02, 2016 | May 02, 2017 | Conducted (TH03-HY) |
| Spectrum Analyzer | Rohde & Schwarz | FSP30 | 101329 | 9kHz~30GHz | Jun. 27, 2016 | Dec. 02, 2016 | Jun. 26, 2017 | Conducted (TH03-HY) |
| Temperature Chamber | ESPEC | SU-641 | 92013721 | -30℃ ~70℃ | Nov. 16, 2016 | Dec. 02, 2016 | Nov. 15, 2017 | Conducted (TH03-HY) |
| AC Power Source | ChainTek | APC-1000W | N/A | N/A | N/A | Dec. 06, 2016 ~ Dec. 13, 2016 | N/A | Conduction (CO05-HY) |
| EMI Test Receiver | Rohde & Schwarz | ESCI 7 | 100724 | 9kHz~7GHz | Aug. 30, 2016 | Dec. 06, 2016 ~ Dec. 13, 2016 | Aug. 29, 2017 | Conduction (CO05-HY) |
| Hygrometer | Testo | 608-H1 | 34913912 | N/A | Apr. 19, 2016 | Dec. 06, 2016 ~ Dec. 13, 2016 | Apr. 18, 2017 | Conduction (CO05-HY) |
| LISN | Rohde & Schwarz | ENV216 | 100080 | 9kHz~30MHz | Nov. 29, 2016 | Dec. 06, 2016 ~ Dec. 13, 2016 | Nov. 28, 2017 | Conduction (CO05-HY) |
| LF Cable | HUBER + SUHNER | RG-214/U | LF01 | N/A | Jan. 06, 2016 | Dec. 06, 2016 ~ Dec. 13, 2016 | Jan. 05, 2017 | Conduction (CO05-HY) |
| Test Software | N/A | EMC32 | 8.40.0 | N/A | N/A | Dec. 06, 2016 ~ Dec. 13, 2016 | N/A | Conduction (CO05-HY) |
| Bilog Antenna | TESEQ | CBL 6111D&0080 0N1D01N-06 | 35419&03 | 30MHz to 1GHz | Jan. 13, 2016 | Dec. 08, 2016 ~ Dec. 14, 2016 | Jan. 12, 2017 | Radiation (03CH07-HY) |
| Loop Antenna | Rohde & Schwarz | HFH2-Z2 | 100315 | 9 kHz~30 MHz | Sep. 02, 2015 | Dec. 08, 2016 ~ Dec. 14, 2016 | Sep. 01, 2017 | Radiation (03CH07-HY) |
| EMI Test Receiver | Keysight | N9038A(MX E) | MY5413008 5 | 20Hz ~ 8.4GHz | Oct. 26, 2016 | Dec. 08, 2016 ~ Dec. 14, 2016 | Oct. 25, 2017 | Radiation (03CH07-HY) |
| Preamplifier | COM-POWER | PA-103A | 161241 | 10MHz-1GHz | Mar. 18, 2016 | Dec. 08, 2016 ~ Dec. 14, 2016 | Mar. 17, 2017 | Radiation (03CH07-HY) |
| Spectrum Analyzer | Agilent | N9010A | MY5347011 8 | 10Hz~44GHz | Feb. 27, 2016 | Dec. 08, 2016 ~ Dec. 14, 2016 | Feb. 26, 2017 | Radiation (03CH07-HY) |
| Hygrometer | Testo | 608-H1 | 34897197 | N/A | N/A | Dec. 08, 2016 ~ Dec. 14, 2016 | N/A | Radiation (03CH07-HY) |
| Filter | Wainwright | WHK20/100 0C7/40SS | SN2 | 20M High Pass | Nov. 22, 2016 | Dec. 08, 2016 ~ Dec. 14, 2016 | Nov. 21, 2017 | Radiation (03CH07-HY) |
| RF Cable | HUBER + SUHNER | SUCOFLEX 104 | MY8420952 1 | 30MHz~1GHz | Dec. 01, 2016 | Dec. 08, 2016 ~ Dec. 14, 2016 | Nov. 30, 2017 | Radiation (03CH07-HY) |
| RF Cable | HUBER + SUHNER | SUCOFLEX 104 | MY8420952 1 | 9KHz~30MHz | Dec. 01, 2016 | Dec. 08, 2016 ~ Dec. 14, 2016 | Nov. 30, 2017 | Radiation (03CH07-HY) |
| Controller | ChainTek | Chaintek 3000 | N/A | Control Turn table | N/A | Dec. 08, 2016 ~ Dec. 14, 2016 | N/A | Radiation (03CH07-HY) |
| Controller | Max-Full | MF7802 | MF7802083 68 | Control Ant Mast | N/A | Dec. 08, 2016 ~ Dec. 14, 2016 | N/A | Radiation (03CH07-HY) |
| Antenna Mast | Max-Full | MFA520BS | N/A | 1m~4m | N/A | Dec. 08, 2016 ~ Dec. 14, 2016 | N/A | Radiation (03CH07-HY) |
| Turn Table | ChainTek | Chaintek 3000 | N/A | 0~360 Degree | N/A | Dec. 08, 2016 ~ Dec. 14, 2016 | N/A | Radiation (03CH07-HY) |
| Test Software | Audix | E3 | 6.2009-8-24 (sporton) | N/A | N/A | Dec. 08, 2016 ~ Dec. 14, 2016 | N/A | Radiation (03CH07-HY) |



| Instrument | Manufacturer | Model No. | Serial No. | Characteristics | Calibration Date | Test Date | Due Date | Remark |
|---------------------|-----------------|-----------|------------|---------------------------|------------------|---------------|---------------|------------------------|
| Open Area Test Site | SPORTON | OATS-10 | OS03-LK | 30 MHz ~ 1 GHz 10m, 3m | May 21, 2016 | Dec. 23, 2016 | May 20, 2017 | Radiation (OS03-LK) |
| Spectrum Analyzer | R&S | FSP 7 | 100641 | 9 kHz ~ 7 GHz | Jun. 23, 2016 | Dec. 23, 2016 | Jun. 22, 2017 | Radiation (OS03-LK) |
| Test Receiver | R&S | ESCS 30 | 836858/024 | 9 kHz ~ 2.75 GHz | Jun. 24, 2016 | Dec. 23, 2016 | Jun. 23, 2017 | Radiation (OS03-LK) |
| Turn Table | EMCO | 2080 | 9711-2021 | 0 ~ 360 degree | N/A | Dec. 23, 2016 | N/A | Radiation (OS03-LK) |
| Antenna Mast | EMCO | 2075 | 9711-2115 | 1 m ~ 4 m | N/A | Dec. 23, 2016 | N/A | Radiation (OS03-LK) |
| Loop Antenna | Rohde & Schwarz | HFH2-Z2 | 100315 | 9 kHz~30 MHz | Sep. 02, 2015 | Dec. 23, 2016 | Sep. 01, 2017 | Radiation (OS03-LK) |
| Preamplifier | COM-POWER | PA-103A | 161241 | 10MHz-1GHz | Mar. 18, 2016 | Dec. 23, 2016 | Mar. 17, 2017 | Radiation (OS03-LK) |
| Test Software | Audix | E3 | 4 | N/A | N/A | Dec. 23, 2016 | N/A | Radiation (OS03-LK) |

Appendix A. Test Results of Conducted Emission Test

<Original test result with NFC antenna>

| | | | |
|-----------------|--|----------------|---------------|
| Test Mode : | NFC Tx | Test Voltage : | 120Vac / 60Hz |
| Function Type : | GSM1900 Idle + Bluetooth Link + WLAN (2.4GHz) Link + NFC Tx + Battery + Earphone 1 + USB Cable (Charging from Adapter 1) | | |

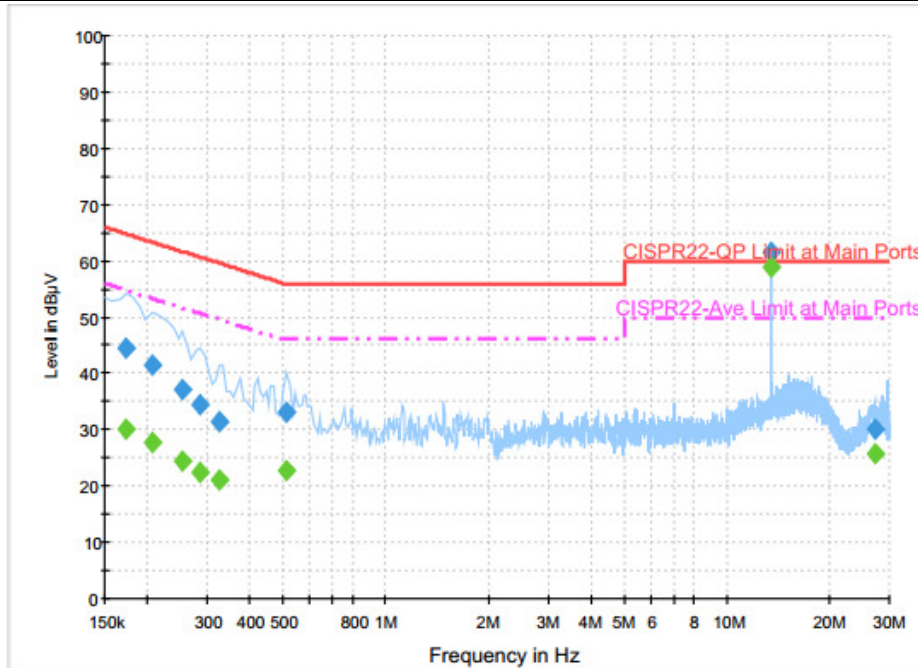

Final Result : Quasi-Peak

| Frequency (MHz) | Quasi-Peak (dBµV) | Filter | Line | Corr. (dB) | Margin (dB) | Limit (dBµV) |
|-----------------|-------------------|--------|------|------------|-------------|--------------|
| 0.174000 | 44.6 | Off | L1 | 19.6 | 20.2 | 64.8 |
| 0.206000 | 41.5 | Off | L1 | 19.6 | 21.9 | 63.4 |
| 0.254000 | 37.0 | Off | L1 | 19.6 | 24.6 | 61.6 |
| 0.286000 | 34.6 | Off | L1 | 19.6 | 26.0 | 60.6 |
| 0.326000 | 31.5 | Off | L1 | 19.6 | 28.1 | 59.6 |
| 0.510000 | 33.2 | Off | L1 | 19.6 | 22.8 | 56.0 |
| 13.558000 | 61.5 | Off | L1 | 20.3 | -1.5 | 60.0 |
| 27.118000 | 30.2 | Off | L1 | 20.9 | 29.8 | 60.0 |

Final Result : Average

| Frequency (MHz) | Average (dBµV) | Filter | Line | Corr. (dB) | Margin (dB) | Limit (dBµV) |
|-----------------|----------------|--------|------|------------|-------------|--------------|
| 0.174000 | 30.1 | Off | L1 | 19.6 | 24.7 | 54.8 |
| 0.206000 | 27.6 | Off | L1 | 19.6 | 25.8 | 53.4 |
| 0.254000 | 24.6 | Off | L1 | 19.6 | 27.0 | 51.6 |
| 0.286000 | 22.4 | Off | L1 | 19.6 | 28.2 | 50.6 |
| 0.326000 | 21.2 | Off | L1 | 19.6 | 28.4 | 49.6 |
| 0.510000 | 22.7 | Off | L1 | 19.6 | 23.3 | 46.0 |
| 13.558000 | 58.7 | Off | L1 | 20.3 | -8.7 | 50.0 |
| 27.118000 | 25.6 | Off | L1 | 20.9 | 24.4 | 50.0 |



| | | | |
|-----------------|--|----------------|---------------|
| Test Mode : | NFC Tx | Test Voltage : | 120Vac / 60Hz |
| Function Type : | GSM1900 Idle + Bluetooth Link + WLAN (2.4GHz) Link + NFC Tx + Battery + Earphone 1 + USB Cable (Charging from Adapter 1) | | |

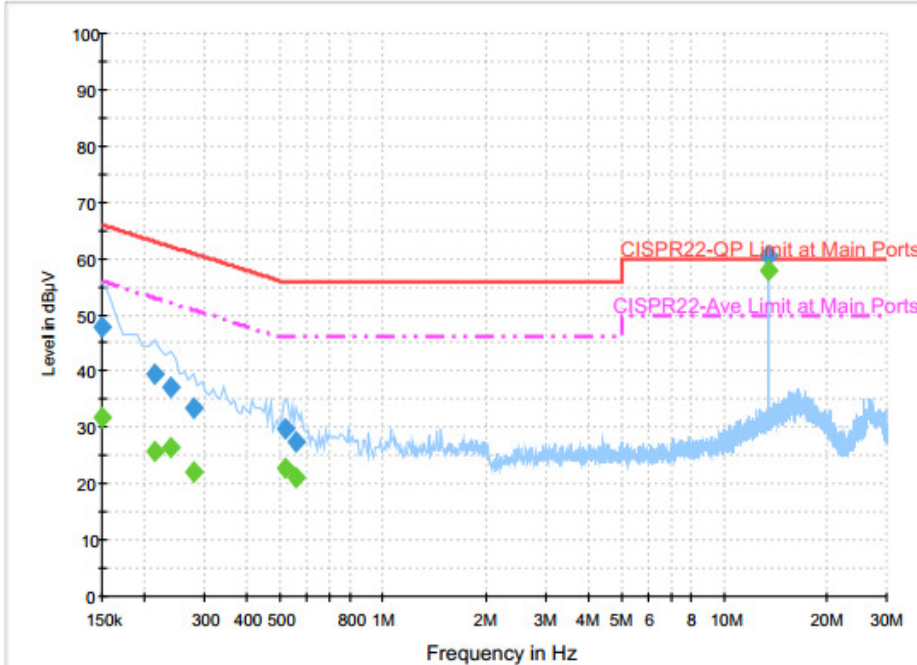

Final Result : Quasi-Peak

| Frequency (MHz) | Quasi-Peak (dBµV) | Filter | Line | Corr. (dB) | Margin (dB) | Limit (dBµV) |
|-----------------|-------------------|--------|------|------------|-------------|--------------|
| 0.150000 | 47.8 | Off | N | 19.6 | 18.2 | 66.0 |
| 0.214000 | 39.4 | Off | N | 19.6 | 23.6 | 63.0 |
| 0.238000 | 37.1 | Off | N | 19.6 | 25.1 | 62.2 |
| 0.278000 | 33.4 | Off | N | 19.6 | 27.5 | 60.9 |
| 0.518000 | 29.8 | Off | N | 19.6 | 26.2 | 56.0 |
| 0.558000 | 27.5 | Off | N | 19.6 | 28.5 | 56.0 |
| 13.558000 | 60.6 | Off | N | 20.3 | -0.6 | 60.0 |

Final Result : Average

| Frequency (MHz) | Average (dBµV) | Filter | Line | Corr. (dB) | Margin (dB) | Limit (dBµV) |
|-----------------|----------------|--------|------|------------|-------------|--------------|
| 0.150000 | 31.6 | Off | N | 19.6 | 24.4 | 56.0 |
| 0.214000 | 25.7 | Off | N | 19.6 | 27.3 | 53.0 |
| 0.238000 | 26.3 | Off | N | 19.6 | 25.9 | 52.2 |
| 0.278000 | 21.9 | Off | N | 19.6 | 29.0 | 50.9 |
| 0.518000 | 22.8 | Off | N | 19.6 | 23.2 | 46.0 |
| 0.558000 | 21.2 | Off | N | 19.6 | 24.8 | 46.0 |
| 13.558000 | 57.8 | Off | N | 20.3 | -7.8 | 50.0 |

<Terminal test result with dummy load>

| | | | |
|------------------------|--|-----------------------|---------------|
| Test Mode : | NFC Tx | Test Voltage : | 120Vac / 60Hz |
| Function Type : | GSM1900 Idle + Bluetooth Link + WLAN (2.4GHz) Link + NFC Tx + Battery + Earphone 1 + USB Cable (Charging from Adapter 1) | | |

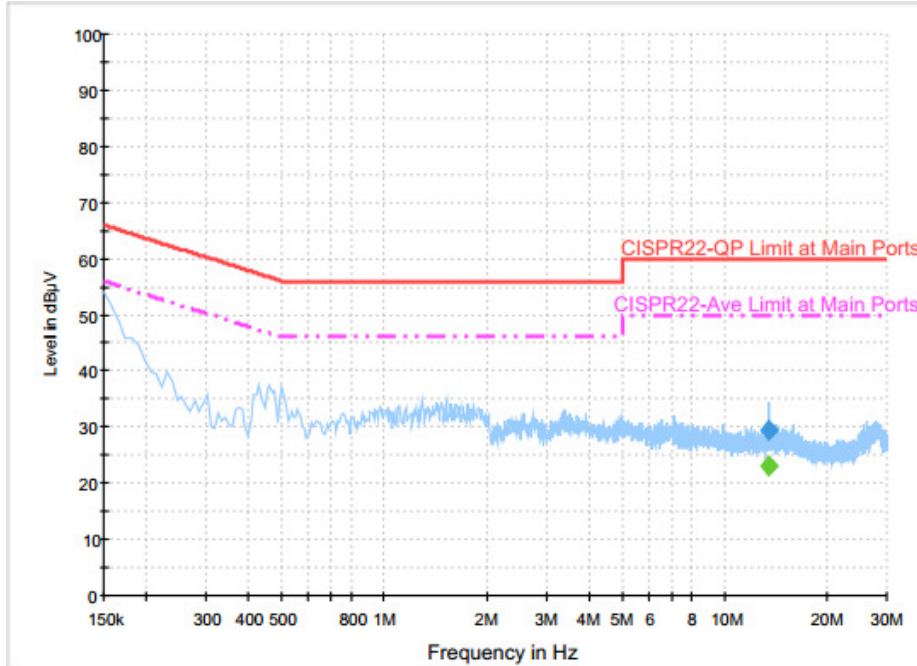

Final Result : Quasi-Peak

| Frequency (MHz) | Quasi-Peak (dBµV) | Filter | Line | Corr. (dB) | Margin (dB) | Limit (dBµV) |
|-----------------|-------------------|--------|------|------------|-------------|--------------|
| 13.558000 | 29.6 | Off | N | 20.3 | 30.4 | 60.0 |

Final Result : Average

| Frequency (MHz) | Average (dBµV) | Filter | Line | Corr. (dB) | Margin (dB) | Limit (dBµV) |
|-----------------|----------------|--------|------|------------|-------------|--------------|
| 13.558000 | 23.2 | Off | N | 20.3 | 26.8 | 50.0 |



| | | | |
|------------------------|--|-----------------------|---------------|
| Test Mode : | NFC Tx | Test Voltage : | 120Vac / 60Hz |
| Function Type : | GSM1900 Idle + Bluetooth Link + WLAN (2.4GHz) Link + NFC Tx + Battery + Earphone 1 + USB Cable (Charging from Adapter 1) | | |

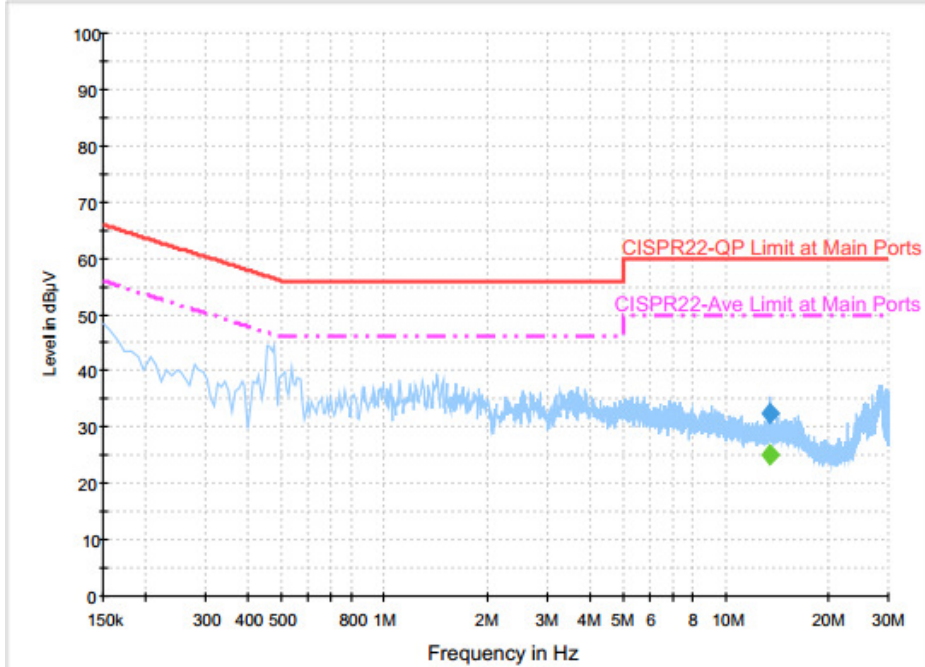

Final Result : Quasi-Peak

| Frequency (MHz) | Quasi-Peak (dBµV) | Filter | Line | Corr. (dB) | Margin (dB) | Limit (dBµV) |
|-----------------|-------------------|--------|------|------------|-------------|--------------|
| 13.558000 | 32.4 | Off | L1 | 20.3 | 27.6 | 60.0 |

Final Result : Average

| Frequency (MHz) | Average (dBµV) | Filter | Line | Corr. (dB) | Margin (dB) | Limit (dBµV) |
|-----------------|----------------|--------|------|------------|-------------|--------------|
| 13.558000 | 25.1 | Off | L1 | 20.3 | 24.9 | 50.0 |

(1) with antenna

Remark: 13.558 MHz is the NFC RF fundamental signal.

(2) with dummy load

Remark: Only the fundamental NFC signal needs to be retested per C63.4.



Appendix B. Test Results of Conducted Test Items

B1. Test Result of 20dB Spectrum Bandwidth

| Test mode | NFC Tx | Test Frequency (MHz) | 13.56 |
|------------------------------|----------------|----------------------------|--------------------|
| | | | |
| Date: 2.DEC.2016 10:26:46 | | Date: 2.DEC.2016 10:27:07 | |
| 20dB Bandwidth (kHz) | 2.64 | 99% OccupiedBW(kHz) | 2.24 |
| Frequency range (MHz) | $f_L > 13.553$ | 13.55934 | Test Result |
| | $f_H < 13.567$ | 13.56198 | |



B2. Test Result of Frequency Stability

| B3. Voltage vs. Frequency Stability | | Temperature vs. Frequency Stability | | |
|-------------------------------------|-----------------------------|-------------------------------------|------|-----------------------------|
| Voltage (Vac) | Measurement Frequency (MHz) | Temperature (°C) | Time | Measurement Frequency (MHz) |
| 120 | 13.560650 | -20 | 0 | 13.560670 |
| | | | 2 | 13.560680 |
| | | | 5 | 13.560680 |
| | | | 10 | 13.560700 |
| | | -10 | 0 | 13.560720 |
| | | | 2 | 13.560720 |
| | | | 5 | 13.560730 |
| | | | 10 | 13.560740 |
| | | 0 | 0 | 13.560740 |
| | | | 2 | 13.560740 |
| | | | 5 | 13.560740 |
| | | | 10 | 13.560740 |
| | | 10 | 0 | 13.560730 |
| | | | 2 | 13.560740 |
| | | | 5 | 13.560740 |
| | | | 10 | 13.560740 |
| | | 20 | 0 | 13.560640 |
| | | | 2 | 13.560640 |
| | | | 5 | 13.560640 |
| | | | 10 | 13.560640 |
| | | 30 | 0 | 13.560640 |
| | | | 2 | 13.560640 |
| | | | 5 | 13.560640 |
| | | | 10 | 13.560640 |
| | | 40 | 0 | 13.560640 |
| | | | 2 | 13.560640 |
| | | | 5 | 13.560640 |
| | | | 10 | 13.560640 |



| Voltage vs. Frequency Stability | | Temperature vs. Frequency Stability | | |
|---------------------------------|-----------------------------|-------------------------------------|------|-----------------------------|
| Voltage (Vac) | Measurement Frequency (MHz) | Temperature (°C) | Time | Measurement Frequency (MHz) |
| | | 50 | 0 | 13.560650 |
| | | | 2 | 13.560650 |
| | | | 5 | 13.560650 |
| | | | 10 | 13.560650 |
| Max.Deviation (MHz) | 0.000650 | Max.Deviation (MHz) | | 0.000740 |
| Max.Deviation (ppm) | 47.9351 | Max.Deviation (ppm) | | 54.5723 |
| Limit | FS < ±100 ppm | Limit | | FS < ±100 ppm |
| Test Result | PASS | Test Result | | PASS |



Appendix C. Test Results of Radiated Test Items

C1. Test Result of Field Strength of Fundamental Emissions

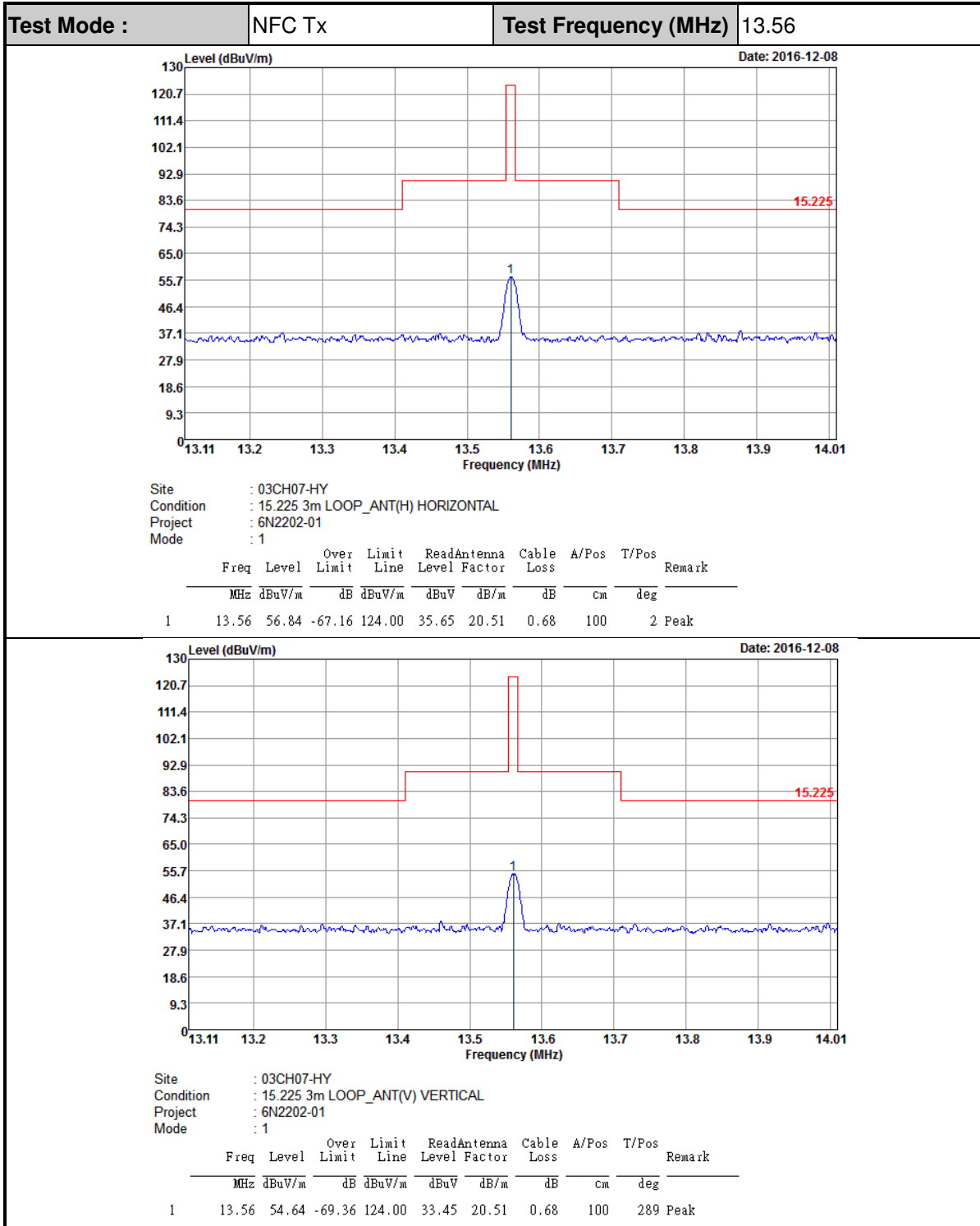



C2. Results of Radiated Spurious Emissions (9 kHz~30MHz)

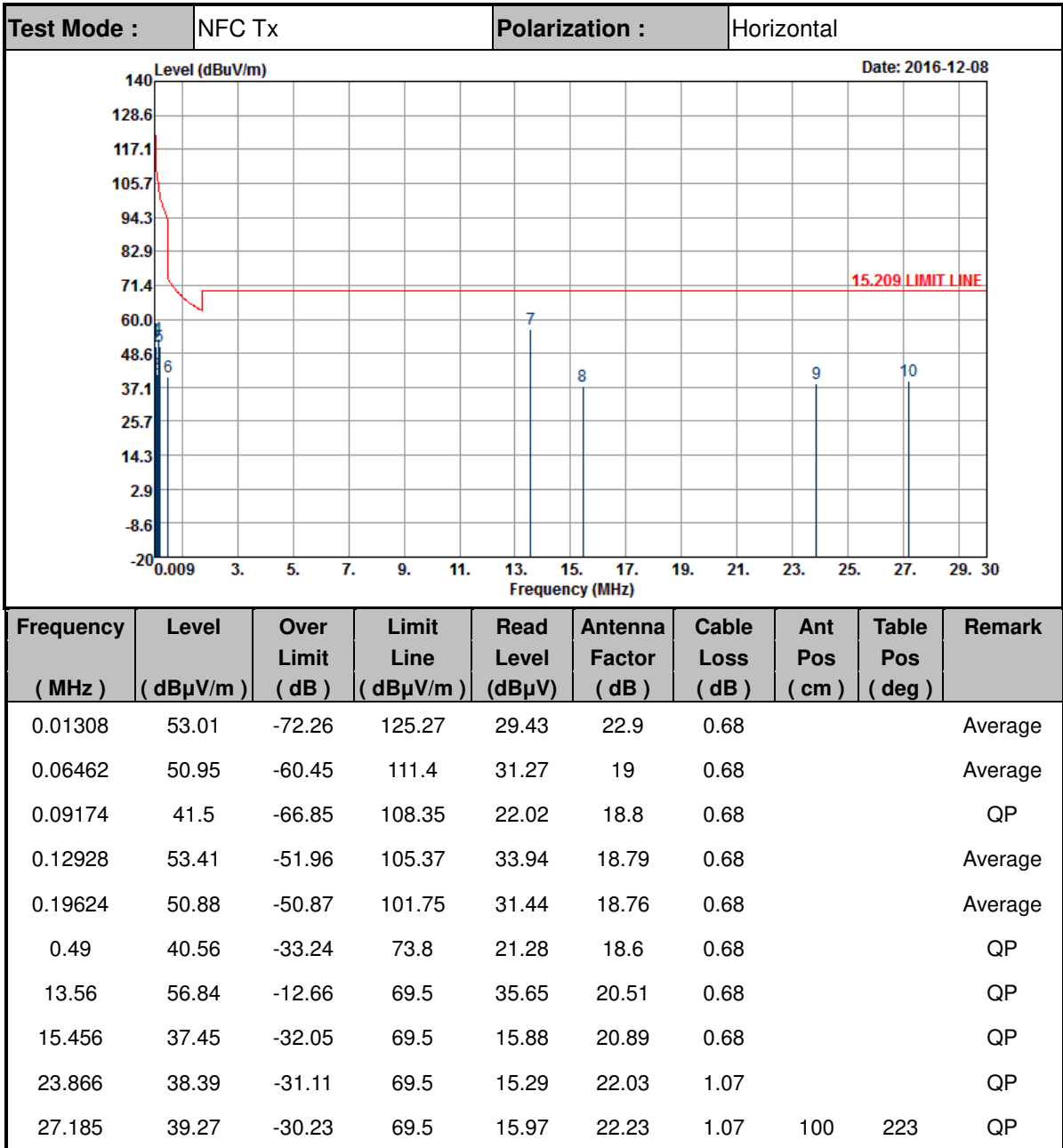

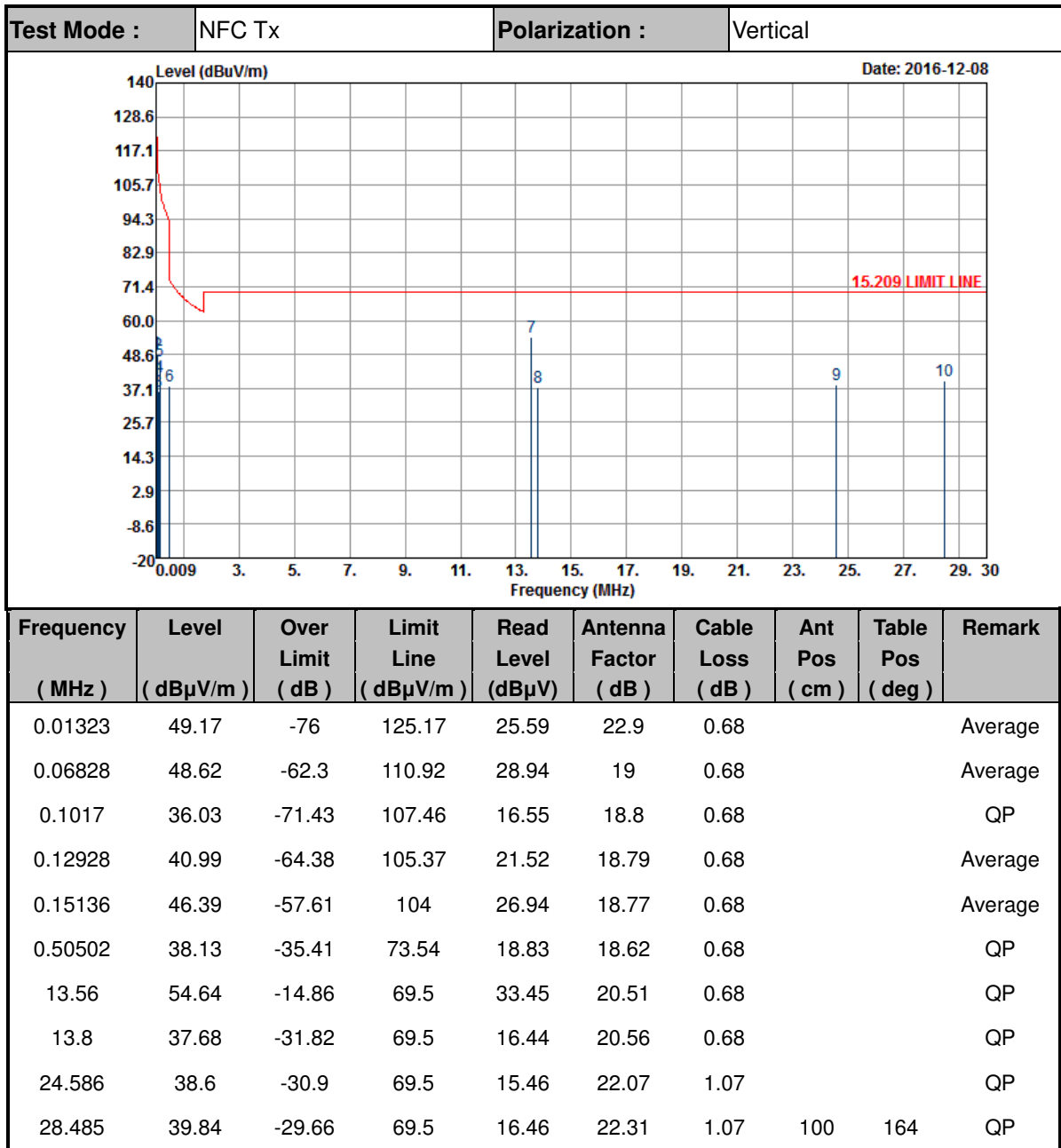

Note:

1. 13.56 MHz is fundamental signal which can be ignored.
2. The amplitude of spurious emissions which are attenuated by more than 20dB below the permissible value has no need to be reported.
3. Distance extrapolation factor = 40 log (specific distance / test distance) (dB);
4. Limit line = specific limits (dBμV) + distance extrapolation factor.



C3. Results of Radiated Spurious Emissions (30MHz~1GHz)

| | | | |
|-------------|--------|----------------|------------|
| Test Mode : | NFC Tx | Polarization : | Horizontal |
|-------------|--------|----------------|------------|

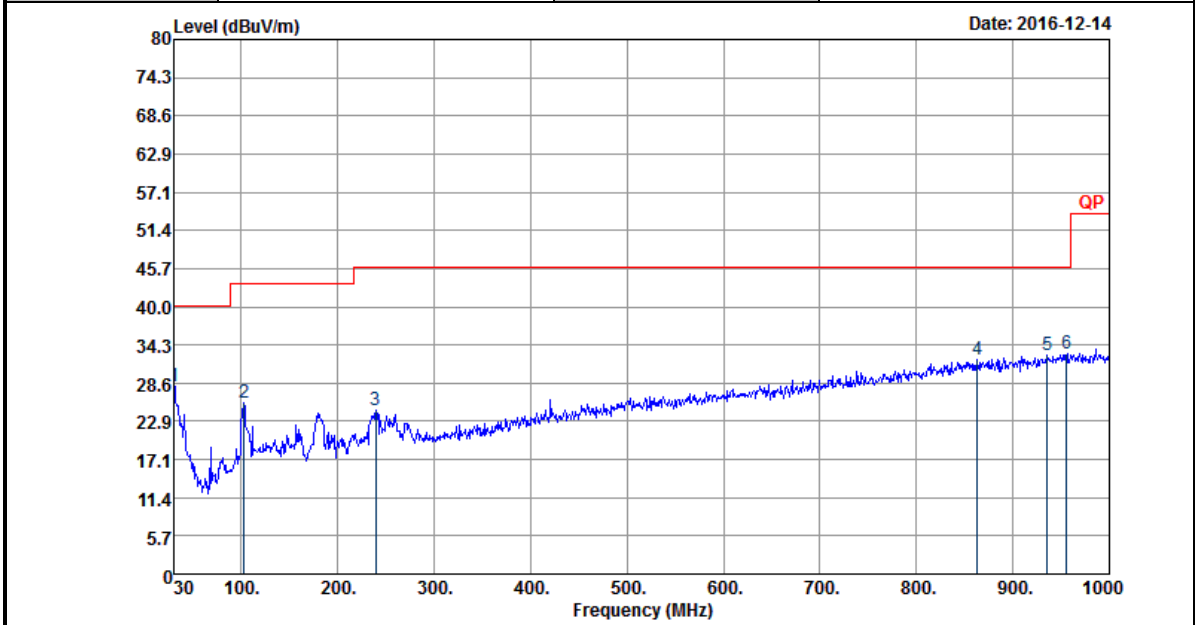

| Frequency (MHz) | Level (dBμV/m) | Over Limit (dB) | Limit Line (dBμV/m) | Read Level (dBμV) | Antenna Factor (dB) | Cable Loss (dB) | Preamp Factor (dB) | Ant Pos (cm) | Table Pos (deg) | Remark |
|-------------------|------------------|-------------------|-----------------------|---------------------|-----------------------|-------------------|----------------------|----------------|-------------------|--------|
| 30.27 | 28.04 | -11.96 | 40 | 32.32 | 26 | 1.07 | 31.35 | 100 | 0 | Peak |
| 102.63 | 25.66 | -17.84 | 43.5 | 38.96 | 16.67 | 1.55 | 31.52 | | | Peak |
| 239.25 | 24.41 | -21.59 | 46 | 35.74 | 18 | 2.07 | 31.4 | | | Peak |
| 863.5 | 32.02 | -13.98 | 46 | 29.63 | 28.78 | 4.17 | 30.56 | | | Peak |
| 935.6 | 32.77 | -13.23 | 46 | 29.31 | 29.87 | 4.12 | 30.53 | | | Peak |
| 955.9 | 32.95 | -13.05 | 46 | 29.2 | 30.21 | 4.07 | 30.53 | | | Peak |

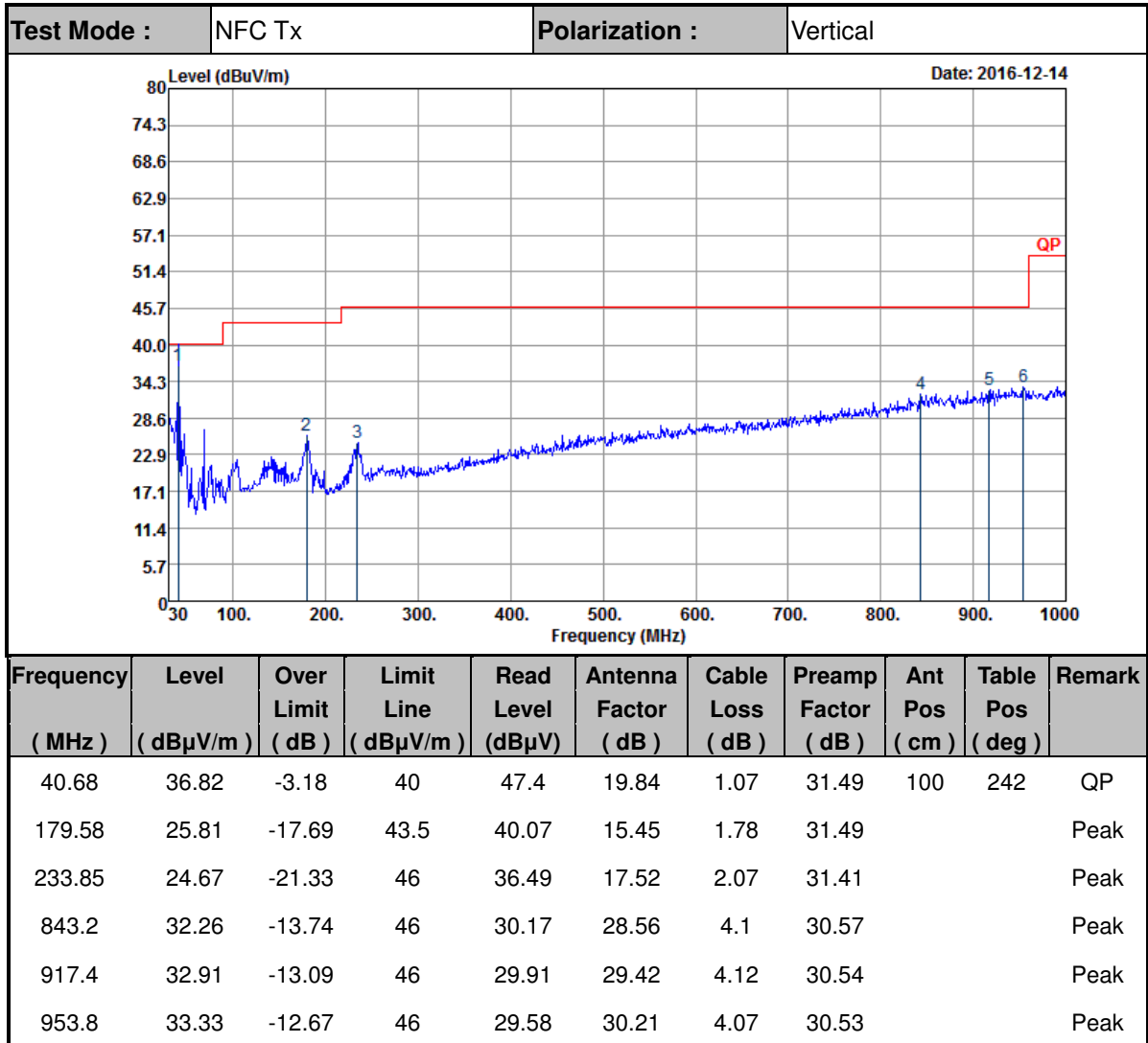

Note:

1. The amplitude of spurious emissions which are attenuated by more than 20dB below the permissible value has no need to be reported.
2. Emission level (dBuV/m) = 20 log Emission level (uV/m).
3. Corrected Reading: Antenna Factor + Cable Loss + Read Level - Preamp Factor= Level.



Appendix D. Verification of Radiated Spurious Emissions at open-area test site

D.1 Results of Radiated Emissions (9 kHz~30MHz)

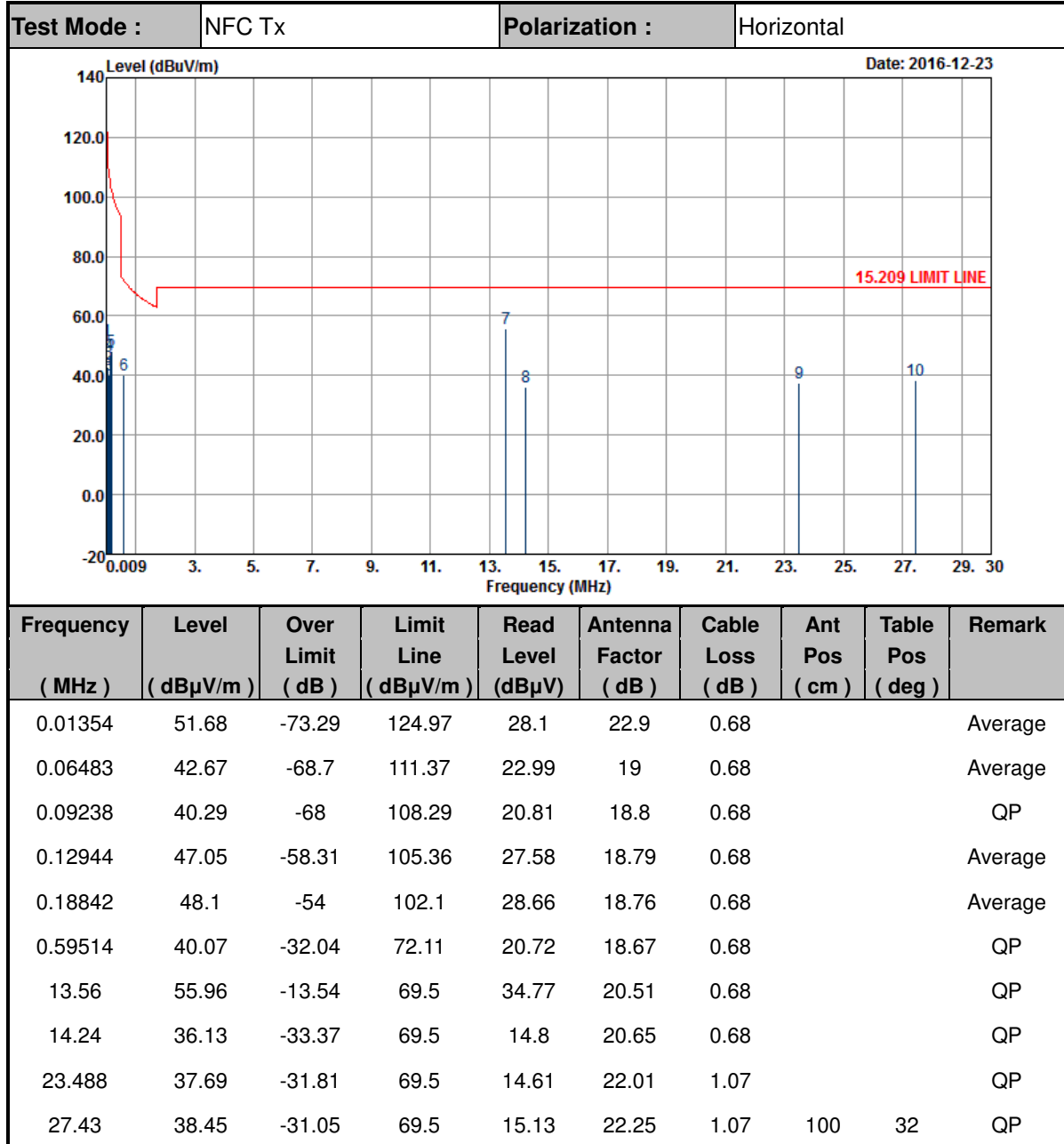

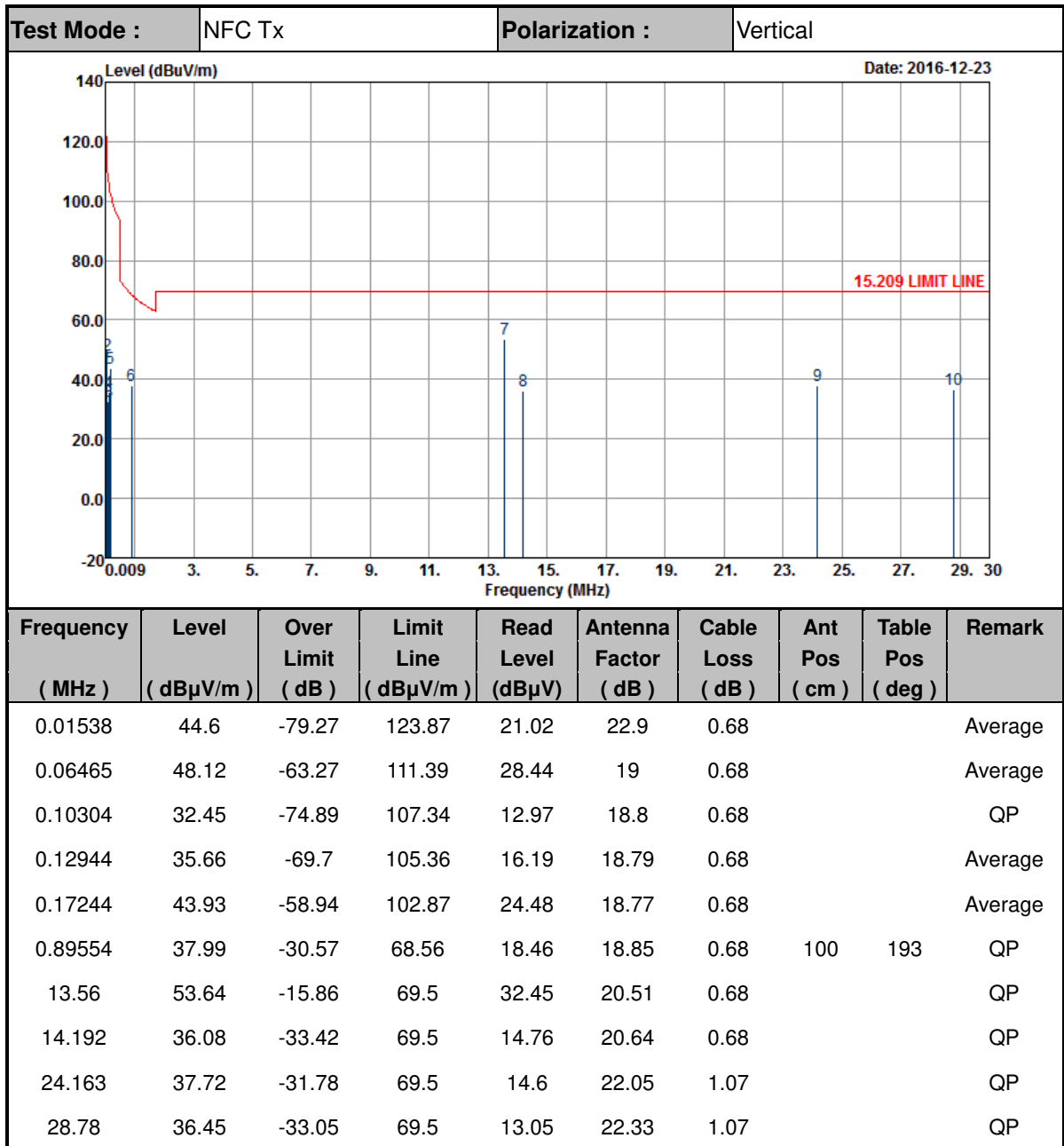

Note:

1. 13.56 MHz are fundamental signal which can be ignored.
2. The amplitude of spurious emissions which are attenuated by more than 20dB below the permissible value has no need to be reported.
3. Distance extrapolation factor = 40 log (specific distance / test distance) (dB);
4. Limit line = specific limits (dBμV) + distance extrapolation factor.
5. The test distance between the receiving antenna and the EUT is 3meter.