

# CERTIFICATE OF CALIBRATION

ISSUED BY **UL VS LTD**

DATE OF ISSUE: 23/May/2017

CERTIFICATE NUMBER : 11762345JD01A



5248

UL VS LTD  
PAVILION A  
ASHWOOD PARK, ASHWOOD WAY  
BASINGSTOKE, HAMPSHIRE  
RG23 8BG, UK  
TEL: +44 (0) 1256 312000  
FAX: +44 (0) 1256 312001  
Email: LST.UK.Calibration@ul.com



Page 1 of 10

**APPROVED SIGNATORY**

.....  
Naseer Mirza

**Customer :**

UL VS Inc  
47173 Benicia Street  
Fremont, CA 94538, USA

**Equipment Details:**

Description:	Dipole Validation Kit	Date of Receipt:	09/May/2017
Manufacturer:	Speag		
Type/Model Number:	D750V3		
Serial Number:	1024		
Calibration Date:	12/May/2017		
Calibrated By:	Chanthu Thevarajah Laboratory Engineer		

Signature:

.....

All Calibration have been conducted in the closed laboratory facility: Lab Temperature (22±3) °C and humidity < 70%

This certificate is issued in accordance with the laboratory accreditation requirements of the United Kingdom Accreditation Service. It provides traceability of measurement to the SI system of units and/or to units of measurement realised at the National Physical Laboratory or other recognised national metrology institutes. This certificate may not be reproduced other than in full, except with the prior written approval of the issuing laboratory.

Use of the UKAS mark demonstrates that compliance with the requirements of BS/EN/ISO/IEC 17025 has been independently assessed.

# CERTIFICATE OF CALIBRATION

## ISSUED BY UL VS LTD

UKAS Accredited Calibration Laboratory No. 5248

CERTIFICATE  
NUMBER :  
11762345JD01A

Page 2 of 10

The calibration methods and procedures used were as detailed in:

1. **IEC 62209-1:2005**: Procedure to determine the specific absorption rate (SAR) for hand-held devices used in close proximity to the ear (frequency range of 300 MHz to 3 GHz)
2. **IEC 62209-2:2010**: Procedure to determine the specific absorption rate (SAR) for wireless communication devices used in close proximity to the human body (frequency range of 30 MHz to 6 GHz)
3. **IEEE 1528: 2013**: IEEE Recommended Practice for Determining the Peak Spatial-Average Specific Absorption Rate (SAR) in the Human Head from Wireless Communication Devices: Measurement Techniques
4. FCC KDB Publication Number: **“KDB865664 D01 SAR Measurement 100 MHz to 6 GHz”**
5. **SPEAG DASY4/ DASY5 System Handbook**

The measuring equipment used to perform the calibration, documented in this certificate has been calibrated in accordance with the manufacturers' recommendations, and is traceable to recognized national standards.

UL No.	Instrument	Manufacturer	Type No.	Serial No.	Date Last Calibrated	Cal. Interval (Months)
A2110	Data Acquisition Electronics	SPEAG	DAE4	431	18 Nov 2016	12
A2587	Probe	SPEAG	ES3DV3	3341	29 Aug 2016	12
A1985	Dipole	SPEAG	D750V3	1011	14 Feb 2017	12
PRE0151451	Power Monitoring Kit	Art-Fi	ART 100850-01	0001	Cal as part of System	12
PRE0151441	Power Sensor	Rhode & Schwarz	NRP8S	102481	16 Nov 2016	12
M1015	Network Analyser	Agilent Technologies	8753ES	US39172406	26 Sept 2016	12
PRE0151154	Network Analyser	Rhode & Schwarz	ZND8	100151	22 Nov 2016	12
PRE0151877	Calibration Kit	Rhode & Schwarz	Z135	102947-Bt	09 May 2017	12
M1768	Signal Generator	Rhode & Schwarz	SME06	837633/001	08 Nov 2016	12

# CERTIFICATE OF CALIBRATION

## ISSUED BY UL VS LTD

UKAS Accredited Calibration Laboratory No. 5248

CERTIFICATE  
NUMBER :  
11762345JD01A

Page 3 of 10

### SAR System Specification

<b>Robot System Positioner:</b>	Stäubli Unimation Corp. Robot Model: RX90L
<b>Robot Serial Number:</b>	F00/SD89A1/A/01
<b>DASY Version:</b>	DASY 4 (v4.7.80)
<b>Phantom:</b>	Flat section of SAM Twin Phantom
<b>Distance Dipole Centre:</b>	15 mm (with spacer)
<b>Frequency:</b>	750 MHz

### Dielectric Property Measurements – Head Simulating Liquid (HSL)

Simulant Liquid	Frequency (MHz)	Room Temp		Liquid Temp		Parameters	Target Value	Measured Value	Uncertainty (%)
		Start	End	Start	End				
Head	750	21.0 °C	21.0 °C	21.0°C	21.0°C	$\epsilon_r$	41.96	41.29	± 5%
						$\sigma$	0.89	0.91	± 5%

### SAR Results – Head Simulating Liquid (HSL)

Simulant Liquid	SAR Measured	250 mW input Power	Normalised to 1.00 W	Uncertainty (%)
Head	SAR averaged over 1g	2.13 W/Kg	<b>8.47 W/Kg</b>	± 17.57%
	SAR averaged over 10g	1.39 W/Kg	<b>5.53 W/Kg</b>	± 17.32%

### Antenna Parameters – Head Simulating Liquid (HSL)

Simulant Liquid	Parameter	Measured Level	Uncertainty (%)
Head	Impedance	47.67 $\Omega$ 2.80 j $\Omega$	± 0.28 $\Omega$ ± 0.044 j $\Omega$
	Return Loss	28.12	± 2.03 dB

# CERTIFICATE OF CALIBRATION

## ISSUED BY UL VS LTD

UKAS Accredited Calibration Laboratory No. 5248

CERTIFICATE  
NUMBER :  
11762345JD01A

Page 4 of 10

### Dielectric Property Measurements – Body Simulating Liquid (MSL)

Simulant Liquid	Frequency (MHz)	Room Temp		Liquid Temp		Parameters	Target Value	Measured Value	Uncertainty (%)
		Start	End	Start	End				
Body	750	21.0 °C	21.0 °C	21.0°C	21.0°C	$\epsilon_r$	55.55	53.75	± 5%
						$\sigma$	0.96	0.97	± 5%

### SAR Results – Body Simulating Liquid (MSL)

Simulant Liquid	SAR Measured	250 mW input Power	Normalised to 1.00 W	Uncertainty (%)
Body	SAR averaged over 1g	2.16 W/Kg	<b>8.59 W/Kg</b>	± 18.06%
	SAR averaged over 10g	1.42 W/Kg	<b>5.65 W/Kg</b>	± 17.44%

### Antenna Parameters – Body Simulating Liquid (MSL)

Simulant Liquid	Parameter	Measured Level	Uncertainty (%)
Body	Impedance	51.39 $\Omega$ 3.87 $j\Omega$	± 0.28 $\Omega$ ± 0.044 $j\Omega$
	Return Loss	28.60	± 2.03 dB

# CERTIFICATE OF CALIBRATION

## ISSUED BY UL VS LTD

CERTIFICATE  
NUMBER :  
11762345JD01A

UKAS Accredited Calibration Laboratory No. 5248

Page 5 of 10

### DASY Validation Scan for Head Stimulating Liquid (HSL)

DUT: Dipole 750 MHz SN:1101; Type: D750V3; Serial: D750V3 - SN:1024

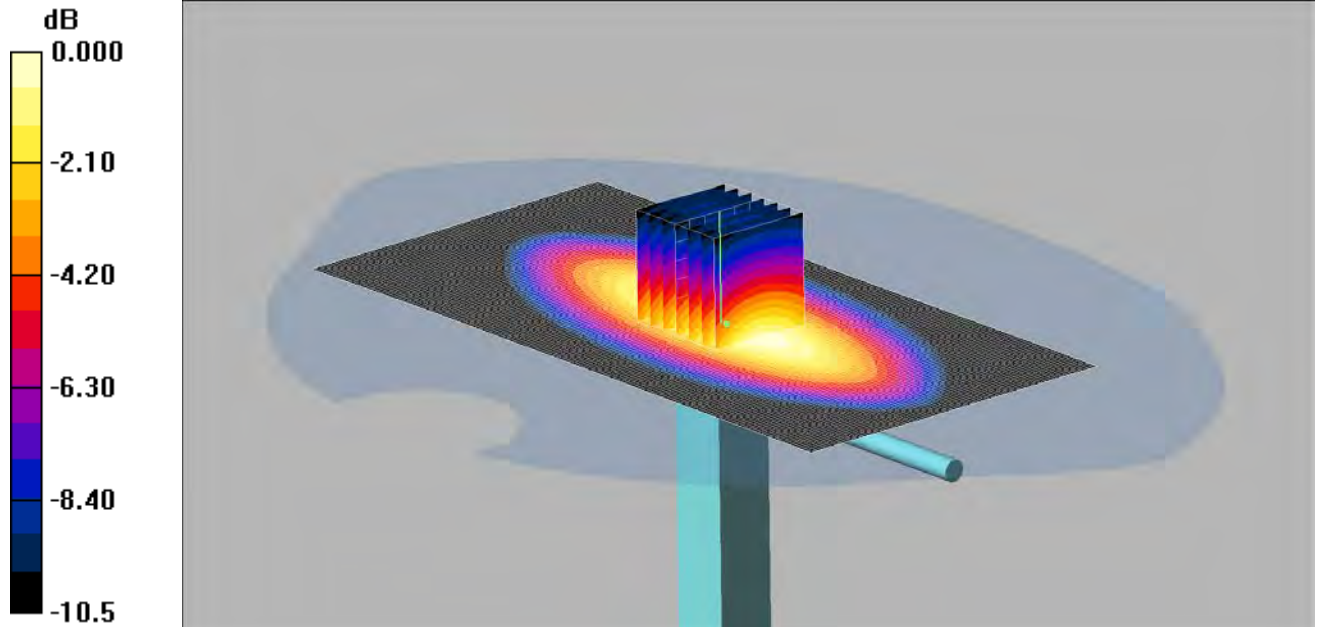

0 dB = 2.48mW/g

Communication System: CW 750; Frequency: 750 MHz; Duty Cycle: 1:1

Medium: 750 MHz HSL Medium parameters used:  $f = 750$  MHz;  $\sigma = 0.91$  mho/m;  $\epsilon_r = 41.3$ ;  $\rho = 1000$  kg/m<sup>3</sup>

Phantom section: Flat Section

DASY4 Configuration:

- Probe: ES3DV3 - SN3341; ConvF(6.53, 6.53, 6.53);

- Sensor-Surface: 3mm (Mechanical Surface Detection)

- Electronics: DAE4 Sn431; Calibrated: 18/11/2016

- Phantom: SAM 12a (Site 57); Type: SAM 4.0; Serial: TP:1020

- Measurement SW: DASY4, V4.7 Build 80; Postprocessing SW: SEMCAD, V1.8 Build 186

**d=15mm, Pin=250mW/Area Scan (81x161x1):** Measurement grid: dx=12mm, dy=12mm

Maximum value of SAR (interpolated) = 2.52 mW/g

**d=15mm, Pin=250mW/Zoom Scan (7x7x7) (7x7x7)/Cube 0:** Measurement grid: dx=5mm, dy=5mm, dz=5mm

Reference Value = 55.4 V/m; Power Drift = -0.238 dB

Peak SAR (extrapolated) = 3.15 W/kg

**SAR(1 g) = 2.13 mW/g; SAR(10 g) = 1.39 mW/g**

Maximum value of SAR (measured) = 2.48 mW/g

# CERTIFICATE OF CALIBRATION

## ISSUED BY UL VS LTD

UKAS Accredited Calibration Laboratory No. 5248

CERTIFICATE  
NUMBER :  
11762345JD01A

Page 6 of 10

### Impedance Measurement Plot for Head Stimulating Liquid (HSL)

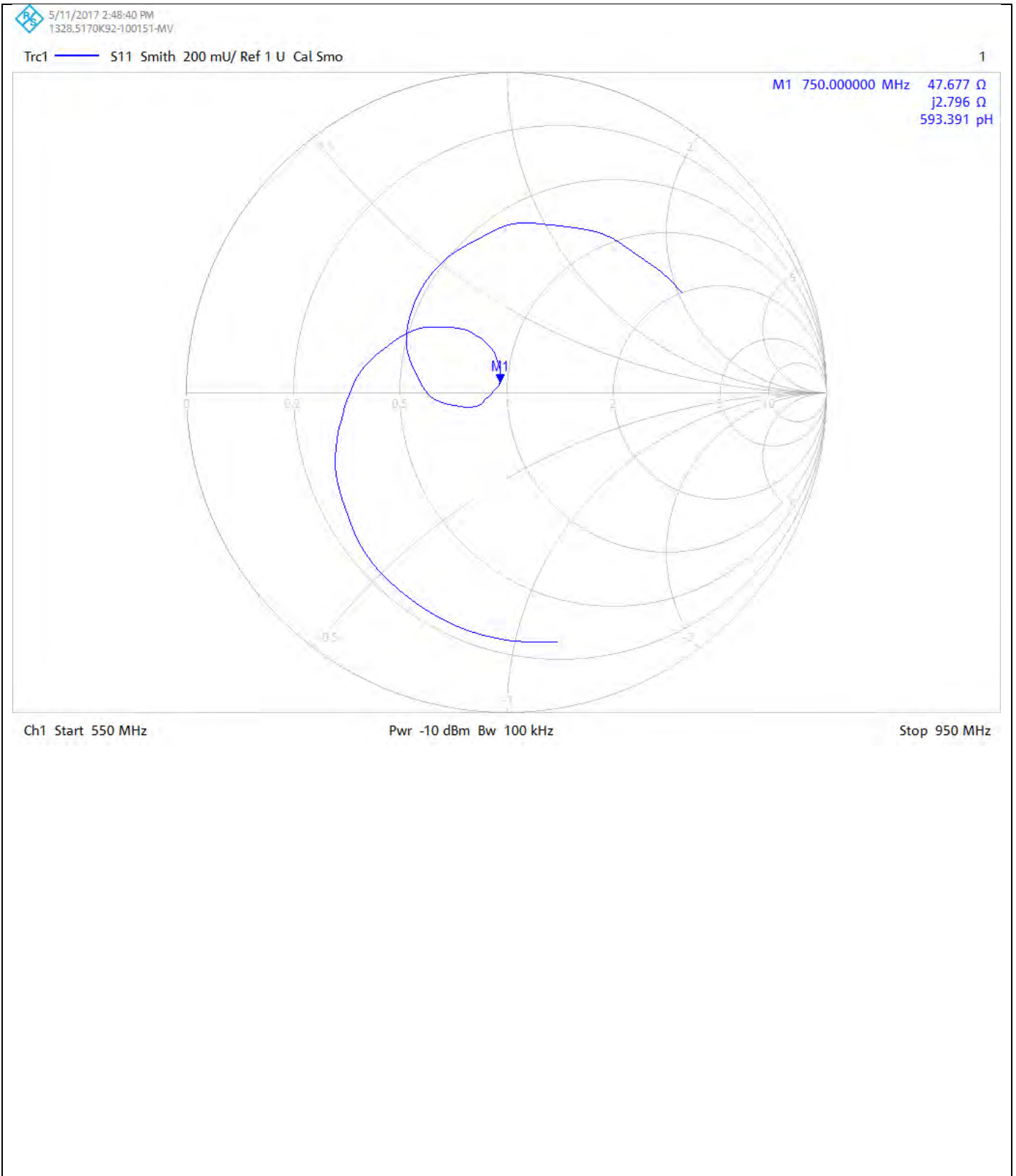

# CERTIFICATE OF CALIBRATION

## ISSUED BY UL VS LTD

UKAS Accredited Calibration Laboratory No. 5248

CERTIFICATE  
NUMBER :  
11762345JD01A

Page 7 of 10

### Return Loss Measurement Plot for Head Stimulating Liquid (HSL)

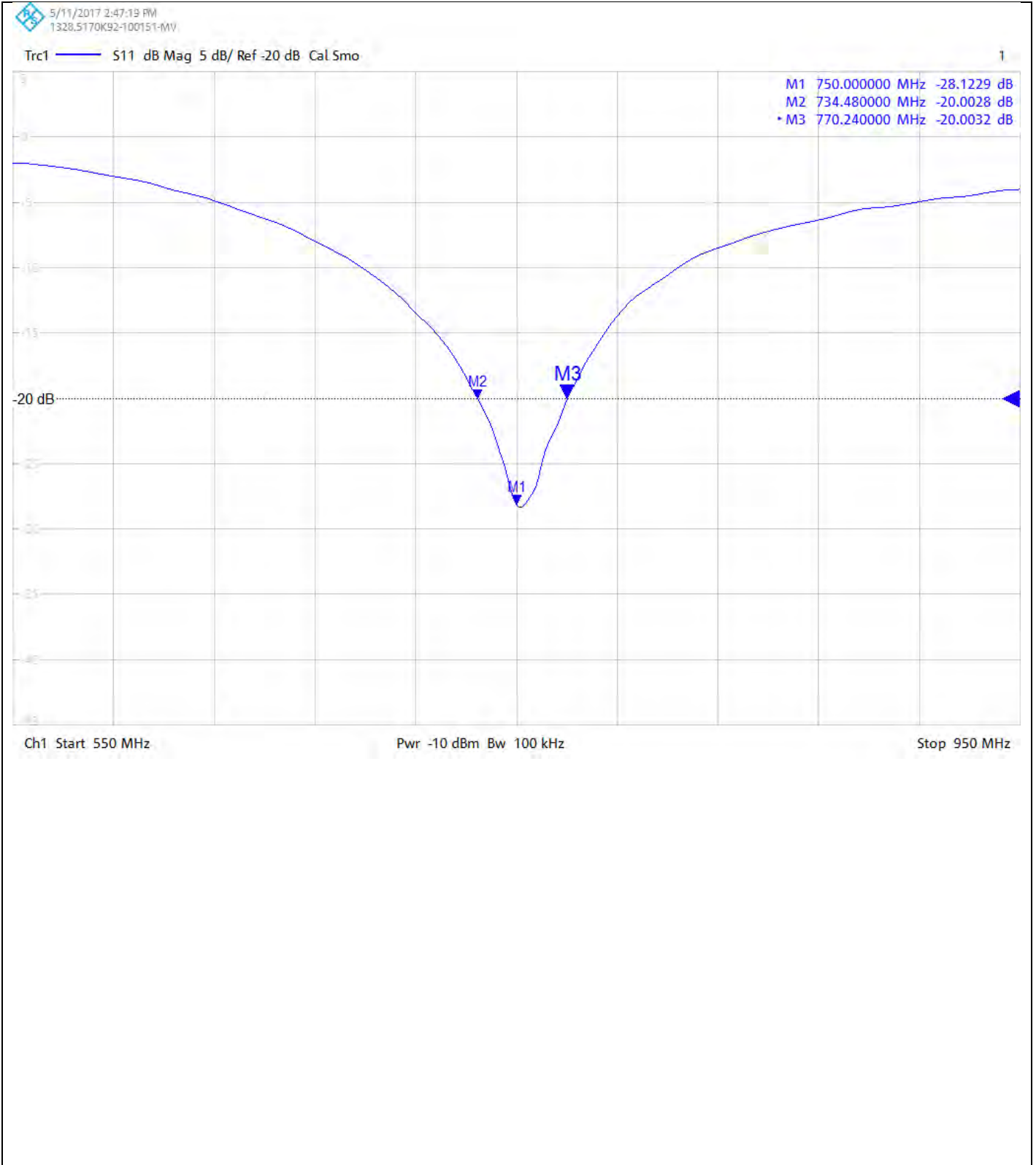

# CERTIFICATE OF CALIBRATION

## ISSUED BY UL VS LTD

UKAS Accredited Calibration Laboratory No. 5248

CERTIFICATE  
NUMBER :  
11762345JD01A

Page 8 of 10

### DASY Validation Scan for Body Stimulating Liquid (MSL)

DUT: Dipole 750 MHz; Type: D750V3; Serial: D750V3 - SN:1024

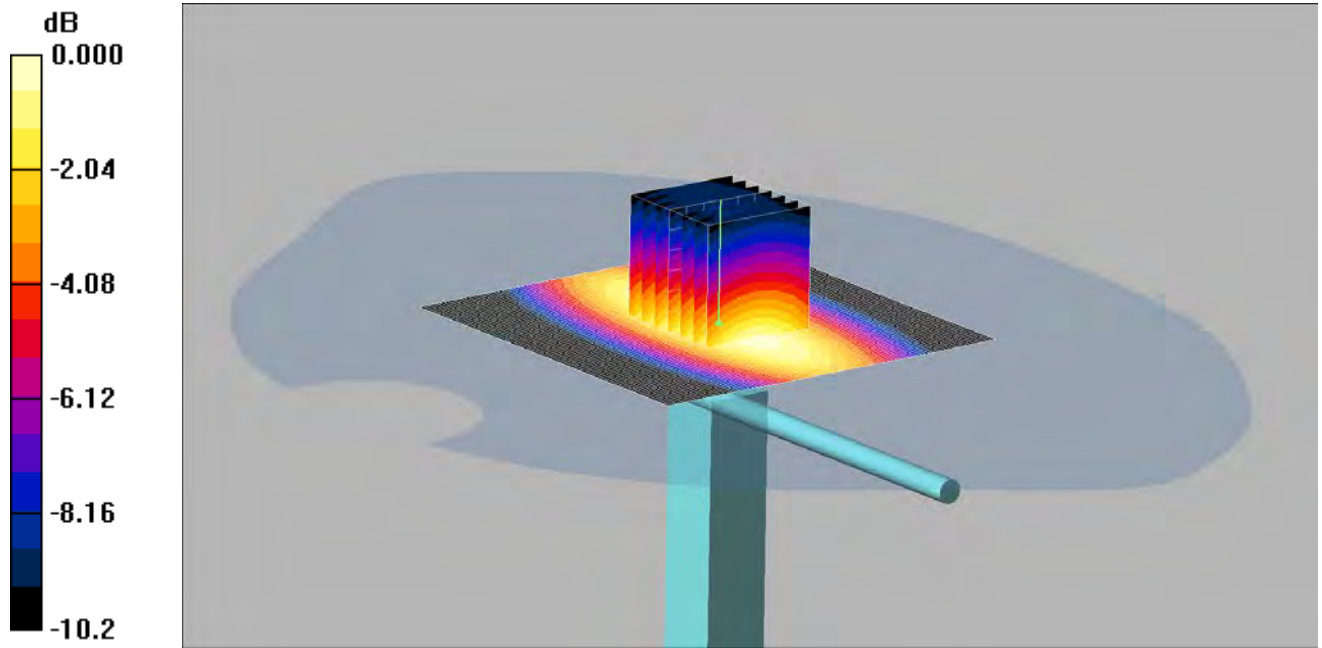

0 dB = 2.34mW/g

Communication System: CW; Frequency: 750 MHz; Duty Cycle: 1:1

Medium: 750 MHz MSL Medium parameters used:  $f = 750$  MHz;  $\sigma = 0.97$  mho/m;  $\epsilon_r = 53.8$ ;  $\rho = 1000$  kg/m<sup>3</sup>

Phantom section: Flat Section

DASY4 Configuration:

- Probe: ES3DV3 - SN3341; ConvF(6.51, 6.51, 6.51);

- Sensor-Surface: 4mm (Mechanical Surface Detection)

- Electronics: DAE4 Sn431; Calibrated: 18/11/2016

- Phantom: SAM 12a (Site 57); Type: SAM 4.0; Serial: TP:1020

- Measurement SW: DASY4, V4.7 Build 80; Postprocessing SW: SEMCAD, V1.8 Build 186

**d=15mm, Pin=250mW/Area Scan (81x81x1)**: Measurement grid: dx=12mm, dy=12mm

Maximum value of SAR (interpolated) = 2.33 mW/g

**d=15mm, Pin=250mW/Zoom Scan (7x7x7) (7x7x7)/Cube 0**: Measurement grid: dx=5mm, dy=5mm, dz=5mm

Reference Value = 49.3 V/m; Power Drift = 0.106 dB

Peak SAR (extrapolated) = 3.23 W/kg

**SAR(1 g) = 2.16 mW/g; SAR(10 g) = 1.42 mW/g**

Maximum value of SAR (measured) = 2.34 mW/g



# CERTIFICATE OF CALIBRATION

## ISSUED BY UL VS LTD

UKAS Accredited Calibration Laboratory No. 5248

CERTIFICATE  
NUMBER :  
11762345JD01A

Page 9 of 10

### Impedance Measurement Plot for Body Stimulating Liquid (MSL)

5/22/2017 11:19:29 AM  
1328.5170K92-100151-MV

Trc1 — S11 Smith 200 mU/ Ref 1 U Cal Smo

1

M1 750.000000 MHz 51.393 Ω  
j3.865 Ω  
820.170 pH

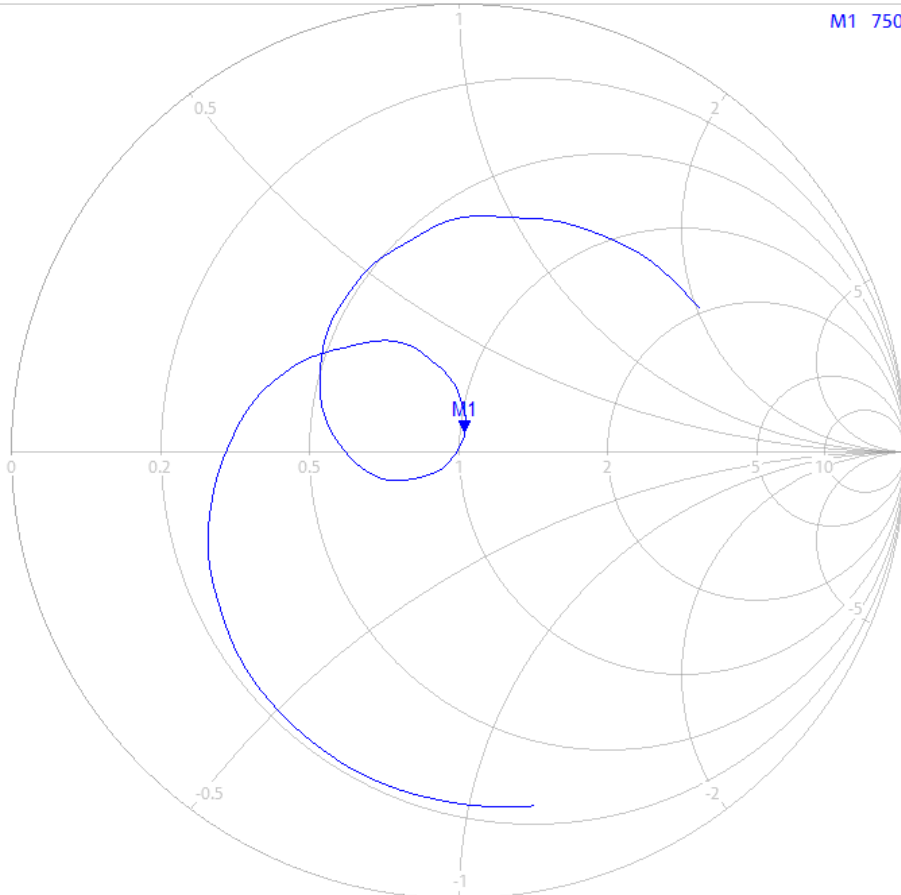

Ch1 Start 550 MHz

Pwr -10 dBm Bw 100 kHz

Stop 950 MHz

# CERTIFICATE OF CALIBRATION

## ISSUED BY UL VS LTD

UKAS Accredited Calibration Laboratory No. 5248

CERTIFICATE  
NUMBER :  
11762345JD01A

Page 10 of 10

### Return Loss Measurement Plot for Body Stimulating Liquid (MSL)

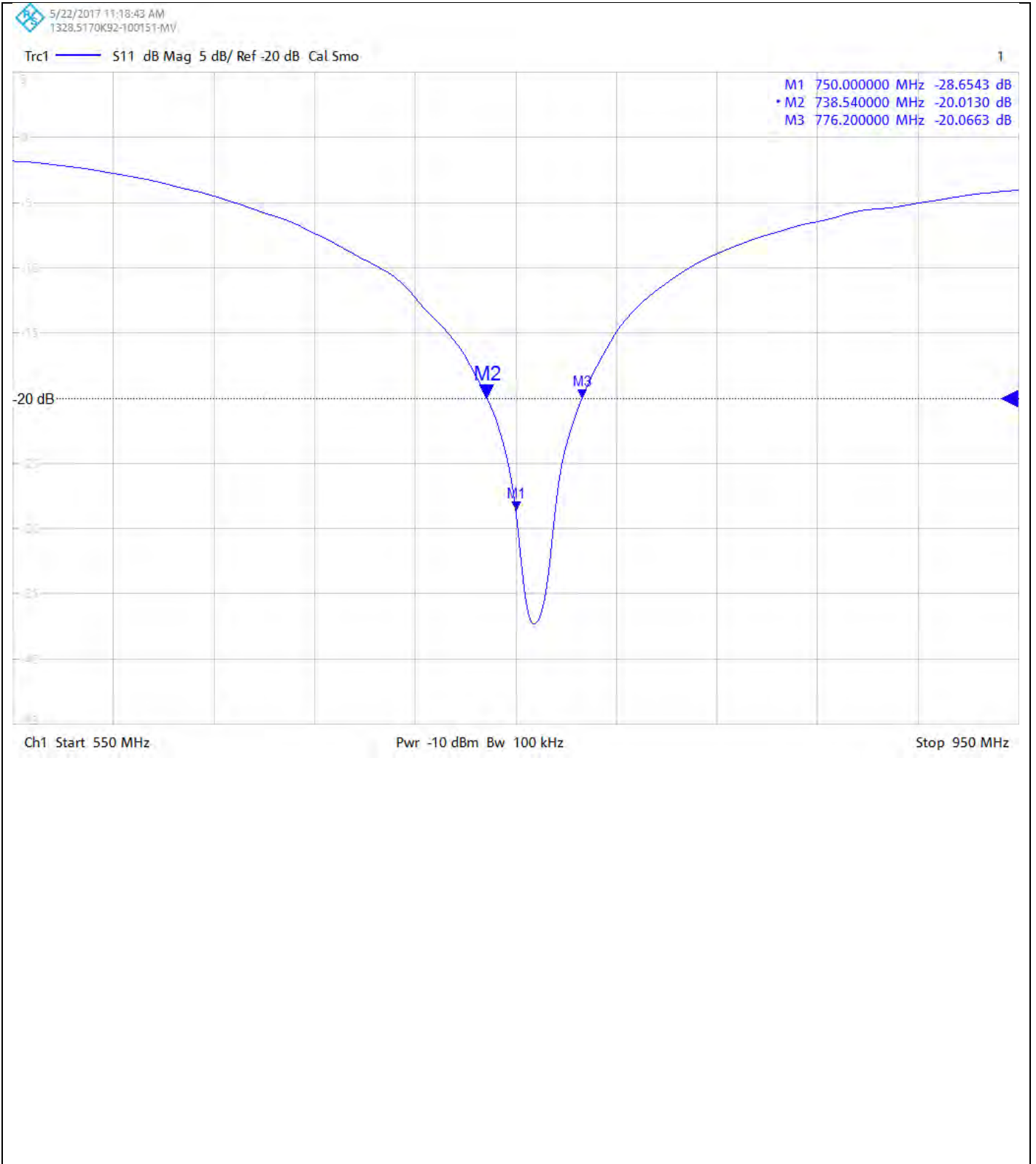

**Calibration Certificate Label:**

 <p>UKAS CALIBRATION 5248</p>	<p><b>UL VS LTD - Tel: +44 (0) 1256312000</b></p> <p>Certificate Number: 11762345JD01A</p> <p>Instrument ID: 1024</p> <p>Calibration Date: 12/May/2017</p> <p>Calibration Due Date:</p>
--	---

 <p>UKAS CALIBRATION 5248</p>	<p><b>UL VS LTD - Tel: +44 (0) 1256312000</b></p> <p>Certificate Number: 11762345JD01A</p> <p>Instrument ID: 1024</p> <p>Calibration Date: 12/May/2017</p> <p>Calibration Due Date:</p>
--	---

 <p>UKAS CALIBRATION 5248</p>	<p><b>UL VS LTD - Tel: +44 (0) 1256312000</b></p> <p>Certificate Number: 11762345JD01A</p> <p>Instrument ID: 1024</p> <p>Calibration Date: 12/May/2017</p> <p>Calibration Due Date:</p>
--	---



Accredited by the Swiss Accreditation Service (SAS)  
**The Swiss Accreditation Service is one of the signatories to the EA  
Multilateral Agreement for the recognition of calibration certificates**

Accreditation No.: **SCS 0108**

Client **UL CCS USA**

Certificate No: **D835V2-4d142\_Sep16**

## CALIBRATION CERTIFICATE

Object **D835V2 - SN:4d142**

Calibration procedure(s) **QA CAL-05.v9  
Calibration procedure for dipole validation kits above 700 MHz**

Calibration date: **September 22, 2016**

This calibration certificate documents the traceability to national standards, which realize the physical units of measurements (SI).  
The measurements and the uncertainties with confidence probability are given on the following pages and are part of the certificate.

All calibrations have been conducted in the closed laboratory facility: environment temperature ( $22 \pm 3$ )°C and humidity < 70%.

Calibration Equipment used (M&TE critical for calibration)

Primary Standards	ID #	Cal Date (Certificate No.)	Scheduled Calibration
Power meter NRP	SN: 104778	06-Apr-16 (No. 217-02288/02289)	Apr-17
Power sensor NRP-Z91	SN: 103244	06-Apr-16 (No. 217-02288)	Apr-17
Power sensor NRP-Z91	SN: 103245	06-Apr-16 (No. 217-02289)	Apr-17
Reference 20 dB Attenuator	SN: 5058 (20k)	05-Apr-16 (No. 217-02292)	Apr-17
Type-N mismatch combination	SN: 5047.2 / 06327	05-Apr-16 (No. 217-02295)	Apr-17
Reference Probe EX3DV4	SN: 7349	15-Jun-16 (No. EX3-7349_Jun16)	Jun-17
DAE4	SN: 601	30-Dec-15 (No. DAE4-601_Dec15)	Dec-16
Secondary Standards	ID #	Check Date (in house)	Scheduled Check
Power meter EPM-442A	SN: GB37480704	07-Oct-15 (No. 217-02222)	In house check: Oct-16
Power sensor HP 8481A	SN: US37292783	07-Oct-15 (No. 217-02222)	In house check: Oct-16
Power sensor HP 8481A	SN: MY41092317	07-Oct-15 (No. 217-02223)	In house check: Oct-16
RF generator R&S SMT-06	SN: 100972	15-Jun-15 (in house check Jun-15)	In house check: Oct-16
Network Analyzer HP 8753E	SN: US37390585	18-Oct-01 (in house check Oct-15)	In house check: Oct-16

	Name	Function	Signature
Calibrated by:	Jeton Kastrati	Laboratory Technician	
Approved by:	Katja Pokovic	Technical Manager	

Issued: September 23, 2016

This calibration certificate shall not be reproduced except in full without written approval of the laboratory.





Accredited by the Swiss Accreditation Service (SAS)

The Swiss Accreditation Service is one of the signatories to the EA Multilateral Agreement for the recognition of calibration certificates

Accreditation No.: **SCS 0108**

**Glossary:**

TSL	tissue simulating liquid
ConvF	sensitivity in TSL / NORM x,y,z
N/A	not applicable or not measured

**Calibration is Performed According to the Following Standards:**

- a) IEEE Std 1528-2013, "IEEE Recommended Practice for Determining the Peak Spatial-Averaged Specific Absorption Rate (SAR) in the Human Head from Wireless Communications Devices: Measurement Techniques", June 2013
- b) IEC 62209-1, "Procedure to measure the Specific Absorption Rate (SAR) for hand-held devices used in close proximity to the ear (frequency range of 300 MHz to 3 GHz)", February 2005
- c) IEC 62209-2, "Procedure to determine the Specific Absorption Rate (SAR) for wireless communication devices used in close proximity to the human body (frequency range of 30 MHz to 6 GHz)", March 2010
- d) KDB 865664, "SAR Measurement Requirements for 100 MHz to 6 GHz"

**Additional Documentation:**

- e) DASY4/5 System Handbook

**Methods Applied and Interpretation of Parameters:**

- *Measurement Conditions:* Further details are available from the Validation Report at the end of the certificate. All figures stated in the certificate are valid at the frequency indicated.
- *Antenna Parameters with TSL:* The dipole is mounted with the spacer to position its feed point exactly below the center marking of the flat phantom section, with the arms oriented parallel to the body axis.
- *Feed Point Impedance and Return Loss:* These parameters are measured with the dipole positioned under the liquid filled phantom. The impedance stated is transformed from the measurement at the SMA connector to the feed point. The Return Loss ensures low reflected power. No uncertainty required.
- *Electrical Delay:* One-way delay between the SMA connector and the antenna feed point. No uncertainty required.
- *SAR measured:* SAR measured at the stated antenna input power.
- *SAR normalized:* SAR as measured, normalized to an input power of 1 W at the antenna connector.
- *SAR for nominal TSL parameters:* The measured TSL parameters are used to calculate the nominal SAR result.

The reported uncertainty of measurement is stated as the standard uncertainty of measurement multiplied by the coverage factor  $k=2$ , which for a normal distribution corresponds to a coverage probability of approximately 95%.

## Measurement Conditions

DASY system configuration, as far as not given on page 1.

<b>DASY Version</b>	DASY5	V52.8.8
<b>Extrapolation</b>	Advanced Extrapolation	
<b>Phantom</b>	Modular Flat Phantom	
<b>Distance Dipole Center - TSL</b>	15 mm	with Spacer
<b>Zoom Scan Resolution</b>	dx, dy, dz = 5.0 mm	
<b>Frequency</b>	835 MHz $\pm$ 1 MHz	

## Head TSL parameters

The following parameters and calculations were applied.

	Temperature	Permittivity	Conductivity
<b>Nominal Head TSL parameters</b>	22.0 °C	41.5	0.90 mho/m
<b>Measured Head TSL parameters</b>	(22.0 $\pm$ 0.2) °C	40.8 $\pm$ 6 %	0.94 mho/m $\pm$ 6 %
<b>Head TSL temperature change during test</b>	< 0.5 °C	----	----

## SAR result with Head TSL

<b>SAR averaged over 1 cm<sup>3</sup> (1 g) of Head TSL</b>	Condition	
SAR measured	250 mW input power	2.41 W/kg
SAR for nominal Head TSL parameters	normalized to 1W	<b>9.30 W/kg <math>\pm</math> 17.0 % (k=2)</b>

<b>SAR averaged over 10 cm<sup>3</sup> (10 g) of Head TSL</b>	condition	
SAR measured	250 mW input power	1.56 W/kg
SAR for nominal Head TSL parameters	normalized to 1W	<b>6.07 W/kg <math>\pm</math> 16.5 % (k=2)</b>

## Body TSL parameters

The following parameters and calculations were applied.

	Temperature	Permittivity	Conductivity
<b>Nominal Body TSL parameters</b>	22.0 °C	55.2	0.97 mho/m
<b>Measured Body TSL parameters</b>	(22.0 $\pm$ 0.2) °C	55.7 $\pm$ 6 %	1.00 mho/m $\pm$ 6 %
<b>Body TSL temperature change during test</b>	< 0.5 °C	----	----

## SAR result with Body TSL

<b>SAR averaged over 1 cm<sup>3</sup> (1 g) of Body TSL</b>	Condition	
SAR measured	250 mW input power	2.38 W/kg
SAR for nominal Body TSL parameters	normalized to 1W	<b>9.32 W/kg <math>\pm</math> 17.0 % (k=2)</b>

<b>SAR averaged over 10 cm<sup>3</sup> (10 g) of Body TSL</b>	condition	
SAR measured	250 mW input power	1.57 W/kg
SAR for nominal Body TSL parameters	normalized to 1W	<b>6.18 W/kg <math>\pm</math> 16.5 % (k=2)</b>

## Appendix (Additional assessments outside the scope of SCS 0108)

### Antenna Parameters with Head TSL

Impedance, transformed to feed point	50.5 $\Omega$ - 6.1 j $\Omega$
Return Loss	- 24.4 dB

### Antenna Parameters with Body TSL

Impedance, transformed to feed point	46.2 $\Omega$ - 8.6 j $\Omega$
Return Loss	- 20.2 dB

### General Antenna Parameters and Design

Electrical Delay (one direction)	1.389 ns
----------------------------------	----------

After long term use with 100W radiated power, only a slight warming of the dipole near the feedpoint can be measured.

The dipole is made of standard semirigid coaxial cable. The center conductor of the feeding line is directly connected to the second arm of the dipole. The antenna is therefore short-circuited for DC-signals. On some of the dipoles, small end caps are added to the dipole arms in order to improve matching when loaded according to the position as explained in the "Measurement Conditions" paragraph. The SAR data are not affected by this change. The overall dipole length is still according to the Standard.

No excessive force must be applied to the dipole arms, because they might bend or the soldered connections near the feedpoint may be damaged.

### Additional EUT Data

Manufactured by	SPEAG
Manufactured on	March 27, 2012



## Appendix (Additional assessments outside the scope of SCS 0108)

### Measurement Conditions

DASY system configuration, as far as not given on page 1 and 3.

Phantom	SAM Head Phantom	For usage with cSAR3DV1-R/L
---------	------------------	-----------------------------

### SAR result with SAM Head (Top)

SAR averaged over 1 cm <sup>3</sup> (1 g) of Head TSL	Condition	
SAR measured	250 mW input power	2.40 W/kg
SAR for nominal Head TSL parameters	normalized to 1W	<b>9.26W/kg ± 17.5 % (k=2)</b>

SAR averaged over 10 cm <sup>3</sup> (10 g) of Head TSL	condition	
SAR measured	250 mW input power	1.59 W/kg
SAR for nominal Head TSL parameters	normalized to 1W	<b>6.18 W/kg ± 16.9 % (k=2)</b>

### SAR result with SAM Head (Mouth)

SAR averaged over 1 cm <sup>3</sup> (1 g) of Head TSL	Condition	
SAR measured	250 mW input power	2.53 W/kg
SAR for nominal Head TSL parameters	normalized to 1W	<b>9.76 W/kg ± 17.5 % (k=2)</b>

SAR averaged over 10 cm <sup>3</sup> (10 g) of Head TSL	condition	
SAR measured	250 mW input power	1.66 W/kg
SAR for nominal Head TSL parameters	normalized to 1W	<b>6.45 W/kg ± 16.9 % (k=2)</b>

### SAR result with SAM Head (Neck)

SAR averaged over 1 cm <sup>3</sup> (1 g) of Head TSL	Condition	
SAR measured	250 mW input power	2.38 W/kg
SAR for nominal Head TSL parameters	normalized to 1W	<b>9.19 W/kg ± 17.5 % (k=2)</b>

SAR averaged over 10 cm <sup>3</sup> (10 g) of Head TSL	condition	
SAR measured	250 mW input power	1.61 W/kg
SAR for nominal Head TSL parameters	normalized to 1W	<b>6.26 W/kg ± 16.9 % (k=2)</b>

### SAR result with SAM Head (Ear)

SAR averaged over 1 cm <sup>3</sup> (1 g) of Head TSL	Condition	
SAR measured	250 mW input power	2.00 W/kg
SAR for nominal Head TSL parameters	normalized to 1W	<b>7.72 W/kg ± 17.5 % (k=2)</b>

SAR averaged over 10 cm <sup>3</sup> (10 g) of Head TSL	condition	
SAR measured	250 mW input power	1.35 W/kg
SAR for nominal Head TSL parameters	normalized to 1W	<b>5.25 W/kg ± 16.9 % (k=2)</b>



# DASY5 Validation Report for Head TSL

Date: 19.09.2016

Test Laboratory: SPEAG, Zurich, Switzerland

**DUT: Dipole 835 MHz; Type: D835V2; Serial: D835V2 - SN:4d142**

Communication System: UID 0 - CW; Frequency: 835 MHz

Medium parameters used:  $f = 835$  MHz;  $\sigma = 0.94$  S/m;  $\epsilon_r = 40.8$ ;  $\rho = 1000$  kg/m<sup>3</sup>

Phantom section: Flat Section

Measurement Standard: DASY5 (IEEE/IEC/ANSI C63.19-2011)

DASY52 Configuration:

- Probe: EX3DV4 - SN7349; ConvF(9.72, 9.72, 9.72); Calibrated: 15.06.2016;
- Sensor-Surface: 1.4mm (Mechanical Surface Detection)
- Electronics: DAE4 Sn601; Calibrated: 30.12.2015
- Phantom: Flat Phantom 4.9L; Type: QD000P49AA; Serial: 1001
- DASY52 52.8.8(1258); SEMCAD X 14.6.10(7372)

## Dipole Calibration for Head Tissue/Pin=250 mW, d=15mm/Zoom Scan (7x7x7)/Cube 0:

Measurement grid: dx=5mm, dy=5mm, dz=5mm

Reference Value = 61.62 V/m; Power Drift = -0.01 dB

Peak SAR (extrapolated) = 3.62 W/kg

**SAR(1 g) = 2.41 W/kg; SAR(10 g) = 1.56 W/kg**

Maximum value of SAR (measured) = 3.22 W/kg

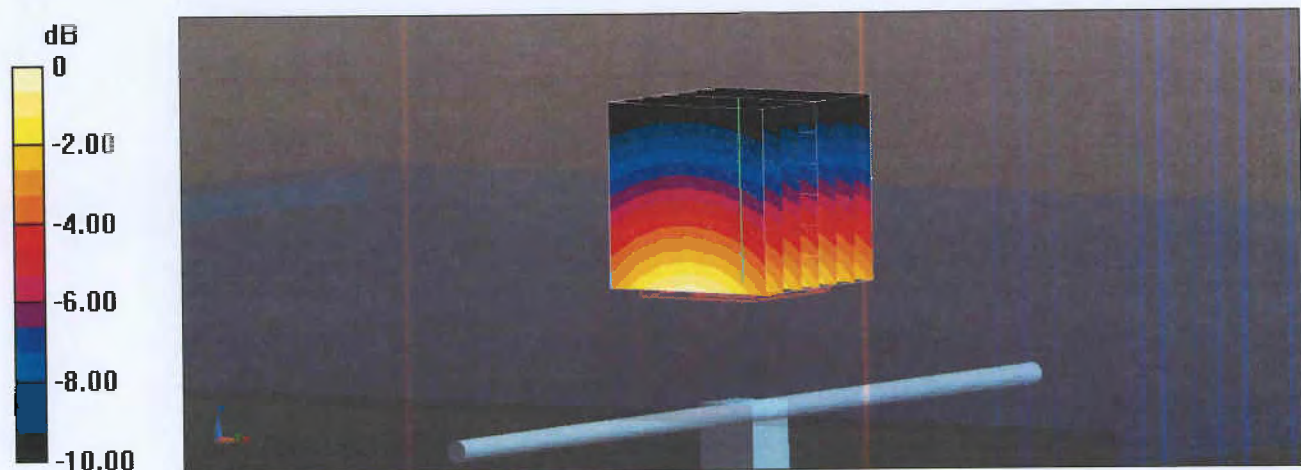

0 dB = 3.22 W/kg = 5.08 dBW/kg

# Impedance Measurement Plot for Head TSL

19 Sep 2016 12:09:13

CH1 S11 1 U FS

2: 50.506  $\Omega$  -6.0547  $\Omega$  31.481 pF

835.000 000 MHz

\*  
Del  
CA

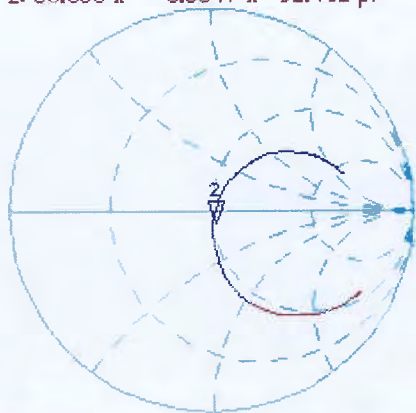

Avg  
16

H1d

CH2 S11 LOG

5 dB/REF -20 dB

2:-24.388 dB

835.000 000 MHz

CA

Avg  
16

H1d

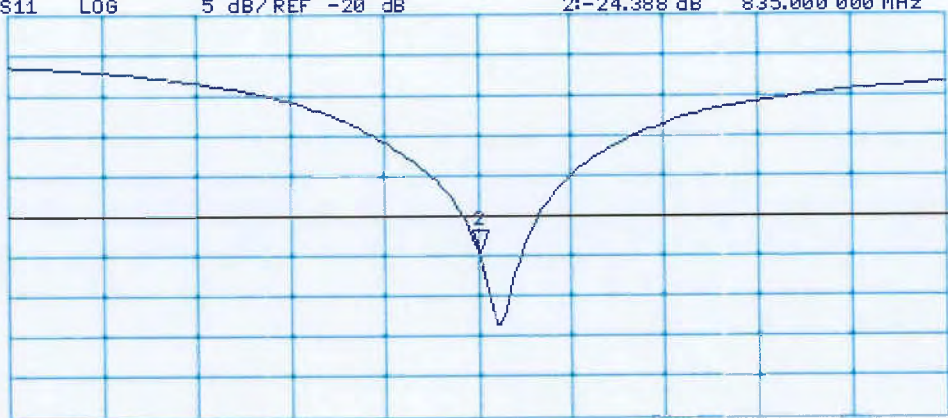

START 635.000 000 MHz

STOP 1 035.000 000 MHz



## DASY5 Validation Report for Body TSL

Date: 12.09.2016

Test Laboratory: SPEAG, Zurich, Switzerland

**DUT: Dipole 835 MHz; Type: D835V2; Serial: D835V2 - SN: 4d142**

Communication System: UID 0 - CW; Frequency: 835 MHz

Medium parameters used:  $f = 835$  MHz;  $\sigma = 1$  S/m;  $\epsilon_r = 55.7$ ;  $\rho = 1000$  kg/m<sup>3</sup>

Phantom section: Flat Section

Measurement Standard: DASY5 (IEEE/IEC/ANSI C63.19-2011)

DASY52 Configuration:

- Probe: EX3DV4 - SN7349; ConvF(9.73, 9.73, 9.73); Calibrated: 15.06.2016;
- Sensor-Surface: 1.4mm (Mechanical Surface Detection)
- Electronics: DAE4 Sn601; Calibrated: 30.12.2015
- Phantom: Flat Phantom 4.9L; Type: QD000P49AA; Serial: 1001
- DASY52 52.8.8(1258); SEMCAD X 14.6.10(7372)

### Dipole Calibration for Body Tissue/Pin=250 mW, d=15mm/Zoom Scan (7x7x7)/Cube 0:

Measurement grid: dx=5mm, dy=5mm, dz=5mm

Reference Value = 59.27 V/m; Power Drift = -0.01 dB

Peak SAR (extrapolated) = 3.43 W/kg

**SAR(1 g) = 2.38 W/kg; SAR(10 g) = 1.57 W/kg**

Maximum value of SAR (measured) = 3.11 W/kg

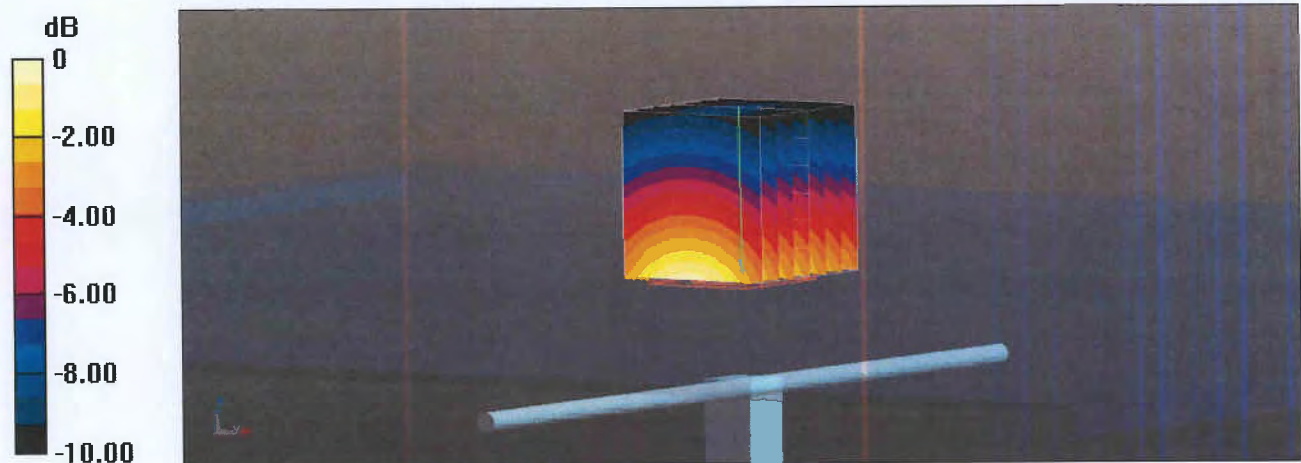

0 dB = 3.11 W/kg = 4.93 dBW/kg

# Impedance Measurement Plot for Body TSL

12 Sep 2016 10:59:17

CH1 S11 1 U FS

1: 46.160  $\Omega$  -8.6035  $\Omega$  22.154 pF 835.000 000 MHz

\*  
Del  
CA

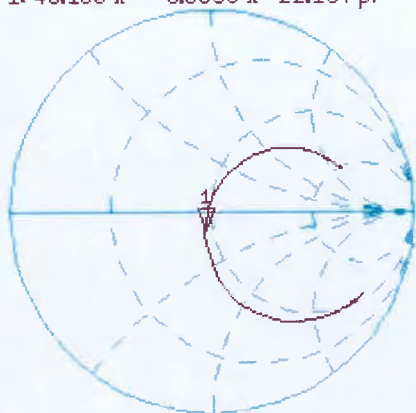

Avg  
16

H1d

CH2 S11 LOG 5 dB/REF -20 dB 1:-20.214 dB 835.000 000 MHz

CA

Avg  
16

H1d

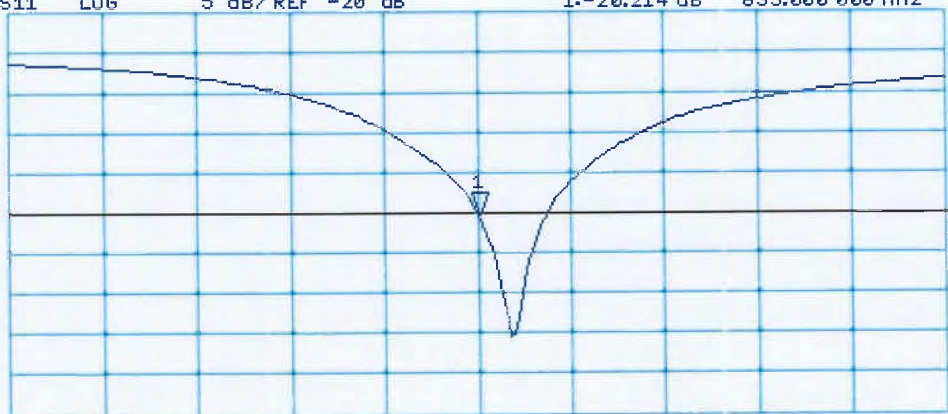

START 635.000 000 MHz

STOP 1 035.000 000 MHz

## DASY5 Validation Report for SAM Head

Date: 22.09.2016

Test Laboratory: SPEAG, Zurich, Switzerland

**DUT: Dipole 835 MHz; Type: D835V2; Serial: D835V2 - SN: 4d142**

Communication System: UID 0 - CW; Frequency: 835 MHz

Medium parameters used:  $f = 835$  MHz;  $\sigma = 0.95$  S/m;  $\epsilon_r = 42.4$ ;  $\rho = 1000$  kg/m<sup>3</sup>

Measurement Standard: DASY5 (IEEE/IEC/ANSI C63.19-2011)

DASY52 Configuration:

- Probe: EX3DV4 - SN7349; ConvF(9.72, 9.72, 9.72); Calibrated: 15.06.2016;
- Sensor-Surface: 1.4mm (Mechanical Surface Detection)
- Electronics: DAE4 Sn601; Calibrated: 30.12.2015
- Phantom: SAM Head
- DASY52 52.8.8(1258); SEMCAD X 14.6.10(7372)

**SAM Head/Top/Zoom Scan (7x7x7)/Cube 0:** Measurement grid: dx=5mm, dy=5mm, dz=5mm

Reference Value = 60.83 V/m; Power Drift = -0.02 dB

Peak SAR (extrapolated) = 3.53 W/kg

**SAR(1 g) = 2.40 W/kg; SAR(10 g) = 1.59 W/kg**

Maximum value of SAR (measured) = 3.16 W/kg

**SAM Head/Mouth/Zoom Scan (7x8x7)/Cube 0:** Measurement grid: dx=5mm, dy=5mm, dz=5mm

Reference Value = 58.70 V/m; Power Drift = -0.02 dB

Peak SAR (extrapolated) = 3.92 W/kg

**SAR(1 g) = 2.53 W/kg; SAR(10 g) = 1.66 W/kg**

Maximum value of SAR (measured) = 3.53 W/kg

**SAM Head/Neck/Zoom Scan (7x7x7)/Cube 0:** Measurement grid: dx=5mm, dy=5mm, dz=5mm

Reference Value = 59.26 V/m; Power Drift = 0.03 dB

Peak SAR (extrapolated) = 3.35 W/kg

**SAR(1 g) = 2.38 W/kg; SAR(10 g) = 1.61 W/kg**

Maximum value of SAR (measured) = 3.05 W/kg

**SAM Head/Ear/Zoom Scan (8x7x7)/Cube 0:** Measurement grid: dx=5mm, dy=5mm, dz=5mm

Reference Value = 54.45 V/m; Power Drift = 0.01 dB

Peak SAR (extrapolated) = 2.83 W/kg

**SAR(1 g) = 2 W/kg; SAR(10 g) = 1.35 W/kg**

Maximum value of SAR (measured) = 2.55 W/kg

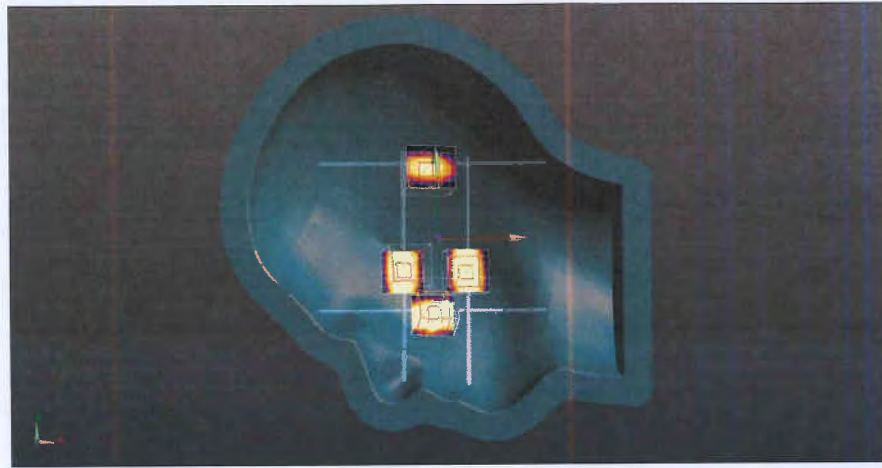
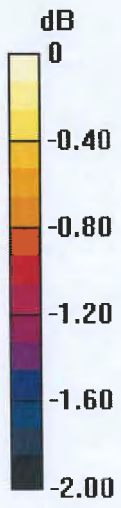

0 dB = 2.55 W/kg = 4.07 dBW/kg





Accreditation No.: **SCS 0108**

Accredited by the Swiss Accreditation Service (SAS)  
**The Swiss Accreditation Service is one of the signatories to the EA  
Multilateral Agreement for the recognition of calibration certificates**

Client **UL CCS USA**

Certificate No: **D1750V2-1053\_Aug16**

## CALIBRATION CERTIFICATE

Object **D1750V2 - SN:1053**

Calibration procedure(s) **QA CAL-05.v9  
Calibration procedure for dipole validation kits above 700 MHz**

Calibration date: **August 16, 2016**

This calibration certificate documents the traceability to national standards, which realize the physical units of measurements (SI).  
The measurements and the uncertainties with confidence probability are given on the following pages and are part of the certificate.

All calibrations have been conducted in the closed laboratory facility: environment temperature (22 ± 3)°C and humidity < 70%.

Calibration Equipment used (M&TE critical for calibration)

Primary Standards	ID #	Cal Date (Certificate No.)	Scheduled Calibration
Power meter NRP	SN: 104778	06-Apr-16 (No. 217-02288/02289)	Apr-17
Power sensor NRP-Z91	SN: 103244	06-Apr-16 (No. 217-02288)	Apr-17
Power sensor NRP-Z91	SN: 103245	06-Apr-16 (No. 217-02289)	Apr-17
Reference 20 dB Attenuator	SN: 5058 (20k)	05-Apr-16 (No. 217-02292)	Apr-17
Type-N mismatch combination	SN: 5047.2 / 06327	05-Apr-16 (No. 217-02295)	Apr-17
Reference Probe EX3DV4	SN: 7349	15-Jun-16 (No. EX3-7349_Jun16)	Jun-17
DAE4	SN: 601	30-Dec-15 (No. DAE4-601_Dec15)	Dec-16
Secondary Standards	ID #	Check Date (in house)	Scheduled Check
Power meter EPM-442A	SN: GB37480704	07-Oct-15 (No. 217-02222)	In house check: Oct-16
Power sensor HP 8481A	SN: US37292783	07-Oct-15 (No. 217-02222)	In house check: Oct-16
Power sensor HP 8481A	SN: MY41092317	07-Oct-15 (No. 217-02223)	In house check: Oct-16
RF generator R&S SMT-06	SN: 100972	15-Jun-15 (in house check Jun-15)	In house check: Oct-16
Network Analyzer HP 8753E	SN: US37390585	18-Oct-01 (in house check Oct-15)	In house check: Oct-16

	Name	Function	Signature
Calibrated by:	Jeton Kastrati	Laboratory Technician	
Approved by:	Katja Pokovic	Technical Manager	

Issued: August 16, 2016

This calibration certificate shall not be reproduced except in full without written approval of the laboratory.



Accredited by the Swiss Accreditation Service (SAS)

The Swiss Accreditation Service is one of the signatories to the EA Multilateral Agreement for the recognition of calibration certificates

**Glossary:**

TSL	tissue simulating liquid
ConvF	sensitivity in TSL / NORM x,y,z
N/A	not applicable or not measured

**Calibration is Performed According to the Following Standards:**

- a) IEEE Std 1528-2013, "IEEE Recommended Practice for Determining the Peak Spatial-Averaged Specific Absorption Rate (SAR) in the Human Head from Wireless Communications Devices: Measurement Techniques", June 2013
- b) IEC 62209-1, "Procedure to measure the Specific Absorption Rate (SAR) for hand-held devices used in close proximity to the ear (frequency range of 300 MHz to 3 GHz)", February 2005
- c) IEC 62209-2, "Procedure to determine the Specific Absorption Rate (SAR) for wireless communication devices used in close proximity to the human body (frequency range of 30 MHz to 6 GHz)", March 2010
- d) KDB 865664, "SAR Measurement Requirements for 100 MHz to 6 GHz"

**Additional Documentation:**

- e) DAS4/5 System Handbook

**Methods Applied and Interpretation of Parameters:**

- *Measurement Conditions:* Further details are available from the Validation Report at the end of the certificate. All figures stated in the certificate are valid at the frequency indicated.
- *Antenna Parameters with TSL:* The dipole is mounted with the spacer to position its feed point exactly below the center marking of the flat phantom section, with the arms oriented parallel to the body axis.
- *Feed Point Impedance and Return Loss:* These parameters are measured with the dipole positioned under the liquid filled phantom. The impedance stated is transformed from the measurement at the SMA connector to the feed point. The Return Loss ensures low reflected power. No uncertainty required.
- *Electrical Delay:* One-way delay between the SMA connector and the antenna feed point. No uncertainty required.
- *SAR measured:* SAR measured at the stated antenna input power.
- *SAR normalized:* SAR as measured, normalized to an input power of 1 W at the antenna connector.
- *SAR for nominal TSL parameters:* The measured TSL parameters are used to calculate the nominal SAR result.

The reported uncertainty of measurement is stated as the standard uncertainty of measurement multiplied by the coverage factor  $k=2$ , which for a normal distribution corresponds to a coverage probability of approximately 95%.



## Measurement Conditions

DASY system configuration, as far as not given on page 1.

DASY Version	DASY5	V52.8.8
Extrapolation	Advanced Extrapolation	
Phantom	Modular Flat Phantom	
Distance Dipole Center - TSL	10 mm	with Spacer
Zoom Scan Resolution	dx, dy, dz = 5 mm	
Frequency	1750 MHz $\pm$ 1 MHz	

## Head TSL parameters

The following parameters and calculations were applied.

	Temperature	Permittivity	Conductivity
Nominal Head TSL parameters	22.0 °C	40.1	1.37 mho/m
Measured Head TSL parameters	(22.0 $\pm$ 0.2) °C	40.3 $\pm$ 6 %	1.37 mho/m $\pm$ 6 %
Head TSL temperature change during test	< 0.5 °C	----	----

## SAR result with Head TSL

SAR averaged over 1 cm <sup>3</sup> (1 g) of Head TSL	Condition	
SAR measured	250 mW input power	9.34 W/kg
SAR for nominal Head TSL parameters	normalized to 1W	<b>37.4 W/kg <math>\pm</math> 17.0 % (k=2)</b>

SAR averaged over 10 cm <sup>3</sup> (10 g) of Head TSL	condition	
SAR measured	250 mW input power	4.93 W/kg
SAR for nominal Head TSL parameters	normalized to 1W	<b>19.7 W/kg <math>\pm</math> 16.5 % (k=2)</b>

## Body TSL parameters

The following parameters and calculations were applied.

	Temperature	Permittivity	Conductivity
Nominal Body TSL parameters	22.0 °C	53.4	1.49 mho/m
Measured Body TSL parameters	(22.0 $\pm$ 0.2) °C	53.1 $\pm$ 6 %	1.49 mho/m $\pm$ 6 %
Body TSL temperature change during test	< 0.5 °C	----	----

## SAR result with Body TSL

SAR averaged over 1 cm <sup>3</sup> (1 g) of Body TSL	Condition	
SAR measured	250 mW input power	9.36 W/kg
SAR for nominal Body TSL parameters	normalized to 1W	<b>37.4 W/kg <math>\pm</math> 17.0 % (k=2)</b>

SAR averaged over 10 cm <sup>3</sup> (10 g) of Body TSL	condition	
SAR measured	250 mW input power	4.94 W/kg
SAR for nominal Body TSL parameters	normalized to 1W	<b>19.7 W/kg <math>\pm</math> 16.5 % (k=2)</b>

## Appendix (Additional assessments outside the scope of SCS 0108)

### Antenna Parameters with Head TSL

Impedance, transformed to feed point	49.6 $\Omega$ + 0.3 j $\Omega$
Return Loss	- 46.3 dB

### Antenna Parameters with Body TSL

Impedance, transformed to feed point	46.2 $\Omega$ - 2.1 j $\Omega$
Return Loss	- 26.9 dB

### General Antenna Parameters and Design

Electrical Delay (one direction)	1.219 ns
----------------------------------	----------

After long term use with 100W radiated power, only a slight warming of the dipole near the feedpoint can be measured.

The dipole is made of standard semirigid coaxial cable. The center conductor of the feeding line is directly connected to the second arm of the dipole. The antenna is therefore short-circuited for DC-signals. On some of the dipoles, small end caps are added to the dipole arms in order to improve matching when loaded according to the position as explained in the "Measurement Conditions" paragraph. The SAR data are not affected by this change. The overall dipole length is still according to the Standard.

No excessive force must be applied to the dipole arms, because they might bend or the soldered connections near the feedpoint may be damaged.

### Additional EUT Data

Manufactured by	SPEAG
Manufactured on	February 19, 2010

# DASY5 Validation Report for Head TSL

Date: 16.08.2016

Test Laboratory: SPEAG, Zurich, Switzerland

**DUT: Dipole 1750 MHz; Type: D1750V2; Serial: D1750V2 - SN:1053**

Communication System: UID 0 - CW; Frequency: 1750 MHz

Medium parameters used:  $f = 1750$  MHz;  $\sigma = 1.37$  S/m;  $\epsilon_r = 40.3$ ;  $\rho = 1000$  kg/m<sup>3</sup>

Phantom section: Flat Section

Measurement Standard: DASY5 (IEEE/IEC/ANSI C63.19-2011)

DASY52 Configuration:

- Probe: EX3DV4 - SN7349; ConvF(8.46, 8.46, 8.46); Calibrated: 15.06.2016;
- Sensor-Surface: 1.4mm (Mechanical Surface Detection)
- Electronics: DAE4 Sn601; Calibrated: 30.12.2015
- Phantom: Flat Phantom 5.0 (front); Type: QD000P50AA; Serial: 1001
- DASY52 52.8.8(1258); SEMCAD X 14.6.10(7372)

## Dipole Calibration for Head Tissue/Pin=250 mW, d=10mm/Zoom Scan (7x7x7)/Cube 0:

Measurement grid: dx=5mm, dy=5mm, dz=5mm

Reference Value = 106.4 V/m; Power Drift = -0.01 dB

Peak SAR (extrapolated) = 17.4 W/kg

**SAR(1 g) = 9.34 W/kg; SAR(10 g) = 4.93 W/kg**

Maximum value of SAR (measured) = 14.4 W/kg

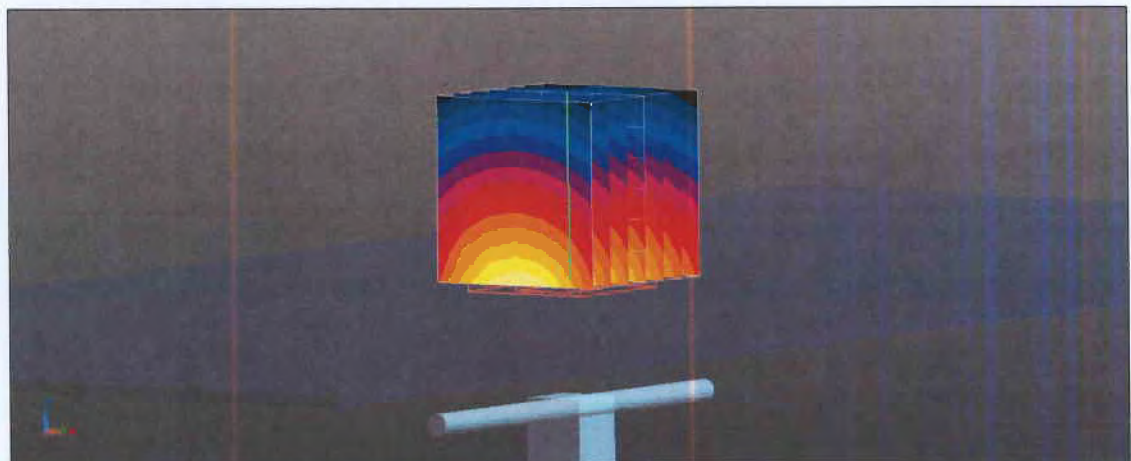
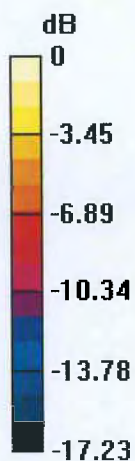

0 dB = 14.4 W/kg = 11.58 dBW/kg

# Impedance Measurement Plot for Head TSL

16 Aug 2016 13:22:53

CH1 S11 1 U FS 1: 49.637  $\Omega$  0.3184  $\Omega$  28.953  $\mu\text{H}$  1 750.000 000 MHz

\*  
Del  
CA

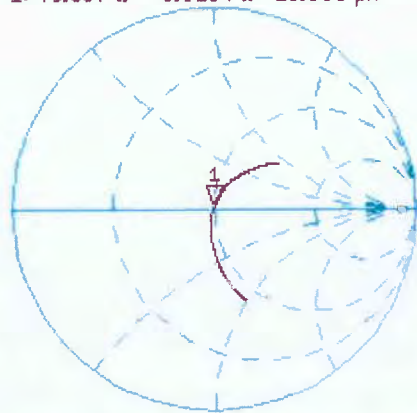

Avg  
16

H1d

CH2 S11 LOG 5 dB/REF -20 dB 1: -46.312 dB 1 750.000 000 MHz

CA

Avg  
16

H1d

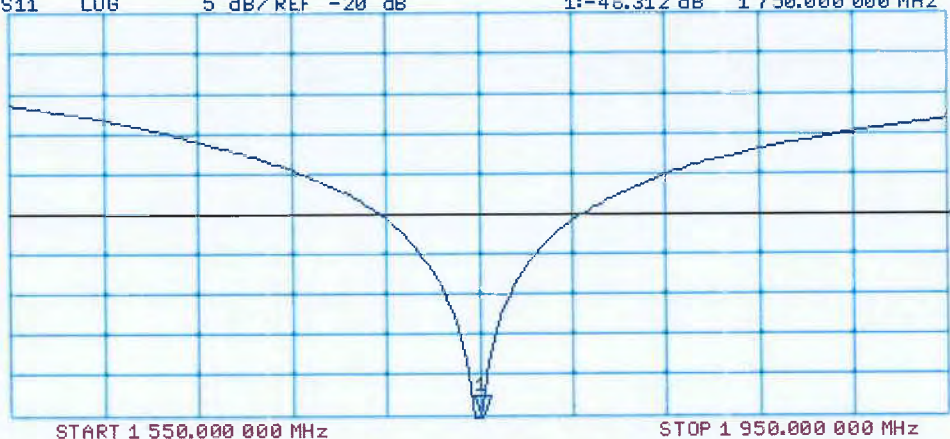



# DASY5 Validation Report for Body TSL

Date: 15.08.2016

Test Laboratory: SPEAG, Zurich, Switzerland

**DUT: Dipole 1750 MHz; Type: D1750V2; Serial: D1750V2 - SN:1053**

Communication System: UID 0 - CW; Frequency: 1750 MHz

Medium parameters used:  $f = 1750$  MHz;  $\sigma = 1.49$  S/m;  $\epsilon_r = 53.1$ ;  $\rho = 1000$  kg/m<sup>3</sup>

Phantom section: Flat Section

Measurement Standard: DASY5 (IEEE/IEC/ANSI C63.19-2011)

DASY52 Configuration:

- Probe: EX3DV4 - SN7349; ConvF(8.25, 8.25, 8.25); Calibrated: 15.06.2016;
- Sensor-Surface: 1.4mm (Mechanical Surface Detection)
- Electronics: DAE4 Sn601; Calibrated: 30.12.2015
- Phantom: Flat Phantom 5.0 (back); Type: QD000P50AA; Serial: 1002
- DASY52 52.8.8(1258); SEMCAD X 14.6.10(7372)

## Dipole Calibration for Body Tissue/ $P_{in}=250$ mW, $d=10$ mm/Zoom Scan (7x7x7)/Cube 0:

Measurement grid:  $dx=5$ mm,  $dy=5$ mm,  $dz=5$ mm

Reference Value = 101.8 V/m; Power Drift = -0.02 dB

Peak SAR (extrapolated) = 16.7 W/kg

**SAR(1 g) = 9.36 W/kg; SAR(10 g) = 4.94 W/kg**

Maximum value of SAR (measured) = 14.1 W/kg

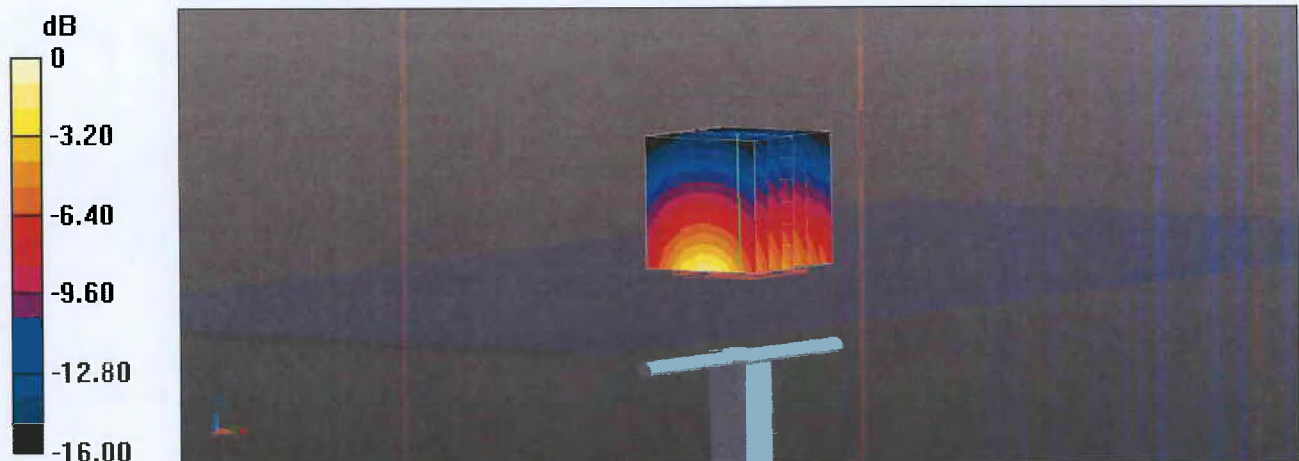

0 dB = 14.1 W/kg = 11.49 dBW/kg

# Impedance Measurement Plot for Body TSL

15 Aug 2016 16:32:27

CH1 S11 1 U FS 1: 46.188  $\Omega$  -2.0977  $\Omega$  43.356 pF 1 750.000 000 MHz

\*  
De l  
CA

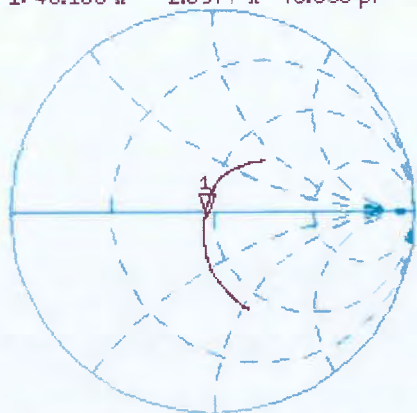

Avg  
16

H1 d

CH2 S11 LOG 5 dB/REF -20 dB 1: -26.884 dB 1 750.000 000 MHz

CA

Avg  
16

H1 d



START 1 550.000 000 MHz

STOP 1 950.000 000 MHz





Accreditation No.: **SCS 0108**

Accredited by the Swiss Accreditation Service (SAS)  
The Swiss Accreditation Service is one of the signatories to the EA  
Multilateral Agreement for the recognition of calibration certificates

Client **UL CCS USA**

Certificate No: **D1900V2-5d043\_Nov16**

## CALIBRATION CERTIFICATE

Object **D1900V2 - SN:5d043**

Calibration procedure(s) **QA CAL-05.v9  
Calibration procedure for dipole validation kits above 700 MHz**

Calibration date: **November 09, 2016**

This calibration certificate documents the traceability to national standards, which realize the physical units of measurements (SI).  
The measurements and the uncertainties with confidence probability are given on the following pages and are part of the certificate.

All calibrations have been conducted in the closed laboratory facility: environment temperature ( $22 \pm 3$ )°C and humidity < 70%.

Calibration Equipment used (M&TE critical for calibration)

Primary Standards	ID #	Cal Date (Certificate No.)	Scheduled Calibration
Power meter NRP	SN: 104778	06-Apr-16 (No. 217-02288/02289)	Apr-17
Power sensor NRP-Z91	SN: 103244	06-Apr-16 (No. 217-02288)	Apr-17
Power sensor NRP-Z91	SN: 103245	06-Apr-16 (No. 217-02289)	Apr-17
Reference 20 dB Attenuator	SN: 5058 (20k)	05-Apr-16 (No. 217-02292)	Apr-17
Type-N mismatch combination	SN: 5047.2 / 06327	05-Apr-16 (No. 217-02295)	Apr-17
Reference Probe EX3DV4	SN: 7349	15-Jun-16 (No. EX3-7349_Jun16)	Jun-17
DAE4	SN: 601	30-Dec-15 (No. DAE4-601_Dec15)	Dec-16

Secondary Standards	ID #	Check Date (in house)	Scheduled Check
Power meter EPM-442A	SN: GB37480704	07-Oct-15 (in house check Oct-16)	In house check: Oct-18
Power sensor HP 8481A	SN: US37292783	07-Oct-15 (in house check Oct-16)	In house check: Oct-18
Power sensor HP 8481A	SN: MY41092317	07-Oct-15 (in house check Oct-16)	In house check: Oct-18
RF generator R&S SMT-06	SN: 100972	15-Jun-15 (in house check Oct-16)	In house check: Oct-18
Network Analyzer HP 8753E	SN: US37390585	18-Oct-01 (in house check Oct-16)	In house check: Oct-17

	Name	Function	Signature
Calibrated by:	Jeton Kastriati	Laboratory Technician	
Approved by:	Katja Pokovic	Technical Manager	

Issued: November 10, 2016

This calibration certificate shall not be reproduced except in full without written approval of the laboratory.





Accredited by the Swiss Accreditation Service (SAS)

Accreditation No.: **SCS 0108**

The Swiss Accreditation Service is one of the signatories to the EA Multilateral Agreement for the recognition of calibration certificates

### Glossary:

TSL	tissue simulating liquid
ConvF	sensitivity in TSL / NORM x,y,z
N/A	not applicable or not measured

### Calibration is Performed According to the Following Standards:

- IEEE Std 1528-2013, "IEEE Recommended Practice for Determining the Peak Spatial-Averaged Specific Absorption Rate (SAR) in the Human Head from Wireless Communications Devices: Measurement Techniques", June 2013
- IEC 62209-1, "Procedure to measure the Specific Absorption Rate (SAR) for hand-held devices used in close proximity to the ear (frequency range of 300 MHz to 3 GHz)", February 2005
- IEC 62209-2, "Procedure to determine the Specific Absorption Rate (SAR) for wireless communication devices used in close proximity to the human body (frequency range of 30 MHz to 6 GHz)", March 2010
- KDB 865664, "SAR Measurement Requirements for 100 MHz to 6 GHz"

### Additional Documentation:

- DASY4/5 System Handbook

### Methods Applied and Interpretation of Parameters:

- Measurement Conditions:** Further details are available from the Validation Report at the end of the certificate. All figures stated in the certificate are valid at the frequency indicated.
- Antenna Parameters with TSL:** The dipole is mounted with the spacer to position its feed point exactly below the center marking of the flat phantom section, with the arms oriented parallel to the body axis.
- Feed Point Impedance and Return Loss:** These parameters are measured with the dipole positioned under the liquid filled phantom. The impedance stated is transformed from the measurement at the SMA connector to the feed point. The Return Loss ensures low reflected power. No uncertainty required.
- Electrical Delay:** One-way delay between the SMA connector and the antenna feed point. No uncertainty required.
- SAR measured:** SAR measured at the stated antenna input power.
- SAR normalized:** SAR as measured, normalized to an input power of 1 W at the antenna connector.
- SAR for nominal TSL parameters:** The measured TSL parameters are used to calculate the nominal SAR result.

The reported uncertainty of measurement is stated as the standard uncertainty of measurement multiplied by the coverage factor  $k=2$ , which for a normal distribution corresponds to a coverage probability of approximately 95%.



## Measurement Conditions

DASY system configuration, as far as not given on page 1.

<b>DASY Version</b>	DASY5	V52.8.8
<b>Extrapolation</b>	Advanced Extrapolation	
<b>Phantom</b>	Modular Flat Phantom	
<b>Distance Dipole Center - TSL</b>	10 mm	with Spacer
<b>Zoom Scan Resolution</b>	dx, dy, dz = 5 mm	
<b>Frequency</b>	1900 MHz $\pm$ 1 MHz	

## Head TSL parameters

The following parameters and calculations were applied.

	Temperature	Permittivity	Conductivity
<b>Nominal Head TSL parameters</b>	22.0 °C	40.0	1.40 mho/m
<b>Measured Head TSL parameters</b>	(22.0 $\pm$ 0.2) °C	40.6 $\pm$ 6 %	1.39 mho/m $\pm$ 6 %
<b>Head TSL temperature change during test</b>	< 0.5 °C	----	----

## SAR result with Head TSL

<b>SAR averaged over 1 cm<sup>3</sup> (1 g) of Head TSL</b>	Condition	
SAR measured	250 mW input power	9.92 W/kg
SAR for nominal Head TSL parameters	normalized to 1W	<b>40.0 W/kg <math>\pm</math> 17.0 % (k=2)</b>

<b>SAR averaged over 10 cm<sup>3</sup> (10 g) of Head TSL</b>	condition	
SAR measured	250 mW input power	5.19 W/kg
SAR for nominal Head TSL parameters	normalized to 1W	<b>20.9 W/kg <math>\pm</math> 16.5 % (k=2)</b>

## Body TSL parameters

The following parameters and calculations were applied.

	Temperature	Permittivity	Conductivity
<b>Nominal Body TSL parameters</b>	22.0 °C	53.3	1.52 mho/m
<b>Measured Body TSL parameters</b>	(22.0 $\pm$ 0.2) °C	53.0 $\pm$ 6 %	1.46 mho/m $\pm$ 6 %
<b>Body TSL temperature change during test</b>	< 0.5 °C	----	----

## SAR result with Body TSL

<b>SAR averaged over 1 cm<sup>3</sup> (1 g) of Body TSL</b>	Condition	
SAR measured	250 mW input power	9.55 W/kg
SAR for nominal Body TSL parameters	normalized to 1W	<b>39.1 W/kg <math>\pm</math> 17.0 % (k=2)</b>

<b>SAR averaged over 10 cm<sup>3</sup> (10 g) of Body TSL</b>	condition	
SAR measured	250 mW input power	5.10 W/kg
SAR for nominal Body TSL parameters	normalized to 1W	<b>20.7 W/kg <math>\pm</math> 16.5 % (k=2)</b>

## Appendix (Additional assessments outside the scope of SCS 0108)

### Antenna Parameters with Head TSL

Impedance, transformed to feed point	51.5 $\Omega$ + 3.5 j $\Omega$
Return Loss	- 28.6 dB

### Antenna Parameters with Body TSL

Impedance, transformed to feed point	46.1 $\Omega$ + 4.7 j $\Omega$
Return Loss	- 24.0 dB

### General Antenna Parameters and Design

Electrical Delay (one direction)	1.194 ns
----------------------------------	----------

After long term use with 100W radiated power, only a slight warming of the dipole near the feedpoint can be measured.

The dipole is made of standard semirigid coaxial cable. The center conductor of the feeding line is directly connected to the second arm of the dipole. The antenna is therefore short-circuited for DC-signals. On some of the dipoles, small end caps are added to the dipole arms in order to improve matching when loaded according to the position as explained in the "Measurement Conditions" paragraph. The SAR data are not affected by this change. The overall dipole length is still according to the Standard.

No excessive force must be applied to the dipole arms, because they might bend or the soldered connections near the feedpoint may be damaged.

### Additional EUT Data

Manufactured by	SPEAG
Manufactured on	December 16, 2003

# DASY5 Validation Report for Head TSL

Date: 09.11.2016

Test Laboratory: SPEAG, Zurich, Switzerland

**DUT: Dipole 1900 MHz; Type: D1900V2; Serial: D1900V2 - SN:5d043**

Communication System: UID 0 - CW; Frequency: 1900 MHz

Medium parameters used:  $f = 1900$  MHz;  $\sigma = 1.39$  S/m;  $\epsilon_r = 40.6$ ;  $\rho = 1000$  kg/m<sup>3</sup>

Phantom section: Flat Section

Measurement Standard: DASY5 (IEEE/IEC/ANSI C63.19-2011)

DASY52 Configuration:

- Probe: EX3DV4 - SN7349; ConvF(7.99, 7.99, 7.99); Calibrated: 15.06.2016;
- Sensor-Surface: 1.4mm (Mechanical Surface Detection)
- Electronics: DAE4 Sn601; Calibrated: 30.12.2015
- Phantom: Flat Phantom 5.0 (front); Type: QD000P50AA; Serial: 1001
- DASY52 52.8.8(1258); SEMCAD X 14.6.10(7331)

## Dipole Calibration for Head Tissue/Pin=250 mW, d=10mm/Zoom Scan (7x7x7)/Cube 0:

Measurement grid: dx=5mm, dy=5mm, dz=5mm

Reference Value = 108.3 V/m; Power Drift = -0.03 dB

Peak SAR (extrapolated) = 18.7 W/kg

**SAR(1 g) = 9.92 W/kg; SAR(10 g) = 5.19 W/kg**

Maximum value of SAR (measured) = 15.5 W/kg

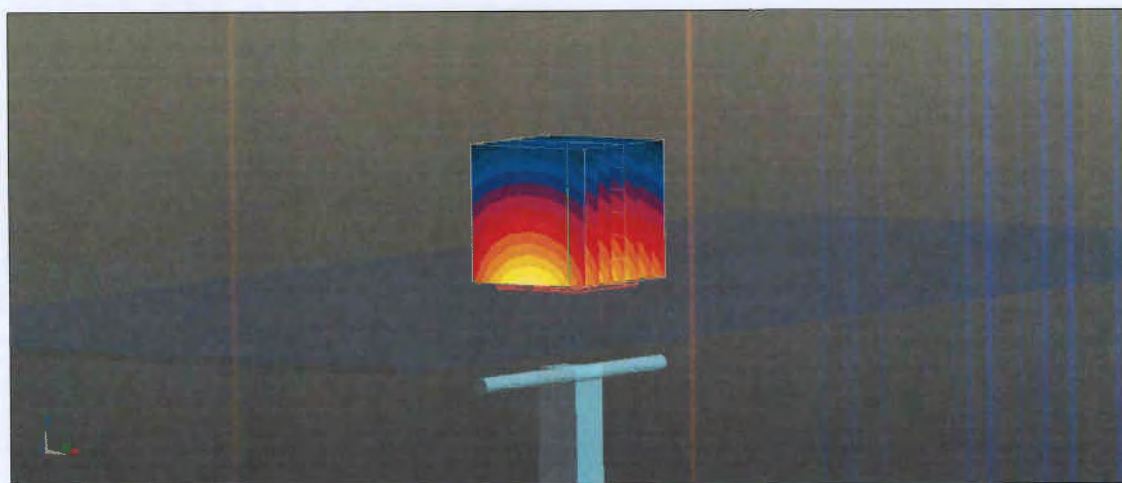
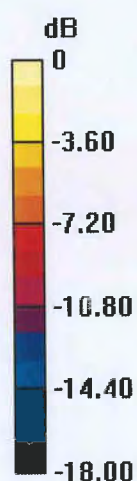

0 dB = 15.5 W/kg = 11.90 dBW/kg

# Impedance Measurement Plot for Head TSL

9 Nov 2016 14:50:10

CH1 S11 1 U FS 1: 51.520  $\Omega$  3.4727  $\Omega$  290.89  $\mu\text{H}$  1 900.000 000 MHz

\*  
De1  
CA

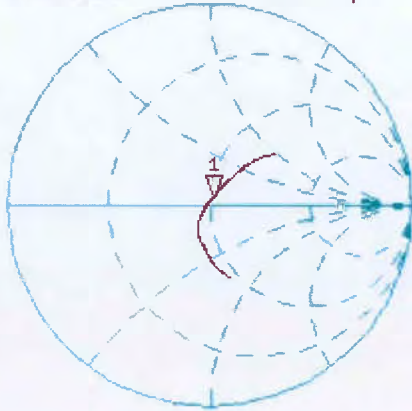

Avg  
16

H1d

CH2 S11 LOG 5 dB/REF -20 dB 1:-28.553 dB 1 900.000 000 MHz

CA

Avg  
16

H1d

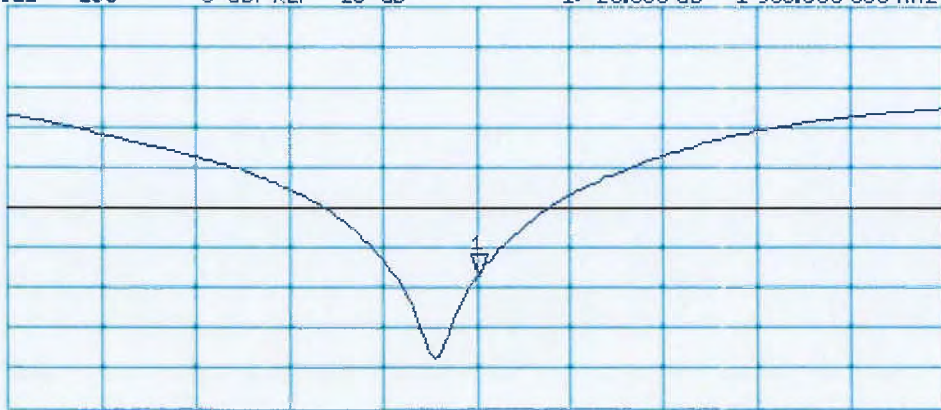

START 1 700.000 000 MHz

STOP 2 100.000 000 MHz



# DASY5 Validation Report for Body TSL

Date: 09.11.2016

Test Laboratory: SPEAG, Zurich, Switzerland

**DUT: Dipole 1900 MHz; Type: D1900V2; Serial: D1900V2 - SN:5d043**

Communication System: UID 0 - CW; Frequency: 1900 MHz

Medium parameters used:  $f = 1900$  MHz;  $\sigma = 1.46$  S/m;  $\epsilon_r = 53$ ;  $\rho = 1000$  kg/m<sup>3</sup>

Phantom section: Flat Section

Measurement Standard: DASY5 (IEEE/IEC/ANSI C63.19-2011)

DASY52 Configuration:

- Probe: EX3DV4 - SN7349; ConvF(8.03, 8.03, 8.03); Calibrated: 15.06.2016;
- Sensor-Surface: 1.4mm (Mechanical Surface Detection)
- Electronics: DAE4 Sn601; Calibrated: 30.12.2015
- Phantom: Flat Phantom 5.0 (back); Type: QD000P50AA; Serial: 1002
- DASY52 52.8.8(1258); SEMCAD X 14.6.10(7331)

**Dipole Calibration for Body Tissue/Pin=250 mW, d=10mm/Zoom Scan (7x7x7)/Cube 0:**

Measurement grid: dx=5mm, dy=5mm, dz=5mm

Reference Value = 103.7 V/m; Power Drift = -0.07 dB

Peak SAR (extrapolated) = 16.5 W/kg

**SAR(1 g) = 9.55 W/kg; SAR(10 g) = 5.1 W/kg**

Maximum value of SAR (measured) = 14.2 W/kg

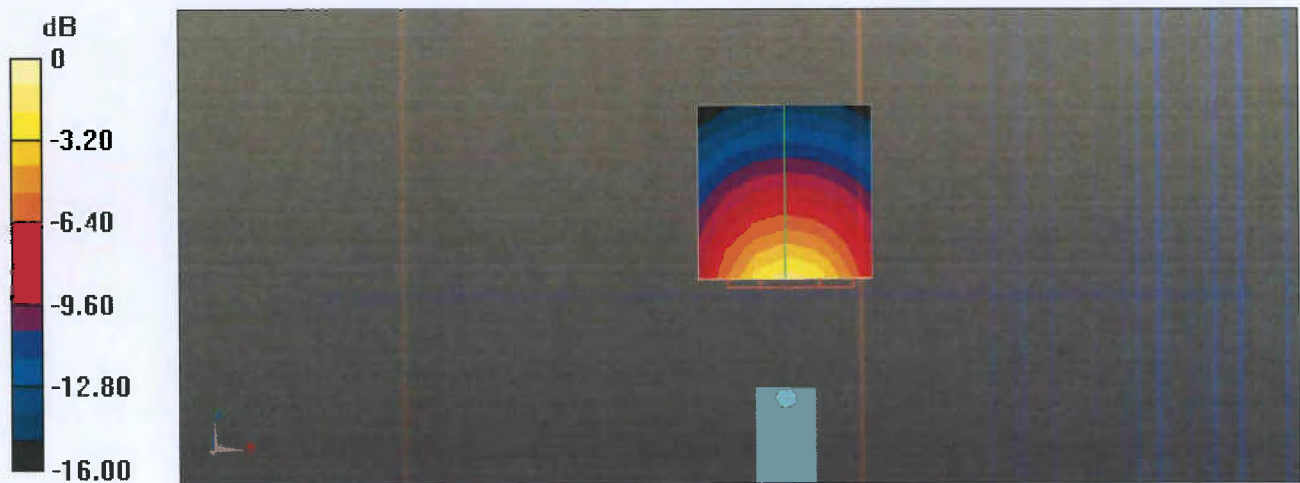

0 dB = 14.2 W/kg = 11.52 dBW/kg

# Impedance Measurement Plot for Body TSL

9 Nov 2016 14:49:12

CH1 S11 1 U FS 1: 46.148  $\Omega$  4.7324  $\Omega$  396.41 pF 1 900.000 000 MHz

\*  
De1  
CA

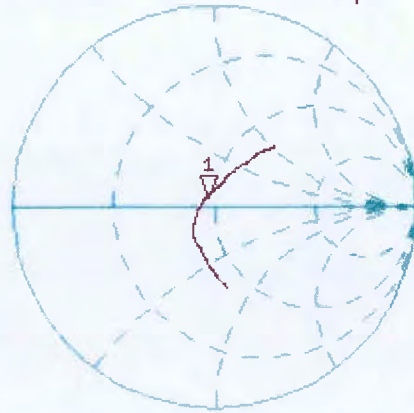

Avg  
16

H1d

CH2 S11 LOG 5 dB/REF -20 dB 1: -23.962 dB 1 900.000 000 MHz

CA

Avg  
16

H1d

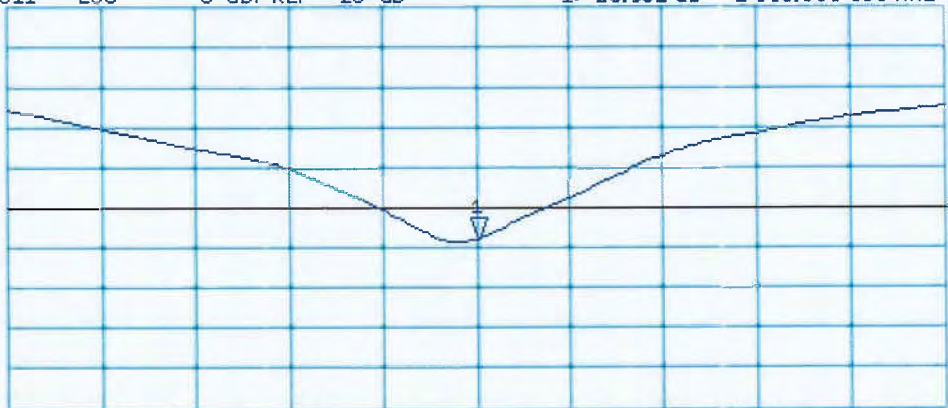

START 1 700.000 000 MHz

STOP 2 100.000 000 MHz