



# **CERTIFICATION TEST REPORT**

**Report Number. :** 11760905-E1V2

**Applicant :** SONY MOBILE COMMUNICATIONS INC.  
4-12-3 HIGASHI-SHINAGAWA,  
SHINAGAWA -KU,TOKYO, 140-0002, JAPAN

**FCC ID :** PY7-32042D

**EUT Description :** GSM/WCDMA/LTE Phone with BT, DTS/UNII a/b/g/n/ac, GPS & NFC

**Test Standard(s) :** FCC CFR47 PART 22 SUBPART H  
FCC CFR47 PART 24 SUBPART E  
FCC CFR47 PART 27 SUBPART F, H, L, and M  
FCC CFR47 PART 90 SUBPART S

**Date Of Issue:**

August 18, 2017

**Prepared by:**

UL Verification Services Inc.  
47173 Benicia Street  
Fremont, CA 94538, U.S.A.  
TEL: (510) 771-1000  
FAX: (510) 661-0888



NVLAP LAB CODE 200065-0

---

**Revision History**

<u>Rev.</u>	<u>Issue Date</u>	<u>Revisions</u>	<u>Revised By</u>
V1	08/16/17	Initial Issue	D. Corona
V2	08/18/17	Updated Section 6.3	D. Corona

**TABLE OF CONTENTS**

**1. ATTESTATION OF TEST RESULTS .....5**

**2. TEST METHODOLOGY ..... 6**

**3. FACILITIES AND ACCREDITATION .....6**

**4. CALIBRATION AND UNCERTAINTY ..... 6**

    4.1. *MEASURING INSTRUMENT CALIBRATION ..... 6*

    4.2. *SAMPLE CALCULATION..... 6*

    4.3. *MEASUREMENT UNCERTAINTY..... 7*

**5. EQUIPMENT UNDER TEST .....7**

    5.1. *DESCRIPTION OF EUT..... 7*

**6. MAXIMUM OUTPUT POWER .....8**

    6.1. *MAXIMUM OUTPUT POWER (GSM/EGPRS)..... 8*

    6.2. *MAXIMUM OUTPUT POWER (WCDMA)..... 9*

    6.3. *MAXIMUM OUTPUT POWER (LTE)..... 10*

**7. DESCRIPTION OF AVAILABLE ANTENNAS ..... 16**

**8. DESCRIPTION OF TEST SETUP ..... 17**

**9. TEST AND MEASUREMENT EQUIPMENT .....20**

**10. SUMMARY TABLE.....21**

**11. RF POWER OUTPUT VERIFICATION.....22**

    11.1. *GSM/GPRS/EDGE .....23*

    11.2. *GSM OUTPUT POWER RESULT .....24*

    11.3. *UMTS REL 99.....26*

    11.4. *UMTS REL 99 OUTPUT POWER RESULT .....27*

    11.5. *UMTS HSDPA .....28*

    11.6. *UMTS HSDPA OUTPUT POWER RESULT .....29*

    11.7. *UMTS HSUPA .....30*

    11.8. *UMTS HSUPA OUTPUT POWER RESULT .....31*

    11.9. *LTE OUTPUT POWER RESULT.....33*

**12. PEAK TO AVERAGE RATIO .....97**

    12.1. *CONDUCTED PEAK TO AVERAGE RESULT ..... 98*

**13. OCCUPIED BANDWIDTH ..... 115**

    13.1. *OCCUPIED BANDWIDTH RESULTS AND PLOTS ..... 116*

**15. BAND EDGE EMISSIONS..... 147**

---

15.1.	BAND EDGE PLOTS .....	148
15.2.	EMISSION MASK PLOTS .....	198
<b>16.</b>	<b>OUT OF BAND EMISSIONS .....</b>	<b>213</b>
16.1.	OUT OF BAND EMISSIONS RESULT AND PLOTS.....	214
<b>18.</b>	<b>FREQUENCY STABILITY .....</b>	<b>244</b>
18.1.	FREQUENCY STABILITY RESULTS.....	245
<b>19.</b>	<b>RADIATED TEST RESULTS.....</b>	<b>248</b>
19.1.	FIELD STRENGTH OF SPURIOUS RADIATION.....	248
19.1.1.	SPURIOUS RADIATION PLOTS.....	249
<b>20.</b>	<b>SETUP PHOTOS .....</b>	<b>268</b>

# 1. ATTESTATION OF TEST RESULTS

**COMPANY NAME:** SONY MOBILE COMMUNICATIONS, INC.  
4-12-3 HIGASHI-SHINAGAWA,  
SHINAGAWA –KU, TOKYO, 140-0002, JAPAN

**EUT DESCRIPTION:** GSM/WCDMA/LTE Phone with BT, DTS/UNII a/b/g/n/ac, GPS & NFC

**SERIAL NUMBER:** BH900014Q85, BH90003A85 (conducted)  
BH9000VP85, BH9000BL85 (radiated)

**DATE TESTED:** July 7 – August 9, 2017

APPLICABLE STANDARDS	
STANDARD	TEST RESULTS
FCC PART 22H, 24E, 27H, 27F, 27L, 27M, 90S	PASS

UL Verification Services Inc. tested the above equipment in accordance with the requirements set forth in the above standards. All indications of Pass/Fail in this report are opinions expressed by UL Verification Services Inc. based on interpretations and/or observations of test results. Measurement Uncertainties were not taken into account and are published for informational purposes only. The test results show that the equipment tested is capable of demonstrating compliance with the requirements as documented in this report.

Note: The results documented in this report apply only to the tested sample, under the conditions and modes of operation as described herein. This document may not be altered or revised in any way unless done so by UL Verification Services Inc. and all revisions are duly noted in the revisions section. Any alteration of this document not carried out by UL Verification Services Inc. will constitute fraud and shall nullify the document. This report must not be used by the client to claim product certification, approval, or endorsement by NVLAP, NIST, any agency of the Federal Government, or any agency of any government.

Approved & Released For  
UL Verification Services Inc. By:

Prepared By:



DAN CORONIA  
CONSUMER TECHNOLOGY DIVISION  
WISE PROJECT LEAD  
UL VERIFICATION SERVICES INC



KIYA KEDIDA  
CONSUMER TECHNOLOGY DIVISION  
WISE ENGINEER  
UL VERIFICATION SERVICES INC

## 2. TEST METHODOLOGY

The tests documented in this report were performed in accordance with TIA-603-D, FCC CFR 47 Part 2, FCC KDB 971168 D01 v02r02, Part 22, Part 24, Part 27 and Part 90.

## 3. FACILITIES AND ACCREDITATION

The test sites and measurement facilities used to collect data are located at 47173 and 47266 Benicia Street, Fremont, California, USA. Line conducted emissions are measured only at the 47173 address. The following table identifies which facilities were utilized for radiated emission measurements documented in this report. Specific facilities are also identified in the test results sections.

47173 Benicia Street	47266 Benicia Street
<input type="checkbox"/> Chamber A(IC: 2324B-1)	<input type="checkbox"/> Chamber D(IC: 22541-1)
<input checked="" type="checkbox"/> Chamber B(IC: 2324B-2)	<input type="checkbox"/> Chamber E(IC: 22541-2)
<input checked="" type="checkbox"/> Chamber C(IC: 2324B-3)	<input type="checkbox"/> Chamber F(IC: 22541-3)
	<input type="checkbox"/> Chamber G(IC: 22541-4)
	<input type="checkbox"/> Chamber H(IC: 22541-5)

The above test sites and facilities are covered under FCC Test Firm Registration # 208313. UL Verification Services Inc. is accredited by NVLAP, Laboratory Code 200065-0. Chambers A through C are covered under Industry Canada company address code 2324B with site numbers 2324B -1 through 2324B-3, respectively. Chambers D through H are covered under Industry Canada company address code 22541 with site numbers 22541 -1 through 22541-5, respectively.

## 4. CALIBRATION AND UNCERTAINTY

### 4.1. MEASURING INSTRUMENT CALIBRATION

The measuring equipment utilized to perform the tests documented in this report has been calibrated in accordance with the manufacturer's recommendations, and is traceable to recognized national standards

### 4.2. SAMPLE CALCULATION

Where relevant, the following sample calculation is provided:

EIRP = PSA reading with EUT worst orientation (dBm) + Path loss (dB) – cable loss( between the SG and substitution antenna) + Substitution Antenna Factor (dBi)

ERP = PSA reading with EUT worst orientation (dBm) + Path loss (dB) – cable loss( between the SG and substitution antenna)

(Path loss = Signal generator output – PSA reading with substitution antenna)

### 4.3. MEASUREMENT UNCERTAINTY

Where relevant, the following measurement uncertainty levels have been estimated for tests performed on the apparatus:

PARAMETER	UNCERTAINTY
Occupied Channel Bandwidth	±1.1 %
RF output power, conducted	±0.35 dB
Power Spectral Density, conducted	±0.39 dB
Unwanted Emissions, conducted	±2.9 dB
All emissions, radiated	±5.36 dB
Temperature	±0.9 °C
Humidity	±2.26% RH
Supply Voltages	±0.45 %
Time	±0.2 %

Uncertainty figures are valid to a confidence level of 95%.

## 5. EQUIPMENT UNDER TEST

### 5.1. DESCRIPTION OF EUT

This EUT is a GSM/WCDMA/LTE PHONE with BT, DTS/UNII a/b/g/n/ac, GPS & NFC.

## 6. MAXIMUM OUTPUT POWER

### 6.1. MAXIMUM OUTPUT POWER (GSM/EGPRS)

The transmitter has a maximum peak conducted and ERP / EIRP output powers as follows:

FCC Part 22/24						
Band	Frequency Range(MHz)	Modulation	Conducted (Average)		ERP/EIRP (Average)	
			AVG(dBm)	AVG(mW)	dBm	mW
850	824~849	GPRS	32.7	1862.09	27.8	602.56
	824~849	EGPRS	26.9	489.78	22.0	158.49
1900	1850~1910	GPRS	29.9	977.24	32.5	1778.28
	1850~1910	EGPRS	25.6	363.08	28.2	660.69



## 6.2. MAXIMUM OUTPUT POWER (WCDMA)

The transmitter has a maximum peak conducted and ERP / EIRP output powers as follows:

FCC Part 24						
Band	Frequency Range(MHz)	Modulation	Conducted (Average)		ERP/EIRP (Average)	
			AVG(dBm)	AVG(mW)	dBm	mW
Band 2	1850~1910	REL99	22.3	169.8	24.9	309.0
	1850~1910	HSDPA	21.4	138.0	24.0	251.2
	1850~1910	HSUPA	21.3	134.9	23.9	245.5

FCC Part 27						
Band	Frequency Range(MHz)	Modulation	Conducted (Average)		ERP/EIRP (Average)	
			AVG(dBm)	AVG(mW)	dBm	mW
Band 4	1710~1755	REL99	23.8	239.9	25.9	389.0
	1710~1755	HSDPA	22.8	190.5	24.9	309.0
	1710~1755	HSUPA	22.9	195.0	25.0	316.2

FCC Part 22						
Band	Frequency Range(MHz)	Modulation	Conducted (Average)		ERP/EIRP (Average)	
			AVG(dBm)	AVG(mW)	dBm	mW
Band 5	824~849	REL99	22.0	158.5	17.1	51.3
	824~849	HSDPA	21.1	128.8	16.2	41.7
	824~849	HSUPA	21.5	141.3	16.6	45.7

### 6.3. MAXIMUM OUTPUT POWER (LTE)

The transmitter has a maximum peak conducted and ERP/EIRP output powers as follows:

#### LTE Band 2

FCC Part 24							
Band	Frequency Range(MHz)	BandWidth (MHz)	Modulation	Conducted		Radiated	
				AVG(dBm)	AVG(mW)	AVG(dBm)	AVG(mW)
LTE2	1850~1910	1.4MHz	QPSK	22.6	182.0	25.2	331.1
			16QAM	22.8	190.5	25.4	346.7
		3MHz	QPSK	22.9	195.0	25.5	354.8
			16QAM	22.9	195.0	25.5	354.8
		5MHz	QPSK	23.0	199.5	25.6	363.1
			16QAM	23.0	199.5	25.6	363.1
		10MHz	QPSK	22.9	195.0	25.5	354.8
			16QAM	22.9	195.0	25.5	354.8
		15MHz	QPSK	23.0	199.5	25.6	363.1
			16QAM	23.3	213.8	25.9	389.0
		20MHz	QPSK	23.0	199.5	25.6	363.1
			16QAM	23.4	218.78	26.00	398.11

**LTE Band 7**

FCC Part 27							
Band	Frequency Range(MHz)	BandWidth (MHz)	Modulation	Conducted (Average)		EIRP (Average)	
				AVG(dBm)	AVG(mW)	dBm	mW
LTE7	2500~2570	5MHz	QPSK	22.0	158.5	21.5	141.3
			16QAM	22.0	158.5	21.5	141.3
		10MHz	QPSK	20.4	110.2	19.9	98.2
			16QAM	20.9	123.6	20.4	110.2
		15MHz	QPSK	20.4	110.7	19.9	98.6
			16QAM	20.9	123.6	20.4	110.2
		20MHz	QPSK	20.6	114.8	20.1	102.3
			16QAM	21.0	124.5	20.5	110.9

**LTE Band 12**

FCC Part 27							
Band	Frequency Range(MHz)	BandWidth (MHz)	Modulation	Conducted (Average)		ERP (Average)	
				AVG(dBm)	AVG(mW)	dBm	mW
LTE12	699~716	1.4MHz	QPSK	24.4	277.3	19.6	91.8
			16QAM	23.7	234.4	18.9	77.6
		3MHz	QPSK	24.5	283.1	19.7	93.8
			16QAM	23.8	238.2	19.0	78.9
		5MHz	QPSK	24.6	286.4	19.8	94.8
			16QAM	24.0	248.3	19.2	82.2
		10MHz	QPSK	24.4	276.7	19.6	91.6
			16QAM	23.8	237.7	19.0	78.7

**LTE Band 13**

FCC Part 27							
Band	Frequency Range(MHz)	BandWidth (MHz)	Modulation	Conducted (Average)		ERP (Average)	
				AVG(dBm)	AVG(mW)	dBm	mW
LTE13	777~787	5MHz	QPSK	23.6	229.6	19.9	97.9
			16QAM	22.7	184.1	19.0	78.5
		10MHz	QPSK	23.5	223.4	19.8	95.3
			16QAM	22.5	176.2	18.8	75.2

**LTE Band 25**

FCC Part 24							
Band	Frequency Range(MHz)	BandWidth (MHz)	Modulation	Conducted (Average)		ERIP (Average)	
				AVG(dBm)	AVG(mW)	dBm	mW
LTE25	1850~1915	1.4MHz	QPSK	22.4	173.4	25.0	315.5
			16QAM	22.7	187.1	25.3	340.4
		3MHz	QPSK	22.3	170.6	24.9	310.5
			16QAM	22.7	184.1	25.3	335.0
		5MHz	QPSK	22.0	160.0	24.6	291.1
			16QAM	22.4	175.0	25.0	318.4
		10MHz	QPSK	22.4	171.8	25.0	312.6
			16QAM	22.7	184.9	25.3	336.5
		15MHz	QPSK	22.3	168.3	24.9	306.2
			16QAM	22.7	185.4	25.3	337.3
		20MHz	QPSK	22.5	177.0	25.1	322.1
			16QAM	23.0	197.2	25.6	358.9

**LTE Band 26 Part 90**

FCC Part 90							
Band	Frequency Range(MHz)	BandWidth (MHz)	Modulation	Conducted (Average)		ERP (Average)	
				AVG(dBm)	AVG(mW)	dBm	mW
LTE26	814~824	1.4MHz	QPSK	22.7	187.5	18.3	68.1
			16QAM	23.0	199.5	18.6	72.4
		3MHz	QPSK	22.7	186.6	18.3	67.8
			16QAM	23.0	199.5	18.6	72.4
		5MHz	QPSK	22.8	190.1	18.4	69.0
			16QAM	22.9	195.0	18.5	70.8
		10MHz	QPSK	22.7	187.9	18.3	68.2
			16QAM	22.9	195.9	18.5	71.1

**LTE Band 26 PART 22**

FCC Part 22							
Band	Frequency Range(MHz)	BandWidth (MHz)	Modulation	Conducted (Average)		ERP (Average)	
				AVG(dBm)	AVG(mW)	dBm	mW
LTE26	824~849	1.4MHz	QPSK	22.7	187.5	18.3	68.1
			16QAM	23.0	199.5	18.6	72.4
		3MHz	QPSK	22.7	186.6	18.3	67.8
			16QAM	23.0	199.5	18.6	72.4
		5MHz	QPSK	22.8	190.1	18.4	69.0
			16QAM	22.9	195.0	18.5	70.8
		10MHz	QPSK	22.7	187.9	18.3	68.2
			16QAM	22.9	195.9	18.5	71.1
		15MHz	QPSK	22.5	177.8	18.1	64.6
			16QAM	22.5	178.6	18.1	64.9

**LTE Band 41**

FCC Part 27							
Band	Frequency Range(MHz)	BandWidth (MHz)	Modulation	Conducted (Average)		EIRP (Average)	
				AVG(dBm)	AVG(mW)	dBm	mW
LTE41	2496~2690	5MHz	QPSK	20.4	109.1	20.7	116.9
			16QAM	20.5	110.9	20.8	118.9
		10MHz	QPSK	20.7	116.4	21.0	124.7
			16QAM	20.7	116.1	21.0	124.5
		15MHz	QPSK	20.5	113.0	20.8	121.1
			16QAM	20.5	111.9	20.8	119.9
		20MHz	QPSK	20.8	119.7	21.1	128.2
			16QAM	20.9	122.2	21.2	130.9

**LTE Band 66**

FCC Part 24							
Band	Frequency Range(MHz)	BandWidth (MHz)	Modulation	Conducted (Average)		ERIP (Average)	
				AVG(dBm)	AVG(mW)	dBm	mW
LTE66	1710~1780	1.4MHz	QPSK	24.2	261.2	26.3	423.6
			16QAM	23.4	219.3	25.5	355.6
		3MHz	QPSK	24.3	267.9	26.4	434.5
			16QAM	23.4	219.3	25.5	355.6
		5MHz	QPSK	24.4	276.1	26.5	447.7
			16QAM	23.5	222.8	25.6	361.4
		10MHz	QPSK	24.4	278.0	26.5	450.8
			16QAM	23.5	224.9	25.6	364.8
		15MHz	QPSK	24.5	282.5	26.6	458.1
			16QAM	23.8	238.8	25.9	387.3
		20MHz	QPSK	24.3	269.8	26.4	437.5
			16QAM	23.9	244.9	26.0	397.2

## 7. DESCRIPTION OF AVAILABLE ANTENNAS

The radio utilizes a PIFA antenna for the [List the bands supported] with a maximum peak gain as follow:

Frequency (MHz)	Peak Gain (dBi)
GSM850, 824~849MHz	-2.4
GSM1900, 1850~1910MHz	2.6
WCDMA Band 2, 1850~1910MHz	2.6
WCDMA Band 4, 1710~1755MHz	2.1
WCDMA Band 5, 824~849	-2.4
LTE Band 2, 1850~1910MHz	2.6
LTE Band 4, 1710~1755MHz	2.1
LTE Band 5, 824~849MHz	-2.4
LTE Band 7, 2500~2570MHz	-0.5
LTE Band 12, 699~716MHz	-2.3
LTE Band 13, 777~787MHz	-1.2
LTE Band 17, 704~716MHz	-2.3
LTE Band 25, 1850~1915MHz	2.6
LTE Band 26, 814~849MHz	-1.9
LTE Band 38, 2570~2620MHz	-0.3
LTE Band 41, 2496~2690MHz	0.3
LTE Band 66, 1710~1780MHz	2.1



## 8. DESCRIPTION OF TEST SETUP

### SUPPORT EQUIPMENT

Support Equipment List				
Description	Manufacturer	Model	Serial Number	FCC ID
AC Adapter	SONY	UCH 20129.9713.1	3416W45305756	NA
Earphone	SONY	N/A	N/A	N/A

### I/O CABLES (CONDUCTED SETUP)

I/O Cable List						
Cable No	Port	# of Identical ports	Connector Type	Serial Type	Cable Length (m)	Remarks
1	RF Out	1	Spectrum Analyzer	Shielded	None	NA
2	Antenna Port	1	EUT	Shielded	0.1m	NA
3	RF In/Out	1	Communication Test Set	Shielded	1m	NA

### I/O CABLES (RADIATED SETUP)

I/O Cable List						
Cable No	Port	# of Identical ports	Connector Type	Serial Type	Cable Length (m)	Remarks
1	USB	1	AC Adapter	Un-shielded	1.2m	No
2	Jack	1	Headset	Shielded	1m	No
3	RF In/out	1	Communication Test Set	Un-shielded	2m	Yes

### TEST SETUP

The EUT is continuously communicated to the call box during the tests.

**SETUP DIAGRAM FOR TESTS (CONDUCTED TEST SETUP)**

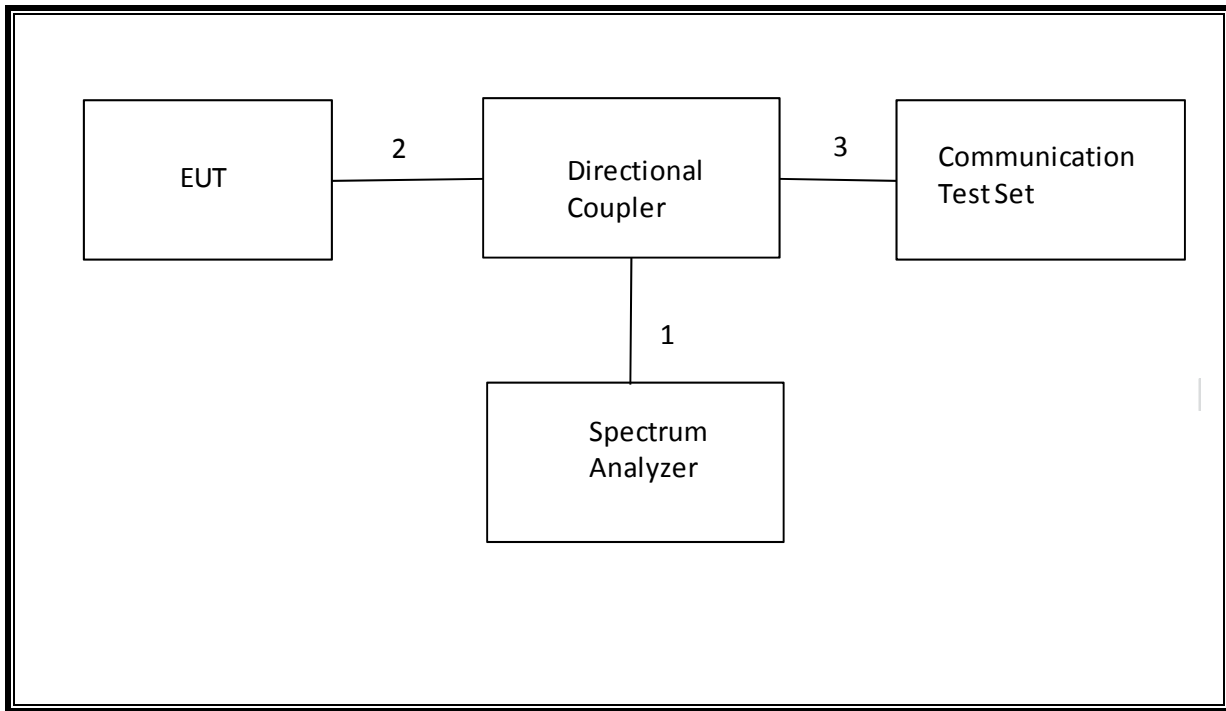

**SETUP DIAGRAM FOR TESTS (RADIATED TEST SETUP)**

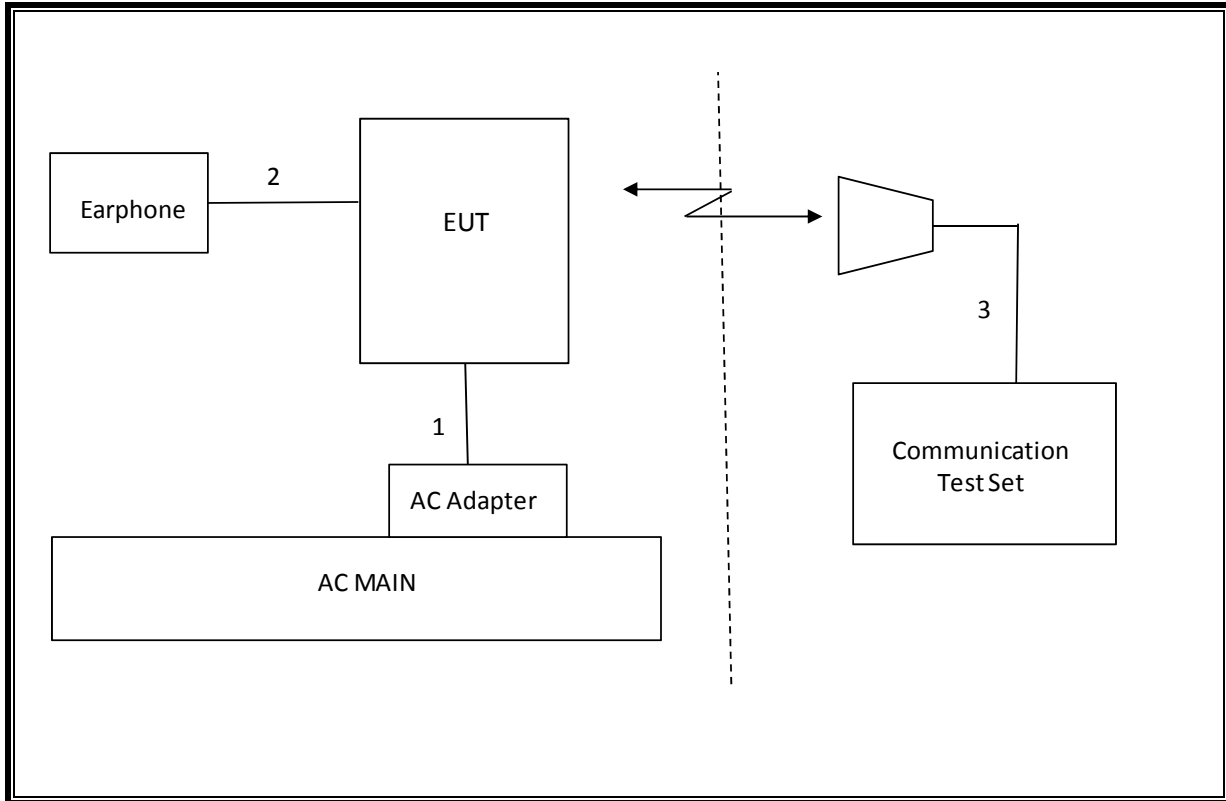

## 9. TEST AND MEASUREMENT EQUIPMENT

The following test and measurement equipment was utilized for the tests documented in this report:

Test Equipment List					
Description	Manufacturer	Model	T Number	Cal Date	Cal Due
Amplifier, 1 to 18 GHz	Miteq	AFS43-00101800-25-S-42	493	02/15/17	02/15/18
Amplifier, 1 to 8 GHz	Miteq	AMF-4D-01000800-30-29P	1156	02/15/17	02/15/18
Amplifier, 10KHz to 1GHz, 32dB	Keysight	8447D	10	02/15/17	02/15/18
Antenna, Broadband Hybrid, 30MHz to 2000MHz	Sunol Sciences	JB3	408	11/10/16	11/10/17
Horn Antenna	ETS-Lindgren	3117	T712	1/30/2017	1/30/2018
Spectrum Analyzer, PXA 3Hz to 44GHz	Keysight	N9030A	907	01/23/17	01/23/18
Highpass Filter, 2.7 GHz	Micro-Circuits	H2G518G6	T772	7/5/16	07/5/18
Highpass Filter, 1 GHz	Micro-Tronics	HPM18129	T889	2/21/17	02/21/18
Highpass Filter, 4GHz	Micro-Tronics	HPM13351	T1241	7/19/17	07/19/18
Wideband Radio Communication Tester	Rohde & Schwarz	CMW500	T956	None	None
PXA, Signal Analyzer	Agilent Technologies	N9030A	T1931	06/06/17	06/06/18
DC power supply, 8 V @ 3 A or 15 V @ 2 A	Agilent / HP	E3610A	None	CNR	None
Antenna, Tuned Dipole 400~1000 MHz	ETS	3121C DB4	T273	6/08/17	6/08/18
Directional Coupler	Mini-Circuits	ZUDC10-183+	T1136	6/18/17	6/18/18

Test Equipment List			
Description	Manufacturer	Model	T Number
Radiated Software	UL	UL EMC	Ver 9.5, June 24, 2015
Conducted Software	UL	UL EMC	Ver 9.5, May 26, 2015
CLT Software	UL	UL RF	Ver 1.0, Feb 2, 2015
Antenna Port Software	UL	UL RF	Ver 3.7, Nov 12, 2015

## 10. SUMMARY TABLE

FCC Part Section	Test Description	Test Limit	Test Condition	Test Result
2.1049	Occupied Bandwidth (99%)	N/A	Conducted	Pass
22.917(a) 24.238(a) 27.53(g) 90.691	Band Edge / Conducted Spurious Emission	-13dBm		Pass
27.53(m)		-25dBm		
2.1046		Conducted output power		N/A
27.53(m) 90.691	Emission Mask	Please refer to limit under section 14		Pass
22.355 90.213	Frequency Stability	2.5PPM		Pass
24.235 27.54		Please refer to limit under section 16		Pass
22.913(a)(2) 27.50©(10) 90.635	Effective Radiated Power	38dBm		Pass
		34.77dBm		Pass
	Equivalent Isotropic Radiated Power	50dBm		Pass
		36.98dBm	Pass	
		40.6dBm		
24.232(c ) 27.50(h)(2)		33dBm	Pass	
27.50(d)(4)		30dBm	Pass	
22.917(a) 24.238(a) 27.53(g) 90.691	Radiated Spurious Emission	-13dBm	Pass	
27.53(m)		-25dBm	Pass	

## 11. RF POWER OUTPUT VERIFICATION

### TEST PROCEDURE

ANSI C63.26:2015/ TIA / EIA 603-D Clause 2.2.17  
KDB 971168 Section 5.6

$$\text{ERP/EIRP} = \text{PMeas} + \text{GT} - \text{LC}$$

where: ERP/EIRP = effective or equivalent radiated power, respectively (expressed in the same units as PMeas, typically dBW or dBm);

PMeas = measured transmitter output power or PSD, in dBm or dBW;

GT = gain of the transmitting antenna, in dBd (ERP) or dBi (EIRP);

LC = signal attenuation in the connecting cable between the transmitter and antenna, in dB.

For devices utilizing multiple antennas, KDB 662911 provides guidance for determining the effective array transmit antenna gain term to be used in the above equation.

### MODES TESTED

- GSM 850
- GSM 1900
- WCDMA Band 2
- WCDMA Band 4
- WCDMA Band 5
- LTE Band 2
- LTE Band 7
- LTE Band 12
- LTE Band 13
- LTE Band 25
- LTE Band 26
- LTE Band 41
- LTE Band 66

## 11.1. GSM/GPRS/EDGE

Using CMW500 Communication Test Set

Function: Menu select > GSM Mobile Station > GSM 850/900/1800/1900

Press Connection control to choose the different menus

Press RESET > choose all to reset all settings

**Connection** Press Signal Off to turn off the signal and change settings  
Network Support > GSM+GPRS or GSM+EGPRS  
Main Service > Packet Data  
Service selection > Test Mode A – Auto Slot Config. off

**MS Signal** Press Slot Config bottom on the right twice to select and change the number of time slots and power setting  
> Slot configuration > Uplink/Gamma  
> 33 dBm for GPRS 850/900  
> 27 dBm for EGPRS 850/900  
> 30 dBm for GPRS1800/1900  
> 26 dBm for EGPRS1800/1900

**BS Signal** Enter the same channel number for TCH channel (test channel) and BCCH channel

Frequency Offset > + 0 Hz  
Mode > BCCH and TCH  
BCCH Level > -85 dBm (May need to adjust if link is not stable)  
BCCH Channel > choose desire test channel [Enter the same channel number for TCH channel (test channel) and BCCH channel]  
Channel Type > Off  
P0> 4 dB  
Slot Config > Unchanged (if already set under MS Signal)  
TCH > choose desired test channel  
Hopping > Off  
Main Timeslot > 3 (Default)

**Network** Coding Scheme > CS 4 (GPRS) and MCS5-9 (EGPRS)  
Bit Stream > 2E9-1PSR Bit Pattern

**AF/RF** Enter appropriate offsets for Ext. Att. Output and Ext. Att. Input

**Connection** Press Signal On to turn on the signal and change settings

## 11.2. GSM OUTPUT POWER RESULT

Tested By	Tony Soares
Date	7/10/2017

### GSM 850

Antenna gain (dBi)		-2.40					
Mode	Ch.	f (MHz)	Modulation	Conducted Average (dBm)	ERP Average (dBm)	ERP Limit (dBm)	Margin (dB)
GPRS	128	824.2	1 Time slot	32.60	27.70	38.5	-10.80
	190	836.6		32.70	27.80	38.5	-10.70
	251	848.8		32.60	27.70	38.5	-10.80
	128	824.2	2 Time slot	29.60	24.70	38.5	-13.80
	190	836.6		29.60	24.70	38.5	-13.80
	251	848.8		29.50	24.60	38.5	-13.90
	128	824.2	3 Time slot	27.80	22.90	38.5	-15.60
	190	836.6		27.90	23.00	38.5	-15.50
	251	848.8		27.80	22.90	38.5	-15.60
	128	824.2	4 Time slot	26.50	21.60	38.5	-16.90
	190	836.6		26.60	21.70	38.5	-16.80
	251	848.8		26.60	21.70	38.5	-16.80
EGPRS	128	824.2	1 Time slot	26.80	21.90	38.5	-16.60
	190	836.6		26.90	22.00	38.5	-16.50
	251	848.8		26.80	21.90	38.5	-16.60
	128	824.2	2 Time slot	25.50	20.60	38.5	-17.90
	190	836.6		25.60	20.70	38.5	-17.80
	251	848.8		25.50	20.60	38.5	-17.90
	128	824.2	3 Time slot	23.90	19.00	38.5	-19.50
	190	836.6		23.90	19.00	38.5	-19.50
	251	848.8		23.90	19.00	38.5	-19.50
	128	824.2	4 Time slot	23.30	18.40	38.5	-20.10
	190	836.6		23.40	18.50	38.5	-20.00
	251	848.8		23.40	18.50	38.5	-20.00



**GSM 1900**

Antenna gain (dBi)		2.60					
Mode	Ch.	f (MHz)	Modulation	Conducted Average (dBm)	ERP Average (dBm)	ERP Limit (dBm)	Margin (dB)
GPRS	512	1850.2	1 Time slot	29.90	32.50	33.0	-0.50
	661	1880		29.90	32.50	33.0	-0.50
	810	1909.8		29.80	32.40	33.0	-0.60
	512	1850.2	2 Time slot	28.40	31.00	33.0	-2.00
	661	1880		28.30	30.90	33.0	-2.10
	810	1909.8		28.50	31.10	33.0	-1.90
	512	1850.2	3 Time slot	26.40	29.00	33.0	-4.00
	661	1880		26.40	29.00	33.0	-4.00
	810	1909.8		26.50	29.10	33.0	-3.90
	512	1850.2	4 Time slot	25.40	28.00	33.0	-5.00
	661	1880		25.50	28.10	33.0	-4.90
	810	1909.8		25.60	28.20	33.0	-4.80
EGPRS	512	1850.2	1 Time slot	25.60	28.20	33.0	-4.80
	661	1880		25.50	28.10	33.0	-4.90
	810	1909.8		25.60	28.20	33.0	-4.80
	512	1850.2	2 Time slot	25.20	27.80	33.0	-5.20
	661	1880		25.10	27.70	33.0	-5.30
	810	1909.8		25.30	27.90	33.0	-5.10
	512	1850.2	3 Time slot	22.80	25.40	33.0	-7.60
	661	1880		22.70	25.30	33.0	-7.70
	810	1909.8		22.80	25.40	33.0	-7.60
	512	1850.2	4 Time slot	21.60	24.20	33.0	-8.80
	661	1880		21.50	24.10	33.0	-8.90
	810	1909.8		21.80	24.40	33.0	-8.60

### 11.3. UMTS REL 99

#### TEST PROCEDURE

##### **Release 99 Setup Procedures used to establish the test signals**

The following tests were completed according to the test requirements outlined in section 5.2 of the 3GPP TS34.121-1 specification. The DUT supports power Class 3, which has a nominal maximum output power of 24 dBm (+1.7/-3.7).

The following summary of these settings are illustrated below:

Mode	Subtest	Rel99
WCDMA General Settings	Loopback Mode	Test Mode 2
	Rel99 RMC	12.2kbps RMC
	Power Control Algorithm	Algorithm2
	$\beta_c/\beta_d$	8/15

#### RESULTS

Tested By	Tony Soares
Date	7/11/2017

### 11.4. UMTS REL 99 OUTPUT POWER RESULT

Antenna gain Band 5 (dBi)	-2.40
Antenna gain Bnad 2 (dBi)	2.60
Antenna gain Band 4 (dBi)	2.10

**Part 22 / RSS 132 850MHz Band (5)**

Band	UL Channel	DL Channel	Frequency (MHz)	Conducted Average (dBm)	ERP Average (dBm)	ERP Limit (dBm)	Margin (dB)
UMTS Rel. 99 850MHz	4132	4357	826.4	22.0	17.1	38.5	-21.4
	4183	4408	836.6	21.9	17.0	38.5	-21.5
	4233	4458	846.6	21.6	16.7	38.5	-21.8

**Part 24 / RSS 133 1900MHz Band (2)**

Band	UL Channel	DL Channel	Frequency (MHz)	Peak Power (dBm)	EIRP Average (dBm)	EIRP Limit (dBm)	Margin (dB)
UMTS Rel. 99 1900MHz	9262	9662	1852.4	22.2	24.8	33.0	-8.2
	9400	9800	1880.0	22.2	24.8	33.0	-8.2
	9538	9938	1907.6	22.3	24.9	33.0	-8.1

**Part 27 / RSS 139 1700MHz Band (4)**

Band	UL Channel	DL Channel	Frequency (MHz)	Peak Power (dBm)	EIRP Average (dBm)	EIRP Limit (dBm)	Margin (dB)
UMTS Rel. 99 1700MHz	1312	1537	1712.4	23.8	25.9	30.0	-4.1
	1413	1638	1732.6	23.6	25.7	30.0	-4.3
	1513	1738	1752.6	23.7	25.8	30.0	-4.2

## 11.5. UMTS HSDPA

### HSDPA Setup Procedures used to establish the test signals

The following 4 Sub-tests were completed according to Release 5 procedures in section 5.2 of 3GPP TS34.121. Summary of settings are illustrated below:

	Mode	HSDPA	HSDPA	HSDPA	HSDPA
	Subtest	1	2	3	4
W-CDMA General Settings	Loopback Mode	Test Mode 1			
	Rel99 RMC	12.2kbps RMC			
	HSDPA FRC	H-Set 1			
	Power Control Algorithm	Algorithm 2			
	$\beta_c$	2/15	11/15	15/15	15/15
	$\beta_d$	15/15	15/15	8/15	4/15
	Bd (SF)	64			
	$\beta_c/\beta_d$	2/15	11/15	15/8	15/4
	$\beta_{hs}$	4/15	24/15	30/15	30/15
MPR (dB)	0	0	0.5	0.5	
HSDPA Specific Settings	$D_{ACK}$	8			
	$D_{NAK}$	8			
	DCQI	8			
	Ack-Nack repetition factor	3			
	CQI Feedback (Table 5.2B.4)	4ms			
	CQI Repetition Factor (Table 5.2B.4)	2			
	$A_{hs}=\beta_{hs}/\beta_c$	30/15			

### RESULTS

Tested By	Tony Soares
Date	7/11/2017

## 11.6. UMTS HSDPA OUTPUT POWER RESULT

Antenna gain Band 5 (dBi)	-2.40
Antenna gain Bnad 2 (dBi)	2.60
Antenna gain Band 4 (dBi)	2.10

### Part 22 / RSS 132 850MHz Band (5)

Band	Subtest	UL Channel	DL Channel	Frequency (MHz)	Conducted Average (dBm)	ERP Average (dBm)	ERP Limit (dBm)	Margin (dB)
UMTS HSDPA 850MHz	1	4132	4357	826.4	21.0	16.1	38.5	-17.5
		4183	4408	836.6	20.8	15.9	38.5	-17.7
		4233	4458	846.6	20.6	15.7	38.5	-17.9
	2	4132	4357	826.4	21.1	16.2	38.5	-17.4
		4183	4408	836.6	21.0	16.1	38.5	-17.5
		4233	4458	846.6	20.6	15.7	38.5	-17.9
	3	4132	4357	826.4	20.6	15.7	38.5	-17.9
		4183	4408	836.6	20.4	15.5	38.5	-18.1
		4233	4458	846.6	20.2	15.3	38.5	-18.3
	4	4132	4357	826.4	20.6	15.7	38.5	-17.9
		4183	4408	836.6	20.4	15.5	38.5	-18.1
		4233	4458	846.6	20.2	15.3	38.5	-18.3

### Part 24 / RSS 133 1900MHz Band (2)

Band	Subtest	UL Channel	DL Channel	Frequency (MHz)	Conducted Average (dBm)	EIRP Average (dBm)	EIRP Limit (dBm)	Margin (dB)
UMTS HSDPA 1900MHz	1	9262	9662	1852.4	21.2	23.8	33.0	-11.8
		9400	9800	1880.0	21.2	23.8	33.0	-11.8
		9538	9938	1907.6	21.4	24.0	33.0	-11.6
	2	9262	9662	1852.4	21.2	23.8	33.0	-11.8
		9400	9800	1880.0	21.2	23.8	33.0	-11.8
		9538	9938	1907.6	21.4	24.0	33.0	-11.6
	3	9262	9662	1852.4	20.6	23.2	33.0	-12.4
		9400	9800	1880.0	20.8	23.4	33.0	-12.2
		9538	9938	1907.6	20.9	23.5	33.0	-12.1
	4	9262	9662	1852.4	20.8	23.4	33.0	-12.2
		9400	9800	1880.0	20.7	23.3	33.0	-12.3
		9538	9938	1907.6	20.9	23.5	33.0	-12.1

### Part 27 / RSS 139 1700MHz Band (4)

Band	Subtest	UL Channel	DL Channel	Frequency (MHz)	Conducted Average (dBm)	EIRP Average (dBm)	EIRP Limit (dBm)	Margin (dB)
UMTS HSDPA 1700MHz	1	1312	1537	1712.4	22.7	24.8	30.0	-7.3
		1413	1638	1732.6	22.6	24.7	30.0	-7.4
		1513	1738	1752.6	22.8	24.9	30.0	-7.3
	2	1312	1537	1712.4	22.8	24.9	30.0	-7.2
		1413	1638	1732.6	22.4	24.5	30.0	-7.6
		1513	1738	1752.6	22.6	24.7	30.0	-7.4
	3	1312	1537	1712.4	22.4	24.5	30.0	-7.6
		1413	1638	1732.6	22.4	24.5	30.0	-7.6
		1513	1738	1752.6	22.5	24.6	30.0	-7.5
	4	1312	1537	1712.4	22.4	24.5	30.0	-7.6
		1413	1638	1732.6	22.4	24.5	30.0	-7.6
		1513	1738	1752.6	22.5	24.6	30.0	-7.5

## 11.7. UMTS HSUPA

The following 5 Sub-tests were completed according to Release 6 procedures in Table C.11.1.3 of 3GPP TS 34.121-1 v13

Summary of settings are illustrated below:

	Mode	HSPA				
	Subtest	1	2	3	4	5
WCDMA General Settings	Loopback Mode	Test Mode 1				
	Rel99 RMC	12.2 kbps RMC				
	HSDPA FRC	H-Set 1				
	HSUPA Test	HSPA				
	Power Control Algorithm	Algorithm 2				Algorithm 1
	$\beta_c$	11/15	6/15	15/15	2/15	15/15
	$\beta_d$	15/15	15/15	9/15	15/15	0
	$\beta_{ec}$	209/225	12/15	30/15	2/15	5/15
	$\beta_c/\beta_d$	11/15	6/15	15/9	2/15	-
	$\beta_{hs}$	22/15	12/15	30/15	4/15	5/15
$\beta_{ed}$	1309/225	94/75	47/15	56/75	47/15	
CM (dB)	1	3	2	3	1	
MPR (dB)	0	2	1	2	0	
HSDPA Specific Settings	DACK	8				0
	DNAK	8				0
	DCQI	8				0
	Ack-Nack repetition factor	3				
	CQI Feedback (Table 5.2B.4)	4ms				
	CQI Repetition Factor (Table 5.2B.4)	2				
	A <sub>hs</sub> = $\beta_{hs}/\beta_c$	30/15				
HSUPA Specific Settings	E-DPDCCH	6	8	8	5	0
	DHARQ	0	0	0	0	0
	AG Index	20	12	15	17	12
	ETFCI (from 34.121 Table C.11.1.3)	75	67	92	71	67
	Associated Max UL Data Rate kbps	242.1	174.9	482.8	205.8	308.9
	Reference E-TFCIs	5	5	2	5	1
	Reference E-TFCI	11	11	11	11	67
	Reference E-TFCI PO	4	4	4	4	18
	Reference E-TFCI	67	67	92	67	67
	Reference E-TFCI PO	18	18	18	18	18
	Reference E-TFCI	71	71	71	71	71
	Reference E-TFCI PO	23	23	23	23	23
	Reference E-TFCI	75	75	75	75	75
	Reference E-TFCI PO	26	26	26	26	26
	Reference E-TFCI	81	81	81	81	81
Reference E-TFCI PO	27	27	27	27	27	
Maximum Channelization Codes	2xSF2				SF4	

### RESULT

Tested By	Tony Soares
Date	7/11/2017

### 11.8. UMTS HSUPA OUTPUT POWER RESULT

Antenna gain Band 5 (dBi)	-2.40
Antenna gain Bnad 2 (dBi)	2.60

**Part 22 / RSS 132 850MHz Band (5)**

Band	Subtest	UL Channel	DL Channel	Frequency (MHz)	Conducted Average (dBm)	ERP Average (dBm)	ERP Limit (dBm)	Margin (dB)
UMTS HSUPA 850MHz	1	4132	4357	826.4	21.5	16.6	38.5	-17.0
		4183	4408	836.6	21.5	16.6	38.5	-17.0
		4233	4458	846.6	21.4	19.0	38.5	-17.1
	2	4132	4357	826.4	19.5	14.6	38.5	-19.0
		4183	4408	836.6	20.0	15.1	38.5	-18.5
		4233	4458	846.6	19.7	14.8	38.5	-18.8
	3	4132	4357	826.4	21.0	16.1	38.5	-17.5
		4183	4408	836.6	20.2	15.3	38.5	-18.3
		4233	4458	846.6	20.5	15.6	38.5	-18.0
	4	4132	4357	826.4	19.5	14.6	38.5	-19.0
		4183	4408	836.6	20.0	15.1	38.5	-18.5
		4233	4458	846.6	19.7	14.8	38.5	-18.8
	5	4132	4357	826.4	21.5	16.6	38.5	-17.0
		4183	4408	836.6	21.5	16.6	38.5	-17.0
		4233	4458	846.6	21.4	16.5	38.5	-17.1

**Part 24 / RSS 133 1900MHz Band (2)**

Band	Subtest	UL Channel	DL Channel	Frequency (MHz)	Conducted Average (dBm)	EIRP Average (dBm)	EIRP Limit (dBm)	Margin (dB)
UMTS HSUPA 1900MHz	1	9262	9662	1852.4	21.0	23.6	33.0	-12.0
		9400	9800	1880.0	21.2	23.8	33.0	-11.8
		9538	9938	1907.6	21.3	23.9	33.0	-11.7
	2	9262	9662	1852.4	19.3	21.9	33.0	-13.7
		9400	9800	1880.0	19.2	21.8	33.0	-13.8
		9538	9938	1907.6	19.2	21.8	33.0	-13.8
	3	9262	9662	1852.4	20.2	22.8	33.0	-12.8
		9400	9800	1880.0	20.2	22.8	33.0	-12.8
		9538	9938	1907.6	20.3	22.9	33.0	-12.7
	4	9262	9662	1852.4	19.3	21.9	33.0	-13.7
		9400	9800	1880.0	19.2	21.8	33.0	-13.8
		9538	9938	1907.6	19.2	21.8	33.0	-13.8
	5	9262	9662	1852.4	21.0	23.6	33.0	-12.0
		9400	9800	1880.0	21.2	23.8	33.0	-11.8
		9538	9938	1907.6	21.3	23.9	33.0	-11.7

Antenna gain Band 4 (dBi)	2.10
---------------------------	------

**Part 27 / RSS 139 1700MHz Band (4)**

Band	Subtest	UL Channel	DL Channel	Frequency (MHz)	Conducted Average (dBm)	EIRP Average (dBm)	EIRP Limit (dBm)	Margin (dB)
UMTS HSUPA 1700MHz	1	1312	1537	1712.4	22.9	25.0	30.0	-7.1
		1413	1638	1732.6	22.7	24.8	30.0	-7.4
		1513	1738	1752.6	22.8	24.9	30.0	-7.2
	2	1312	1537	1712.4	20.9	23.0	30.0	-9.1
		1413	1638	1732.6	20.6	22.7	30.0	-9.4
		1513	1738	1752.6	20.8	22.9	30.0	-9.2
	3	1312	1537	1712.4	22.0	24.1	30.0	-8.0
		1413	1638	1732.6	21.7	23.8	30.0	-8.3
		1513	1738	1752.6	21.7	23.8	30.0	-8.3
	4	1312	1537	1712.4	20.9	23.0	30.0	-9.1
		1413	1638	1732.6	20.6	22.7	30.0	-9.4
		1513	1738	1752.6	20.8	22.9	30.0	-9.2
	5	1312	1537	1712.4	22.9	25.0	30.0	-7.1
		1413	1638	1732.6	22.7	24.8	30.0	-7.4
		1513	1738	1752.6	22.8	24.9	30.0	-7.2



## 11.9. LTE OUTPUT POWER RESULT

**Note(s):**

**LTE Band 4 Measured Results**

LTE Band 4 (Frequency range: 1710-1755MHz) is covered by LTE Band 66 (Frequency range: 1710-1780 MHz) and no testing is necessary due to overlapping frequency range, same maximum tune-up limit and same channel bandwidth and same modulations.

**LTE Band 5 Measured Results**

LTE Band 5 (Frequency range: 824-849 MHz) is covered by LTE Band 26 (Frequency range: 814-849 MHz) due to similar frequency range, same maximum tune-up limit and same channel bandwidth.

**LTE Band 17 Measured Results**

LTE Band 17 (Frequency range: 704-716) is covered by LTE Band 12 (Frequency range: 699-716MHz) no testing is necessary due to overlapping frequency range, same maximum tune-up limit and same channel bandwidth and same modulations.

**LTE Band 38 Measured Results**

LTE Band 38 (Frequency range: 2570-2620 MHz) is covered by LTE Band 41 (Frequency range: 2496-2690 MHz) and no testing is necessary due to overlapping frequency range, same maximum tune-up limit and same channel bandwidth and same modulations.

**64QAM Measured Results**

Measured QPSK, 16QAM & 64QAM Mode Output power and found that QPSK and 16QAM results was the worst case. All testing were performed using QPSK and 16QAM mode to represent the worst case mode.

Tested By	Vanessa Moestopo
Date	07/10/2017-07/15/2017

**LTE Band 2**

Antenna gain (dBi)		2.60										
Bandwidth	UL Channel	Frequency (MHz)	Modulation	RB Size	RB Offset	Conducted Average (dBm)	EIRP Average (dBm)	EIRP Limit (dBm)	Margin (dB)			
1.4	18607	1850.7	QPSK	1	0	22.2	24.8	33.0	-8.2			
				1	3	22.3	24.9	33.0	-8.1			
				1	5	22.3	24.9	33.0	-8.1			
				3	0	22.3	24.9	33.0	-8.1			
				3	1	22.4	25.0	33.0	-8.0			
				3	3	22.4	25.0	33.0	-8.0			
			16QAM	6	0	22.3	24.9	33.0	-8.1			
				1	0	22.4	25.0	33.0	-8.0			
				1	3	22.4	25.0	33.0	-8.0			
				1	5	22.4	25.0	33.0	-8.0			
				3	0	22.5	25.1	33.0	-7.9			
				3	1	22.6	25.2	33.0	-7.8			
			64QAM	3	3	22.6	25.2	33.0	-7.8			
				6	0	22.2	24.8	33.0	-8.2			
				1	0	21.9	24.5	33.0	-8.5			
				1	3	21.9	24.5	33.0	-8.5			
				1	5	21.9	24.5	33.0	-8.5			
				3	0	22.0	24.6	33.0	-8.4			
			1.4	18900	1880.0	QPSK	3	1	21.8	24.4	33.0	-8.6
							3	3	21.7	24.3	33.0	-8.7
							6	0	20.6	23.2	33.0	-9.8
							1	0	22.2	24.8	33.0	-8.2
							1	3	22.3	24.9	33.0	-8.1
							1	5	22.2	24.8	33.0	-8.2
16QAM	3	0				22.2	24.8	33.0	-8.2			
	3	3				22.2	24.8	33.0	-8.2			
	6	0				22.2	24.8	33.0	-8.2			
	1	0				22.6	25.2	33.0	-7.8			
	1	3				22.6	25.2	33.0	-7.8			
	1	5				22.6	25.2	33.0	-7.8			
64QAM	3	0				22.4	25.0	33.0	-8.0			
	3	1				22.4	25.0	33.0	-8.0			
	3	3				22.4	25.0	33.0	-8.0			
	6	0				21.8	24.4	33.0	-8.7			
	1	0				21.7	24.3	33.0	-8.7			
	1	3				21.8	24.4	33.0	-8.6			
64QAM	1	5				21.7	24.3	33.0	-8.7			
	3	0				21.7	24.3	33.0	-8.7			
	3	1				21.7	24.3	33.0	-8.7			
	3	3				21.7	24.3	33.0	-8.7			
	6	0				20.6	23.2	33.0	-9.8			
	6	0				20.6	23.2	33.0	-9.8			

Antenna gain (dBi)		2.60							
Bandwidth	UL Channel	Frequency (MHz)	Modulation	RB Size	RB Offset	Conducted Average (dBm)	EIRP Average (dBm)	EIRP Limit (dBm)	Margin (dB)
1.4	19193	1919.3	QPSK	1	0	22.6	25.2	33.0	-7.8
				1	3	22.6	25.2	33.0	-7.8
				1	5	22.5	25.1	33.0	-7.9
				3	0	22.6	25.2	33.0	-7.9
				3	1	22.6	25.2	33.0	-7.8
				3	3	22.6	25.2	33.0	-7.8
			16QAM	6	0	22.6	25.2	33.0	-7.8
				1	0	22.7	25.3	33.0	-7.7
				1	3	22.8	25.4	33.0	-7.7
				1	5	22.7	25.3	33.0	-7.7
				3	0	22.6	25.2	33.0	-7.8
				3	1	22.7	25.3	33.0	-7.7
			64QAM	3	3	22.7	25.3	33.0	-7.7
				6	0	22.3	24.9	33.0	-8.1
				1	0	22.4	25.0	33.0	-8.0
				1	3	22.4	25.0	33.0	-8.0
				1	5	22.5	25.1	33.0	-7.9
				3	0	22.2	24.8	33.0	-8.2
				3	1	22.2	24.8	33.0	-8.2
				3	3	22.2	24.8	33.0	-8.2
				6	0	21.1	23.7	33.0	-9.3

Antenna gain (dBi)		2.60							
Bandwidth	UL Channel	Frequency (MHz)	Modulation	RB Size	RB Offset	Conducted Average (dBm)	EIRP Average (dBm)	EIRP Limit (dBm)	Margin (dB)
3.0	18615	1851.5	QPSK	1	0	22.5	25.1	33.0	-7.9
				1	8	22.6	25.2	33.0	-7.8
				1	14	22.4	25.0	33.0	-8.0
				8	0	22.5	25.1	33.0	-7.9
				8	4	22.5	25.1	33.0	-7.9
				8	7	22.5	25.1	33.0	-7.9
			16QAM	15	0	22.4	25.0	33.0	-8.0
				1	0	22.9	25.5	33.0	-7.6
				1	8	23.0	25.6	33.0	-7.5
				1	14	22.8	25.4	33.0	-7.6
				8	0	22.2	24.8	33.0	-8.2
				8	4	22.2	24.8	33.0	-8.2
			64QAM	8	7	22.2	24.8	33.0	-8.2
				15	0	22.1	24.7	33.0	-8.3
				1	0	22.0	24.6	33.0	-8.4
				1	8	21.9	24.5	33.0	-8.5
				1	14	21.9	24.5	33.0	-8.5
				8	0	20.7	23.3	33.0	-9.7
3.0	18900	1880.0	QPSK	8	4	20.7	23.3	33.0	-9.7
				8	7	20.7	23.3	33.0	-9.7
				8	7	20.7	23.3	33.0	-9.7
				15	0	20.6	23.2	33.0	-9.8
				1	0	22.4	25.0	33.0	-8.0
				1	8	22.4	25.0	33.0	-8.0
			16QAM	1	14	22.4	25.0	33.0	-8.0
				8	0	22.4	25.0	33.0	-8.0
				8	4	22.4	25.0	33.0	-8.0
				8	7	22.4	25.0	33.0	-8.0
				15	0	22.4	25.0	33.0	-8.0
				1	0	22.3	24.9	33.0	-8.1
			64QAM	1	8	22.4	25.0	33.0	-8.0
				1	14	22.4	25.0	33.0	-8.0
				8	0	22.1	24.7	33.0	-8.3
				8	4	22.1	24.7	33.0	-8.3
				8	7	22.1	24.7	33.0	-8.3
				15	0	22.0	24.6	33.0	-8.4
64QAM	1	0	21.8	24.4	33.0	-8.6			
	1	8	21.8	24.4	33.0	-8.6			
	1	14	21.8	24.4	33.0	-8.6			
	8	0	20.6	23.2	33.0	-9.8			
	8	4	20.6	23.2	33.0	-9.8			
	8	7	20.6	23.2	33.0	-9.8			
15	0	20.6	23.2	33.0	-9.8				

Antenna gain (dBi)		2.60							
Bandwidth	UL Channel	Frequency (MHz)	Modulation	RB Size	RB Offset	Conducted Average (dBm)	EIRP Average (dBm)	EIRP Limit (dBm)	Margin (dB)
3.0	19185	1908.5	QPSK	1	0	22.8	25.4	33.0	-7.6
				1	8	22.9	25.5	33.0	-7.5
				1	14	22.7	25.3	33.0	-7.7
				8	0	22.8	25.4	33.0	-7.6
				8	4	22.8	25.4	33.0	-7.6
				8	7	22.8	25.4	33.0	-7.6
			16QAM	15	0	22.8	25.4	33.0	-7.6
				1	0	22.9	25.5	33.0	-7.5
				1	8	23.0	25.6	33.0	-7.5
				1	14	22.8	25.4	33.0	-7.6
				8	0	22.4	25.0	33.0	-8.0
				8	4	22.5	25.1	33.0	-7.9
			64QAM	8	7	22.5	25.1	33.0	-7.9
				15	0	22.4	25.0	33.0	-8.0
				1	0	22.2	24.8	33.0	-8.2
				1	8	22.2	24.8	33.0	-8.2
				1	14	22.1	24.7	33.0	-8.3
				8	0	21.1	23.7	33.0	-9.3
				8	4	21.2	23.8	33.0	-9.2
				8	7	21.1	23.7	33.0	-9.3
				15	0	21.1	23.7	33.0	-9.3

Antenna gain (dBi)		2.60										
Bandwidth	UL Channel	Frequency (MHz)	Modulation	RB Size	RB Offset	Conducted Average (dBm)	EIRP Average (dBm)	EIRP Limit (dBm)	Margin (dB)			
5.0	18625	1852.5	QPSK	1	0	22.6	25.2	33.0	-7.9			
				1	12	22.4	25.0	33.0	-8.0			
				1	24	22.4	25.0	33.0	-8.0			
				12	0	22.5	25.1	33.0	-7.9			
				12	7	22.5	25.1	33.0	-7.9			
				12	13	22.5	25.1	33.0	-7.9			
			16QAM	25	0	22.5	25.1	33.0	-7.9			
				1	0	23.0	25.6	33.0	-7.4			
				1	12	23.0	25.6	33.0	-7.4			
				1	24	23.0	25.6	33.0	-7.4			
				12	0	22.3	24.9	33.0	-8.1			
				12	7	22.3	24.9	33.0	-8.1			
			64QAM	12	13	22.2	24.8	33.0	-8.2			
				25	0	22.2	24.8	33.0	-8.2			
				1	0	21.9	24.5	33.0	-8.5			
				1	12	21.9	24.5	33.0	-8.5			
				1	24	21.9	24.5	33.0	-8.5			
				12	0	20.7	23.3	33.0	-9.7			
			5.0	18900	1880.0	QPSK	12	7	20.7	23.3	33.0	-9.7
							12	13	20.7	23.3	33.0	-9.7
							25	0	20.7	23.3	33.0	-9.7
1	0	22.6					25.2	33.0	-7.8			
1	12	22.4					25.0	33.0	-8.0			
1	24	22.6					25.2	33.0	-7.8			
16QAM	12	0				22.4	25.0	33.0	-8.0			
	12	7				22.4	25.0	33.0	-8.0			
	12	13				22.4	25.0	33.0	-8.0			
	25	0				22.4	25.0	33.0	-8.0			
	1	0				22.8	25.4	33.0	-7.6			
	1	2				22.6	25.2	33.0	-7.9			
64QAM	1	5				22.7	25.3	33.0	-7.7			
	3	0				22.1	24.7	33.0	-8.3			
	3	1				22.1	24.7	33.0	-8.3			
	3	2				22.1	24.7	33.0	-8.3			
	6	0				22.1	24.7	33.0	-8.3			
	1	0				22.0	24.6	33.0	-8.4			
64QAM	1	12				21.9	24.5	33.0	-8.5			
	1	24				22.0	24.6	33.0	-8.4			
	12	0				20.6	23.2	33.0	-9.8			
	12	7	20.7	23.3	33.0	-9.7						
	12	13	20.7	23.3	33.0	-9.7						
	25	0	20.6	23.2	33.0	-9.8						

Antenna gain (dBi)		2.60							
Bandwidth	UL Channel	Frequency (MHz)	Modulation	RB Size	RB Offset	Conducted Average (dBm)	EIRP Average (dBm)	EIRP Limit (dBm)	Margin (dB)
5.0	19175	1907.5	QPSK	1	0	23.0	25.6	33.0	-7.4
				1	12	22.9	25.5	33.0	-7.5
				1	24	22.9	25.5	33.0	-7.5
				12	0	22.9	25.5	33.0	-7.5
				12	7	22.8	25.4	33.0	-7.6
				12	13	22.9	25.5	33.0	-7.6
				25	0	22.8	25.4	33.0	-7.6
			16QAM	1	0	23.0	25.6	33.0	-7.4
				1	12	22.9	25.5	33.0	-7.5
				1	24	22.9	25.5	33.0	-7.5
				12	0	22.5	25.1	33.0	-7.9
				12	7	22.5	25.1	33.0	-7.9
				12	13	22.5	25.1	33.0	-7.9
				25	0	22.4	25.0	33.0	-8.0
			64QAM	1	0	22.4	25.0	33.0	-8.0
				1	12	22.4	25.0	33.0	-8.0
				1	24	22.4	25.0	33.0	-8.0
				12	0	21.2	23.8	33.0	-9.2
				12	7	21.2	23.8	33.0	-9.2
				12	13	21.2	23.8	33.0	-9.2
				25	0	21.2	23.8	33.0	-9.2

Antenna gain (dBi)		2.60							
Bandwidth	UL Channel	Frequency (MHz)	Modulation	RB Size	RB Offset	Conducted Average (dBm)	EIRP Average (dBm)	EIRP Limit (dBm)	Margin (dB)
10.0	18650	1855.0	QPSK	1	0	22.8	25.4	33.0	-7.6
				1	25	22.5	25.1	33.0	-7.9
				1	49	22.6	25.2	33.0	-7.8
				25	0	22.5	25.1	33.0	-7.9
				25	12	22.5	25.1	33.0	-7.9
				25	25	22.4	25.0	33.0	-8.0
			16QAM	50	0	22.5	25.1	33.0	-7.9
				1	0	23.1	25.7	33.0	-7.3
				1	25	22.8	25.4	33.0	-7.6
				1	49	23.0	25.6	33.0	-7.4
				25	0	22.2	24.8	33.0	-8.2
				25	12	22.1	24.7	33.0	-8.3
			64QAM	25	25	22.1	24.7	33.0	-8.3
				50	0	22.1	24.7	33.0	-8.3
				1	0	22.0	24.6	33.0	-8.4
				1	25	21.7	24.3	33.0	-8.7
				1	49	21.9	24.5	33.0	-8.5
				25	0	20.7	23.3	33.0	-9.7
10.0	18900	1880.0	QPSK	25	12	20.7	23.3	33.0	-9.7
				25	25	20.6	23.2	33.0	-9.8
				50	0	20.7	23.3	33.0	-9.7
				1	0	22.8	25.4	33.0	-7.7
				1	25	22.3	24.9	33.0	-8.1
				1	49	22.6	25.2	33.0	-7.8
			16QAM	25	0	22.6	25.2	33.0	-7.8
				25	12	22.4	25.0	33.0	-8.0
				25	25	22.5	25.1	33.0	-7.9
				50	0	22.5	25.1	33.0	-7.9
				1	0	22.7	25.3	33.0	-7.7
				1	25	22.3	24.9	33.0	-8.1
			64QAM	1	49	22.6	25.2	33.0	-7.8
				25	0	22.2	24.8	33.0	-8.2
				25	12	22.1	24.7	33.0	-8.3
				25	25	22.1	24.7	33.0	-8.3
				50	0	22.1	24.7	33.0	-8.3
				1	0	21.8	24.4	33.0	-8.6
64QAM	1	25	21.5	24.1	33.0	-8.9			
	1	49	21.8	24.4	33.0	-8.6			
	25	0	20.7	23.3	33.0	-9.7			
	25	12	20.7	23.3	33.0	-9.7			
	25	25	20.7	23.3	33.0	-9.7			
	50	0	20.7	23.3	33.0	-9.7			



Antenna gain (dBi)		2.60							
Bandwidth	UL Channel	Frequency (MHz)	Modulation	RB Size	RB Offset	Conducted Average (dBm)	EIRP Average (dBm)	EIRP Limit (dBm)	Margin (dB)
10.0	19150	1905.0	QPSK	1	0	22.8	25.4	33.0	-7.6
				1	25	22.8	25.4	33.0	-7.6
				1	49	22.7	25.3	33.0	-7.7
				25	0	22.9	25.5	33.0	-7.5
				25	12	22.9	25.5	33.0	-7.5
				25	25	22.8	25.4	33.0	-7.6
			16QAM	50	0	22.9	25.5	33.0	-7.5
				1	0	22.9	25.5	33.0	-7.6
				1	25	22.8	25.4	33.0	-7.6
				1	49	22.8	25.4	33.0	-7.6
				25	0	22.6	25.2	33.0	-7.8
				25	12	22.6	25.2	33.0	-7.8
			64QAM	25	25	22.5	25.1	33.0	-7.9
				50	0	22.5	25.1	33.0	-7.9
				1	0	22.0	24.6	33.0	-8.4
				1	25	21.9	24.5	33.0	-8.5
				1	49	22.0	24.6	33.0	-8.4
				25	0	21.2	23.8	33.0	-9.2
25	12	21.2	23.8	33.0	-9.2				
25	25	21.1	23.7	33.0	-9.3				
50	0	21.1	23.7	33.0	-9.3				

Antenna gain (dBi)		2.60							
Bandwidth	UL Channel	Frequency (MHz)	Modulation	RB Size	RB Offset	Conducted Average (dBm)	EIRP Average (dBm)	EIRP Limit (dBm)	Margin (dB)
15.0	18675	1857.5	QPSK	1	0	22.8	25.4	33.0	-7.6
				1	37	22.6	25.2	33.0	-7.8
				1	74	22.5	25.1	33.0	-7.9
				36	0	22.7	25.3	33.0	-7.7
				36	20	22.6	25.2	33.0	-7.8
				36	39	22.6	25.2	33.0	-7.9
				75	0	22.6	25.2	33.0	-7.8
			16QAM	1	0	23.2	25.8	33.0	-7.2
				1	37	22.9	25.5	33.0	-7.5
				1	74	22.9	25.5	33.0	-7.5
				36	0	22.4	25.0	33.0	-8.0
				36	20	22.3	24.9	33.0	-8.1
				36	39	22.2	24.8	33.0	-8.2
				75	0	22.3	24.9	33.0	-8.2
			64QAM	1	0	21.6	24.2	33.0	-8.8
				1	37	21.7	24.3	33.0	-8.7
				1	74	21.5	24.1	33.0	-8.9
				36	0	20.9	23.5	33.0	-9.5
				36	20	20.8	23.4	33.0	-9.6
				36	39	20.8	23.4	33.0	-9.6
				75	0	20.8	23.4	33.0	-9.6
15.0	18900	1880.0	QPSK	1	0	22.7	25.3	33.0	-7.7
				1	37	22.4	25.0	33.0	-8.1
				1	74	22.4	25.0	33.0	-8.0
				36	0	22.6	25.2	33.0	-7.8
				36	20	22.5	25.1	33.0	-7.9
				36	39	22.5	25.1	33.0	-7.9
				75	0	22.6	25.2	33.0	-7.9
			16QAM	1	0	22.6	25.2	33.0	-7.8
				1	37	22.3	24.9	33.0	-8.1
				1	74	22.4	25.0	33.0	-8.0
				36	0	22.3	24.9	33.0	-8.1
				36	20	22.2	24.8	33.0	-8.2
				36	39	22.2	24.8	33.0	-8.2
				75	0	22.2	24.8	33.0	-8.3
			64QAM	1	0	21.5	24.1	33.0	-8.9
				1	37	21.4	24.0	33.0	-9.0
				1	74	21.3	23.9	33.0	-9.1
				36	0	20.8	23.4	33.0	-9.6
				36	20	20.8	23.4	33.0	-9.6
				36	39	20.8	23.4	33.0	-9.6
				75	0	20.8	23.4	33.0	-9.6

Antenna gain (dBi)		2.60							
Bandwidth	UL Channel	Frequency (MHz)	Modulation	RB Size	RB Offset	Conducted Average (dBm)	EIRP Average (dBm)	EIRP Limit (dBm)	Margin (dB)
15.0	19125	1902.5	QPSK	1	0	23.0	25.6	33.0	-7.4
				1	37	22.9	25.5	33.0	-7.6
				1	74	22.8	25.4	33.0	-7.6
				36	0	22.9	25.5	33.0	-7.6
				36	20	22.9	25.5	33.0	-7.5
				36	39	22.8	25.4	33.0	-7.6
				75	0	22.9	25.5	33.0	-7.5
			16QAM	1	0	23.3	25.9	33.0	-7.1
				1	37	23.2	25.8	33.0	-7.2
				1	74	23.2	25.8	33.0	-7.2
				36	0	22.4	25.0	33.0	-8.0
				36	20	22.5	25.1	33.0	-7.9
				36	39	22.4	25.0	33.0	-8.0
				75	0	22.5	25.1	33.0	-7.9
			64QAM	1	0	21.8	24.4	33.0	-8.6
				1	37	21.7	24.3	33.0	-8.7
				1	74	21.7	24.3	33.0	-8.7
				36	0	21.2	23.8	33.0	-9.2
				36	20	21.2	23.8	33.0	-9.2
				36	39	21.2	23.8	33.0	-9.2
				75	0	21.2	23.8	33.0	-9.2

Antenna gain (dBi)		2.60								
Bandwidth	UL Channel	Frequency (MHz)	Modulation	RB Size	RB Offset	Conducted Average (dBm)	EIRP Average (dBm)	EIRP Limit (dBm)	Margin (dB)	
20.0	18700	1860.0	QPSK	1	0	22.9	25.5	33.0	-7.5	
				1	49	22.5	25.1	33.0	-7.9	
				1	99	22.5	25.1	33.0	-7.9	
				50	0	22.7	25.3	33.0	-7.7	
				50	24	22.6	25.2	33.0	-7.8	
				50	50	22.5	25.1	33.0	-7.9	
				100	0	22.6	25.2	33.0	-7.8	
			16QAM	1	0	23.4	26.0	33.0	-7.0	
				1	49	23.0	25.6	33.0	-7.4	
				1	99	22.9	25.5	33.0	-7.5	
				50	0	22.3	24.9	33.0	-8.1	
				50	24	22.2	24.8	33.0	-8.2	
				50	50	22.2	24.8	33.0	-8.2	
				100	0	22.2	24.8	33.0	-8.2	
			64QAM	1	0	22.2	24.8	33.0	-8.2	
				1	49	21.8	24.4	33.0	-8.6	
				1	99	21.9	24.5	33.0	-8.5	
				50	0	21.0	23.6	33.0	-9.4	
				50	24	21.0	23.6	33.0	-9.4	
				50	50	20.9	23.5	33.0	-9.5	
				100	0	20.8	23.4	33.0	-9.6	
20.0	18900	1880.0	QPSK	1	0	22.8	25.4	33.0	-7.6	
				1	49	22.4	25.0	33.0	-8.0	
				1	99	22.6	25.2	33.0	-7.8	
				50	0	22.7	25.3	33.0	-7.7	
				50	24	22.6	25.2	33.0	-7.8	
				50	50	22.5	25.1	33.0	-7.9	
				100	0	22.6	25.2	33.0	-7.8	
			16QAM	1	0	23.3	25.9	33.0	-7.1	
				1	49	22.9	25.5	33.0	-7.5	
				1	99	23.2	25.8	33.0	-7.2	
				50	0	22.3	24.9	33.0	-8.1	
				50	24	22.2	24.8	33.0	-8.2	
				50	50	22.1	24.7	33.0	-8.3	
				100	0	22.2	24.8	33.0	-8.2	
			64QAM	1	0	21.8	24.4	33.0	-8.6	
				1	49	21.9	24.5	33.0	-8.5	
				1	99	21.9	24.5	33.0	-8.5	
				50	0	21.0	23.6	33.0	-9.4	
				50	24	21.0	23.6	33.0	-9.4	
				50	50	20.8	23.4	33.0	-9.6	
				100	0	20.9	23.5	33.0	-9.5	

Antenna gain (dBi)		2.60							
Bandwidth	UL Channel	Frequency (MHz)	Modulation	RB Size	RB Offset	Conducted Average (dBm)	EIRP Average (dBm)	EIRP Limit (dBm)	Margin (dB)
20.0	19100	1900.0	QPSK	1	0	23.0	25.6	33.0	-7.4
				1	49	22.7	25.3	33.0	-7.7
				1	99	22.8	25.4	33.0	-7.6
				50	0	22.9	25.5	33.0	-7.5
				50	24	22.8	25.4	33.0	-7.6
				50	50	22.9	25.5	33.0	-7.6
				100	0	22.9	25.5	33.0	-7.6
			16QAM	1	0	23.4	26.0	33.0	-7.0
				1	49	23.1	25.7	33.0	-7.3
				1	99	23.2	25.8	33.0	-7.2
				50	0	22.6	25.2	33.0	-7.9
				50	24	22.5	25.1	33.0	-7.9
				50	50	22.5	25.1	33.0	-8.0
				100	0	22.5	25.1	33.0	-7.9
			64QAM	1	0	22.0	24.6	33.0	-8.4
				1	49	22.0	24.6	33.0	-8.4
				1	99	21.9	24.5	33.0	-8.5
				50	0	21.3	23.9	33.0	-9.1
				50	24	21.2	23.8	33.0	-9.2
				50	50	21.2	23.8	33.0	-9.2
				100	0	21.2	23.8	33.0	-9.2

**LTE Band 7**

Antenna gain (dBi)		-0.50							
Bandwidth	UL Channel	Frequency (MHz)	Modulation	RB Size	RB Offset	Conducted Average (dBm)	EIRP Average (dBm)	EIRP Limit (dBm)	Margin (dB)
5.0	20775	2052.5	QPSK	1	0	21.9	20.4	33.0	-12.6
				1	12	21.7	20.5	33.0	-12.5
				1	24	21.7	20.4	33.0	-12.6
				12	0	22.0	20.4	33.0	-12.6
				12	7	21.8	20.5	33.0	-12.5
				12	13	21.8	20.5	33.0	-12.5
				25	0	21.8	20.5	33.0	-12.5
			16QAM	1	0	21.6	20.5	33.0	-12.5
				1	12	21.5	20.6	33.0	-12.4
				1	24	21.5	20.6	33.0	-12.4
				12	0	21.5	20.5	33.0	-12.5
				12	7	21.4	20.6	33.0	-12.4
				12	13	21.4	20.5	33.0	-12.5
				25	0	21.4	20.4	33.0	-12.6
			64QAM	1	0	21.3	20.2	33.0	-12.8
				1	12	21.3	20.3	33.0	-12.7
				1	24	21.3	20.2	33.0	-12.8
				12	0	20.6	20.0	33.0	-13.0
				12	7	20.6	20.0	33.0	-13.0
				12	13	20.5	20.1	33.0	-12.9
				25	0	20.5	20.0	33.0	-13.0
5.0	21100	2535.0	QPSK	1	0	22.0	20.2	33.0	-12.8
				1	12	22.0	20.2	33.0	-12.8
				1	24	21.9	20.2	33.0	-12.8
				12	0	22.0	20.2	33.0	-12.8
				12	7	22.0	20.3	33.0	-12.7
				12	13	22.0	20.3	33.0	-12.7
				25	0	21.9	20.3	33.0	-12.7
			16QAM	1	0	21.9	20.9	33.0	-12.1
				1	2	22.0	20.8	33.0	-12.2
				1	5	21.9	20.8	33.0	-12.2
				3	0	21.7	20.6	33.0	-12.4
				3	1	21.7	20.5	33.0	-12.5
				3	2	21.6	20.5	33.0	-12.5
				6	0	21.5	20.3	33.0	-12.7
			64QAM	1	0	21.2	20.0	33.0	-13.0
				1	12	21.2	20.0	33.0	-13.0
				1	24	21.2	20.0	33.0	-13.0
				12	0	20.6	19.9	33.0	-13.1
				12	7	20.6	19.9	33.0	-13.1
				12	13	20.5	19.9	33.0	-13.1
				25	0	20.5	19.9	33.0	-13.1

Antenna gain (dBi)		-0.50							
Bandwidth	UL Channel	Frequency (MHz)	Modulation	RB Size	RB Offset	Conducted Average (dBm)	EIRP Average (dBm)	EIRP Limit (dBm)	Margin (dB)
5.0	21425	2567.5	QPSK	1	0	20.4	19.9	33.0	-13.1
				1	12	20.3	19.8	33.0	-13.2
				1	24	20.2	19.7	33.0	-13.3
				12	0	20.3	19.8	33.0	-13.2
				12	7	20.3	19.8	33.0	-13.2
				12	13	20.3	19.8	33.0	-13.2
				25	0	20.3	19.8	33.0	-13.2
			16QAM	1	0	20.5	20.0	33.0	-13.0
				1	12	20.4	19.9	33.0	-13.1
				1	24	20.4	19.9	33.0	-13.1
				12	0	20.5	20.0	33.0	-13.0
				12	7	20.4	19.9	33.0	-13.1
				12	13	20.4	19.9	33.0	-13.1
				25	0	20.4	19.9	33.0	-13.1
			64QAM	1	0	20.1	19.6	33.0	-13.4
				1	12	20.1	19.6	33.0	-13.4
				1	24	20.0	19.5	33.0	-13.5
				12	0	20.0	19.5	33.0	-13.5
				12	7	20.1	19.6	33.0	-13.4
				12	13	20.0	19.5	33.0	-13.5
				25	0	20.0	19.5	33.0	-13.5

Antenna gain (dBi)		-0.50							
Bandwidth	UL Channel	Frequency (MHz)	Modulation	RB Size	RB Offset	Conducted Average (dBm)	EIRP Average (dBm)	EIRP Limit (dBm)	Margin (dB)
10.0	20880	2505.0	QPSK	1	0	20.3	19.8	33.0	-13.2
				1	25	20.3	19.8	33.0	-13.2
				1	49	20.2	19.7	33.0	-13.3
				25	0	20.4	19.9	33.0	-13.1
				25	12	20.4	19.9	33.0	-13.1
				25	25	20.3	19.8	33.0	-13.2
			50	0	20.4	19.9	33.0	-13.1	
			16QAM	1	0	20.3	19.8	33.0	-13.2
				1	25	20.3	19.8	33.0	-13.2
				1	49	20.3	19.8	33.0	-13.2
				25	0	20.5	20.0	33.0	-13.0
				25	12	20.5	20.0	33.0	-13.0
				25	25	20.5	20.0	33.0	-13.0
			64QAM	50	0	20.3	19.8	33.0	-13.2
				1	0	20.0	19.5	33.0	-13.5
				1	25	19.9	19.4	33.0	-13.6
				1	49	19.9	19.4	33.0	-13.6
				25	0	19.9	19.4	33.0	-13.6
25	12	19.9		19.4	33.0	-13.6			
10.0	21100	2535.0	QPSK	25	25	19.9	19.4	33.0	-13.6
				50	0	19.9	19.4	33.0	-13.6
				1	0	20.3	19.8	33.0	-13.2
				1	25	20.2	19.7	33.0	-13.3
				1	49	20.1	19.6	33.0	-13.4
				25	0	20.2	19.7	33.0	-13.3
			16QAM	25	12	20.2	19.7	33.0	-13.3
				25	25	20.1	19.6	33.0	-13.4
				50	0	20.2	19.7	33.0	-13.3
				1	0	20.9	20.4	33.0	-12.6
				1	25	20.8	20.3	33.0	-12.7
				1	49	20.7	20.2	33.0	-12.8
			64QAM	25	0	20.5	20.0	33.0	-13.0
				25	12	20.5	20.0	33.0	-13.0
				25	25	20.5	20.0	33.0	-13.1
				50	0	20.5	20.0	33.0	-13.0
				1	0	20.2	19.7	33.0	-13.3
				1	25	20.2	19.7	33.0	-13.3
64QAM	1	49	20.1	19.6	33.0	-13.4			
	25	0	20.0	19.5	33.0	-13.5			
	25	12	20.0	19.5	33.0	-13.5			
	25	25	19.9	19.4	33.0	-13.6			
	50	0	19.8	19.3	33.0	-13.7			



Antenna gain (dBi)		-0.50							
Bandwidth	UL Channel	Frequency (MHz)	Modulation	RB Size	RB Offset	Conducted Average (dBm)	EIRP Average (dBm)	EIRP Limit (dBm)	Margin (dB)
10.0	21400	2565.0	QPSK	1	0	20.1	19.6	33.0	-13.4
				1	25	20.1	19.6	33.0	-13.4
				1	49	20.1	19.6	33.0	-13.4
				25	0	20.1	19.6	33.0	-13.4
				25	12	20.2	19.7	33.0	-13.3
				25	25	20.2	19.7	33.0	-13.4
				50	0	20.2	19.7	33.0	-13.3
			16QAM	1	0	20.1	19.6	33.0	-13.4
				1	25	20.1	19.6	33.0	-13.4
				1	49	20.1	19.6	33.0	-13.4
				25	0	20.2	19.7	33.0	-13.3
				25	12	20.3	19.8	33.0	-13.2
				25	25	20.2	19.7	33.0	-13.3
				50	0	20.3	19.8	33.0	-13.2
			64QAM	1	0	20.4	19.9	33.0	-13.1
				1	25	20.4	19.9	33.0	-13.1
				1	49	20.3	19.8	33.0	-13.2
				25	0	19.9	19.4	33.0	-13.6
				25	12	20.0	19.5	33.0	-13.5
				25	25	20.0	19.5	33.0	-13.5
				50	0	20.0	19.5	33.0	-13.5

Antenna gain (dBi)		-0.50							
Bandwidth	UL Channel	Frequency (MHz)	Modulation	RB Size	RB Offset	Conducted Average (dBm)	EIRP Average (dBm)	EIRP Limit (dBm)	Margin (dB)
15.0	20825	2507.5	QPSK	1	0	20.1	19.6	33.0	-13.4
				1	37	20.0	19.5	33.0	-13.5
				1	74	19.9	19.4	33.0	-13.6
				36	0	20.2	19.7	33.0	-13.4
				36	20	20.4	19.9	33.0	-13.1
				36	39	20.4	19.9	33.0	-13.1
				75	0	20.4	19.9	33.0	-13.1
			16QAM	1	0	20.9	20.4	33.0	-12.6
				1	37	20.7	20.2	33.0	-12.8
				1	74	20.7	20.2	33.0	-12.8
				36	0	20.5	20.0	33.0	-13.0
				36	20	20.5	20.0	33.0	-13.1
				36	39	20.4	19.9	33.0	-13.1
				75	0	20.5	20.0	33.0	-13.1
			64QAM	1	0	20.0	19.5	33.0	-13.5
				1	37	19.7	19.2	33.0	-13.8
				1	74	19.8	19.3	33.0	-13.7
				36	0	19.8	19.3	33.0	-13.7
				36	20	19.9	19.4	33.0	-13.6
				36	39	19.8	19.3	33.0	-13.7
				75	0	19.8	19.3	33.0	-13.7
15.0	21100	2535.0	QPSK	1	0	20.3	19.8	33.0	-13.2
				1	37	20.1	19.6	33.0	-13.4
				1	74	20.0	19.5	33.0	-13.5
				36	0	20.2	19.7	33.0	-13.3
				36	20	20.2	19.7	33.0	-13.3
				36	39	20.1	19.6	33.0	-13.4
				75	0	20.2	19.7	33.0	-13.4
			16QAM	1	0	20.8	20.3	33.0	-12.7
				1	37	20.5	20.0	33.0	-13.0
				1	74	20.4	19.9	33.0	-13.1
				36	0	20.3	19.8	33.0	-13.2
				36	20	20.3	19.8	33.0	-13.2
				36	39	20.1	19.6	33.0	-13.4
				75	0	20.2	19.7	33.0	-13.3
			64QAM	1	0	20.2	19.7	33.0	-13.3
				1	37	19.9	19.4	33.0	-13.6
				1	74	19.9	19.4	33.0	-13.6
				36	0	19.9	19.4	33.0	-13.6
				36	20	19.9	19.4	33.0	-13.6
				36	39	19.9	19.4	33.0	-13.6
				75	0	19.8	19.3	33.0	-13.7

Antenna gain (dBi)		-0.50							
Bandwidth	UL Channel	Frequency (MHz)	Modulation	RB Size	RB Offset	Conducted Average (dBm)	EIRP Average (dBm)	EIRP Limit (dBm)	Margin (dB)
15.0	21375	2562.5	QPSK	1	0	20.4	19.9	33.0	-13.1
				1	37	20.1	19.6	33.0	-13.4
				1	74	20.2	19.7	33.0	-13.3
				36	0	20.4	19.9	33.0	-13.1
				36	20	20.2	19.7	33.0	-13.3
				36	39	20.3	19.8	33.0	-13.2
				75	0	20.3	19.8	33.0	-13.2
			16QAM	1	0	20.4	19.9	33.0	-13.1
				1	37	20.1	19.6	33.0	-13.4
				1	74	20.1	19.6	33.0	-13.4
				36	0	20.4	19.9	33.0	-13.1
				36	20	20.3	19.8	33.0	-13.2
				36	39	20.4	19.9	33.0	-13.2
				75	0	20.4	19.9	33.0	-13.1
			64QAM	1	0	20.5	20.0	33.0	-13.0
				1	37	20.1	19.6	33.0	-13.4
				1	74	20.1	19.6	33.0	-13.4
				36	0	20.3	19.8	33.0	-13.2
				36	20	20.2	19.7	33.0	-13.3
				36	39	20.2	19.7	33.0	-13.3
				75	0	20.2	19.7	33.0	-13.3

Antenna gain (dBi)		-0.50										
Bandwidth	UL Channel	Frequency (MHz)	Modulation	RB Size	RB Offset	Conducted Average (dBm)	EIRP Average (dBm)	EIRP Limit (dBm)	Margin (dB)			
20.0	20850	2510.0	QPSK	1	0	20.4	19.9	33.0	-13.1			
				1	49	20.3	19.8	33.0	-13.2			
				1	99	20.2	19.7	33.0	-13.3			
				50	0	20.5	20.0	33.0	-13.0			
				50	24	20.5	20.0	33.0	-13.1			
				50	50	20.4	19.9	33.0	-13.1			
			16QAM	100	0	20.5	20.0	33.0	-13.0			
				1	0	20.9	20.4	33.0	-12.6			
				1	49	20.7	20.2	33.0	-12.8			
				1	99	20.7	20.2	33.0	-12.9			
				50	0	20.5	20.0	33.0	-13.0			
				50	24	20.5	20.0	33.0	-13.0			
			64QAM	50	50	20.4	19.9	33.0	-13.1			
				100	0	20.5	20.0	33.0	-13.0			
				1	0	20.2	19.7	33.0	-13.3			
				1	49	20.0	19.5	33.0	-13.5			
				1	99	20.0	19.5	33.0	-13.5			
				50	0	20.1	19.6	33.0	-13.4			
			20.0	21100	2535.0	QPSK	50	24	19.9	19.4	33.0	-13.6
							50	50	19.8	19.3	33.0	-13.7
							100	0	19.9	19.4	33.0	-13.6
1	0	20.6					20.1	33.0	-12.9			
1	49	20.4					19.9	33.0	-13.1			
1	99	20.2					19.7	33.0	-13.3			
16QAM	50	0				20.5	20.0	33.0	-13.0			
	50	24				20.5	20.0	33.0	-13.0			
	50	50				20.4	19.9	33.0	-13.1			
	100	0				20.5	20.0	33.0	-13.0			
	1	0				21.0	20.5	33.0	-12.5			
	1	49				21.0	20.5	33.0	-12.5			
64QAM	1	99				20.8	20.3	33.0	-12.7			
	50	0				20.7	20.2	33.0	-12.9			
	50	24				20.6	20.1	33.0	-12.9			
	50	50				20.5	20.0	33.0	-13.0			
	100	0				20.5	20.0	33.0	-13.0			
	1	0				20.6	20.1	33.0	-12.9			
				1	49	20.3	19.8	33.0	-13.2			
				1	99	20.0	19.5	33.0	-13.5			
				50	0	20.0	19.5	33.0	-13.5			
				50	24	20.0	19.5	33.0	-13.5			
				50	50	19.9	19.4	33.0	-13.6			
				100	0	20.0	19.5	33.0	-13.5			

Antenna gain (dBi)		-0.50							
Bandwidth	UL Channel	Frequency (MHz)	Modulation	RB Size	RB Offset	Conducted Average (dBm)	EIRP Average (dBm)	EIRP Limit (dBm)	Margin (dB)
20.0	21350	2560.0	QPSK	1	0	20.6	20.1	33.0	-12.9
				1	49	20.4	19.9	33.0	-13.2
				1	99	20.4	19.9	33.0	-13.1
				50	0	20.6	20.1	33.0	-12.9
				50	24	20.5	20.0	33.0	-13.0
				50	50	20.4	19.9	33.0	-13.1
				100	0	20.5	20.0	33.0	-13.0
			16QAM	1	0	21.0	20.5	33.0	-12.5
				1	49	20.9	20.4	33.0	-12.6
				1	99	20.9	20.4	33.0	-12.6
				50	0	20.6	20.1	33.0	-12.9
				50	24	20.6	20.1	33.0	-12.9
				50	50	20.5	20.0	33.0	-13.0
				100	0	20.6	20.1	33.0	-12.9
			64QAM	1	0	20.5	20.0	33.0	-13.0
				1	49	20.2	19.7	33.0	-13.3
				1	99	20.3	19.8	33.0	-13.2
				50	0	20.1	19.6	33.0	-13.4
				50	24	20.0	19.5	33.0	-13.5
				50	50	20.0	19.5	33.0	-13.5
				100	0	20.0	19.5	33.0	-13.5

**LTE Band 12**

Antenna gain (dBi)		-2.30										
Bandwidth	UL Channel	Frequency (MHz)	Modulation	RB Size	RB Offset	Conducted Average (dBm)	ERP Average (dBm)	ERP Limit (dBm)	Margin (dB)			
1.4	23017	699.7	QPSK	1	0	24.4	19.6	34.7	-15.1			
				1	3	24.4	19.6	34.7	-15.1			
				1	5	24.4	19.6	34.7	-15.1			
				3	0	24.4	19.6	34.7	-15.1			
				3	1	24.4	19.6	34.7	-15.1			
				3	3	24.4	19.6	34.7	-15.1			
			16QAM	1	0	23.4	18.6	34.7	-16.1			
				1	3	23.5	18.7	34.7	-16.0			
				1	5	23.4	18.6	34.7	-16.1			
				3	0	23.6	18.8	34.7	-15.9			
				3	1	23.6	18.8	34.7	-15.9			
				3	3	23.6	18.8	34.7	-15.9			
			64QAM	1	0	22.3	17.5	34.7	-17.2			
				1	3	22.3	17.5	34.7	-17.2			
				1	5	22.2	17.4	34.7	-17.3			
				3	0	22.2	17.4	34.7	-17.3			
				3	1	22.3	17.5	34.7	-17.2			
				3	3	22.3	17.5	34.7	-17.2			
			1.4	23095	707.5	QPSK	1	0	24.3	19.5	34.7	-15.2
							1	3	24.4	19.6	34.7	-15.1
							1	5	24.3	19.5	34.7	-15.2
3	0	24.3					19.5	34.7	-15.2			
3	1	24.3					19.5	34.7	-15.2			
3	3	24.4					19.6	34.7	-15.1			
16QAM	6	0				23.3	18.5	34.7	-16.2			
	1	0				23.6	18.8	34.7	-15.9			
	1	3				23.7	18.9	34.7	-15.8			
	1	5				23.6	18.8	34.7	-15.9			
	3	0				23.5	18.7	34.7	-16.0			
	3	1				23.5	18.7	34.7	-16.0			
64QAM	3	3				23.5	18.7	34.7	-16.0			
	6	0				22.3	17.5	34.7	-17.2			
	1	0				22.4	17.6	34.7	-17.1			
	1	3				22.3	17.5	34.7	-17.2			
	1	5				22.3	17.5	34.7	-17.2			
	3	0				22.2	17.4	34.7	-17.3			
	3	1				22.2	17.4	34.7	-17.3			
	3	3				22.2	17.4	34.7	-17.3			
	6	0				21.1	16.3	34.7	-18.4			

Antenna gain (dBi)		-2.30							
Bandwidth	UL Channel	Frequency (MHz)	Modulation	RB Size	RB Offset	Conducted Average (dBm)	ERP Average (dBm)	ERP Limit (dBm)	Margin (dB)
1.4	23173	715.3	QPSK	1	0	24.2	19.4	34.7	-15.3
				1	3	24.2	19.4	34.7	-15.3
				1	5	24.1	19.3	34.7	-15.4
				3	0	24.2	19.4	34.7	-15.3
				3	1	24.2	19.4	34.7	-15.3
				3	3	24.2	19.4	34.7	-15.3
				6	0	23.2	18.4	34.7	-16.3
			16QAM	1	0	23.2	18.4	34.7	-16.3
				1	3	23.3	18.5	34.7	-16.2
				1	5	23.2	18.4	34.7	-16.3
				3	0	23.3	18.5	34.7	-16.2
				3	1	23.3	18.5	34.7	-16.2
				3	3	23.3	18.5	34.7	-16.2
				6	0	22.4	17.6	34.7	-17.1
			64QAM	1	0	22.3	17.5	34.7	-17.2
				1	3	22.3	17.5	34.7	-17.2
				1	5	22.2	17.4	34.7	-17.3
				3	0	22.1	17.3	34.7	-17.4
				3	1	22.0	17.2	34.7	-17.5
				3	3	22.0	17.2	34.7	-17.5
				6	0	21.0	16.2	34.7	-18.5

Antenna gain (dBi)		-2.30							
Bandwidth	UL Channel	Frequency (MHz)	Modulation	RB Size	RB Offset	Conducted Average (dBm)	ERP Average (dBm)	ERP Limit (dBm)	Margin (dB)
3.0	23025	700.5	QPSK	1	0	24.4	19.6	34.7	-15.1
				1	8	24.5	19.7	34.7	-15.0
				1	14	24.4	19.6	34.7	-15.1
				8	0	23.5	18.7	34.7	-16.0
				8	4	23.5	18.7	34.7	-16.0
				8	7	23.5	18.7	34.7	-16.0
				15	0	23.5	18.7	34.7	-16.0
			16QAM	1	0	23.5	18.7	34.7	-16.0
				1	8	23.6	18.8	34.7	-15.9
				1	14	23.5	18.7	34.7	-16.0
				8	0	22.6	17.8	34.7	-16.9
				8	4	22.6	17.8	34.7	-16.9
				8	7	22.6	17.8	34.7	-16.9
				15	0	22.5	17.7	34.7	-17.0
			64QAM	1	0	22.3	17.5	34.7	-17.2
				1	8	22.1	17.3	34.7	-17.4
				1	14	22.4	17.6	34.7	-17.1
				8	0	21.3	16.5	34.7	-18.2
				8	4	21.3	16.5	34.7	-18.2
				8	7	21.3	16.5	34.7	-18.2
				15	0	21.2	16.4	34.7	-18.3
3.0	23095	707.5	QPSK	1	0	24.4	19.6	34.7	-15.1
				1	8	24.5	19.7	34.7	-15.0
				1	14	24.4	19.6	34.7	-15.1
				8	0	23.4	18.6	34.7	-16.1
				8	4	23.4	18.6	34.7	-16.1
				8	7	23.4	18.6	34.7	-16.1
				15	0	23.4	18.6	34.7	-16.1
			16QAM	1	0	23.8	19.0	34.7	-15.7
				1	8	23.8	19.0	34.7	-15.7
				1	14	23.7	18.9	34.7	-15.8
				8	0	22.5	17.7	34.7	-17.0
				8	4	22.5	17.7	34.7	-17.0
				8	7	22.5	17.7	34.7	-17.0
				15	0	22.5	17.7	34.7	-17.0
			64QAM	1	0	22.5	17.7	34.7	-17.0
				1	8	22.5	17.7	34.7	-17.0
				1	14	22.3	17.5	34.7	-17.2
				8	0	21.2	16.4	34.7	-18.3
				8	4	21.2	16.4	34.7	-18.3
				8	7	21.2	16.4	34.7	-18.3
				15	0	21.2	16.4	34.7	-18.3



Antenna gain (dBi)		-2.30							
Bandwidth	UL Channel	Frequency (MHz)	Modulation	RB Size	RB Offset	Conducted Average (dBm)	ERP Average (dBm)	ERP Limit (dBm)	Margin (dB)
3.0	23165	714.5	QPSK	1	0	24.2	19.4	34.7	-15.3
				1	8	24.3	19.5	34.7	-15.2
				1	14	24.2	19.4	34.7	-15.3
				8	0	23.3	18.5	34.7	-16.2
				8	4	23.3	18.5	34.7	-16.2
				8	7	23.3	18.5	34.7	-16.2
				15	0	23.3	18.5	34.7	-16.2
			16QAM	1	0	23.2	18.4	34.7	-16.3
				1	8	23.2	18.4	34.7	-16.3
				1	14	23.1	18.3	34.7	-16.4
				8	0	22.5	17.7	34.7	-17.0
				8	4	22.4	17.6	34.7	-17.1
				8	7	22.4	17.6	34.7	-17.1
				15	0	22.4	17.6	34.7	-17.1
			64QAM	1	0	22.4	17.6	34.7	-17.1
				1	8	22.4	17.6	34.7	-17.1
				1	14	22.3	17.5	34.7	-17.2
				8	0	21.1	16.3	34.7	-18.4
				8	4	21.1	16.3	34.7	-18.4
				8	7	21.1	16.3	34.7	-18.4
				15	0	21.1	16.3	34.7	-18.4

Antenna gain (dBi)		-2.30										
Bandwidth	UL Channel	Frequency (MHz)	Modulation	RB Size	RB Offset	Conducted Average (dBm)	ERP Average (dBm)	ERP Limit (dBm)	Margin (dB)			
5.0	23035	701.5	QPSK	1	0	24.6	19.8	34.7	-14.9			
				1	12	24.5	19.7	34.7	-15.0			
				1	24	24.5	19.7	34.7	-15.0			
				12	0	23.5	18.7	34.7	-16.0			
				12	7	23.5	18.7	34.7	-16.0			
				12	13	23.5	18.7	34.7	-16.0			
			16QAM	25	0	23.5	18.7	34.7	-16.0			
				1	0	23.6	18.8	34.7	-15.9			
				1	12	23.6	18.8	34.7	-15.9			
				1	24	23.6	18.8	34.7	-15.9			
				12	0	22.6	17.8	34.7	-16.9			
				12	7	22.6	17.8	34.7	-16.9			
			64QAM	12	13	22.6	17.8	34.7	-16.9			
				25	0	22.5	17.7	34.7	-17.0			
				1	0	22.5	17.7	34.7	-17.0			
				1	12	22.6	17.8	34.7	-16.9			
				1	24	22.5	17.7	34.7	-17.0			
				12	0	21.3	16.5	34.7	-18.2			
			5.0	23095	707.5	QPSK	12	7	21.3	16.5	34.7	-18.2
							12	13	21.3	16.5	34.7	-18.2
							25	0	21.3	16.5	34.7	-18.2
1	0	24.4					19.6	34.7	-15.1			
1	12	24.4					19.6	34.7	-15.1			
1	24	24.3					19.5	34.7	-15.2			
16QAM	12	0				23.4	18.6	34.7	-16.1			
	12	7				23.4	18.6	34.7	-16.1			
	12	13				23.4	18.6	34.7	-16.1			
	25	0				23.4	18.6	34.7	-16.1			
	1	0				23.9	19.1	34.7	-15.6			
	1	2				23.9	19.1	34.7	-15.6			
64QAM	1	5				23.9	19.1	34.7	-15.6			
	3	0				22.6	17.8	34.7	-16.9			
	3	1				22.6	17.8	34.7	-16.9			
	3	2				22.5	17.7	34.7	-17.0			
	6	0				22.5	17.7	34.7	-17.0			
	1	0				22.5	17.7	34.7	-17.0			
64QAM	1	12				22.4	17.6	34.7	-17.1			
	1	24				22.4	17.6	34.7	-17.1			
	12	0				21.1	16.3	34.7	-18.4			
	12	7	21.2	16.4	34.7	-18.3						
	12	13	21.2	16.4	34.7	-18.3						
	25	0	21.2	16.4	34.7	-18.3						

Antenna gain (dBi)		-2.30							
Bandwidth	UL Channel	Frequency (MHz)	Modulation	RB Size	RB Offset	Conducted Average (dBm)	ERP Average (dBm)	ERP Limit (dBm)	Margin (dB)
5.0	23155	713.5	QPSK	1	0	24.4	19.6	34.7	-15.1
				1	12	24.3	19.5	34.7	-15.2
				1	24	24.3	19.5	34.7	-15.2
				12	0	23.4	18.6	34.7	-16.1
				12	7	23.4	18.6	34.7	-16.1
				12	13	23.3	18.5	34.7	-16.2
				25	0	23.3	18.5	34.7	-16.2
			16QAM	1	0	23.5	18.7	34.7	-16.0
				1	12	23.4	18.6	34.7	-16.1
				1	24	23.4	18.6	34.7	-16.1
				12	0	22.5	17.7	34.7	-17.0
				12	7	22.5	17.7	34.7	-17.0
				12	13	22.4	17.6	34.7	-17.1
				25	0	22.4	17.6	34.7	-17.1
			64QAM	1	0	22.3	17.5	34.7	-17.2
				1	12	22.4	17.6	34.7	-17.1
				1	24	22.2	17.4	34.7	-17.3
				12	0	21.1	16.3	34.7	-18.4
				12	7	21.2	16.4	34.7	-18.3
				12	13	21.1	16.3	34.7	-18.4
				12	0	21.1	16.3	34.7	-18.4
25	0	21.1		16.3	34.7	-18.4			

Antenna gain (dBi)		-2.30							
Bandwidth	UL Channel	Frequency (MHz)	Modulation	RB Size	RB Offset	Conducted Average (dBm)	ERP Average (dBm)	ERP Limit (dBm)	Margin (dB)
10.0	23095	707.5	QPSK	1	0	24.4	19.6	34.7	-15.1
				1	25	24.4	19.6	34.7	-15.1
				1	49	24.2	19.4	34.7	-15.3
				25	0	23.4	18.6	34.7	-16.1
				25	12	23.4	18.6	34.7	-16.1
				25	25	23.3	18.5	34.7	-16.2
			16QAM	50	0	23.4	18.6	34.7	-16.1
				1	0	23.8	19.0	34.7	-15.7
				1	25	23.6	18.8	34.7	-15.9
				1	49	23.6	18.8	34.7	-15.9
				25	0	22.5	17.7	34.7	-17.0
				25	12	22.5	17.7	34.7	-17.0
			64QAM	25	25	22.4	17.6	34.7	-17.1
				50	0	22.4	17.6	34.7	-17.1
				1	0	22.5	17.7	34.7	-17.0
				1	25	22.3	17.5	34.7	-17.2
				1	49	22.2	17.4	34.7	-17.3
				25	0	21.2	16.4	34.7	-18.3
				25	12	21.2	16.4	34.7	-18.3
				25	25	21.2	16.4	34.7	-18.3
			50	0	21.2	16.4	34.7	-18.3	

**LTE Band 13**

Antenna gain (dBi)		-1.20							
Bandwidth	UL Channel	Frequency (MHz)	Modulation	RB Size	RB Offset	Conducted Average (dBm)	ERP Average (dBm)	ERP Limit (dBm)	Margin (dB)
5.0	23230	782.0	QPSK	1	0	23.6	19.9	34.7	-14.8
				1	12	23.6	19.9	34.7	-14.8
				1	24	23.6	19.9	34.7	-14.8
				12	0	22.6	18.9	34.7	-15.8
				12	7	22.6	18.9	34.7	-15.8
				12	13	22.5	18.8	34.7	-15.9
			16QAM	25	0	22.6	18.9	34.7	-15.8
				1	0	22.6	18.9	34.7	-15.8
				1	12	22.6	18.9	34.7	-15.8
				1	24	22.6	18.9	34.7	-15.8
				12	0	21.7	18.0	34.7	-16.7
				12	7	21.6	17.9	34.7	-16.8
			64QAM	12	13	21.6	17.9	34.7	-16.8
				25	0	21.6	17.9	34.7	-16.8
				1	0	21.2	17.5	34.7	-17.2
				1	12	21.3	17.6	34.7	-17.1
				1	24	21.3	17.6	34.7	-17.1
				12	0	20.2	16.5	34.7	-18.2
12	7	20.3	16.6	34.7	-18.1				
12	13	20.2	16.5	34.7	-18.2				
25	0	20.2	16.5	34.7	-18.2				

Antenna gain (dBi)		-1.20							
Bandwidth	UL Channel	Frequency (MHz)	Modulation	RB Size	RB Offset	Conducted Average (dBm)	ERP Average (dBm)	ERP Limit (dBm)	Margin (dB)
10.0	23230	782.0	QPSK	1	0	23.5	19.8	34.7	-14.9
				1	25	23.5	19.8	34.7	-14.9
				1	49	23.5	19.8	34.7	-14.9
				25	0	22.5	18.8	34.7	-15.9
				25	12	22.6	18.9	34.7	-15.8
				25	25	22.5	18.8	34.7	-15.9
			16QAM	50	0	22.5	18.8	34.7	-15.9
				1	0	22.5	18.8	34.7	-15.9
				1	25	22.4	18.7	34.7	-16.0
				1	49	22.4	18.7	34.7	-16.0
				25	0	21.5	17.8	34.7	-16.9
				25	12	21.6	17.9	34.7	-16.8
			64QAM	25	25	21.5	17.8	34.7	-16.9
				50	0	21.5	17.8	34.7	-16.9
				1	0	21.1	17.4	34.7	-17.3
				1	25	21.1	17.4	34.7	-17.3
				1	49	21.1	17.4	34.7	-17.3
				25	0	20.1	16.4	34.7	-18.3
25	12	20.2	16.5	34.7	-18.2				
25	25	20.2	16.5	34.7	-18.2				
50	0	20.2	16.5	34.7	-18.2				

**LTE Band 25**

Antenna gain (dBi)		2.60										
Bandwidth	UL Channel	Frequency (MHz)	Modulation	RB Size	RB Offset	Conducted Average (dBm)	EIRP Average (dBm)	EIRP Limit (dBm)	Margin (dB)			
1.4	26047	1850.7	QPSK	1	0	22.1	24.7	33.0	-8.3			
				1	3	22.2	24.8	33.0	-8.2			
				1	5	22.1	24.7	33.0	-8.3			
				3	0	22.1	24.7	33.0	-8.3			
				3	1	22.2	24.8	33.0	-8.2			
				3	3	22.2	24.8	33.0	-8.2			
			16QAM	6	0	22.1	24.7	33.0	-8.3			
				1	0	22.2	24.8	33.0	-8.2			
				1	3	22.2	24.8	33.0	-8.2			
				1	5	22.2	24.8	33.0	-8.2			
				3	0	22.3	24.9	33.0	-8.1			
				3	1	22.4	25.0	33.0	-8.0			
			64QAM	3	3	22.4	25.0	33.0	-8.1			
				6	0	22.3	24.9	33.0	-8.1			
				1	0	21.7	24.3	33.0	-8.7			
				1	3	21.9	24.5	33.0	-8.5			
				1	5	21.9	24.5	33.0	-8.5			
				3	0	21.6	24.2	33.0	-8.8			
			1.4	26365	1882.5	QPSK	3	1	21.7	24.3	33.0	-8.7
							3	3	21.6	24.2	33.0	-8.8
							3	1	21.7	24.3	33.0	-8.7
							3	3	21.6	24.2	33.0	-8.8
							6	0	20.8	23.4	33.0	-9.6
							6	0	20.8	23.4	33.0	-9.6
QPSK	1	0				22.3	24.9	33.0	-8.1			
	1	3				22.4	25.0	33.0	-8.0			
	1	5				22.3	24.9	33.0	-8.1			
	3	0				22.3	24.9	33.0	-8.1			
	3	1				22.4	25.0	33.0	-8.0			
	3	3				22.4	25.0	33.0	-8.1			
16QAM	6	0				22.3	24.9	33.0	-8.1			
	1	0				22.7	25.3	33.0	-7.7			
	1	3				22.7	25.3	33.0	-7.7			
	1	5				22.7	25.3	33.0	-7.7			
	3	0				22.5	25.1	33.0	-7.9			
	3	1				22.5	25.1	33.0	-7.9			
64QAM	3	3	22.5	25.1	33.0	-7.9						
	6	0	22.2	24.8	33.0	-8.2						
	1	0	22.0	24.6	33.0	-8.4						
	1	3	22.0	24.6	33.0	-8.4						
	1	5	22.2	24.8	33.0	-8.2						
	3	0	21.9	24.5	33.0	-8.5						
64QAM	3	1	21.8	24.4	33.0	-8.6						
	3	3	21.9	24.5	33.0	-8.5						
	6	0	20.9	23.5	33.0	-9.5						

Antenna gain (dBi)		2.60							
Bandwidth	UL Channel	Frequency (MHz)	Modulation	RB Size	RB Offset	Conducted Average (dBm)	EIRP Average (dBm)	EIRP Limit (dBm)	Margin (dB)
1.4	26683	1914.3	QPSK	1	0	22.4	25.0	33.0	-8.1
				1	3	22.4	25.0	33.0	-8.0
				1	5	22.3	24.9	33.0	-8.1
				3	0	22.3	24.9	33.0	-8.1
				3	1	22.4	25.0	33.0	-8.0
				3	3	22.4	25.0	33.0	-8.0
				6	0	22.3	24.9	33.0	-8.1
			16QAM	1	0	22.4	25.0	33.0	-8.0
				1	3	22.5	25.1	33.0	-7.9
				1	5	22.4	25.0	33.0	-8.0
				3	0	22.4	25.0	33.0	-8.0
				3	1	22.4	25.0	33.0	-8.0
				3	3	22.4	25.0	33.0	-8.0
				6	0	22.5	25.1	33.0	-7.9
			64QAM	1	0	22.0	24.6	33.0	-8.4
				1	3	22.3	24.9	33.0	-8.1
				1	5	22.3	24.9	33.0	-8.1
				3	0	22.0	24.6	33.0	-8.4
				3	1	21.9	24.5	33.0	-8.5
				3	3	21.9	24.5	33.0	-8.5
				6	0	21.1	23.7	33.0	-9.3

Antenna gain (dBi)		2.60										
Bandwidth	UL Channel	Frequency (MHz)	Modulation	RB Size	RB Offset	Conducted Average (dBm)	EIRP Average (dBm)	EIRP Limit (dBm)	Margin (dB)			
3.0	20655	1851.5	QPSK	1	0	22.3	24.9	33.0	-8.1			
				1	8	22.3	24.9	33.0	-8.1			
				1	14	22.2	24.8	33.0	-8.2			
				8	0	22.3	24.9	33.0	-8.1			
				8	4	22.3	24.9	33.0	-8.1			
				8	7	22.2	24.8	33.0	-8.2			
			16QAM	15	0	22.2	24.8	33.0	-8.2			
				1	0	22.3	24.9	33.0	-8.1			
				1	8	22.4	25.0	33.0	-8.0			
				1	14	22.3	24.9	33.0	-8.2			
				8	0	22.3	24.9	33.0	-8.1			
				8	4	22.3	24.9	33.0	-8.1			
			64QAM	8	7	22.3	24.9	33.0	-8.1			
				15	0	22.2	24.8	33.0	-8.2			
				1	0	21.6	24.2	33.0	-8.8			
				1	8	21.6	24.2	33.0	-8.8			
				1	14	21.7	24.3	33.0	-8.7			
				8	0	20.8	23.4	33.0	-9.6			
			3.0	26365	1882.5	QPSK	8	4	20.8	23.4	33.0	-9.6
							8	7	20.8	23.4	33.0	-9.6
							15	0	20.8	23.4	33.0	-9.6
1	0	22.2					24.8	33.0	-8.2			
1	8	22.3					24.9	33.0	-8.1			
1	14	22.2					24.8	33.0	-8.2			
16QAM	8	0				22.2	24.8	33.0	-8.2			
	8	4				22.2	24.8	33.0	-8.2			
	8	7				22.2	24.8	33.0	-8.2			
	15	0				22.1	24.7	33.0	-8.3			
	1	0				22.6	25.2	33.0	-7.9			
	1	8				22.7	25.3	33.0	-7.8			
64QAM	1	14				22.5	25.1	33.0	-7.9			
	8	0				22.3	24.9	33.0	-8.1			
	8	4				22.3	24.9	33.0	-8.1			
	8	7				22.3	24.9	33.0	-8.1			
	15	0				22.2	24.8	33.0	-8.2			
	1	0				21.8	24.4	33.0	-8.6			
64QAM	1	8				21.8	24.4	33.0	-8.6			
	1	14				21.6	24.2	33.0	-8.8			
	8	0				20.8	23.4	33.0	-9.6			
	8	4	20.8	23.4	33.0	-9.6						
	8	7	20.8	23.4	33.0	-9.6						
	15	0	20.8	23.4	33.0	-9.6						



Antenna gain (dBi)		2.60							
Bandwidth	UL Channel	Frequency (MHz)	Modulation	RB Size	RB Offset	Conducted Average (dBm)	EIRP Average (dBm)	EIRP Limit (dBm)	Margin (dB)
3.0	26675	1913.5	QPSK	1	0	22.4	25.0	33.0	-8.1
				1	8	22.4	25.0	33.0	-8.0
				1	14	22.3	24.9	33.0	-8.1
				8	0	22.4	25.0	33.0	-8.1
				8	4	22.4	25.0	33.0	-8.0
				8	7	22.4	25.0	33.0	-8.0
				15	0	22.4	25.0	33.0	-8.0
			16QAM	1	0	22.3	24.9	33.0	-8.1
				1	8	22.3	24.9	33.0	-8.1
				1	14	22.2	24.8	33.0	-8.2
				8	0	22.5	25.1	33.0	-7.9
				8	4	22.5	25.1	33.0	-7.9
				8	7	22.5	25.1	33.0	-7.9
				15	0	22.4	25.0	33.0	-8.0
			64QAM	1	0	22.1	24.7	33.0	-8.3
				1	8	22.1	24.7	33.0	-8.3
				1	14	22.1	24.7	33.0	-8.3
				8	0	21.1	23.7	33.0	-9.3
				8	4	21.1	23.7	33.0	-9.3
				8	7	21.1	23.7	33.0	-9.3
				15	0	21.1	23.7	33.0	-9.3

Antenna gain (dBi)		2.60										
Bandwidth	UL Channel	Frequency (MHz)	Modulation	RB Size	RB Offset	Conducted Average (dBm)	EIRP Average (dBm)	EIRP Limit (dBm)	Margin (dB)			
5.0	26065	1852.5	QPSK	1	0	22.0	24.6	33.0	-8.4			
				1	12	22.0	24.6	33.0	-8.4			
				1	24	22.0	24.6	33.0	-8.4			
				12	0	22.0	24.6	33.0	-8.4			
				12	7	22.0	24.6	33.0	-8.4			
				12	13	21.9	24.5	33.0	-8.5			
			16QAM	25	0	22.0	24.6	33.0	-8.5			
				1	0	22.1	24.7	33.0	-8.3			
				1	12	22.0	24.6	33.0	-8.4			
				1	24	22.1	24.7	33.0	-8.4			
				12	0	22.1	24.7	33.0	-8.4			
				12	7	22.0	24.6	33.0	-8.4			
			64QAM	12	13	22.0	24.6	33.0	-8.4			
				25	0	21.9	24.5	33.0	-8.5			
				1	0	22.0	24.6	33.0	-8.4			
				1	12	21.9	24.5	33.0	-8.5			
				1	24	22.0	24.6	33.0	-8.4			
				12	0	20.8	23.4	33.0	-9.6			
			5.0	26365	1882.5	QPSK	12	7	20.8	23.4	33.0	-9.6
							12	13	20.8	23.4	33.0	-9.6
							12	13	20.8	23.4	33.0	-9.6
							25	0	20.9	23.5	33.0	-9.5
							1	0	21.9	24.5	33.0	-8.5
							1	12	21.8	24.4	33.0	-8.6
16QAM	1	24				21.9	24.5	33.0	-8.5			
	12	0				21.9	24.5	33.0	-8.5			
	12	7				21.9	24.5	33.0	-8.5			
	12	13				21.9	24.5	33.0	-8.5			
	25	0				21.9	24.5	33.0	-8.5			
	1	0				22.4	25.0	33.0	-8.0			
64QAM	1	2				22.4	25.0	33.0	-8.0			
	1	5				22.4	25.0	33.0	-8.0			
	3	0				22.1	24.7	33.0	-8.3			
	3	1				22.0	24.6	33.0	-8.4			
	3	2				22.0	24.6	33.0	-8.4			
	6	0				21.9	24.5	33.0	-8.5			
QPSK	1	0				21.7	24.3	33.0	-8.7			
	1	12				21.7	24.3	33.0	-8.7			
	1	24				21.8	24.4	33.0	-8.6			
	12	0				20.8	23.4	33.0	-9.6			
	12	7				20.8	23.4	33.0	-9.6			
	12	13				20.8	23.4	33.0	-9.6			
16QAM	25	0	20.8	23.4	33.0	-9.6						
	1	0	21.7	24.3	33.0	-8.7						
	1	12	21.7	24.3	33.0	-8.7						
	1	24	21.8	24.4	33.0	-8.6						
	12	0	20.8	23.4	33.0	-9.6						
	12	7	20.8	23.4	33.0	-9.6						
64QAM	12	13	20.8	23.4	33.0	-9.6						
	25	0	20.8	23.4	33.0	-9.6						

Antenna gain (dBi)		2.60							
Bandwidth	UL Channel	Frequency (MHz)	Modulation	RB Size	RB Offset	Conducted Average (dBm)	EIRP Average (dBm)	EIRP Limit (dBm)	Margin (dB)
5.0	26665	1912.5	QPSK	1	0	22.2	24.8	33.0	-8.2
				1	12	22.1	24.7	33.0	-8.3
				1	24	22.1	24.7	33.0	-8.3
				12	0	22.1	24.7	33.0	-8.3
				12	7	22.1	24.7	33.0	-8.3
				12	13	22.1	24.7	33.0	-8.3
				25	0	22.1	24.7	33.0	-8.3
			16QAM	1	0	22.3	24.9	33.0	-8.1
				1	12	22.2	24.8	33.0	-8.2
				1	24	22.3	24.9	33.0	-8.2
				12	0	22.2	24.8	33.0	-8.2
				12	7	22.2	24.8	33.0	-8.2
				12	13	22.2	24.8	33.0	-8.2
				25	0	22.1	24.7	33.0	-8.3
			64QAM	1	0	22.3	24.9	33.0	-8.1
				1	12	22.3	24.9	33.0	-8.1
				1	24	22.3	24.9	33.0	-8.1
				12	0	21.2	23.8	33.0	-9.2
				12	7	21.1	23.7	33.0	-9.3
				12	13	21.1	23.7	33.0	-9.3
				25	0	21.1	23.7	33.0	-9.3

Antenna gain (dBi)		2.60							
Bandwidth	UL Channel	Frequency (MHz)	Modulation	RB Size	RB Offset	Conducted Average (dBm)	EIRP Average (dBm)	EIRP Limit (dBm)	Margin (dB)
10.0	26090	1855.0	QPSK	1	0	22.3	24.9	33.0	-8.1
				1	25	21.9	24.5	33.0	-8.5
				1	49	22.1	24.7	33.0	-8.3
				25	0	22.1	24.7	33.0	-8.3
				25	12	22.0	24.6	33.0	-8.4
				25	25	22.0	24.6	33.0	-8.4
			16QAM	50	0	22.0	24.6	33.0	-8.4
				1	0	22.3	24.9	33.0	-8.1
				1	25	22.0	24.6	33.0	-8.4
				1	49	22.1	24.7	33.0	-8.3
				25	0	22.1	24.7	33.0	-8.3
				25	12	22.1	24.7	33.0	-8.3
			64QAM	25	25	22.0	24.6	33.0	-8.4
				50	0	22.1	24.7	33.0	-8.3
				1	0	21.7	24.3	33.0	-8.7
				1	25	21.5	24.1	33.0	-8.9
				1	49	21.7	24.3	33.0	-8.7
				25	0	20.8	23.4	33.0	-9.6
10.0	26365	1882.5	QPSK	25	12	20.8	23.4	33.0	-9.6
				25	25	20.7	23.3	33.0	-9.7
				50	0	20.7	23.3	33.0	-9.7
				1	0	22.3	24.9	33.0	-8.1
				1	25	22.0	24.6	33.0	-8.4
				1	49	22.2	24.8	33.0	-8.2
			16QAM	25	0	22.1	24.7	33.0	-8.3
				25	12	22.1	24.7	33.0	-8.3
				25	25	22.1	24.7	33.0	-8.3
				50	0	22.1	24.7	33.0	-8.3
				1	0	22.7	25.3	33.0	-7.7
				1	25	22.4	25.0	33.0	-8.1
			64QAM	1	49	22.5	25.1	33.0	-7.9
				25	0	22.1	24.7	33.0	-8.3
				25	12	22.1	24.7	33.0	-8.3
				25	25	22.1	24.7	33.0	-8.3
				50	0	22.1	24.7	33.0	-8.3
				1	0	22.0	24.6	33.0	-8.4
	1	25	21.6	24.2	33.0	-8.8			
	1	49	21.8	24.4	33.0	-8.6			
	25	0	20.8	23.4	33.0	-9.6			
	25	12	20.8	23.4	33.0	-9.6			
	25	25	20.8	23.4	33.0	-9.6			
	50	0	20.8	23.4	33.0	-9.6			

Antenna gain (dBi)		2.60							
Bandwidth	UL Channel	Frequency (MHz)	Modulation	RB Size	RB Offset	Conducted Average (dBm)	EIRP Average (dBm)	EIRP Limit (dBm)	Margin (dB)
10.0	26640	1910.0	QPSK	1	0	22.3	24.9	33.0	-8.1
				1	25	22.1	24.7	33.0	-8.3
				1	49	22.1	24.7	33.0	-8.3
				25	0	22.3	24.9	33.0	-8.1
				25	12	22.2	24.8	33.0	-8.2
				25	25	22.2	24.8	33.0	-8.2
			16QAM	50	0	22.2	24.8	33.0	-8.2
				1	0	22.2	24.8	33.0	-8.2
				1	25	22.1	24.7	33.0	-8.4
				1	49	22.0	24.6	33.0	-8.4
				25	0	22.3	24.9	33.0	-8.1
				25	12	22.2	24.8	33.0	-8.2
			64QAM	25	25	22.2	24.8	33.0	-8.2
				50	0	22.2	24.8	33.0	-8.2
				1	0	22.1	24.7	33.0	-8.3
				1	25	21.9	24.5	33.0	-8.5
				1	49	21.8	24.4	33.0	-8.6
				25	0	21.1	23.7	33.0	-9.3
				25	12	21.1	23.7	33.0	-9.3
				25	25	21.1	23.7	33.0	-9.3
				50	0	21.1	23.7	33.0	-9.3

Antenna gain (dBi)		2.60							
Bandwidth	UL Channel	Frequency (MHz)	Modulation	RB Size	RB Offset	Conducted Average (dBm)	EIRP Average (dBm)	EIRP Limit (dBm)	Margin (dB)
15.0	26115	1857.0	QPSK	1	0	22.2	24.8	33.0	-8.2
				1	37	22.0	24.6	33.0	-8.4
				1	74	22.1	24.7	33.0	-8.4
				36	0	22.2	24.8	33.0	-8.3
				36	20	22.1	24.7	33.0	-8.3
				36	39	22.0	24.6	33.0	-8.4
			16QAM	75	0	22.1	24.7	33.0	-8.3
				1	0	22.2	24.8	33.0	-8.3
				1	37	21.9	24.5	33.0	-8.5
				1	74	22.0	24.6	33.0	-8.4
				36	0	22.1	24.7	33.0	-8.3
				36	20	22.1	24.7	33.0	-8.3
			64QAM	36	39	22.0	24.6	33.0	-8.4
				75	0	22.1	24.7	33.0	-8.3
				1	0	21.9	24.5	33.0	-8.5
				1	37	21.9	24.5	33.0	-8.5
				1	74	21.8	24.4	33.0	-8.6
				36	0	20.8	23.4	33.0	-9.6
				36	20	20.8	23.4	33.0	-9.6
				36	39	20.8	23.4	33.0	-9.6
				75	0	20.8	23.4	33.0	-9.6
15.0	26365	1882.5	QPSK	1	0	22.2	24.8	33.0	-8.2
				1	37	22.0	24.6	33.0	-8.4
				1	74	22.0	24.6	33.0	-8.4
				36	0	22.1	24.7	33.0	-8.3
				36	20	22.1	24.7	33.0	-8.3
				36	39	22.1	24.7	33.0	-8.3
			16QAM	75	0	22.1	24.7	33.0	-8.3
				1	0	22.6	25.2	33.0	-7.8
				1	37	22.4	25.0	33.0	-8.0
				1	74	22.3	24.9	33.0	-8.1
				36	0	22.2	24.8	33.0	-8.3
				36	20	22.1	24.7	33.0	-8.3
			64QAM	36	39	22.1	24.7	33.0	-8.4
				75	0	22.1	24.7	33.0	-8.3
				1	0	21.9	24.5	33.0	-8.5
				1	37	21.7	24.3	33.0	-8.7
				1	74	21.8	24.4	33.0	-8.6
				36	0	20.9	23.5	33.0	-9.5
				36	20	20.9	23.5	33.0	-9.5
				36	39	20.8	23.4	33.0	-9.6
				75	0	20.8	23.4	33.0	-9.6

Antenna gain (dBi)		2.60							
Bandwidth	UL Channel	Frequency (MHz)	Modulation	RB Size	RB Offset	Conducted Average (dBm)	EIRP Average (dBm)	EIRP Limit (dBm)	Margin (dB)
15.0	26615	1907.5	QPSK	1	0	22.2	24.8	33.0	-8.2
				1	37	22.1	24.7	33.0	-8.3
				1	74	22.1	24.7	33.0	-8.3
				36	0	22.3	24.9	33.0	-8.2
				36	20	22.2	24.8	33.0	-8.2
				36	39	22.2	24.8	33.0	-8.2
				75	0	22.2	24.8	33.0	-8.2
			16QAM	1	0	22.7	25.3	33.0	-7.7
				1	37	22.5	25.1	33.0	-7.9
				1	74	22.5	25.1	33.0	-7.9
				36	0	22.4	25.0	33.0	-8.0
				36	20	22.3	24.9	33.0	-8.1
				36	39	22.2	24.8	33.0	-8.2
				75	0	22.2	24.8	33.0	-8.2
			64QAM	1	0	22.1	24.7	33.0	-8.3
				1	37	22.0	24.6	33.0	-8.4
				1	74	21.9	24.5	33.0	-8.5
				36	0	21.1	23.7	33.0	-9.3
				36	20	21.1	23.7	33.0	-9.3
				36	39	21.0	23.6	33.0	-9.4
				75	0	21.0	23.6	33.0	-9.4

Antenna gain (dBi)		2.60							
Bandwidth	UL Channel	Frequency (MHz)	Modulation	RB Size	RB Offset	Conducted Average (dBm)	EIRP Average (dBm)	EIRP Limit (dBm)	Margin (dB)
20.0	26140	1860.0	QPSK	1	0	22.3	24.9	33.0	-8.1
				1	49	21.9	24.5	33.0	-8.5
				1	99	22.0	24.6	33.0	-8.4
				50	0	22.2	24.8	33.0	-8.3
				50	24	22.1	24.7	33.0	-8.3
				50	50	22.0	24.6	33.0	-8.4
			16QAM	100	0	22.1	24.7	33.0	-8.3
				1	0	22.7	25.3	33.0	-7.7
				1	49	22.3	24.9	33.0	-8.1
				1	99	22.5	25.1	33.0	-7.9
				50	0	22.1	24.7	33.0	-8.3
				50	24	22.0	24.6	33.0	-8.4
			64QAM	50	50	22.0	24.6	33.0	-8.4
				100	0	22.0	24.6	33.0	-8.4
				1	0	21.9	24.5	33.0	-8.5
				1	49	21.8	24.4	33.0	-8.6
				1	99	21.6	24.2	33.0	-8.8
				50	0	20.8	23.4	33.0	-9.6
20.0	26365	1882.5	QPSK	50	24	20.8	23.4	33.0	-9.6
				50	50	20.7	23.3	33.0	-9.7
				100	0	20.7	23.3	33.0	-9.7
				1	0	22.4	25.0	33.0	-8.0
				1	49	22.0	24.6	33.0	-8.4
				1	99	22.1	24.7	33.0	-8.3
			16QAM	50	0	22.2	24.8	33.0	-8.2
				50	24	22.1	24.7	33.0	-8.3
				50	50	22.0	24.6	33.0	-8.4
				100	0	22.1	24.7	33.0	-8.3
				1	0	22.8	25.4	33.0	-7.6
				1	49	22.5	25.1	33.0	-7.9
			64QAM	1	99	22.6	25.2	33.0	-7.9
				50	0	22.2	24.8	33.0	-8.2
				50	24	22.1	24.7	33.0	-8.3
				50	50	22.1	24.7	33.0	-8.3
				100	0	22.1	24.7	33.0	-8.3
				1	0	21.6	24.2	33.0	-8.8
64QAM	1	49	21.6	24.2	33.0	-8.8			
	1	99	21.8	24.4	33.0	-8.6			
	50	0	20.9	23.5	33.0	-9.5			
	50	24	20.9	23.5	33.0	-9.5			
	50	50	20.8	23.4	33.0	-9.6			
	100	0	20.8	23.4	33.0	-9.6			



Antenna gain (dBi)		2.60							
Bandwidth	UL Channel	-1.5	Modulation	RB Size	RB Offset	Conducted Average (dBm)	EIRP Average (dBm)	EIRP Limit (dBm)	Margin (dB)
20.0	590	1905.0	QPSK	1	0	22.5	25.1	33.0	-7.9
				1	49	22.2	24.8	33.0	-8.2
				1	99	22.1	24.7	33.0	-8.3
				50	0	22.4	25.0	33.0	-8.0
				50	24	22.3	24.9	33.0	-8.1
				50	50	22.2	24.8	33.0	-8.2
			16QAM	100	0	22.2	24.8	33.0	-8.2
				1	0	23.0	25.6	33.0	-7.5
				1	49	22.7	25.3	33.0	-7.8
				1	99	22.6	25.2	33.0	-7.8
				50	0	22.4	25.0	33.0	-8.0
				50	24	22.2	24.8	33.0	-8.2
			64QAM	50	50	22.2	24.8	33.0	-8.2
				100	0	22.3	24.9	33.0	-8.1
				1	0	22.1	24.7	33.0	-8.3
				1	49	22.1	24.7	33.0	-8.3
				1	99	21.8	24.4	33.0	-8.6
				50	0	21.1	23.7	33.0	-9.3
50	24	21.1	23.7	33.0	-9.3				
50	50	21.0	23.6	33.0	-9.4				
100	0	21.0	23.6	33.0	-9.4				

**LTE Band 26**

Antenna gain (dBi)		-1.90										
Bandwidth	UL Channel	Frequency (MHz)	Modulation	RB Size	RB Offset	Conducted Average (dBm)	ERP Average (dBm)	ERP Limit (dBm)	Margin (dB)			
1.4	26697	814.7	QPSK	1	0	22.6	18.2	38.5	-20.2			
				1	3	22.7	18.3	38.5	-20.2			
				1	5	22.6	18.2	38.5	-20.3			
				3	0	22.6	18.2	38.5	-20.2			
				3	1	22.7	18.3	38.5	-20.2			
				3	3	22.7	18.3	38.5	-20.2			
			16QAM	6	0	22.6	18.2	38.5	-20.3			
				1	0	23.0	18.6	38.5	-19.9			
				1	3	23.0	18.6	38.5	-19.9			
				1	5	23.0	18.6	38.5	-19.9			
				3	0	22.8	18.4	38.5	-20.0			
				3	1	22.9	18.5	38.5	-20.0			
			64QAM	3	3	22.8	18.4	38.5	-20.0			
				3	0	22.5	18.1	38.5	-20.3			
				1	0	22.2	17.8	38.5	-20.7			
				1	3	22.3	17.9	38.5	-20.6			
				1	5	22.2	17.8	38.5	-20.7			
				3	0	22.0	17.6	38.5	-20.9			
			1.4	26865	831.5	QPSK	3	1	22.0	17.6	38.5	-20.9
							3	3	22.0	17.6	38.5	-20.9
							3	3	22.0	17.6	38.5	-20.9
							6	0	21.2	16.8	38.5	-21.7
							1	0	22.7	18.3	38.5	-20.1
							1	3	22.7	18.3	38.5	-20.1
16QAM	1	5				22.7	18.3	38.5	-20.2			
	3	0				22.7	18.3	38.5	-20.2			
	3	1				22.7	18.3	38.5	-20.1			
	3	3				22.7	18.3	38.5	-20.1			
	6	0				22.7	18.3	38.5	-20.2			
	1	0				22.8	18.4	38.5	-20.0			
64QAM	1	3				22.8	18.4	38.5	-20.0			
	1	5				22.8	18.4	38.5	-20.0			
	3	0				22.7	18.3	38.5	-20.1			
	3	1				22.8	18.4	38.5	-20.1			
	3	3				22.8	18.4	38.5	-20.1			
	6	0				22.8	18.4	38.5	-20.0			
64QAM	1	0	22.1	17.7	38.5	-20.8						
	1	3	22.2	17.8	38.5	-20.7						
	1	5	22.0	17.6	38.5	-20.9						
	3	0	22.0	17.6	38.5	-20.9						
	3	1	22.0	17.6	38.5	-20.9						
	3	3	22.0	17.6	38.5	-20.9						
6	0	21.1	16.7	38.5	-21.8							

Antenna gain (dBi)		-1.90							
Bandwidth	UL Channel	Frequency (MHz)	Modulation	RB Size	RB Offset	Conducted Average (dBm)	ERP Average (dBm)	ERP Limit (dBm)	Margin (dB)
1.4	27033	848.3	QPSK	1	0	22.2	17.8	38.5	-20.7
				1	3	22.3	17.9	38.5	-20.6
				1	5	22.2	17.8	38.5	-20.7
				3	0	22.3	17.9	38.5	-20.6
				3	1	22.3	17.9	38.5	-20.6
				3	3	22.3	17.9	38.5	-20.6
			16QAM	6	0	22.2	17.8	38.5	-20.7
				1	0	22.3	17.9	38.5	-20.6
				1	3	22.3	17.9	38.5	-20.6
				1	5	22.3	17.9	38.5	-20.6
				3	0	22.4	18.0	38.5	-20.5
				3	1	22.5	18.1	38.5	-20.4
			64QAM	3	3	22.5	18.1	38.5	-20.4
				6	0	22.2	17.8	38.5	-20.7
				1	0	22.1	17.7	38.5	-20.8
				1	3	22.3	17.9	38.5	-20.6
				1	5	22.1	17.7	38.5	-20.8
				3	0	22.0	17.6	38.5	-20.9
			3	1	22.0	17.6	38.5	-20.9	
			3	3	22.0	17.6	38.5	-20.9	
			6	0	21.0	16.6	38.5	-21.9	

Antenna gain (dBi)		-1.90										
Bandwidth	UL Channel	Frequency (MHz)	Modulation	RB Size	RB Offset	Conducted Average (dBm)	ERP Average (dBm)	ERP Limit (dBm)	Margin (dB)			
3.0	26705	815.5	QPSK	1	0	22.7	18.3	38.5	-20.2			
				1	8	22.8	18.4	38.5	-20.1			
				1	14	22.5	18.1	38.5	-20.4			
				8	0	22.7	18.3	38.5	-20.2			
				8	4	22.7	18.3	38.5	-20.2			
				8	7	22.7	18.3	38.5	-20.2			
			16QAM	15	0	22.7	18.3	38.5	-20.2			
				1	0	23.0	18.6	38.5	-19.9			
				1	8	23.0	18.6	38.5	-19.9			
				1	14	22.9	18.5	38.5	-20.0			
				8	0	22.8	18.4	38.5	-20.1			
				8	4	22.8	18.4	38.5	-20.1			
			64QAM	8	7	22.8	18.4	38.5	-20.1			
				8	7	22.8	18.4	38.5	-20.1			
				15	0	22.7	18.3	38.5	-20.2			
				1	0	22.2	17.8	38.5	-20.7			
				1	8	22.1	17.7	38.5	-20.8			
				1	14	22.0	17.6	38.5	-20.9			
			3.0	26865	831.5	QPSK	8	0	21.2	16.8	38.5	-21.7
							8	4	21.2	16.8	38.5	-21.7
							8	7	21.2	16.8	38.5	-21.7
8	7	21.2					16.8	38.5	-21.7			
15	0	21.2					16.8	38.5	-21.7			
1	0	22.5					18.1	38.5	-20.4			
16QAM	1	8				22.6	18.2	38.5	-20.3			
	1	14				22.5	18.1	38.5	-20.4			
	8	0				22.6	18.2	38.5	-20.3			
	8	4				22.6	18.2	38.5	-20.3			
	8	7				22.6	18.2	38.5	-20.3			
	15	0				22.6	18.2	38.5	-20.3			
64QAM	1	0				22.5	18.1	38.5	-20.4			
	1	8				22.5	18.1	38.5	-20.4			
	1	14				22.4	18.0	38.5	-20.5			
	8	0				22.7	18.3	38.5	-20.2			
	8	4				22.7	18.3	38.5	-20.2			
	8	7				22.7	18.3	38.5	-20.2			
64QAM	15	0				22.6	18.2	38.5	-20.3			
	1	0				22.3	17.9	38.5	-20.6			
	1	8				22.3	17.9	38.5	-20.6			
	1	14	22.3	17.9	38.5	-20.6						
	8	0	21.2	16.8	38.5	-21.7						
	8	4	21.2	16.8	38.5	-21.7						
8	7	21.2	16.8	38.5	-21.7							
15	0	21.2	16.8	38.5	-21.7							

Antenna gain (dBi)		-1.90							
Bandwidth	UL Channel	Frequency (MHz)	Modulation	RB Size	RB Offset	Conducted Average (dBm)	ERP Average (dBm)	ERP Limit (dBm)	Margin (dB)
3.0	27025	847.5	QPSK	1	0	22.3	17.9	38.5	-20.6
				1	8	22.4	18.0	38.5	-20.5
				1	14	22.3	17.9	38.5	-20.6
				8	0	22.4	18.0	38.5	-20.5
				8	4	22.4	18.0	38.5	-20.5
				8	7	22.3	17.9	38.5	-20.6
				15	0	22.4	18.0	38.5	-20.5
			16QAM	1	0	22.3	17.9	38.5	-20.6
				1	8	22.5	18.1	38.5	-20.4
				1	14	22.4	18.0	38.5	-20.5
				8	0	22.1	17.7	38.5	-20.8
				8	4	22.1	17.7	38.5	-20.8
				8	7	22.1	17.7	38.5	-20.8
				15	0	22.0	17.6	38.5	-20.9
			64QAM	1	0	22.2	17.8	38.5	-20.7
				1	8	22.1	17.7	38.5	-20.8
				1	14	22.2	17.8	38.5	-20.7
				8	0	21.0	16.6	38.5	-21.9
				8	4	21.0	16.6	38.5	-21.9
				8	7	21.0	16.6	38.5	-21.9
				15	0	21.0	16.6	38.5	-21.9

Antenna gain (dBi)		-1.90							
Bandwidth	UL Channel	Frequency (MHz)	Modulation	RB Size	RB Offset	Conducted Average (dBm)	ERP Average (dBm)	ERP Limit (dBm)	Margin (dB)
5.0	26715	816.5	QPSK	1	0	22.6	18.2	38.5	-20.3
				1	12	22.4	18.0	38.5	-20.5
				1	24	22.4	18.0	38.5	-20.5
				12	0	22.5	18.1	38.5	-20.4
				12	7	22.4	18.0	38.5	-20.5
				12	13	22.4	18.0	38.5	-20.5
			25	0	22.4	18.0	38.5	-20.5	
			16QAM	1	0	22.7	18.3	38.5	-20.2
				1	12	22.5	18.1	38.5	-20.4
				1	24	22.5	18.1	38.5	-20.4
				12	0	22.6	18.2	38.5	-20.3
				12	7	22.5	18.1	38.5	-20.4
				12	13	22.4	18.0	38.5	-20.5
			25	0	22.4	18.0	38.5	-20.5	
			64QAM	1	0	22.1	17.7	38.5	-20.8
				1	12	22.0	17.6	38.5	-20.9
				1	24	22.0	17.6	38.5	-20.9
				12	0	21.1	16.7	38.5	-21.8
				12	7	21.0	16.6	38.5	-21.9
				12	13	21.0	16.6	38.5	-21.9
			25	0	21.0	16.6	38.5	-21.9	
5.0	26865	831.5	QPSK	1	0	22.8	18.4	38.5	-20.1
				1	12	22.7	18.3	38.5	-20.2
				1	24	22.7	18.3	38.5	-20.2
				12	0	22.7	18.3	38.5	-20.2
				12	7	22.7	18.3	38.5	-20.2
				12	13	22.7	18.3	38.5	-20.2
			25	0	22.7	18.3	38.5	-20.2	
			16QAM	1	0	22.9	18.5	38.5	-20.0
				1	2	22.8	18.4	38.5	-20.1
				1	5	22.8	18.4	38.5	-20.1
				3	0	22.8	18.4	38.5	-20.1
				3	1	22.8	18.4	38.5	-20.1
				3	2	22.7	18.3	38.5	-20.2
			6	0	22.7	18.3	38.5	-20.2	
			64QAM	1	0	22.2	17.8	38.5	-20.7
				1	12	22.3	17.9	38.5	-20.6
				1	24	22.2	17.8	38.5	-20.7
				12	0	21.2	16.8	38.5	-21.7
				12	7	21.2	16.8	38.5	-21.7
				12	13	21.1	16.7	38.5	-21.8
			25	0	21.2	16.8	38.5	-21.7	

Antenna gain (dBi)		-1.90							
Bandwidth	UL Channel	Frequency (MHz)	Modulation	RB Size	RB Offset	Conducted Average (dBm)	ERP Average (dBm)	ERP Limit (dBm)	Margin (dB)
5.0	27015	846.5	QPSK	1	0	22.3	17.9	38.5	-20.6
				1	12	22.3	17.9	38.5	-20.6
				1	24	22.3	17.9	38.5	-20.6
				12	0	22.3	17.9	38.5	-20.6
				12	7	22.4	18.0	38.5	-20.5
				12	13	22.4	18.0	38.5	-20.5
				25	0	22.4	18.0	38.5	-20.5
			16QAM	1	0	22.9	18.5	38.5	-20.0
				1	12	22.9	18.5	38.5	-20.0
				1	24	22.9	18.5	38.5	-20.0
				12	0	22.5	18.1	38.5	-20.4
				12	7	22.3	17.9	38.5	-20.6
				12	13	22.2	17.8	38.5	-20.7
				25	0	22.4	18.0	38.5	-20.5
			64QAM	1	0	22.3	17.9	38.5	-20.6
				1	12	22.2	17.8	38.5	-20.7
				1	24	22.2	17.8	38.5	-20.7
				12	0	21.2	16.8	38.5	-21.7
				12	7	21.1	16.7	38.5	-21.8
				12	13	21.0	16.6	38.5	-21.9
				25	0	21.2	16.8	38.5	-21.7

Antenna gain (dBi)		-1.90										
Bandwidth	UL Channel	Frequency (MHz)	Modulation	RB Size	RB Offset	Conducted Average (dBm)	ERP Average (dBm)	ERP Limit (dBm)	Margin (dB)			
10.0	26740	819.0	QPSK	1	0	22.6	18.2	38.5	-20.3			
				1	25	22.4	18.0	38.5	-20.5			
				1	49	22.3	17.9	38.5	-20.6			
				25	0	22.4	18.0	38.5	-20.5			
				25	12	22.4	18.0	38.5	-20.5			
				25	25	22.4	18.0	38.5	-20.5			
			16QAM	50	0	22.4	18.0	38.5	-20.5			
				1	0	22.9	18.5	38.5	-20.0			
				1	25	22.8	18.4	38.5	-20.1			
				1	49	22.7	18.3	38.5	-20.2			
				25	0	22.4	18.0	38.5	-20.5			
				25	12	22.5	18.1	38.5	-20.4			
			64QAM	25	25	22.4	18.0	38.5	-20.5			
				50	0	22.5	18.1	38.5	-20.4			
				1	0	22.0	17.6	38.5	-20.9			
				1	25	22.0	17.6	38.5	-20.9			
				1	49	22.0	17.6	38.5	-20.9			
				25	0	21.1	16.7	38.5	-21.8			
			10.0	26865	831.5	QPSK	25	12	21.2	16.8	38.5	-21.7
							25	25	21.1	16.7	38.5	-21.8
							50	0	21.1	16.7	38.5	-21.8
1	0	22.7					18.3	38.5	-20.2			
1	25	22.6					18.2	38.5	-20.3			
1	49	22.5					18.1	38.5	-20.4			
16QAM	25	0				22.7	18.3	38.5	-20.2			
	25	12				22.8	18.4	38.5	-20.1			
	25	25				22.6	18.2	38.5	-20.3			
	50	0				22.7	18.3	38.5	-20.2			
	1	0				22.7	18.3	38.5	-20.2			
	1	25				22.6	18.2	38.5	-20.3			
64QAM	1	49				22.5	18.1	38.5	-20.4			
	25	0				22.8	18.4	38.5	-20.1			
	25	12				22.7	18.3	38.5	-20.2			
	25	25				22.7	18.3	38.5	-20.2			
	50	0				22.7	18.3	38.5	-20.2			
	1	0				22.2	17.8	38.5	-20.7			
64QAM	1	25				22.1	17.7	38.5	-20.8			
	1	49				22.0	17.6	38.5	-20.9			
	25	0				21.2	16.8	38.5	-21.7			
	25	12	21.2	16.8	38.5	-21.7						
	25	25	21.2	16.8	38.5	-21.7						
	50	0	21.2	16.8	38.5	-21.7						



Antenna gain (dBi)		-1.90							
Bandwidth	UL Channel	Frequency (MHz)	Modulation	RB Size	RB Offset	Conducted Average (dBm)	ERP Average (dBm)	EIRP Limit (dBm)	Margin (dB)
10.0	26990	844.0	QPSK	1	0	22.4	18.0	38.5	-20.5
				1	25	22.3	17.9	38.5	-20.6
				1	49	22.2	17.8	38.5	-20.7
				25	0	22.4	18.0	38.5	-20.5
				25	12	22.3	17.9	38.5	-20.6
				25	25	22.2	17.8	38.5	-20.7
				50	0	22.3	17.9	38.5	-20.6
			16QAM	1	0	22.5	18.1	38.5	-20.4
				1	25	22.3	17.9	38.5	-20.6
				1	49	22.3	17.9	38.5	-20.6
				25	0	22.5	18.1	38.5	-20.4
				25	12	22.4	18.0	38.5	-20.5
				25	25	22.4	18.0	38.5	-20.5
				50	0	22.4	18.0	38.5	-20.5
			64QAM	1	0	22.4	18.0	38.5	-20.5
				1	25	22.3	17.9	38.5	-20.6
				1	49	22.2	17.8	38.5	-20.7
				25	0	21.2	16.8	38.5	-21.7
				25	12	21.1	16.7	38.5	-21.8
				25	25	21.1	16.7	38.5	-21.8
				50	0	21.1	16.7	38.5	-21.8

Antenna gain (dBi)		-1.90								
Bandwidth	UL Channel	Frequency (MHz)	Modulation	RB Size	RB Offset	Conducted Average (dBm)	ERP Average (dBm)	ERP Limit (dBm)	Margin (dB)	
15.0	26865	831.5	QPSK	1	0	22.4	18.0	38.5	-20.5	
				1	37	22.4	18.0	38.5	-20.5	
				1	74	22.1	17.7	38.5	-20.8	
				36	0	22.5	18.1	38.5	-20.4	
				36	20	22.5	18.1	38.5	-20.4	
				36	39	22.4	18.0	38.5	-20.5	
			16QAM	75	0	22.4	18.0	38.5	-20.5	
				1	0	22.4	18.0	38.5	-20.5	
				1	37	22.3	17.9	38.5	-20.6	
				1	74	22.1	17.7	38.5	-20.8	
				36	0	22.5	18.1	38.5	-20.4	
				36	20	22.5	18.1	38.5	-20.4	
			64QAM	36	39	22.3	17.9	38.5	-20.6	
				75	0	22.4	18.0	38.5	-20.5	
				1	0	22.3	17.9	38.5	-20.6	
				1	37	22.2	17.8	38.5	-20.7	
				1	74	22.1	17.7	38.5	-20.8	
				36	0	21.3	16.9	38.5	-21.6	
			36	20	21.3	16.9	38.5	-21.6		
			36	39	21.2	16.8	38.5	-21.7		
			75	0	21.2	16.8	38.5	-21.7		

**LTE Band 41**

Antenna gain (dBi)		0.30										
Bandwidth	UL Channel	Frequency (MHz)	Modulation	RB Size	RB Offset	Conducted Average (dBm)	EIRP Average (dBm)	EIRP Limit (dBm)	Margin (dB)			
5.0	39675	2498.5	QPSK	1	0	20.0	20.3	33.0	-12.7			
				1	12	19.9	20.2	33.0	-12.8			
				1	24	19.8	20.1	33.0	-12.9			
				12	0	20.0	20.3	33.0	-12.7			
				12	7	20.0	20.3	33.0	-12.7			
				12	13	19.9	20.2	33.0	-12.8			
			16QAM	25	0	20.0	20.3	33.0	-12.7			
				1	0	19.9	20.2	33.0	-12.8			
				1	12	19.9	20.2	33.0	-12.8			
				1	24	19.8	20.1	33.0	-12.9			
				12	0	20.0	20.3	33.0	-12.7			
				12	7	20.0	20.3	33.0	-12.7			
			64QAM	12	13	20.0	20.3	33.0	-12.7			
				25	0	20.0	20.3	33.0	-12.7			
				1	0	20.0	20.3	33.0	-12.7			
				1	12	20.1	20.4	33.0	-12.6			
				1	24	20.0	20.3	33.0	-12.7			
				12	0	20.0	20.3	33.0	-12.7			
			5.0	40620	2593.0	QPSK	12	7	20.0	20.3	33.0	-12.7
							12	13	20.0	20.3	33.0	-12.7
							25	0	20.0	20.3	33.0	-12.7
							1	0	20.1	20.4	33.0	-12.6
							1	12	20.0	20.3	33.0	-12.7
							1	24	20.0	20.3	33.0	-12.7
16QAM	12	0				20.1	20.4	33.0	-12.6			
	12	7				20.1	20.4	33.0	-12.6			
	12	13				20.1	20.4	33.0	-12.6			
	25	0				20.1	20.4	33.0	-12.6			
	1	0				20.2	20.5	33.0	-12.5			
	1	12				20.2	20.5	33.0	-12.5			
64QAM	1	24				20.2	20.5	33.0	-12.5			
	12	0				20.2	20.5	33.0	-12.5			
	12	7				20.2	20.5	33.0	-12.5			
	12	13				20.2	20.5	33.0	-12.5			
	25	0				20.1	20.4	33.0	-12.6			
	1	0				20.7	21.0	33.0	-12.0			
64QAM	1	12	20.7	21.0	33.0	-12.0						
	1	24	20.7	21.0	33.0	-12.0						
	12	0	20.4	20.7	33.0	-12.3						
	12	7	20.5	20.8	33.0	-12.2						
	12	13	20.4	20.7	33.0	-12.3						
	25	0	20.4	20.7	33.0	-12.3						

Antenna gain (dBi)		0.30							
Bandwidth	UL Channel	Frequency (MHz)	Modulation	RB Size	RB Offset	Conducted Average (dBm)	EIRP Average (dBm)	EIRP Limit (dBm)	Margin (dB)
5.0	41565	2687.5	QPSK	1	0	19.8	20.1	33.0	-12.9
				1	12	19.8	20.1	33.0	-12.9
				1	24	19.7	20.0	33.0	-13.0
				12	0	19.8	20.1	33.0	-12.9
				12	7	19.9	20.2	33.0	-12.8
				12	13	19.8	20.1	33.0	-12.9
				25	0	19.8	20.1	33.0	-12.9
			16QAM	1	0	19.7	20.0	33.0	-13.0
				1	12	19.8	20.1	33.0	-13.0
				1	24	19.7	20.0	33.0	-13.0
				12	0	19.7	20.0	33.0	-13.0
				12	7	19.8	20.1	33.0	-12.9
				12	13	19.8	20.1	33.0	-12.9
				25	0	19.8	20.1	33.0	-12.9
			64QAM	1	0	20.5	20.8	33.0	-12.2
				1	12	20.5	20.8	33.0	-12.2
				1	24	20.5	20.8	33.0	-12.2
				12	0	20.2	20.5	33.0	-12.5
				12	7	20.4	20.7	33.0	-12.3
				12	13	20.3	20.6	33.0	-12.4
				25	0	20.3	20.6	33.0	-12.4

Antenna gain (dBi)		0.30										
Bandwidth	UL Channel	Frequency (MHz)	Modulation	RB Size	RB Offset	Conducted Average (dBm)	EIRP Average (dBm)	EIRP Limit (dBm)	Margin (dB)			
10.0	39700	2501.0	QPSK	1	0	20.1	20.4	33.0	-12.6			
				1	25	20.1	20.4	33.0	-12.6			
				1	49	20.1	20.4	33.0	-12.6			
				25	0	20.3	20.6	33.0	-12.4			
				25	12	20.3	20.6	33.0	-12.4			
				25	25	20.2	20.5	33.0	-12.5			
			16QAM	1	0	20.1	20.4	33.0	-12.6			
				1	25	20.0	20.3	33.0	-12.7			
				1	49	20.0	20.3	33.0	-12.7			
				25	0	20.3	20.6	33.0	-12.4			
				25	12	20.2	20.5	33.0	-12.5			
				25	25	20.2	20.5	33.0	-12.5			
			64QAM	50	0	20.2	20.5	33.0	-12.5			
				1	0	20.4	20.7	33.0	-12.3			
				1	25	20.5	20.8	33.0	-12.2			
				1	49	20.4	20.7	33.0	-12.3			
				25	0	20.0	20.3	33.0	-12.7			
				25	12	20.0	20.3	33.0	-12.7			
			10.0	40620	2593.0	QPSK	25	25	19.9	20.2	33.0	-12.8
							50	0	20.0	20.3	33.0	-12.7
							1	0	20.4	20.7	33.0	-12.3
1	25	20.4					20.7	33.0	-12.3			
1	49	20.3					20.6	33.0	-12.4			
25	0	20.5					20.8	33.0	-12.2			
16QAM	25	12				20.5	20.8	33.0	-12.2			
	25	25				20.5	20.8	33.0	-12.2			
	50	0				20.5	20.8	33.0	-12.2			
	1	0				20.6	20.9	33.0	-12.1			
	1	25				20.6	20.9	33.0	-12.1			
	1	49				20.5	20.8	33.0	-12.2			
64QAM	25	0				20.6	20.9	33.0	-12.1			
	25	12				20.6	20.9	33.0	-12.1			
	25	25				20.5	20.8	33.0	-12.2			
	50	0				20.6	20.9	33.0	-12.1			
	1	0				20.0	20.3	33.0	-12.7			
	1	25				20.0	20.3	33.0	-12.7			
64QAM	1	49				19.9	20.2	33.0	-12.8			
	25	0				20.3	20.6	33.0	-12.4			
	25	12				20.3	20.6	33.0	-12.4			
	25	25	20.3	20.6	33.0	-12.4						
	50	0	20.3	20.6	33.0	-12.4						
	50	0	20.3	20.6	33.0	-12.4						

Antenna gain (dBi)		0.30							
Bandwidth	UL Channel	Frequency (MHz)	Modulation	RB Size	RB Offset	Conducted Average (dBm)	EIRP Average (dBm)	EIRP Limit (dBm)	Margin (dB)
10.0	41540	2685.0	QPSK	1	0	20.4	20.7	33.0	-12.3
				1	25	20.4	20.7	33.0	-12.3
				1	49	20.3	20.6	33.0	-12.4
				25	0	20.4	20.7	33.0	-12.3
				25	12	20.4	20.7	33.0	-12.3
				25	25	20.4	20.7	33.0	-12.4
				50	0	20.3	20.6	33.0	-12.4
			16QAM	1	0	20.5	20.8	33.0	-12.2
				1	25	20.4	20.7	33.0	-12.3
				1	49	20.4	20.7	33.0	-12.3
				25	0	20.4	20.7	33.0	-12.3
				25	12	20.4	20.7	33.0	-12.3
				25	25	20.4	20.7	33.0	-12.3
				50	0	20.4	20.7	33.0	-12.3
			64QAM	1	0	20.1	20.4	33.0	-12.6
				1	25	20.0	20.3	33.0	-12.7
				1	49	20.0	20.3	33.0	-12.7
				25	0	20.2	20.5	33.0	-12.5
				25	12	20.3	20.6	33.0	-12.4
				25	25	20.3	20.6	33.0	-12.4
				50	0	20.3	20.6	33.0	-12.4

Antenna gain (dBi)		0.30										
Bandwidth	UL Channel	Frequency (MHz)	Modulation	RB Size	RB Offset	Conducted Average (dBm)	EIRP Average (dBm)	EIRP Limit (dBm)	Margin (dB)			
15.0	39725	2503.5	QPSK	1	0	20.0	20.3	33.0	-12.8			
				1	37	19.8	20.1	33.0	-12.9			
				1	74	19.8	20.1	33.0	-12.9			
				36	0	20.0	20.3	33.0	-12.7			
				36	20	20.1	20.4	33.0	-12.6			
				36	39	20.0	20.3	33.0	-12.7			
			16QAM	75	0	20.0	20.3	33.0	-12.7			
				1	0	20.0	20.3	33.0	-12.7			
				1	37	19.9	20.2	33.0	-12.8			
				1	74	19.8	20.1	33.0	-12.9			
				36	0	20.0	20.3	33.0	-12.7			
				36	20	20.1	20.4	33.0	-12.6			
			64QAM	36	39	20.0	20.3	33.0	-12.7			
				75	0	20.1	20.4	33.0	-12.6			
				1	0	20.3	20.6	33.0	-12.4			
				1	37	20.3	20.6	33.0	-12.4			
				1	74	20.1	20.4	33.0	-12.6			
				36	0	20.0	20.3	33.0	-12.7			
			15.0	40620	2593.0	QPSK	36	20	20.0	20.3	33.0	-12.7
							36	39	19.9	20.2	33.0	-12.8
							75	0	20.0	20.3	33.0	-12.7
							1	0	20.4	20.7	33.0	-12.3
							1	37	20.2	20.5	33.0	-12.5
							1	74	20.2	20.5	33.0	-12.5
16QAM	36	0				20.3	20.6	33.0	-12.4			
	36	20				20.4	20.7	33.0	-12.4			
	36	39				20.3	20.6	33.0	-12.4			
	75	0				20.3	20.6	33.0	-12.4			
	1	0				20.4	20.7	33.0	-12.3			
	1	37				20.3	20.6	33.0	-12.4			
64QAM	1	74				20.2	20.5	33.0	-12.5			
	36	0				20.3	20.6	33.0	-12.4			
	36	20				20.4	20.7	33.0	-12.3			
	36	39				20.3	20.6	33.0	-12.4			
	75	0				20.2	20.5	33.0	-12.5			
	1	0				19.9	20.2	33.0	-12.8			
64QAM	1	37				19.8	20.1	33.0	-12.9			
	1	74				19.7	20.0	33.0	-13.0			
	36	0				20.3	20.6	33.0	-12.4			
	36	20				20.3	20.6	33.0	-12.4			
	36	39				20.3	20.6	33.0	-12.4			
	75	0				20.3	20.6	33.0	-12.4			

Antenna gain (dBi)		0.30							
Bandwidth	UL Channel	Frequency (MHz)	Modulation	RB Size	RB Offset	Conducted Average (dBm)	EIRP Average (dBm)	EIRP Limit (dBm)	Margin (dB)
15.0	41515	2682.5	QPSK	1	0	20.3	20.6	33.0	-12.4
				1	37	20.1	20.4	33.0	-12.6
				1	74	20.1	20.4	33.0	-12.6
				36	0	20.1	20.4	33.0	-12.6
				36	20	20.2	20.5	33.0	-12.6
				36	39	20.1	20.4	33.0	-12.6
				75	0	20.0	20.3	33.0	-12.7
			16QAM	1	0	20.4	20.7	33.0	-12.3
				1	37	20.4	20.7	33.0	-12.3
				1	74	20.3	20.6	33.0	-12.4
				36	0	20.4	20.7	33.0	-12.3
				36	20	20.4	20.7	33.0	-12.3
				36	39	20.2	20.5	33.0	-12.5
				75	0	20.4	20.7	33.0	-12.4
			64QAM	1	0	20.2	20.5	33.0	-12.5
				1	37	20.2	20.5	33.0	-12.5
				1	74	20.3	20.6	33.0	-12.4
				36	0	20.2	20.5	33.0	-12.5
				36	20	20.3	20.6	33.0	-12.4
				36	39	20.3	20.6	33.0	-12.4
				75	0	20.3	20.6	33.0	-12.4



Antenna gain (dBi)		0.30							
Bandwidth	UL Channel	Frequency (MHz)	Modulation	RB Size	RB Offset	Conducted Average (dBm)	EIRP Average (dBm)	EIRP Limit (dBm)	Margin (dB)
20.0	39750	2506.0	QPSK	1	0	20.4	20.7	33.0	-12.3
				1	49	20.2	20.5	33.0	-12.5
				1	99	20.2	20.5	33.0	-12.5
				50	0	20.3	20.6	33.0	-12.4
				50	24	20.3	20.6	33.0	-12.4
				50	50	20.2	20.5	33.0	-12.5
			100	0	20.4	20.7	33.0	-12.4	
			16QAM	1	0	20.4	20.7	33.0	-12.3
				1	49	20.3	20.6	33.0	-12.4
				1	99	20.2	20.5	33.0	-12.5
				50	0	20.4	20.7	33.0	-12.3
				50	24	20.4	20.7	33.0	-12.3
				50	50	20.4	20.7	33.0	-12.4
			64QAM	100	0	20.4	20.7	33.0	-12.3
				1	0	20.0	20.3	33.0	-12.7
				1	49	19.9	20.2	33.0	-12.8
				1	99	19.7	20.0	33.0	-13.0
				50	0	20.0	20.3	33.0	-12.7
50	24	20.0		20.3	33.0	-12.7			
20.0	40620	2593.0	QPSK	50	50	20.0	20.3	33.0	-12.7
				100	0	20.0	20.3	33.0	-12.7
				1	0	20.5	20.8	33.0	-12.2
				1	49	20.3	20.6	33.0	-12.4
				1	99	20.2	20.5	33.0	-12.5
				50	0	20.3	20.6	33.0	-12.4
			16QAM	50	24	20.4	20.7	33.0	-12.3
				50	50	20.3	20.6	33.0	-12.4
				100	0	20.5	20.8	33.0	-12.2
				1	0	20.4	20.7	33.0	-12.3
				1	49	20.3	20.6	33.0	-12.5
				1	99	20.2	20.5	33.0	-12.5
			64QAM	50	0	20.5	20.8	33.0	-12.2
				50	24	20.5	20.8	33.0	-12.2
				50	50	20.5	20.8	33.0	-12.3
				100	0	20.5	20.8	33.0	-12.2
				1	0	20.0	20.3	33.0	-12.7
				1	49	19.9	20.2	33.0	-12.8
64QAM	1	99	19.8	20.1	33.0	-12.9			
	50	0	20.4	20.7	33.0	-12.3			
	50	24	20.5	20.8	33.0	-12.2			
	50	50	20.4	20.7	33.0	-12.3			
	100	0	20.4	20.7	33.0	-12.3			
	100	0	20.4	20.7	33.0	-12.3			

Antenna gain (dBi)		0.30							
Bandwidth	UL Channel	-1.5	Modulation	RB Size	RB Offset	Conducted Average (dBm)	EIRP Average (dBm)	EIRP Limit (dBm)	Margin (dB)
20.0	41490	2680.0	QPSK	1	0	20.3	20.6	33.0	-12.4
				1	49	20.1	20.4	33.0	-12.6
				1	99	20.1	20.4	33.0	-12.6
				50	0	20.2	20.5	33.0	-12.5
				50	24	20.4	20.7	33.0	-12.3
				50	50	20.4	20.7	33.0	-12.4
				100	0	20.4	20.7	33.0	-12.4
			16QAM	1	0	20.7	21.0	33.0	-12.0
				1	49	20.5	20.8	33.0	-12.2
				1	99	20.4	20.7	33.0	-12.3
				50	0	20.5	20.8	33.0	-12.2
				50	24	20.4	20.7	33.0	-12.3
				50	50	20.4	20.7	33.0	-12.3
				100	0	20.4	20.7	33.0	-12.3
			64QAM	1	0	20.0	20.3	33.0	-12.7
				1	49	19.9	20.2	33.0	-12.8
				1	99	19.8	20.1	33.0	-12.9
				50	0	20.2	20.5	33.0	-12.5
				50	24	20.4	20.7	33.0	-12.3
				50	50	20.3	20.6	33.0	-12.4
				100	0	20.3	20.6	33.0	-12.4

**LTE Band 66**

Antenna gain (dBi)		2.10							
Bandwidth	UL Channel	Frequency (MHz)	Modulation	RB Size	RB Offset	Conducted Average (dBm)	EIRP Average (dBm)	EIRP Limit (dBm)	Margin (dB)
1.4	131979	1710.7	QPSK	1	0	24.1	26.2	33.0	-6.8
				1	3	24.1	26.2	33.0	-6.8
				1	5	24.1	26.2	33.0	-6.8
				3	0	24.1	26.2	33.0	-6.8
				3	1	24.2	26.3	33.0	-6.7
				3	3	24.2	26.3	33.0	-6.7
			16QAM	6	0	23.2	25.3	33.0	-7.7
				1	0	23.2	25.3	33.0	-7.7
				1	3	23.2	25.3	33.0	-7.7
				1	5	23.2	25.3	33.0	-7.7
				3	0	23.4	25.5	33.0	-7.6
				3	1	23.4	25.5	33.0	-7.5
	132322	1745.0	QPSK	3	3	23.4	25.5	33.0	-7.5
				6	0	22.4	24.5	33.0	-8.5
				1	0	24.0	26.1	33.0	-6.9
				1	3	24.1	26.2	33.0	-6.8
				1	5	24.0	26.1	33.0	-6.9
				3	0	24.0	26.1	33.0	-6.9
			16QAM	3	1	24.1	26.2	33.0	-6.8
				3	3	24.1	26.2	33.0	-6.8
				6	0	23.1	25.2	33.0	-7.8
				1	0	23.1	25.2	33.0	-7.8
				1	3	23.1	25.2	33.0	-7.8
				1	5	23.1	25.2	33.0	-7.8
	132665	1779.3	QPSK	3	0	23.2	25.3	33.0	-7.7
				3	1	23.3	25.4	33.0	-7.6
				3	3	23.3	25.4	33.0	-7.6
				6	0	22.3	24.4	33.0	-8.6
				1	0	24.2	26.3	33.0	-6.8
				1	3	24.2	26.3	33.0	-6.7
			16QAM	1	5	24.1	26.2	33.0	-6.8
				3	0	24.1	26.2	33.0	-6.8
				3	1	24.1	26.2	33.0	-6.8
				3	3	24.1	26.2	33.0	-6.8
				6	0	23.1	25.2	33.0	-7.8
				1	0	23.2	25.3	33.0	-7.7
Page 91 of 269									

Antenna gain (dBi)		2.10							
Bandwidth	UL Channel	Frequency (MHz)	Modulation	RB Size	RB Offset	Conducted Average (dBm)	EIRP Average (dBm)	EIRP Limit (dBm)	Margin (dB)
3.0	131987	1711.5	QPSK	1	0	24.2	26.3	33.0	-6.7
				1	8	24.3	26.4	33.0	-6.6
				1	14	24.2	26.3	33.0	-6.7
				8	0	23.3	25.4	33.0	-7.6
				8	4	23.3	25.4	33.0	-7.6
				8	7	23.3	25.4	33.0	-7.6
			16QAM	15	0	23.3	25.4	33.0	-7.6
				1	0	23.3	25.4	33.0	-7.6
				1	8	23.4	25.5	33.0	-7.5
				1	14	23.3	25.4	33.0	-7.7
				8	0	22.4	24.5	33.0	-8.5
				8	4	22.4	24.5	33.0	-8.5
	132322	1745.0	QPSK	8	7	22.4	24.5	33.0	-8.5
				8	0	22.3	24.4	33.0	-8.6
				1	0	24.0	26.1	33.0	-6.9
				1	8	24.1	26.2	33.0	-6.8
				1	14	24.0	26.1	33.0	-6.9
				8	0	23.1	25.2	33.0	-7.9
			16QAM	8	4	23.1	25.2	33.0	-7.9
				8	7	23.0	25.1	33.0	-7.9
				15	0	23.0	25.1	33.0	-7.9
				1	0	23.1	25.2	33.0	-7.8
				1	8	23.2	25.3	33.0	-7.7
				1	14	23.1	25.2	33.0	-7.9
	132657	1778.5	QPSK	8	0	22.1	24.2	33.0	-8.8
				8	4	22.1	24.2	33.0	-8.8
				8	7	22.1	24.2	33.0	-8.8
				15	0	22.0	24.1	33.0	-8.9
				1	0	24.1	26.2	33.0	-6.9
				1	8	24.2	26.3	33.0	-6.7
16QAM			1	14	24.1	26.2	33.0	-6.9	
			8	0	23.1	25.2	33.0	-7.8	
			8	4	23.1	25.2	33.0	-7.8	
			8	7	23.1	25.2	33.0	-7.8	
			15	0	23.1	25.2	33.0	-7.8	
			1	0	23.0	25.1	33.0	-7.9	
Page 92 of 269									

Antenna gain (dBi)		2.10							
Bandwidth	UL Channel	Frequency (MHz)	Modulation	RB Size	RB Offset	Conducted Average (dBm)	EIRP Average (dBm)	EIRP Limit (dBm)	Margin (dB)
5.0	131997	1712.5	QPSK	1	0	24.3	26.4	33.0	-6.6
				1	12	24.4	26.5	33.0	-6.5
				1	24	24.4	26.5	33.0	-6.5
				12	0	23.4	25.5	33.0	-7.5
				12	7	23.4	25.5	33.0	-7.5
				12	13	23.3	25.4	33.0	-7.6
			16QAM	25	0	23.4	25.5	33.0	-7.5
				1	0	23.5	25.6	33.0	-7.4
				1	12	23.5	25.6	33.0	-7.4
				1	24	23.4	25.5	33.0	-7.5
				12	0	22.5	24.6	33.0	-8.5
				12	7	22.4	24.5	33.0	-8.5
	132322	1745.0	QPSK	12	13	22.4	24.5	33.0	-8.5
				25	0	22.3	24.4	33.0	-8.6
				1	0	24.2	26.3	33.0	-6.7
				1	12	24.2	26.3	33.0	-6.7
				1	24	24.1	26.2	33.0	-6.8
				12	0	23.2	25.3	33.0	-7.7
			16QAM	12	7	23.1	25.2	33.0	-7.8
				12	13	23.1	25.2	33.0	-7.8
				25	0	23.1	25.2	33.0	-7.8
				1	0	23.3	25.4	33.0	-7.7
				1	12	23.2	25.3	33.0	-7.7
				1	24	23.2	25.3	33.0	-7.7
	132647	1777.5	QPSK	12	0	22.2	24.3	33.0	-8.7
				12	7	22.2	24.3	33.0	-8.7
				12	13	22.2	24.3	33.0	-8.7
				25	0	22.1	24.2	33.0	-8.8
				1	0	23.9	26.0	33.0	-7.0
				1	12	24.1	26.2	33.0	-6.8
			16QAM	1	24	24.1	26.2	33.0	-6.8
				12	0	23.0	25.1	33.0	-7.9
				12	7	23.0	25.1	33.0	-7.9
				12	13	23.0	25.1	33.0	-7.9
				25	0	23.1	25.2	33.0	-7.8
				1	0	23.0	25.1	33.0	-7.9
16QAM	1	12	23.2	25.3	33.0	-7.7			
	1	24	23.3	25.4	33.0	-7.7			
	12	0	22.1	24.2	33.0	-8.8			
	12	7	22.2	24.3	33.0	-8.8			
	12	13	22.2	24.3	33.0	-8.8			
	25	0	22.1	24.2	33.0	-8.8			

Antenna gain (dBi)		2.10							
Bandwidth	UL Channel	Frequency (MHz)	Modulation	RB Size	RB Offset	Conducted Average (dBm)	EIRP Average (dBm)	EIRP Limit (dBm)	Margin (dB)
10.0	132022	1715.0	QPSK	1	0	24.3	26.4	33.0	-6.6
				1	25	24.3	26.4	33.0	-6.6
				1	49	24.4	26.5	33.0	-6.5
				25	0	23.5	25.6	33.0	-7.5
				25	12	23.5	25.6	33.0	-7.5
				25	25	23.4	25.5	33.0	-7.5
			16QAM	50	0	23.4	25.5	33.0	-7.5
				1	0	23.4	25.5	33.0	-7.5
				1	25	23.4	25.5	33.0	-7.5
				1	49	23.5	25.6	33.0	-7.4
				25	0	22.6	24.7	33.0	-8.3
				25	12	22.5	24.6	33.0	-8.4
	132322	1745.0	QPSK	25	25	22.5	24.6	33.0	-8.4
				50	0	22.5	24.6	33.0	-8.4
				1	0	24.3	26.4	33.0	-6.7
				1	25	24.1	26.2	33.0	-6.8
				1	49	24.1	26.2	33.0	-6.8
				25	0	23.3	25.4	33.0	-7.7
			16QAM	25	12	23.2	25.3	33.0	-7.7
				25	25	23.1	25.2	33.0	-7.8
				50	0	23.3	25.4	33.0	-7.7
				1	0	23.3	25.4	33.0	-7.6
				1	25	23.2	25.3	33.0	-7.7
				1	49	23.1	25.2	33.0	-7.8
	132622	1775.0	QPSK	25	0	22.4	24.5	33.0	-8.5
				25	12	22.3	24.4	33.0	-8.6
				25	25	22.3	24.4	33.0	-8.6
				50	0	22.3	24.4	33.0	-8.6
				1	0	24.4	26.5	33.0	-6.6
				1	25	24.1	26.2	33.0	-6.8
			16QAM	1	49	23.8	25.9	33.0	-7.1
				25	0	23.3	25.4	33.0	-7.6
				25	12	23.3	25.4	33.0	-7.6
				25	25	23.1	25.2	33.0	-7.8
				50	0	23.2	25.3	33.0	-7.7
				1	0	23.3	25.4	33.0	-7.6
				1	25	23.1	25.2	33.0	-7.8
				1	49	22.7	24.8	33.0	-8.3
				25	0	22.4	24.5	33.0	-8.5
				25	12	22.3	24.4	33.0	-8.6
				25	25	22.2	24.3	33.0	-8.8
				50	0	22.2	24.3	33.0	-8.7

Antenna gain (dBi)		2.10							
Bandwidth	UL Channel	Frequency (MHz)	Modulation	RB Size	RB Offset	Conducted Average (dBm)	EIRP Average (dBm)	EIRP Limit (dBm)	Margin (dB)
15.0	132047	1717.5	QPSK	1	0	24.3	26.4	33.0	-6.6
				1	37	24.4	26.5	33.0	-6.5
				1	74	24.4	26.5	33.0	-6.5
				36	0	23.4	25.5	33.0	-7.5
				36	20	23.4	25.5	33.0	-7.5
				36	39	23.4	25.5	33.0	-7.5
			75	0	23.4	25.5	33.0	-7.5	
			16QAM	1	0	23.6	25.7	33.0	-7.3
				1	37	23.8	25.9	33.0	-7.2
				1	74	23.8	25.9	33.0	-7.1
				36	0	22.5	24.6	33.0	-8.4
				36	20	22.5	24.6	33.0	-8.4
	36	39		22.5	24.6	33.0	-8.4		
	132322	1745.0	QPSK	1	0	24.4	26.5	33.0	-6.5
				1	37	24.1	26.2	33.0	-6.8
				1	74	24.1	26.2	33.0	-6.8
				36	0	23.3	25.4	33.0	-7.6
				36	20	23.3	25.4	33.0	-7.6
				36	39	23.2	25.3	33.0	-7.7
			75	0	23.2	25.3	33.0	-7.7	
			16QAM	1	0	23.3	25.4	33.0	-7.6
				1	37	23.1	25.2	33.0	-7.8
				1	74	23.0	25.1	33.0	-7.9
				36	0	22.3	24.4	33.0	-8.6
				36	20	22.3	24.4	33.0	-8.6
	36	39		22.2	24.3	33.0	-8.7		
	132572	1772.5	QPSK	1	0	24.5	26.6	33.0	-6.4
				1	37	24.2	26.3	33.0	-6.7
				1	74	24.2	26.3	33.0	-6.7
				36	0	23.4	25.5	33.0	-7.6
36				20	23.3	25.4	33.0	-7.6	
36				39	23.2	25.3	33.0	-7.7	
75			0	23.3	25.4	33.0	-7.6		
16QAM			1	0	23.5	25.6	33.0	-7.5	
			1	37	23.0	25.1	33.0	-7.9	
			1	74	23.2	25.3	33.0	-7.7	
			36	0	22.4	24.5	33.0	-8.5	
			36	20	22.3	24.4	33.0	-8.6	
	36	39	22.2	24.3	33.0	-8.7			
75	0	22.3	24.4	33.0	-8.6				

Antenna gain (dBi)		2.10							
Bandwidth	UL Channel	Frequency (MHz)	Modulation	RB Size	RB Offset	Conducted Average (dBm)	EIRP Average (dBm)	EIRP Limit (dBm)	Margin (dB)
20.0	132072	1720.0	QPSK	1	0	24.3	26.4	33.0	-6.6
				1	49	24.2	26.3	33.0	-6.7
				1	99	24.0	26.1	33.0	-6.9
				50	0	23.3	25.4	33.0	-7.6
				50	24	23.2	25.3	33.0	-7.7
				50	50	23.1	25.2	33.0	-7.8
			100	0	23.2	25.3	33.0	-7.7	
			16QAM	1	0	23.7	25.8	33.0	-7.2
				1	49	23.6	25.7	33.0	-7.3
				1	99	23.4	25.5	33.0	-7.5
				50	0	22.3	24.4	33.0	-8.6
				50	24	22.2	24.3	33.0	-8.7
	50	50		22.1	24.2	33.0	-8.8		
	132322	1745.0	QPSK	1	0	24.3	26.4	33.0	-6.6
				1	49	24.1	26.2	33.0	-6.8
				1	99	24.1	26.2	33.0	-6.8
				50	0	23.3	25.4	33.0	-7.6
				50	24	23.2	25.3	33.0	-7.7
				50	50	23.1	25.2	33.0	-7.8
			100	0	23.2	25.3	33.0	-7.7	
			16QAM	1	0	23.8	25.9	33.0	-7.1
				1	49	23.7	25.8	33.0	-7.2
				1	99	23.6	25.7	33.0	-7.3
				50	0	22.3	24.4	33.0	-8.6
				50	24	22.2	24.3	33.0	-8.7
	50	50		22.2	24.3	33.0	-8.7		
	132572	1770.0	QPSK	1	0	24.4	26.5	33.0	-6.5
				1	49	24.1	26.2	33.0	-6.8
				1	99	24.1	26.2	33.0	-6.8
				50	0	23.2	25.3	33.0	-7.7
50				24	23.1	25.2	33.0	-7.8	
50				50	23.1	25.2	33.0	-7.8	
100			0	23.2	25.3	33.0	-7.7		
16QAM			1	0	23.9	26.0	33.0	-7.0	
			1	49	23.6	25.7	33.0	-7.3	
			1	99	23.6	25.7	33.0	-7.3	
			50	0	22.3	24.4	33.0	-8.6	
			50	24	22.2	24.3	33.0	-8.7	
	50	50	22.1	24.2	33.0	-8.8			
100	0	22.2	24.3	33.0	-8.7				



## 12. PEAK TO AVERAGE RATIO

### TEST PROCEDURE

Per KDB 971168 D01 Power Meas License Digital Systems v02r02

### TEST SPEC

In addition, when the transmitter power is measured in terms of average value, the peak-to-average ratio of the power shall not exceed 13 dB.

## 12.1. CONDUCTED PEAK TO AVERAGE RESULT

### GSM

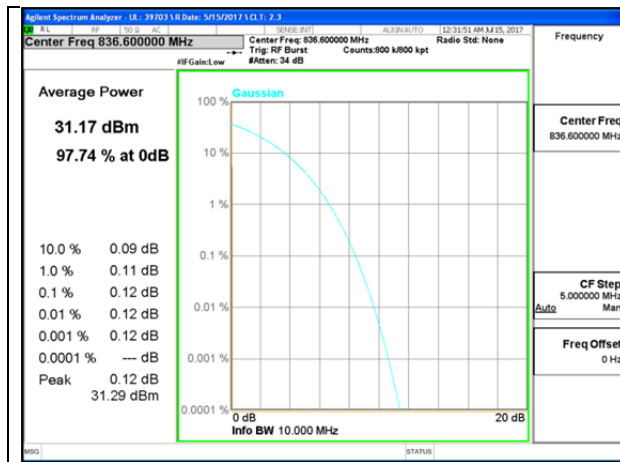

GSM850 GPRS Middle Channel

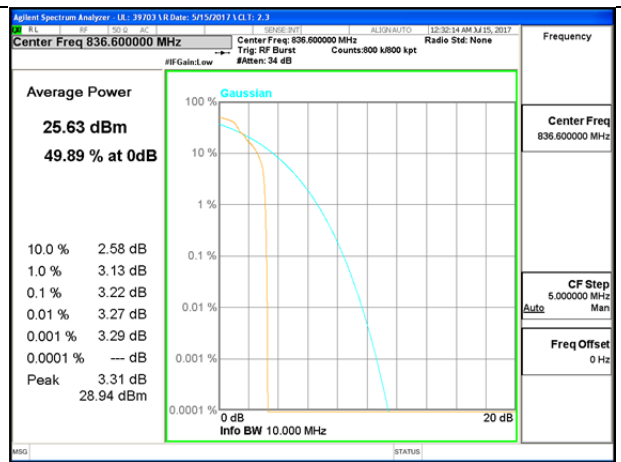

GSM850 EGPRS Middle Channel

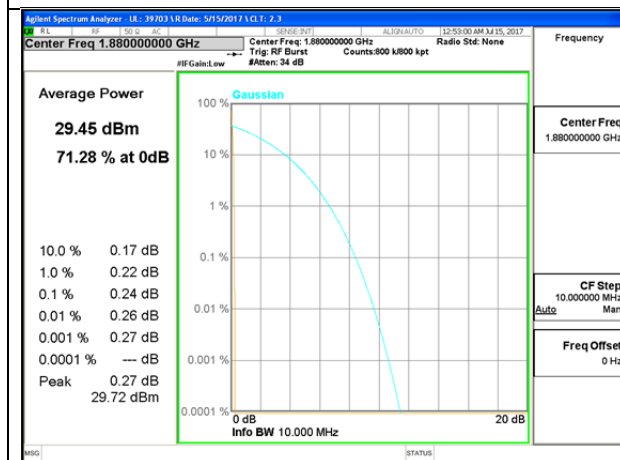

GSM1900 GPRS Middle Channel

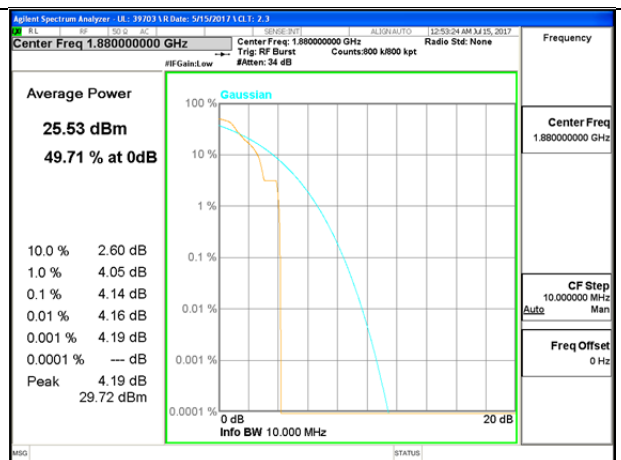

GSM1900 EGPRS Middle Channel

**WCDMA**

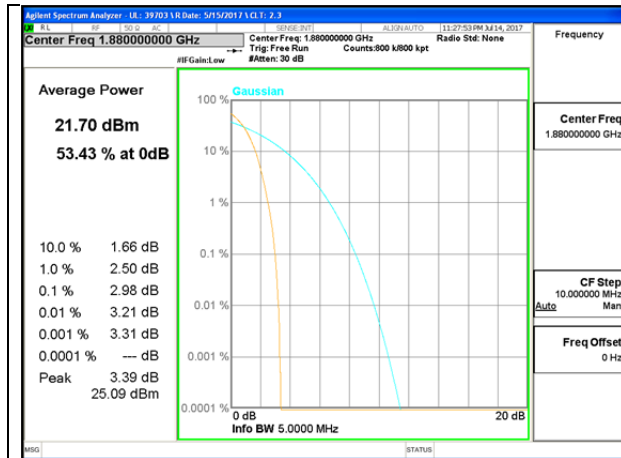

B2 REL99

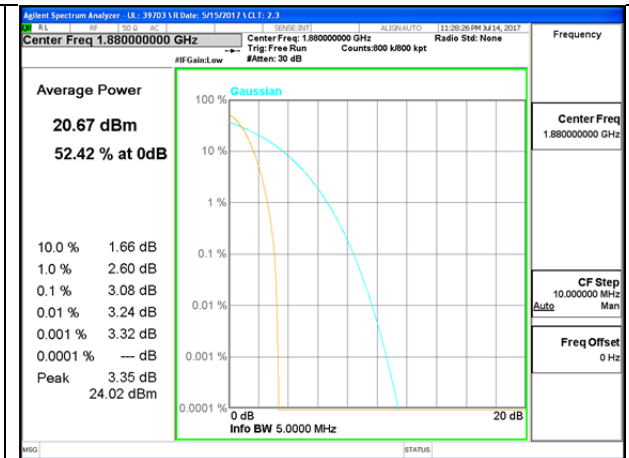

B2 HSDPA

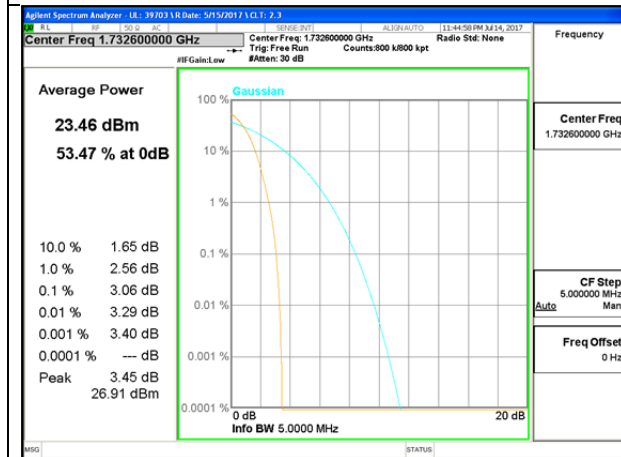

B4 REL99

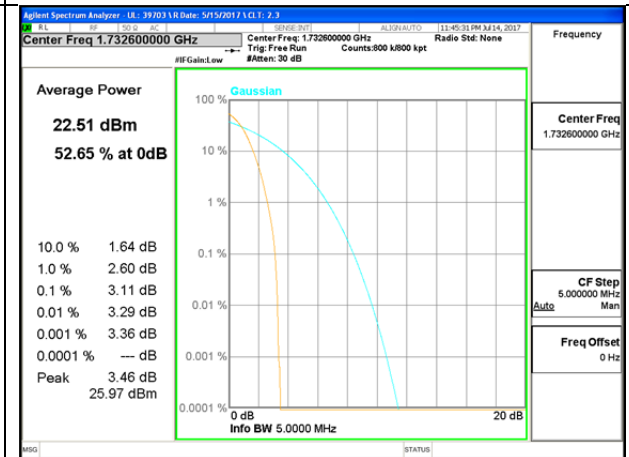

B4 HSDPA

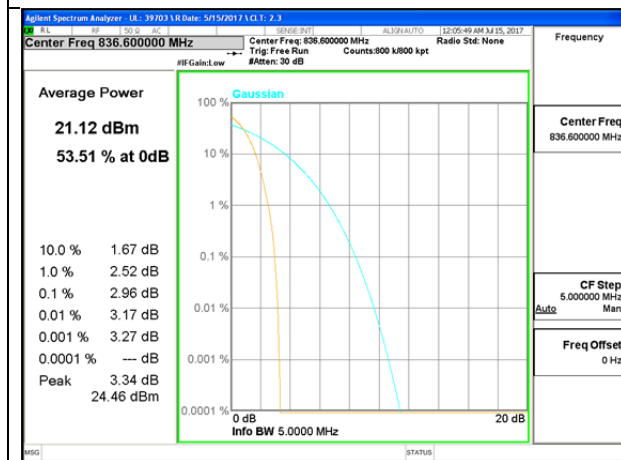

B5 REL99

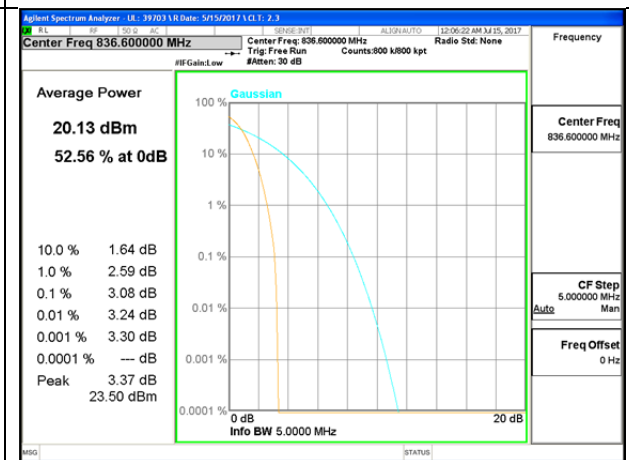

B5 HSDPA

**LTE Band 2**

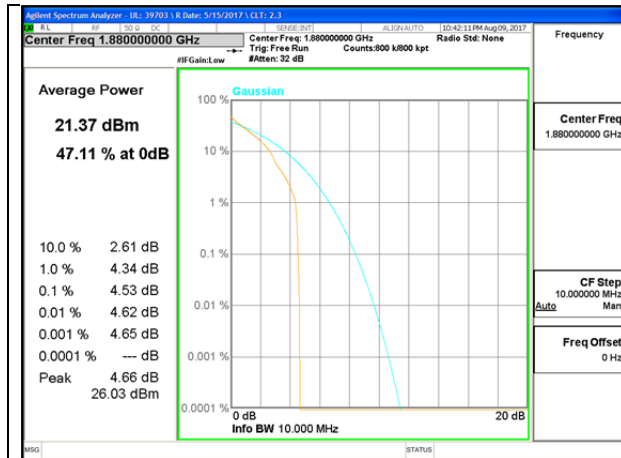

LTE B2 1.4MHz QPSK Middle Channel

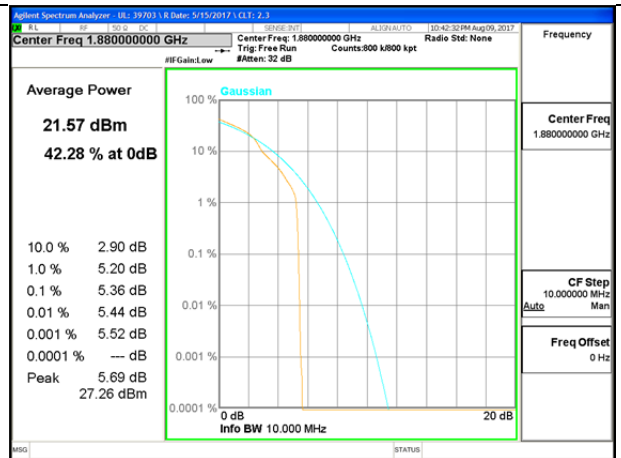

LTE B2 1.4MHz 16QAM Middle Channel

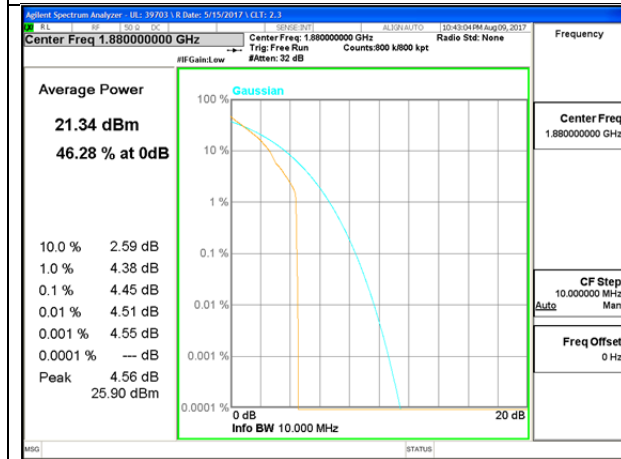

LTE B2 3MHz QPSK Middle Channel

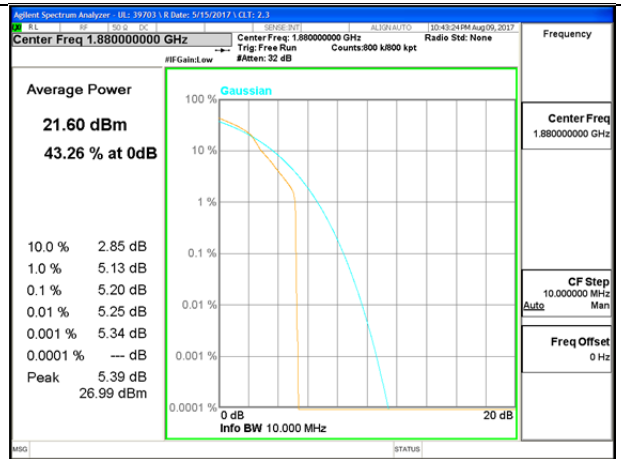

LTE B2 3MHz 16QAM Middle Channel

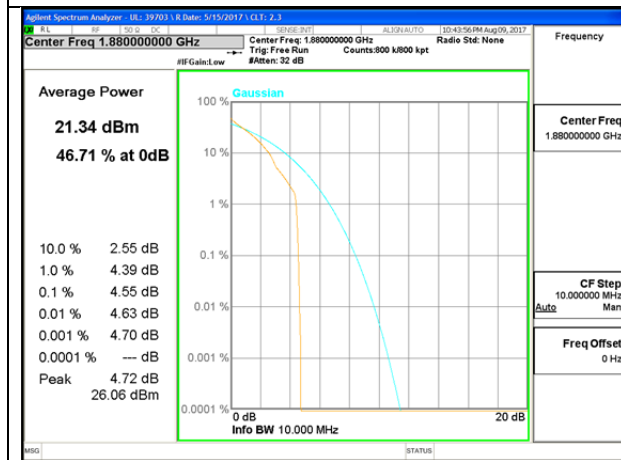

LTE B2 5MHz QPSK Middle Channel

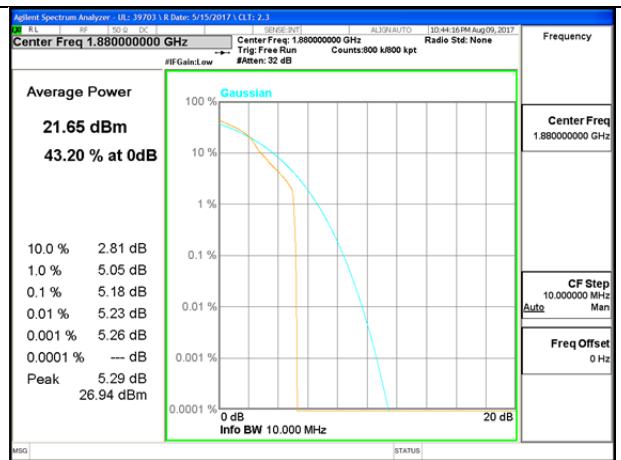

LTE B2 5MHz 16QAM Middle Channel

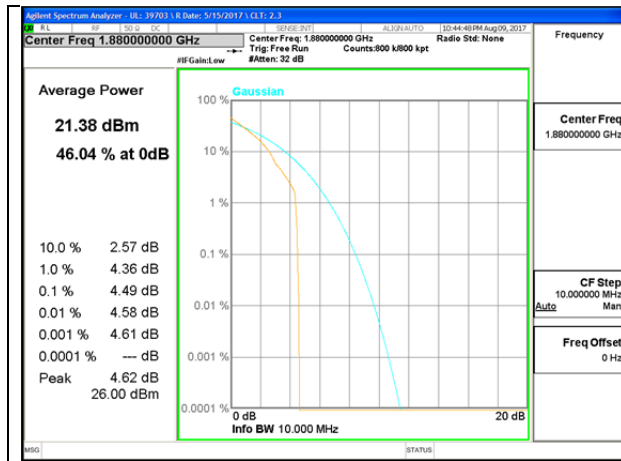

LTE B2 10MHz QPSK Middle Channel

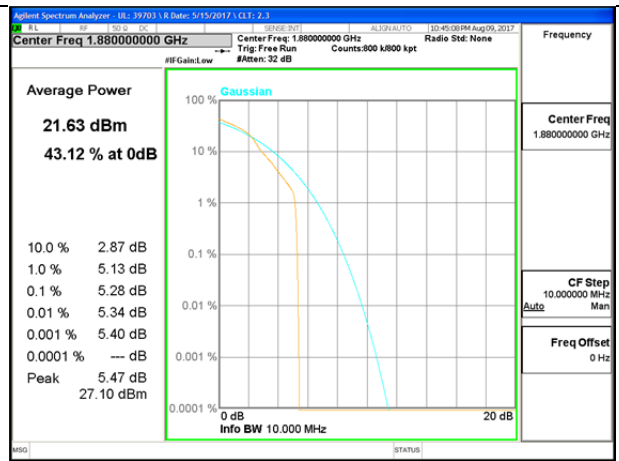

LTE B2 10MHz 16QAM Middle Channel

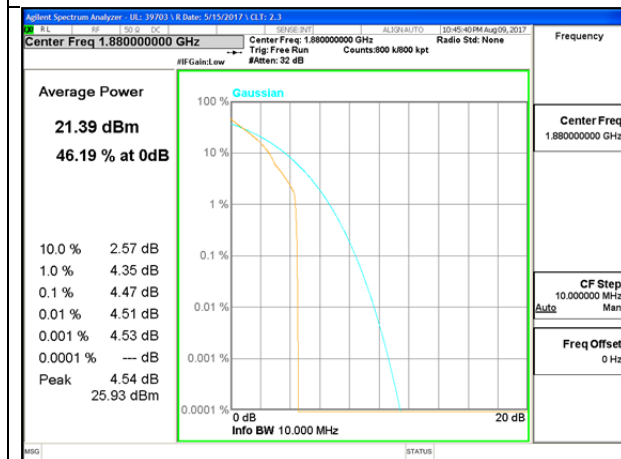

LTE B2 15MHz QPSK Middle Channel



LTE B2 15MHz 16QAM Middle Channel

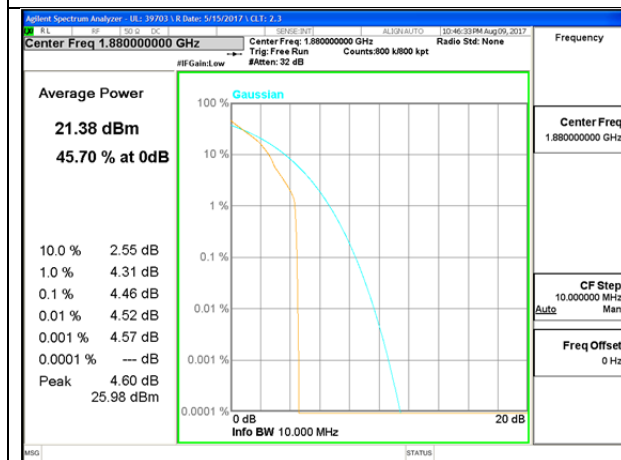

LTE B2 20MHz QPSK Middle Channel



LTE B2 20MHz 16QAM Middle Channel

**LTE Band 7**

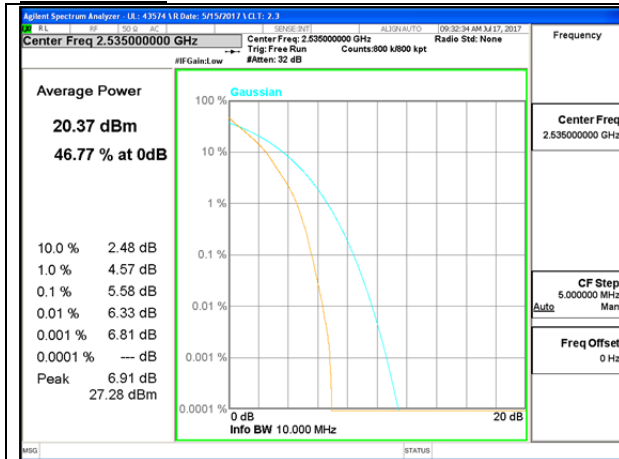

LTE B7 5MHz QPSK Middle Channel

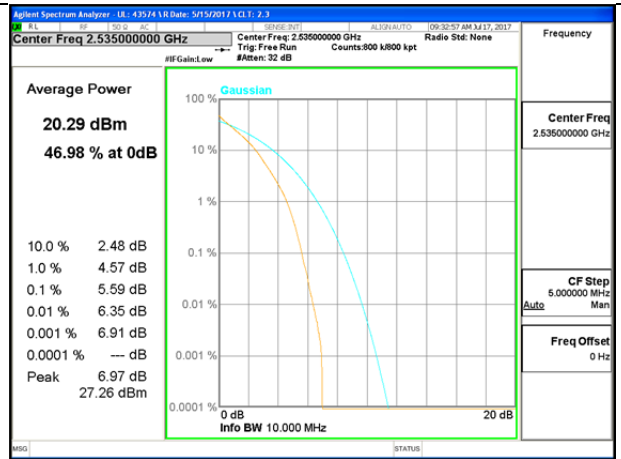

LTE B7 5MHz 16QAM Middle Channel

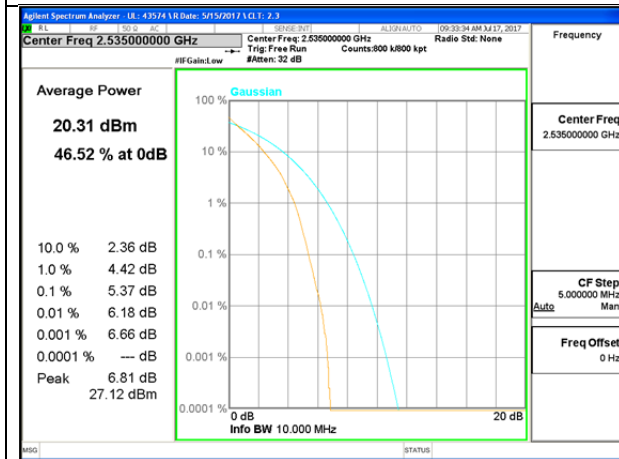

LTE B7 10MHz QPSK Middle Channel

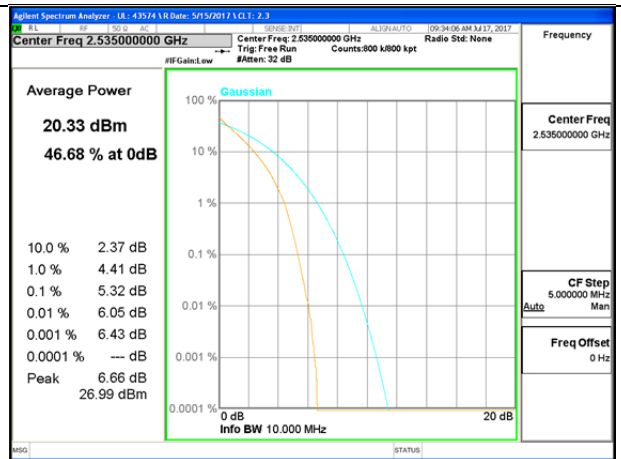

LTE B7 10MHz 16QAM Middle Channel

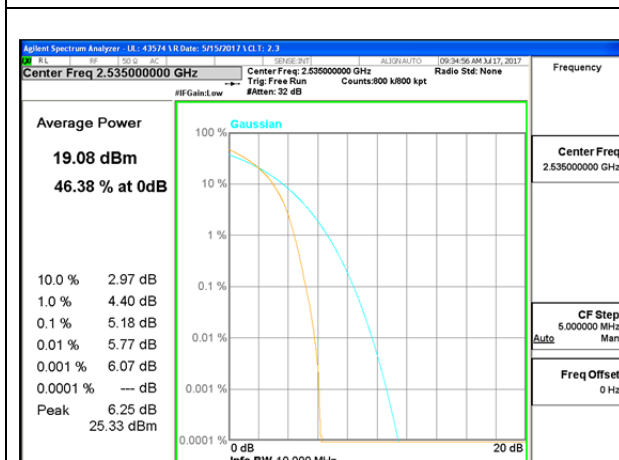

LTE B7 15MHz QPSK Middle Channel

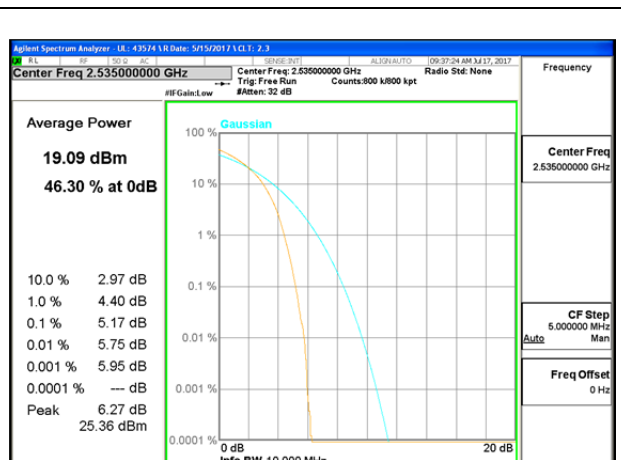

LTE B7 15MHz 16QAM Middle Channel

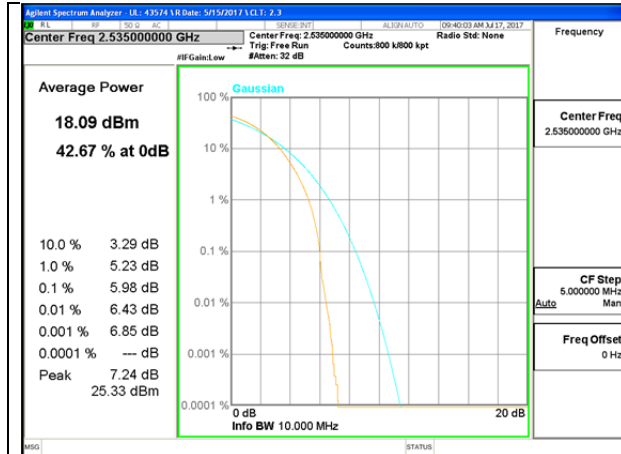

LTE B7 20MHz QPSK Middle Channel

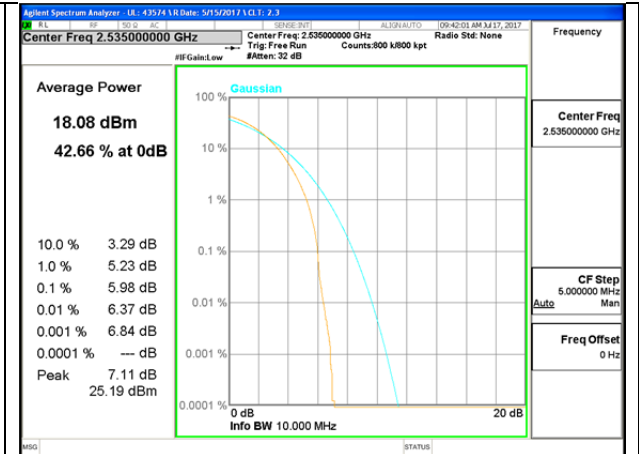

LTE B7 20MHz 16QAM Middle Channel

**LTE Band 12**

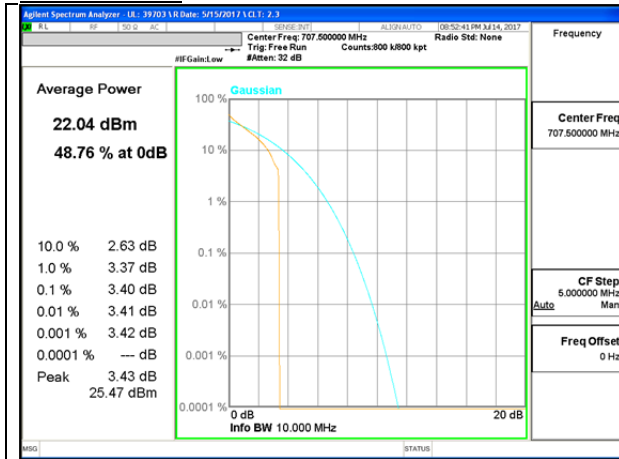

LTE B12 1.4MHz QPSK Middle Channel

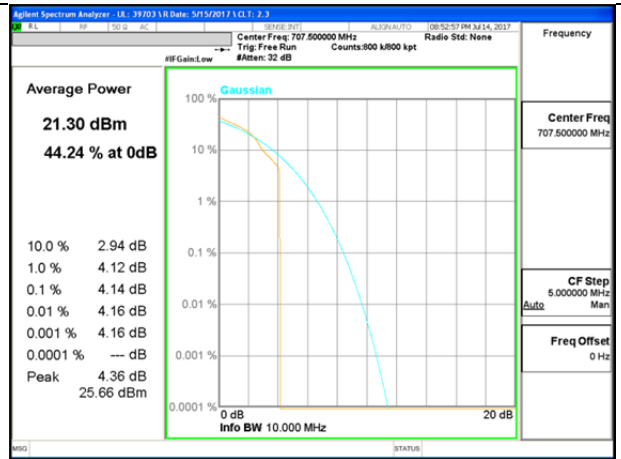

LTE B12 1.4MHz 16QAM Middle Channel



LTE B12 3MHz QPSK Middle Channel

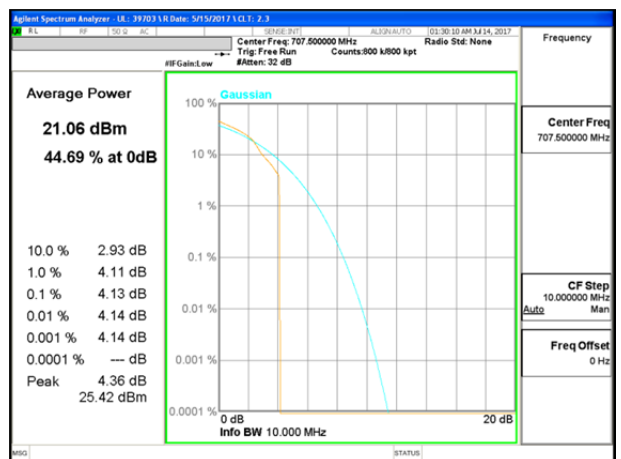

LTE B12 3MHz 16QAM Middle Channel

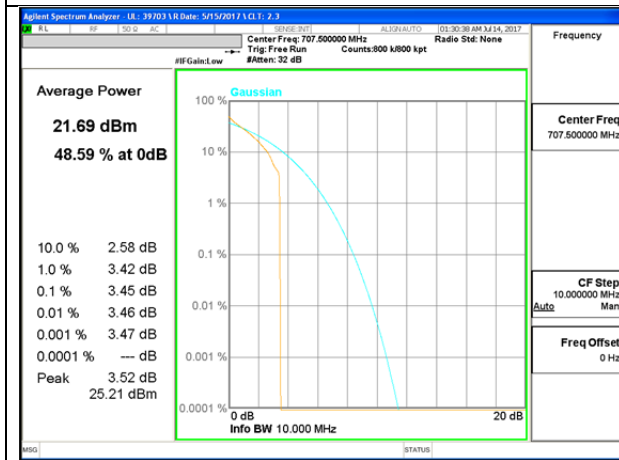

LTE B12 5MHz QPSK Middle Channel

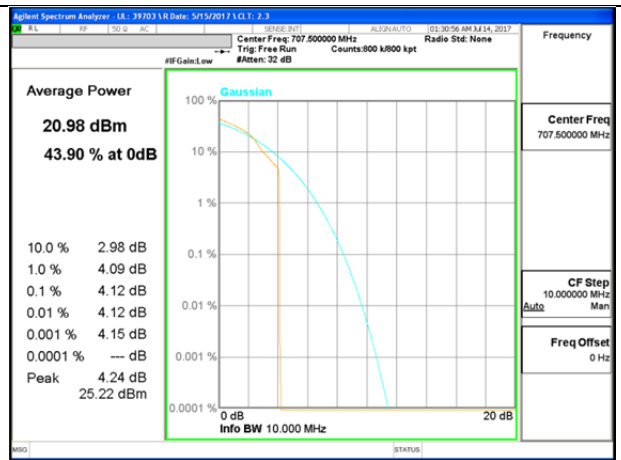

LTE B12 5MHz 16QAM Middle Channel



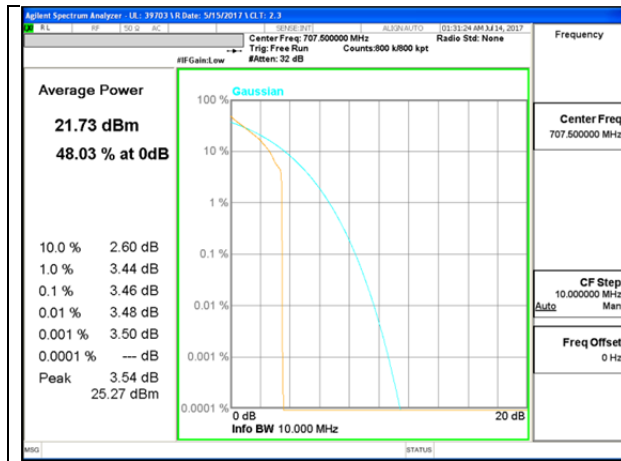

LTE B12 10MHz QPSK Middle Channel

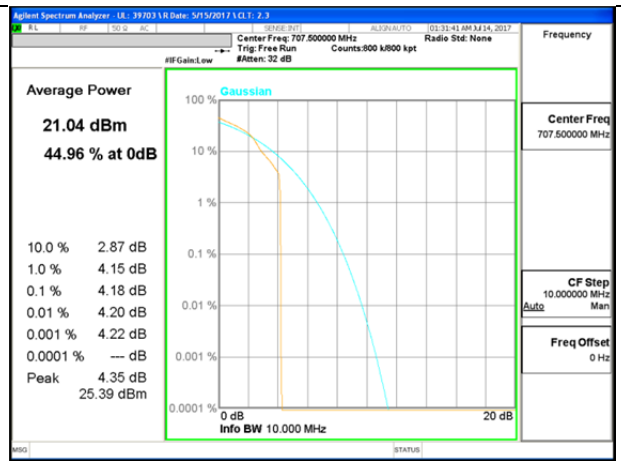

LTE B12 10MHz 16QAM Middle Channel

**LTE Band 13**

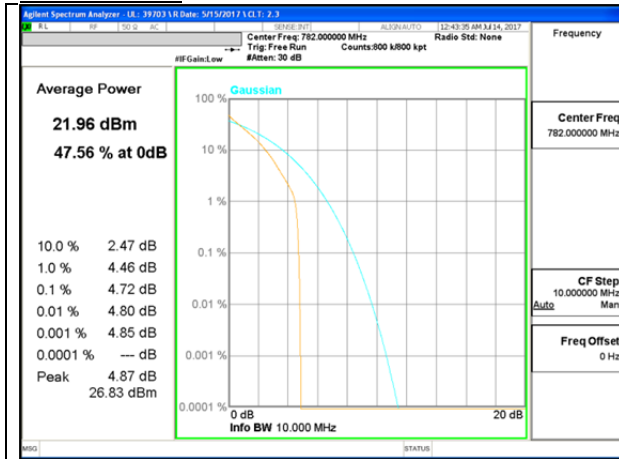

LTE B13 5MHz QPSK Middle Channel

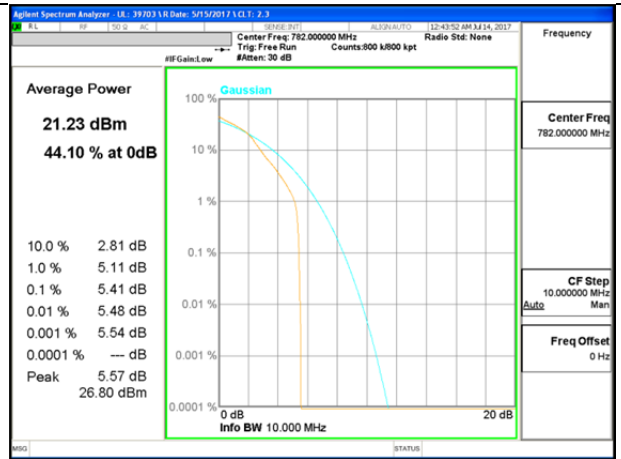

LTE B13 5MHz 16QAM Middle Channel

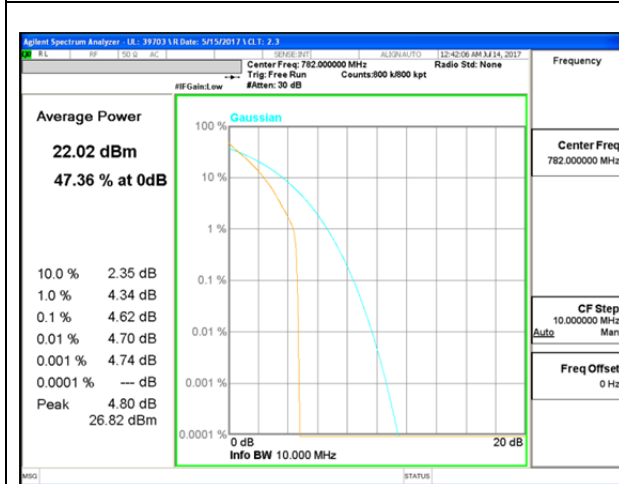

LTE B13 10MHz QPSK Middle Channel

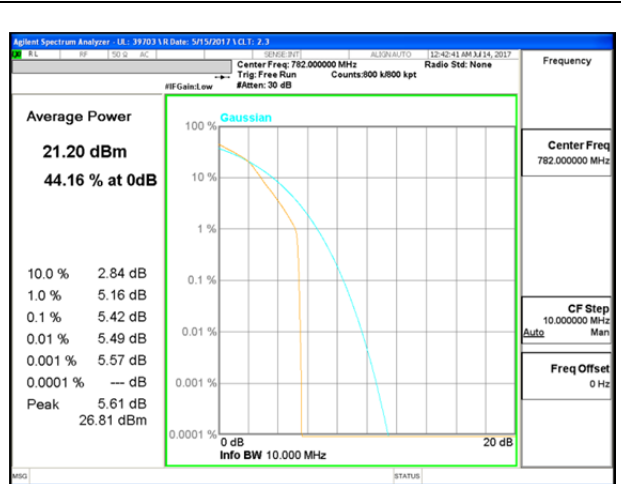

LTE B13 10MHz 16QAM Middle Channel

**LTE Band 25**

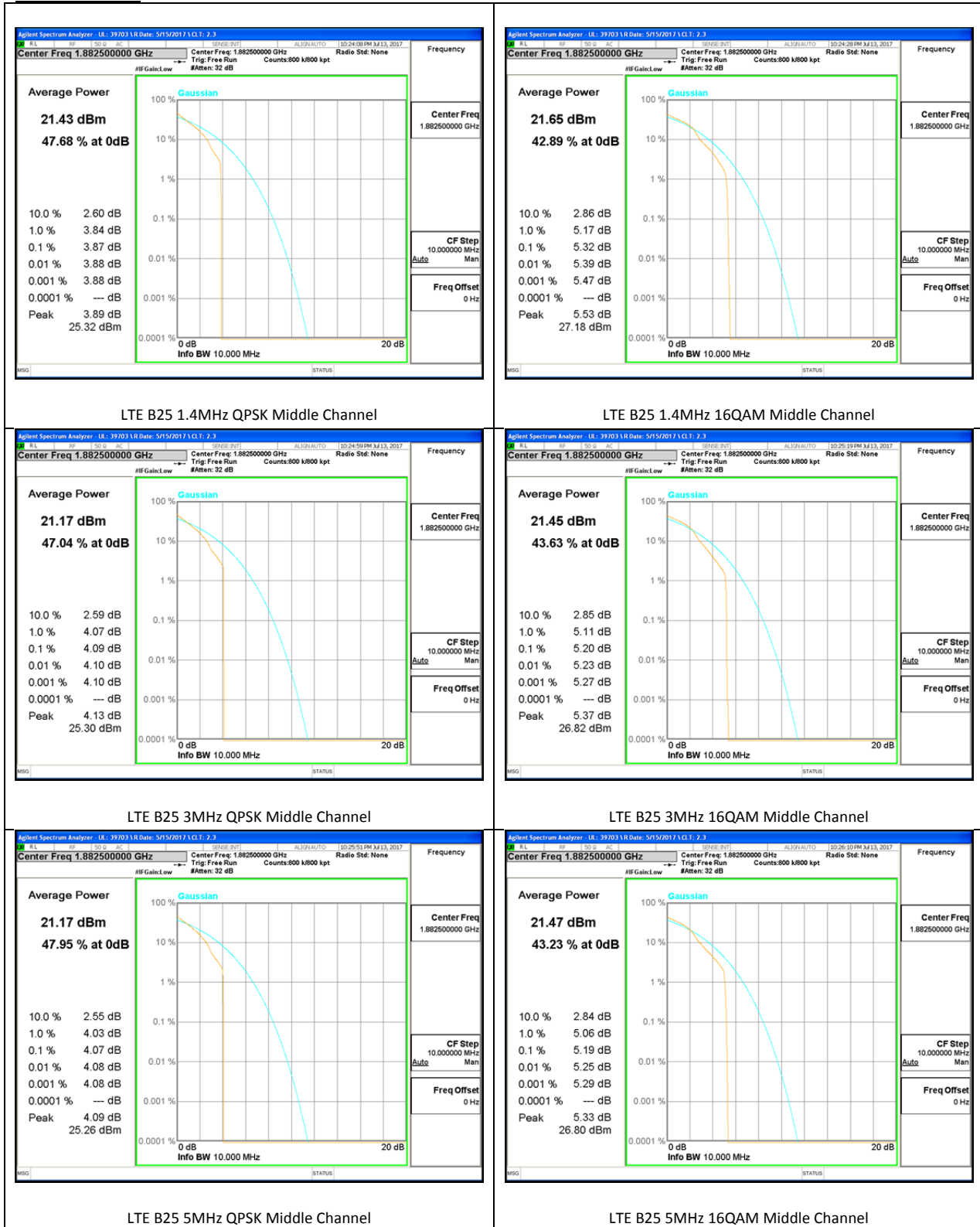

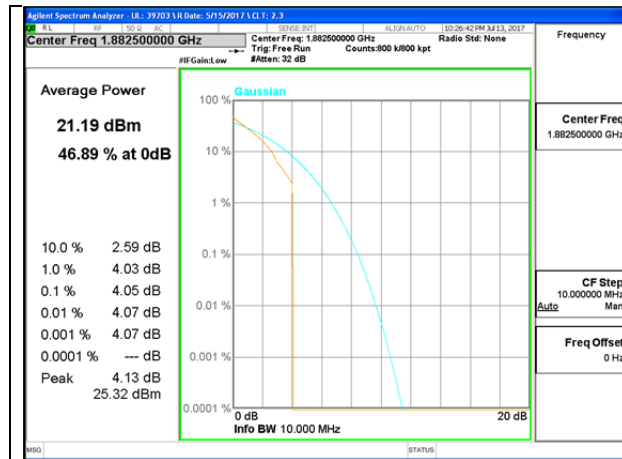

LTE B25 10MHz QPSK Middle Channel

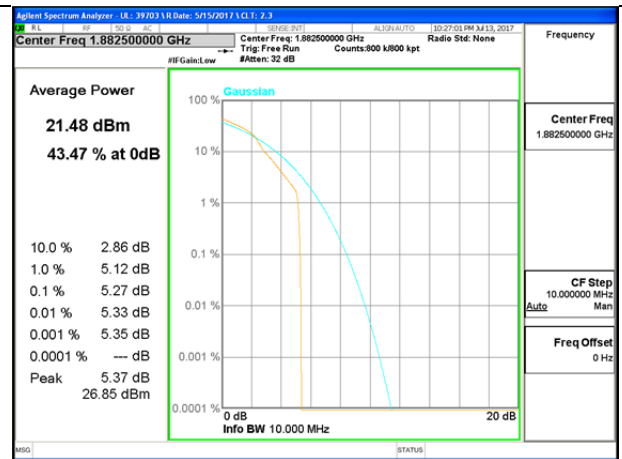

LTE B25 10MHz 16QAM Middle Channel

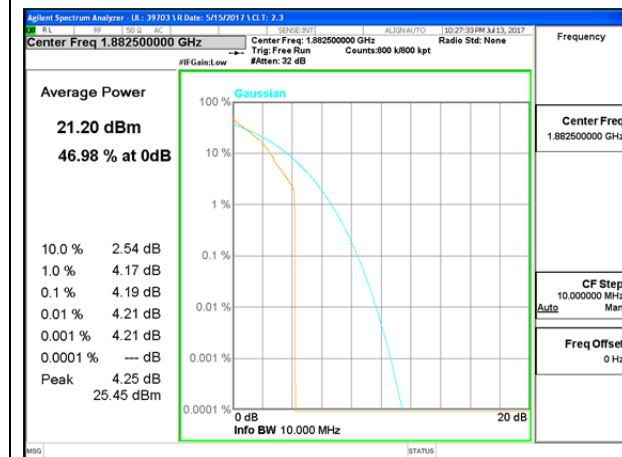

LTE B25 15MHz QPSK Middle Channel

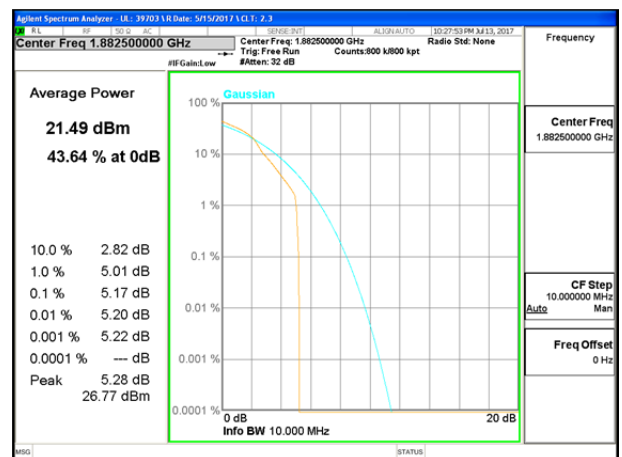

LTE B25 15MHz 16QAM Middle Channel

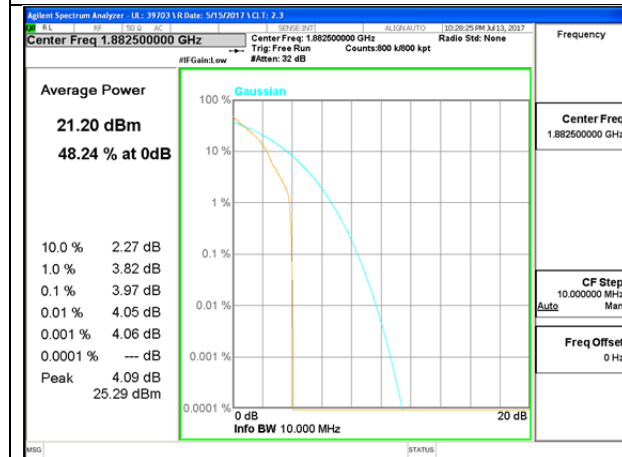

LTE B25 20MHz QPSK Middle Channel

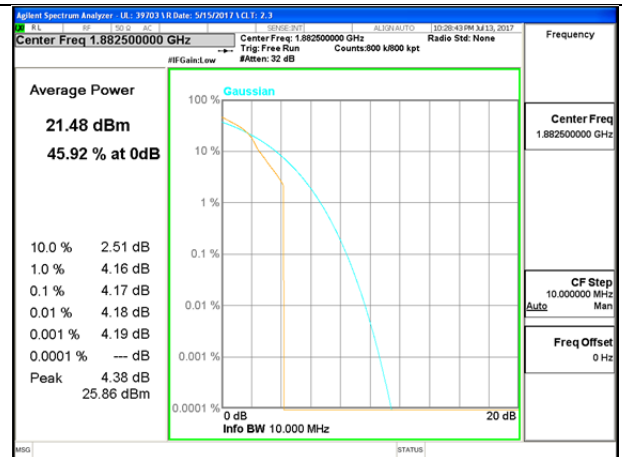

LTE B25 20MHz 16QAM Middle Channel

**LTE Band 26**

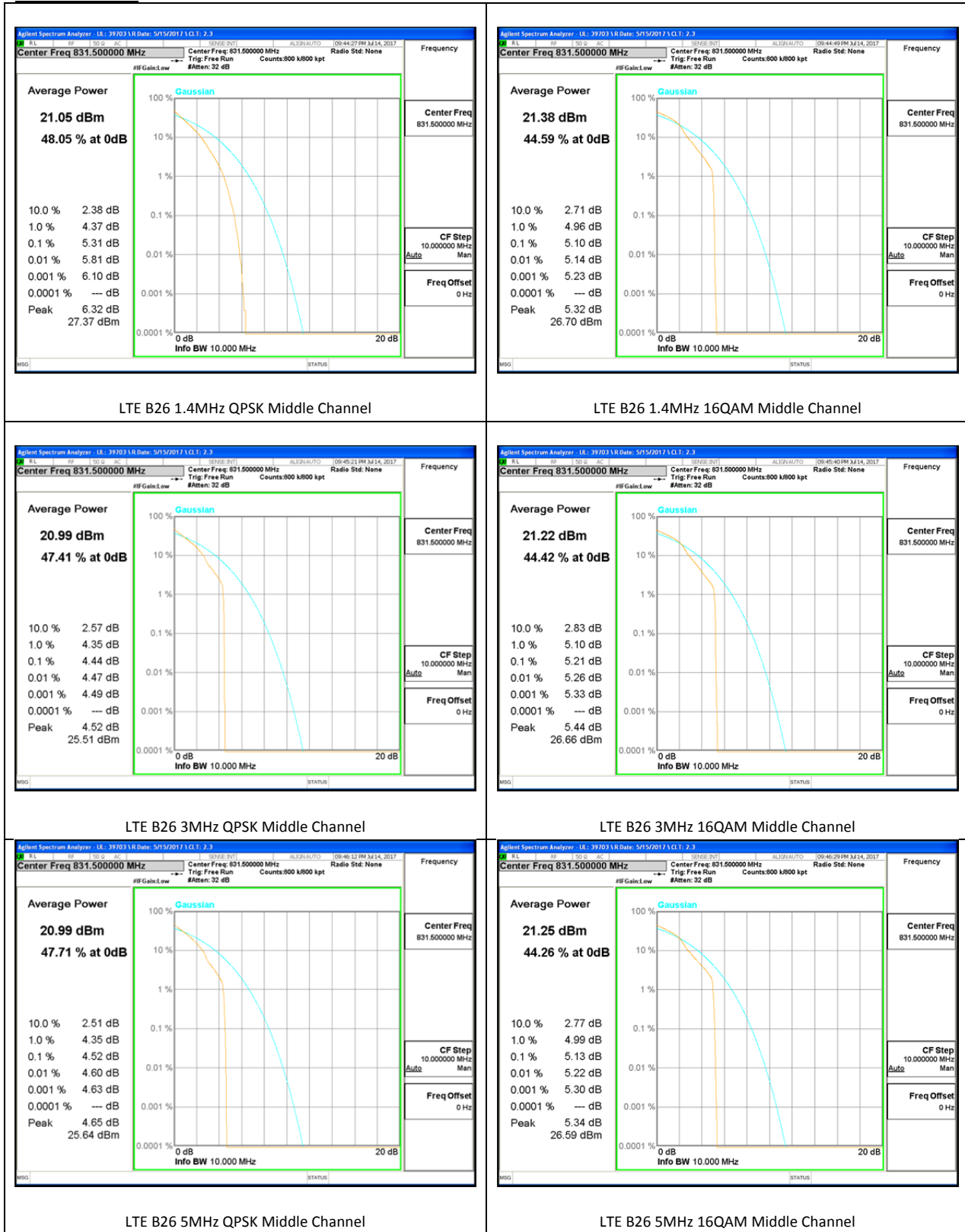

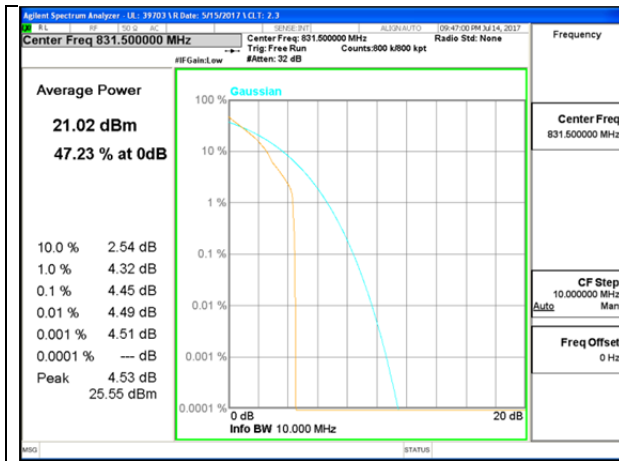

LTE B26 10MHz QPSK Middle Channel

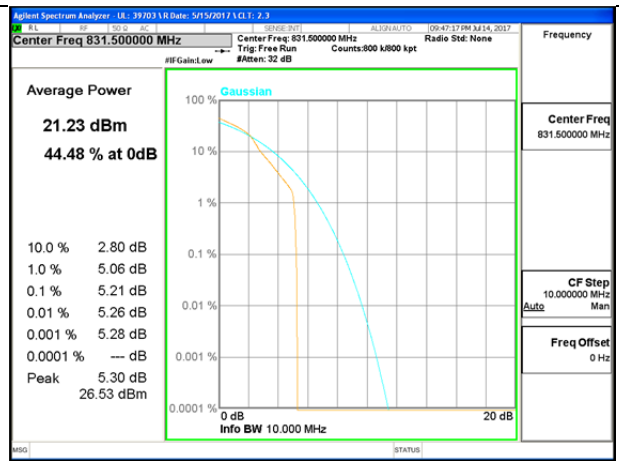

LTE B26 10MHz 16QAM Middle Channel

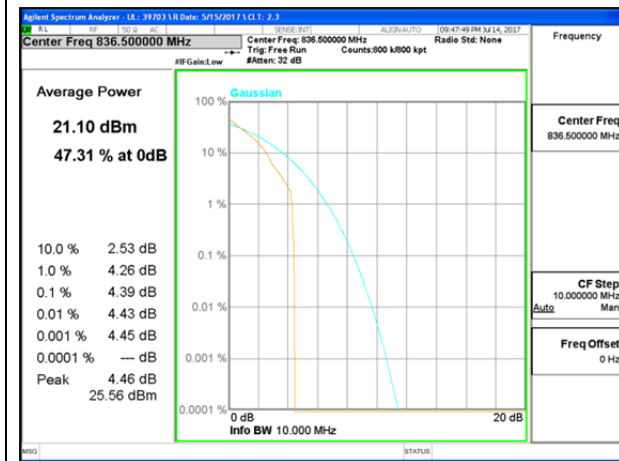

LTE B26 15MHz QPSK Middle Channel

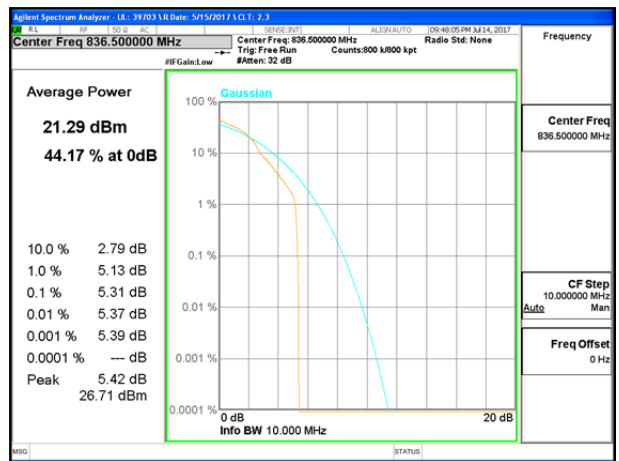

LTE B26 15MHz 16QAM Middle Channel

**LTE Band 41**

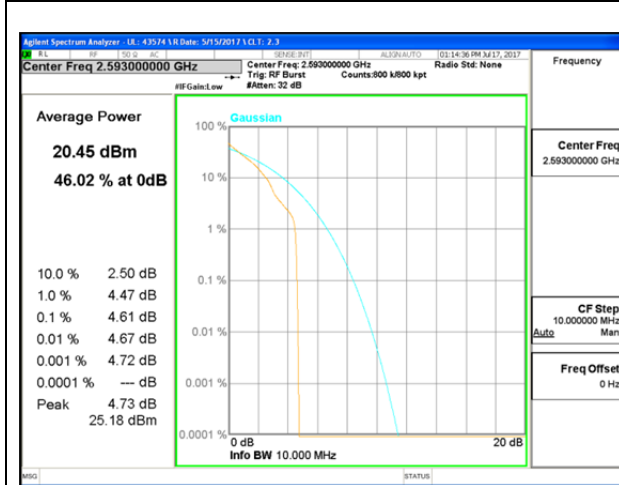

LTE B41 5MHz QPSK Middle Channel

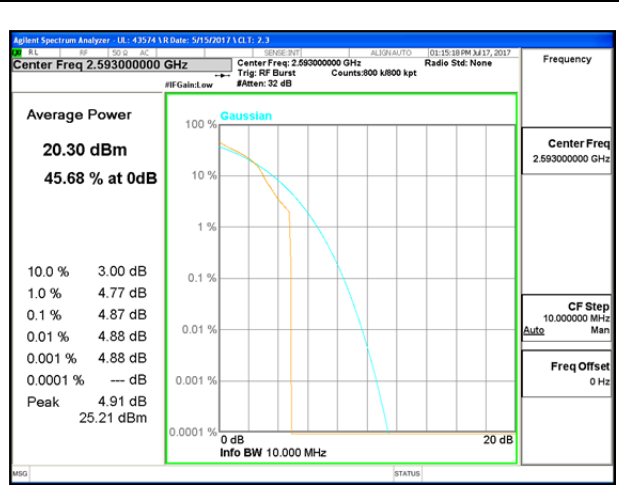

LTE B41 5MHz 16QAM Middle Channel

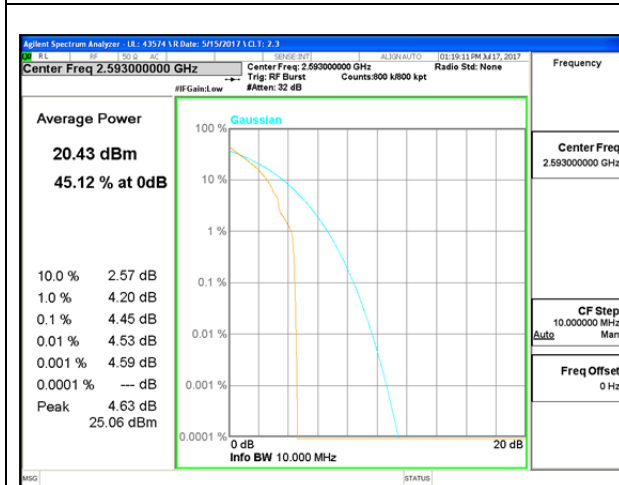

LTE B41 10MHz QPSK Middle Channel

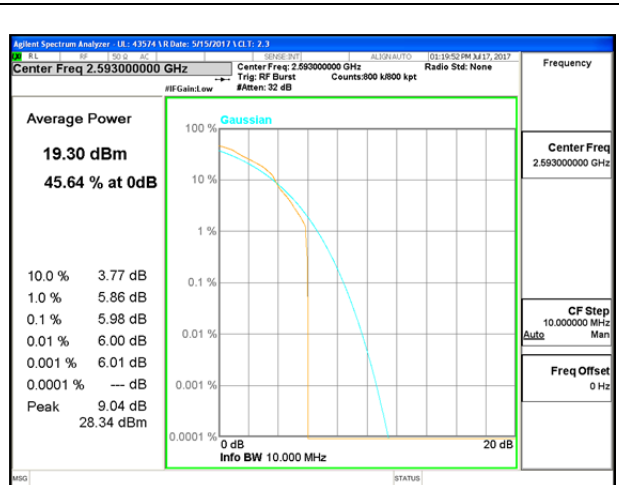

LTE B41 10MHz 16QAM Middle Channel

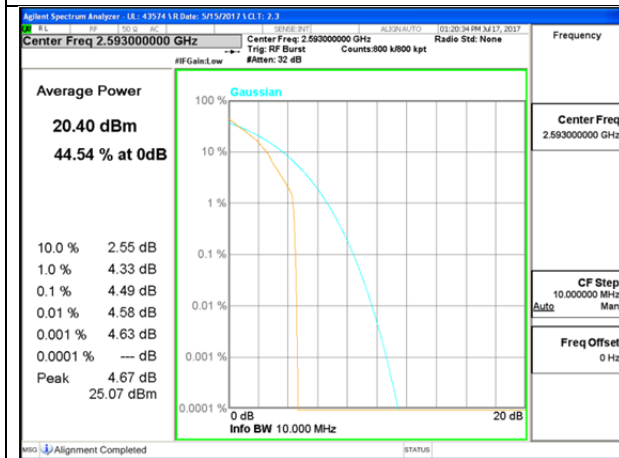

LTE B41 15MHz QPSK Middle Channel

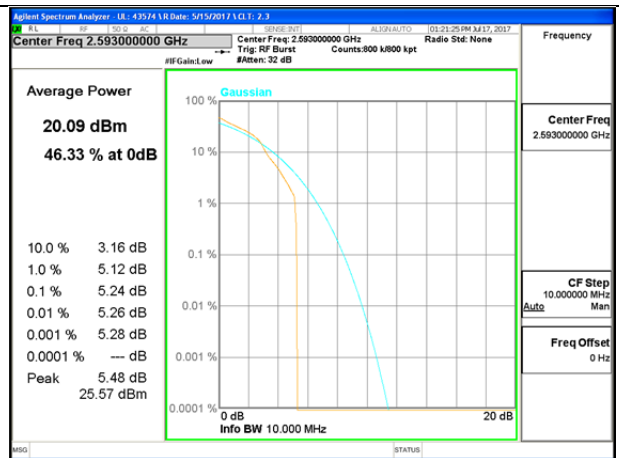

LTE B41 15MHz 16QAM Middle Channel

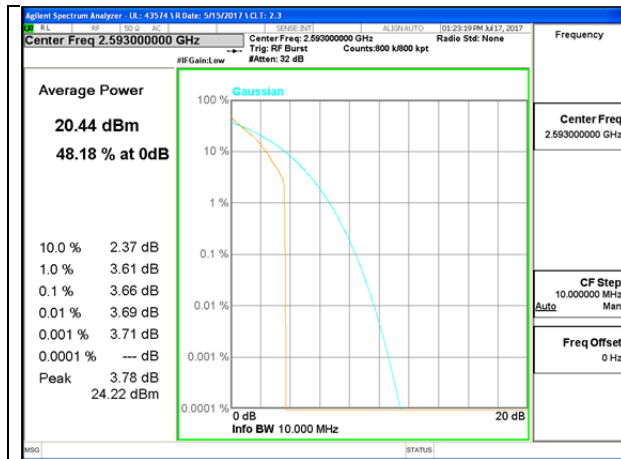

LTE B41 20MHz QPSK Middle Channel

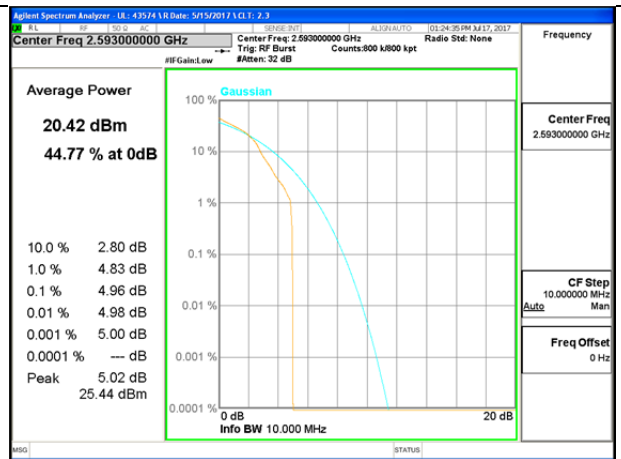

LTE B41 20MHz 16QAM Middle Channel



**LTE Band 66**

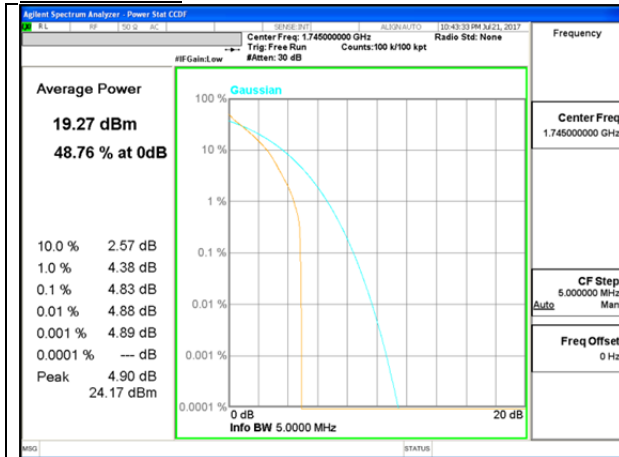

LTE B66 6MHz QPSK Middle Channel

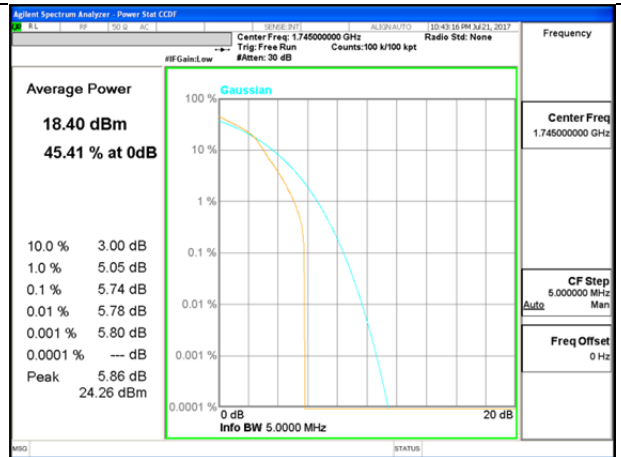

LTE B66 6MHz 16QAM Middle Channel

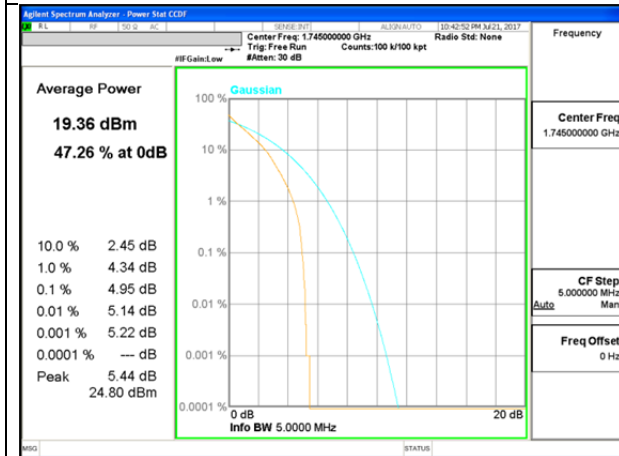

LTE B66 3MHz QPSK Middle Channel

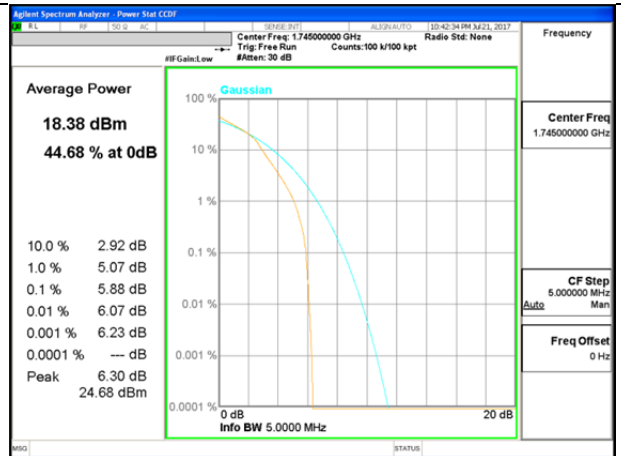

LTE B66 3MHz 16QAM Middle Channel

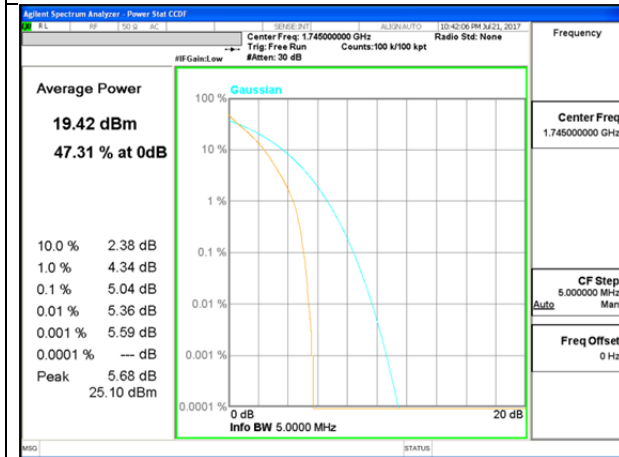

LTE B66 5MHz QPSK Middle Channel

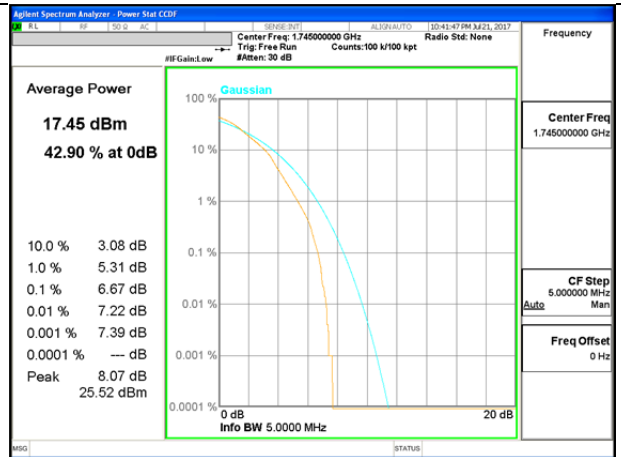

LTE B66 5MHz 16QAM Middle Channel

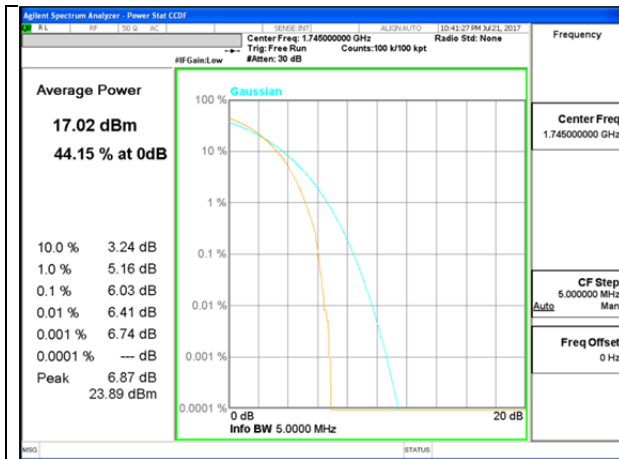

LTE B66 10MHz QPSK Middle Channel

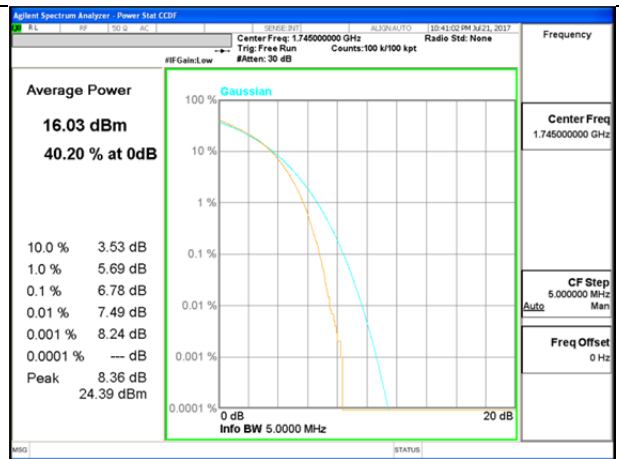

LTE B66 10MHz 16QAM Middle Channel

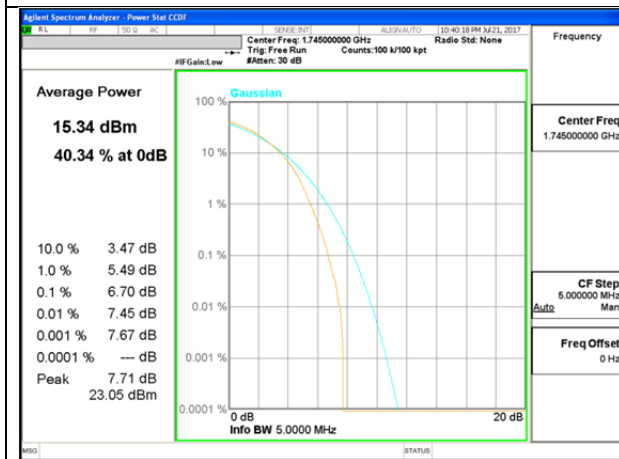

LTE B66 15MHz QPSK Middle Channel

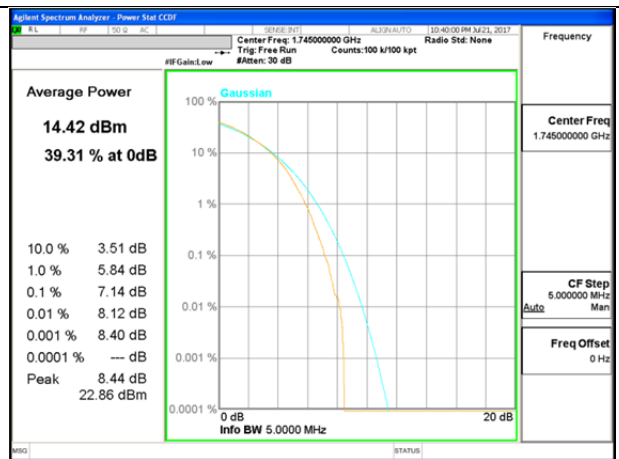

LTE B66 15MHz 16QAM Middle Channel



LTE B66 20MHz QPSK Middle Channel

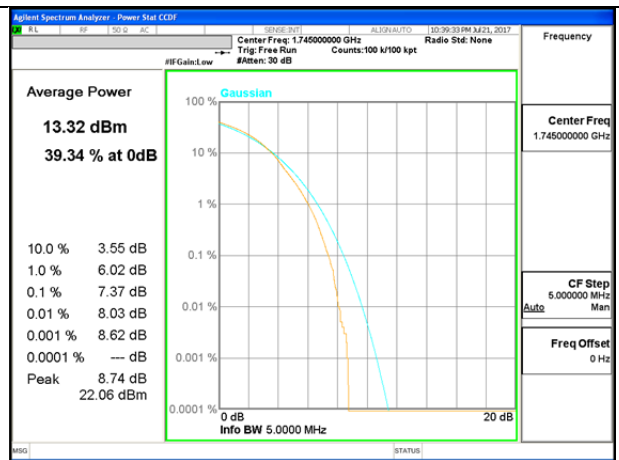

LTE B66 20MHz 16QAM Middle Channel

## 13. OCCUPIED BANDWIDTH

### RULE PART(S)

FCC: §2.1049

### LIMITS

For reporting purposes only

### TEST PROCEDURE

The transmitter output was connected to a calibrated coaxial cable and coupler, the other end of which was connected to a spectrum analyzer. The occupied bandwidth was measured with the spectrum analyzer at the low, middle and high channel in each band. The -26dB bandwidth was also measured and recorded.

(KDB 971168 D01 Power Meas License Digital Systems v02r02)